



Test Report No.: RF190617N032-1



TEST REPORT



Applicant	Lenovo(Shanghai) Electronics Technology Co., Ltd.
Address	Section 304-305, Building No. 4, # 222, Meiyue Road, China (Shanghai) Pilot Free Trade Zone

Manufacturer or Supplier	Lenovo PC HK Limited
Address	23/F, Lincoln House, Taikoo Place 979 King's Road, Quarry Bay, Hong Kong
Product	ThinkReality A6 Compute Box
Brand Name	ThinkReality
Model	ThinkReality A6 Compute Pack
Additional Model & Model Difference	N/A
FCC ID	O57TRA6CP
Date of tests	Jun. 17, 2019 ~ Jul. 08, 2019

the tests have been carried out according to the requirements of the following standards:

FCC Part 15, Subpart C, Section 15.225

CONCLUSION: The submitted sample was found to COMPLY with the test requirement

Tested by Lucas Chen Project Engineer / EMC Department	Approved by Glyn He Supervisor / EMC Department
	 Date: Jul. 30, 2019

This report is governed by, and incorporates by reference, CPS Conditions of Service as posted at the date of issuance of this report at <http://www.bureauveritas.com/home/about-us/our-business/cps/about-us/terms-conditions> and is intended for your exclusive use. Any copying or replication of this report to or for any other person or entity, or use of our name or trademark, is permitted only with our prior written permission. This report sets forth our findings solely with respect to the test samples identified herein. The results set forth in this report are not indicative or representative of the quality or characteristics of the lot from which a test sample was taken or any similar or identical product unless specifically and expressly noted. Our report includes all of the tests requested by you and the results thereof based upon the information that you provided to us. Measurement uncertainty is only provided upon request for accredited tests. You have 60 days from date of issuance of this report to notify us of any material error or omission caused by our negligence or if you require measurement uncertainty; provided, however, that such notice shall be in writing and shall specifically address the issue you wish to raise. A failure to raise such issue within the prescribed time shall constitute you unqualified acceptance of the completeness of this report, the tests conducted and the correctness of the report contents.

Bureau Veritas Shenzhen Co., Ltd.
Dongguan Branch

No. 34, Chenwulu Section, Guantai Rd., Houjie
Town, Dongguan City,
Guangdong 523942, China

Tel: +86 769 8998 2098
Fax: +86 769 8593 1080
Email: customerservice.dg@cn.bureauveritas.com



TABLE OF CONTENTS

RELEASE CONTROL RECORD	4
1 SUMMARY OF TEST RESULTS.....	5
2 MEASUREMENT UNCERTAINTY	5
3 GENERAL INFORMATION.....	6
3.1 GENERAL DESCRIPTION OF EUT.....	6
3.2 DESCRIPTION OF TEST MODES.....	7
3.2.1. CONFIGURATION OF SYSTEM UNDER TEST	7
3.2.2. TEST MODE APPLICABILITY AND TESTED CHANNEL DETAIL.....	7
3.3 GENERAL DESCRIPTION OF APPLIED STANDARDS.....	9
3.4 DESCRIPTION OF SUPPORT UNITS.....	9
4 TEST TYPES AND RESULTS.....	10
4.1. CONDUCTED EMISSION MEASUREMENT	10
4.1.1 LIMITS OF CONDUCTED EMISSION MEASUREMENT.....	10
4.1.2 TEST INSTRUMENTS	10
4.1.3 TEST PROCEDURES.....	11
4.1.4 DEVIATION FROM TEST STANDARD.....	11
4.1.5 TEST SETUP	12
4.1.6 EUT OPERATING CONDITIONS	12
4.1.7 TEST RESULTS.....	13
4.2. RADIATED EMISSION AND BANDEDGE MEASUREMENT	15
4.2.1 LIMITS OF RADIATED EMISSION AND BANDEDGE MEASUREMENT.....	15
4.2.2 TEST INSTRUMENTS	16
4.2.3 TEST PROCEDURES.....	17
4.2.4 DEVIATION FROM TEST STANDARD.....	17
4.2.5 TEST SETUP	18
4.2.6 EUT OPERATING CONDITIONS	19
4.2.7 TEST RESULTS.....	19
4.3. FREQUENCY TOLERANCE	21
4.3.1. LIMIT OF FREQUENCY TOLERANCE	21
4.3.2. TEST INSTRUMENTS	21
4.3.3. TEST PROCEDURES.....	22
4.3.4. DEVIATION FROM TEST STANDARD.....	22
4.3.5. TEST SETUP	22
4.3.6. EUT OPERATING CONDITIONS	23



Test Report No.: RF190617N032-1

4.3.7.	TEST RESULTS.....	23
4.4.	20dB BANDWIDTH	24
4.4.1	LIMITS OF 20dB BANDWIDTH	24
4.4.2	TEST INSTRUMENTS	24
4.4.3	TEST PROCEDURE	25
4.4.4	DEVIATION FROM TEST STANDARD.....	25
4.4.5	TEST SETUP	25
4.4.6	EUT OPERATING CONDITION.....	26
4.4.7	TEST RESULTS.....	26
5.	PHOTOGRAPHS OF THE TEST CONFIGURATION	27
6.	APPENDIX A - MODIFICATIONS RECORDERS FOR ENGINEERING CHANGES TO THE EUT BY THE LAB.....	28



Test Report No.: RF190617N032-1

RELEASE CONTROL RECORD

ISSUE NO.	REASON FOR CHANGE	DATE ISSUED
RF190617N032-1	Original release	Jul. 30, 2019



1 SUMMARY OF TEST RESULTS

The EUT has been tested according to the following specifications:

APPLIED STANDARD: FCC Part 15, Subpart C			
STANDARD SECTION	TEST TYPE AND LIMIT	RESULT	REMARK
15.207	AC Power Conducted Emission	PASS	Meet the requirement of limit.
15.225 (a)&(b)&(c)	The field strength of any emissions within the band	PASS	Meet the requirement of limit.
15.225 (d)	The field strength of any emissions appearing outside of the 13.110-14.010 MHz band	PASS	Meet the requirement of limit.
15.225 (e)	Frequency tolerance	PASS	Meet the requirement of limit.
15.215 (c)	20dB Bandwidth	PASS	Meet the requirement of limit.
15.203	Antenna Requirement	PASS	No antenna connector is used.

2 MEASUREMENT UNCERTAINTY

Where relevant, the following measurement uncertainty levels have been estimated for tests performed on the EUT as specified in CISPR 16-4-2:

MEASUREMENT	FREQUENCY	UNCERTAINTY
Conducted emissions	9kHz~30MHz	2.70dB
Radiated emissions	9KHz ~ 30MHz	2.16dB
	30MHz ~ 1GMHz	3.83dB
	1GHz ~ 18GHz	4.66dB
	18GHz ~ 40GHz	4.67dB

This uncertainty represents an expanded uncertainty expressed at approximately the 95% confidence level using a coverage factor of k=2.



3 GENERAL INFORMATION

3.1 GENERAL DESCRIPTION OF EUT

PRODUCT	ThinkReality A6 Compute Box
MODEL NO.	ThinkReality A6 Compute Pack
FCC ID	O57TRA6CP
POWER SUPPLY	DC 3.85V from Battery or DC 5V from Adapter
MODULATION TECHNOLOGY	NFC
MODULATION TYPE	ASK
OPERATING FREQUENCY	13.56MHz
NUMBER OF CHANNEL	1
ANTENNA TYPE	Loop antenna
I/O PORTS	Refer to user's manual
CABLE SUPPLIED	N/A

NOTES:

1. For a more detailed features description, please refer to the manufacturer's specifications or the user's manual.
2. For the test results, the EUT had been tested with all conditions. But only the worst case was shown in test report.
3. Please refer to the EUT photo document (Reference No.: 190617N032) for detailed product photo.
4. The EUT was powered by the following adapter:

Adapter	
BRAND:	Lenovo
MODEL:	SC-31
INPUT:	AC 100-240V, 50/60Hz 0.8A
OUTPUT:	DC 5V, 3A or DC 9V 2A
DC LINE:	Type-C Cable: Unshielded, Detachable, 92cm



3.2 DESCRIPTION OF TEST MODES

The EUT only have one channel.

CHANNEL	FREQUENCY (MHz)
1	13.56

3.2.1. CONFIGURATION OF SYSTEM UNDER TEST

Please see section 5 photograph of the test configuration for reference.

3.2.2. TEST MODE APPLICABILITY AND TESTED CHANNEL DETAIL

Pre-Scan has been conducted to determine the worst-case mode from all possible combinations between available modulations, data rates, XYZ axis and antenna ports. The worst case was found when positioned on X axis for radiated emission. Following channel(s) was (were) selected for the final test as listed below:

EUT CONFIGURE MODE	APPLICABLE TO				DESCRIPTION
	RE	FT	PLC	BW	
A	-	√	-	√	DC 3.85V from battery with NFC
B	√	-	√	-	DC 5V from Adapter with NFC

Where RE: Radiated Emission FT: Frequency tolerance
 PLC: Power Line Conducted Emission BW: 20dB Bandwidth

RADIATED EMISSION TEST:

- Pre-Scan has been conducted to determine the worst-case mode from all possible combinations between available modulations, XYZ axis, antenna ports (if EUT with antenna diversity architecture) and packet type.
- Following channel(s) was (were) selected for the final test as listed below.

EUT CONFIGURE MODE	TESTED CHANNEL	TESTED FREQUENCY (MHZ)	MODULATION TYPE	AXIS
B	1	13.56	ASK	X



FREQUENCY TOLERANCE:

- This item includes all test value of each mode, but only includes spectrum plot of worst value of each mode.
- Pre-Scan has been conducted to determine the worst-case mode from all possible combinations between available modulations, antenna ports (if EUT with antenna diversity architecture), and packet types.
- Following channel(s) was (were) selected for the final test as listed below.

EUT CONFIGURE MODE	TESTED CHANNEL	TESTED FREQUENCY (MHZ)	MODULATION TYPE	AXIS
A	1	13.56	ASK	X

POWER LINE CONDUCTED EMISSION TEST:

- This item includes all test value of each mode, but only includes spectrum plot of worst value of each mode.
- Pre-Scan has been conducted to determine the worst-case mode from all possible combinations between available modulations, antenna ports (if EUT with antenna diversity architecture), and packet types.
- Following channel(s) was (were) selected for the final test as listed below.

EUT CONFIGURE MODE	TESTED CHANNEL	TESTED FREQUENCY (MHZ)	MODULATION TYPE	AXIS
B	1	13.56	ASK	X

20dB BANDWIDTH:

- This item includes all test value of each mode, but only includes spectrum plot of worst value of each mode.
- Pre-Scan has been conducted to determine the worst-case mode from all possible combinations between available modulations, antenna ports (if EUT with antenna diversity architecture), and packet types.
- Following channel(s) was (were) selected for the final test as listed below.

EUT CONFIGURE MODE	TESTED CHANNEL	TESTED FREQUENCY (MHZ)	MODULATION TYPE	AXIS
A	1	13.56	ASK	X



**BUREAU
VERITAS**

Test Report No.: RF190617N032-1

TEST CONDITION:

APPLICABLE TO	ENVIRONMENTAL CONDITIONS	TEST VOLTAGE (SYSTEM)	TESTED BY
RE	21deg. C, 63%RH	DC 5V From Adapter	Walker
FT	25deg. C, 60%RH	DC 3.85V From battery	Robert Cheng
PLC	25deg. C, 55%RH	DC 5V From Adapter	Dragon
BW	25deg. C, 60%RH	DC 3.85V From battery	Robert Cheng

3.3 GENERAL DESCRIPTION OF APPLIED STANDARDS

The EUT is a RF Product. According to the specifications of the manufacturer, it must comply with the requirements of the following standards:

**FCC Part 15, Subpart C. Section 15.225
ANSI C63.10-2013**

All test items have been performed and recorded as per the above standards.

- NOTE:**
1. All test items have been performed and recorded as per the above standards.
 2. It has been verified to comply with the requirements of FCC Part 15, Subpart B, Class B (sDOC). The test report has been issued separately.

3.4 DESCRIPTION OF SUPPORT UNITS

The EUT has been tested as an independent unit together with other necessary accessories or support units. The following support units or accessories were used to form a representative test configuration during the tests.

NO.	PRODUCT	BRAND	MODEL NO.	SERIAL NO.	FCC ID
1	DC source	LONG WEI	PS-6403D	010934269	N/A

NO.	SIGNAL CABLE DESCRIPTION OF THE ABOVE SUPPORT UNITS
1	AC Line: Unshielded, Detachable 1.5m, DC Line: Unshielded, Detachable 1.0m



4 TEST TYPES AND RESULTS

4.1. CONDUCTED EMISSION MEASUREMENT

4.1.1 LIMITS OF CONDUCTED EMISSION MEASUREMENT

FREQUENCY OF EMISSION (MHz)	CONDUCTED LIMIT (dBµV)	
	Quasi-peak	Average
0.15 ~ 0.5	66 to 56	56 to 46
0.5 ~ 5	56	46
5 ~ 30	60	50

- NOTE:** 1. The lower limit shall apply at the transition frequencies.
2. The limit decreases in line with the logarithm of the frequency in the range of 0.15 to 0.50MHz.
3. All emanations from a class A/B digital device or system, including any network of conductors and apparatus connected thereto, shall not exceed the level of field strengths specified above.

4.1.2 TEST INSTRUMENTS

Equipment	Manufacturer	Model No.	Serial No.	Last Cal.	Next Cal.
EMI Test Receiver	Rohde&Schwarz	ESR7	101494	Mar. 12,19	Mar. 11,20
Artificial Mains Network	Rohde&Schwarz	ENV216	101173	Mar. 12,19	Mar. 11,20
Artificial Mains Network	Rohde&Schwarz	ESH3-Z5	100317	Mar. 13,19	Mar. 12,20
Voltage probe	SCHWARZBEC K	TK 9421	TK 9421-176	Jan. 17,19	Jan. 16,20
Test software	ADT	ADT_Cond_V 7.3.7	N/A	N/A	N/A

- NOTES:**
1. The test was performed in shielded room 553.
2. The calibration interval of the above test instruments is 12 months. And the calibrations are traceable to CEPREI/CHINA, GRGT/CHINA and NIM/CHINA.



**BUREAU
VERITAS**

Test Report No.: RF190617N032-1

4.1.3 TEST PROCEDURES

- a. The EUT was placed 0.4 meters from the conducting wall of the shielded room with EUT being connected to the power mains through a line impedance stabilization network (LISN). Other support units were connected to the power mains through another LISN. The two LISNs provide 50 ohm/ 50uH of coupling impedance for the measuring instrument.
- b. Both lines of the power mains connected to the EUT were checked for maximum conducted interference.
- c. The frequency range from 150kHz to 30MHz was searched. Emission levels under (Limit - 20dB) was not recorded.

NOTE: All modes of operation were investigated and the worst-case emissions are reported.

4.1.4 DEVIATION FROM TEST STANDARD

No deviation.



4.1.5 TEST SETUP

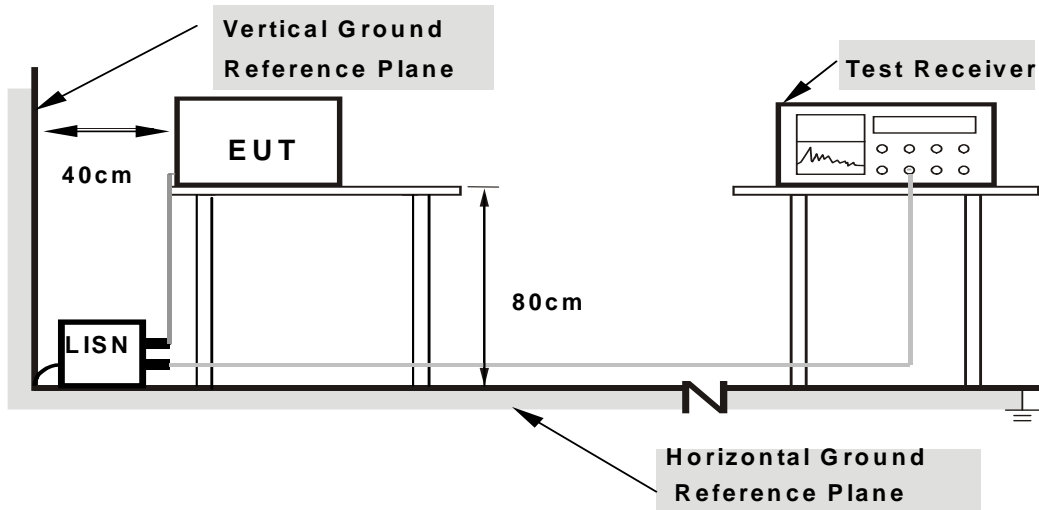

- Note:**
- 1.Support units were connected to second LISN.
 - 2.Both of LISNs (AMN) are 80 cm from EUT and at least 80 from other units and other metal planes

For the actual test configuration, please refer to the attached file (Test Setup Photo).

4.1.6 EUT OPERATING CONDITIONS

- a. Turned on the power and connected of all equipment.
- b. EUT was operated according to the type used was description in manufacturer's specifications or the User's Manual.



**BUREAU
VERITAS**

Test Report No.: RF190617N032-1

4.1.7 TEST RESULTS

CONDUCTED WORST-CASE DATA:

PHASE	Line	6dB BANDWIDTH	9kHz
--------------	------	----------------------	------

No	Freq. [MHz]	Corr. Factor (dB)	Reading Value [dB (uV)]		Emission Level [dB (uV)]		Limit [dB (uV)]		Margin (dB)	
			Q.P.	AV.	Q.P.	AV.	Q.P.	AV.	Q.P.	AV.
1	0.15225	10.15	26.55	11.68	36.70	21.83	65.88	55.88	-29.18	-34.05
2	0.55664	10.20	17.62	12.65	27.82	22.85	56.00	46.00	-28.18	-23.15
3	0.77023	10.23	13.78	3.57	24.01	13.80	56.00	46.00	-31.99	-32.20
4	1.46625	10.22	14.92	6.67	25.14	16.89	56.00	46.00	-30.86	-29.11
5	9.64050	10.21	25.27	19.55	35.48	29.76	60.00	50.00	-24.52	-20.24
6	22.05825	10.27	20.36	14.81	30.63	25.08	60.00	50.00	-29.37	-24.92

- REMARKS:**
1. Q.P. and AV. are abbreviations of quasi-peak and average individually.
 2. "-": The Quasi-peak reading value also meets average limit and measurement with the average detector is unnecessary.
 3. The emission levels of other frequencies were very low against the limit.
 4. Margin value = Emission level - Limit value
 5. Correction factor = Insertion loss + Cable loss
 6. Emission Level = Correction Factor + Reading Value.

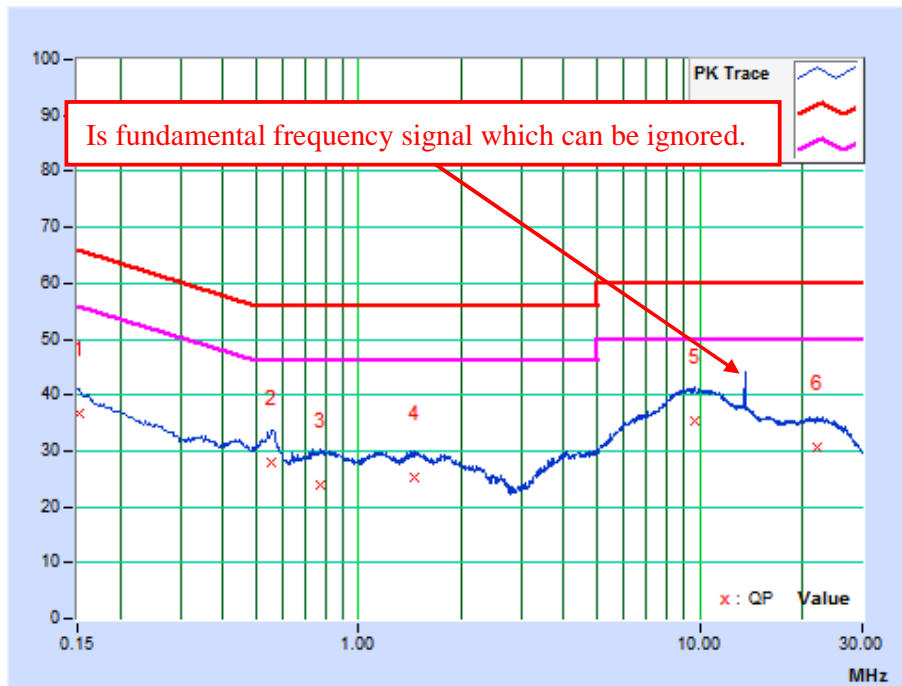

Bureau Veritas Shenzhen Co., Ltd.
Dongguan Branch

No. 34, Chenwulu Section, Guantai Rd., Houjie
Town, Dongguan City,
Guangdong 523942, China

Tel: +86 769 8998 2098
Fax: +86 769 8593 1080
Email: customerservice.dg@cn.bureauveritas.com

PHASE	Neutral	6dB BANDWIDTH	9kHz
-------	---------	---------------	------

No	Freq. [MHz]	Corr. Factor (dB)	Reading Value [dB (uV)]		Emission Level [dB (uV)]		Limit [dB (uV)]		Margin (dB)	
			Q.P.	AV.	Q.P.	AV.	Q.P.	AV.	Q.P.	AV.
1	0.1500	9.95	22.82	6.19	32.77	16.14	66.00	56.00	-33.23	-39.86
2	0.4023	9.98	12.12	-2.12	22.10	7.86	57.81	47.81	-35.71	-39.95
3	0.5596	10.00	13.32	6.80	23.32	16.80	56.00	46.00	-32.68	-29.20
4	0.7800	10.03	7.79	-1.97	17.82	8.06	56.00	46.00	-38.18	-37.94
5	1.1265	10.03	7.92	-1.13	17.95	8.90	56.00	46.00	-38.05	-37.10
6	9.7935	10.08	19.52	12.74	29.60	22.82	60.00	50.00	-30.40	-27.18

- REMARKS:**
1. Q.P. and AV. are abbreviations of quasi-peak and average individually.
 2. "-": The Quasi-peak reading value also meets average limit and measurement with the average detector is unnecessary.
 3. The emission levels of other frequencies were very low against the limit.
 4. Margin value = Emission level - Limit value
 5. Correction factor = Insertion loss + Cable loss
 6. Emission Level = Correction Factor + Reading Value.

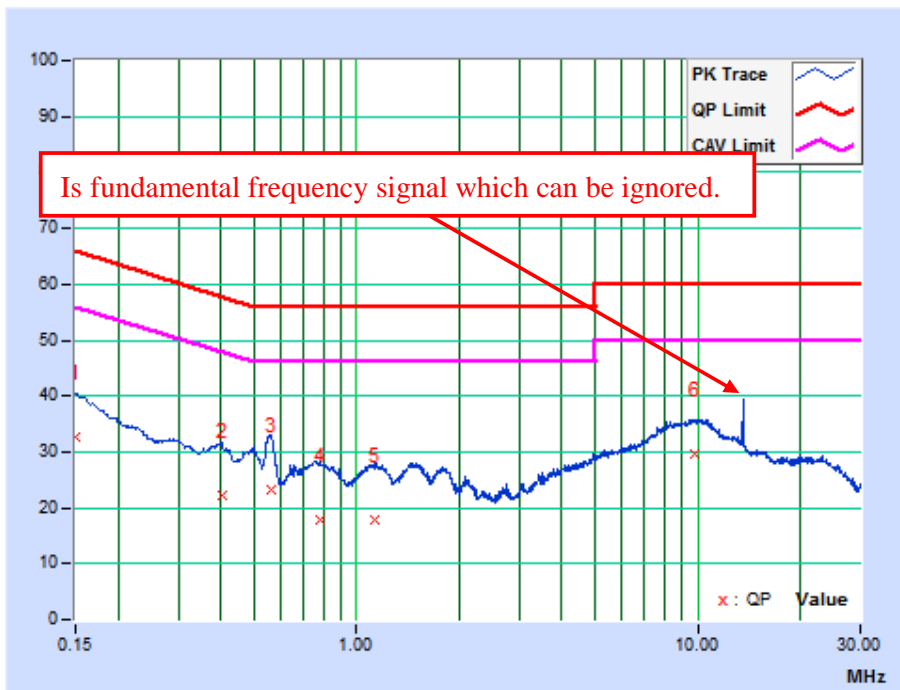



4.2. RADIATED EMISSION AND BANDEDGE MEASUREMENT

4.2.1 LIMITS OF RADIATED EMISSION AND BANDEDGE MEASUREMENT

The field strength of any emissions shall not exceed the following limits:

- (a) 15.848mV/m(84dBuV/m) at 30m, within the band 13.553-13.567 MHz;
- (b) 334uV/m(50.5dBuV/m) at 30m, within the band 13.410-13.553 MHz and 13.567-13.710MHz;
- (c) 106uV/m(40.5dBuV/m) at 30m, within the band 13.110-13.410 MHz and 13.710-14.010MHz;

The field strength of any emissions appearing outside of the 13.110-14.010 MHz band shall not exceed the general radiated emission limits in § 15.209.

FREQUENCIES (MHz)	FIELD STRENGTH (microvolts/meter)	MEASUREMENT DISTANCE (meters)
0.009 ~ 0.490	2400/F(kHz)	300
0.490 ~ 1.705	24000/F(kHz)	30
1.705 ~ 30.0	30	30
30 ~ 88	100	3
88 ~ 216	150	3
216 ~ 960	200	3
Above 960	500	3

NOTES:

1. The lower limit shall apply at the transition frequencies.
2. Emission level (dBuV/m) = 20 log Emission level (uV/m).
3. As shown in 15.35(b), for frequencies above 1000MHz, the field strength limits are based on average detector, however, the peak field strength of any emission shall not exceed the maximum permitted average limits, specified above by more than 20dB under any condition of modulation.
4. The measured field strength was extrapolated to distance 30 meters, using the formula that the limit of field strength varies as the inverse distance square (40dB per decade of distance)

Example:

$$\begin{aligned}
 13.56\text{MHz} &= 15848\text{uV/m} && 30\text{m} \\
 &= 84\text{dBuV/m} && 30\text{m} \\
 &= 84+20\log(30/3)^2 && 3\text{m} \\
 &= 124\text{dBuV/m}
 \end{aligned}$$



**BUREAU
VERITAS**

Test Report No.: RF190617N032-1

4.2.2 TEST INSTRUMENTS

9KHz~30MHz

Equipment	Manufacturer	Model No.	Serial No.	Last Cal.	Next Cal.
EMI Test Receiver	Rohde&Schwarz	ESR7	101564	Mar. 12,19	Mar. 11,20
Active Loop Antenna	SCHWARZBECK	FMZB 1519B	1519B-045	May 04,19	May 03,20
Amplifier	Burgeon	BPA-530	100210	Apr. 17,19	Apr. 18,20
Test Software	ADT	ADT_Radiated_V8.7.07	N/A	N/A	N/A

- NOTES:**
1. The calibration interval of the above test instruments is 12 months and the calibrations are traceable to CEPREI/CHINA, GRGT/CHINA and NIM/CHINA.
 2. The test was performed in 10m Chamber
 3. The FCC Site Registration No. is 749762.

30MHz~1GHz

Equipment	Manufacturer	Model No.	Serial No.	Last Cal.	Next Cal.
EMI Test Receiver	Rohde&Schwarz	ESU40	100449	Mar. 12,19	Mar. 11,20
Bilog Antenna	Teseq	CBL 6111D	30643	Aug.11,18	Aug. 10,19
Amplifier	Burgeon	BPA-530	100220	Apr. 17,19	Apr. 18,20
3m Semi-anechoic Chamber	ETS-LINDGREN	9m*6m*6m	NSEMC003	Feb. 10,18	Feb. 09,20
Test software	ADT	ADT_Radiated_V7.6.15.9.2	N/A	N/A	N/A

- NOTES:**
1. The test was performed in 966 Chamber (a 3m Semi-anechoic chamber).
 2. The calibration interval of the above test instruments are 12 months and the calibrations are traceable to CEPREI/CHINA, GRGT/CHINA and NIM/CHINA.
 3. The horn antenna is used only for the measurement of emission frequency above1GHz if tested.
 4. The FCC Site Registration No. is 749762.



4.2.3 TEST PROCEDURES

- a. The EUT was placed on the top of a rotating table 0.8 meters above the ground at a 3&10 meter semi-anechoic chamber. The table was rotated 360 degrees to determine the position of the highest radiation.
- b. The EUT was set 3 meters away from the interference-receiving antenna, which was mounted on the top of a variable-height antenna tower.
- c. The antenna is a broadband antenna, and its height is varied from one meter to four meters above the ground to determine the maximum value of the field strength. Both horizontal and vertical polarizations of the antenna are set to make the measurement.
- d. For each suspected emission, the EUT was arranged to its worst case and then the antenna was tuned to heights from 1 meter to 4 meters and the rotatable table was turned from 0 degrees to 360 degrees to find the maximum reading.
- e. The test-receiver system was set to quasi-peak detect function and specified bandwidth with maximum hold mode when the test frequency is below 1 GHz.
- f. During the test, each emission was maximized by: having the EUT continuously working, investigated all operating modes, rotated about all 3 axis (X, Y & Z) and considered typical configuration to obtain worst position, manipulating interconnecting cables, For battery operated equipment, the equipment tests shall be perform using fresh batteries. The turntable was rotated to maximize the emission level.
- g. For below 30MHz, a loop antenna with its vertical plane is place 3m from the EUT and rotated about its vertical axis for maximum response at each azimuth about the EUT. And the centre of the loop shall be 1m above the ground.

NOTES:

1. The resolution bandwidth and video bandwidth of test receiver/spectrum analyzer is 120kHz for Quasi-peak detection at frequency below 1GHz.
2. The resolution bandwidth of test receiver/spectrum analyzer is 1 MHz and video bandwidth is 3MHz for Peak detection at frequency above 1GHz.
3. All modes of operation were investigated and the worst-case emissions are reported.

4.2.4 DEVIATION FROM TEST STANDARD

No deviation.

4.2.5 TEST SETUP

Below 30MHz test setup

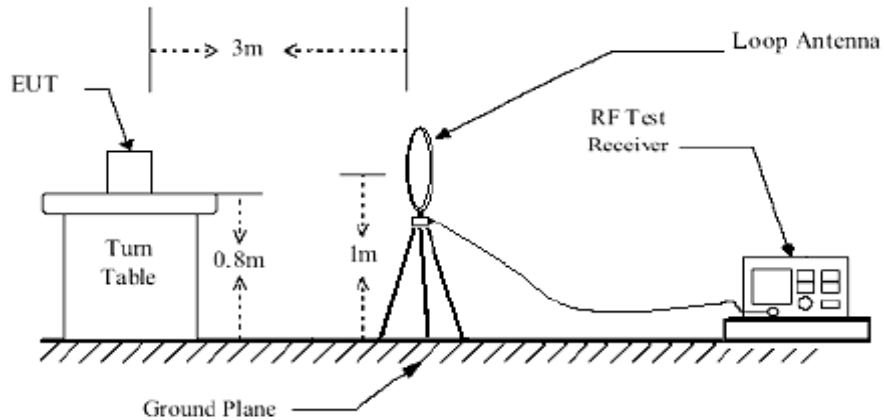

Below 1GHz test setup

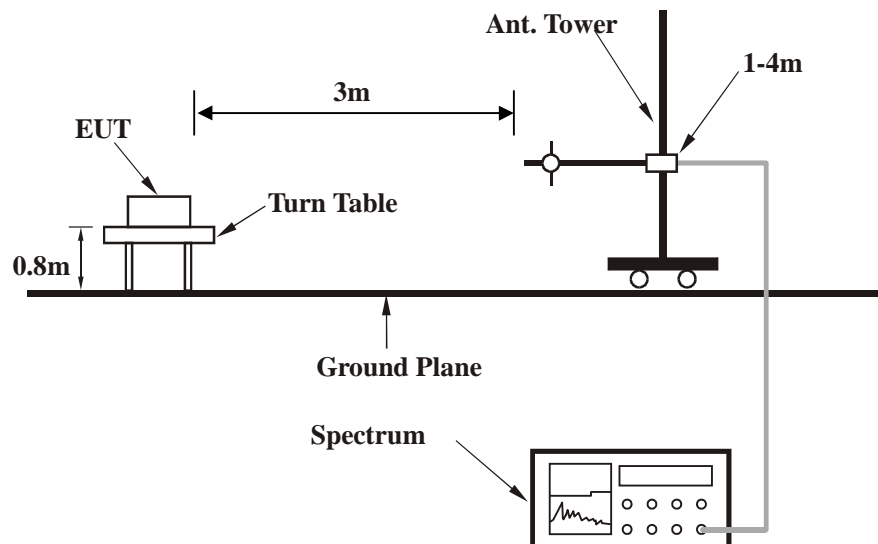

Note: For the actual test configuration, please refer to the attached file (Test Setup Photo).



BUREAU VERITAS

Test Report No.: RF190617N032-1

4.2.6 EUT OPERATING CONDITIONS

Set the EUT under transmission condition continuously at specific channel frequency.

4.2.7 TEST RESULTS

FIELD STRENGTH (BELOW 30MHZ AT 3M)

No.	Freq. (MHz)	Correction Factor (dB/m)	Raw Value (dBuV)	Emission Level (dBuV/m)	Polarity (0° / 90°)	Limit (dBuV/m)	Margin (dB)
1	*13.56(QP)	-10.74	66.25	55.51	0°	124.0	-68.49
2	27.12(QP)	-10.30	28.70	18.40	0°	69.54	-51.14
3	*13.56(QP)	-10.74	65.63	54.89	90°	124.0	-69.11
4	27.12(QP)	-10.30	29.12	18.82	90°	69.54	-50.72

- REMARKS:**
1. Emission level (dBuV/m) = Raw Value (dBuV) + Correction Factor (dB/m).
 2. Correction Factor (dB/m) = Antenna Factor (dB/m) + Cable Factor (dB).
 3. The other emission levels were very low against the limit.
 4. Margin value = Emission level – Limit value.
 5. " * " : Fundamental frequency.
 6. For the test results, both 0° and 90° polarizations of the antenna are set to make the measurement, but only the worst case was shown in test report.

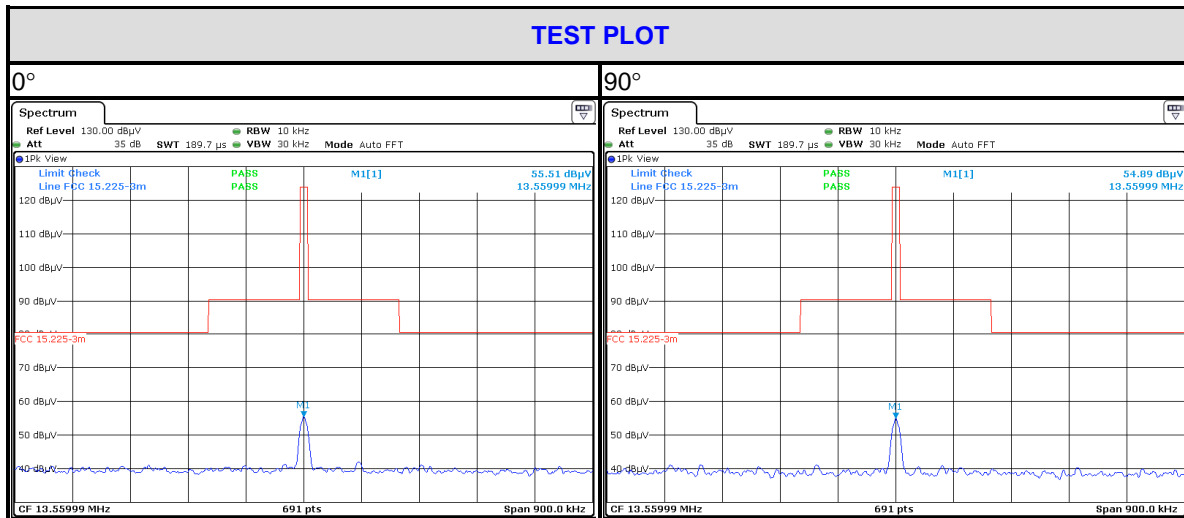

Bureau Veritas Shenzhen Co., Ltd.
Dongguan Branch

No. 34, Chenwulu Section, Guantai Rd., Houjie
Town, Dongguan City,
Guangdong 523942, China

Tel: +86 769 8998 2098
Fax: +86 769 8593 1080
Email: customerservice.dg@cn.bureauveritas.com



BELOW 1GHz WORST-CASE DATA:

CHANNEL	Channel 1	DETECTOR FUNCTION	Quasi-Peak (QP)
FREQUENCY RANGE	9KHz ~ 1GHz		

ANTENNA POLARITY & TEST DISTANCE: HORIZONTAL AT 3 M

NO.	FREQ. (MHz)	EMISSION LEVEL (dBuV/m)	LIMIT (dBuV/m)	MARGIN (dB)	ANTENNA HEIGHT (m)	TABLE ANGLE (Degree)	RAW VALUE (dBuV)	CORRECTION FACTOR (dB/m)
1	30.01	33.60 QP	40.00	-6.40	1.74 H	209	43.71	-10.11
2	90.62	17.85 QP	43.50	-25.65	1.74 H	271	37.23	-19.38
3	137.26	18.50 QP	43.50	-25.00	1.74 H	344	34.50	-16.00
4	185.45	23.53 QP	43.50	-19.97	1.74 H	345	41.34	-17.81
5	322.24	21.01 QP	46.00	-24.99	1.74 H	202	32.69	-11.68
6	801.03	31.12 QP	46.00	-14.88	1.74 H	342	33.24	-2.12

ANTENNA POLARITY & TEST DISTANCE: VERTICAL AT 3 M

NO.	FREQ. (MHz)	EMISSION LEVEL (dBuV/m)	LIMIT (dBuV/m)	MARGIN (dB)	ANTENNA HEIGHT (m)	TABLE ANGLE (Degree)	RAW VALUE (dBuV)	CORRECTION FACTOR (dB/m)
1	30.00	33.22 QP	40.00	-6.78	1.00 V	348	43.32	-10.10
2	73.53	19.80 QP	40.00	-20.20	1.00 V	119	41.89	-22.09
3	166.79	18.42 QP	43.50	-25.08	1.00 V	250	35.35	-16.93
4	196.33	18.82 QP	43.50	-24.68	1.00 V	356	36.79	-17.97
5	424.84	22.88 QP	46.00	-23.12	1.00 V	103	31.82	-8.94
6	801.03	31.96 QP	46.00	-14.04	1.00 V	286	34.08	-2.12

REMARKS:

1. Emission level (dBuV/m) = Raw Value (dBuV) + Correction Factor (dB/m).
2. Correction Factor (dB/m) = Antenna Factor (dB/m) + Cable Factor (dB).
3. The emission levels of other frequencies were less than 20dB margin against the limit.
4. Margin value = Emission level – Limit value.



4.3. FREQUENCY TOLERANCE

4.3.1. LIMIT OF FREQUENCY TOLERANCE

The frequency tolerance of the carrier signal shall be maintained within +/- 0.01% of the operating frequency over a temperature variation of -20 degrees to 50 degrees C at normal supply voltage, and for a variation in the primary supply voltage from 85% to 115% of the rated supply voltage at a temperature of 20 degrees C.

4.3.2. TEST INSTRUMENTS

Equipment	Manufacturer	Model No.	Serial No.	Last Cal.	Next Cal.
Power Sensor	Keysight	U2021XA	MY55060016	Jun. 13,19	Jun. 12,20
Power Sensor	Keysight	U2021XA	MY55060018	Jun. 13,19	Jun. 12,20
Power Meter	Anritsu	ML2495A	1139001	Mar. 12,19	Mar. 11,20
Power Sensor	Anritsu	MA2411B	1531155	Mar. 12,19	Mar. 11,20
Digital Multimeter	FLUKE	15B	A1220010DG	Oct. 17, 18	Oct.16, 19
Humid & Temp Programmable Tester	Haida	HD-2257	110807201	Nov.15,18	Nov. 14,19
Oscilloscope	Agilent	DSO9254A	MY51260160	Nov. 09,18	Nov. 08,19
Signal Analyzer	Rohde & Schwarz	FSV7	102331	Aug. 02,18	Aug. 01,19
Signal Generator	Agilent	N5183A	MY50140980	Dec. 07,18	Dec. 06,19
Agile Signal Generator	Agilent	8645A	Agilent	Oct.27, 18	Oct.26, 19
Spectrum Analyzer	Keysight	N9020A	MY55400499	Mar. 12,19	Mar. 11,20
MXG-B RF Vector Signal Generator	Keysight	N5182B	MY56200288	Dec. 07, 18	Dec. 06, 19
BLUETOOTH TESTER	Rohde&Schwarz	CBT32	100811	Jul.06, 19	Jul. 05, 20
Attenuator	MINI	BW-S10W2+	S130129FGE2	N/A	N/A
DC Source	Keysight	E3642A	MY56146098	N/A	N/A

NOTES:

1. The test was performed in RF Oven room.
2. The calibration interval of the above test instruments is 12 months and the calibrations are traceable to CEPREI/CHINA, GRGT/CHINA and NIM/CHINA.

4.3.3. TEST PROCEDURES

- a) The EUT was placed inside the environmental test chamber and powered by nominal DC voltage.
- b) Turn the EUT on and couple its output to a spectrum analyzer.
- c) Turn the EUT off and set the chamber to the highest temperature specified.
- d) Allow sufficient time (approximately 30 min) for the temperature of the chamber to stabilize, turn the EUT on and measure the operating frequency after 2, 5, and 10 minutes.
- e) Repeat step c) and d) with the temperature chamber set to the lowest temperature.
- f) The test chamber was allowed to stabilize at +20 degree C for a minimum of 30 minutes. The supply voltage was then adjusted on the EUT from 85% to 115% and the frequency record.

4.3.4. DEVIATION FROM TEST STANDARD

No deviation.

4.3.5. TEST SETUP

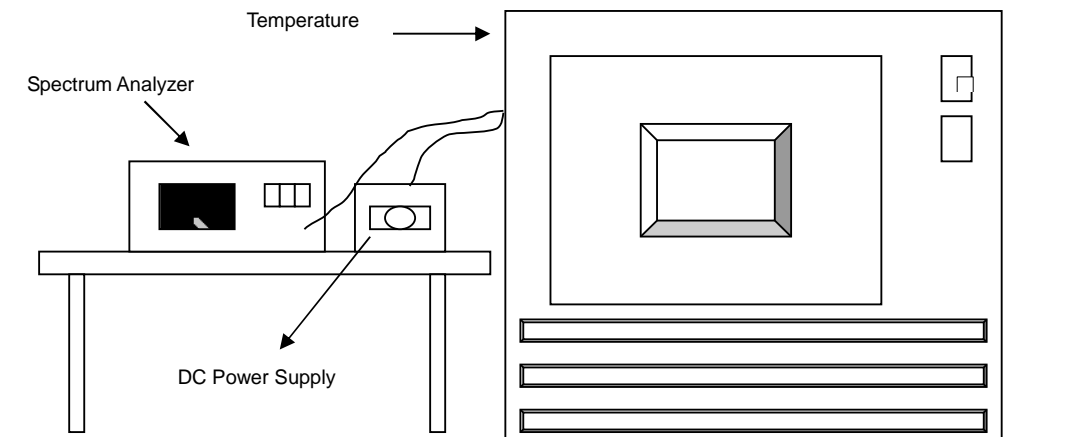



BUREAU VERITAS

Test Report No.: RF190617N032-1

4.3.6. EUT OPERATING CONDITIONS

Set the EUT under transmission condition continuously at specific channel frequency.

4.3.7. TEST RESULTS

FREQUENCY STABILITY VERSUS TEMP.									
TEMP. (°C)	POWER SUPPLY (V)	0 MINUTE		2 MINUTE		5 MINUTE		10 MINUTE	
		Measured Frequency	Frequency Drift	Measured Frequency	Frequency Drift	Measured Frequency	Frequency Drift	Measured Frequency	Frequency Drift
		(MHz)	%	(MHz)	%	(MHz)	%	(MHz)	%
50	3.85	13.55999	-0.00007	13.55998	-0.00015	13.55999	-0.00007	13.56	0.00000
40	3.85	13.56005	0.00037	13.56005	0.00037	13.56004	0.00029	13.56005	0.00037
30	3.85	13.55996	-0.00029	13.55997	-0.00022	13.55996	-0.00029	13.55996	-0.00029
20	3.85	13.55993	-0.00052	13.55993	-0.00052	13.55993	-0.00052	13.55993	-0.00052
10	3.85	13.56001	0.00007	13.56001	0.00007	13.56001	0.00007	13.56001	0.00007
0	3.85	13.55999	-0.00007	13.55999	-0.00007	13.55998	-0.00015	13.55999	-0.00007
-10	3.85	13.56004	0.00029	13.56004	0.00029	13.56004	0.00029	13.56005	0.00037
-20	3.85	13.56	0.00000	13.55999	-0.00007	13.55999	-0.00007	13.55999	-0.00007

FREQUENCY STABILITY VERSUS VOLTAGE									
TEMP. (°C)	POWER SUPPLY (V)	0 MINUTE		2 MINUTE		5 MINUTE		10 MINUTE	
		Measured Frequency	Frequency Drift	Measured Frequency	Frequency Drift	Measured Frequency	Frequency Drift	Measured Frequency	Frequency Drift
		(MHz)	%	(MHz)	%	(MHz)	%	(MHz)	%
20	3.85	13.55993	-0.00052	13.55993	-0.00052	13.55993	-0.00052	13.55993	-0.00052
	3.85	13.55993	-0.00052	13.55993	-0.00052	13.55993	-0.00052	13.55993	-0.00052
	3.2725	13.55993	-0.00052	13.55993	-0.00052	13.55993	-0.00052	13.55993	-0.00052



4.4. 20dB BANDWIDTH

4.4.1 LIMITS OF 20dB BANDWIDTH

The 20dB bandwidth shall be specified in operating frequency band.(13.11MHz – 14.01MHz)

4.4.2 TEST INSTRUMENTS

Equipment	Manufacturer	Model No.	Serial No.	Last Cal.	Next Cal.
Power Sensor	Keysight	U2021XA	MY55060016	Jun. 13,18	Jun. 12,19
Power Sensor	Keysight	U2021XA	MY55060018	Jun. 13,18	Jun. 12,19
Power Meter	Anritsu	ML2495A	1139001	Mar. 12,19	Mar. 11,20
Power Sensor	Anritsu	MA2411B	1531155	Mar. 12,19	Mar. 11,20
Digital Multimeter	FLUKE	15B	A1220010DG	Oct. 17, 18	Oct.16, 19
Humid & Temp Programmable Tester	Haida	HD-2257	110807201	Nov.15,18	Nov. 14,19
Oscilloscope	Agilent	DSO9254A	MY51260160	Nov. 09,18	Nov. 08,19
Signal Analyzer	Rohde & Schwarz	FSV7	102331	Aug. 02,18	Aug. 01,19
Signal Generator	Agilent	N5183A	MY50140980	Dec. 07,18	Dec. 06,19
Agile Signal Generator	Agilent	8645A	Agilent	Oct.27, 18	Oct.26, 19
Spectrum Analyzer	Keysight	N9020A	MY55400499	Mar. 12,19	Mar. 11,20
MXG-B RF Vector Signal Generator	Keysight	N5182B	MY56200288	Dec. 07, 18	Dec. 06, 19
BLUETOOTH TESTER	Rohde&Schwarz	CBT32	100811	Jul.06, 19	Jul. 05, 20
Attenuator	MINI	BW-S10W2+	S130129FGE2	N/A	N/A
DC Source	Keysight	E3642A	MY56146098	N/A	N/A

NOTES:

1. The test was performed in RF Oven room.
2. The calibration interval of the above test instruments is 12 months and the calibrations are traceable to CEPREI/CHINA, GRGT/CHINA and NIM/CHINA.



4.4.3 TEST PROCEDURE

- a. Check the calibration of the measuring instrument using either an internal calibrator or a known signal from an external generator.
- b. Turn on the EUT and connect it to measurement instrument. Then set it to any one convenient frequency within its operating range. Set a reference level on the measuring instrument equal to the highest peak value.
- c. Measure the frequency difference of two frequencies that were attenuated 20dB from the reference level. Record the frequency difference as the emission bandwidth.
- d. Repeat above procedures until all frequencies measured were complete.

4.4.4 DEVIATION FROM TEST STANDARD

No deviation.

4.4.5 TEST SETUP

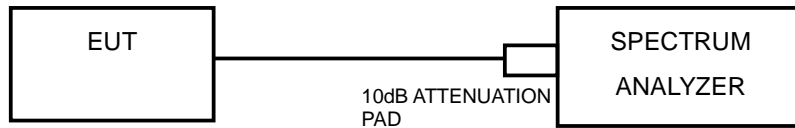



4.4.6 EUT OPERATING CONDITION

The software provided by client to enable the EUT under transmission condition continuously.

4.4.7 TEST RESULTS

CHANNEL	CHANNEL FREQUENCY (MHz)	20dB BANDWIDTH (KHz)
1	13.56	24.75

Lower & Upper Test Frequency Point (MHz)	Test Frequency (MHz)	P/F
Lower	13.54770	PASS
Upper	13.57245	PASS

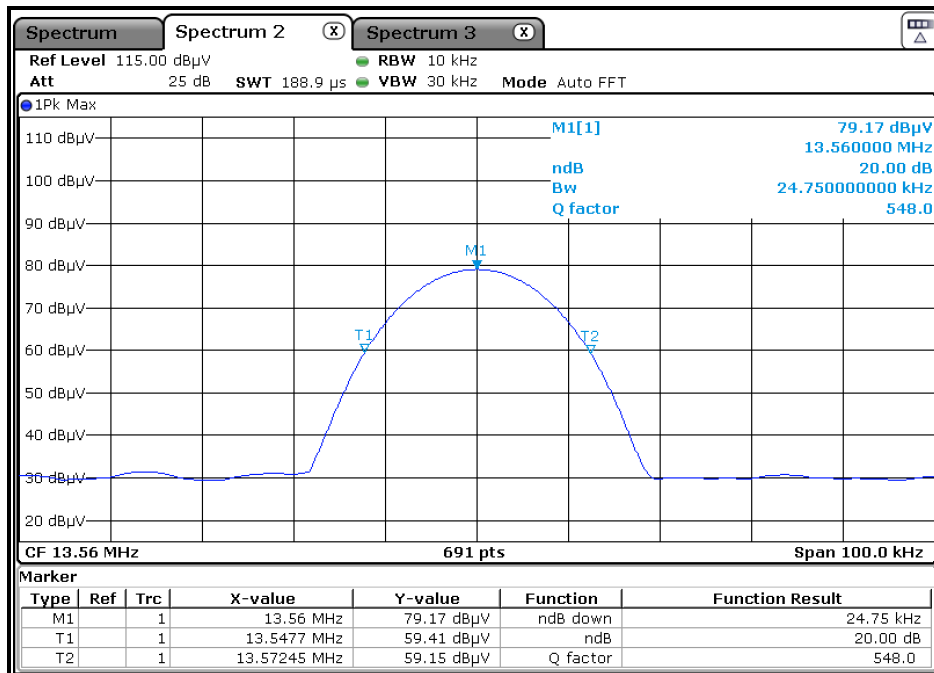



**BUREAU
VERITAS**

Test Report No.: RF190617N032-1

5. PHOTOGRAPHS OF THE TEST CONFIGURATION

Please refer to the attached file (Test Setup Photo).



**BUREAU
VERITAS**

Test Report No.: RF190617N032-1

6. APPENDIX A - MODIFICATIONS RECORDERS FOR ENGINEERING CHANGES TO THE EUT BY THE LAB

No any modifications are made to the EUT by the lab during the test.

---END---