

FCC Test Report

Report No.: RF180528C19-4

FCC ID: O57TBX705F

Test Model: Lenovo TB-X705F

Received Date: May 28, 2018

Test Date: Jun. 02, 2018 ~ Jun. 19, 2018

Issued Date: Jun. 25, 2018

Applicant: Lenovo(Shanghai) Electronics Technology Co., Ltd.

Address: NO.68 BUILDING, 199 FENJU RD, China (Shanghai) Pilot Free Trade Zone, 200131, CHINA

Manufacturer: Lenovo PC HK Limited

Address: 23/F, Lincoln House, Taikoo Place 979 King's Road, Quarry Bay, Hong Kong

Issued By: Bureau Veritas Consumer Products Services (H.K.) Ltd., Taoyuan Branch

Lab Address: No. 47-2, 14th Ling, Chia Pau Vil., Lin Kou Dist., New Taipei City, Taiwan (R.O.C)

Test Location (1): No.19, Hwa Ya 2nd Rd., Wen Hwa Vil., Kwei Shan Dist., Taoyuan City 33383, Taiwan, R.O.C.

Test Location (2): No.215, Sec. 3, Beixin Rd., Xindian Dist., New Taipei City 231, Taiwan, R.O.C

**FCC Registration /
Designation Number:** 427177 / TW0011



This report is for your exclusive use. Any copying or replication of this report to or for any other person or entity, or use of our name or trademark, is permitted only with our prior written permission. This report sets forth our findings solely with respect to the test samples identified herein. The results set forth in this report are not indicative or representative of the quality or characteristics of the lot from which a test sample was taken or any similar or identical product unless specifically and expressly noted. Our report includes all of the tests requested by you and the results thereof based upon the information that you provided to us. You have 60 days from date of issuance of this report to notify us of any material error or omission caused by our negligence, provided, however, that such notice shall be in writing and shall specifically address the issue you wish to raise. A failure to raise such issue within the prescribed time shall constitute your unqualified acceptance of the completeness of this report, the tests conducted and the correctness of the report contents. Unless specific mention, the uncertainty of measurement has been explicitly taken into account to declare the compliance or non-compliance to the specification. The report must not be used by the client to claim product certification, approval, or endorsement by TAF or any government agencies.

Table of Contents

Release Control Record	4
1 Certificate of Conformity	5
2 Summary of Test Results	6
2.1 Measurement Uncertainty	6
2.2 Modification Record	6
3 General Information	7
3.1 General Description of EUT	7
3.2 Description of Test Modes	10
3.2.1 Test Mode Applicability and Tested Channel Detail	12
3.3 Duty Cycle of Test Signal	14
3.4 Description of Support Units	15
3.4.1 Configuration of System under Test	15
3.5 General Description of Applied Standards	15
4 Test Types and Results	16
4.1 Radiated Emission and Bandedge Measurement	16
4.1.1 Limits of Radiated Emission and Bandedge Measurement	16
4.1.2 Limits of Unwanted Emission Out of the Restricted Bands	17
4.1.3 Test Instruments	18
4.1.4 Test Procedures	20
4.1.5 Deviation from Test Standard	21
4.1.6 Test Setup	21
4.1.7 EUT Operating Conditions	22
4.1.8 Test Results	23
4.2 Conducted Emission Measurement	67
4.2.1 Limits of Conducted Emission Measurement	67
4.2.2 Test Instruments	67
4.2.3 Test Procedures	68
4.2.4 Deviation from Test Standard	68
4.2.5 Test Setup	68
4.2.6 EUT Operating Conditions	68
4.2.7 Test Results	69
4.3 Transmit Power Measurement	73
4.3.1 Limits of Transmit Power Measurement	73
4.3.2 Test Setup	73
4.3.3 Test Instruments	74
4.3.4 Test Procedure	74
4.3.5 Deviation from Test Standard	74
4.3.6 EUT Operating Conditions	74
4.3.7 Test Results	75
4.4 Occupied Bandwidth Measurement	81
4.4.1 Test Setup	81
4.4.2 Test Instruments	81
4.4.3 Test Procedure	81
4.4.4 Test Results	82
4.5 Peak Power Spectral Density Measurement	85
4.5.1 Limits of Peak Power Spectral Density Measurement	85
4.5.2 Test Setup	85
4.5.3 Test Instruments	85
4.5.4 Test Procedures	85
4.5.5 Deviation from Test Standard	86
4.5.6 EUT Operating Conditions	86
4.5.7 Test Results	87
4.6 Frequency Stability	92

4.6.1	Limit of Frequency Stability Measurement	92
4.6.2	Test Setup	92
4.6.3	Test Instruments	92
4.6.4	Test Procedure	92
4.6.5	Deviation from Test Standard	92
4.6.6	EUT Operating Condition	92
4.6.7	Test Results	93
4.7	6 dB Bandwidth Measurement.....	94
4.7.1	Limits of 6 dB Bandwidth Measurement.....	94
4.7.2	Test Setup.....	94
4.7.3	Test Instruments	94
4.7.4	Test Procedure	94
4.7.5	Deviation from Test Standard	94
4.7.6	EUT Operating Condition	94
4.7.7	Test Results	95
5	Pictures of Test Arrangements.....	97
	Annex A- Radiated Out of Band Emisison (OOBE) Measurement (For U-NII-3 band)	98
	Appendix – Information on the Testing Laboratories	101

Release Control Record

Issue No.	Description	Date Issued
RF180528C19-4	Original Release	Jun. 25, 2018

1 Certificate of Conformity

Product: Portable Tablet Computer

Brand: Lenovo

Test Model: Lenovo TB-X705F

Sample Status: Production Unit

Applicant: Lenovo(Shanghai) Electronics Technology Co., Ltd.

Test Date: Jun. 02, 2018 ~ Jun. 19, 2018

Standards: 47 CFR FCC Part 15, Subpart E (Section 15.407)
ANSI C63.10:2013

The above equipment has been tested by **Bureau Veritas Consumer Products Services (H.K.) Ltd., Taoyuan Branch**, and found compliance with the requirement of the above standards. The test record, data evaluation & Equipment Under Test (EUT) configurations represented herein are true and accurate accounts of the measurements of the sample's RF characteristics under the conditions specified in this report.

Prepared by :

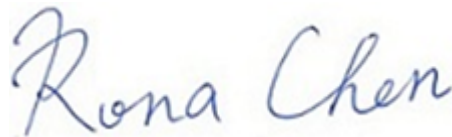

,

Date:

Jun. 25, 2018

Rona Chen / Specialist

Approved by :

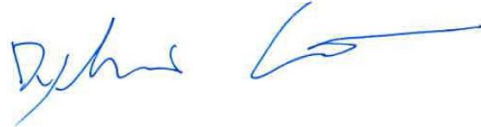

,

Date:

Jun. 25, 2018

Dylan Chiou / Project Engineer

2 Summary of Test Results

47 CFR FCC Part 15, Subpart E (Section 15.407)			
FCC Clause	Test Item	Result	Remarks
15.407(b)(6)	AC Power Conducted Emissions	Pass	Meet the requirement of limit. Minimum passing margin is -13.52 dB at 0.50507 MHz.
15.407(b) (1/2/3/4(i/ii)/6)	Radiated Emissions & Band Edge Measurement	Pass	Meet the requirement of limit. Minimum passing margin is -5.58 dB at 11650 MHz.
15.407(a)(1/2/3)	Max Average Transmit Power	Pass	Meet the requirement of limit.
---	Occupied Bandwidth Measurement	-	Reference only
15.407(a)(1/2/3)	Peak Power Spectral Density	Pass	Meet the requirement of limit.
15.407(e)	6 dB Bandwidth	Pass	Meet the requirement of limit. (U-NII-3 Band only)
15.407(g)	Frequency Stability	Pass	Meet the requirement of limit.
15.203	Antenna Requirement	Pass	No antenna connector is used.

*For U-NII-3 band compliance with rule part 15.407(b)(4)(i), the OOBE test plots were recorded in Annex A.

2.1 Measurement Uncertainty

Where relevant, the following measurement uncertainty levels have been estimated for tests performed on the EUT as specified in CISPR 16-4-2:

Measurement	Frequency	Expanded Uncertainty (k=2) (\pm)
Conducted Emissions at mains ports	150 kHz ~ 30 MHz	2.44 dB
Radiated Emissions up to 1 GHz	30 MHz ~ 200 MHz	2.0153 dB
	200 MHz ~ 1000 MHz	2.0224 dB
Radiated Emissions above 1 GHz	1 GHz ~ 18 GHz	1.0121 dB
	18 GHz ~ 40 GHz	1.1508 dB

2.2 Modification Record

There were no modifications required for compliance.

3 General Information

3.1 General Description of EUT

Product	Portable Tablet Computer
Brand	Lenovo
Test Model	Lenovo TB-X705F
Status of EUT	Production Unit
Power Supply Rating	3.85 Vdc (Battery) 5 Vdc (Adapter or host equipment)
Modulation Type	256QAM, 64QAM, 16QAM, QPSK, BPSK
Modulation Technology	OFDM
Transfer Rate	802.11a: 54.0/ 48.0/ 36.0/ 24.0/ 18.0/ 12.0/ 9.0/ 6.0 Mbps 802.11n: up to 135.0 Mbps 802.11ac: up to 433.3 Mbps
Operating Frequency	5180 ~ 5240 MHz, 5260 ~ 5320 MHz, 5500 ~ 5720 MHz, 5745 ~ 5825 MHz
Number of Channel	5180 ~ 5240 MHz: 4 for 802.11a, 802.11n (HT20) 2 for 802.11n (HT40) 1 for 802.11ac (VHT80) 5260 ~ 5320 MHz: 4 for 802.11a, 802.11n (HT20) 2 for 802.11n (HT40) 1 for 802.11ac (VHT80) 5500 ~ 5720 MHz: 12 for 802.11a, 802.11n (HT20) 6 for 802.11n (HT40) 3 for 802.11ac (VHT80) 5745 ~ 5825 MHz: 5 for 802.11a, 802.11n (HT20) 2 for 802.11n (HT40) 1 for 802.11ac (VHT80)
Output Power	5180 ~ 5240 MHz: 802.11a: 14.65 dBm / 29.174 mW 802.11n (HT20): 14.67 dBm / 29.309 mW 802.11n (HT40): 14.98 dBm / 31.477 mW 802.11ac (VHT80): 11.98 dBm / 15.776 mW 5260 ~ 5320 MHz: 802.11a: 14.67 dBm / 29.309 mW 802.11n (HT20): 14.70 dBm / 29.512 mW 802.11n (HT40): 14.87 dBm / 30.69 mW 802.11ac (VHT80): 12.01 dBm / 15.885 mW 5500 ~ 5720 MHz: 802.11a: 14.76 dBm / 29.923 mW 802.11n (HT20): 14.82 dBm / 30.339 mW 802.11n (HT40): 15.14 dBm / 32.659 mW 802.11ac (VHT80): 12.16 dBm / 16.444 mW 5745 ~ 5825 MHz: 802.11a: 14.59 dBm / 28.774 mW 802.11n (HT20): 14.82 dBm / 30.339 mW 802.11n (HT40): 15.14 dBm / 32.659 mW 802.11ac (VHT80): 12.02 dBm / 15.922 mW

Antenna Type	Monopole antenna with -2.81 dBi gain (5180 ~ 5240 MHz) Monopole antenna with -2.81 dBi gain (5260 ~ 5320 MHz) Monopole antenna with -2.73 dBi gain (5500 ~ 5720 MHz) Monopole antenna with -2.59 dBi gain (5745 ~ 5825 MHz)
Antenna Connector	N/A
Product HW Version	Lenovo Tablet TB-X705F
Product SW Version	TB-X705F_RF01_20180518
Accessory Device	Refer to Note as below
Data Cable Supplied	Refer to Note as below

Note:

1. The EUT provides 1 completed transmitter and 1 receiver.

Modulation Mode	Tx Function
802.11a	1TX
802.11n (HT20)	1TX
802.11n (HT40)	1TX
802.11ac (VHT80)	1TX

2. The EUT contains following accessory devices.

Product	Brand	Model	Description
Adapter 1	Salom	SC-41	I/P: 100-240 Vac, 50/60 Hz, 0.3 A O/P: 5 Vdc, 2 A
Adapter 2	AcBel	SC-41	I/P: 100-240 Vac, 50/60 Hz, 0.3 A O/P: 5 Vdc, 2 A
Battery 1	SCUD	L16D2P31	3.85 Vdc, 7000 mAh
Battery 2	Celxpert	L16D2P31	3.85 Vdc, 7000 mAh
USB Cable 1 (White)	LiQi	LQ-02300039	1 m shielded cable w/o core
USB Cable 2 (Black)	LiQi	LQ-02300040	1 m shielded cable w/o core
LCD Panel 1	BOE	TV101WUM-LL0/TV101WUM-LL1	10.1 "
LCD Panel 2	INNOLUX	P101KZD-AF0/P101KZD-AF1	10.1 "
Photo Camera 1	O-film	L8856A00	8M AF
Photo Camera 2	Q-tech	F8856CB	8M AF
Photo Camera 3	Lcetron	LE5132FM	5M FF
Photo Camera 4	Holitech	MF80G	5M FF
CPU	Qualcomm	SDA-450-A-792NSP-TR-01-0-AA	792nsp

* USB Cable 1 and USB Cable 2 is electrically identical, difference models are for color distinguished. Therefore, only USB Cable 1 is as a representative for final test.

Product	Brand	Model	Description
EMMC1 + DDR1	SAMSUNG	KMGD6001BM-B421 (3+32)	32G
EMMC2 + DDR2	HYNIX	H9TQ26ADFTBCUR-KUM (3+32)	32G
EMMC3 + DDR3	SAMSUNG	KMRH60014A-B614 (4+64)	64G
EMMC4 + DDR4	HYNIX	H9TQ52ACLTMCUR-KUM (4+64)	64G
Speaker	Keysound	QM171219AM48	--
Motor 1	AWA	YK2455R	--
Motor 2	Baolong	BLX-431320S	--
Main Board 1	huashen	W92ME1B3-3-03	--
Main Board 2	yilianda	W92ME1B3-3-05	--
BT/WLAN Module	Qualcomm	WCN-3680B-0-79BWLNSP	--

3. The Adapter 1 and Adapter 2 had been pre-tested to determine the worst-case. The worst case was found in Adapter 1. Therefore, only Adapter 1 was chosen for the final test.
4. The EUT contains two samples.

Sample	Configurations
A	EUT + Battery 1 + LCD Panel 1 + Photo Camera 1 + Photo Camera 3 + EMMC 3 + DDR 3 + Motor 1 + Main Board 1
B	EUT + Battery 2 + LCD Panel 2 + Photo Camera 2 + Photo Camera 4 + EMMC 4 + DDR 4 + Motor 2 + Main Board 2

5. The above EUT information is declared by manufacturer and for more detailed features description, please refers to the manufacturer's specifications or user's manual.

3.2 Description of Test Modes

For 5180 ~ 5240 MHz

4 channels are provided for 802.11a, 802.11n (HT20):

Channel	Frequency (MHz)	Channel	Frequency (MHz)
36	5180	44	5220
40	5200	48	5240

2 channels are provided for 802.11n (HT40):

Channel	Frequency (MHz)	Channel	Frequency (MHz)
38	5190	46	5230

1 channel is provided for 802.11ac (VHT80):

Channel	Frequency (MHz)
42	5210

For 5260 ~ 5320 MHz

4 channels are provided for 802.11a, 802.11n (HT20):

Channel	Frequency (MHz)	Channel	Frequency (MHz)
52	5260	60	5300
56	5280	64	5320

2 channels are provided for 802.11n (HT40):

Channel	Frequency (MHz)	Channel	Frequency (MHz)
54	5270	62	5310

1 channel is provided for 802.11ac (VHT80):

Channel	Frequency (MHz)
58	5290

For 5500 ~ 5700 MHz

12 channels are provided for 802.11a, 802.11n (HT20):

Channel	Frequency (MHz)	Channel	Frequency (MHz)
100	5500	124	5620
104	5520	128	5640
108	5540	132	5660
112	5560	136	5680
116	5580	140	5700
120	5600	144	5720

6 channels are provided for 802.11n (HT40):

Channel	Frequency (MHz)	Channel	Frequency (MHz)
102	5510	126	5630
110	5550	134	5670
118	5590	142	5710

3 channels are provided for 802.11ac (VHT80):

Channel	Frequency (MHz)	Channel	Frequency (MHz)
106	5530	138	5690
122	5610		

For 5745 ~ 5825 MHz:

5 channels are provided for 802.11a, 802.11n (HT20):

Channel	Frequency (MHz)	Channel	Frequency (MHz)
149	5745	161	5805
153	5765	165	5825
157	5785		

2 channels are provided for 802.11n (HT40):

Channel	Frequency (MHz)	Channel	Frequency (MHz)
151	5755	159	5795

1 channel is provided for 802.11ac (VHT80):

Channel	Frequency (MHz)
155	5775

3.2.1 Test Mode Applicability and Tested Channel Detail

EUT Configure Mode	Applicable To				Description
	RE \geq 1G	RE<1G	PLC	APCM	
A	√	√	√	√	Sample A
B	-	√	√	-	Sample B

Where **RE \geq 1G**: Radiated Emission above 1 GHz **RE<1G**: Radiated Emission below 1 GHz
PLC: Power Line Conducted Emission **APCM**: Antenna Port Conducted Measurement

NOTE:

- The EUT had been pre-tested on the positioned of each 3 axis. The worst case was found when positioned on **X-plane** for 5180 ~ 5240 MHz, **Y-plane** for 5260 ~ 5320 MHz & 5500 ~ 5720 MHz, **Z-plane** for 5745 ~ 5825 MHz.
- "-" means no effect.

Radiated Emission Test (Above 1 GHz):

- Pre-Scan has been conducted to determine the worst-case mode from all possible combinations between available modulations, data rates and antenna ports (if EUT with antenna diversity architecture).
- Following channel(s) was (were) selected for the final test as listed below.

EUT Configure Mode	Frequency Band (MHz)	Mode	Available Channel	Tested Channel	Modulation Technology	Modulation Type	Data Rate (Mbps)
A	5180-5240	802.11a	36 to 48	36, 40, 48	OFDM	BPSK	6.0
		802.11n (HT20)	36 to 48	36, 40, 48	OFDM	BPSK	6.5
		802.11n (HT40)	38 to 46	38, 46	OFDM	BPSK	13.5
		802.11ac (VHT80)	42	42	OFDM	BPSK	29.3
	5260-5320	802.11a	52 to 64	52, 60, 64	OFDM	BPSK	6.0
		802.11n (HT20)	52 to 64	52, 60, 64	OFDM	BPSK	6.5
		802.11n (HT40)	54 to 62	54, 62	OFDM	BPSK	13.5
		802.11ac (VHT80)	58	58	OFDM	BPSK	29.3
	5500-5720	802.11a	100 to 144	100, 116, 140, 144	OFDM	BPSK	6.0
		802.11n (HT20)	100 to 144	100, 116, 140, 144	OFDM	BPSK	6.5
		802.11n (HT40)	102 to 142	102, 110, 134, 142	OFDM	BPSK	13.5
		802.11ac (VHT80)	106 to 138	106, 122, 138	OFDM	BPSK	29.3
	5745-5825	802.11a	149 to 165	149, 157, 165	OFDM	BPSK	6.0
		802.11n (HT20)	149 to 165	149, 157, 165	OFDM	BPSK	6.5
		802.11n (HT40)	151 to 159	151, 159	OFDM	BPSK	13.5
		802.11ac (VHT80)	155	155	OFDM	BPSK	29.3

Radiated Emission Test (Below 1 GHz):

- Pre-Scan has been conducted to determine the worst-case mode from all possible combinations between available modulations, data rates and antenna ports (if EUT with antenna diversity architecture).
- Following channel(s) was (were) selected for the final test as listed below.

EUT Configure Mode	Frequency Band (MHz)	Mode	Available Channel	Tested Channel	Modulation Technology	Modulation Type	Data Rate (Mbps)
A, B	5745-5825	802.11n (HT20)	149 to 165	165	OFDM	BPSK	6.5

Power Line Conducted Emission Test:

- Pre-Scan has been conducted to determine the worst-case mode from all possible combinations between available modulations, data rates and antenna ports (if EUT with antenna diversity architecture).
- Following channel(s) was (were) selected for the final test as listed below.

EUT Configure Mode	Test Condition
A, B	WLAN 5G + USB Cable + Adapter

Antenna Port Conducted Measurement:

- This item includes all test value of each mode, but only includes spectrum plot of worst value of each mode.
- Pre-Scan has been conducted to determine the worst-case mode from all possible combinations between available modulations, data rates and antenna ports (if EUT with antenna diversity architecture).
- Following channel(s) was (were) selected for the final test as listed below.

EUT Configure Mode	Frequency Band (MHz)	Mode	Available Channel	Tested Channel	Modulation Technology	Modulation Type	Data Rate (Mbps)
A, B	5180-5240	802.11a	36 to 48	36, 40, 48	OFDM	BPSK	6.0
		802.11n (HT20)	36 to 48	36, 40, 48	OFDM	BPSK	6.5
		802.11n (HT40)	38 to 46	38, 46	OFDM	BPSK	13.5
		802.11ac (VHT80)	42	42	OFDM	BPSK	29.3
	5260-5320	802.11a	52 to 64	52, 60, 64	OFDM	BPSK	6.0
		802.11n (HT20)	52 to 64	52, 60, 64	OFDM	BPSK	6.5
		802.11n (HT40)	54 to 62	54, 62	OFDM	BPSK	13.5
		802.11ac (VHT80)	58	58	OFDM	BPSK	29.3
	5500-5720	802.11a	100 to 144	100, 116, 140, 144	OFDM	BPSK	6.0
		802.11n (HT20)	100 to 144	100, 116, 140, 144	OFDM	BPSK	6.5
		802.11n (HT40)	102 to 142	102, 110, 134, 142	OFDM	BPSK	13.5
		802.11ac (VHT80)	106 to 138	106, 122, 138	OFDM	BPSK	29.3
	5745-5825	802.11a	149 to 165	149, 157, 165	OFDM	BPSK	6.0
		802.11n (HT20)	149 to 165	149, 157, 165	OFDM	BPSK	6.5
		802.11n (HT40)	151 to 159	151, 159	OFDM	BPSK	13.5
		802.11ac (VHT80)	155	155	OFDM	BPSK	29.3

Test Condition:

Applicable To	Environmental Conditions	Input Power	Tested by
RE≥1G	25 deg. C, 65 % RH	120 Vac, 60 Hz	Charles Hsiao
RE<1G	25 deg. C, 65 % RH	120 Vac, 60 Hz	Charles Hsiao
PLC	25 deg. C, 65 % RH	120 Vac, 60 Hz	Getaz Yang Jisyong Wang
APCM	25 deg. C, 65 % RH	3.85 Vdc	Gavin Wu

3.3 Duty Cycle of Test Signal

MODULATION TYPE: BPSK

802.11a: Duty cycle = $1.363/1.563 = 0.872$, Duty factor = $10 * \log(1/0.872) = 0.59$

802.11n (HT20): Duty cycle = $1.272/1.474 = 0.863$, Duty factor = $10 * \log(1/0.863) = 0.64$

802.11n (HT40): Duty cycle = $0.630/0.834 = 0.755$, Duty factor = $10 * \log(1/0.755) = 1.22$

802.11ac (VHT80): Duty cycle = $0.246/0.464 = 0.530$, Duty factor = $10 * \log(1/0.530) = 2.76$

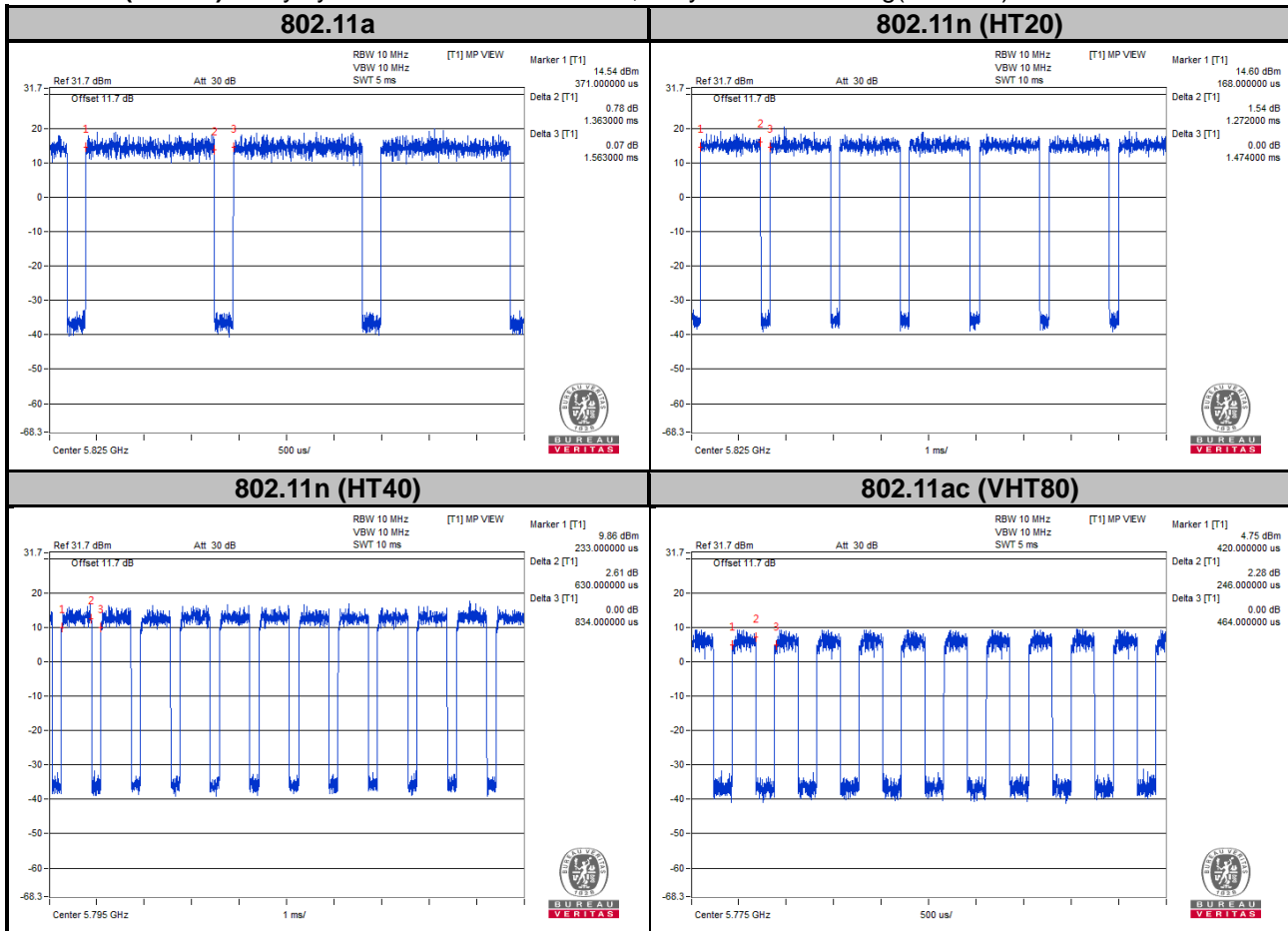

3.4 Description of Support Units

The EUT has been tested as an independent unit together with other necessary accessories or support units. The following support units or accessories were used to form a representative test configuration during the tests.

No.	Product	Brand	Model No.	Serial No.	FCC ID
1.	Earphone	N/A	N/A	N/A	N/A

No.	Signal Cable Description of The Above Support Units
1.	N/A

Note:

1. All power cords of the above support units are non-shielded (1.8m).

3.4.1 Configuration of System under Test

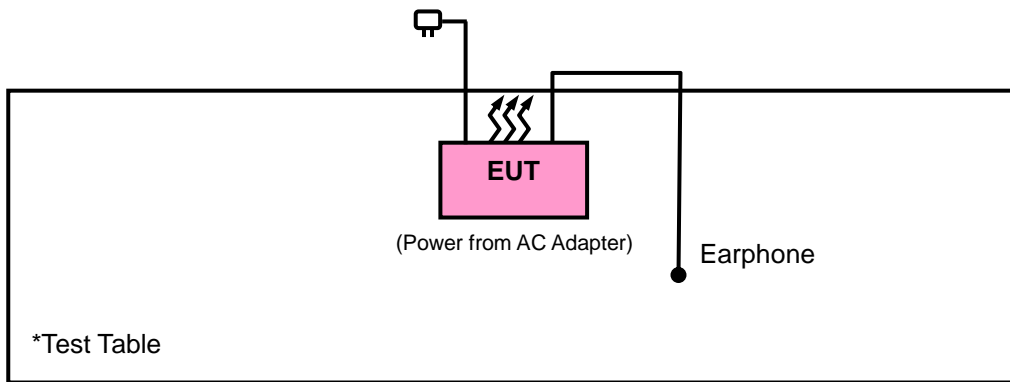

3.5 General Description of Applied Standards

The EUT is a RF Product. According to the specifications of the manufacturer, it must comply with the requirements of the following standards:

FCC Part 15, Subpart E (15.407)

789033 D02 General UNII Test Procedures New Rules v02r01

ANSI C63.10-2013

All test items have been performed and recorded as per the above standards.

4 Test Types and Results

4.1 Radiated Emission and Bandedge Measurement

4.1.1 Limits of Radiated Emission and Bandedge Measurement

Radiated emissions which fall in the restricted bands must comply with the radiated emission limits specified as below table. Other emissions shall be at least 20 dB below the highest level of the desired power:

Frequencies (MHz)	Field Strength (microvolts/meter)	Measurement Distance (meters)
0.009 ~ 0.490	2400/F (kHz)	300
0.490 ~ 1.705	24000/F (kHz)	30
1.705 ~ 30.0	30	30
30 ~ 88	100	3
88 ~ 216	150	3
216 ~ 960	200	3
Above 960	500	3

Note:

1. The lower limit shall apply at the transition frequencies.
2. Emission level (dBuV/m) = 20 log Emission level (uV/m).
3. For frequencies above 1000 MHz, the field strength limits are based on average detector, however, the peak field strength of any emission shall not exceed the maximum permitted average limits, specified above by more than 20 dB under any condition of modulation.

4.1.2 Limits of Unwanted Emission Out of the Restricted Bands

Applicable To		Limit	
789033 D02 General UNII Test Procedures New Rules v02r01		Field Strength at 3 m	
		PK: 74 (dBµV/m)	AV: 54 (dBµV/m)
Frequency Band	Applicable To	EIRP Limit	Equivalent Field Strength at 3 m
5150~5250 MHz	15.407(b)(1)	PK: -27 (dBm/MHz)	PK: 68.2 (dBµV/m)
5250~5350 MHz	15.407(b)(2)		
5470~5725 MHz	15.407(b)(3)		
5725~5850 MHz	15.407(b)(4)(i)	PK:-27 (dBm/MHz) ^{*1} PK:10 (dBm/MHz) ^{*2} PK:15.6 (dBm/MHz) ^{*3} PK:27 (dBm/MHz) ^{*4}	PK: 68.2 (dBµV/m) ^{*1} PK:105.2 (dBµV/m) ^{*2} PK: 110.8 (dBµV/m) ^{*3} PK:122.2 (dBµV/m) ^{*4}
	15.407(b)(4)(ii)	Emission limits in section 15.247(d)	
^{*1} beyond 75 MHz or more above of the band edge. ^{*2} below the band edge increasing linearly to 10 dBm/MHz at 25 MHz above. ^{*3} below the band edge increasing linearly to a level of 15.6 dBm/MHz at 5 MHz above. ^{*4} from 5 MHz above or below the band edge increasing linearly to a level of 27 dBm/MHz at the band edge.			

Note:

The following formula is used to convert the equipment isotropic radiated power (eirp) to field strength:

$$E = \frac{1000000\sqrt{30P}}{3} \mu\text{V/m, where P is the eirp (Watts).$$

4.1.3 Test Instruments

Description & Manufacturer	Model No.	Serial No.	Date of Calibration	Due Date of Calibration
Test Receiver Agilent Technologies	N9038A	MY52260177	Jul. 05, 2017	Jul. 04, 2018
Spectrum Analyzer ROHDE & SCHWARZ	FSU43	101261	Jan. 11, 2018	Jan. 10, 2019
Double Ridge Guide Horn Antenna EMCO	3115	5619	Nov. 30, 2017	Nov. 29, 2018
BILOG Antenna SCHWARZBECK	VULB 9168	9168-153	Dec. 06, 2017	Dec. 05, 2018
Fixed Attenuator Mini-Circuits	BW-N10W5+	NA	Jul. 07, 2017	Jul. 06, 2018
Loop Antenna	EM-6879	269	Aug. 11, 2017	Aug. 10, 2018
Preamplifier Agilent	310N	187226	Jun. 23, 2017	Jun. 22, 2018
Preamplifier Agilent	83017A	MY39501357	Jun. 23, 2017	Jun. 22, 2018
HORN Antenna Schwarzbeck	BBHA 9120D	9120D-969	Dec. 12, 2017	Dec. 11, 2018
Power Meter Anritsu	ML2495A	1012010	Aug. 15, 2017	Aug. 14, 2018
Power Sensor Anritsu	MA2411B	1315050	Aug. 15, 2017	Aug. 14, 2018
RF signal cable ETS-LINDGREN	5D-FB	Cable-CH1-01(RFC -SMS-100-SMS-12 0+RFC-SMS-100-S MS-400)	Jun. 26, 2017	Jun. 25, 2018
RF signal cable ETS-LINDGREN	8D-FB	Cable-CH1-02(RFC -SMS-100-SMS-24)	Jun. 26, 2017	Jun. 25, 2018
Boresight Antenna Fixture	FBA-01	FBA-SIP01	NA	NA
Software BV ADT	E3 8.130425b	NA	NA	NA
Antenna Tower MF	NA	NA	NA	NA
Turn Table MF	NA	NA	NA	NA
Antenna Tower & Turn Table Controller MF	MF-7802	NA	NA	NA
Temperature & Humidity Chamber	GTH-120-40-CP-A R	MAA1306-019	Sep. 08, 2017	Sep. 07, 2018
DC Power Supply Topward	33010D	807748	Oct. 25, 2016	Oct. 24, 2018
Digital Multimeter Fluke	87-III	70360742	Jun. 30, 2017	Jun. 29, 2018

- Note:
1. The calibration interval of the above test instruments is 12/24 months and the calibrations are traceable to NML/ROC and NIST/USA.
 2. The test was performed in HsinTien Chamber 1.
 3. The horn antenna and preamplifier (model: 83017A) are used only for the measurement of emission frequency above 1 GHz if tested.
 4. The IC Site Registration No. is IC7450I-1.

4.1.4 Test Procedures

For Radiated Emission below 30 MHz

- a. The EUT was placed on the top of a rotating table 0.8 meters above the ground at a 3 meter chamber room. The table was rotated 360 degrees to determine the position of the highest radiation.
- b. The EUT was set 3 meters away from the interference-receiving antenna, which was mounted on the top of a variable-height antenna tower.
- c. Both Parallel, perpendicular, and ground-parallel orientations of the antenna are set to make the measurement.
- d. For each suspected emission, the EUT was arranged to its worst case and the rotatable table was turned from 0 degrees to 360 degrees to find the maximum reading.
- e. The test-receiver system was set to Quasi-Peak Detect Function and Specified Bandwidth with Maximum Hold Mode.

Note:

1. The resolution bandwidth and video bandwidth of test receiver/spectrum analyzer is 9 kHz at frequency below 30 MHz.

For Radiated Emission above 30 MHz

- a. The EUT was placed on the top of a rotating table 0.8 meters (for 30 MHz ~ 1 GHz) / 1.5 meters (for above 1 GHz) above the ground at 3 meter chamber room for test. The table was rotated 360 degrees to determine the position of the highest radiation.
- b. The EUT was set 3 meters away from the interference-receiving antenna, which was mounted on the top of a variable-height antenna tower.
- c. The height of antenna is varied from one meter to four meters above the ground to determine the maximum value of the field strength. Both horizontal and vertical polarizations of the antenna are set to make the measurement.
- d. For each suspected emission, the EUT was arranged to its worst case and then the antenna was tuned to heights from 1 meter to 4 meters and the rotatable table was turned from 0 degrees to 360 degrees to find the maximum reading.
- e. The test-receiver system was set to quasi-peak detect function and specified bandwidth with maximum hold mode when the test frequency is below 1 GHz.
- f. The test-receiver system was set to peak and average detected function and specified bandwidth with maximum hold mode when the test frequency is above 1 GHz. If the peak reading value also meets average limit, measurement with the average detector is unnecessary.

Note:

1. The resolution bandwidth and video bandwidth of test receiver/spectrum analyzer is 120 kHz for Quasi-peak detection (QP) at frequency below 1 GHz.
2. The resolution bandwidth of test receiver/spectrum analyzer is 1 MHz and the video bandwidth is 3 MHz for Peak detection (PK) at frequency above 1 GHz.
3. The resolution bandwidth of test receiver/spectrum analyzer is 1 MHz and the video bandwidth is $\geq 1/T$ (Duty cycle < 98 %) or 10 Hz (Duty cycle ≥ 98 %) for Average detection (AV) at frequency above 1 GHz.
(11a: RBW = 1 MHz, VBW = 1 kHz ; 11n (HT20): RBW = 1 MHz, VBW = 1 kHz ;
11n (HT40): RBW = 1 MHz, VBW = 3 kHz ; 11ac (VHT80): RBW = 1 MHz, VBW = 10 kHz)
4. All modes of operation were investigated and the worst-case emissions are reported.

4.1.5 Deviation from Test Standard

No deviation.

4.1.6 Test Setup

<Radiated Emission below 30 MHz>

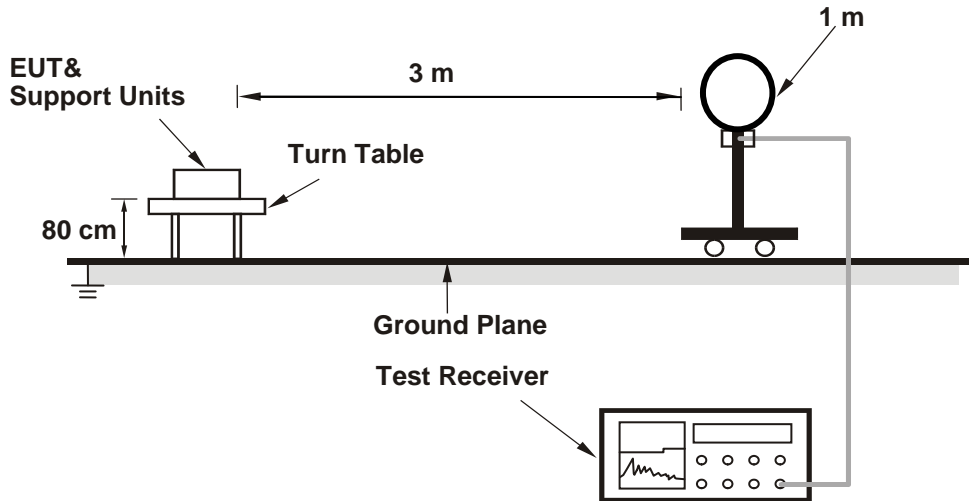

<Radiated Emission 30 MHz to 1 GHz>

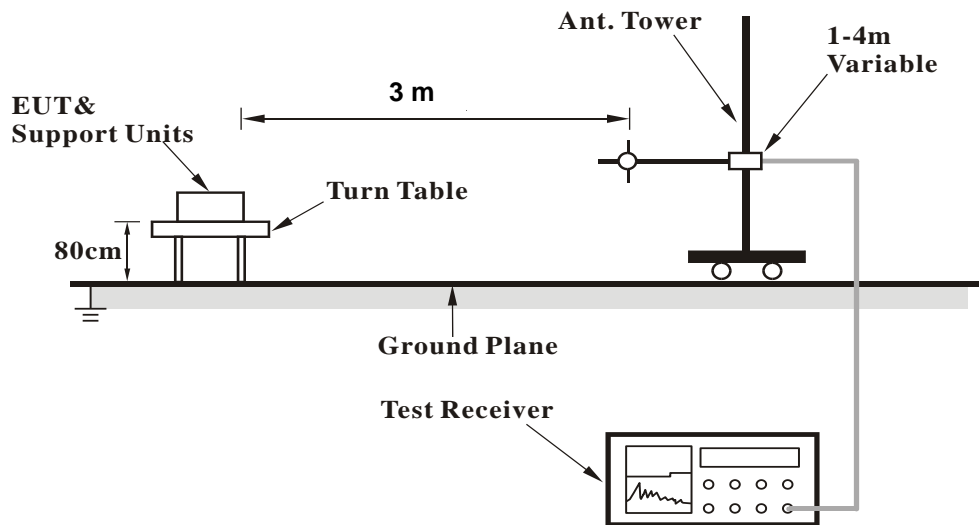

<Radiated Emission above 1 GHz>

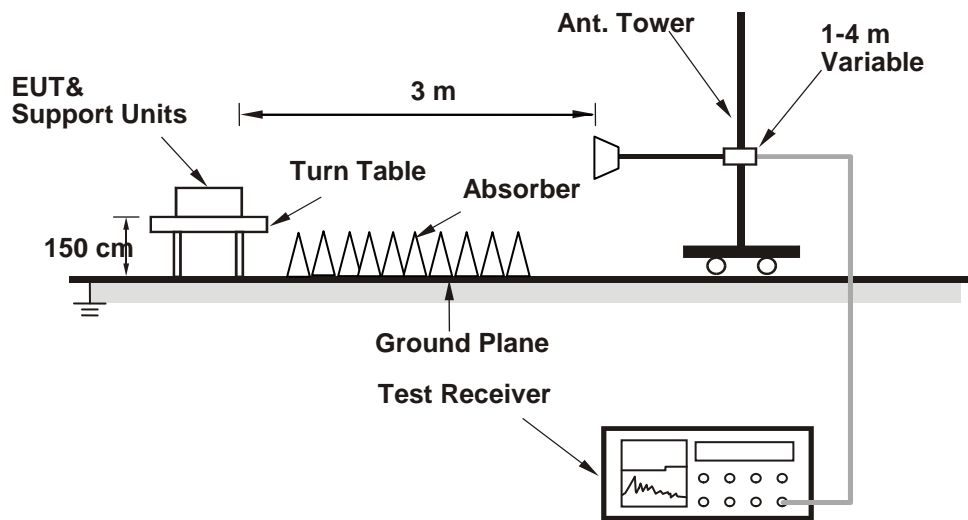

For the actual test configuration, please refer to the attached file (Test Setup Photo).

4.1.7 EUT Operating Conditions

- Placed the EUT on a testing table.
- Use the software to control the EUT under transmission condition continuously at specific channel frequency.

4.1.8 Test Results
 Above 1 GHz Data :
 Mode A
 802.11a

EUT Test Condition		Measurement Detail	
Channel	Channel 36	Frequency Range	1 GHz ~ 40 GHz
Input Power	120 Vac, 60 Hz	Detector Function	Peak (PK) Average (AV)
Environmental Conditions	25 deg. C, 65 % RH	Tested By	Charles Hsiao

Antenna Polarity & Test Distance: Horizontal at 3 m										
Frequency (MHz)	Emission Level (dBuV/m)	Read Level (dBuV)	Limit (dBuV/m)	Margin (dB)	Antenna Factor (dB/m)	Cable Loss (dB)	Preamp Factor (dB)	Antenna Height (cm)	Table Angle (Degree)	Remark
5128.1	43.67	35.45	54	-10.33	34.11	8.1	33.99	234	330	Average
5128.1	53.49	45.27	74	-20.51	34.11	8.1	33.99	234	330	Peak
5180	93.31	85			34.15	8.16	34	234	330	Average
5180	100.1	91.79			34.15	8.16	34	234	330	Peak
*10360	56.01	41.71	68.2	-12.19	37.12	12.3	35.12	135	55	Peak

Antenna Polarity & Test Distance: Vertical at 3 m										
Frequency (MHz)	Emission Level (dBuV/m)	Read Level (dBuV)	Limit (dBuV/m)	Margin (dB)	Antenna Factor (dB/m)	Cable Loss (dB)	Preamp Factor (dB)	Antenna Height (cm)	Table Angle (Degree)	Remark
5126.75	42.89	34.67	54	-11.11	34.11	8.1	33.99	101	178	Average
5126.75	53.1	44.88	74	-20.9	34.11	8.1	33.99	101	178	Peak
5180	90.35	82.04			34.15	8.16	34	101	178	Average
5180	97.57	89.26			34.15	8.16	34	101	178	Peak
*10360	55.6	41.3	68.2	-12.6	37.12	12.3	35.12	124	344	Peak

Remarks:

- Emission Level = Read Level + Antenna Factor + Cable Loss - Preamp Factor
Margin value = Emission level – Limit value
- 5180 MHz: Fundamental Frequency
- *: Out of Restricted Band
- The emission levels of other frequencies were very low against the limit

EUT Test Condition		Measurement Detail	
Channel	Channel 40	Frequency Range	1 GHz ~ 40 GHz
Input Power	120 Vac, 60 Hz	Detector Function	Peak (PK) Average (AV)
Environmental Conditions	25 deg. C, 65 % RH	Tested By	Charles Hsiao

Antenna Polarity & Test Distance: Horizontal at 3 m										
Frequency (MHz)	Emission Level (dBuV/m)	Read Level (dBuV)	Limit (dBuV/m)	Margin (dB)	Antenna Factor (dB/m)	Cable Loss (dB)	Preamp Factor (dB)	Antenna Height (cm)	Table Angle (Degree)	Remark
5138.9	42.54	34.29	54	-11.46	34.11	8.13	33.99	234	330	Average
5138.9	53.75	45.5	74	-20.25	34.11	8.13	33.99	234	330	Peak
5200	93.47	85.12			34.16	8.19	34	234	330	Average
5200	100.45	92.1			34.16	8.19	34	234	330	Peak
5426.89	42.76	33.99	54	-11.24	34.33	8.48	34.04	234	330	Average
5426.89	53.44	44.67	74	-20.56	34.33	8.48	34.04	234	330	Peak
10400	55.33	40.99	74	-18.67	37.14	12.36	35.16	173	35	Peak
Antenna Polarity & Test Distance: Vertical at 3 m										
Frequency (MHz)	Emission Level (dBuV/m)	Read Level (dBuV)	Limit (dBuV/m)	Margin (dB)	Antenna Factor (dB/m)	Cable Loss (dB)	Preamp Factor (dB)	Antenna Height (cm)	Table Angle (Degree)	Remark
5133.65	42.51	34.26	54	-11.49	34.11	8.13	33.99	101	178	Average
5133.65	53.55	45.3	74	-20.45	34.11	8.13	33.99	101	178	Peak
5200	90.41	82.06			34.16	8.19	34	101	178	Average
5200	97.56	89.21			34.16	8.19	34	101	178	Peak
5448.34	42.64	33.81	54	-11.36	34.36	8.51	34.04	101	178	Average
5448.34	53.97	45.14	74	-20.03	34.36	8.51	34.04	101	178	Peak
10400	54.89	40.55	74	-19.11	37.14	12.36	35.16	116	247	Peak

Remarks:

- Emission Level = Read Level + Antenna Factor + Cable Loss - Preamp Factor
Margin value = Emission level – Limit value
- 5200 MHz: Fundamental Frequency
- *: Out of Restricted Band
- The emission levels of other frequencies were very low against the limit

EUT Test Condition		Measurement Detail	
Channel	Channel 48	Frequency Range	1 GHz ~ 40 GHz
Input Power	120 Vac, 60 Hz	Detector Function	Peak (PK) Average (AV)
Environmental Conditions	25 deg. C, 65 % RH	Tested By	Charles Hsiao

Antenna Polarity & Test Distance: Horizontal at 3 m										
Frequency (MHz)	Emission Level (dBuV/m)	Read Level (dBuV)	Limit (dBuV/m)	Margin (dB)	Antenna Factor (dB/m)	Cable Loss (dB)	Preamp Factor (dB)	Antenna Height (cm)	Table Angle (Degree)	Remark
5240	93.35	84.91			34.19	8.26	34.01	234	330	Average
5240	100.4	91.96			34.19	8.26	34.01	234	330	Peak
5455.6	42.79	33.97	54	-11.21	34.36	8.51	34.05	234	330	Average
5455.6	53.26	44.44	74	-20.74	34.36	8.51	34.05	234	330	Peak
*10480	56.75	42.24	68.2	-11.45	37.19	12.53	35.21	158	9	Peak

Antenna Polarity & Test Distance: Vertical at 3 m										
Frequency (MHz)	Emission Level (dBuV/m)	Read Level (dBuV)	Limit (dBuV/m)	Margin (dB)	Antenna Factor (dB/m)	Cable Loss (dB)	Preamp Factor (dB)	Antenna Height (cm)	Table Angle (Degree)	Remark
5240	90.11	81.67			34.19	8.26	34.01	101	178	Average
5240	97.08	88.64			34.19	8.26	34.01	101	178	Peak
5448.12	42.71	33.88	54	-11.29	34.36	8.51	34.04	101	178	Average
5448.12	53.37	44.54	74	-20.63	34.36	8.51	34.04	101	178	Peak
*10480	56.24	41.73	68.2	-11.96	37.19	12.53	35.21	119	246	Peak

Remarks:

- Emission Level = Read Level + Antenna Factor + Cable Loss - Preamp Factor
Margin value = Emission level – Limit value
- 5240 MHz: Fundamental Frequency
- *: Out of Restricted Band
- The emission levels of other frequencies were very low against the limit

EUT Test Condition		Measurement Detail	
Channel	Channel 52	Frequency Range	1 GHz ~ 40 GHz
Input Power	120 Vac, 60 Hz	Detector Function	Peak (PK) Average (AV)
Environmental Conditions	25 deg. C, 65 % RH	Tested By	Charles Hsiao

Antenna Polarity & Test Distance: Horizontal at 3 m										
Frequency (MHz)	Emission Level (dBuV/m)	Read Level (dBuV)	Limit (dBuV/m)	Margin (dB)	Antenna Factor (dB/m)	Cable Loss (dB)	Preamp Factor (dB)	Antenna Height (cm)	Table Angle (Degree)	Remark
5144.9	42.6	34.35	54	-11.4	34.12	8.13	34	200	118	Average
5144.9	53.55	45.3	74	-20.45	34.12	8.13	34	200	118	Peak
5260	94.95	86.49			34.21	8.26	34.01	200	118	Average
5260	102.64	94.18			34.21	8.26	34.01	200	118	Peak
*10520	57.38	42.79	68.2	-10.82	37.21	12.61	35.23	196	331	Peak

Antenna Polarity & Test Distance: Vertical at 3 m										
Frequency (MHz)	Emission Level (dBuV/m)	Read Level (dBuV)	Limit (dBuV/m)	Margin (dB)	Antenna Factor (dB/m)	Cable Loss (dB)	Preamp Factor (dB)	Antenna Height (cm)	Table Angle (Degree)	Remark
5129	42.66	34.44	54	-11.34	34.11	8.1	33.99	274	208	Average
5129	53.96	45.74	74	-20.04	34.11	8.1	33.99	274	208	Peak
5260	91.81	83.35			34.21	8.26	34.01	274	208	Average
5260	99.14	90.68			34.21	8.26	34.01	274	208	Peak
*10520	55.73	41.14	68.2	-12.47	37.21	12.61	35.23	137	126	Peak

Remarks:

- Emission Level = Read Level + Antenna Factor + Cable Loss - Preamp Factor
Margin value = Emission level – Limit value
- 5260 MHz: Fundamental Frequency
- *: Out of Restricted Band
- The emission levels of other frequencies were very low against the limit

EUT Test Condition		Measurement Detail	
Channel	Channel 60	Frequency Range	1 GHz ~ 40 GHz
Input Power	120 Vac, 60 Hz	Detector Function	Peak (PK) Average (AV)
Environmental Conditions	25 deg. C, 65 % RH	Tested By	Charles Hsiao

Antenna Polarity & Test Distance: Horizontal at 3 m										
Frequency (MHz)	Emission Level (dBuV/m)	Read Level (dBuV)	Limit (dBuV/m)	Margin (dB)	Antenna Factor (dB/m)	Cable Loss (dB)	Preamp Factor (dB)	Antenna Height (cm)	Table Angle (Degree)	Remark
5131.25	42.67	34.45	54	-11.33	34.11	8.1	33.99	200	118	Average
5131.25	54.51	46.29	74	-19.49	34.11	8.1	33.99	200	118	Peak
5300	94.9	86.36			34.24	8.32	34.02	200	118	Average
5300	102.67	94.13			34.24	8.32	34.02	200	118	Peak
5352.2	44.28	35.65	54	-9.72	34.28	8.38	34.03	200	118	Average
5352.2	53.71	45.08	74	-20.29	34.28	8.38	34.03	200	118	Peak
10600	45.86	31.18	54	-8.14	37.28	12.67	35.27	127	320	Average
10600	55.95	41.27	74	-18.05	37.28	12.67	35.27	127	320	Peak

Antenna Polarity & Test Distance: Vertical at 3 m										
Frequency (MHz)	Emission Level (dBuV/m)	Read Level (dBuV)	Limit (dBuV/m)	Margin (dB)	Antenna Factor (dB/m)	Cable Loss (dB)	Preamp Factor (dB)	Antenna Height (cm)	Table Angle (Degree)	Remark
5141	42.58	34.32	54	-11.42	34.12	8.13	33.99	274	208	Average
5141	54.55	46.29	74	-19.45	34.12	8.13	33.99	274	208	Peak
5300	91.24	82.7			34.24	8.32	34.02	274	208	Average
5300	99.54	91			34.24	8.32	34.02	274	208	Peak
5352.09	43.01	34.38	54	-10.99	34.28	8.38	34.03	274	208	Average
5352.09	53.44	44.81	74	-20.56	34.28	8.38	34.03	274	208	Peak
10600	46.29	31.61	54	-7.71	37.28	12.67	35.27	185	131	Average
10600	56.31	41.63	74	-17.69	37.28	12.67	35.27	185	131	Peak

Remarks:

- Emission Level = Read Level + Antenna Factor + Cable Loss - Preamp Factor
Margin value = Emission level – Limit value
- 5300 MHz: Fundamental Frequency
- *: Out of Restricted Band
- The emission levels of other frequencies were very low against the limit

EUT Test Condition		Measurement Detail	
Channel	Channel 64	Frequency Range	1 GHz ~ 40 GHz
Input Power	120 Vac, 60 Hz	Detector Function	Peak (PK) Average (AV)
Environmental Conditions	25 deg. C, 65 % RH	Tested By	Charles Hsiao

Antenna Polarity & Test Distance: Horizontal at 3 m										
Frequency (MHz)	Emission Level (dBuV/m)	Read Level (dBuV)	Limit (dBuV/m)	Margin (dB)	Antenna Factor (dB/m)	Cable Loss (dB)	Preamp Factor (dB)	Antenna Height (cm)	Table Angle (Degree)	Remark
5320	94.58	86			34.25	8.35	34.02	200	118	Average
5320	103.23	94.65			34.25	8.35	34.02	200	118	Peak
5372	43.95	35.28	54	-10.05	34.29	8.41	34.03	200	118	Average
5372	53.6	44.93	74	-20.4	34.29	8.41	34.03	200	118	Peak
10640	46.51	31.78	54	-7.49	37.31	12.71	35.29	145	177	Average
10640	56.47	41.74	74	-17.53	37.31	12.71	35.29	145	177	Peak

Antenna Polarity & Test Distance: Vertical at 3 m										
Frequency (MHz)	Emission Level (dBuV/m)	Read Level (dBuV)	Limit (dBuV/m)	Margin (dB)	Antenna Factor (dB/m)	Cable Loss (dB)	Preamp Factor (dB)	Antenna Height (cm)	Table Angle (Degree)	Remark
5320	91.71	83.13			34.25	8.35	34.02	274	208	Average
5320	99.01	90.43			34.25	8.35	34.02	274	208	Peak
5372.44	43.2	34.53	54	-10.8	34.29	8.41	34.03	274	208	Average
5372.44	53.5	44.83	74	-20.5	34.29	8.41	34.03	274	208	Peak
10640	46.32	31.59	54	-7.68	37.31	12.71	35.29	112	139	Average
10640	56.25	41.52	74	-17.75	37.31	12.71	35.29	112	139	Peak

Remarks:

- Emission Level = Read Level + Antenna Factor + Cable Loss - Preamp Factor
Margin value = Emission level – Limit value
- 5320 MHz: Fundamental Frequency
- *: Out of Restricted Band
- The emission levels of other frequencies were very low against the limit

EUT Test Condition		Measurement Detail	
Channel	Channel 100	Frequency Range	1 GHz ~ 40 GHz
Input Power	120 Vac, 60 Hz	Detector Function	Peak (PK) Average (AV)
Environmental Conditions	25 deg. C, 65 % RH	Tested By	Charles Hsiao

Antenna Polarity & Test Distance: Horizontal at 3 m										
Frequency (MHz)	Emission Level (dBuV/m)	Read Level (dBuV)	Limit (dBuV/m)	Margin (dB)	Antenna Factor (dB/m)	Cable Loss (dB)	Preamp Factor (dB)	Antenna Height (cm)	Table Angle (Degree)	Remark
5447.6	44.89	36.06	54	-9.11	34.36	8.51	34.04	213	63	Average
5447.6	54.19	45.36	74	-19.81	34.36	8.51	34.04	213	63	Peak
*5468.4	52.87	44.04	68.2	-15.33	34.37	8.51	34.05	213	63	Peak
5500	95.35	86.43			34.4	8.57	34.05	213	63	Average
5500	103.28	94.36			34.4	8.57	34.05	213	63	Peak
11000	46.78	31.7	54	-7.22	37.6	12.96	35.48	112	162	Average
11000	56.62	41.54	74	-17.38	37.6	12.96	35.48	112	162	Peak
Antenna Polarity & Test Distance: Vertical at 3 m										
Frequency (MHz)	Emission Level (dBuV/m)	Read Level (dBuV)	Limit (dBuV/m)	Margin (dB)	Antenna Factor (dB/m)	Cable Loss (dB)	Preamp Factor (dB)	Antenna Height (cm)	Table Angle (Degree)	Remark
5447.92	43.85	35.02	54	-10.15	34.36	8.51	34.04	201	182	Average
5447.92	53.27	44.44	74	-20.73	34.36	8.51	34.04	201	182	Peak
*5469.2	52.09	43.26	68.2	-16.11	34.37	8.51	34.05	201	182	Peak
5500	92.94	84.02			34.4	8.57	34.05	201	182	Average
5500	100.1	91.18			34.4	8.57	34.05	201	182	Peak
11000	47.83	32.75	54	-6.17	37.6	12.96	35.48	108	240	Average
11000	58.15	43.07	74	-15.85	37.6	12.96	35.48	108	240	Peak

Remarks:

- Emission Level = Read Level + Antenna Factor + Cable Loss - Preamp Factor
Margin value = Emission level – Limit value
- 5500 MHz: Fundamental Frequency
- *: Out of Restricted Band
- The emission levels of other frequencies were very low against the limit

EUT Test Condition		Measurement Detail	
Channel	Channel 116	Frequency Range	1 GHz ~ 40 GHz
Input Power	120 Vac, 60 Hz	Detector Function	Peak (PK) Average (AV)
Environmental Conditions	25 deg. C, 65 % RH	Tested By	Charles Hsiao

Antenna Polarity & Test Distance: Horizontal at 3 m										
Frequency (MHz)	Emission Level (dBuV/m)	Read Level (dBuV)	Limit (dBuV/m)	Margin (dB)	Antenna Factor (dB/m)	Cable Loss (dB)	Preamp Factor (dB)	Antenna Height (cm)	Table Angle (Degree)	Remark
5454.8	42.71	33.89	54	-11.29	34.36	8.51	34.05	215	65	Average
5454.8	53.43	44.61	74	-20.57	34.36	8.51	34.05	215	65	Peak
*5468.72	52.87	44.04	68.2	-15.33	34.37	8.51	34.05	215	65	Peak
5580	96.16	87.17			34.47	8.6	34.08	215	65	Average
5580	104.53	95.54			34.47	8.6	34.08	215	65	Peak
*5724.68	51.9	42.74	68.2	-16.3	34.62	8.65	34.11	215	65	Peak
11160	46.41	31.33	54	-7.59	37.7	12.83	35.45	175	123	Average
11160	56.35	41.27	74	-17.65	37.7	12.83	35.45	175	123	Peak

Antenna Polarity & Test Distance: Vertical at 3 m										
Frequency (MHz)	Emission Level (dBuV/m)	Read Level (dBuV)	Limit (dBuV/m)	Margin (dB)	Antenna Factor (dB/m)	Cable Loss (dB)	Preamp Factor (dB)	Antenna Height (cm)	Table Angle (Degree)	Remark
5451.76	42.82	34	54	-11.18	34.36	8.51	34.05	201	182	Average
5451.76	53.11	44.29	74	-20.89	34.36	8.51	34.05	201	182	Peak
*5468.56	52.14	43.31	68.2	-16.06	34.37	8.51	34.05	201	182	Peak
5580	93.55	84.56			34.47	8.6	34.08	201	182	Average
5580	101.13	92.14			34.47	8.6	34.08	201	182	Peak
*5724.85	51.83	42.67	68.2	-16.37	34.62	8.65	34.11	201	182	Peak
11160	46.59	31.51	54	-7.41	37.7	12.83	35.45	138	105	Average
11160	56.62	41.54	74	-17.38	37.7	12.83	35.45	138	105	Peak

Remarks:

- Emission Level = Read Level + Antenna Factor + Cable Loss - Preamp Factor
Margin value = Emission level – Limit value
- 5580 MHz: Fundamental Frequency
- *: Out of Restricted Band
- The emission levels of other frequencies were very low against the limit

EUT Test Condition		Measurement Detail	
Channel	Channel 140	Frequency Range	1 GHz ~ 40 GHz
Input Power	120 Vac, 60 Hz	Detector Function	Peak (PK) Average (AV)
Environmental Conditions	25 deg. C, 65 % RH	Tested By	Charles Hsiao

Antenna Polarity & Test Distance: Horizontal at 3 m										
Frequency (MHz)	Emission Level (dBuV/m)	Read Level (dBuV)	Limit (dBuV/m)	Margin (dB)	Antenna Factor (dB/m)	Cable Loss (dB)	Preamp Factor (dB)	Antenna Height (cm)	Table Angle (Degree)	Remark
5700	96.07	86.94			34.59	8.64	34.1	159	65	Average
5700	103.34	94.21			34.59	8.64	34.1	159	65	Peak
*5724.6	51.94	42.78	68.2	-16.26	34.62	8.65	34.11	159	65	Peak
11400	46.7	31.6	54	-7.3	37.84	12.67	35.41	145	108	Average
11400	56.85	41.75	74	-17.15	37.84	12.67	35.41	145	108	Peak

Antenna Polarity & Test Distance: Vertical at 3 m										
Frequency (MHz)	Emission Level (dBuV/m)	Read Level (dBuV)	Limit (dBuV/m)	Margin (dB)	Antenna Factor (dB/m)	Cable Loss (dB)	Preamp Factor (dB)	Antenna Height (cm)	Table Angle (Degree)	Remark
5700	93.75	84.62			34.59	8.64	34.1	252	182	Average
5700	100.65	91.52			34.59	8.64	34.1	252	182	Peak
*5724.76	53.57	44.41	68.2	-14.63	34.62	8.65	34.11	252	182	Peak
11400	47.95	32.85	54	-6.05	37.84	12.67	35.41	169	227	Average
11400	58.11	43.01	74	-15.89	37.84	12.67	35.41	169	227	Peak

Remarks:

- Emission Level = Read Level + Antenna Factor + Cable Loss - Preamp Factor
Margin value = Emission level – Limit value
- 5700 MHz: Fundamental Frequency
- *: Out of Restricted Band
- The emission levels of other frequencies were very low against the limit

EUT Test Condition		Measurement Detail	
Channel	Channel 144	Frequency Range	1 GHz ~ 40 GHz
Input Power	120 Vac, 60 Hz	Detector Function	Peak (PK) Average (AV)
Environmental Conditions	25 deg. C, 65 % RH	Tested By	Charles Hsiao

Antenna Polarity & Test Distance: Horizontal at 3 m										
Frequency (MHz)	Emission Level (dBuV/m)	Read Level (dBuV)	Limit (dBuV/m)	Margin (dB)	Antenna Factor (dB/m)	Cable Loss (dB)	Preamp Factor (dB)	Antenna Height (cm)	Table Angle (Degree)	Remark
5459.92	42.81	33.99	54	-11.19	34.36	8.51	34.05	159	65	Average
5459.92	53.19	44.37	74	-20.81	34.36	8.51	34.05	159	65	Peak
*5470.96	52.72	43.86	68.2	-15.48	34.37	8.54	34.05	159	65	Peak
5720	97.85	88.69			34.62	8.65	34.11	159	65	Average
5720	104.3	95.14			34.62	8.65	34.11	159	65	Peak
11440	46.2	31.09	54	-7.8	37.86	12.65	35.4	132	76	Average
11440	56.01	40.9	74	-17.99	37.86	12.65	35.4	132	76	Peak
Antenna Polarity & Test Distance: Vertical at 3 m										
Frequency (MHz)	Emission Level (dBuV/m)	Read Level (dBuV)	Limit (dBuV/m)	Margin (dB)	Antenna Factor (dB/m)	Cable Loss (dB)	Preamp Factor (dB)	Antenna Height (cm)	Table Angle (Degree)	Remark
5393.36	42.66	33.95	54	-11.34	34.31	8.44	34.04	252	188	Average
5393.36	53.02	44.31	74	-20.98	34.31	8.44	34.04	252	188	Peak
*5469.04	51.29	42.46	68.2	-16.91	34.37	8.51	34.05	252	188	Peak
5720	93.55	84.39			34.62	8.65	34.11	252	188	Average
5720	100.3	91.14			34.62	8.65	34.11	252	188	Peak
11440	47.49	32.38	54	-6.51	37.86	12.65	35.4	124	150	Average
11440	57.38	42.27	74	-16.62	37.86	12.65	35.4	124	150	Peak

Remarks:

- Emission Level = Read Level + Antenna Factor + Cable Loss - Preamp Factor
Margin value = Emission level – Limit value
- 5720 MHz: Fundamental Frequency
- *: Out of Restricted Band
- The emission levels of other frequencies were very low against the limit

EUT Test Condition		Measurement Detail	
Channel	Channel 149	Frequency Range	1 GHz ~ 40 GHz
Input Power	120 Vac, 60 Hz	Detector Function	Peak (PK) Average (AV)
Environmental Conditions	25 deg. C, 65 % RH	Tested By	Charles Hsiao

<Spurious Emission>

Antenna Polarity & Test Distance: Horizontal at 3 m										
Frequency (MHz)	Emission Level (dBuV/m)	Read Level (dBuV)	Limit (dBuV/m)	Margin (dB)	Antenna Factor (dB/m)	Cable Loss (dB)	Preamp Factor (dB)	Antenna Height (cm)	Table Angle (Degree)	Remark
5745	95.62	86.43			34.64	8.66	34.11	100	202	Average
5745	102.22	93.03			34.64	8.66	34.11	100	202	Peak
11490	47.75	32.63	54	-6.25	37.89	12.62	35.39	189	165	Average
11490	57.55	42.43	74	-16.45	37.89	12.62	35.39	189	165	Peak
Antenna Polarity & Test Distance: Vertical at 3 m										
Frequency (MHz)	Emission Level (dBuV/m)	Read Level (dBuV)	Limit (dBuV/m)	Margin (dB)	Antenna Factor (dB/m)	Cable Loss (dB)	Preamp Factor (dB)	Antenna Height (cm)	Table Angle (Degree)	Remark
5745	91.47	82.28			34.64	8.66	34.11	166	5	Average
5745	98.34	89.15			34.64	8.66	34.11	166	5	Peak
11490	47.86	32.74	54	-6.14	37.89	12.62	35.39	118	126	Average
11490	57.02	41.9	74	-16.98	37.89	12.62	35.39	118	126	Peak

<Out of Band Emission (OOBE)>

Antenna Polarity & Test Distance: Horizontal at 3 m										
Frequency (MHz)	Emission Level (dBuV/m)	Read Level (dBuV)	Limit (dBuV/m)	Margin (dB)	Antenna Factor (dB/m)	Cable Loss (dB)	Preamp Factor (dB)	Antenna Height (cm)	Table Angle (Degree)	Remark
*5613.925	54.36	45.33	68.2	-13.84	34.5	8.61	34.08	100	202	Peak
5652.775	53.15	44.05	70.25	-17.1	34.56	8.63	34.09	100	202	Peak
5921.575	52.79	43.39	70.73	-17.94	34.83	8.73	34.16	100	202	Peak
*5930.5	53	43.6	68.2	-15.2	34.83	8.73	34.16	100	202	Peak
Antenna Polarity & Test Distance: Vertical at 3 m										
Frequency (MHz)	Emission Level (dBuV/m)	Read Level (dBuV)	Limit (dBuV/m)	Margin (dB)	Antenna Factor (dB/m)	Cable Loss (dB)	Preamp Factor (dB)	Antenna Height (cm)	Table Angle (Degree)	Remark
*5620.225	53.66	44.61	68.2	-14.54	34.52	8.61	34.08	166	5	Peak
5655.925	52.21	43.12	72.58	-20.37	34.56	8.63	34.1	166	5	Peak
5919.475	52.9	43.52	72.29	-19.39	34.81	8.73	34.16	166	5	Peak
*5986.15	53.59	44.13	68.2	-14.61	34.88	8.75	34.17	166	5	Peak

Remarks:

- Emission Level = Read Level + Antenna Factor + Cable Loss - Preamp Factor
Margin value = Emission level – Limit value
- 5745 MHz: Fundamental Frequency
- *: Out of Restricted Band
- The emission levels of other frequencies were very low against the limit

EUT Test Condition		Measurement Detail	
Channel	Channel 157	Frequency Range	1 GHz ~ 40 GHz
Input Power	120 Vac, 60 Hz	Detector Function	Peak (PK) Average (AV)
Environmental Conditions	25 deg. C, 65 % RH	Tested By	Charles Hsiao

<Spurious Emission>

Antenna Polarity & Test Distance: Horizontal at 3 m										
Frequency (MHz)	Emission Level (dBuV/m)	Read Level (dBuV)	Limit (dBuV/m)	Margin (dB)	Antenna Factor (dB/m)	Cable Loss (dB)	Preamp Factor (dB)	Antenna Height (cm)	Table Angle (Degree)	Remark
5785	95.44	86.21			34.68	8.68	34.13	100	202	Average
5785	102.53	93.3			34.68	8.68	34.13	100	202	Peak
11570	48.05	32.74	54	-5.95	38	12.68	35.37	147	7	Average
11570	57.62	42.31	74	-16.38	38	12.68	35.37	147	7	Peak
Antenna Polarity & Test Distance: Vertical at 3 m										
Frequency (MHz)	Emission Level (dBuV/m)	Read Level (dBuV)	Limit (dBuV/m)	Margin (dB)	Antenna Factor (dB/m)	Cable Loss (dB)	Preamp Factor (dB)	Antenna Height (cm)	Table Angle (Degree)	Remark
5785	91.63	82.4			34.68	8.68	34.13	166	5	Average
5785	98.55	89.32			34.68	8.68	34.13	166	5	Peak
11570	47.94	32.63	54	-6.06	38	12.68	35.37	158	263	Average
11570	58.03	42.72	74	-15.97	38	12.68	35.37	158	263	Peak

<Out of Band Emission (OOBE)>

Antenna Polarity & Test Distance: Horizontal at 3 m										
Frequency (MHz)	Emission Level (dBuV/m)	Read Level (dBuV)	Limit (dBuV/m)	Margin (dB)	Antenna Factor (dB/m)	Cable Loss (dB)	Preamp Factor (dB)	Antenna Height (cm)	Table Angle (Degree)	Remark
*5559.85	53.54	44.57	68.2	-14.66	34.45	8.59	34.07	100	202	Peak
5660.65	53.77	44.68	76.08	-22.31	34.56	8.63	34.1	100	202	Peak
5921.05	51.55	42.17	71.12	-19.57	34.81	8.73	34.16	100	202	Peak
*6018.7	53.54	44.03	68.2	-14.66	34.92	8.77	34.18	100	202	Peak
Antenna Polarity & Test Distance: Vertical at 3 m										
Frequency (MHz)	Emission Level (dBuV/m)	Read Level (dBuV)	Limit (dBuV/m)	Margin (dB)	Antenna Factor (dB/m)	Cable Loss (dB)	Preamp Factor (dB)	Antenna Height (cm)	Table Angle (Degree)	Remark
*5553.55	53.57	44.6	68.2	-14.63	34.45	8.59	34.07	166	5	Peak
5655.925	52.22	43.13	72.58	-20.36	34.56	8.63	34.1	166	5	Peak
5921.05	52.88	43.5	71.12	-18.24	34.81	8.73	34.16	166	5	Peak
*5961.475	53.8	44.36	68.2	-14.4	34.87	8.74	34.17	166	5	Peak

Remarks:

- Emission Level = Read Level + Antenna Factor + Cable Loss - Preamp Factor
Margin value = Emission level – Limit value
- 5785 MHz: Fundamental Frequency
- *: Out of Restricted Band
- The emission levels of other frequencies were very low against the limit

EUT Test Condition		Measurement Detail	
Channel	Channel 165	Frequency Range	1 GHz ~ 40 GHz
Input Power	120 Vac, 60 Hz	Detector Function	Peak (PK) Average (AV)
Environmental Conditions	25 deg. C, 65 % RH	Tested By	Charles Hsiao

<Spurious Emission>

Antenna Polarity & Test Distance: Horizontal at 3 m										
Frequency (MHz)	Emission Level (dBuV/m)	Read Level (dBuV)	Limit (dBuV/m)	Margin (dB)	Antenna Factor (dB/m)	Cable Loss (dB)	Preamp Factor (dB)	Antenna Height (cm)	Table Angle (Degree)	Remark
5825	95.77	86.48			34.73	8.69	34.13	100	202	Average
5825	102.91	93.62			34.73	8.69	34.13	100	202	Peak
11650	48.27	32.74	54	-5.73	38.09	12.8	35.36	141	27	Average
11650	56.62	41.09	74	-17.38	38.09	12.8	35.36	141	27	Peak
Antenna Polarity & Test Distance: Vertical at 3 m										
Frequency (MHz)	Emission Level (dBuV/m)	Read Level (dBuV)	Limit (dBuV/m)	Margin (dB)	Antenna Factor (dB/m)	Cable Loss (dB)	Preamp Factor (dB)	Antenna Height (cm)	Table Angle (Degree)	Remark
5825	91	81.71			34.73	8.69	34.13	166	5	Average
5825	98.06	88.77			34.73	8.69	34.13	166	5	Peak
11650	48.36	32.83	54	-5.64	38.09	12.8	35.36	138	334	Average
11650	56.9	41.37	74	-17.1	38.09	12.8	35.36	138	334	Peak

<Out of Band Emission (OOBE)>

Antenna Polarity & Test Distance: Horizontal at 3 m										
Frequency (MHz)	Emission Level (dBuV/m)	Read Level (dBuV)	Limit (dBuV/m)	Margin (dB)	Antenna Factor (dB/m)	Cable Loss (dB)	Preamp Factor (dB)	Antenna Height (cm)	Table Angle (Degree)	Remark
*5620.225	53.95	44.9	68.2	-14.25	34.52	8.61	34.08	100	202	Peak
5660.65	53.04	43.95	76.08	-23.04	34.56	8.63	34.1	100	202	Peak
5920.525	51.84	42.46	71.51	-19.67	34.81	8.73	34.16	100	202	Peak
*5978.275	53.49	44.03	68.2	-14.71	34.88	8.75	34.17	100	202	Peak
Antenna Polarity & Test Distance: Vertical at 3 m										
Frequency (MHz)	Emission Level (dBuV/m)	Read Level (dBuV)	Limit (dBuV/m)	Margin (dB)	Antenna Factor (dB/m)	Cable Loss (dB)	Preamp Factor (dB)	Antenna Height (cm)	Table Angle (Degree)	Remark
*5531.5	53.44	44.5	68.2	-14.76	34.43	8.58	34.07	166	5	Peak
5655.925	53.12	44.03	72.58	-19.46	34.56	8.63	34.1	166	5	Peak
5923.15	53.25	43.85	69.57	-16.32	34.83	8.73	34.16	166	5	Peak
*6017.125	53.45	43.94	68.2	-14.75	34.92	8.77	34.18	166	5	Peak

Remarks:

- Emission Level = Read Level + Antenna Factor + Cable Loss - Preamp Factor
Margin value = Emission level – Limit value
- 5825 MHz: Fundamental Frequency
- *: Out of Restricted Band
- The emission levels of other frequencies were very low against the limit

802.11n (HT20)

EUT Test Condition		Measurement Detail	
Channel	Channel 36	Frequency Range	1 GHz ~ 40 GHz
Input Power	120 Vac, 60 Hz	Detector Function	Peak (PK) Average (AV)
Environmental Conditions	25 deg. C, 65 % RH	Tested By	Charles Hsiao

Antenna Polarity & Test Distance: Horizontal at 3 m

Frequency (MHz)	Emission Level (dBuV/m)	Read Level (dBuV)	Limit (dBuV/m)	Margin (dB)	Antenna Factor (dB/m)	Cable Loss (dB)	Preamp Factor (dB)	Antenna Height (cm)	Table Angle (Degree)	Remark
5128.4	43.98	35.76	54	-10.02	34.11	8.1	33.99	234	330	Average
5128.4	54.11	45.89	74	-19.89	34.11	8.1	33.99	234	330	Peak
5180	93.33	85.02			34.15	8.16	34	234	330	Average
5180	100.24	91.93			34.15	8.16	34	234	330	Peak
*10360	55.78	41.48	68.2	-12.42	37.12	12.3	35.12	105	104	Peak

Antenna Polarity & Test Distance: Vertical at 3 m

Frequency (MHz)	Emission Level (dBuV/m)	Read Level (dBuV)	Limit (dBuV/m)	Margin (dB)	Antenna Factor (dB/m)	Cable Loss (dB)	Preamp Factor (dB)	Antenna Height (cm)	Table Angle (Degree)	Remark
5128.7	43	34.78	54	-11	34.11	8.1	33.99	101	178	Average
5128.7	53.4	45.18	74	-20.6	34.11	8.1	33.99	101	178	Peak
5180	90.55	82.24			34.15	8.16	34	101	178	Average
5180	97.71	89.4			34.15	8.16	34	101	178	Peak
*10360	55.44	41.14	68.2	-12.76	37.12	12.3	35.12	112	300	Peak

Remarks:

- Emission Level = Read Level + Antenna Factor + Cable Loss - Preamp Factor
Margin value = Emission level – Limit value
- 5180 MHz: Fundamental Frequency
- *: Out of Restricted Band
- The emission levels of other frequencies were very low against the limit

EUT Test Condition		Measurement Detail	
Channel	Channel 40	Frequency Range	1 GHz ~ 40 GHz
Input Power	120 Vac, 60 Hz	Detector Function	Peak (PK) Average (AV)
Environmental Conditions	25 deg. C, 65 % RH	Tested By	Charles Hsiao

Antenna Polarity & Test Distance: Horizontal at 3 m										
Frequency (MHz)	Emission Level (dBuV/m)	Read Level (dBuV)	Limit (dBuV/m)	Margin (dB)	Antenna Factor (dB/m)	Cable Loss (dB)	Preamp Factor (dB)	Antenna Height (cm)	Table Angle (Degree)	Remark
5129.45	42.52	34.3	54	-11.48	34.11	8.1	33.99	234	330	Average
5129.45	53.33	45.11	74	-20.67	34.11	8.1	33.99	234	330	Peak
5200	93.47	85.12			34.16	8.19	34	234	330	Average
5200	100.22	91.87			34.16	8.19	34	234	330	Peak
5443.17	42.75	33.96	54	-11.25	34.35	8.48	34.04	234	330	Average
5443.17	54.46	45.67	74	-19.54	34.35	8.48	34.04	234	330	Peak
10400	55	40.66	74	-19	37.14	12.36	35.16	175	295	Peak
Antenna Polarity & Test Distance: Vertical at 3 m										
Frequency (MHz)	Emission Level (dBuV/m)	Read Level (dBuV)	Limit (dBuV/m)	Margin (dB)	Antenna Factor (dB/m)	Cable Loss (dB)	Preamp Factor (dB)	Antenna Height (cm)	Table Angle (Degree)	Remark
5139.2	42.62	34.37	54	-11.38	34.11	8.13	33.99	101	178	Average
5139.2	53.3	45.05	74	-20.7	34.11	8.13	33.99	101	178	Peak
5200	90.47	82.12			34.16	8.19	34	101	178	Average
5200	97.19	88.84			34.16	8.19	34	101	178	Peak
5437.67	42.69	33.9	54	-11.31	34.35	8.48	34.04	101	178	Average
5437.67	53.43	44.64	74	-20.57	34.35	8.48	34.04	101	178	Peak
10400	54.88	40.54	74	-19.12	37.14	12.36	35.16	116	245	Peak

Remarks:

- Emission Level = Read Level + Antenna Factor + Cable Loss - Preamp Factor
Margin value = Emission level – Limit value
- 5200 MHz: Fundamental Frequency
- *: Out of Restricted Band
- The emission levels of other frequencies were very low against the limit

EUT Test Condition		Measurement Detail	
Channel	Channel 48	Frequency Range	1 GHz ~ 40 GHz
Input Power	120 Vac, 60 Hz	Detector Function	Peak (PK) Average (AV)
Environmental Conditions	25 deg. C, 65 % RH	Tested By	Charles Hsiao

Antenna Polarity & Test Distance: Horizontal at 3 m										
Frequency (MHz)	Emission Level (dBuV/m)	Read Level (dBuV)	Limit (dBuV/m)	Margin (dB)	Antenna Factor (dB/m)	Cable Loss (dB)	Preamp Factor (dB)	Antenna Height (cm)	Table Angle (Degree)	Remark
5240	93.88	85.44			34.19	8.26	34.01	234	330	Average
5240	100.82	92.38			34.19	8.26	34.01	234	330	Peak
5441.19	42.78	33.99	54	-11.22	34.35	8.48	34.04	234	330	Average
5441.19	53.53	44.74	74	-20.47	34.35	8.48	34.04	234	330	Peak
*10480	56.63	42.12	68.2	-11.57	37.19	12.53	35.21	119	211	Peak

Antenna Polarity & Test Distance: Vertical at 3 m										
Frequency (MHz)	Emission Level (dBuV/m)	Read Level (dBuV)	Limit (dBuV/m)	Margin (dB)	Antenna Factor (dB/m)	Cable Loss (dB)	Preamp Factor (dB)	Antenna Height (cm)	Table Angle (Degree)	Remark
5240	90.63	82.19			34.19	8.26	34.01	101	178	Average
5240	97.67	89.23			34.19	8.26	34.01	101	178	Peak
5459.89	42.73	33.91	54	-11.27	34.36	8.51	34.05	101	178	Average
5459.89	53.67	44.85	74	-20.33	34.36	8.51	34.05	101	178	Peak
*10480	56.22	41.71	68.2	-11.98	37.19	12.53	35.21	119	346	Peak

Remarks:

- Emission Level = Read Level + Antenna Factor + Cable Loss - Preamp Factor
Margin value = Emission level – Limit value
- 5240 MHz: Fundamental Frequency
- *: Out of Restricted Band
- The emission levels of other frequencies were very low against the limit

EUT Test Condition		Measurement Detail	
Channel	Channel 52	Frequency Range	1 GHz ~ 40 GHz
Input Power	120 Vac, 60 Hz	Detector Function	Peak (PK) Average (AV)
Environmental Conditions	25 deg. C, 65 % RH	Tested By	Charles Hsiao

Antenna Polarity & Test Distance: Horizontal at 3 m										
Frequency (MHz)	Emission Level (dBuV/m)	Read Level (dBuV)	Limit (dBuV/m)	Margin (dB)	Antenna Factor (dB/m)	Cable Loss (dB)	Preamp Factor (dB)	Antenna Height (cm)	Table Angle (Degree)	Remark
5136.05	42.58	34.33	54	-11.42	34.11	8.13	33.99	200	118	Average
5136.05	53.63	45.38	74	-20.37	34.11	8.13	33.99	200	118	Peak
5260	93.55	85.09			34.21	8.26	34.01	200	118	Average
5260	101.25	92.79			34.21	8.26	34.01	200	118	Peak
*10520	56.26	41.67	68.2	-11.94	37.21	12.61	35.23	162	33	Peak

Antenna Polarity & Test Distance: Vertical at 3 m										
Frequency (MHz)	Emission Level (dBuV/m)	Read Level (dBuV)	Limit (dBuV/m)	Margin (dB)	Antenna Factor (dB/m)	Cable Loss (dB)	Preamp Factor (dB)	Antenna Height (cm)	Table Angle (Degree)	Remark
5112.65	42.59	34.39	54	-11.41	34.09	8.1	33.99	274	208	Average
5112.65	53.89	45.69	74	-20.11	34.09	8.1	33.99	274	208	Peak
5260	90.12	81.66			34.21	8.26	34.01	274	208	Average
5260	97.97	89.51			34.21	8.26	34.01	274	208	Peak
*10520	56.39	41.8	68.2	-11.81	37.21	12.61	35.23	112	157	Peak

Remarks:

- Emission Level = Read Level + Antenna Factor + Cable Loss - Preamp Factor
Margin value = Emission level – Limit value
- 5260 MHz: Fundamental Frequency
- *: Out of Restricted Band
- The emission levels of other frequencies were very low against the limit

EUT Test Condition		Measurement Detail	
Channel	Channel 60	Frequency Range	1 GHz ~ 40 GHz
Input Power	120 Vac, 60 Hz	Detector Function	Peak (PK) Average (AV)
Environmental Conditions	25 deg. C, 65 % RH	Tested By	Charles Hsiao

Antenna Polarity & Test Distance: Horizontal at 3 m										
Frequency (MHz)	Emission Level (dBuV/m)	Read Level (dBuV)	Limit (dBuV/m)	Margin (dB)	Antenna Factor (dB/m)	Cable Loss (dB)	Preamp Factor (dB)	Antenna Height (cm)	Table Angle (Degree)	Remark
5121.8	42.62	34.42	54	-11.38	34.09	8.1	33.99	200	118	Average
5121.8	53.09	44.89	74	-20.91	34.09	8.1	33.99	200	118	Peak
5300	94.19	85.65			34.24	8.32	34.02	200	118	Average
5300	101.5	92.96			34.24	8.32	34.02	200	118	Peak
5351.76	44.21	35.58	54	-9.79	34.28	8.38	34.03	200	118	Average
5351.76	53.48	44.85	74	-20.52	34.28	8.38	34.03	200	118	Peak
10600	45.77	31.09	54	-8.23	37.28	12.67	35.27	108	219	Average
10600	55.89	41.21	74	-18.11	37.28	12.67	35.27	108	219	Peak
Antenna Polarity & Test Distance: Vertical at 3 m										
Frequency (MHz)	Emission Level (dBuV/m)	Read Level (dBuV)	Limit (dBuV/m)	Margin (dB)	Antenna Factor (dB/m)	Cable Loss (dB)	Preamp Factor (dB)	Antenna Height (cm)	Table Angle (Degree)	Remark
5058.5	42.57	34.47	54	-11.43	34.05	8.03	33.98	274	208	Average
5058.5	53.1	45	74	-20.9	34.05	8.03	33.98	274	208	Peak
5300	91.39	82.85			34.24	8.32	34.02	274	208	Average
5300	98.87	90.33			34.24	8.32	34.02	274	208	Peak
5351.76	43.06	34.43	54	-10.94	34.28	8.38	34.03	274	208	Average
5351.76	53.35	44.72	74	-20.65	34.28	8.38	34.03	274	208	Peak
10600	45.61	30.93	54	-8.39	37.28	12.67	35.27	152	169	Average
10600	55.33	40.65	74	-18.67	37.28	12.67	35.27	152	169	Peak

Remarks:

- Emission Level = Read Level + Antenna Factor + Cable Loss - Preamp Factor
Margin value = Emission level – Limit value
- 5300 MHz: Fundamental Frequency
- *: Out of Restricted Band
- The emission levels of other frequencies were very low against the limit

EUT Test Condition		Measurement Detail	
Channel	Channel 64	Frequency Range	1 GHz ~ 40 GHz
Input Power	120 Vac, 60 Hz	Detector Function	Peak (PK) Average (AV)
Environmental Conditions	25 deg. C, 65 % RH	Tested By	Charles Hsiao

Antenna Polarity & Test Distance: Horizontal at 3 m										
Frequency (MHz)	Emission Level (dBuV/m)	Read Level (dBuV)	Limit (dBuV/m)	Margin (dB)	Antenna Factor (dB/m)	Cable Loss (dB)	Preamp Factor (dB)	Antenna Height (cm)	Table Angle (Degree)	Remark
5320	93.86	85.28			34.25	8.35	34.02	200	118	Average
5320	101.93	93.35			34.25	8.35	34.02	200	118	Peak
5371.89	44.03	35.36	54	-9.97	34.29	8.41	34.03	200	118	Average
5371.89	54.28	45.61	74	-19.72	34.29	8.41	34.03	200	118	Peak
10640	46.05	31.32	54	-7.95	37.31	12.71	35.29	139	335	Average
10640	55.99	41.26	74	-18.01	37.31	12.71	35.29	139	335	Peak

Antenna Polarity & Test Distance: Vertical at 3 m										
Frequency (MHz)	Emission Level (dBuV/m)	Read Level (dBuV)	Limit (dBuV/m)	Margin (dB)	Antenna Factor (dB/m)	Cable Loss (dB)	Preamp Factor (dB)	Antenna Height (cm)	Table Angle (Degree)	Remark
5320	91.32	82.74			34.25	8.35	34.02	274	208	Average
5320	99.02	90.44			34.25	8.35	34.02	274	208	Peak
5371.67	43.2	34.53	54	-10.8	34.29	8.41	34.03	274	208	Average
5371.67	53.31	44.64	74	-20.69	34.29	8.41	34.03	274	208	Peak
10640	46.27	31.54	54	-7.73	37.31	12.71	35.29	132	118	Average
10640	56.5	41.77	74	-17.5	37.31	12.71	35.29	132	118	Peak

Remarks:

- Emission Level = Read Level + Antenna Factor + Cable Loss - Preamp Factor
Margin value = Emission level – Limit value
- 5320 MHz: Fundamental Frequency
- *: Out of Restricted Band
- The emission levels of other frequencies were very low against the limit

EUT Test Condition		Measurement Detail	
Channel	Channel 100	Frequency Range	1 GHz ~ 40 GHz
Input Power	120 Vac, 60 Hz	Detector Function	Peak (PK) Average (AV)
Environmental Conditions	25 deg. C, 65 % RH	Tested By	Charles Hsiao

Antenna Polarity & Test Distance: Horizontal at 3 m										
Frequency (MHz)	Emission Level (dBuV/m)	Read Level (dBuV)	Limit (dBuV/m)	Margin (dB)	Antenna Factor (dB/m)	Cable Loss (dB)	Preamp Factor (dB)	Antenna Height (cm)	Table Angle (Degree)	Remark
5449.04	45.13	36.3	54	-8.87	34.36	8.51	34.04	213	63	Average
5449.04	53.69	44.86	74	-20.31	34.36	8.51	34.04	213	63	Peak
*5468.4	53.71	44.88	68.2	-14.49	34.37	8.51	34.05	213	63	Peak
5500	96.16	87.24			34.4	8.57	34.05	213	63	Average
5500	103.11	94.19			34.4	8.57	34.05	213	63	Peak
11000	47.21	32.13	54	-6.79	37.6	12.96	35.48	163	340	Average
11000	57.05	41.97	74	-16.95	37.6	12.96	35.48	163	340	Peak
Antenna Polarity & Test Distance: Vertical at 3 m										
Frequency (MHz)	Emission Level (dBuV/m)	Read Level (dBuV)	Limit (dBuV/m)	Margin (dB)	Antenna Factor (dB/m)	Cable Loss (dB)	Preamp Factor (dB)	Antenna Height (cm)	Table Angle (Degree)	Remark
5448.72	43.88	35.05	54	-10.12	34.36	8.51	34.04	201	182	Average
5448.72	53.71	44.88	74	-20.29	34.36	8.51	34.04	201	182	Peak
*5470.64	52.49	43.66	68.2	-15.71	34.37	8.51	34.05	201	182	Peak
5500	93.46	84.54			34.4	8.57	34.05	201	182	Average
5500	100.95	92.03			34.4	8.57	34.05	201	182	Peak
11000	46.83	31.75	54	-7.17	37.6	12.96	35.48	136	211	Average
11000	56.8	41.72	74	-17.2	37.6	12.96	35.48	136	211	Peak

Remarks:

- Emission Level = Read Level + Antenna Factor + Cable Loss - Preamp Factor
Margin value = Emission level – Limit value
- 5500 MHz: Fundamental Frequency
- *: Out of Restricted Band
- The emission levels of other frequencies were very low against the limit

EUT Test Condition		Measurement Detail	
Channel	Channel 116	Frequency Range	1 GHz ~ 40 GHz
Input Power	120 Vac, 60 Hz	Detector Function	Peak (PK) Average (AV)
Environmental Conditions	25 deg. C, 65 % RH	Tested By	Charles Hsiao

Antenna Polarity & Test Distance: Horizontal at 3 m										
Frequency (MHz)	Emission Level (dBuV/m)	Read Level (dBuV)	Limit (dBuV/m)	Margin (dB)	Antenna Factor (dB/m)	Cable Loss (dB)	Preamp Factor (dB)	Antenna Height (cm)	Table Angle (Degree)	Remark
5447.92	42.75	33.92	54	-11.25	34.36	8.51	34.04	215	65	Average
5447.92	53.21	44.38	74	-20.79	34.36	8.51	34.04	215	65	Peak
*5468.4	51.43	42.6	68.2	-16.77	34.37	8.51	34.05	215	65	Peak
5580	95.83	86.84			34.47	8.6	34.08	215	65	Average
5580	103.94	94.95			34.47	8.6	34.08	215	65	Peak
*5725.24	52.67	43.51	68.2	-15.53	34.62	8.65	34.11	215	65	Peak
11160	47.74	32.66	54	-6.26	37.7	12.83	35.45	168	232	Average
11160	57.71	42.63	74	-16.29	37.7	12.83	35.45	168	232	Peak

Antenna Polarity & Test Distance: Vertical at 3 m										
Frequency (MHz)	Emission Level (dBuV/m)	Read Level (dBuV)	Limit (dBuV/m)	Margin (dB)	Antenna Factor (dB/m)	Cable Loss (dB)	Preamp Factor (dB)	Antenna Height (cm)	Table Angle (Degree)	Remark
5458.16	42.71	33.89	54	-11.29	34.36	8.51	34.05	201	182	Average
5458.16	53.4	44.58	74	-20.6	34.36	8.51	34.05	201	182	Peak
*5469.52	53.66	44.83	68.2	-14.54	34.37	8.51	34.05	201	182	Peak
5580	93.06	84.07			34.47	8.6	34.08	201	182	Average
5580	100.04	91.05			34.47	8.6	34.08	201	182	Peak
*5725.8	51.83	42.67	68.2	-16.37	34.62	8.65	34.11	201	182	Peak
11160	46.58	31.5	54	-7.42	37.7	12.83	35.45	121	180	Average
11160	56.7	41.62	74	-17.3	37.7	12.83	35.45	121	180	Peak

Remarks:

- Emission Level = Read Level + Antenna Factor + Cable Loss - Preamp Factor
Margin value = Emission level – Limit value
- 5580 MHz: Fundamental Frequency
- *: Out of Restricted Band
- The emission levels of other frequencies were very low against the limit

EUT Test Condition		Measurement Detail	
Channel	Channel 140	Frequency Range	1 GHz ~ 40 GHz
Input Power	120 Vac, 60 Hz	Detector Function	Peak (PK) Average (AV)
Environmental Conditions	25 deg. C, 65 % RH	Tested By	Charles Hsiao

Antenna Polarity & Test Distance: Horizontal at 3 m										
Frequency (MHz)	Emission Level (dBuV/m)	Read Level (dBuV)	Limit (dBuV/m)	Margin (dB)	Antenna Factor (dB/m)	Cable Loss (dB)	Preamp Factor (dB)	Antenna Height (cm)	Table Angle (Degree)	Remark
5700	96.88	87.75			34.59	8.64	34.1	159	65	Average
5700	103.13	94			34.59	8.64	34.1	159	65	Peak
5725.48	54.15	44.99	68.2	-14.05	34.62	8.65	34.11	159	65	Peak
11400	46.92	31.82	54	-7.08	37.84	12.67	35.41	186	274	Average
11400	56.86	41.76	74	-17.14	37.84	12.67	35.41	186	274	Peak

Antenna Polarity & Test Distance: Vertical at 3 m										
Frequency (MHz)	Emission Level (dBuV/m)	Read Level (dBuV)	Limit (dBuV/m)	Margin (dB)	Antenna Factor (dB/m)	Cable Loss (dB)	Preamp Factor (dB)	Antenna Height (cm)	Table Angle (Degree)	Remark
5700	93.58	84.45			34.59	8.64	34.1	252	182	Average
5700	100.99	91.86			34.59	8.64	34.1	252	182	Peak
5725.32	54.75	45.59	68.2	-13.45	34.62	8.65	34.11	252	182	Peak
11400	46.5	31.4	54	-7.5	37.84	12.67	35.41	118	61	Average
11400	56.45	41.35	74	-17.55	37.84	12.67	35.41	118	61	Peak

Remarks:

- Emission Level = Read Level + Antenna Factor + Cable Loss - Preamp Factor
Margin value = Emission level – Limit value
- 5700 MHz: Fundamental Frequency
- *: Out of Restricted Band
- The emission levels of other frequencies were very low against the limit

EUT Test Condition		Measurement Detail	
Channel	Channel 144	Frequency Range	1 GHz ~ 40 GHz
Input Power	120 Vac, 60 Hz	Detector Function	Peak (PK) Average (AV)
Environmental Conditions	25 deg. C, 65 % RH	Tested By	Charles Hsiao

Antenna Polarity & Test Distance: Horizontal at 3 m										
Frequency (MHz)	Emission Level (dBuV/m)	Read Level (dBuV)	Limit (dBuV/m)	Margin (dB)	Antenna Factor (dB/m)	Cable Loss (dB)	Preamp Factor (dB)	Antenna Height (cm)	Table Angle (Degree)	Remark
5450.96	42.72	33.9	54	-11.28	34.36	8.51	34.05	159	65	Average
5450.96	53.57	44.75	74	-20.43	34.36	8.51	34.05	159	65	Peak
*5468.88	52.36	43.53	68.2	-15.84	34.37	8.51	34.05	159	65	Peak
5720	95.7	86.54			34.62	8.65	34.11	159	65	Average
5720	103.73	94.57			34.62	8.65	34.11	159	65	Peak
11440	46.27	31.16	54	-7.73	37.86	12.65	35.4	133	281	Average
11440	56.2	41.09	74	-17.8	37.86	12.65	35.4	133	281	Peak
Antenna Polarity & Test Distance: Vertical at 3 m										
Frequency (MHz)	Emission Level (dBuV/m)	Read Level (dBuV)	Limit (dBuV/m)	Margin (dB)	Antenna Factor (dB/m)	Cable Loss (dB)	Preamp Factor (dB)	Antenna Height (cm)	Table Angle (Degree)	Remark
5438	42.71	33.92	54	-11.29	34.35	8.48	34.04	252	188	Average
5438	52.9	44.11	74	-21.1	34.35	8.48	34.04	252	188	Peak
*5468.56	52.4	43.57	68.2	-15.8	34.37	8.51	34.05	252	188	Peak
5720	93.02	83.86			34.62	8.65	34.11	252	188	Average
5720	101.08	91.92			34.62	8.65	34.11	252	188	Peak
11440	46.93	31.82	54	-7.07	37.86	12.65	35.4	156	112	Average
11440	57.1	41.99	74	-16.9	37.86	12.65	35.4	156	112	Peak

Remarks:

- Emission Level = Read Level + Antenna Factor + Cable Loss - Preamp Factor
Margin value = Emission level – Limit value
- 5720 MHz: Fundamental Frequency
- *: Out of Restricted Band
- The emission levels of other frequencies were very low against the limit

EUT Test Condition		Measurement Detail	
Channel	Channel 149	Frequency Range	1 GHz ~ 40 GHz
Input Power	120 Vac, 60 Hz	Detector Function	Peak (PK) Average (AV)
Environmental Conditions	25 deg. C, 65 % RH	Tested By	Charles Hsiao

<Spurious Emission>

Antenna Polarity & Test Distance: Horizontal at 3 m										
Frequency (MHz)	Emission Level (dBuV/m)	Read Level (dBuV)	Limit (dBuV/m)	Margin (dB)	Antenna Factor (dB/m)	Cable Loss (dB)	Preamp Factor (dB)	Antenna Height (cm)	Table Angle (Degree)	Remark
5745	95.62	86.43			34.64	8.66	34.11	100	202	Average
5745	102.34	93.15			34.64	8.66	34.11	100	202	Peak
11490	47.81	32.69	54	-6.19	37.89	12.62	35.39	105	104	Average
11490	57.05	41.93	74	-16.95	37.89	12.62	35.39	105	104	Peak
Antenna Polarity & Test Distance: Vertical at 3 m										
Frequency (MHz)	Emission Level (dBuV/m)	Read Level (dBuV)	Limit (dBuV/m)	Margin (dB)	Antenna Factor (dB/m)	Cable Loss (dB)	Preamp Factor (dB)	Antenna Height (cm)	Table Angle (Degree)	Remark
5745	91.46	82.27			34.64	8.66	34.11	166	5	Average
5745	98.68	89.49			34.64	8.66	34.11	166	5	Peak
11490	47.86	32.74	54	-6.14	37.89	12.62	35.39	148	157	Average
11490	56.31	41.19	74	-17.69	37.89	12.62	35.39	148	157	Peak

<Out of Band Emission (OOBE)>

Antenna Polarity & Test Distance: Horizontal at 3 m										
Frequency (MHz)	Emission Level (dBuV/m)	Read Level (dBuV)	Limit (dBuV/m)	Margin (dB)	Antenna Factor (dB/m)	Cable Loss (dB)	Preamp Factor (dB)	Antenna Height (cm)	Table Angle (Degree)	Remark
*5648.575	54.2	45.13	68.2	-14	34.54	8.62	34.09	100	202	Peak
5654.875	52.73	43.64	71.81	-19.08	34.56	8.63	34.1	100	202	Peak
5918.95	51.66	42.28	72.68	-21.02	34.81	8.73	34.16	100	202	Peak
*5967.775	53.34	43.89	68.2	-14.86	34.87	8.75	34.17	100	202	Peak
Antenna Polarity & Test Distance: Vertical at 3 m										
Frequency (MHz)	Emission Level (dBuV/m)	Read Level (dBuV)	Limit (dBuV/m)	Margin (dB)	Antenna Factor (dB/m)	Cable Loss (dB)	Preamp Factor (dB)	Antenna Height (cm)	Table Angle (Degree)	Remark
*5577.7	52.86	43.87	68.2	-15.34	34.47	8.6	34.08	166	5	Peak
5654.875	52.1	43.01	71.81	-19.71	34.56	8.63	34.1	166	5	Peak
5918.425	53.36	43.98	73.07	-19.71	34.81	8.73	34.16	166	5	Peak
*5964.625	53.11	43.66	68.2	-15.09	34.87	8.75	34.17	166	5	Peak

Remarks:

- Emission Level = Read Level + Antenna Factor + Cable Loss - Preamp Factor
Margin value = Emission level – Limit value
- 5745 MHz: Fundamental Frequency
- *: Out of Restricted Band
- The emission levels of other frequencies were very low against the limit

EUT Test Condition		Measurement Detail	
Channel	Channel 157	Frequency Range	1 GHz ~ 40 GHz
Input Power	120 Vac, 60 Hz	Detector Function	Peak (PK) Average (AV)
Environmental Conditions	25 deg. C, 65 % RH	Tested By	Charles Hsiao

<Spurious Emission>

Antenna Polarity & Test Distance: Horizontal at 3 m										
Frequency (MHz)	Emission Level (dBuV/m)	Read Level (dBuV)	Limit (dBuV/m)	Margin (dB)	Antenna Factor (dB/m)	Cable Loss (dB)	Preamp Factor (dB)	Antenna Height (cm)	Table Angle (Degree)	Remark
5785	95.46	86.23			34.68	8.68	34.13	100	202	Average
5785	102.11	92.88			34.68	8.68	34.13	100	202	Peak
11570	47.98	32.67	54	-6.02	38	12.68	35.37	146	1	Average
11570	57.1	41.79	74	-16.9	38	12.68	35.37	146	1	Peak
Antenna Polarity & Test Distance: Vertical at 3 m										
Frequency (MHz)	Emission Level (dBuV/m)	Read Level (dBuV)	Limit (dBuV/m)	Margin (dB)	Antenna Factor (dB/m)	Cable Loss (dB)	Preamp Factor (dB)	Antenna Height (cm)	Table Angle (Degree)	Remark
5785	91.49	82.26			34.68	8.68	34.13	166	5	Average
5785	98.93	89.7			34.68	8.68	34.13	166	5	Peak
11570	48.04	32.73	54	-5.96	38	12.68	35.37	142	344	Average
11570	56.68	41.37	74	-17.32	38	12.68	35.37	142	344	Peak

<Out of Band Emission (OOBE)>

Antenna Polarity & Test Distance: Horizontal at 3 m										
Frequency (MHz)	Emission Level (dBuV/m)	Read Level (dBuV)	Limit (dBuV/m)	Margin (dB)	Antenna Factor (dB/m)	Cable Loss (dB)	Preamp Factor (dB)	Antenna Height (cm)	Table Angle (Degree)	Remark
*5563	53.11	44.14	68.2	-15.09	34.45	8.59	34.07	100	202	Peak
5653.3	51.11	42.01	70.64	-19.53	34.56	8.63	34.09	100	202	Peak
5923.675	54.31	44.91	69.18	-14.87	34.83	8.73	34.16	100	202	Peak
*5942.575	53.89	44.46	68.2	-14.31	34.85	8.74	34.16	100	202	Peak
Antenna Polarity & Test Distance: Vertical at 3 m										
Frequency (MHz)	Emission Level (dBuV/m)	Read Level (dBuV)	Limit (dBuV/m)	Margin (dB)	Antenna Factor (dB/m)	Cable Loss (dB)	Preamp Factor (dB)	Antenna Height (cm)	Table Angle (Degree)	Remark
*5604.475	53.3	44.27	68.2	-14.9	34.5	8.61	34.08	166	5	Peak
5653.3	52.33	43.23	70.64	-18.31	34.56	8.63	34.09	166	5	Peak
5916.85	53.58	44.2	74.23	-20.65	34.81	8.73	34.16	166	5	Peak
*6009.25	54.41	44.9	68.2	-13.79	34.92	8.76	34.17	166	5	Peak

Remarks:

- Emission Level = Read Level + Antenna Factor + Cable Loss - Preamp Factor
Margin value = Emission level – Limit value
- 5785 MHz: Fundamental Frequency
- *: Out of Restricted Band
- The emission levels of other frequencies were very low against the limit

EUT Test Condition		Measurement Detail	
Channel	Channel 165	Frequency Range	1 GHz ~ 40 GHz
Input Power	120 Vac, 60 Hz	Detector Function	Peak (PK) Average (AV)
Environmental Conditions	25 deg. C, 65 % RH	Tested By	Charles Hsiao

<Spurious Emission>

Antenna Polarity & Test Distance: Horizontal at 3 m										
Frequency (MHz)	Emission Level (dBuV/m)	Read Level (dBuV)	Limit (dBuV/m)	Margin (dB)	Antenna Factor (dB/m)	Cable Loss (dB)	Preamp Factor (dB)	Antenna Height (cm)	Table Angle (Degree)	Remark
5825	95.47	86.18			34.73	8.69	34.13	100	202	Average
5825	102.38	93.09			34.73	8.69	34.13	100	202	Peak
11650	48.42	32.89	54	-5.58	38.09	12.8	35.36	105	195	Average
11650	56.67	41.14	74	-17.33	38.09	12.8	35.36	105	195	Peak
Antenna Polarity & Test Distance: Vertical at 3 m										
Frequency (MHz)	Emission Level (dBuV/m)	Read Level (dBuV)	Limit (dBuV/m)	Margin (dB)	Antenna Factor (dB/m)	Cable Loss (dB)	Preamp Factor (dB)	Antenna Height (cm)	Table Angle (Degree)	Remark
5825	91.36	82.07			34.73	8.69	34.13	166	5	Average
5825	98.03	88.74			34.73	8.69	34.13	166	5	Peak
11650	48.38	32.85	54	-5.62	38.09	12.8	35.36	137	249	Average
11650	56.17	40.64	74	-17.83	38.09	12.8	35.36	137	249	Peak

<Out of Band Emission (OOBE)>

Antenna Polarity & Test Distance: Horizontal at 3 m										
Frequency (MHz)	Emission Level (dBuV/m)	Read Level (dBuV)	Limit (dBuV/m)	Margin (dB)	Antenna Factor (dB/m)	Cable Loss (dB)	Preamp Factor (dB)	Antenna Height (cm)	Table Angle (Degree)	Remark
*5586.1	54.07	45.06	68.2	-14.13	34.49	8.6	34.08	100	202	Peak
5654.35	52.17	43.08	71.42	-19.25	34.56	8.63	34.1	100	202	Peak
5918.95	52.4	43.02	72.68	-20.28	34.81	8.73	34.16	100	202	Peak
*5981.95	54.17	44.71	68.2	-14.03	34.88	8.75	34.17	100	202	Peak
Antenna Polarity & Test Distance: Vertical at 3 m										
Frequency (MHz)	Emission Level (dBuV/m)	Read Level (dBuV)	Limit (dBuV/m)	Margin (dB)	Antenna Factor (dB/m)	Cable Loss (dB)	Preamp Factor (dB)	Antenna Height (cm)	Table Angle (Degree)	Remark
*5626.525	53.62	44.57	68.2	-14.58	34.52	8.61	34.08	166	5	Peak
5655.4	51.01	41.92	72.2	-21.19	34.56	8.63	34.1	166	5	Peak
5922.1	52.56	43.16	70.35	-17.79	34.83	8.73	34.16	166	5	Peak
*5965.15	53	43.55	68.2	-15.2	34.87	8.75	34.17	166	5	Peak

Remarks:

- Emission Level = Read Level + Antenna Factor + Cable Loss - Preamp Factor
Margin value = Emission level – Limit value
- 5825 MHz: Fundamental Frequency
- *: Out of Restricted Band
- The emission levels of other frequencies were very low against the limit

802.11n (HT40)

EUT Test Condition		Measurement Detail	
Channel	Channel 38	Frequency Range	1 GHz ~ 40 GHz
Input Power	120 Vac, 60 Hz	Detector Function	Peak (PK) Average (AV)
Environmental Conditions	25 deg. C, 65 % RH	Tested By	Charles Hsiao

Antenna Polarity & Test Distance: Horizontal at 3 m

Frequency (MHz)	Emission Level (dBuV/m)	Read Level (dBuV)	Limit (dBuV/m)	Margin (dB)	Antenna Factor (dB/m)	Cable Loss (dB)	Preamp Factor (dB)	Antenna Height (cm)	Table Angle (Degree)	Remark
5149.25	43.89	35.64	54	-10.11	34.12	8.13	34	234	317	Average
5149.25	53.63	45.38	74	-20.37	34.12	8.13	34	234	317	Peak
5190	91.44	83.1			34.15	8.19	34	234	317	Average
5190	98.35	90.01			34.15	8.19	34	234	317	Peak
5449.33	43.16	34.33	54	-10.84	34.36	8.51	34.04	234	317	Average
5449.33	54.32	45.49	74	-19.68	34.36	8.51	34.04	234	317	Peak
*10380	55.68	41.33	68.2	-12.52	37.13	12.36	35.14	113	245	Peak

Antenna Polarity & Test Distance: Vertical at 3 m

Frequency (MHz)	Emission Level (dBuV/m)	Read Level (dBuV)	Limit (dBuV/m)	Margin (dB)	Antenna Factor (dB/m)	Cable Loss (dB)	Preamp Factor (dB)	Antenna Height (cm)	Table Angle (Degree)	Remark
5148.35	43.16	34.91	54	-10.84	34.12	8.13	34	101	178	Average
5148.35	52.89	44.64	74	-21.11	34.12	8.13	34	101	178	Peak
5190	88.25	79.91			34.15	8.19	34	101	178	Average
5190	95.39	87.05			34.15	8.19	34	101	178	Peak
5439.1	43.42	34.63	54	-10.58	34.35	8.48	34.04	101	178	Average
5439.1	53.68	44.89	74	-20.32	34.35	8.48	34.04	101	178	Peak
*10380	55.78	41.43	68.2	-12.42	37.13	12.36	35.14	134	330	Peak

Remarks:

- Emission Level = Read Level + Antenna Factor + Cable Loss - Preamp Factor
Margin value = Emission level – Limit value
- 5190 MHz: Fundamental Frequency
- *: Out of Restricted Band
- The emission levels of other frequencies were very low against the limit

EUT Test Condition		Measurement Detail	
Channel	Channel 46	Frequency Range	1 GHz ~ 40 GHz
Input Power	120 Vac, 60 Hz	Detector Function	Peak (PK) Average (AV)
Environmental Conditions	25 deg. C, 65 % RH	Tested By	Charles Hsiao

Antenna Polarity & Test Distance: Horizontal at 3 m										
Frequency (MHz)	Emission Level (dBuV/m)	Read Level (dBuV)	Limit (dBuV/m)	Margin (dB)	Antenna Factor (dB/m)	Cable Loss (dB)	Preamp Factor (dB)	Antenna Height (cm)	Table Angle (Degree)	Remark
5127.5	43.26	35.04	54	-10.74	34.11	8.1	33.99	234	317	Average
5127.5	53.31	45.09	74	-20.69	34.11	8.1	33.99	234	317	Peak
5230	91.74	83.34			34.19	8.22	34.01	234	317	Average
5230	98.26	89.86			34.19	8.22	34.01	234	317	Peak
5449.33	43.15	34.32	54	-10.85	34.36	8.51	34.04	234	317	Average
5449.33	53.53	44.7	74	-20.47	34.36	8.51	34.04	234	317	Peak
*10460	55.78	41.27	68.2	-12.42	37.17	12.53	35.19	113	137	Peak

Antenna Polarity & Test Distance: Vertical at 3 m										
Frequency (MHz)	Emission Level (dBuV/m)	Read Level (dBuV)	Limit (dBuV/m)	Margin (dB)	Antenna Factor (dB/m)	Cable Loss (dB)	Preamp Factor (dB)	Antenna Height (cm)	Table Angle (Degree)	Remark
5126.3	43.24	35.02	54	-10.76	34.11	8.1	33.99	101	178	Average
5126.3	52.6	44.38	74	-21.4	34.11	8.1	33.99	101	178	Peak
5230	88.32	79.92			34.19	8.22	34.01	101	178	Average
5230	95.31	86.91			34.19	8.22	34.01	101	178	Peak
5452.74	43.2	34.38	54	-10.8	34.36	8.51	34.05	101	178	Average
5452.74	52.91	44.09	74	-21.09	34.36	8.51	34.05	101	178	Peak
*10460	57.71	43.2	68.2	-10.49	37.17	12.53	35.19	157	188	Peak

Remarks:

- Emission Level = Read Level + Antenna Factor + Cable Loss - Preamp Factor
Margin value = Emission level – Limit value
- 5230 MHz: Fundamental Frequency
- *: Out of Restricted Band
- The emission levels of other frequencies were very low against the limit

EUT Test Condition		Measurement Detail	
Channel	Channel 54	Frequency Range	1 GHz ~ 40 GHz
Input Power	120 Vac, 60 Hz	Detector Function	Peak (PK) Average (AV)
Environmental Conditions	25 deg. C, 65 % RH	Tested By	Charles Hsiao

Antenna Polarity & Test Distance: Horizontal at 3 m										
Frequency (MHz)	Emission Level (dBuV/m)	Read Level (dBuV)	Limit (dBuV/m)	Margin (dB)	Antenna Factor (dB/m)	Cable Loss (dB)	Preamp Factor (dB)	Antenna Height (cm)	Table Angle (Degree)	Remark
5147.9	42.66	34.41	54	-11.34	34.12	8.13	34	194	116	Average
5147.9	53.3	45.05	74	-20.7	34.12	8.13	34	194	116	Peak
5270	91.65	83.16			34.21	8.29	34.01	194	116	Average
5270	99.87	91.38			34.21	8.29	34.01	194	116	Peak
5368.59	42.9	34.23	54	-11.1	34.29	8.41	34.03	194	116	Average
5368.59	53.03	44.36	74	-20.97	34.29	8.41	34.03	194	116	Peak
10540	46.35	31.73	54	-7.65	37.23	12.63	35.24	160	47	Average
10540	56.48	41.86	74	-17.52	37.23	12.63	35.24	160	47	Peak
Antenna Polarity & Test Distance: Vertical at 3 m										
Frequency (MHz)	Emission Level (dBuV/m)	Read Level (dBuV)	Limit (dBuV/m)	Margin (dB)	Antenna Factor (dB/m)	Cable Loss (dB)	Preamp Factor (dB)	Antenna Height (cm)	Table Angle (Degree)	Remark
5124.65	42.6	34.38	54	-11.4	34.11	8.1	33.99	224	208	Average
5124.65	53.25	45.03	74	-20.75	34.11	8.1	33.99	224	208	Peak
5270	89.2	80.71			34.21	8.29	34.01	224	208	Average
5270	96.52	88.03			34.21	8.29	34.01	224	208	Peak
5369.58	42.77	34.1	54	-11.23	34.29	8.41	34.03	224	208	Average
5369.58	54.1	45.43	74	-19.9	34.29	8.41	34.03	224	208	Peak
10540	45.92	31.3	54	-8.08	37.23	12.63	35.24	136	176	Average
10540	55.81	41.19	74	-18.19	37.23	12.63	35.24	136	176	Peak

Remarks:

- Emission Level = Read Level + Antenna Factor + Cable Loss - Preamp Factor
Margin value = Emission level – Limit value
- 5270 MHz: Fundamental Frequency
- *: Out of Restricted Band
- The emission levels of other frequencies were very low against the limit

EUT Test Condition		Measurement Detail	
Channel	Channel 62	Frequency Range	1 GHz ~ 40 GHz
Input Power	120 Vac, 60 Hz	Detector Function	Peak (PK) Average (AV)
Environmental Conditions	25 deg. C, 65 % RH	Tested By	Charles Hsiao

Antenna Polarity & Test Distance: Horizontal at 3 m										
Frequency (MHz)	Emission Level (dBuV/m)	Read Level (dBuV)	Limit (dBuV/m)	Margin (dB)	Antenna Factor (dB/m)	Cable Loss (dB)	Preamp Factor (dB)	Antenna Height (cm)	Table Angle (Degree)	Remark
5131.55	42.7	34.48	54	-11.3	34.11	8.1	33.99	194	116	Average
5131.55	53.23	45.01	74	-20.77	34.11	8.1	33.99	194	116	Peak
5310	91.94	83.39			34.25	8.32	34.02	194	116	Average
5310	99.82	91.27			34.25	8.32	34.02	194	116	Peak
5350.11	44.07	35.44	54	-9.93	34.28	8.38	34.03	194	116	Average
5350.11	55.91	47.28	74	-18.09	34.28	8.38	34.03	194	116	Peak
10620	45.53	30.82	54	-8.47	37.3	12.69	35.28	143	190	Average
10620	55.62	40.91	74	-18.38	37.3	12.69	35.28	143	190	Peak

Antenna Polarity & Test Distance: Vertical at 3 m										
Frequency (MHz)	Emission Level (dBuV/m)	Read Level (dBuV)	Limit (dBuV/m)	Margin (dB)	Antenna Factor (dB/m)	Cable Loss (dB)	Preamp Factor (dB)	Antenna Height (cm)	Table Angle (Degree)	Remark
5128.7	42.66	34.44	54	-11.34	34.11	8.1	33.99	224	208	Average
5128.7	53.36	45.14	74	-20.64	34.11	8.1	33.99	224	208	Peak
5310	89.4	80.85			34.25	8.32	34.02	224	208	Average
5310	96.31	87.76			34.25	8.32	34.02	224	208	Peak
5350.11	43.15	34.52	54	-10.85	34.28	8.38	34.03	224	208	Average
5350.11	53.23	44.6	74	-20.77	34.28	8.38	34.03	224	208	Peak
10620	46.72	32.01	54	-7.28	37.3	12.69	35.28	159	113	Average
10620	56.81	42.1	74	-17.19	37.3	12.69	35.28	159	113	Peak

Remarks:

- Emission Level = Read Level + Antenna Factor + Cable Loss - Preamp Factor
Margin value = Emission level – Limit value
- 5310 MHz: Fundamental Frequency
- *: Out of Restricted Band
- The emission levels of other frequencies were very low against the limit

EUT Test Condition		Measurement Detail	
Channel	Channel 102	Frequency Range	1 GHz ~ 40 GHz
Input Power	120 Vac, 60 Hz	Detector Function	Peak (PK) Average (AV)
Environmental Conditions	25 deg. C, 65 % RH	Tested By	Charles Hsiao

Antenna Polarity & Test Distance: Horizontal at 3 m										
Frequency (MHz)	Emission Level (dBuV/m)	Read Level (dBuV)	Limit (dBuV/m)	Margin (dB)	Antenna Factor (dB/m)	Cable Loss (dB)	Preamp Factor (dB)	Antenna Height (cm)	Table Angle (Degree)	Remark
5448.24	43.54	34.71	54	-10.46	34.36	8.51	34.04	213	63	Average
5448.24	53.6	44.77	74	-20.4	34.36	8.51	34.04	213	63	Peak
*5468.88	55.72	46.89	68.2	-12.48	34.37	8.51	34.05	213	63	Peak
5510	94.76	85.85			34.4	8.57	34.06	213	63	Average
5510	101.16	92.25			34.4	8.57	34.06	213	63	Peak
*5724.04	53.07	43.91	68.2	-15.13	34.62	8.65	34.11	213	63	Peak
11020	46.67	31.6	54	-7.33	37.61	12.94	35.48	198	253	Average
11020	56.74	41.67	74	-17.26	37.61	12.94	35.48	198	253	Peak

Antenna Polarity & Test Distance: Vertical at 3 m										
Frequency (MHz)	Emission Level (dBuV/m)	Read Level (dBuV)	Limit (dBuV/m)	Margin (dB)	Antenna Factor (dB/m)	Cable Loss (dB)	Preamp Factor (dB)	Antenna Height (cm)	Table Angle (Degree)	Remark
5459.6	42.96	34.14	54	-11.04	34.36	8.51	34.05	233	188	Average
5459.6	53.39	44.57	74	-20.61	34.36	8.51	34.05	233	188	Peak
*5470.48	53.29	44.46	68.2	-14.91	34.37	8.51	34.05	233	188	Peak
5510	91.37	82.46			34.4	8.57	34.06	233	188	Average
5510	98.11	89.2			34.4	8.57	34.06	233	188	Peak
*5724.28	52.92	43.76	68.2	-15.28	34.62	8.65	34.11	233	188	Peak
11020	45.91	30.84	54	-8.09	37.61	12.94	35.48	185	227	Average
11020	55.76	40.69	74	-18.24	37.61	12.94	35.48	185	227	Peak

Remarks:

- Emission Level = Read Level + Antenna Factor + Cable Loss - Preamp Factor
Margin value = Emission level – Limit value
- 5510 MHz: Fundamental Frequency
- *: Out of Restricted Band
- The emission levels of other frequencies were very low against the limit

EUT Test Condition		Measurement Detail	
Channel	Channel 110	Frequency Range	1 GHz ~ 40 GHz
Input Power	120 Vac, 60 Hz	Detector Function	Peak (PK) Average (AV)
Environmental Conditions	25 deg. C, 65 % RH	Tested By	Charles Hsiao

Antenna Polarity & Test Distance: Horizontal at 3 m										
Frequency (MHz)	Emission Level (dBuV/m)	Read Level (dBuV)	Limit (dBuV/m)	Margin (dB)	Antenna Factor (dB/m)	Cable Loss (dB)	Preamp Factor (dB)	Antenna Height (cm)	Table Angle (Degree)	Remark
5448.08	43.63	34.8	54	-10.37	34.36	8.51	34.04	215	65	Average
5448.08	54.18	45.35	74	-19.82	34.36	8.51	34.04	215	65	Peak
*5468.88	51.82	42.99	68.2	-16.38	34.37	8.51	34.05	215	65	Peak
5550	94.76	85.79			34.45	8.59	34.07	215	65	Average
5550	101.36	92.39			34.45	8.59	34.07	215	65	Peak
*5725.96	52.06	42.9	68.2	-16.14	34.62	8.65	34.11	215	65	Peak
11100	45.83	30.74	54	-8.17	37.66	12.89	35.46	138	263	Average
11100	55.73	40.64	74	-18.27	37.66	12.89	35.46	138	263	Peak

Antenna Polarity & Test Distance: Vertical at 3 m										
Frequency (MHz)	Emission Level (dBuV/m)	Read Level (dBuV)	Limit (dBuV/m)	Margin (dB)	Antenna Factor (dB/m)	Cable Loss (dB)	Preamp Factor (dB)	Antenna Height (cm)	Table Angle (Degree)	Remark
5450	42.93	34.11	54	-11.07	34.36	8.51	34.05	201	182	Average
5450	53.78	44.96	74	-20.22	34.36	8.51	34.05	201	182	Peak
*5468.24	52.05	43.22	68.2	-16.15	34.37	8.51	34.05	201	182	Peak
5550	90.33	81.36			34.45	8.59	34.07	201	182	Average
5550	97.69	88.72			34.45	8.59	34.07	201	182	Peak
*5725.16	52.4	43.24	68.2	-15.8	34.62	8.65	34.11	201	182	Peak
11100	46.08	30.99	54	-7.92	37.66	12.89	35.46	149	137	Average
11100	56.21	41.12	74	-17.79	37.66	12.89	35.46	149	137	Peak

Remarks:

- Emission Level = Read Level + Antenna Factor + Cable Loss - Preamp Factor
Margin value = Emission level – Limit value
- 5550 MHz: Fundamental Frequency
- *: Out of Restricted Band
- The emission levels of other frequencies were very low against the limit

EUT Test Condition		Measurement Detail	
Channel	Channel 134	Frequency Range	1 GHz ~ 40 GHz
Input Power	120 Vac, 60 Hz	Detector Function	Peak (PK) Average (AV)
Environmental Conditions	25 deg. C, 65 % RH	Tested By	Charles Hsiao

Antenna Polarity & Test Distance: Horizontal at 3 m										
Frequency (MHz)	Emission Level (dBuV/m)	Read Level (dBuV)	Limit (dBuV/m)	Margin (dB)	Antenna Factor (dB/m)	Cable Loss (dB)	Preamp Factor (dB)	Antenna Height (cm)	Table Angle (Degree)	Remark
5439.44	42.77	33.98	54	-11.23	34.35	8.48	34.04	159	65	Average
5439.44	53.3	44.51	74	-20.7	34.35	8.48	34.04	159	65	Peak
*5470	53.16	44.33	68.2	-15.04	34.37	8.51	34.05	159	65	Peak
5670	94.11	85.01			34.57	8.63	34.1	159	65	Average
5670	101.07	91.97			34.57	8.63	34.1	159	65	Peak
*5724.44	52.73	43.57	68.2	-15.47	34.62	8.65	34.11	159	65	Peak
11340	46.17	31.08	54	-7.83	37.8	12.71	35.42	196	342	Average
11340	56.14	41.05	74	-17.86	37.8	12.71	35.42	196	342	Peak

Antenna Polarity & Test Distance: Vertical at 3 m										
Frequency (MHz)	Emission Level (dBuV/m)	Read Level (dBuV)	Limit (dBuV/m)	Margin (dB)	Antenna Factor (dB/m)	Cable Loss (dB)	Preamp Factor (dB)	Antenna Height (cm)	Table Angle (Degree)	Remark
5446.8	42.85	34.02	54	-11.15	34.36	8.51	34.04	252	188	Average
5446.8	53.11	44.28	74	-20.89	34.36	8.51	34.04	252	188	Peak
*5470.32	52.92	44.09	68.2	-15.28	34.37	8.51	34.05	252	188	Peak
5670	91.3	82.2			34.57	8.63	34.1	252	188	Average
5670	98.46	89.36			34.57	8.63	34.1	252	188	Peak
*5724.92	52.79	43.63	68.2	-15.41	34.62	8.65	34.11	252	188	Peak
11340	45.48	30.39	54	-8.52	37.8	12.71	35.42	148	218	Average
11340	55.37	40.28	74	-18.63	37.8	12.71	35.42	148	218	Peak

Remarks:

- Emission Level = Read Level + Antenna Factor + Cable Loss - Preamp Factor
Margin value = Emission level – Limit value
- 5670 MHz: Fundamental Frequency
- *: Out of Restricted Band
- The emission levels of other frequencies were very low against the limit

EUT Test Condition		Measurement Detail	
Channel	Channel 142	Frequency Range	1 GHz ~ 40 GHz
Input Power	120 Vac, 60 Hz	Detector Function	Peak (PK) Average (AV)
Environmental Conditions	25 deg. C, 65 % RH	Tested By	Charles Hsiao

Antenna Polarity & Test Distance: Horizontal at 3 m										
Frequency (MHz)	Emission Level (dBuV/m)	Read Level (dBuV)	Limit (dBuV/m)	Margin (dB)	Antenna Factor (dB/m)	Cable Loss (dB)	Preamp Factor (dB)	Antenna Height (cm)	Table Angle (Degree)	Remark
5434	42.85	34.06	54	-11.15	34.35	8.48	34.04	159	65	Average
5434	52.93	44.14	74	-21.07	34.35	8.48	34.04	159	65	Peak
*5469.84	52.04	43.21	68.2	-16.16	34.37	8.51	34.05	159	65	Peak
5710	94.46	85.31			34.61	8.65	34.11	159	65	Average
5710	101.71	92.56			34.61	8.65	34.11	159	65	Peak
11420	46.38	31.28	54	-7.62	37.85	12.65	35.4	195	226	Average
11420	56.1	41	74	-17.9	37.85	12.65	35.4	195	226	Peak
Antenna Polarity & Test Distance: Vertical at 3 m										
Frequency (MHz)	Emission Level (dBuV/m)	Read Level (dBuV)	Limit (dBuV/m)	Margin (dB)	Antenna Factor (dB/m)	Cable Loss (dB)	Preamp Factor (dB)	Antenna Height (cm)	Table Angle (Degree)	Remark
5449.04	42.72	33.89	54	-11.28	34.36	8.51	34.04	252	188	Average
5449.04	53.24	44.41	74	-20.76	34.36	8.51	34.04	252	188	Peak
*5468.08	53.55	44.72	68.2	-14.65	34.37	8.51	34.05	252	188	Peak
5710	91.08	81.93			34.61	8.65	34.11	252	188	Average
5710	98.28	89.13			34.61	8.65	34.11	252	188	Peak
11420	46.45	31.35	54	-7.55	37.85	12.65	35.4	128	246	Average
11420	56.32	41.22	74	-17.68	37.85	12.65	35.4	128	246	Peak

Remarks:

- Emission Level = Read Level + Antenna Factor + Cable Loss - Preamp Factor
Margin value = Emission level – Limit value
- 5710 MHz: Fundamental Frequency
- *: Out of Restricted Band
- The emission levels of other frequencies were very low against the limit

EUT Test Condition		Measurement Detail	
Channel	Channel 151	Frequency Range	1 GHz ~ 40 GHz
Input Power	120 Vac, 60 Hz	Detector Function	Peak (PK) Average (AV)
Environmental Conditions	25 deg. C, 65 % RH	Tested By	Charles Hsiao

<Spurious Emission>

Antenna Polarity & Test Distance: Horizontal at 3 m										
Frequency (MHz)	Emission Level (dBuV/m)	Read Level (dBuV)	Limit (dBuV/m)	Margin (dB)	Antenna Factor (dB/m)	Cable Loss (dB)	Preamp Factor (dB)	Antenna Height (cm)	Table Angle (Degree)	Remark
5755	93.77	84.56			34.66	8.66	34.11	100	202	Average
5755	100.74	91.53			34.66	8.66	34.11	100	202	Peak
11510	47.88	32.77	54	-6.12	37.9	12.6	35.39	115	13	Average
11510	57.88	42.77	74	-16.12	37.9	12.6	35.39	115	13	Peak
Antenna Polarity & Test Distance: Vertical at 3 m										
Frequency (MHz)	Emission Level (dBuV/m)	Read Level (dBuV)	Limit (dBuV/m)	Margin (dB)	Antenna Factor (dB/m)	Cable Loss (dB)	Preamp Factor (dB)	Antenna Height (cm)	Table Angle (Degree)	Remark
5755	89.98	80.77			34.66	8.66	34.11	166	5	Average
5755	96.64	87.43			34.66	8.66	34.11	166	5	Peak
11510	47.76	32.65	54	-6.24	37.9	12.6	35.39	125	348	Average
11510	56.24	41.13	74	-17.76	37.9	12.6	35.39	125	348	Peak

<Out of Band Emission (OOBE)>

Antenna Polarity & Test Distance: Horizontal at 3 m										
Frequency (MHz)	Emission Level (dBuV/m)	Read Level (dBuV)	Limit (dBuV/m)	Margin (dB)	Antenna Factor (dB/m)	Cable Loss (dB)	Preamp Factor (dB)	Antenna Height (cm)	Table Angle (Degree)	Remark
*5592.4	54.21	45.2	68.2	-13.99	34.49	8.6	34.08	100	202	Peak
5652.775	51.74	42.64	70.25	-18.51	34.56	8.63	34.09	100	202	Peak
5916.325	53.69	44.31	74.62	-20.93	34.81	8.73	34.16	100	202	Peak
*5962.525	53.89	44.45	68.2	-14.31	34.87	8.74	34.17	100	202	Peak
Antenna Polarity & Test Distance: Vertical at 3 m										
Frequency (MHz)	Emission Level (dBuV/m)	Read Level (dBuV)	Limit (dBuV/m)	Margin (dB)	Antenna Factor (dB/m)	Cable Loss (dB)	Preamp Factor (dB)	Antenna Height (cm)	Table Angle (Degree)	Remark
*5608.675	54.75	45.72	68.2	-13.45	34.5	8.61	34.08	166	5	Peak
5656.45	51.48	42.39	72.97	-21.49	34.56	8.63	34.1	166	5	Peak
5921.575	52.94	43.54	70.73	-17.79	34.83	8.73	34.16	166	5	Peak
*6007.675	53.56	44.05	68.2	-14.64	34.92	8.76	34.17	166	5	Peak

Remarks:

- Emission Level = Read Level + Antenna Factor + Cable Loss - Preamp Factor
Margin value = Emission level – Limit value
- 5755 MHz: Fundamental Frequency
- *: Out of Restricted Band
- The emission levels of other frequencies were very low against the limit

EUT Test Condition		Measurement Detail	
Channel	Channel 159	Frequency Range	1 GHz ~ 40 GHz
Input Power	120 Vac, 60 Hz	Detector Function	Peak (PK) Average (AV)
Environmental Conditions	25 deg. C, 65 % RH	Tested By	Charles Hsiao

<Spurious Emission>

Antenna Polarity & Test Distance: Horizontal at 3 m										
Frequency (MHz)	Emission Level (dBuV/m)	Read Level (dBuV)	Limit (dBuV/m)	Margin (dB)	Antenna Factor (dB/m)	Cable Loss (dB)	Preamp Factor (dB)	Antenna Height (cm)	Table Angle (Degree)	Remark
5795	93.32	84.08			34.69	8.68	34.13	100	202	Average
5795	100.6	91.36			34.69	8.68	34.13	100	202	Peak
11590	47.83	32.46	54	-6.17	38.02	12.72	35.37	116	324	Average
11590	56.27	40.9	74	-17.73	38.02	12.72	35.37	116	324	Peak
Antenna Polarity & Test Distance: Vertical at 3 m										
Frequency (MHz)	Emission Level (dBuV/m)	Read Level (dBuV)	Limit (dBuV/m)	Margin (dB)	Antenna Factor (dB/m)	Cable Loss (dB)	Preamp Factor (dB)	Antenna Height (cm)	Table Angle (Degree)	Remark
5795	89.5	80.26			34.69	8.68	34.13	166	5	Average
5795	96.47	87.23			34.69	8.68	34.13	166	5	Peak
11590	48.02	32.65	54	-5.98	38.02	12.72	35.37	132	30	Average
11590	56.85	41.48	74	-17.15	38.02	12.72	35.37	132	30	Peak

<Out of Band Emission (OOBE)>

Antenna Polarity & Test Distance: Horizontal at 3 m										
Frequency (MHz)	Emission Level (dBuV/m)	Read Level (dBuV)	Limit (dBuV/m)	Margin (dB)	Antenna Factor (dB/m)	Cable Loss (dB)	Preamp Factor (dB)	Antenna Height (cm)	Table Angle (Degree)	Remark
*5595.025	54.98	45.97	68.2	-13.22	34.49	8.6	34.08	100	202	Peak
5656.45	52.55	43.46	72.97	-20.42	34.56	8.63	34.1	100	202	Peak
5922.625	53.59	44.19	69.96	-16.37	34.83	8.73	34.16	100	202	Peak
*5995.6	54.25	44.76	68.2	-13.95	34.9	8.76	34.17	100	202	Peak
Antenna Polarity & Test Distance: Vertical at 3 m										
Frequency (MHz)	Emission Level (dBuV/m)	Read Level (dBuV)	Limit (dBuV/m)	Margin (dB)	Antenna Factor (dB/m)	Cable Loss (dB)	Preamp Factor (dB)	Antenna Height (cm)	Table Angle (Degree)	Remark
*5556.7	54.57	45.6	68.2	-13.63	34.45	8.59	34.07	166	5	Peak
5654.875	50.16	41.07	71.81	-21.65	34.56	8.63	34.1	166	5	Peak
5922.625	52.07	42.67	69.96	-17.89	34.83	8.73	34.16	166	5	Peak
*5957.8	54.03	44.58	68.2	-14.17	34.87	8.74	34.16	166	5	Peak

Remarks:

- Emission Level = Read Level + Antenna Factor + Cable Loss - Preamp Factor
Margin value = Emission level – Limit value
- 5795 MHz: Fundamental Frequency
- *: Out of Restricted Band
- The emission levels of other frequencies were very low against the limit

802.11ac (VHT80)

EUT Test Condition		Measurement Detail	
Channel	Channel 42	Frequency Range	1 GHz ~ 40 GHz
Input Power	120 Vac, 60 Hz	Detector Function	Peak (PK) Average (AV)
Environmental Conditions	25 deg. C, 65 % RH	Tested By	Charles Hsiao

Antenna Polarity & Test Distance: Horizontal at 3 m

Frequency (MHz)	Emission Level (dBuV/m)	Read Level (dBuV)	Limit (dBuV/m)	Margin (dB)	Antenna Factor (dB/m)	Cable Loss (dB)	Preamp Factor (dB)	Antenna Height (cm)	Table Angle (Degree)	Remark
5147	43.45	35.2	54	-10.55	34.12	8.13	34	234	320	Average
5147	53.86	45.61	74	-20.14	34.12	8.13	34	234	320	Peak
5210	86.27	77.91			34.17	8.19	34	234	320	Average
5210	93.5	85.14			34.17	8.19	34	234	320	Peak
5431.29	43.62	34.83	54	-10.38	34.35	8.48	34.04	234	320	Average
5431.29	52.67	43.88	74	-21.33	34.35	8.48	34.04	234	320	Peak
*10420	56.39	41.98	68.2	-11.81	37.15	12.42	35.16	195	9	Peak

Antenna Polarity & Test Distance: Vertical at 3 m

Frequency (MHz)	Emission Level (dBuV/m)	Read Level (dBuV)	Limit (dBuV/m)	Margin (dB)	Antenna Factor (dB/m)	Cable Loss (dB)	Preamp Factor (dB)	Antenna Height (cm)	Table Angle (Degree)	Remark
5070.2	43.48	35.38	54	-10.52	34.05	8.03	33.98	101	178	Average
5070.2	53.13	45.03	74	-20.87	34.05	8.03	33.98	101	178	Peak
5210	83.77	75.41			34.17	8.19	34	101	178	Average
5210	90.89	82.53			34.17	8.19	34	101	178	Peak
5451.09	43.59	34.77	54	-10.41	34.36	8.51	34.05	101	178	Average
5451.09	53.46	44.64	74	-20.54	34.36	8.51	34.05	101	178	Peak
*10420	56.15	41.74	68.2	-12.05	37.15	12.42	35.16	115	326	Peak

Remarks:

- Emission Level = Read Level + Antenna Factor + Cable Loss - Preamp Factor
Margin value = Emission level – Limit value
- 5210 MHz: Fundamental Frequency
- *: Out of Restricted Band
- The emission levels of other frequencies were very low against the limit

EUT Test Condition		Measurement Detail	
Channel	Channel 58	Frequency Range	1 GHz ~ 40 GHz
Input Power	120 Vac, 60 Hz	Detector Function	Peak (PK) Average (AV)
Environmental Conditions	25 deg. C, 65 % RH	Tested By	Charles Hsiao

Antenna Polarity & Test Distance: Horizontal at 3 m										
Frequency (MHz)	Emission Level (dBuV/m)	Read Level (dBuV)	Limit (dBuV/m)	Margin (dB)	Antenna Factor (dB/m)	Cable Loss (dB)	Preamp Factor (dB)	Antenna Height (cm)	Table Angle (Degree)	Remark
5124.5	42.73	34.51	54	-11.27	34.11	8.1	33.99	213	116	Average
5124.5	53.54	45.32	74	-20.46	34.11	8.1	33.99	213	116	Peak
5290	86.4	77.87			34.23	8.32	34.02	213	116	Average
5290	94.17	85.64			34.23	8.32	34.02	213	116	Peak
5350.88	43.41	34.78	54	-10.59	34.28	8.38	34.03	213	116	Average
5350.88	53.81	45.18	74	-20.19	34.28	8.38	34.03	213	116	Peak
*10580	56.65	42	68.2	-11.55	37.27	12.65	35.27	111	68	Peak

Antenna Polarity & Test Distance: Vertical at 3 m										
Frequency (MHz)	Emission Level (dBuV/m)	Read Level (dBuV)	Limit (dBuV/m)	Margin (dB)	Antenna Factor (dB/m)	Cable Loss (dB)	Preamp Factor (dB)	Antenna Height (cm)	Table Angle (Degree)	Remark
5123.75	42.56	34.34	54	-11.44	34.11	8.1	33.99	224	208	Average
5123.75	53.46	45.24	74	-20.54	34.11	8.1	33.99	224	208	Peak
5290	83.38	74.85			34.23	8.32	34.02	224	208	Average
5290	91.33	82.8			34.23	8.32	34.02	224	208	Peak
5450.1	42.73	33.91	54	-11.27	34.36	8.51	34.05	224	208	Average
5450.1	53	44.18	74	-21	34.36	8.51	34.05	224	208	Peak
*10580	57.31	42.66	68.2	-10.89	37.27	12.65	35.27	169	203	Peak

Remarks:

- Emission Level = Read Level + Antenna Factor + Cable Loss - Preamp Factor
Margin value = Emission level – Limit value
- 5290 MHz: Fundamental Frequency
- *: Out of Restricted Band
- The emission levels of other frequencies were very low against the limit

EUT Test Condition		Measurement Detail	
Channel	Channel 106	Frequency Range	1 GHz ~ 40 GHz
Input Power	120 Vac, 60 Hz	Detector Function	Peak (PK) Average (AV)
Environmental Conditions	25 deg. C, 65 % RH	Tested By	Charles Hsiao

Antenna Polarity & Test Distance: Horizontal at 3 m										
Frequency (MHz)	Emission Level (dBuV/m)	Read Level (dBuV)	Limit (dBuV/m)	Margin (dB)	Antenna Factor (dB/m)	Cable Loss (dB)	Preamp Factor (dB)	Antenna Height (cm)	Table Angle (Degree)	Remark
5458.32	43.9	35.08	54	-10.1	34.36	8.51	34.05	215	65	Average
5458.32	53.6	44.78	74	-20.4	34.36	8.51	34.05	215	65	Peak
*5470.8	54.46	45.6	68.2	-13.74	34.37	8.54	34.05	215	65	Peak
5530	87.63	78.7			34.42	8.58	34.07	215	65	Average
5530	95.86	86.93			34.42	8.58	34.07	215	65	Peak
*5725.96	51.67	42.51	68.2	-16.53	34.62	8.65	34.11	215	65	Peak
11060	46.71	31.63	54	-7.29	37.64	12.91	35.47	131	124	Average
11060	56.66	41.58	74	-17.34	37.64	12.91	35.47	131	124	Peak

Antenna Polarity & Test Distance: Vertical at 3 m										
Frequency (MHz)	Emission Level (dBuV/m)	Read Level (dBuV)	Limit (dBuV/m)	Margin (dB)	Antenna Factor (dB/m)	Cable Loss (dB)	Preamp Factor (dB)	Antenna Height (cm)	Table Angle (Degree)	Remark
5458.48	43.2	34.38	54	-10.8	34.36	8.51	34.05	233	188	Average
5458.48	53.59	44.77	74	-20.41	34.36	8.51	34.05	233	188	Peak
*5470.32	53.03	44.2	68.2	-15.17	34.37	8.51	34.05	233	188	Peak
5530	84.34	75.41			34.42	8.58	34.07	233	188	Average
5530	92.92	83.99			34.42	8.58	34.07	233	188	Peak
*5725.4	53.79	44.63	68.2	-14.41	34.62	8.65	34.11	233	188	Peak
11060	46.59	31.51	54	-7.41	37.64	12.91	35.47	182	164	Average
11060	56.62	41.54	74	-17.38	37.64	12.91	35.47	182	164	Peak

Remarks:

- Emission Level = Read Level + Antenna Factor + Cable Loss - Preamp Factor
Margin value = Emission level – Limit value
- 5530 MHz: Fundamental Frequency
- *: Out of Restricted Band
- The emission levels of other frequencies were very low against the limit

EUT Test Condition		Measurement Detail	
Channel	Channel 122	Frequency Range	1 GHz ~ 40 GHz
Input Power	120 Vac, 60 Hz	Detector Function	Peak (PK) Average (AV)
Environmental Conditions	25 deg. C, 65 % RH	Tested By	Charles Hsiao

Antenna Polarity & Test Distance: Horizontal at 3 m										
Frequency (MHz)	Emission Level (dBuV/m)	Read Level (dBuV)	Limit (dBuV/m)	Margin (dB)	Antenna Factor (dB/m)	Cable Loss (dB)	Preamp Factor (dB)	Antenna Height (cm)	Table Angle (Degree)	Remark
5452.56	42.8	33.98	54	-11.2	34.36	8.51	34.05	212	65	Average
5452.56	54.47	45.65	74	-19.53	34.36	8.51	34.05	212	65	Peak
*5469.52	53.17	44.34	68.2	-15.03	34.37	8.51	34.05	212	65	Peak
5610	87	77.97			34.5	8.61	34.08	212	65	Average
5610	95.39	86.36			34.5	8.61	34.08	212	65	Peak
*5725.56	52.91	43.75	68.2	-15.29	34.62	8.65	34.11	212	65	Peak
11220	48.35	33.26	54	-5.65	37.73	12.8	35.44	196	326	Average
11220	58.6	43.51	74	-15.4	37.73	12.8	35.44	196	326	Peak

Antenna Polarity & Test Distance: Vertical at 3 m										
Frequency (MHz)	Emission Level (dBuV/m)	Read Level (dBuV)	Limit (dBuV/m)	Margin (dB)	Antenna Factor (dB/m)	Cable Loss (dB)	Preamp Factor (dB)	Antenna Height (cm)	Table Angle (Degree)	Remark
5450	42.76	33.94	54	-11.24	34.36	8.51	34.05	201	182	Average
5450	53.47	44.65	74	-20.53	34.36	8.51	34.05	201	182	Peak
*5470	51.41	42.58	68.2	-16.79	34.37	8.51	34.05	201	182	Peak
5610	84.9	75.87			34.5	8.61	34.08	201	182	Average
5610	92.29	83.26			34.5	8.61	34.08	201	182	Peak
*5724.44	52.37	43.21	68.2	-15.83	34.62	8.65	34.11	201	182	Peak
11220	47.63	32.54	54	-6.37	37.73	12.8	35.44	153	82	Average
11220	57.8	42.71	74	-16.2	37.73	12.8	35.44	153	82	Peak

Remarks:

- Emission Level = Read Level + Antenna Factor + Cable Loss - Preamp Factor
Margin value = Emission level – Limit value
- 5610 MHz: Fundamental Frequency
- *: Out of Restricted Band
- The emission levels of other frequencies were very low against the limit

EUT Test Condition		Measurement Detail	
Channel	Channel 138	Frequency Range	1 GHz ~ 40 GHz
Input Power	120 Vac, 60 Hz	Detector Function	Peak (PK) Average (AV)
Environmental Conditions	25 deg. C, 65 % RH	Tested By	Charles Hsiao

Antenna Polarity & Test Distance: Horizontal at 3 m										
Frequency (MHz)	Emission Level (dBuV/m)	Read Level (dBuV)	Limit (dBuV/m)	Margin (dB)	Antenna Factor (dB/m)	Cable Loss (dB)	Preamp Factor (dB)	Antenna Height (cm)	Table Angle (Degree)	Remark
5460	42.73	33.91	54	-11.27	34.36	8.51	34.05	159	65	Average
5460	53.9	45.08	74	-20.1	34.36	8.51	34.05	159	65	Peak
*5468.4	52.47	43.64	68.2	-15.73	34.37	8.51	34.05	159	65	Peak
5690	90.58	81.45			34.59	8.64	34.1	159	65	Average
5690	98.26	89.13			34.59	8.64	34.1	159	65	Peak
11380	46	30.89	54	-8	37.83	12.69	35.41	169	332	Average
11380	56.01	40.9	74	-17.99	37.83	12.69	35.41	169	332	Peak
Antenna Polarity & Test Distance: Vertical at 3 m										
Frequency (MHz)	Emission Level (dBuV/m)	Read Level (dBuV)	Limit (dBuV/m)	Margin (dB)	Antenna Factor (dB/m)	Cable Loss (dB)	Preamp Factor (dB)	Antenna Height (cm)	Table Angle (Degree)	Remark
5439.76	42.68	33.89	54	-11.32	34.35	8.48	34.04	252	188	Average
5439.76	53.56	44.77	74	-20.44	34.35	8.48	34.04	252	188	Peak
*5468.08	53.24	44.41	68.2	-14.96	34.37	8.51	34.05	252	188	Peak
5690	88.03	78.9			34.59	8.64	34.1	252	188	Average
5690	96.22	87.09			34.59	8.64	34.1	252	188	Peak
11380	47.11	32	54	-6.89	37.83	12.69	35.41	135	178	Average
11380	57.13	42.02	74	-16.87	37.83	12.69	35.41	135	178	Peak

Remarks:

- Emission Level = Read Level + Antenna Factor + Cable Loss - Preamp Factor
Margin value = Emission level – Limit value
- 5690 MHz: Fundamental Frequency
- *: Out of Restricted Band
- The emission levels of other frequencies were very low against the limit

EUT Test Condition		Measurement Detail	
Channel	Channel 155	Frequency Range	1 GHz ~ 40 GHz
Input Power	120 Vac, 60 Hz	Detector Function	Peak (PK) Average (AV)
Environmental Conditions	25 deg. C, 65 % RH	Tested By	Charles Hsiao

<Spurious Emission>

Antenna Polarity & Test Distance: Horizontal at 3 m										
Frequency (MHz)	Emission Level (dBuV/m)	Read Level (dBuV)	Limit (dBuV/m)	Margin (dB)	Antenna Factor (dB/m)	Cable Loss (dB)	Preamp Factor (dB)	Antenna Height (cm)	Table Angle (Degree)	Remark
5775	89.74	80.51			34.68	8.67	34.12	100	202	Average
5775	96.99	87.76			34.68	8.67	34.12	100	202	Peak
11550	48.26	32.99	54	-5.74	37.97	12.68	35.38	147	4	Average
11550	56.85	41.58	74	-17.15	37.97	12.68	35.38	147	4	Peak
Antenna Polarity & Test Distance: Vertical at 3 m										
Frequency (MHz)	Emission Level (dBuV/m)	Read Level (dBuV)	Limit (dBuV/m)	Margin (dB)	Antenna Factor (dB/m)	Cable Loss (dB)	Preamp Factor (dB)	Antenna Height (cm)	Table Angle (Degree)	Remark
5775	85.52	76.29			34.68	8.67	34.12	166	5	Average
5775	92.85	83.62			34.68	8.67	34.12	166	5	Peak
11550	48.27	33	54	-5.73	37.97	12.68	35.38	174	247	Average
11550	56.33	41.06	74	-17.67	37.97	12.68	35.38	174	247	Peak

<Out of Band Emission (OOBE)>

Antenna Polarity & Test Distance: Horizontal at 3 m										
Frequency (MHz)	Emission Level (dBuV/m)	Read Level (dBuV)	Limit (dBuV/m)	Margin (dB)	Antenna Factor (dB/m)	Cable Loss (dB)	Preamp Factor (dB)	Antenna Height (cm)	Table Angle (Degree)	Remark
*5598.7	53.19	44.17	68.2	-15.01	34.5	8.6	34.08	100	202	Peak
5662.225	54.45	45.36	77.25	-22.8	34.56	8.63	34.1	100	202	Peak
5914.75	53.4	44.02	75.78	-22.38	34.81	8.73	34.16	100	202	Peak
*5996.65	54.12	44.63	68.2	-14.08	34.9	8.76	34.17	100	202	Peak
Antenna Polarity & Test Distance: Vertical at 3 m										
Frequency (MHz)	Emission Level (dBuV/m)	Read Level (dBuV)	Limit (dBuV/m)	Margin (dB)	Antenna Factor (dB/m)	Cable Loss (dB)	Preamp Factor (dB)	Antenna Height (cm)	Table Angle (Degree)	Remark
*5648.05	53.91	44.84	68.2	-14.29	34.54	8.62	34.09	166	5	Peak
5659.075	52.74	43.65	74.92	-22.18	34.56	8.63	34.1	166	5	Peak
5919.475	53.06	43.68	72.29	-19.23	34.81	8.73	34.16	166	5	Peak
*6022.375	55.11	45.6	68.2	-13.09	34.92	8.77	34.18	166	5	Peak

Remarks:

- Emission Level = Read Level + Antenna Factor + Cable Loss - Preamp Factor
Margin value = Emission level – Limit value
- 5775 MHz: Fundamental Frequency
- *: Out of Restricted Band
- The emission levels of other frequencies were very low against the limit

9 kHz ~ 30 MHz Data:

The amplitude of spurious emissions attenuated more than 20 dB below the permissible value is not required to be report.

30 MHz ~ 1 GHz Worst-Case Data:

Mode A

802.11n (HT20)

EUT Test Condition		Measurement Detail	
Channel	Channel 165	Frequency Range	30 MHz ~ 1 GHz
Input Power	120 Vac, 60 Hz	Detector Function	Peak (PK) Quasi-peak (QP)
Environmental Conditions	25 deg. C, 65 % RH	Tested By	Charles Hsiao

Antenna Polarity & Test Distance: Horizontal at 3 m										
Frequency (MHz)	Emission Level (dBuV/m)	Read Level (dBuV)	Limit (dBuV/m)	Margin (dB)	Antenna Factor (dB/m)	Cable Loss (dB)	Preamp Factor (dB)	Antenna Height (cm)	Table Angle (Degree)	Remark
36.75	17.92	36.76	40	-22.08	12.65	0.74	32.23	193	199	Peak
177.96	21.53	42.54	43.5	-21.97	9.62	1.61	32.24	171	162	Peak
260.31	27.8	45.47	46	-18.2	12.49	1.94	32.1	180	224	Peak
381.9	21.75	36.95	46	-24.25	14.63	2.34	32.17	153	185	Peak
729.1	22.2	31.55	46	-23.8	19.61	3.16	32.12	174	117	Peak
937	31.79	37.73	46	-14.21	21.65	3.62	31.21	163	225	Peak

Antenna Polarity & Test Distance: Vertical at 3 m										
Frequency (MHz)	Emission Level (dBuV/m)	Read Level (dBuV)	Limit (dBuV/m)	Margin (dB)	Antenna Factor (dB/m)	Cable Loss (dB)	Preamp Factor (dB)	Antenna Height (cm)	Table Angle (Degree)	Remark
47.82	14.45	31.26	40	-25.55	14.51	0.9	32.22	155	240	Peak
101.28	11.52	30.19	43.5	-31.98	12.31	1.28	32.26	165	124	Peak
254.1	13.33	31.1	46	-32.67	12.39	1.94	32.1	129	316	Peak
388.2	15.94	31.04	46	-30.06	14.75	2.34	32.19	165	357	Peak
715.8	24.12	33.66	46	-21.88	19.46	3.11	32.11	193	320	Peak
937	31.55	37.49	46	-14.45	21.65	3.62	31.21	146	122	Peak

Remarks:

- Emission Level = Read Level + Antenna Factor + Cable Loss - Preamp Factor
Margin value = Emission level – Limit value
- The emission levels of other frequencies were very low against the limit

Mode B

802.11n (HT20)

EUT Test Condition		Measurement Detail	
Channel	Channel 165	Frequency Range	30 MHz ~ 1 GHz
Input Power	120 Vac, 60 Hz	Detector Function	Peak (PK) Quasi-peak (QP)
Environmental Conditions	25 deg. C, 65 % RH	Tested By	Charles Hsiao

Antenna Polarity & Test Distance: Horizontal at 3 m										
Frequency (MHz)	Emission Level (dBuV/m)	Read Level (dBuV)	Limit (dBuV/m)	Margin (dB)	Antenna Factor (dB/m)	Cable Loss (dB)	Preamp Factor (dB)	Antenna Height (cm)	Table Angle (Degree)	Remark
89.94	14.2	34.34	43.5	-29.3	10.46	1.11	31.71	184	221	Peak
170.4	21.44	43.01	43.5	-22.06	9.15	1.52	32.24	109	346	Peak
253.83	27.26	45.03	46	-18.74	12.39	1.94	32.1	175	315	Peak
377.7	21.13	36.46	46	-24.87	14.56	2.26	32.15	189	264	Peak
666.8	19.57	29.94	46	-26.43	18.71	3.05	32.13	178	124	Peak
938.4	29.3	35.22	46	-16.7	21.66	3.62	31.2	139	305	Peak

Antenna Polarity & Test Distance: Vertical at 3 m										
Frequency (MHz)	Emission Level (dBuV/m)	Read Level (dBuV)	Limit (dBuV/m)	Margin (dB)	Antenna Factor (dB/m)	Cable Loss (dB)	Preamp Factor (dB)	Antenna Height (cm)	Table Angle (Degree)	Remark
56.46	12.26	29.6	40	-27.74	13.99	0.9	32.23	187	164	Peak
93.99	10.54	29.97	43.5	-32.96	11.39	1.11	31.93	108	129	Peak
246	12.26	30.29	46	-33.74	12.23	1.85	32.11	133	302	Peak
379.8	14.71	30.02	46	-31.29	14.59	2.26	32.16	155	143	Peak
682.2	19.84	29.94	46	-26.16	18.96	3.05	32.11	190	67	Peak
937.7	31.42	37.34	46	-14.58	21.66	3.62	31.2	127	133	Peak

Remarks:

- Emission Level = Read Level + Antenna Factor + Cable Loss - Preamp Factor
Margin value = Emission level – Limit value
- The emission levels of other frequencies were very low against the limit

4.2 Conducted Emission Measurement

4.2.1 Limits of Conducted Emission Measurement

Frequency (MHz)	Conducted Limit (dBuV)	
	Quasi-Peak	Average
0.15 - 0.5	66 - 56	56 - 46
0.50 - 5.0	56	46
5.0 - 30.0	60	50

- Note: 1. The lower limit shall apply at the transition frequencies.
 2. The limit decreases in line with the logarithm of the frequency in the range of 0.15 to 0.50 MHz.

4.2.2 Test Instruments

Description & Manufacturer	Model No.	Serial No.	Date of Calibration	Due Date of Calibration
Test Receiver ROHDE & SCHWARZ	ESCI	100613	Nov. 23, 2017	Nov. 22, 2018
RF signal cable (with 10dB PAD) Woken	5D-FB	Cable-cond1-01	Sep. 05, 2017	Sep. 04, 2018
LISN/AMN ROHDE & SCHWARZ (EUT)	ESH3-Z5	835239/001	Mar. 06, 2018	Mar. 05, 2019
LISN/AMN ROHDE & SCHWARZ (Peripheral)	ESH3-Z5	100311	Aug. 15, 2017	Aug. 14, 2018
Software ADT	BV ADT_Cond_ V7.3.7.4	NA	NA	NA

- Note: 1. The calibration interval of the above test instruments is 12 months and the calibrations are traceable to NML/ROC and NIST/USA.
 2. The test was performed in HwaYa Shielded Room 1.
 3. The VCCI Site Registration No. is C-2040.

4.2.3 Test Procedures

- a. The EUT was placed 0.4 meters from the conducting wall of the shielded room with EUT being connected to the power mains through a line impedance stabilization network (LISN). Other support units were connected to the power mains through another LISN. The two LISNs provide 50 ohm/ 50uH of coupling impedance for the measuring instrument.
- b. Both lines of the power mains connected to the EUT were checked for maximum conducted interference.
- c. The frequency range from 150 kHz to 30 MHz was searched. Emission levels under (Limit -20 dB) was not recorded.

Note: All modes of operation were investigated and the worst-case emissions are reported.

4.2.4 Deviation from Test Standard

No deviation.

4.2.5 Test Setup

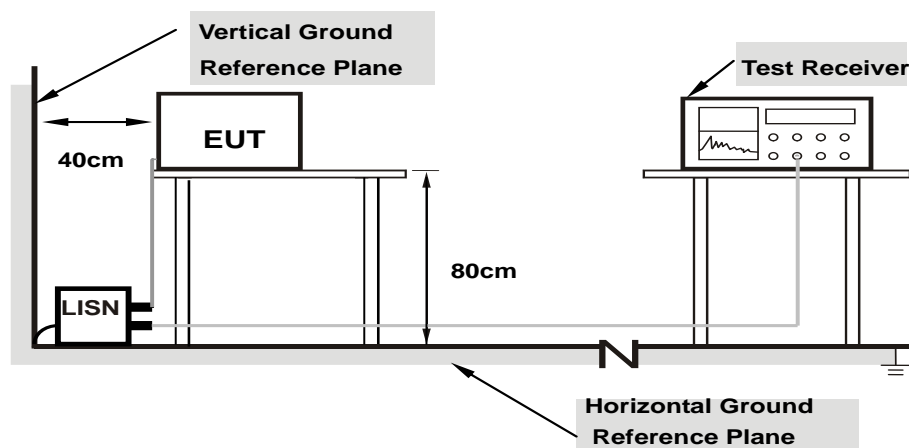

- Note:**
1. Support units were connected to second LISN.
 2. Both of LISNs (AMN) are 80 cm from EUT and at least 80 from other units and other metal planes

For the actual test configuration, please refer to the attached file (Test Setup Photo).

4.2.6 EUT Operating Conditions

- a. Placed the EUT on a testing table.
- b. Use the software to control the EUT under transmission condition continuously at specific channel frequency.

4.2.7 Test Results

Mode A

Frequency Range	150kHz ~ 30MHz	Detector Function & Resolution Bandwidth	Quasi-Peak (QP) / Average (AV), 9kHz
Input Power	120Vac, 60Hz	Environmental Conditions	25°C, 65%RH
Tested by	Getaz Yang	Test Date	2018/6/5

Phase Of Power : Line (L)										
No	Frequency (MHz)	Correction Factor (dB)	Reading Value (dBuV)		Emission Level (dBuV)		Limit (dBuV)		Margin (dB)	
			Q.P.	AV.	Q.P.	AV.	Q.P.	AV.	Q.P.	AV.
1	0.18122	10.10	31.21	17.88	41.31	27.98	64.43	54.43	-23.12	-26.45
2	0.22429	10.11	29.06	15.74	39.17	25.85	62.66	52.66	-23.49	-26.81
3	0.35332	10.11	28.82	17.51	38.93	27.62	58.88	48.88	-19.95	-21.26
4	0.50507	10.12	32.36	20.95	42.48	31.07	56.00	46.00	-13.52	-14.93
5	2.63285	10.22	25.39	8.85	35.61	19.07	56.00	46.00	-20.39	-26.93
6	12.70578	10.78	27.38	12.61	38.16	23.39	60.00	50.00	-21.84	-26.61

Remarks:

1. Q.P. and AV. are abbreviations of quasi-peak and average individually.
2. The emission levels of other frequencies were very low against the limit.
3. Margin value = Emission level – Limit value
4. Correction factor = Insertion loss + Cable loss
5. Emission Level = Correction Factor + Reading Value

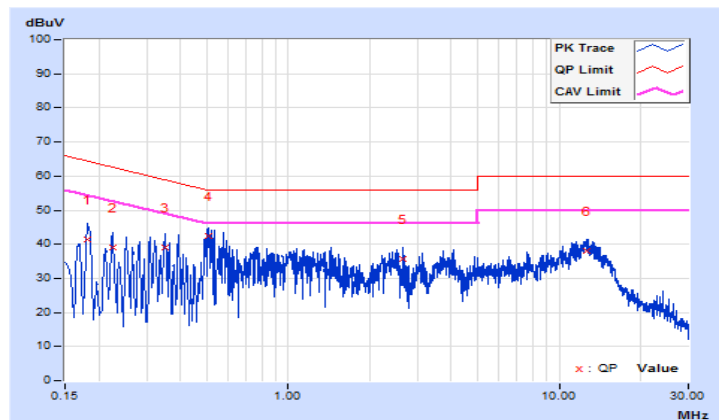

Frequency Range	150kHz ~ 30MHz	Detector Function & Resolution Bandwidth	Quasi-Peak (QP) / Average (AV), 9kHz
Input Power	120Vac, 60Hz	Environmental Conditions	25°C, 65%RH
Tested by	Getaz Yang	Test Date	2018/6/5

Phase Of Power : Neutral (N)										
No	Frequency (MHz)	Correction Factor (dB)	Reading Value (dBuV)		Emission Level (dBuV)		Limit (dBuV)		Margin (dB)	
			Q.P.	AV.	Q.P.	AV.	Q.P.	AV.	Q.P.	AV.
1	0.17346	10.10	30.15	12.47	40.25	22.57	64.79	54.79	-24.54	-32.22
2	0.28685	10.11	26.92	12.25	37.03	22.36	60.62	50.62	-23.59	-28.26
3	0.55273	10.12	30.11	17.56	40.23	27.68	56.00	46.00	-15.77	-18.32
4	1.31127	10.15	27.50	14.56	37.65	24.71	56.00	46.00	-18.35	-21.29
5	4.02790	10.27	27.59	13.29	37.86	23.56	56.00	46.00	-18.14	-22.44
6	13.68642	10.68	30.15	15.10	40.83	25.78	60.00	50.00	-19.17	-24.22

Remarks:

1. Q.P. and AV. are abbreviations of quasi-peak and average individually.
2. The emission levels of other frequencies were very low against the limit.
3. Margin value = Emission level – Limit value
4. Correction factor = Insertion loss + Cable loss
5. Emission Level = Correction Factor + Reading Value

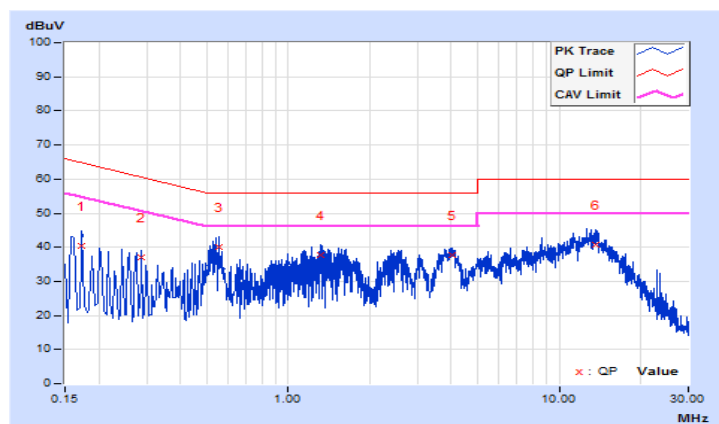

Mode B

Frequency Range	150kHz ~ 30MHz	Detector Function & Resolution Bandwidth	Quasi-Peak (QP) / Average (AV), 9kHz
Input Power	120Vac, 60Hz	Environmental Conditions	25°C, 65%RH
Tested by	Jisyong Wang	Test Date	2018/6/19

Phase Of Power : Line (L)										
No	Frequency (MHz)	Correction Factor (dB)	Reading Value (dBuV)		Emission Level (dBuV)		Limit (dBuV)		Margin (dB)	
			Q.P.	AV.	Q.P.	AV.	Q.P.	AV.	Q.P.	AV.
1	0.15391	10.10	37.90	16.65	48.00	26.75	65.79	55.79	-17.79	-29.04
2	0.18122	10.10	34.89	15.30	44.99	25.40	64.43	54.43	-19.44	-29.03
3	0.25557	10.11	22.13	2.18	32.24	12.29	61.57	51.57	-29.33	-39.28
4	0.35332	10.11	22.88	4.65	32.99	14.76	58.88	48.88	-25.89	-34.12
5	1.04517	10.14	19.44	4.63	29.58	14.77	56.00	46.00	-26.42	-31.23
6	7.95436	10.51	27.87	15.42	38.38	25.93	60.00	50.00	-21.62	-24.07

Remarks:

1. Q.P. and AV. are abbreviations of quasi-peak and average individually.
2. The emission levels of other frequencies were very low against the limit.
3. Margin value = Emission level – Limit value
4. Correction factor = Insertion loss + Cable loss
5. Emission Level = Correction Factor + Reading Value

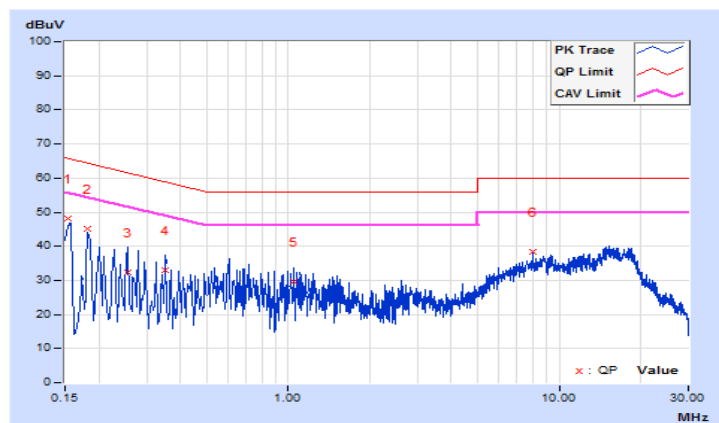

Frequency Range	150kHz ~ 30MHz	Detector Function & Resolution Bandwidth	Quasi-Peak (QP) / Average (AV), 9kHz
Input Power	120Vac, 60Hz	Environmental Conditions	25°C, 65%RH
Tested by	Jisyong Wang	Test Date	2018/6/19

Phase Of Power : Neutral (N)										
No	Frequency (MHz)	Correction Factor (dB)	Reading Value (dBuV)		Emission Level (dBuV)		Limit (dBuV)		Margin (dB)	
			Q.P.	AV.	Q.P.	AV.	Q.P.	AV.	Q.P.	AV.
1	0.23216	10.11	25.62	6.18	35.73	16.29	62.37	52.37	-26.64	-36.08
2	0.25948	10.11	30.61	15.37	40.72	25.48	61.45	51.45	-20.73	-25.97
3	0.55679	10.12	26.86	11.97	36.98	22.09	56.00	46.00	-19.02	-23.91
4	1.15487	10.14	23.29	5.28	33.43	15.42	56.00	46.00	-22.57	-30.58
5	1.77265	10.17	30.41	2.85	40.58	13.02	56.00	46.00	-15.42	-32.98
6	15.64142	10.76	27.21	13.78	37.97	24.54	60.00	50.00	-22.03	-25.46

Remarks:

1. Q.P. and AV. are abbreviations of quasi-peak and average individually.
2. The emission levels of other frequencies were very low against the limit.
3. Margin value = Emission level – Limit value
4. Correction factor = Insertion loss + Cable loss
5. Emission Level = Correction Factor + Reading Value

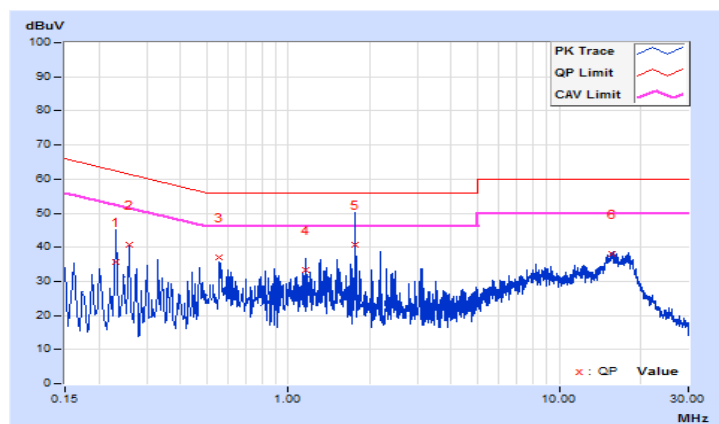

4.3 Transmit Power Measurement

4.3.1 Limits of Transmit Power Measurement

Operation Band	EUT Category	Limit
U-NII-1	Outdoor Access Point	1 Watt (30 dBm) (Max. e.i.r.p \leq 125 mW (21 dBm) at any elevation angle above 30 degrees as measured from the horizon)
	Fixed point-to-point Access Point	1 Watt (30 dBm)
	Indoor Access Point	1 Watt (30 dBm)
	√ Mobile and Portable client device	250 mW (24 dBm)
U-NII-2A	√	250 mW (24 dBm) or 11 dBm + 10 log B*
U-NII-2C	√	250 mW (24 dBm) or 11 dBm + 10 log B*
U-NII-3	√	1 Watt (30 dBm)

*B is the 26 dB emission bandwidth in megahertz

Per KDB 662911 Method of conducted output power measurement on IEEE 802.11 devices,

Array Gain = 0 dB (i.e., no array gain) for $N_{ANT} \leq 4$;

Array Gain = 0 dB (i.e., no array gain) for channel widths ≥ 40 MHz for any N_{ANT} ;

Array Gain = $5 \log(N_{ANT}/N_{SS})$ dB or 3 dB, whichever is less for 20 MHz channel widths with $N_{ANT} \geq 5$.

For power measurements on all other devices: Array Gain = $10 \log(N_{ANT}/N_{SS})$ dB.

4.3.2 Test Setup

<Power Output Measurement>

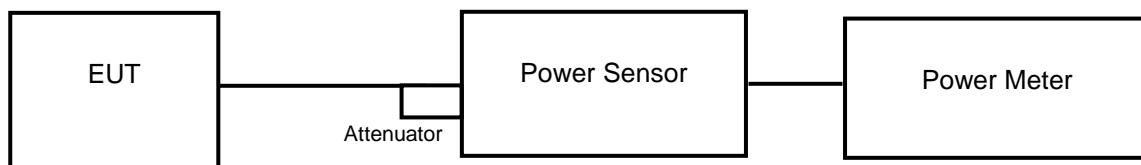

or

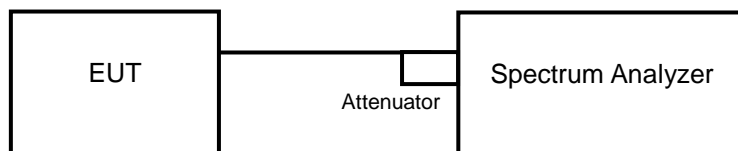

<26 dB Bandwidth>

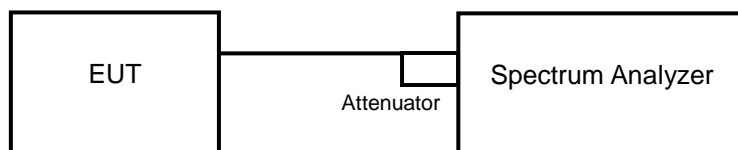

4.3.3 Test Instruments

Refer to section 4.1.2 to get information of above instrument.

4.3.4 Test Procedure

Average Power Measurement

<802.11a, 802.11n (HT20), 802.11n (HT40)>

Method PM is used to perform output power measurement, trigger and gating function of wide band power meter is enabled to measure max output power of TX on burst. Duty factor is not added to measured value.

<802.11ac (VHT80)>

- a. Set span to encompass the entire 26 dB EBW (or, alternatively, the entire 99 % occupied bandwidth) of the signal.
- b. Set sweep trigger to "free run".
- c. Set RBW = 1 MHz.
- d. Set VBW \geq 3 MHz
- e. Number of points in sweep \geq 2 Span / RBW.
- f. Sweep time \leq (number of points in sweep) * T
- g. Using emission bandwidth to determine the frequency span for integration the channel bandwidth.
- h. Detector = RMS.
- i. Trace mode = max hold.
- j. Allow max hold to run for at least 60 seconds, or longer as needed to allow the trace to stabilize.

26 dB Bandwidth

- a. Set RBW = approximately 1 % of the emission bandwidth.
- b. Set the VBW > RBW.
- c. Detector = Peak.
- d. Trace mode = max hold.
- e. Measure the maximum width of the emission that is 26 dB down from the peak of the emission. Compare this with the RBW setting of the analyzer. Readjust RBW and repeat measurement as needed until the RBW/EBW ratio is approximately 1 %.

4.3.5 Deviation from Test Standard

No deviation.

4.3.6 EUT Operating Conditions

The software provided by client to enable the EUT under transmission condition continuously at lowest, middle and highest channel frequencies individually.

4.3.7 Test Results

Power Output:

802.11a

Channel	Frequency (MHz)	Maximum Conducted Power (mW)	Maximum Conducted Power (dBm)	Power Limit (dBm)	Pass / Fail
36	5180	28.576	14.56	24	Pass
40	5200	27.925	14.46	24	Pass
48	5240	29.174	14.65	24	Pass
52	5260	27.669	14.42	24	Pass
60	5300	29.309	14.67	24	Pass
64	5320	28.576	14.56	24	Pass
100	5500	28.314	14.52	24	Pass
116	5580	29.923	14.76	24	Pass
140	5700	27.542	14.40	24	Pass
144	5720 (U-NII-2C)	28.314	14.52	23.12	Pass
144	5720 (U-NII-3)	28.314	14.52	30	Pass
149	5745	28.774	14.59	30	Pass
157	5785	28.314	14.52	30	Pass
165	5825	27.99	14.47	30	Pass

Note:

For U-NII-2A, U-NII-2C Band:

1. $11 \text{ dBm} + 10\log (22.31) = 24.48 \text{ dBm} > 24 \text{ dBm}$.
2. $11 \text{ dBm} + 10\log (22.61) = 24.54 \text{ dBm} > 24 \text{ dBm}$.
3. $11 \text{ dBm} + 10\log (22.25) = 24.47 \text{ dBm} > 24 \text{ dBm}$.
4. $11 \text{ dBm} + 10\log (22.51) = 24.52 \text{ dBm} > 24 \text{ dBm}$.
5. $11 \text{ dBm} + 10\log (22.40) = 24.50 \text{ dBm} > 24 \text{ dBm}$.
6. $11 \text{ dBm} + 10\log (22.17) = 24.45 \text{ dBm} > 24 \text{ dBm}$.
7. $11 \text{ dBm} + 10\log (16.30) = 23.12 \text{ dBm} < 24 \text{ dBm}$.

802.11n (HT20)

Channel	Frequency (MHz)	Maximum Conducted Power (mW)	Maximum Conducted Power (dBm)	Power Limit (dBm)	Pass / Fail
36	5180	29.309	14.67	24	Pass
40	5200	28.445	14.54	24	Pass
48	5240	28.708	14.58	24	Pass
52	5260	29.242	14.66	24	Pass
60	5300	28.774	14.59	24	Pass
64	5320	29.512	14.70	24	Pass
100	5500	29.992	14.77	24	Pass
116	5580	29.107	14.64	24	Pass
140	5700	30.061	14.78	24	Pass
144	5720 (U-NII-2C)	30.339	14.82	23.18	Pass
144	5720 (U-NII-3)	30.339	14.82	30	Pass
149	5745	29.174	14.65	30	Pass
157	5785	28.708	14.58	30	Pass
165	5825	27.227	14.35	30	Pass

Note:

For U-NII-2A, U-NII-2C Band:

1. $11 \text{ dBm} + 10\log(22.78) = 24.57 \text{ dBm} > 24 \text{ dBm}$.
2. $11 \text{ dBm} + 10\log(22.70) = 24.56 \text{ dBm} > 24 \text{ dBm}$.
3. $11 \text{ dBm} + 10\log(22.80) = 24.57 \text{ dBm} > 24 \text{ dBm}$.
4. $11 \text{ dBm} + 10\log(22.73) = 24.56 \text{ dBm} > 24 \text{ dBm}$.
5. $11 \text{ dBm} + 10\log(22.41) = 24.50 \text{ dBm} > 24 \text{ dBm}$.
6. $11 \text{ dBm} + 10\log(23.01) = 24.61 \text{ dBm} > 24 \text{ dBm}$.
7. $11 \text{ dBm} + 10\log(16.55) = 23.18 \text{ dBm} < 24 \text{ dBm}$.

802.11n (HT40)

Channel	Frequency (MHz)	Maximum Conducted Power (mW)	Maximum Conducted Power (dBm)	Power Limit (dBm)	Pass / Fail
38	5190	31.477	14.98	24	Pass
46	5230	30.832	14.89	24	Pass
54	5270	30.69	14.87	24	Pass
62	5310	30.061	14.78	24	Pass
102	5510	30.903	14.90	24	Pass
110	5550	29.174	14.65	24	Pass
134	5670	31.189	14.94	24	Pass
142	5710 (U-NII-2C)	32.659	15.14	24	Pass
142	5710 (U-NII-3)	32.659	15.14	30	Pass
151	5755	32.509	15.12	30	Pass
159	5795	30.69	14.87	30	Pass

Note:

For U-NII-2A, U-NII-2C Band:

1. $11 \text{ dBm} + 10\log (45.62) = 27.59 \text{ dBm} > 24 \text{ dBm}$.
2. $11 \text{ dBm} + 10\log (45.66) = 27.59 \text{ dBm} > 24 \text{ dBm}$.
3. $11 \text{ dBm} + 10\log (45.66) = 27.59 \text{ dBm} > 24 \text{ dBm}$.
4. $11 \text{ dBm} + 10\log (45.75) = 27.60 \text{ dBm} > 24 \text{ dBm}$.
5. $11 \text{ dBm} + 10\log (46.06) = 27.63 \text{ dBm} > 24 \text{ dBm}$.
6. $11 \text{ dBm} + 10\log (38.02) = 26.80 \text{ dBm} > 24 \text{ dBm}$.

802.11ac (VHT80)

Channel	Frequency (MHz)	Maximum Conducted Power (mW)	Maximum Conducted Power (dBm)	Power Limit (dBm)	Pass / Fail
42	5210	15.776	11.98	24	Pass
58	5290	15.885	12.01	24	Pass
106	5530	16.032	12.05	24	Pass
122	5610	16.444	12.16	24	Pass
138	5690 (U-NII-2C)	15.922	12.02	24	Pass
138	5690 (U-NII-3)	15.922	12.02	30	Pass
155	5775	14.997	11.76	30	Pass

Note:

For U-NII-2A, U-NII-2C Band:

1. $11 \text{ dBm} + 10\log (84.36) = 30.26 \text{ dBm} > 24 \text{ dBm}$.
2. $11 \text{ dBm} + 10\log (84.84) = 30.28 \text{ dBm} > 24 \text{ dBm}$.
3. $11 \text{ dBm} + 10\log (85.03) = 30.29 \text{ dBm} > 24 \text{ dBm}$.
4. $11 \text{ dBm} + 10\log (77.14) = 29.87 \text{ dBm} > 24 \text{ dBm}$.

26 dB Bandwidth:
802.11a

Channel	Frequency (MHz)	26 dBc Bandwidth (MHz)
36	5180	22.47
40	5200	22.45
48	5240	22.52
52	5260	22.31
60	5300	22.61
64	5320	22.25
100	5500	22.51
116	5580	22.40
140	5700	22.17
144	5720 (U-NII-2C)	16.30
144	5720 (U-NII-3)	6.19

802.11n (HT20)

Channel	Frequency (MHz)	26 dBc Bandwidth (MHz)
36	5180	22.90
40	5200	22.43
48	5240	22.53
52	5260	22.78
60	5300	22.70
64	5320	22.80
100	5500	22.73
116	5580	22.41
140	5700	23.01
144	5720 (U-NII-2C)	16.55
144	5720 (U-NII-3)	6.23

802.11n (HT40)

Channel	Frequency (MHz)	26 dBc Bandwidth (MHz)
38	5190	45.86
46	5230	45.16
54	5270	45.62
62	5310	45.66
102	5510	45.66
110	5550	45.75
134	5670	46.06
142	5710 (U-NII-2C)	38.02
142	5710 (U-NII-3)	7.89

802.11ac (VHT80)

Channel	Frequency (MHz)	26 dBc Bandwidth (MHz)
42	5210	85.08
58	5290	84.36
106	5530	84.84
122	5610	85.03
138	5690 (U-NII-2C)	77.14
138	5690 (U-NII-3)	7.86

Spectrum Plot of Worst Value

802.11a

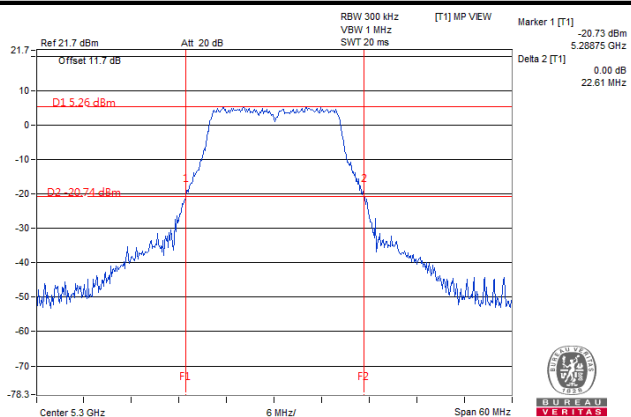

802.11n (HT20)

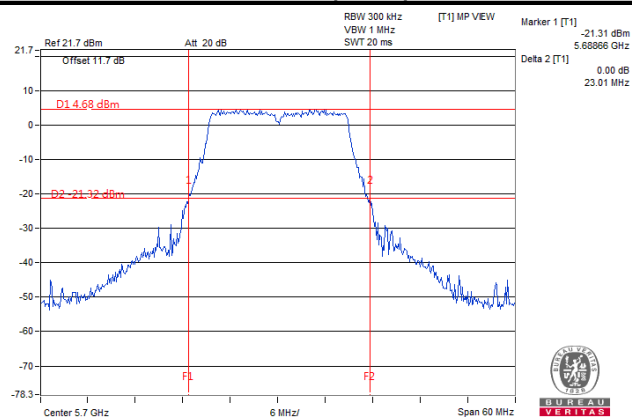

802.11n (HT40)

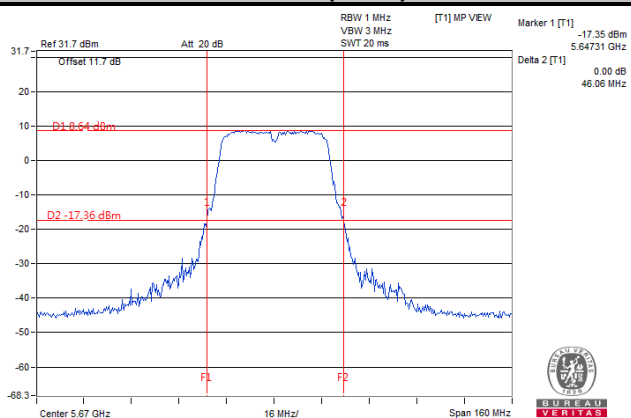

802.11ac (VHT80)

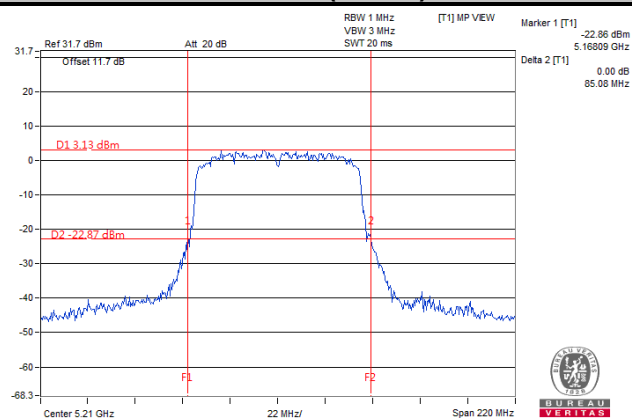

4.4 Occupied Bandwidth Measurement

4.4.1 Test Setup

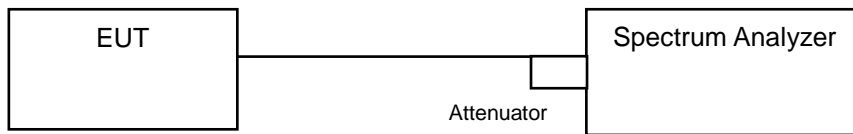

4.4.2 Test Instruments

Refer to section 4.1.2 to get information of above instrument.

4.4.3 Test Procedure

The transmitter output was connected to the spectrum analyzer through an attenuator. The bandwidth of the fundamental frequency was measured by spectrum analyzer with resolution bandwidth in the range of 1 % to 5 % of the anticipated emission bandwidth, and a video bandwidth at least 3x the resolution bandwidth and set the detector to SAMPLE. The width of a frequency band such that, below the lower and above the upper frequency limits, the mean powers emitted are each equal to a specified percentage 0.5 % of the total mean power of a given emission.

4.4.4 Test Results

802.11a

Channel	Channel Frequency (MHz)	Occupied Bandwidth (MHz)
36	5180	16.80
40	5200	17.04
48	5240	16.92
52	5260	17.04
60	5300	16.92
64	5320	17.04
100	5500	17.16
116	5580	17.16
140	5700	17.04
144	5720 (U-NII-2C)	13.28
144	5720 (U-NII-3)	3.28
149	5745	16.83
157	5785	17.02
165	5825	16.92

802.11n (HT20)

Channel	Channel Frequency (MHz)	Occupied Bandwidth (MHz)
36	5180	18.00
40	5200	18.00
48	5240	18.00
52	5260	17.88
60	5300	18.00
64	5320	18.00
100	5500	18.12
116	5580	18.00
140	5700	18.00
144	5720 (U-NII-2C)	13.88
144	5720 (U-NII-3)	3.88
149	5745	17.88
157	5785	18.08
165	5825	17.98

802.11n (HT40)

Channel	Channel Frequency (MHz)	Occupied Bandwidth (MHz)
38	5190	36.48
46	5230	36.48
54	5270	36.60
62	5310	36.24
102	5510	36.36
110	5550	36.48
134	5670	36.36
142	5710 (U-NII-2C)	33.24
142	5710 (U-NII-3)	3.24
151	5755	36.48
159	5795	36.36

802.11ac (VHT80)

Channel	Channel Frequency (MHz)	Occupied Bandwidth (MHz)
42	5210	75.12
58	5290	74.88
106	5530	74.88
122	5610	74.88
138	5690 (U-NII-2C)	72.44
138	5690 (U-NII-3)	2.20
155	5775	74.81

Spectrum Plot of Worst Value

802.11a

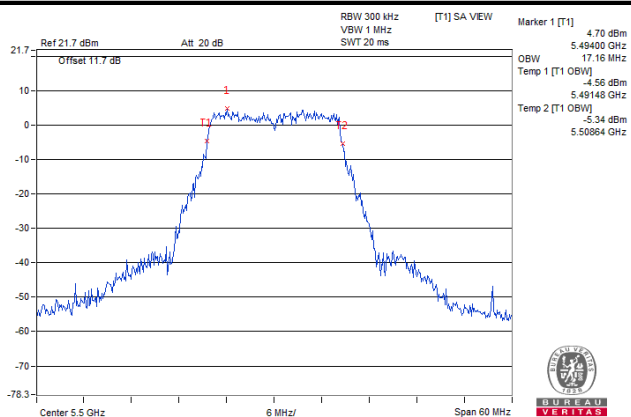

802.11n (HT20)

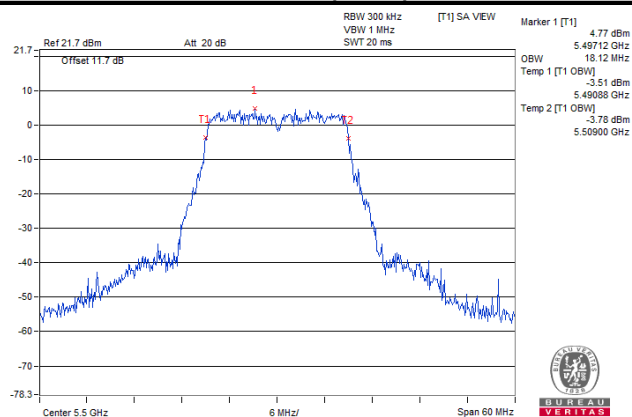

802.11n (HT40)

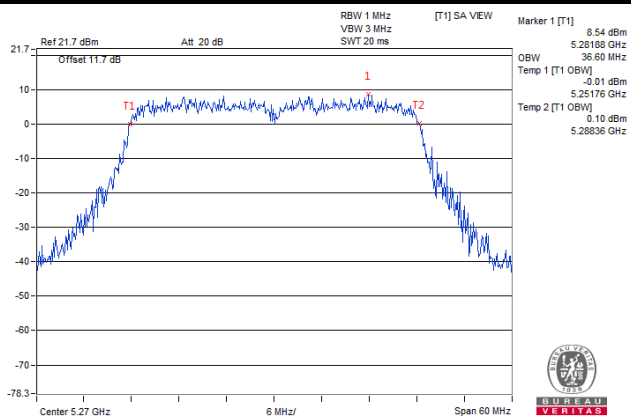

802.11ac (VHT80)

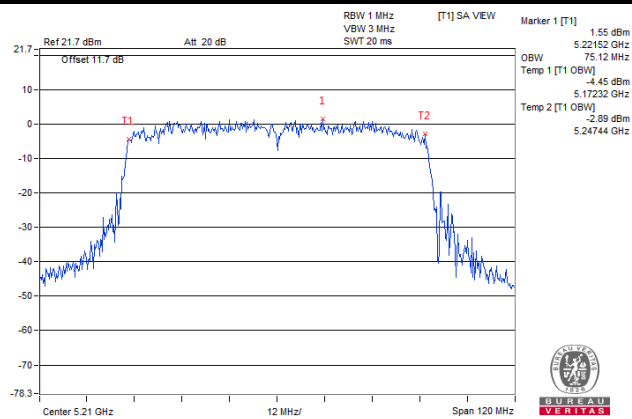

4.5 Peak Power Spectral Density Measurement

4.5.1 Limits of Peak Power Spectral Density Measurement

Operation Band	EUT Category		Limit
U-NII-1		Outdoor Access Point	17 dBm/MHz
		Fixed point-to-point Access Point	
		Indoor Access Point	
	√	Mobile and Portable client device	11 dBm/MHz
U-NII-2A		√	11 dBm/MHz
U-NII-2C		√	11 dBm/MHz
U-NII-3		√	30 dBm/500 kHz

4.5.2 Test Setup

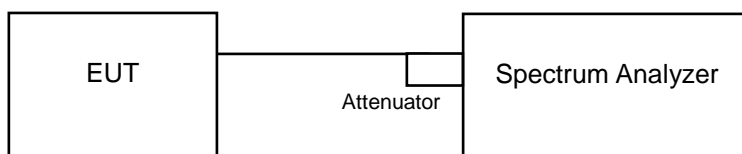

4.5.3 Test Instruments

Refer to section 4.1.3 to get information of above instrument.

4.5.4 Test Procedures

For U-NII-1, U-NII-2A, U-NII-2C band:

Using method SA-2

1. Set span to encompass the entire emission bandwidth (EBW) of the signal.
2. Set RBW = 1 MHz, Set VBW \geq 3 RBW, Detector = RMS
3. Sweep time = auto, trigger set to "free run".
4. Trace average at least 100 traces in power averaging mode.
5. Record the max value and add 10 log (1/duty cycle)

※For U-NII-3:

1. Set span to encompass the entire emission bandwidth (EBW) of the signal.
2. Set RBW = 300 kHz, Set VBW \geq 3 RBW, Detector = RMS
3. Use the peak marker function to determine the maximum power level in any 500 kHz band segment within the fundamental EBW.
4. Scale the observed power level to an equivalent value in 500 kHz by adjusting (reducing) the measured power by a bandwidth correction factor (BWCF) where $BWCF = 10\log(500 \text{ kHz}/300 \text{ kHz})$
5. Sweep time = auto, trigger set to "free run".
6. Trace average at least 100 traces in power averaging mode.
7. Record the max value and add 10 log (1/duty cycle)

4.5.5 Deviation from Test Standard

No deviation.

4.5.6 EUT Operating Conditions

The software provided by client to enable the EUT under transmission condition continuously at lowest, middle and highest channel frequencies individually.

4.5.7 Test Results

For U-NII-1, U-NII-2A, U-NII-2C Band

802.11a

Channel	Frequency (MHz)	PSD w/o Duty Factor (dBm/MHz)	Duty Factor (dB)	PSD with Duty Factor (dBm/MHz)	Maximum Limit (dBm/MHz)	Pass / Fail
36	5180	-0.34	0.59	0.25	11	Pass
40	5200	-0.49	0.59	0.10	11	Pass
48	5240	-0.71	0.59	-0.11	11	Pass
52	5260	-0.56	0.59	0.03	11	Pass
60	5300	-0.63	0.59	-0.03	11	Pass
64	5320	-0.60	0.59	0.00	11	Pass
100	5500	-0.63	0.59	-0.03	11	Pass
116	5580	-0.31	0.59	0.28	11	Pass
140	5700	-0.06	0.59	0.54	11	Pass
144	5720 (U-NII-2C)	-0.79	0.59	-0.19	11	Pass

Note: Refer to section 3.3 for duty cycle spectrum plot.

802.11n (HT20)

Channel	Frequency (MHz)	PSD w/o Duty Factor (dBm/MHz)	Duty Factor (dB)	PSD with Duty Factor (dBm/MHz)	Maximum Limit (dBm/MHz)	Pass / Fail
36	5180	-0.60	0.64	0.04	11	Pass
40	5200	-0.50	0.64	0.14	11	Pass
48	5240	-0.61	0.64	0.03	11	Pass
52	5260	-0.66	0.64	-0.03	11	Pass
60	5300	-0.54	0.64	0.09	11	Pass
64	5320	-0.52	0.64	0.12	11	Pass
100	5500	-0.50	0.64	0.14	11	Pass
116	5580	-0.64	0.64	-0.01	11	Pass
140	5700	-0.69	0.64	-0.06	11	Pass
144	5720 (U-NII-2C)	-0.87	0.64	-0.24	11	Pass

Note: Refer to section 3.3 for duty cycle spectrum plot.

802.11n (HT40)

Channel	Frequency (MHz)	PSD w/o Duty Factor (dBm/MHz)	Duty Factor (dB)	PSD with Duty Factor (dBm/MHz)	Maximum Limit (dBm/MHz)	Pass / Fail
38	5190	-3.16	1.22	-1.94	11	Pass
46	5230	-3.20	1.22	-1.98	11	Pass
54	5270	-3.49	1.22	-2.27	11	Pass
62	5310	-3.61	1.22	-2.39	11	Pass
102	5510	-3.47	1.22	-2.25	11	Pass
110	5550	-3.72	1.22	-2.50	11	Pass
134	5670	-3.64	1.22	-2.42	11	Pass
142	5710 (U-NII-2C)	-3.90	1.22	-2.68	11	Pass

Note: Refer to section 3.3 for duty cycle spectrum plot.

802.11ac (VHT80)

Channel	Frequency (MHz)	PSD w/o Duty Factor (dBm/MHz)	Duty Factor (dB)	PSD with Duty Factor (dBm/MHz)	Maximum Limit (dBm/MHz)	Pass / Fail
42	5210	-10.86	2.76	-8.11	11	Pass
58	5290	-10.60	2.76	-7.84	11	Pass
106	5530	-10.49	2.76	-7.73	11	Pass
122	5610	-10.82	2.76	-8.06	11	Pass
138	5690 (U-NII-2C)	-10.45	2.76	-7.69	11	Pass

Note: Refer to section 3.3 for duty cycle spectrum plot.

Spectrum Plot of Worst Value

802.11a

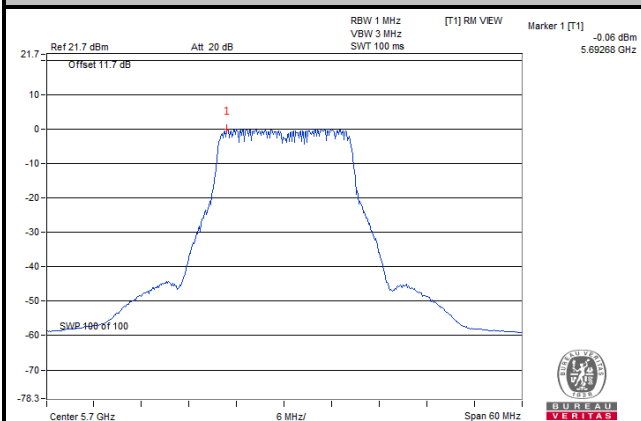

802.11n (HT20)

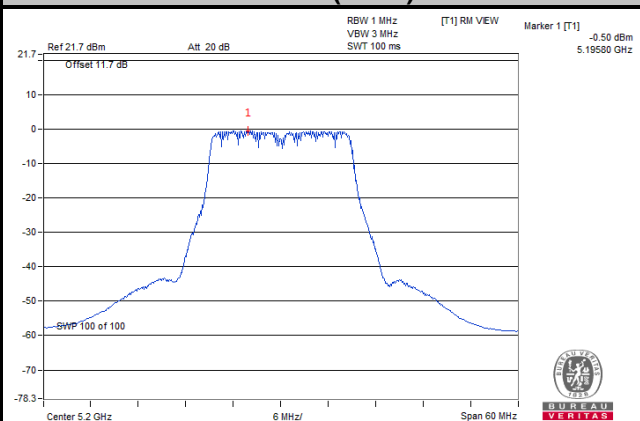

802.11n (HT40)

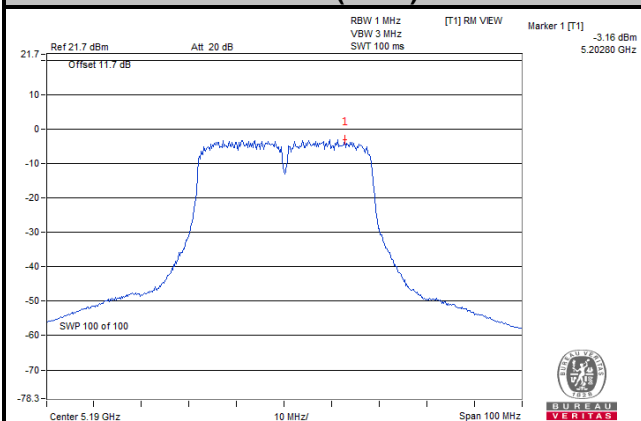

802.11ac (VHT80)

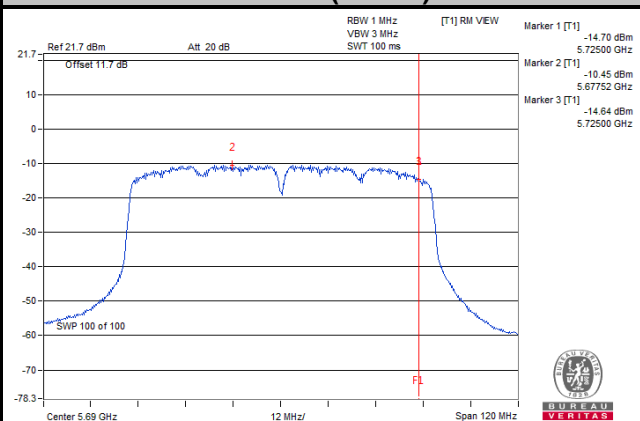

For U-NII-3 Band

802.11a

Channel	Frequency (MHz)	PSD w/o Duty Factor (dBm/300 kHz)	PSD w/o Duty Factor (dBm/500 kHz)	Duty Factor (dB)	PSD with Duty Factor (dBm/500 kHz)	Limit (dBm/500 kHz)	Pass / Fail
144	5720 (U-NII-3)	-8.16	-5.94	0.59	-5.35	30	Pass
149	5745	-8.01	-5.79	0.59	-5.20	30	Pass
157	5785	-8.37	-6.15	0.59	-5.56	30	Pass
165	5825	-8.62	-6.40	0.59	-5.81	30	Pass

Note: Refer to section 3.3 for duty cycle spectrum plot.

802.11n (HT20)

Channel	Frequency (MHz)	PSD w/o Duty Factor (dBm/300 kHz)	PSD w/o Duty Factor (dBm/500 kHz)	Duty Factor (dB)	PSD with Duty Factor (dBm/500 kHz)	Limit (dBm/500 kHz)	Pass / Fail
144	5720 (U-NII-3)	-8.12	-5.90	0.64	-5.26	30	Pass
149	5745	-8.51	-6.29	0.64	-5.65	30	Pass
157	5785	-8.43	-6.21	0.64	-5.57	30	Pass
165	5825	-9.11	-6.89	0.64	-6.25	30	Pass

Note: Refer to section 3.3 for duty cycle spectrum plot.

802.11n (HT40)

Channel	Frequency (MHz)	PSD w/o Duty Factor (dBm/300 kHz)	PSD w/o Duty Factor (dBm/500 kHz)	Duty Factor (dB)	PSD with Duty Factor (dBm/500 kHz)	Limit (dBm/500 kHz)	Pass / Fail
142	5710 (U-NII-3)	-13.35	-11.13	1.22	-9.91	30	Pass
151	5755	-12.31	-10.09	1.22	-8.87	30	Pass
159	5795	-12.32	-10.10	1.22	-8.88	30	Pass

Note: Refer to section 3.3 for duty cycle spectrum plot.

802.11ac (VHT80)

Channel	Frequency (MHz)	PSD w/o Duty Factor (dBm/300 kHz)	PSD w/o Duty Factor (dBm/500 kHz)	Duty Factor (dB)	PSD with Duty Factor (dBm/500 kHz)	Limit (dBm/500 kHz)	Pass / Fail
138	5690 (U-NII-3)	-18.28	-16.06	2.76	-13.30	30	Pass
155	5775	-19.25	-17.03	2.76	-14.27	30	Pass

Note: Refer to section 3.3 for duty cycle spectrum plot.

Spectrum Plot of Worst Value

802.11a

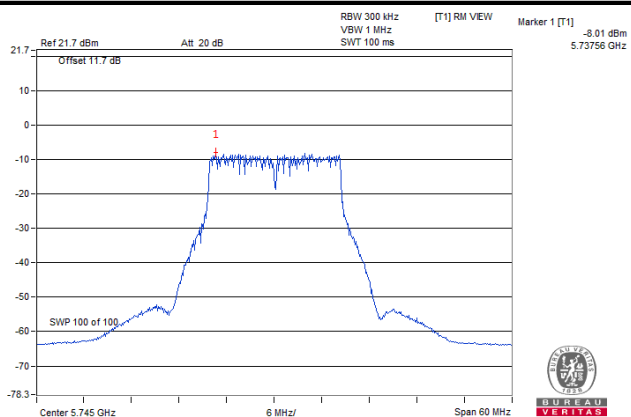

802.11n (HT20)

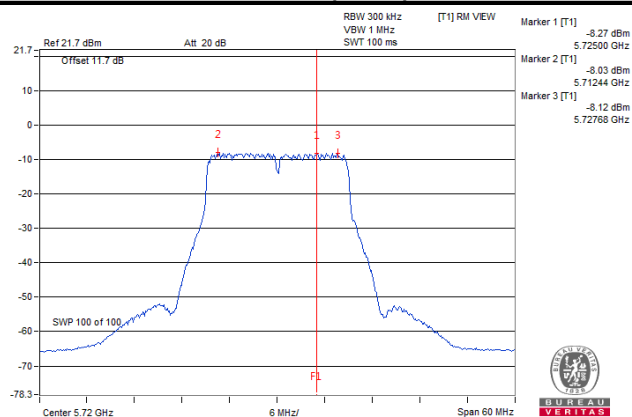

802.11n (HT40)

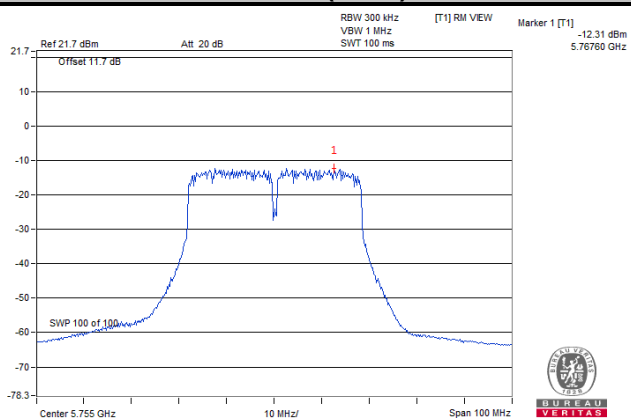

802.11ac (VHT80)

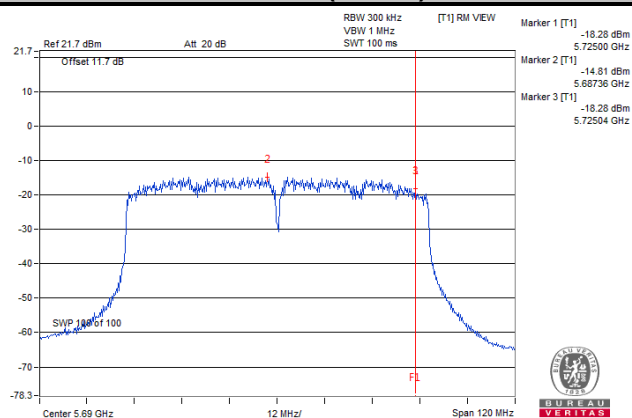

4.6 Frequency Stability

4.6.1 Limit of Frequency Stability Measurement

The frequency of the carrier signal shall be maintained within band of operation.

4.6.2 Test Setup

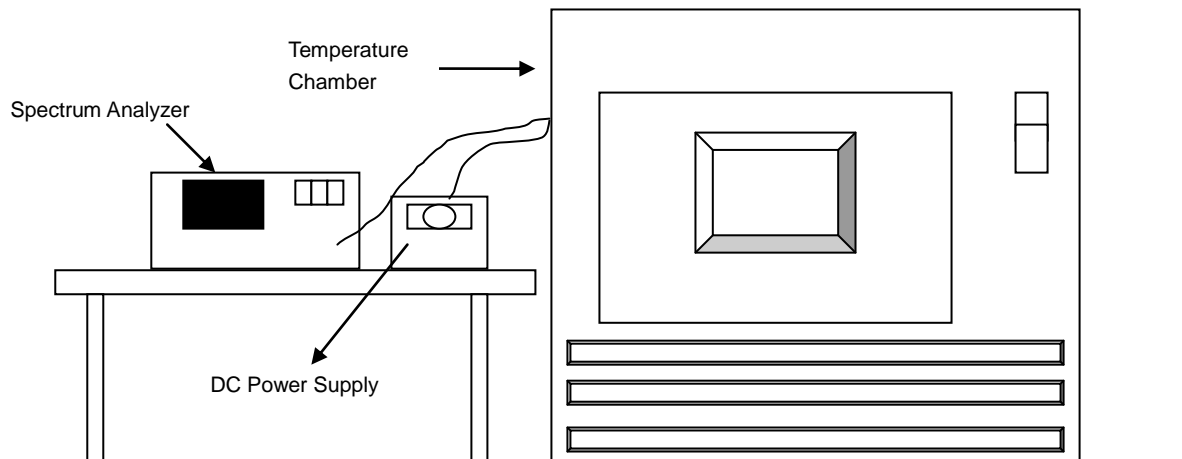

4.6.3 Test Instruments

Refer to section 4.1.3 to get information of above instrument.

4.6.4 Test Procedure

- To ensure emission at the band edge is maintained within the authorized band, those values shall be measured by radiation emissions at upper and lower frequency points, and finally compensated by frequency deviation as procedures below.
- The EUT was operated at the maximum output power, and connected to the spectrum analyzer, which is set to maximum hold function and peak detector. The peak value of the power envelope was measured and noted. The upper and lower frequency points were respectively measured relatively 10 dB lower than the measured peak value.
- The frequency deviation was calculated by adding the upper frequency point and the lower frequency point divided by two. Those detailed values of frequency deviation are provided in table below.

4.6.5 Deviation from Test Standard

No deviation.

4.6.6 EUT Operating Condition

Set the EUT transmit at un-modulation mode to test frequency stability.

4.6.7 Test Results

Frequency Stability Versus Temp.									
Operating Frequency: 5180 MHz									
Temp. (°C)	Power Supply (Vdc)	0 Minute		2 Minute		5 Minute		10 Minute	
		Measured Frequency (MHz)	Frequency Drift (ppm)	Measured Frequency (MHz)	Frequency Drift (ppm)	Measured Frequency (MHz)	Frequency Drift (ppm)	Measured Frequency (MHz)	Frequency Drift (ppm)
50	3.85	5179.9933	-0.00013	5179.9947	-0.00010	5179.9939	-0.00012	5179.9948	-0.00010
40	3.85	5180.0142	0.00027	5180.0131	0.00025	5180.0155	0.00030	5180.0155	0.00030
30	3.85	5180.025	0.00048	5180.0227	0.00044	5180.0223	0.00043	5180.0256	0.00049
20	3.85	5179.9846	-0.00030	5179.9846	-0.00030	5179.9822	-0.00034	5179.9838	-0.00031
10	3.85	5179.9975	-0.00005	5179.998	-0.00004	5179.9976	-0.00005	5179.9991	-0.00002
0	3.85	5180.0104	0.00020	5180.0073	0.00014	5180.0075	0.00014	5180.0079	0.00015
-10	3.85	5180.0155	0.00030	5180.0149	0.00029	5180.0114	0.00022	5180.0125	0.00024
-20	3.85	5180.0054	0.00010	5180.0013	0.00003	5180.0042	0.00008	5180.0055	0.00011
-30	3.85	5179.9775	-0.00043	5179.9763	-0.00046	5179.9808	-0.00037	5179.9784	-0.00042

Frequency Stability Versus Temp.									
Operating Frequency: 5180 MHz									
Temp. (°C)	Power Supply (Vdc)	0 Minute		2 Minute		5 Minute		10 Minute	
		Measured Frequency (MHz)	Frequency Drift (ppm)	Measured Frequency (MHz)	Frequency Drift (ppm)	Measured Frequency (MHz)	Frequency Drift (ppm)	Measured Frequency (MHz)	Frequency Drift (ppm)
20	4.4	5179.9843	-0.00030	5179.9854	-0.00028	5179.9821	-0.00035	5179.9831	-0.00033
	3.85	5179.9846	-0.00030	5179.9846	-0.00030	5179.9822	-0.00034	5179.9838	-0.00031
	3.6	5179.9843	-0.00030	5179.9844	-0.00030	5179.983	-0.00033	5179.9829	-0.00033

4.7 6 dB Bandwidth Measurement

4.7.1 Limits of 6 dB Bandwidth Measurement

The minimum of 6 dB Bandwidth Measurement is 0.5 MHz.

4.7.2 Test Setup

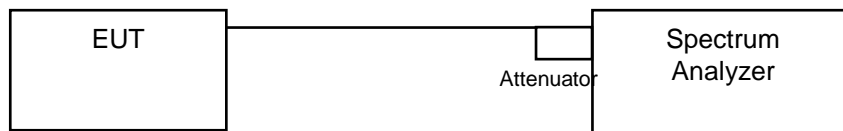

4.7.3 Test Instruments

Refer to section 4.1.3 to get information of above instrument.

4.7.4 Test Procedure

MEASUREMENT PROCEDURE REF

- Set resolution bandwidth (RBW) = 100 kHz
- Set the video bandwidth (VBW) $\geq 3 \times$ RBW, Detector = Peak.
- Trace mode = max hold.
- Sweep = auto couple.
- Measure the maximum width of the emission that is constrained by the frequencies associated with the two amplitude points (upper and lower) that are attenuated by 6 dB relative to the maximum level measured in the fundamental emission

4.7.5 Deviation from Test Standard

No deviation.

4.7.6 EUT Operating Condition

The software provided by client to enable the EUT under transmission condition continuously at lowest, middle and highest channel frequencies individually.

4.7.7 Test Results

802.11a

Channel	Frequency (MHz)	6 dB Bandwidth (MHz)	Minimum Limit (MHz)	Pass / Fail
144	5720 (U-NII-3)	3.28	0.5	Pass
149	5745	16.43	0.5	Pass
157	5785	16.43	0.5	Pass
165	5825	16.49	0.5	Pass

802.11n (HT20)

Channel	Frequency (MHz)	6 dB Bandwidth (MHz)	Minimum Limit (MHz)	Pass / Fail
144	5720 (U-NII-3)	3.87	0.5	Pass
149	5745	17.66	0.5	Pass
157	5785	17.64	0.5	Pass
165	5825	17.64	0.5	Pass

802.11n (HT40)

Channel	Frequency (MHz)	6 dB Bandwidth (MHz)	Minimum Limit (MHz)	Pass / Fail
142	5710 (U-NII-3)	2.72	0.5	Pass
151	5755	35.36	0.5	Pass
159	5795	35.34	0.5	Pass

802.11ac (VHT80)

Channel	Frequency (MHz)	6 dB Bandwidth (MHz)	Minimum Limit (MHz)	Pass / Fail
138	5690 (U-NII-3)	2.62	0.5	Pass
155	5775	75.25	0.5	Pass

Spectrum Plot of Worst Value

802.11a

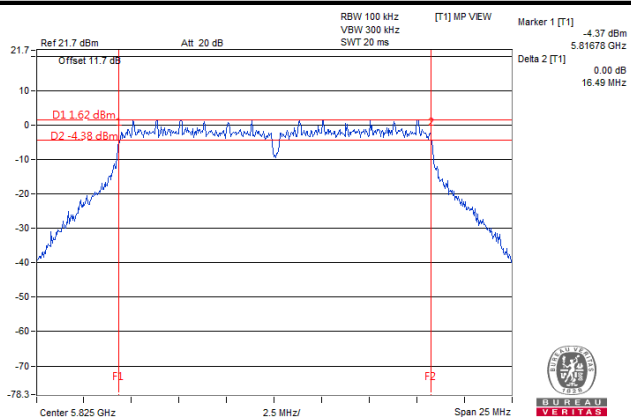

802.11n (HT20)

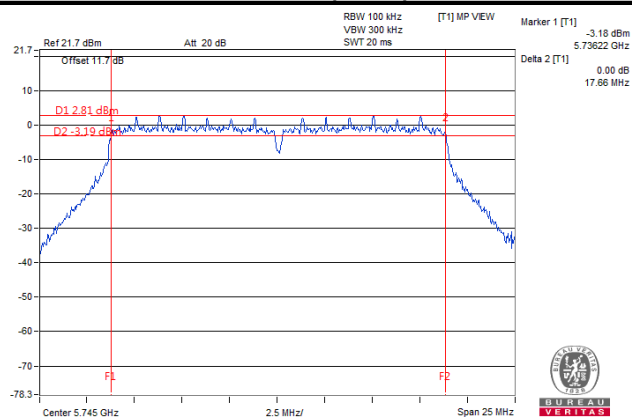

802.11n (HT40)

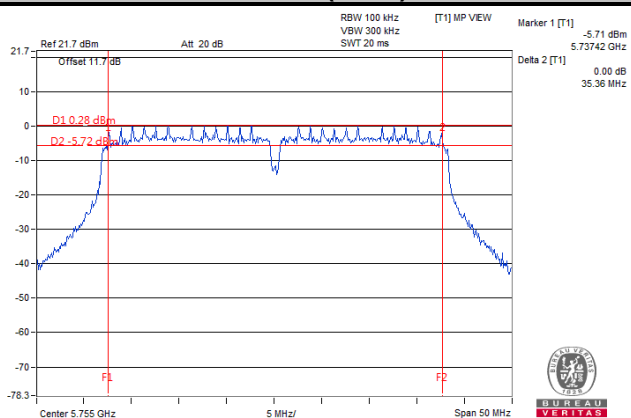

802.11ac (VHT80)

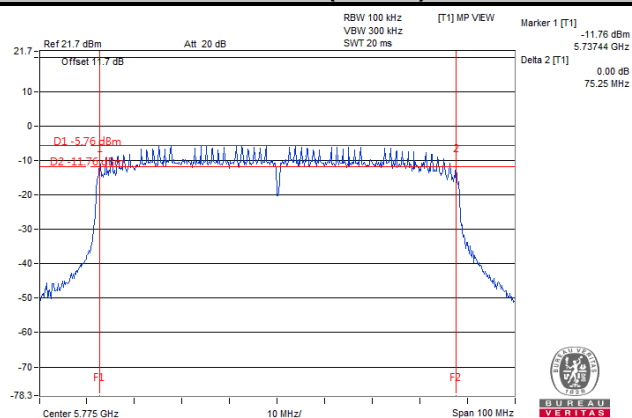

5 Pictures of Test Arrangements

Please refer to the attached file (Test Setup Photo).

Annex A- Radiated Out of Band Emision (OOBE) Measurement (For U-NII-3 band)

802.11a

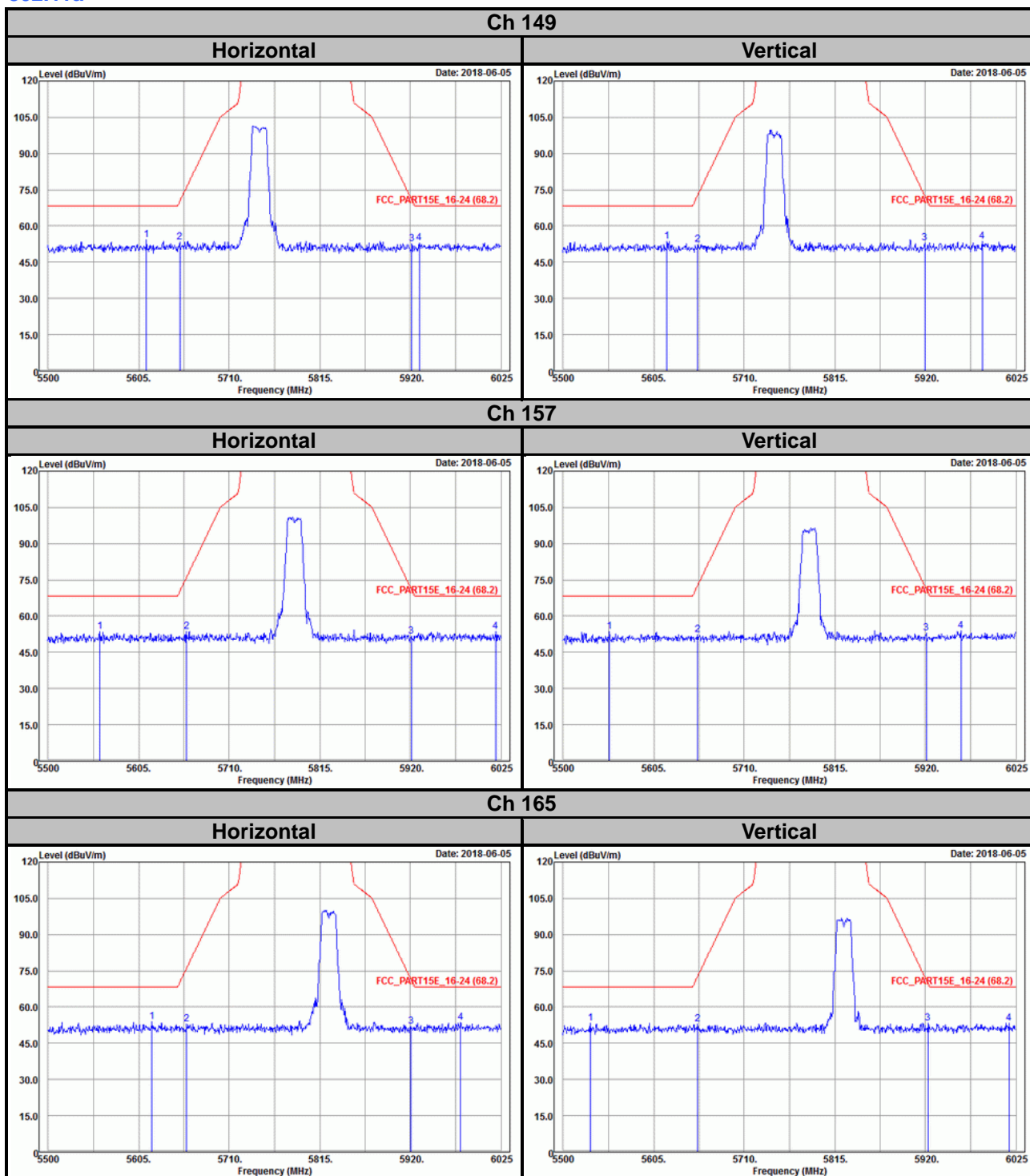

802.11n (HT20)

Ch 149

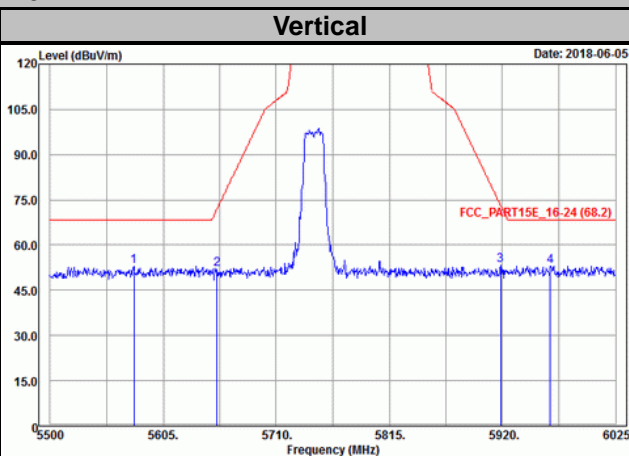
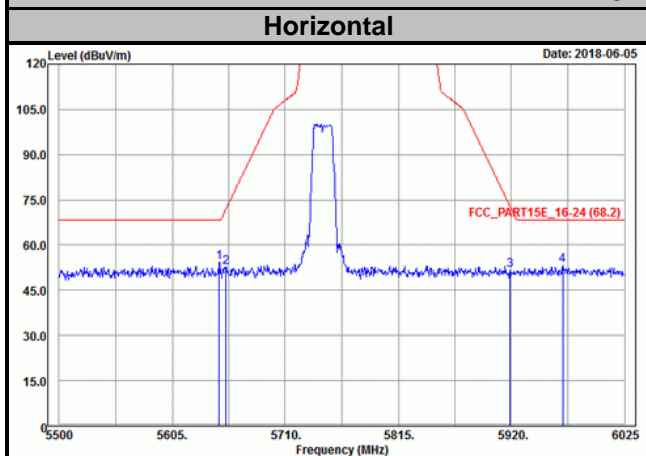

Ch 157

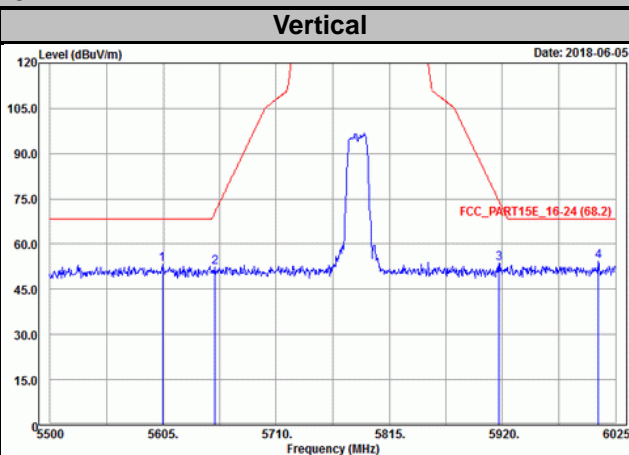
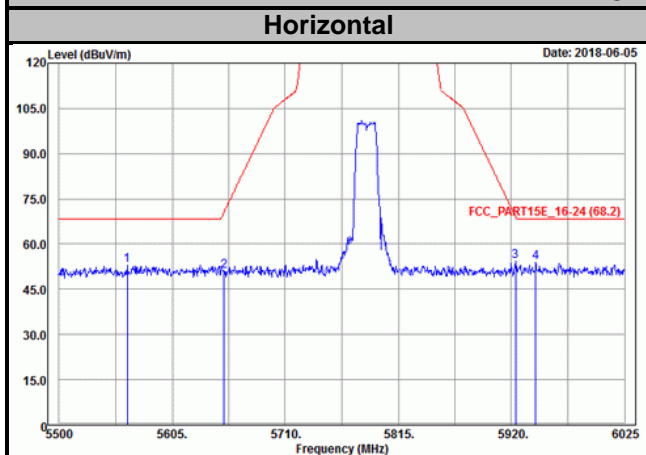

Ch 165

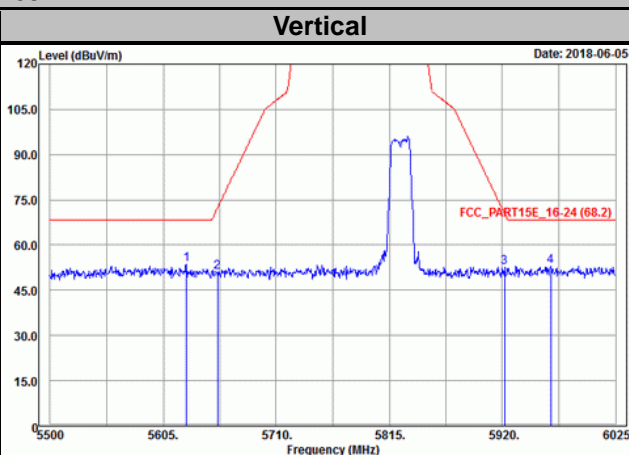
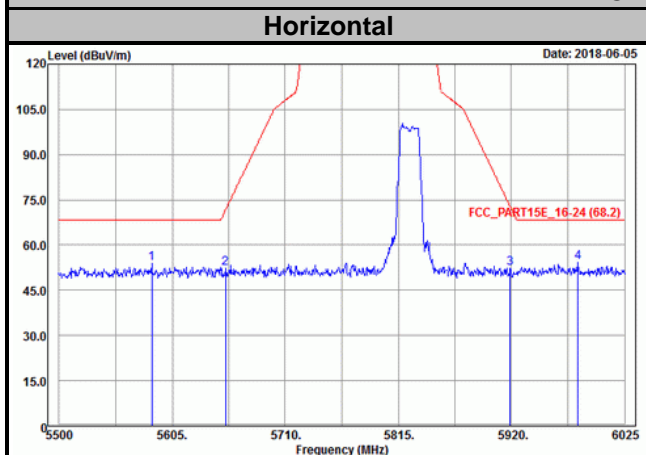

802.11n (HT40)

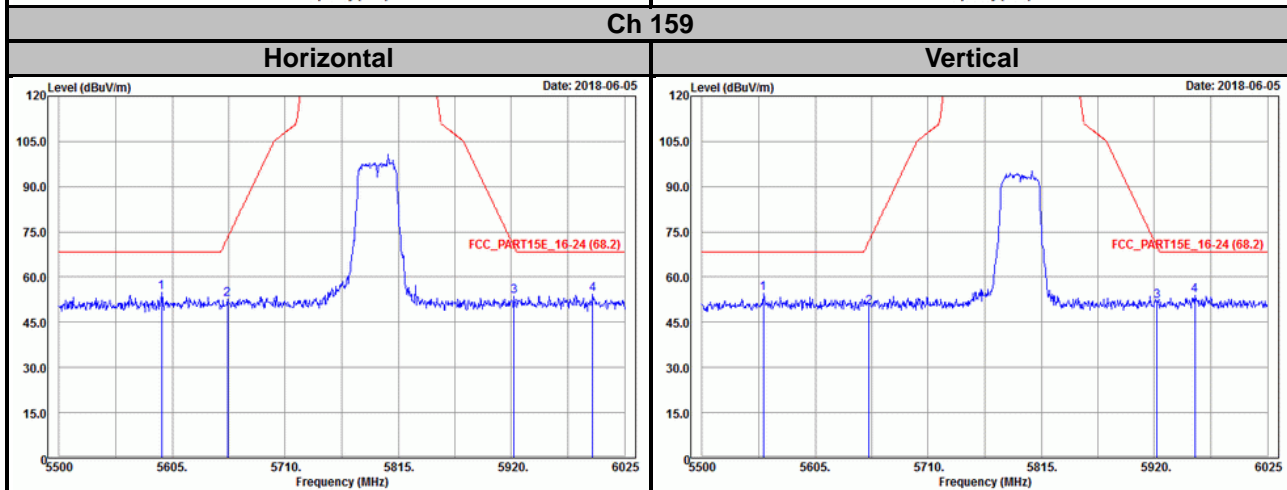
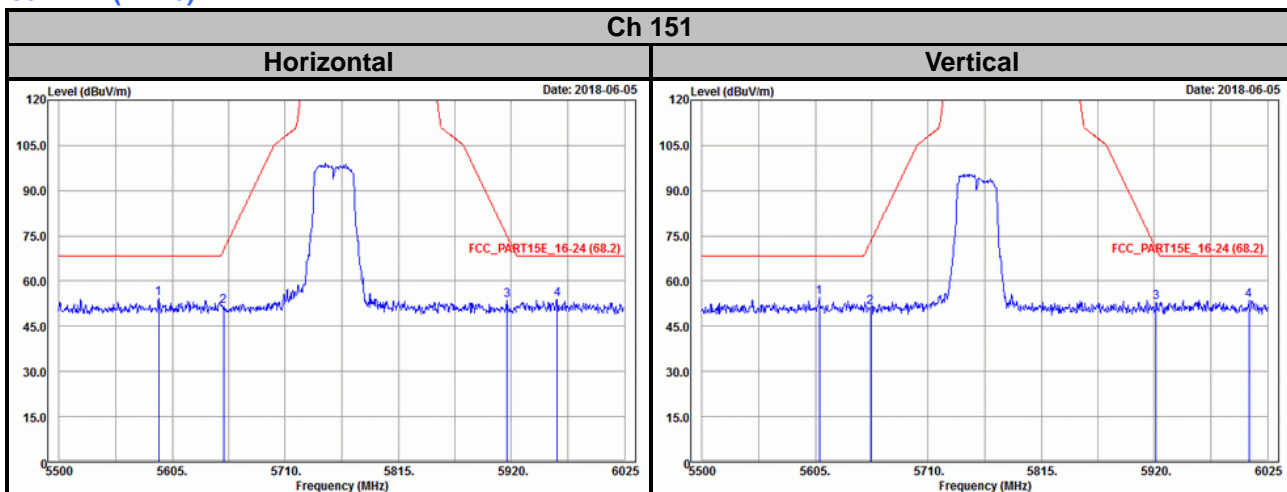

802.11ac (VHT80)

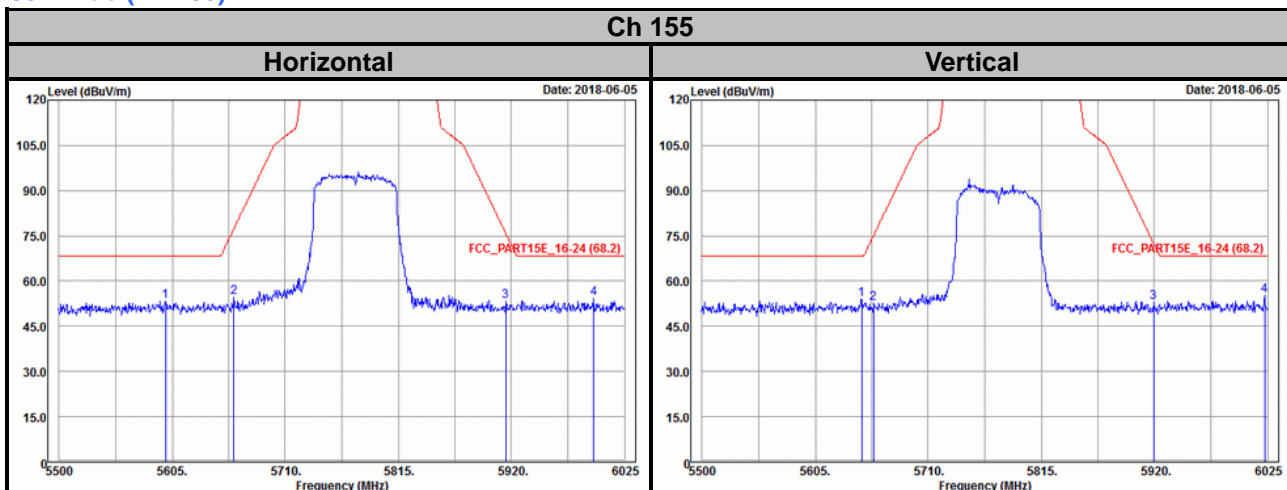

Appendix – Information on the Testing Laboratories

We, Bureau Veritas Consumer Products Services (H.K.) Ltd., Taoyuan Branch, were founded in 1988 to provide our best service in EMC, Radio, Telecom and Safety consultation. Our laboratories are FCC recognized accredited test firms and accredited according to ISO/IEC 17025.

If you have any comments, please feel free to contact us at the following:

Linko EMC/RF Lab

Tel: 886-2-26052180

Fax: 886-2-26051924

Hsin Chu EMC/RF/Telecom Lab

Tel: 886-3-6668565

Fax: 886-3-6668323

Hwa Ya EMC/RF/Safety

Tel: 886-3-3183232

Fax: 886-3-3270892

Email: service.adt@tw.bureauveritas.com

Web Site: www.bureauveritas-adt.com

The address and road map of all our labs can be found in our web site also.

--- END ---