



TEST REPORT

No. I17D00058-SAR01

For

Client: Lenovo (Shanghai) Electronics

Technology Co., Ltd

Production: Portable Tablet Computer

Brand : Lenovo

Model Name: TB-X704V

Standard: ANSI C95.1-1999

FCC 47 CFR Part 2 (2.1093)

RSS 102 issue 5

FCC ID: O57TBX704V

IC: 10407A-TBX704V

Hardware Version: Lenovo Tablet TB-X704V

Software Version: TB-X704V_RF01_20170301

Issued date: 2017-7-20

Note:

The test results in this test report relate only to the devices specified in this report. This report shall not be reproduced except in full without the written approval of ECIT Shanghai.

Test Laboratory:

ECIT Shanghai, East China Institute of Telecommunications

Add: 7-8F, G Area, No.668, Beijing East Road, Huangpu District, Shanghai, P. R. China

Tel: (+86)-021-63843300, E-Mail: welcome@ecit.org.cn

Revision Version

| Report Number | Revision | Date | Memo |
|----------------------|-----------------|-------------|---------------------------------|
| I17D00058-SAR01 | 00 | 2017-6-16 | Initial creation of test report |
| I17D00058-SAR01 | 01 | 2017-6-21 | Second creation of test report |
| I17D00058-SAR01 | 02 | 2017-6-23 | Third creation of test report |
| I17D00058-SAR01 | 03 | 2017-6-30 | Fourth creation of test report |
| I17D00058-SAR01 | 04 | 2017-7-20 | Fifth creation of test report |

CONTENTS

| | | |
|------|---|----|
| 1. | TEST LABORATORY | 7 |
| 1.1. | TESTING LOCATION | 7 |
| 1.2. | TESTING ENVIRONMENT | 7 |
| 1.3. | PROJECT DATA..... | 7 |
| 1.4. | SIGNATURE | 7 |
| 2. | STATEMENT OF COMPLIANCE | 8 |
| 3. | CLIENT INFORMATION..... | 10 |
| 3.1. | APPLICANT INFORMATION | 10 |
| 3.2. | MANUFACTURER INFORMATION | 10 |
| 4. | EQUIPMENT UNDER TEST (EUT) AND ANCILLARY EQUIPMENT (AE) | 11 |
| 4.1. | ABOUT EUT | 11 |
| 4.2. | INTERNAL IDENTIFICATION OF EUT USED DURING THE TEST..... | 12 |
| 4.3. | INTERNAL IDENTIFICATION OF AE USED DURING THE TEST | 12 |
| 5. | TEST METHODOLOGY | 13 |
| 5.1. | APPLICABLE LIMIT REGULATIONS | 13 |
| 5.2. | APPLICABLE MEASUREMENT STANDARDS | 13 |
| 6. | SPECIFIC ABSORPTION RATE (SAR)..... | 14 |
| 6.1. | INTRODUCTION..... | 14 |
| 6.2. | SAR DEFINITION | 14 |
| 7. | TISSUE SIMULATING LIQUIDS | 15 |
| 7.1. | TARGETS FOR TISSUE SIMULATING LIQUID..... | 15 |
| 7.2. | DIELECTRIC PERFORMANCE | 15 |
| 8. | SYSTEM VERIFICATION | 16 |
| 8.1. | SYSTEM SETUP | 16 |
| 8.2. | SYSTEM VERIFICATION | 17 |
| 9. | MEASUREMENT PROCEDURES | 18 |

| | |
|--|----|
| 9.1. TESTS TO BE PERFORMED | 18 |
| 9.2. GENERAL MEASUREMENT PROCEDURE | 19 |
| 9.3. WCDMA MEASUREMENT PROCEDURES FOR SAR..... | 20 |
| 9.4. SAR MEASUREMENT FOR LTE..... | 21 |
| 9.5. BLUETOOTH & WI-FI MEASUREMENT PROCEDURES FOR SAR..... | 22 |
| 9.6. POWER DRIFT | 23 |
| 10. AREA SCAN BASED 1-G SAR | 24 |
| 11. CONDUCTED OUTPUT POWER | 25 |
| 11.1. MANUFACTURING TOLERANCE..... | 25 |
| 11.2. WCDMA MEASUREMENT RESULT | 29 |
| 11.3. LTE MEASUREMENT RESULT | 31 |
| 11.4. LTE CARRIER AGGREGATION | 50 |
| 11.5. WI-FI AND BT MEASUREMENT RESULT | 52 |
| 12. SIMULTANEOUS TX SAR CONSIDERATIONS..... | 56 |
| 12.1. INTRODUCTION..... | 56 |
| 12.2. TRANSMIT ANTENNA SEPARATION DISTANCES | 56 |
| 12.3. STANDALONE SAR TEST EXCLUSION CONSIDERATIONS | 57 |
| 12.4. SAR MEASUREMENT POSITIONS | 58 |
| 13. POWER REDUCTION BY PROXIMITY SENSING..... | 59 |
| 13.1. PROCEDURES FOR DETERMINING PROXIMITY SENSOR TRIGGERING DISTANCES | 59 |
| 13.2. PROCEDURES FOR DETERMINING ANTENNA AND PROXIMITY SENSOR COVERAGE | 60 |
| 13.3. PROXIMITY SENSOR STATUS TABLE OF TRIGGER DISTANCE | 62 |
| 13.4. TILT ANGLE INFLUENCES TO PROXIMITY SENSOR TRIGGERING..... | 64 |
| 13.5. POWER REDUCTION PER AIR-INTERFACE..... | 65 |
| 13.6. PROXIMITY SENSOR COVERAGE AREA | 66 |
| 14. EVALUATION OF SIMULTANEOUS..... | 67 |
| 15. SAR TEST RESULT | 70 |

| | | |
|----------|--|-----|
| 16. | SAR MEASUREMENT VARIABILITY | 83 |
| 17. | MEASUREMENT UNCERTAINTY | 84 |
| 18. | MAIN TEST INSTRUMENT | 86 |
| ANNEX A. | GRAPH RESULTS | 87 |
| ANNEX B. | SYSTEM VALIDATION RESULTS | 119 |
| ANNEX C. | SAR MEASUREMENT SETUP..... | 124 |
| ANNEX D. | POSITION OF THE WIRELESS DEVICE IN RELATION TO THE PHANTOM.... | 133 |
| ANNEX E. | EQUIVALENT MEDIA RECIPES | 137 |
| ANNEX F. | SYSTEM VALIDATION | 138 |
| ANNEX G. | PROBE AND DAE CALIBRATION CERTIFICATE..... | 139 |
| ANNEX H. | ACCREDITATION CERTIFICATE | 216 |

1. Test Laboratory

1.1. Testing Location

| | |
|---|---|
| Company Name: | ECIT Shanghai, East China Institute of Telecommunications |
| Address: | 7-8F, G Area, No. 668, Beijing East Road, Huangpu District, Shanghai, P. R. China |
| Postal Code: | 200001 |
| Telephone: | (+86)-021-63843300 |
| Fax: | (+86)-021-63843301 |
| IC OAT' S Test Site Registration Number | 10766A-1 |

1.2. Testing Environment

| | |
|-----------------------------|--------------|
| Normal Temperature: | 18-25°C |
| Relative Humidity: | 10-90% |
| Ambient noise & Reflection: | < 0.012 W/kg |

1.3. Project Data

| | |
|---------------------|-------------|
| Project Leader: | Chen Minfei |
| Testing Start Date: | 2017-04-27 |
| Testing End Date: | 2017-06-05 |

1.4. Signature

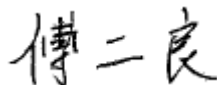

Fu Erliang
(Prepared this test report)



Song Kaihua
(Reviewed this test report)

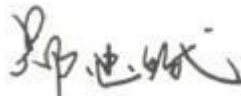

Zheng Zhongbin
Director of the laboratory
(Approved this test report)

2. Statement of Compliance

The maximum results of Specific Absorption Rate (SAR) found during testing for **TB-X704V** are as follows (with expanded uncertainty 22.4%)

Table 2.1: Max. Reported SAR (1g)

| Band | Position | SAR 1g (W/Kg) |
|--------------|----------|---------------|
| WCDMA Band2 | Body | 1.155 |
| WCDMA Band5 | Body | 0.478 |
| LTE Band2 | Body | 0.948 |
| LTE Band4 | Body | 1.023 |
| LTE Band5 | Body | 0.503 |
| LTE Band7 | Body | 1.138 |
| LTE Band12 | Body | 0.758 |
| LTE Band13 | Body | 0.504 |
| Wi-Fi 2.4GHz | Body | 0.370 |
| Wi-Fi 5GHz | Body | 0.341 |

The SAR values found for the Mobile Phone are below the maximum recommended levels of 1.6 W/Kg as averaged over any 1g tissue according to the ANSI C95.1-1999 and RSS 102 issue 5 .

For body worn operation, this device has been tested and meets FCC RF exposure guidelines when used with any accessory that contains no metal. Use of other accessories may not ensure compliance with FCC RF exposure guidelines.

The LTE Band12/13 and Wi-Fi 5GHz test result are reference **TA Technology (Shanghai) Co.,Ltd** and the report No. is **RXA1704-0095SAR**.

The measurement together with the test system set-up is described in chapter 7 of this test report. A detailed description of the equipment under test can be found in chapter 3 of this test report.

The sample has four TX antennas. One is main antenna for WCDMA/LTE Middle, High Band, One is main antenna for WCDMA/LTE Low Band and the other is for WiFi/BT and GPS. So simultaneous transmission is LTE/WCDMA and WiFi/BT.

Table 2.2: Simultaneous SAR (1g)

| Transmission SAR(W/Kg) | | | | | | |
|------------------------|-------------|-------|-------|----------------|-------|-------|
| Test Position | | 3G | 4G | WIFI 2.4GHz | BT | SUM |
| Body 14mm | Ground Side | 1.155 | 1.012 | 0.127 | 0.083 | 1.292 |
| | Right Side | -- | -- | -- | 0.083 | 0.083 |
| | Bottom Side | 0.208 | 0.153 | -- | 0.083 | 0.291 |
| | Top Side | 0.573 | 1.138 | 0.093 | 0.083 | 1.231 |
| Body 0 mm | Ground Side | 1.092 | 1.023 | 0.370 | 0.083 | 1.462 |
| | Right Side | 0.276 | 0.511 | -- | 0.083 | 0.594 |
| | Bottom Side | 0.248 | 0.334 | -- | 0.083 | 0.417 |
| | Top Side | 0.492 | 0.864 | 0.138 | 0.083 | 1.002 |

According to the above table, the maximum sum of reported SAR values for WCDMA/LTE and WiFi is **1.462 W/kg** (1g). The detail for simultaneous transmission consideration is described in chapter 12.

3. Client Information

3.1. Applicant Information

Company Name: Lenovo (Shanghai) Electronics Technology Co., Ltd
Address: NO.68 BUILDING, 199 FENJU RD, Pilot Free Trade Zone, Shanghai,
200131, China
Email: liujl11@lenovo.com

3.2. Manufacturer Information

Company Name: Lenovo PC HK Limited
Address: 23/F, Lincoln House, Taikoo Place 979 King's Road, Quarry Bay, Hong Kong
Email: liujl11@lenovo.com

4. Equipment Under Test (EUT) and Ancillary Equipment (AE)

4.1. About EUT

| | |
|---|---|
| Description: | Portable Tablet Computer |
| Model name: | TB-X704V |
| Operation Model(s): | WCDMA Band II/V LTE Band 2/4/5/7,WIFI2450 |
| Tx Frequency: | 1852.4-1907.6 MHz (WCDMA Band II) 826.4-846.6MHz (WCDMA Band V) 1850MHz -1910 MHz (LTE Band 2) 1710MHz -1755 MHz (LTE Band 4) 824 MHz -849 MHz (LTE Band 5) 2500 MHz - 2570 MHz (LTE Band 7) 2412- 2462 MHz (Wi-Fi) 2400-2483.5 MHz (BT) |
| CA Support: | Downlink only |
| Test device Production information: GPRS/EGPRS Class Mode: GPRS/ EGPRS Multislot Class: | Production unit N/A N/A |
| Device type: | Portable device |
| UE category: | 3 |
| Antenna type: | Inner antenna |
| Accessories/Body-worn configurations: | Headset Battery |
| Dimensions: Hotspot Mode: | 24.5cm×17.5cm×0.8cm Support simultaneous transmission of hotspot and voice (or data) |
| FCC ID: | O57TBX704V |
| IC: | 10407A-TBX704V |
| The device employs proximity sensors that detect the presence of the user's body at the back faces and Top or bottom side of the device. when back body worn and Top or bottom side condition is detected, WCDMA Band II/V;LTE Band 2/4/5/7;WIFI 2.4GHz reduced power will be active. | |

4.2. Internal Identification of EUT used during the test

| EUT ID* | SN or IMEI | HW Version | SW Version | Receive Date |
|---------|-----------------|---------------------------|----------------------------|--------------|
| N05 | 863923030004393 | Lenovo Tablet TB-X704V | TB-X704V_RF01_20170 301 | 2017-3-17 |

*EUT ID: is used to identify the test sample in the lab internally.

4.3. Internal Identification of AE used during the test

| AE ID* | Description | Model | SN | Manufacturer |
|--------|-------------|-------|-----|--------------|
| N/A | N/A | N/A | N/A | N/A |

*AE ID: is used to identify the test sample in the lab internally.

5. TEST METHODOLOGY

5.1. Applicable Limit Regulations

ANSI C95.1–1999: IEEE Standard for Safety Levels with Respect to Human Exposure to Radio Frequency Electromagnetic Fields, 3 kHz to 300 GHz.

FCC 47 CFR Part 2 (2.1093): Radiofrequency radiation exposure evaluation: portable devices.

RSS-102 issue 5: 2015: Radio Frequency (RF) Exposure Compliance of Radio communication Apparatus (All Frequency Bands)

It specifies the maximum exposure limit of **1.6 W/kg** as averaged over any 1 gram of tissue for portable devices being used within 20 cm of the user in the uncontrolled environment.

5.2. Applicable Measurement Standards

IEEE 1528:2013: Recommended Practice for Determining the Peak Spatial-Average Specific Absorption Rate (SAR) in the Human Body Due to Wireless Communications Devices: Experimental Techniques.

IEC62209-2:2010: Human exposure to radiofrequency fields from handheld and body mounted wireless communication devices — Human models, instrumentation, and procedures Part 2: Procedure to determine the specific absorption rate (SAR) for wireless communication devices used in close proximity to the human body(frequency range of 30 MHz to 6 GHz)

KDB 616217 D04 SAR for laptop and tablets v01r02: SAR evaluation considerations for laptop, notebook, netbook and tablet computers.

KDB248227 D01 802 11 Wi-Fi SAR v02r02: SAR measurement procedures for 802.112abg transmitters.

KDB447498 D01 General RF Exposure Guidance v06: Mobile and Portable Devices RF Exposure Procedures and Equipment Authorization Policies.

KDB865664 D01 SAR Measurement 100 MHz to 6 GHz v01r04: SAR Measurement Requirements for 100 MHz to 6 GHz

KDB865664 D02 RF Exposure Reporting v01r02: provides general reporting requirements as well as certain specific information required to support MPE and SAR compliance.

KDB941225 D01 3G SAR Procedures v03r01: 3G SAR Measurement Procedures.

KDB941225 D05 SAR for LTE Devices v02r04: SAR Evaluation Considerations for LTE Devices.

KDB941225 D06 hotspot SAR v02r01: SAR Evaluation Procedures for Portable Devices with Wireless Router Capabilities.

NOTE: KDB is not in A2LA Scope List.

6. Specific Absorption Rate (SAR)

6.1. Introduction

SAR is related to the rate at which energy is absorbed per unit mass in an object exposed to a radio field. The SAR distribution in a biological body is complicated and is usually carried out by experimental techniques or numerical modeling. The standard recommends limits for two tiers of groups, occupational/controlled and general population/uncontrolled, based on a person's awareness and ability to exercise control over his or her exposure. In general, occupational/controlled exposure limits are higher than the limits for general population/uncontrolled.

6.2. SAR Definition

The SAR definition is the time derivative (rate) of the incremental energy (dW) absorbed by (dissipated in) an incremental mass (dm) contained in a volume element (dv) of a given density (ρ). The equation description is as below:

$$SAR = \frac{d}{dt} \left(\frac{dW}{dm} \right) = \frac{d}{dt} \left(\frac{dW}{\rho dv} \right)$$

SAR is expressed in units of Watts per kilogram (W/kg)

SAR measurement can be either related to the temperature elevation in tissue by

$$SAR = c \left(\frac{\delta T}{\delta t} \right)$$

Where: C is the specific heat capacity, δT is the temperature rise and δt is the exposure duration, or related to the electrical field in the tissue by

$$SAR = \frac{\sigma |E|^2}{\rho}$$

Where: σ is the conductivity of the tissue, ρ is the mass density of tissue and E is the RMS electrical field strength.

However for evaluating SAR of low power transmitter, electrical field measurement is typically applied.

7. Tissue Simulating Liquids

7.1. Targets for tissue simulating liquid

Table 7.1: Targets for tissue simulating liquid

| Frequency (MHz) | Liquid Type | Conductivity(σ) | $\pm 5\%$ Range | Permittivity(ϵ) | $\pm 5\%$ Range |
|-----------------|-------------|--------------------------|-----------------|----------------------------|-----------------|
| 835 | Head | 0.90 | 0.86~0.95 | 41.5 | 39.4~43.6 |
| 835 | Body | 0.97 | 0.92~1.02 | 55.2 | 52.4~58.0 |
| 1800 | Head | 1.40 | 1.33~1.47 | 40.0 | 38.0~42.0 |
| 1800 | Body | 1.52 | 1.44~1.60 | 53.3 | 50.6~56.0 |
| 1900 | Head | 1.40 | 1.33~1.47 | 40.0 | 38.0~42.0 |
| 1900 | Body | 1.52 | 1.44~1.60 | 53.3 | 50.6~56.0 |
| 2450 | Head | 1.80 | 1.71~1.89 | 39.2 | 37.2~41.2 |
| 2450 | Body | 1.95 | 1.85~2.05 | 52.7 | 50.1~55.3 |
| 2600 | Head | 1.96 | 1.86~2.06 | 39 | 37.05~40.95 |
| 2600 | Body | 2.16 | 2.05~2.27 | 52.5 | 59.88~55.13 |

7.2. Dielectric Performance

Table 7.2: Dielectric Performance of Tissue Simulating Liquid

| Measurement Value | | | | | | |
|-----------------------------|-----------|-------------------------|-----------|-----------------------|-----------|-----------|
| Liquid Temperature: 22.5 °C | | | | | | |
| Type | Frequency | Permittivity ϵ | Drift (%) | Conductivity σ | Drift (%) | Test Date |
| Body | 826.4MHz | 55.147 | -0.10% | 0.994 | 2.47% | 2017-4-28 |
| Body | 846.6 MHz | 55.214 | 0.09% | 1.012 | 2.89% | 2017-4-28 |
| Body | 829 MHz | 55.141 | -0.15% | 0.995 | 2.63% | 2017-4-28 |
| Body | 836.5 MHz | 55.152 | -0.08% | 0.997 | 2.65% | 2017-4-28 |
| Body | 844 MHz | 55.203 | 0.06% | 1.008 | 2.74% | 2017-4-28 |
| Body | 1720MHz | 52.301 | -2.30% | 1.411 | -3.65% | 2017-4-29 |
| Body | 1732.5MHz | 52.305 | -2.20% | 1.422 | -3.73% | 2017-4-29 |
| Body | 1745MHz | 52.3 | -2.11% | 1.435 | -3.67% | 2017-4-29 |
| Body | 1852.4MHz | 54.779 | 2.77% | 1.523 | 0.20% | 2017-4-27 |
| Body | 1880.0MHz | 54.667 | 2.56% | 1.551 | 2.04% | 2017-4-27 |
| Body | 1907.6MHz | 54.555 | 2.35% | 1.579 | 3.88% | 2017-4-27 |
| Body | 1860MHz | 54.749 | 2.72% | 1.531 | 0.72% | 2017-4-27 |
| Body | 1900MHz | 54.586 | 2.41% | 1.571 | 3.36% | 2017-4-27 |
| Body | 2412 MHz | 53.051 | 0.57% | 1.932 | 0.96% | 2017-5-23 |
| Body | 2437 MHz | 52.966 | 0.47% | 1.961 | 1.21% | 2017-5-23 |
| Body | 2462 MHz | 52.882 | 0.37% | 1.991 | 1.22% | 2017-5-23 |
| Body | 2510MHz | 53.804 | 2.23% | 1.978 | -2.47% | 2017-6-05 |
| Body | 2535MHz | 53.723 | 2.15% | 2.004 | -3.21% | 2017-6-05 |
| Body | 2560MHz | 53.474 | 1.75% | 2.044 | -3.27% | 2017-6-05 |

8. System verification

8.1. System Setup

In the simplified setup for system evaluation, the DUT is replaced by a calibrated dipole and the power source is replaced by a continuous wave that comes from a signal generator. The calibrated dipole must be placed beneath the flat phantom section of the SAM twin phantom with the correct distance holder. The distance holder should touch the phantom surface with a light pressure at the reference marking and be oriented parallel to the long side of the phantom. The equipment setup is shown below:

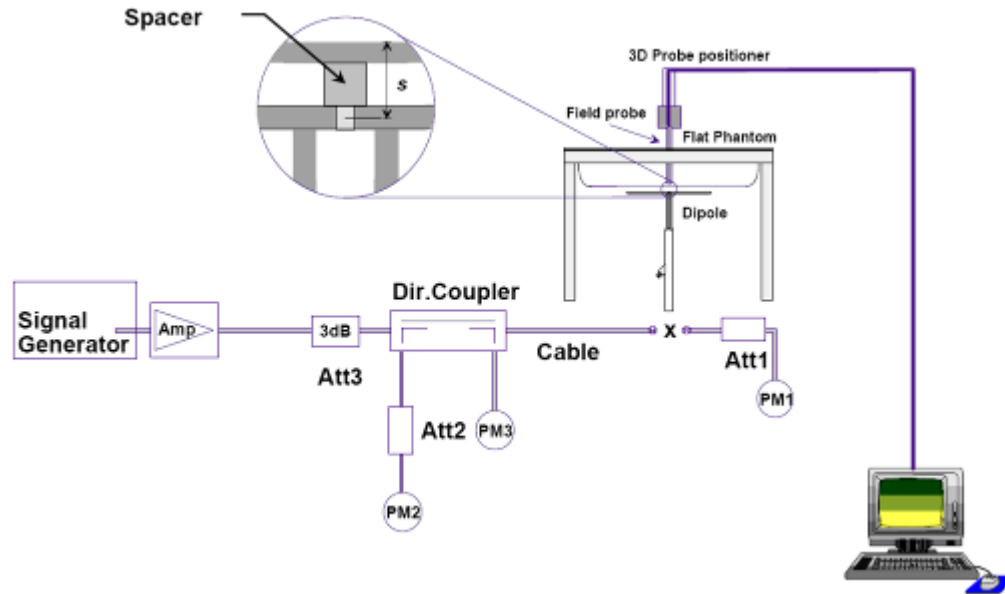

Picture 8.1 System Setup for System Evaluation



Picture 8.2 Photo of Dipole Setup

8.2. System Verification

SAR system verification is required to confirm measurement accuracy, according to the tissue dielectric media, probe calibration points and other system operating parameters required for measuring the SAR of test device. The system verification must be performed for each frequency band and within the valid range of each probe calibration point required for testing the device.

Table 8.1: System Verification of Body

| Verification Results | | | | | | | |
|-----------------------------|---------------------|-------------|-----------------------|-------------|--------------|-------------|-----------|
| Input power level: 1W | | | | | | | |
| Frequency | Target value (W/kg) | | Measured value (W/kg) | | Deviation | | Test date |
| | 10 g Average | 1 g Average | 10 g Average | 1 g Average | 10 g Average | 1 g Average | |
| 835 MHz | 6.29 | 9.57 | 6.36 | 9.56 | 1.11% | -0.10% | 2017-4-28 |
| 1750 MHz | 20.2 | 37.6 | 20.72 | 38.28 | 2.57% | 1.81% | 2017-4-29 |
| 1900 MHz | 21.3 | 41.1 | 21.92 | 42.4 | 2.91% | 3.16% | 2017-4-27 |
| 2450 MHz | 24.7 | 53.1 | 25.36 | 55.6 | 2.67% | 4.71% | 2017-5-23 |
| 2600 MHz | 25.4 | 57.1 | 24.32 | 55.6 | -4.25% | -2.63% | 2017-6-05 |

9. Measurement Procedures

9.1. Tests to be performed

In order to determine the highest value of the peak spatial-average SAR of a handset, all device positions, configurations and operational modes shall be tested for each frequency band according to steps 1 to 3 below. A flowchart of the test process is shown in Picture 11.1.

Step 1: The tests described in 11.2 shall be performed at the channel that is closest to the centre of the transmit frequency band (f_c) for:

- a) all device positions (cheek and tilt, for both left and right sides of the SAM phantom, as described in Chapter 8),
- b) all configurations for each device position in a), e.g., antenna extended and retracted, and
- c) all operational modes, e.g., analogue and digital, for each device position in a) and configuration in b) in each frequency band.

If more than three frequencies need to be tested according to 11.1 (i.e., $N_c > 3$), then all frequencies, configurations and modes shall be tested for all of the above test conditions.

Step 2: For the condition providing highest peak spatial-average SAR determined in Step 1, perform all tests described in 11.2 at all other test frequencies, i.e., lowest and highest frequencies. In addition, for all other conditions (device position, configuration and operational mode) where the peak spatial-average SAR value determined in Step 1 is within 3 dB of the applicable SAR limit, it is recommended that all other test frequencies shall be tested as well.

Step 3: Examine all data to determine the highest value of the peak spatial-average SAR found in Steps 1 to 2.

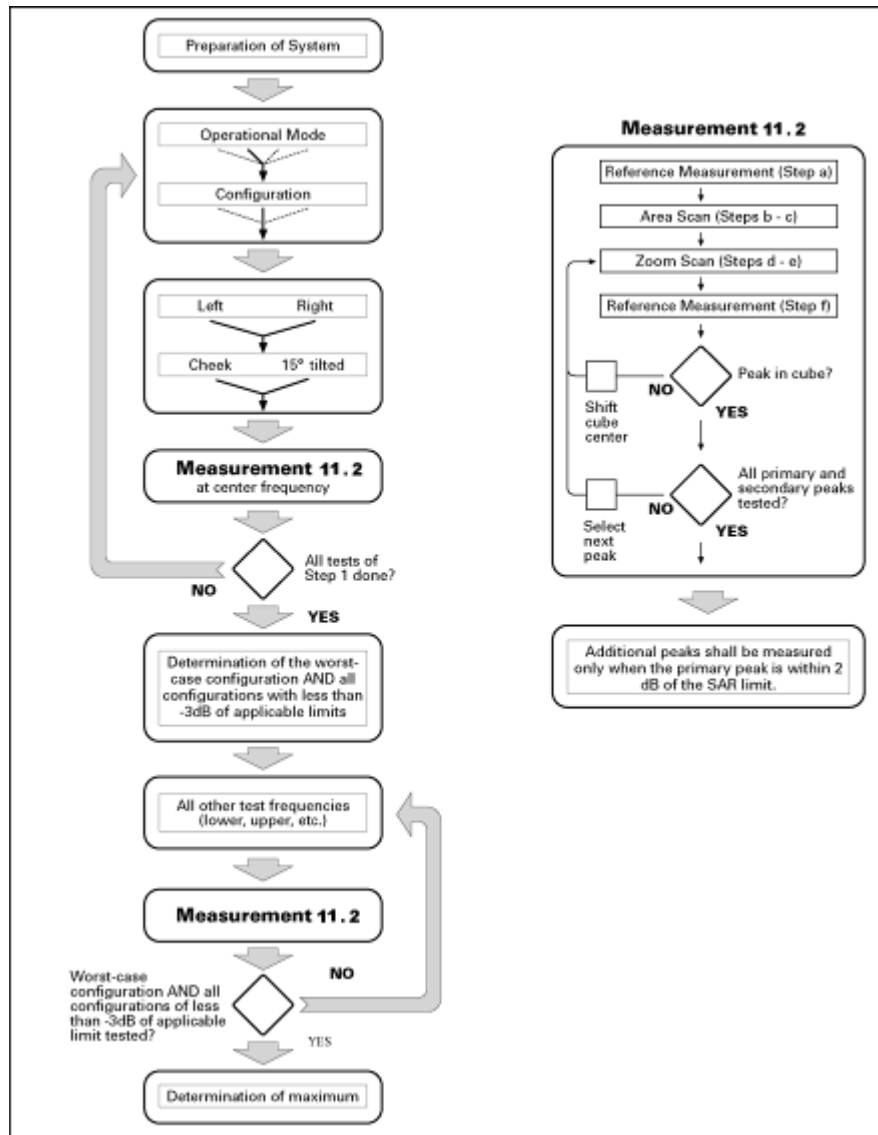

Picture 9.1 Block diagram of the tests to be performed

9.2. General Measurement Procedure

The following procedure shall be performed for each of the test conditions (see Picture 11.1) described in 11.1:

- a) Measure the local SAR at a test point within 8 mm or less in the normal direction from the inner surface of the phantom.
- b) Measure the two-dimensional SAR distribution within the phantom (area scan procedure). The boundary of the measurement area shall not be closer than 20 mm from the phantom side walls. The distance between the measurement points should enable the detection of the location of local maximum with an accuracy of better than half the linear dimension of the tissue cube after interpolation. A maximum grid spacing of 20 mm for frequencies below 3 GHz and $(60/f \text{ [GHz]})$ mm for frequencies of 3GHz and greater is recommended. The maximum distance between the geometrical centre of the probe detectors and the inner surface of the phantom shall be 5 mm for frequencies below 3 GHz and $0.5 \ln(2)/2$ mm for frequencies of 3 GHz and greater, where δ is the plane wave skin depth and $\ln(x)$ is the natural logarithm. The maximum variation of the sensor-phantom surface shall be ± 1 mm for frequencies below 3 GHz and ± 0.5 mm for frequencies of 3 GHz and greater. At all measurement points the angle of the probe with

respect to the line normal to the surface should be less than 5°. If this cannot be achieved for a measurement distance to the phantom inner surface shorter than the probe diameter, additional uncertainty evaluation is needed.

c) From the scanned SAR distribution, identify the position of the maximum SAR value, in addition identify the positions of any local maxima with SAR values within 2 dB of the maximum value that are not within the zoom-scan volume; additional peaks shall be measured only when the primary peak is within 2 dB of the SAR limit. This is consistent with the 2 dB threshold already stated;

d) Measure the three-dimensional SAR distribution at the local maxima locations identified in step c). The horizontal grid step shall be $(24/f[\text{GHz}])$ mm or less but not more than 8 mm. The minimum zoom size of 30 mm by 30 mm and 30 mm for frequencies below 3 GHz. For higher frequencies, the minimum zoom size of 22 mm by 22 mm and 22 mm. The grid step in the vertical direction shall be $(8-f[\text{GHz}])$ mm or less but not more than 5 mm, if uniform spacing is used. If variable spacing is used in the vertical direction, the maximum spacing between the two closest measured points to the phantom shell shall be $(12 / f[\text{GHz}])$ mm or less but not more than 4 mm, and the spacing between further points shall increase by an incremental factor not exceeding 1.5. When variable spacing is used, extrapolation routines shall be tested with the same spacing as used in measurements. The maximum distance between the geometrical centre of the probe detectors and the inner surface of the phantom shall be 5 mm for frequencies below 3 GHz and $\delta \ln(2)/2$ mm for frequencies of 3 GHz and greater, where δ is the plane wave skin depth and $\ln(x)$ is the natural logarithm. Separate grids shall be centered on each of the local SAR maxima found in step c). Uncertainties due to field distortion between the media boundary and the dielectric enclosure of the probe should also be minimized, which is achieved if the distance between the phantom surface and physical tip of the probe is larger than probe tip diameter. Other methods may utilize correction procedures for these boundary effects that enable high precision measurements closer than half the probe diameter. For all measurement points, the angle of the probe with respect to the flat phantom surface shall be less than 5°. If this cannot be achieved an additional uncertainty evaluation is needed.

e) Use post processing(e.g. interpolation and extrapolation) procedures to determine the local SAR values at the spatial resolution needed for mass averaging.

9.3. WCDMA Measurement Procedures for SAR

The following procedures are applicable to WCDMA handsets operating under 3GPP Release99, Release 5 and Release 6. The default test configuration is to measure SAR with an established radio link between the DUT and a communication test set using a 12.2kbps RMC (reference measurement channel) configured in Test Loop Mode 1. SAR is selectively confirmed for other physical channel configurations (DPCCH & DPDCH_n), HSDPA and HSPA (HSUPA/HSDPA) modes according to output power, exposure conditions and device operating capabilities. Both uplink and downlink should be configured with the same RMC or AMR, when required. SAR for Release 5 HSDPA and Release 6 HSPA are measured using the applicable FRC (fixed reference channel) and E-DCH reference channel configurations. Maximum output power is verified according to applicable versions of 3GPP TS 34.121 and SAR must be measured according to these maximum output conditions. When Maximum Power Reduction (MPR) is not implemented according to Cubic Metric (CM) requirements for Release 6 HSPA, the following procedures do not apply.

For Release 5 HSDPA Data Devices:

| Sub-test | β_c | β_d | β_d (SF) | β_c / β_d | β_{hs} | CM/dB | MPR/dB |
|----------|-----------|-----------|----------------|---------------------|--------------|-------|--------|
| 1 | 2/15 | 15/15 | 64 | 2/15 | 4/15 | 2.0 | 0.0 |

| | | | | | | | |
|---|-------|-------|----|-------|-------|-----|-----|
| 2 | 12/15 | 15/15 | 64 | 12/15 | 24/25 | 2.0 | 0.0 |
| 3 | 15/15 | 8/15 | 64 | 15/8 | 30/15 | 2.0 | 0.0 |
| 4 | 15/15 | 4/15 | 64 | 15/4 | 30/15 | 2.0 | 0.0 |

For Release 6 HSUPA Data Devices

| Sub - test | β_c | β_d | β_d (SF) | β_c / β_d | β_{hs} | β_{ec} | β_{ed} | β_{ed} (SF) | β_{ed} (codes) | CM (dB) | MP R (dB) | AG Index | E-TFC I |
|------------|-----------|-----------|----------------|---------------------|--------------|--------------|--|-------------------|----------------------|---------|-----------|----------|---------|
| 1 | 11/1 5 | 15/1 5 | 64 | 11/15 | 22/1 5 | 209/22 5 | 1039/225 | 4 | 1 | 2.0 | 1.0 | 20 | 75 |
| 2 | 6/15 | 15/1 5 | 64 | 6/15 | 12/1 5 | 12/15 | 12/15 | 4 | 1 | 2.0 | 1.0 | 12 | 67 |
| 3 | 15/1 5 | 9/15 | 64 | 15/9 | 30/1 5 | 30/15 | $\beta_{ed1}:47/15$ $\beta_{ed2}:47/1$ 5 | 4 | 2 | 2.0 | 1.0 | 15 | 92 |
| 4 | 2/15 | 15/1 5 | 64 | 2/15 | 4/15 | 4/15 | 56/75 | 4 | 1 | 2.0 | 1.0 | 17 | 71 |
| 5 | 15/1 5 | 15/1 5 | 64 | 15/15 | 24/1 5 | 30/15 | 134/15 | 4 | 1 | 2.0 | 1.0 | 21 | 81 |

9.4. SAR Measurement for LTE

SAR tests for LTE are performed with a base station simulator, Anritsu 8820. Closed loop power control was used so the UE transmits with maximum output power during SAR testing. All powers were measured with the Anritsu 8820

It is performed for conducted power and SAR based on the KDB941225 D05.

SAR is evaluated separately according to the following procedures for the different test positions in each exposure condition – head, body, body-worn accessories and other use conditions. The procedures in the following subsections are applied separately to test each LTE frequency band

1) QPSK with 1 RB allocation

Start with the largest channel bandwidth and measure SAR for QPSK with 1 RB allocation, using the RB offset and required test channel combination with the highest maximum output power among RB offsets at the upper edge, middle and lower edge of each required test channel. When the reported SAR is ≤ 0.8 W/kg, testing of the remaining RB offset configurations and required test channels is not required for 1 RB allocation; otherwise, SAR is required for the remaining required test channels and only for the RB offset configuration with the highest output power for that channel. When the reported SAR of a required test channel is > 1.45 W/kg, SAR is required for all three RB offset configurations for that required test channel.

2) QPSK with 50% RB allocation

The procedures required for 1 RB allocation in 1) are applied to measure the SAR for QPSK with 50% RB allocation.

3) QPSK with 100% RB allocation

For QPSK with 100% RB allocation, SAR is not required when the highest maximum output power for 100 % RB allocation is less than the highest maximum output power in 50% and 1 RB allocations and the highest reported SAR for 1 RB and 50% RB allocation in 1) and 2) are ≤ 0.8 W/kg. Otherwise, SAR is measured for the highest output power channel; and if the reported SAR is > 1.45 W/kg, the remaining required test channels must also be tested.

9.5. Bluetooth & Wi-Fi Measurement Procedures for SAR

Normal network operating configurations are not suitable for measuring the SAR of 802.11 transmitters in general. Unpredictable fluctuations in network traffic and antenna diversity conditions can introduce undesirable variations in SAR results. The SAR for these devices should be measured using chipset based test mode software to ensure that the results are consistent and reliable.

Chipset based test mode software is hardware dependent and generally varies among manufacturers. The device operating parameters established in a test mode for SAR measurements must be identical to those programmed in production units, including output power levels, amplifier gain settings and other RF performance tuning parameters. The test frequencies should correspond to actual channel frequencies defined for domestic use. SAR for devices with switched diversity should be measured with only one antenna transmitting at a time during each SAR measurement, according to a fixed modulation and data rate. The same data pattern should

be used for all measurements.

9.6. Power Drift

To control the output power stability during the SAR test, DASY5 system calculates the power drift by measuring the E-field at the same location at the beginning and at the end of the measurement for each test position. These drift values can be found in Section 15 labeled as: (Power Drift [dB]). This ensures that the power drift during one measurement is within 5%.

10. Area Scan Based 1-g SAR

10.1 Requirement of KDB

According to the KDB447498 D01 v06, when the implementation is based the specific polynomial fit algorithm as presented at the 29th Bioelectromagnetics Society meeting (2007) and the estimated 1-g SAR is ≤ 1.2 W/kg, a zoom scan measurement is not required provided it is also not needed for any other purpose; for example, if the peak SAR location required for simultaneous transmission SAR test exclusion can be determined accurately by the SAR system or manually to discriminate between distinctive peaks and scattered noisy SAR distributions from area scans.

There must not be any warning or alert messages due to various measurement concerns identified by the SAR system; for example, noise in measurements, peaks too close to scan boundary, peaks are too sharp, spatial resolution and uncertainty issues etc. The SAR system verification must also demonstrate that the area scan estimated 1-g SAR is within 3% of the zoom scan 1-g SAR (See Annex B). When all the SAR results for each exposure condition in a frequency band and wireless mode are based on estimated 1-g SAR, the 1-g SAR for the highest SAR configuration must be determined by a zoom scan.

10.2 Fast SAR Algorithms

The approach is based on the area scan measurement applying a frequency dependent attenuation parameter. This attenuation parameter was empirically determined by analyzing a large number of phones. The MOTOROLA FAST SAR was developed and validated by the MOTOROLA Research Group in Ft. Lauderdale.

In the initial study, an approximation algorithm based on Linear fit was developed. The accuracy of the algorithm has been demonstrated across a broad frequency range (136-2450 MHz) and for both 1- and 10-g averaged SAR using a sample of 264 SAR measurements from 55 wireless handsets. For the sample size studied, the root-mean-squared errors of the algorithm are 1.2% and 5.8% for 1- and 10-g averaged SAR, respectively. The paper describing the algorithm in detail is expected to be published in August 2004 within the Special Issue of Transactions on MTT.

In the second step, the same research group optimized the fitting algorithm to an Polynomial fit whereby the frequency validity was extended to cover the range 30-6000MHz. Details of this study can be found in the BEMS 2007 Proceedings.

Both algorithms are implemented in DASY software.

11. Conducted Output Power

11.1. Manufacturing tolerance

Table 11.4: WCDMA

| WCDMA Band II Sensor off | | | |
|----------------------------|--------------|--------------|--------------|
| Channel | Channel 9262 | Channel 9400 | Channel 9538 |
| Maximum Target Value (dBm) | 23.5 | 23.5 | 23.5 |
| WCDMA Band II Sensor on | | | |
| Channel | Channel 9262 | Channel 9400 | Channel 9538 |
| Maximum Target Value (dBm) | 14 | 14 | 14 |

Table 11.5: HSDPA

| WCDMA Band II | | | | |
|---------------|----------------------------|------|------|------|
| Channel | | 9262 | 9400 | 9538 |
| 1 | Maximum Target Value (dBm) | 23 | 23 | 23 |
| 2 | Maximum Target Value (dBm) | 23 | 23 | 23 |
| 3 | Maximum Target Value (dBm) | 22.5 | 22.5 | 22.5 |
| 4 | Maximum Target Value (dBm) | 22 | 22 | 22 |

Table 11.6: HSUPA

| WCDMA Band II | | | | |
|---------------|----------------------------|------|------|------|
| Channel | | 9262 | 9400 | 9538 |
| 1 | Maximum Target Value (dBm) | 22 | 22 | 22 |
| 2 | Maximum Target Value (dBm) | 21 | 21 | 21 |
| 3 | Maximum Target Value (dBm) | 21 | 21 | 21 |
| 4 | Maximum Target Value (dBm) | 22 | 22 | 22 |
| 5 | Maximum Target Value (dBm) | 22 | 22 | 22 |

Table 11.7: WCDMA

| WCDMA Band V Sensor off | | | |
|----------------------------|------|------|------|
| Channel | 4132 | 4182 | 4233 |
| Maximum Target Value (dBm) | 23.5 | 23.5 | 23.5 |
| WCDMA Band V Sensor on | | | |
| Channel | 4132 | 4182 | 4233 |
| Maximum Target Value (dBm) | 18 | 18 | 18 |

Table 11.8: HSDPA

| WCDMA Band V | | | | |
|--------------|----------------------------|------|------|------|
| Channel | | 4132 | 4182 | 4233 |
| 1 | Maximum Target Value (dBm) | 23 | 23 | 23 |
| 2 | Maximum Target Value (dBm) | 23 | 23 | 23 |
| 3 | Maximum Target Value (dBm) | 22.5 | 22.5 | 22.5 |
| 4 | Maximum Target Value (dBm) | 22.5 | 22.5 | 22.5 |

Table 11.9: HSUPA

| WCDMA Band V | | | | |
|--------------|----------------------------|------|------|------|
| Channel | | 4132 | 4182 | 4233 |
| 1 | Maximum Target Value (dBm) | 22.5 | 22.5 | 22.5 |
| 2 | Maximum Target Value (dBm) | 21 | 21 | 21 |

| | | | | |
|---|----------------------------|----|----|----|
| 3 | Maximum Target Value (dBm) | 21 | 21 | 21 |
| 4 | Maximum Target Value (dBm) | 22 | 22 | 22 |
| 5 | Maximum Target Value (dBm) | 22 | 22 | 22 |

Table 11.12: LTE

| LTE Band2 Sensor off | | | |
|----------------------------|------|------|------|
| RB Size | 1 | 50% | 100% |
| Maximum Target Value (dBm) | 23.5 | 22 | 22 |
| LTE Band4 Sensor off | | | |
| RB Size | 1 | 50% | 100% |
| Maximum Target Value (dBm) | 23.5 | 23 | 22.5 |
| LTE Band5 Sensor off | | | |
| RB Size | 1 | 50% | 100% |
| Maximum Target Value (dBm) | 23.5 | 23 | 22.5 |
| LTE Band7 Sensor off | | | |
| RB Size | 1 | 50% | 100% |
| Maximum Target Value (dBm) | 22.5 | 21.5 | 21.5 |
| LTE Band2 Sensor on | | | |
| RB Size | 1 | 50% | 100% |
| Maximum Target Value (dBm) | 13.5 | 13.5 | 13.5 |
| LTE Band4 Sensor on | | | |
| RB Size | 1 | 50% | 100% |
| Maximum Target Value (dBm) | 13.5 | 13.5 | 13.5 |
| LTE Band5 Sensor on | | | |
| RB Size | 1 | 50% | 100% |
| Maximum Target Value (dBm) | 16.5 | 16 | 16 |
| LTE Band7 Sensor on | | | |
| RB Size | 1 | 50% | 100% |
| Maximum Target Value (dBm) | 12 | 11.5 | 11.5 |

Table 11.13: WiFi

| WiFi 802.11b Sensor off | | | |
|-----------------------------|-----------|-----------|------------|
| Channel | Channel 1 | Channel 6 | Channel 11 |
| Maximum Target Value (dBm) | 15 | 15 | 15 |
| WiFi 802.11g Sensor off | | | |
| Channel | Channel 1 | Channel 6 | Channel 11 |
| Maximum Target Value (dBm) | 14.5 | 14.5 | 14.5 |
| WiFi 802.11n 20M Sensor off | | | |
| Channel | Channel 1 | Channel 6 | Channel 11 |
| Maximum Target Value (dBm) | 14.5 | 14.5 | 14.5 |
| WiFi 802.11n 40M Sensor off | | | |
| Channel | Channel 1 | Channel 6 | Channel 11 |
| Maximum Target Value (dBm) | 14.5 | 14.5 | 14 |
| WiFi 802.11b Sensor on | | | |
| Channel | Channel 1 | Channel 6 | Channel 11 |
| Maximum Target Value (dBm) | 9.5 | 9.5 | 9.5 |
| WiFi 802.11g Sensor on | | | |
| Channel | Channel 1 | Channel 6 | Channel 11 |
| Maximum Target Value (dBm) | 8.5 | 8.5 | 8 |
| WiFi 802.11n 20M Sensor on | | | |
| Channel | Channel 1 | Channel 6 | Channel 11 |
| Maximum Target Value (dBm) | 8.5 | 8.5 | 8 |
| WiFi 802.11n 40M Sensor on | | | |
| Channel | Channel 1 | Channel 6 | Channel 11 |
| Maximum Target Value (dBm) | 8.5 | 8.5 | 8 |

Table 11.12: Bluetooth

| Bluetooth 2.1 | | | |
|----------------------------|-----------|------------|------------|
| Channel | Channel 0 | Channel 39 | Channel 78 |
| Maximum Target Value (dBm) | 3 | 3 | 1 |
| Bluetooth 4.0 | | | |
| Channel | Channel 0 | Channel 19 | Channel 39 |
| Maximum Target Value (dBm) | -1.5 | -1.5 | -3 |

11.2. WCDMA Measurement result

Table 11.16: The conducted Power for WCDMA Sensor off

| Item | band | WCDMA BAND II result(dBm) | | |
|-------|-------|----------------------------|----------------------------|----------------------------|
| | ARFCN | 2712 (1852.4MHz) | 2788 (1880.0MHz) | 2863 (1907.6MHz) |
| WCDMA | \ | 23.31 | 23.14 | 23.21 |
| HSDPA | 1 | 22.59 | 22.41 | 22.47 |
| | 2 | 22.37 | 22.21 | 22.29 |
| | 3 | 22.04 | 21.91 | 22 |
| | 4 | 21.96 | 21.81 | 21.87 |
| HSUPA | 1 | 21.94 | 21.81 | 21.86 |
| | 2 | 20.99 | 20.75 | 20.9 |
| | 3 | 20.98 | 20.89 | 20.83 |
| | 4 | 21.79 | 21.59 | 21.74 |
| | 5 | 21.59 | 21.49 | 21.63 |
| Item | band | WCDMA BAND V result(dBm) | | |
| | ARFCN | Channel 4132 (826.4MHz) | Channel 4182 (836.6MHz) | Channel 4233 (846.6MHz) |
| WCDMA | \ | 23.33 | 23.27 | 23.24 |
| HSDPA | 1 | 22.58 | 22.53 | 22.52 |
| | 2 | 22.38 | 22.35 | 22.28 |
| | 3 | 22.11 | 22.04 | 22.03 |
| | 4 | 22.01 | 21.97 | 21.93 |
| HSUPA | 1 | 22.01 | 21.94 | 21.86 |
| | 2 | 20.98 | 20.95 | 20.87 |
| | 3 | 20.98 | 21 | 20.91 |
| | 4 | 21.91 | 21.77 | 21.79 |
| | 5 | 21.62 | 21.6 | 21.62 |

Table 11.16: The conducted Power for WCDMA Sensor on

| Item | band | WCDMA BAND II result(dBm) | | |
|-------|-------|---------------------------|---------------------|---------------------|
| | ARFCN | 2712 (1852.4MHz) | 2788 (1880.0MHz) | 2863 (1907.6MHz) |
| WCDMA | \ | 13.91 | 13.94 | 13.62 |
| HSDPA | 1 | 13.24 | 13.18 | 12.88 |
| | 2 | 13.02 | 12.98 | 12.7 |
| | 3 | 12.69 | 12.68 | 12.41 |
| | 4 | 12.61 | 12.58 | 12.28 |
| HSUPA | 1 | 12.59 | 12.58 | 12.27 |
| | 2 | 11.64 | 11.52 | 11.31 |
| | 3 | 11.63 | 11.66 | 11.24 |
| | 4 | 12.44 | 12.36 | 12.15 |

| | 5 | 12.24 | 12.26 | 12.04 |
|--------------|-------|----------------------------|----------------------------|----------------------------|
| Item | band | WCDMA BAND V result(dBm) | | |
| | ARFCN | Channel 4132 (826.4MHz) | Channel 4183 (836.6MHz) | Channel 4233 (846.6MHz) |
| WCDMA | \ | 17.86 | 17.88 | 17.74 |
| HSDPA | 1 | 17.24 | 17.15 | 17 |
| | 2 | 17.02 | 16.95 | 16.82 |
| | 3 | 16.69 | 16.65 | 16.53 |
| | 4 | 16.61 | 16.55 | 16.4 |
| HSUPA | 1 | 16.59 | 16.55 | 16.39 |
| | 2 | 15.64 | 15.49 | 15.43 |
| | 3 | 15.63 | 15.63 | 15.36 |
| | 4 | 16.44 | 16.33 | 16.27 |
| | 5 | 16.24 | 16.23 | 16.16 |

11.3. LTE Measurement result

Table 11.17: The conducted Power for LTE BAND 2/4/5/7 Sensor off

| Band2 | | | | | | |
|-----------|-------|---------|-----------|-------------------------------|-----------------------------|-------------------------------|
| Bandwidth | Mode | RB Size | RB Offset | Actual output power(dBm) | | |
| | | | | Channel 18625 1852.5MHz | Channel 18900 1880MHz | Channel 19175 1907.5MHz |
| 5MHz | QPSK | 1 | 0 | 22.71 | 22.94 | 22.85 |
| | | 1 | 13 | 22.77 | 22.76 | 22.84 |
| | | 1 | 24 | 22.78 | 22.72 | 22.80 |
| | | 12 | 0 | 21.80 | 21.85 | 21.91 |
| | | 12 | 6 | 21.82 | 21.80 | 21.93 |
| | | 12 | 13 | 21.72 | 21.80 | 21.86 |
| | | 25 | 0 | 21.74 | 21.81 | 21.82 |
| | 16QAM | 1 | 0 | 20.81 | 20.98 | 20.70 |
| | | 1 | 13 | 20.84 | 21.00 | 20.82 |
| | | 1 | 24 | 20.79 | 20.95 | 20.68 |
| | | 12 | 0 | 19.87 | 20.27 | 20.11 |
| | | 12 | 6 | 19.96 | 20.20 | 19.86 |
| | | 12 | 13 | 19.89 | 20.22 | 20.00 |
| | | 25 | 0 | 20.20 | 20.32 | 20.24 |
| Bandwidth | Mode | RB Size | RB Offset | Actual output power(dBm) | | |
| | | | | Channel 18650 1855MHz | Channel 18900 1880MHz | Channel 19150 1905MHz |
| 10MHz | QPSK | 1 | 0 | 22.99 | 22.43 | 23.02 |
| | | 1 | 25 | 23.00 | 22.91 | 22.94 |
| | | 1 | 49 | 22.72 | 22.72 | 22.68 |
| | | 25 | 0 | 21.92 | 21.77 | 21.86 |
| | | 25 | 13 | 21.79 | 21.75 | 21.91 |
| | | 25 | 25 | 21.91 | 21.81 | 21.90 |
| | | 50 | 0 | 21.84 | 21.83 | 21.87 |
| | 16QAM | 1 | 0 | 20.46 | 21.20 | 21.18 |
| | | 1 | 25 | 21.05 | 21.21 | 21.31 |
| | | 1 | 49 | 20.92 | 21.10 | 20.88 |
| | | 25 | 0 | 20.27 | 20.41 | 20.48 |
| | | 25 | 13 | 20.34 | 20.42 | 20.32 |
| | | 25 | 25 | 20.25 | 20.30 | 20.02 |
| | | 50 | 0 | 20.19 | 20.32 | 20.28 |
| Bandwidth | Mode | RB Size | RB Offset | Actual output power(dBm) | | |

| | | | | Channel 18675 1857.5MHz | Channel 18900 1880MHz | Channel 19125 1902.5MHz |
|-----------|-------|---------|-----------|-------------------------------|-----------------------------|-------------------------------|
| | | | | Actual output power(dBm) | | |
| Bandwidth | Mode | RB Size | RB Offset | Channel 18700 1860MHz | Channel 18900 1880MHz | Channel 19100 1900MHz |
| 15MHz | QPSK | 1 | 0 | 23.23 | 22.98 | 23.17 |
| | | 1 | 37 | 22.88 | 22.77 | 22.76 |
| | | 1 | 74 | 22.82 | 22.91 | 22.93 |
| | | 36 | 0 | 21.88 | 21.67 | 21.87 |
| | | 36 | 19 | 21.94 | 21.76 | 21.88 |
| | | 36 | 38 | 21.95 | 21.64 | 21.92 |
| | | 75 | 0 | 21.87 | 21.67 | 21.91 |
| | 16QAM | 1 | 0 | 21.00 | 21.21 | 21.24 |
| | | 1 | 37 | 20.90 | 21.11 | 20.85 |
| | | 1 | 74 | 21.02 | 20.45 | 21.01 |
| | | 36 | 0 | 19.91 | 20.26 | 20.17 |
| | | 36 | 19 | 19.97 | 20.22 | 20.19 |
| | | 36 | 38 | 20.05 | 20.22 | 20.07 |
| | | 75 | 0 | 20.02 | 20.31 | 20.27 |
| 20MHz | QPSK | 1 | 0 | 23.23 | 23.26 | 23.24 |
| | | 1 | 50 | 23.02 | 22.94 | 23.10 |
| | | 1 | 99 | 22.71 | 22.86 | 22.70 |
| | | 50 | 0 | 21.89 | 21.99 | 21.91 |
| | | 50 | 25 | 21.90 | 21.83 | 21.89 |
| | | 50 | 50 | 21.97 | 21.87 | 21.83 |
| | | 100 | 0 | 21.80 | 21.94 | 21.87 |
| | 16QAM | 1 | 0 | 20.99 | 21.23 | 21.15 |
| | | 1 | 50 | 21.14 | 21.35 | 21.49 |
| | | 1 | 99 | 20.92 | 21.11 | 20.89 |
| | | 50 | 0 | 20.37 | 20.22 | 20.48 |
| | | 50 | 25 | 20.19 | 20.39 | 20.53 |
| | | 50 | 50 | 20.21 | 20.37 | 20.28 |
| | | 100 | 0 | 20.21 | 20.33 | 20.37 |
| Bandwidth | Mode | RB Size | RB Offset | Actual output power(dBm) | | |
| | | | | Channel 18615 1851.5MHz | Channel 18900 1880MHz | Channel 19185 1908.5MHz |
| 3MHz | QPSK | 1 | 0 | 22.74 | 22.58 | 22.83 |
| | | 1 | 7 | 22.58 | 22.63 | 22.49 |
| | | 1 | 14 | 22.60 | 22.66 | 22.92 |
| | | 8 | 0 | 21.68 | 21.67 | 21.94 |

| Bandwidth | Mode | RB Size | RB Offset | Actual output power(dBm) | | | |
|-----------|--------|---------|-----------|----------------------------|--------------------------|----------------------------|-------|
| | | | | Channel 18607 1850.7MHz | Channel 18900 1880MHz | Channel 19193 1909.3MHz | |
| 1.4MHz | 16QAM | 8 | 4 | 21.77 | 21.64 | 21.87 | |
| | | 8 | 7 | 21.73 | 21.69 | 21.94 | |
| | | 15 | 0 | 21.77 | 21.63 | 21.88 | |
| | | 1 | 0 | 20.56 | 20.99 | 20.70 | |
| | | 1 | 7 | 20.88 | 21.06 | 20.89 | |
| | | 1 | 14 | 20.73 | 20.88 | 20.73 | |
| | | 8 | 0 | 20.05 | 20.44 | 20.09 | |
| | | 8 | 4 | 20.25 | 20.40 | 20.01 | |
| | | 8 | 7 | 20.41 | 20.37 | 20.13 | |
| | 15 | 0 | 20.13 | 20.31 | 20.08 | | |
| | 1.4MHz | QPSK | 1 | 0 | 22.59 | 22.66 | 22.87 |
| | | | 1 | 3 | 22.60 | 22.67 | 22.91 |
| | | | 1 | 5 | 22.53 | 22.47 | 22.95 |
| | | | 3 | 0 | 22.66 | 22.70 | 22.93 |
| | | | 3 | 1 | 22.68 | 22.73 | 22.99 |
| 3 | | | 3 | 22.79 | 22.70 | 22.95 | |
| 6 | | | 0 | 21.61 | 21.56 | 21.86 | |
| 16QAM | | 1 | 0 | 20.87 | 20.94 | 20.97 | |
| | | 1 | 3 | 20.85 | 21.44 | 20.93 | |
| | | 1 | 5 | 20.80 | 21.42 | 20.95 | |
| | | 3 | 0 | 20.97 | 21.24 | 21.02 | |
| | | 3 | 1 | 21.09 | 21.31 | 21.09 | |
| | | 3 | 3 | 21.16 | 21.40 | 21.13 | |
| | | 6 | 0 | 20.06 | 20.44 | 20.07 | |

| Band4 | | | | | | |
|-----------|------|---------|-----------|----------------------------|----------------------------|----------------------------|
| Bandwidth | Mode | RB Size | RB Offset | Actual output power(dBm) | | |
| | | | | Channel 19975 1712.5MHz | Channel 20175 1732.5MHz | Channel 20375 1752.5MHz |
| 5MHz | QPSK | 1 | 0 | 22.68 | 23.10 | 23.30 |
| | | 1 | 13 | 22.79 | 23.33 | 23.36 |
| | | 1 | 24 | 22.68 | 23.25 | 23.42 |
| | | 12 | 0 | 22.14 | 22.43 | 22.65 |
| | | 12 | 6 | 21.96 | 22.44 | 22.63 |
| | | 12 | 13 | 21.96 | 22.46 | 22.70 |
| | | 25 | 0 | 21.91 | 22.41 | 22.41 |

| | | | | | | |
|-----------|-------|---------|-----------|-------------------------------|-------------------------------|-------------------------------|
| | 16QAM | 1 | 0 | 20.80 | 21.09 | 20.59 |
| | | 1 | 13 | 20.84 | 21.00 | 20.75 |
| | | 1 | 24 | 20.70 | 21.00 | 20.96 |
| | | 12 | 0 | 19.81 | 20.41 | 20.12 |
| | | 12 | 6 | 20.00 | 20.01 | 19.94 |
| | | 12 | 13 | 19.99 | 20.01 | 19.95 |
| | | 25 | 0 | 19.97 | 20.19 | 20.06 |
| Bandwidth | Mode | RB Size | RB Offset | Actual output power(dBm) | | |
| | | | | Channel 20000 1715MHz | Channel 20175 1732.5MHz | Channel 20350 1750MHz |
| 10MHz | QPSK | 1 | 0 | 22.74 | 23.15 | 23.25 |
| | | 1 | 25 | 22.99 | 23.16 | 23.17 |
| | | 1 | 49 | 22.82 | 23.05 | 23.11 |
| | | 25 | 0 | 21.99 | 22.36 | 22.63 |
| | | 25 | 13 | 22.01 | 22.34 | 22.62 |
| | | 25 | 25 | 22.02 | 22.43 | 22.69 |
| | | 50 | 0 | 22.02 | 22.38 | 22.42 |
| | 16QAM | 1 | 0 | 20.90 | 21.03 | 21.23 |
| | | 1 | 25 | 20.99 | 21.39 | 21.25 |
| | | 1 | 49 | 20.77 | 21.06 | 21.02 |
| | | 25 | 0 | 20.13 | 20.38 | 20.26 |
| | | 25 | 13 | 20.10 | 20.31 | 20.18 |
| | | 25 | 25 | 19.87 | 20.18 | 20.08 |
| | | 50 | 0 | 19.91 | 20.32 | 20.31 |
| Bandwidth | Mode | RB Size | RB Offset | Actual output power(dBm) | | |
| | | | | Channel 20025 1717.5MHz | Channel 20175 1732.5MHz | Channel 20325 1747.5MHz |
| 15MHz | QPSK | 1 | 0 | 22.97 | 22.97 | 23.40 |
| | | 1 | 38 | 22.82 | 23.32 | 23.35 |
| | | 1 | 74 | 22.88 | 23.17 | 23.33 |
| | | 36 | 0 | 22.09 | 22.43 | 22.61 |
| | | 36 | 18 | 22.02 | 22.40 | 22.52 |
| | | 36 | 39 | 22.11 | 22.42 | 22.51 |
| | | 75 | 0 | 22.13 | 22.35 | 22.28 |
| | 16QAM | 1 | 0 | 21.01 | 21.17 | 21.22 |
| | | 1 | 38 | 20.98 | 21.11 | 21.11 |
| | | 1 | 74 | 20.88 | 21.09 | 20.94 |
| | | 36 | 0 | 20.33 | 20.28 | 20.38 |
| | | 36 | 18 | 20.24 | 20.40 | 20.27 |
| | | 36 | 39 | 20.17 | 20.41 | 20.14 |
| | | 75 | 0 | 20.25 | 20.45 | 20.35 |

| Bandwidth | Mode | RB Size | RB Offset | Actual output power(dBm) | | |
|-----------|-------|---------|-----------|-------------------------------|-------------------------------|-------------------------------|
| | | | | Channel 20050 1720MHz | Channel 20175 1732.5MHz | Channel 20300 1745MHz |
| 20MHz | QPSK | 1 | 0 | 23.36 | 23.45 | 23.41 |
| | | 1 | 50 | 23.10 | 23.34 | 23.23 |
| | | 1 | 99 | 23.12 | 23.20 | 23.40 |
| | | 50 | 0 | 22.73 | 22.76 | 22.72 |
| | | 50 | 25 | 22.11 | 22.38 | 22.53 |
| | | 50 | 50 | 22.16 | 22.41 | 22.57 |
| | | 100 | 0 | 22.35 | 22.45 | 22.37 |
| | 16QAM | 1 | 0 | 20.96 | 20.37 | 21.44 |
| | | 1 | 50 | 21.13 | 21.38 | 21.42 |
| | | 1 | 99 | 20.93 | 21.02 | 20.96 |
| | | 50 | 0 | 19.99 | 20.31 | 20.31 |
| | | 50 | 25 | 20.10 | 20.37 | 20.26 |
| | | 50 | 50 | 20.20 | 20.07 | 20.22 |
| | | 100 | 0 | 20.18 | 20.19 | 20.34 |
| Bandwidth | Mode | RB Size | RB Offset | Actual output power(dBm) | | |
| | | | | Channel 19965 1711.5MHz | Channel 20175 1732.5MHz | Channel 20385 1753.5MHz |
| 3MHz | QPSK | 1 | 0 | 22.74 | 23.24 | 23.42 |
| | | 1 | 8 | 22.66 | 23.32 | 23.39 |
| | | 1 | 14 | 22.88 | 23.26 | 23.37 |
| | | 8 | 0 | 22.01 | 22.43 | 22.59 |
| | | 8 | 4 | 22.08 | 22.30 | 22.48 |
| | | 8 | 7 | 22.05 | 22.51 | 22.44 |
| | | 15 | 0 | 22.03 | 22.35 | 22.31 |
| | 16QAM | 1 | 0 | 20.92 | 20.97 | 20.85 |
| | | 1 | 8 | 20.78 | 21.42 | 20.79 |
| | | 1 | 15 | 20.92 | 21.42 | 20.83 |
| | | 8 | 0 | 20.07 | 20.26 | 19.97 |
| | | 8 | 4 | 20.11 | 20.09 | 20.08 |
| | | 8 | 7 | 20.10 | 20.42 | 20.18 |
| | | 15 | 0 | 19.99 | 20.31 | 20.00 |
| Bandwidth | Mode | RB Size | RB Offset | Actual output power(dBm) | | |
| | | | | Channel 19957 1710.7MHz | Channel 20175 1732.5MHz | Channel 20393 1754.3MHz |
| 1.4MHz | QPSK | 1 | 0 | 22.90 | 23.10 | 23.36 |
| | | 1 | 2 | 22.91 | 23.07 | 23.28 |

| | | | | | | |
|--|-------|---|---|-------|-------|-------|
| | | 1 | 5 | 22.79 | 23.03 | 23.26 |
| | | 3 | 0 | 22.37 | 22.38 | 22.35 |
| | | 3 | 1 | 22.39 | 22.36 | 22.34 |
| | | 3 | 2 | 22.35 | 22.38 | 22.32 |
| | | 6 | 0 | 22.10 | 22.25 | 22.30 |
| | 16QAM | 1 | 0 | 20.94 | 21.24 | 20.92 |
| | | 1 | 2 | 20.89 | 21.58 | 20.81 |
| | | 1 | 5 | 20.93 | 21.00 | 20.82 |
| | | 3 | 0 | 21.14 | 21.25 | 21.10 |
| | | 3 | 1 | 21.11 | 21.44 | 21.15 |
| | | 3 | 2 | 21.18 | 21.24 | 21.21 |
| | | 6 | 0 | 20.03 | 20.30 | 20.08 |

| Band5 | | | | | | |
|-----------|-------|---------|-----------|---------------------------|---------------------------|---------------------------|
| Bandwidth | Mode | RB Size | RB Offset | Actual output power(dBm) | | |
| | | | | Channel 20425 826.5MHz | Channel 20525 836.5MHz | Channel 20625 846.5MHz |
| 5MHz | QPSK | 1 | 0 | 22.77 | 23.30 | 22.91 |
| | | 1 | 12 | 23.21 | 23.28 | 22.75 |
| | | 1 | 24 | 23.19 | 23.13 | 22.73 |
| | | 12 | 0 | 22.05 | 22.60 | 21.80 |
| | | 12 | 6 | 22.04 | 22.47 | 21.85 |
| | | 12 | 13 | 22.18 | 22.40 | 21.68 |
| | | 25 | 0 | 22.02 | 22.44 | 21.82 |
| | 16QAM | 1 | 0 | 21.8 | 22.36 | 21.93 |
| | | 1 | 12 | 22.19 | 22.36 | 21.64 |
| | | 1 | 24 | 22.18 | 22.06 | 21.53 |
| | | 12 | 0 | 21.11 | 21.55 | 20.55 |
| | | 12 | 6 | 20.99 | 21.54 | 20.92 |
| | | 12 | 13 | 21.09 | 21.43 | 20.6 |
| | | 25 | 0 | 20.91 | 21.48 | 20.77 |
| Bandwidth | Mode | RB Size | RB Offset | Actual output power(dBm) | | |
| | | | | Channel 20450 829MHz | Channel 20525 836.5MHz | Channel 20600 844MHz |
| 10MHz | QPSK | 1 | 0 | 23.26 | 23.44 | 23.30 |
| | | 1 | 25 | 23.40 | 23.33 | 23.08 |
| | | 1 | 49 | 23.28 | 22.89 | 22.47 |
| | | 25 | 0 | 22.46 | 22.70 | 22.45 |
| | | 25 | 13 | 22.35 | 22.43 | 21.96 |
| | | 25 | 25 | 22.60 | 22.31 | 21.81 |
| | | 50 | 0 | 22.42 | 22.49 | 22.03 |
| | 16QAM | 1 | 0 | 22.31 | 22.41 | 22.32 |
| | | 1 | 25 | 22.39 | 22.4 | 21.96 |
| | | 1 | 49 | 22.27 | 21.83 | 21.27 |
| | | 25 | 0 | 21.13 | 21.62 | 20.55 |
| | | 25 | 13 | 21.28 | 21.49 | 21.03 |
| | | 25 | 25 | 21.52 | 21.33 | 20.73 |
| | | 50 | 0 | 21.32 | 21.45 | 20.91 |
| Bandwidth | Mode | RB Size | RB Offset | Channel 20415 825.5MHz | | |
| | | | | Channel 20415 825.5MHz | Channel 20525 836.5MHz | Channel 20635 847.5MHz |
| 3MHz | QPSK | 1 | 0 | 22.59 | 23.22 | 22.50 |

| | | | | | | |
|---------------------------|-----------|------|---------|-----------|------------------------------|---------------------------|
| | | 1 | 7 | 22.72 | 23.17 | 22.61 |
| | | 1 | 14 | 22.79 | 23.13 | 22.38 |
| | | 8 | 0 | 21.89 | 22.66 | 21.99 |
| | | 8 | 4 | 22.03 | 22.52 | 21.76 |
| | | 8 | 7 | 22.03 | 22.35 | 21.70 |
| | | 15 | 0 | 22.09 | 22.40 | 21.67 |
| | 16QAM | 1 | 0 | 21.59 | 22.21 | 21.52 |
| | | 1 | 7 | 21.7 | 22.18 | 21.59 |
| | | 1 | 14 | 21.68 | 22.06 | 21.25 |
| | | 8 | 0 | 20.95 | 21.58 | 21 |
| | | 8 | 4 | 20.96 | 21.49 | 20.83 |
| | | 8 | 7 | 21.05 | 21.37 | 20.58 |
| | | 15 | 0 | 20.99 | 21.56 | 20.65 |
| | Bandwidth | Mode | RB Size | RB Offset | Actual output power(dBm) | |
| Channel 20407 824.7MHz | | | | | Channel 20525 836.5MHz | Channel 20643 848.3MHz |
| 1.4MHz | QPSK | 1 | 0 | 22.69 | 23.31 | 22.41 |
| | | 1 | 2 | 22.87 | 23.20 | 22.54 |
| | | 1 | 5 | 22.71 | 23.09 | 22.42 |
| | | 3 | 0 | 22.10 | 22.52 | 22.69 |
| | | 3 | 2 | 22.06 | 22.46 | 22.67 |
| | | 3 | 3 | 22.16 | 22.58 | 22.67 |
| | | 6 | 0 | 21.86 | 22.48 | 21.66 |
| | 16QAM | 1 | 0 | 21.72 | 21.90 | 21.96 |
| | | 1 | 2 | 21.76 | 21.91 | 22.06 |
| | | 1 | 5 | 21.74 | 21.60 | 21.71 |
| | | 3 | 0 | 21.80 | 21.71 | 21.89 |
| | | 3 | 2 | 21.88 | 21.83 | 21.91 |
| | | 3 | 3 | 22.06 | 21.92 | 22.06 |
| | | 6 | 0 | 20.90 | 20.83 | 20.93 |

| Band7 | | | | | | |
|-----------|-------|---------|-----------|-------------------------------|-----------------------------|-------------------------------|
| Bandwidth | Mode | RB Size | RB Offset | Actual output power(dBm) | | |
| | | | | Channel 20775 2502.5MHz | Channel 21100 2535MHz | Channel 21425 2567.5MHz |
| 5MHz | QPSK | 1 | 0 | 21.86 | 21.6 | 21.97 |
| | | 1 | 13 | 21.94 | 21.76 | 22.11 |
| | | 1 | 24 | 21.68 | 21.7 | 22.03 |
| | | 12 | 0 | 20.85 | 20.83 | 21.24 |
| | | 12 | 6 | 20.82 | 20.75 | 21.22 |
| | | 12 | 13 | 20.69 | 20.82 | 21.18 |
| | | 25 | 0 | 20.83 | 20.74 | 21.24 |
| | 16QAM | 1 | 0 | 20.86 | 20.59 | 20.99 |
| | | 1 | 13 | 20.92 | 20.77 | 21.09 |
| | | 1 | 24 | 20.57 | 20.63 | 20.9 |
| | | 12 | 0 | 19.91 | 19.75 | 20.25 |
| | | 12 | 6 | 19.75 | 19.72 | 20.29 |
| | | 12 | 13 | 19.71 | 19.84 | 20.06 |
| | | 25 | 0 | 19.73 | 19.7 | 20.22 |
| Bandwidth | Mode | RB Size | RB Offset | Actual output power(dBm) | | |
| | | | | Channel 20800 2505MHz | Channel 21100 2535MHz | Channel 21400 2565MHz |
| 10MHz | QPSK | 1 | 0 | 22.01 | 21.83 | 22.05 |
| | | 1 | 25 | 21.89 | 21.89 | 22.23 |
| | | 1 | 49 | 21.82 | 21.85 | 22.1 |
| | | 25 | 0 | 20.81 | 20.9 | 20.81 |
| | | 25 | 13 | 20.81 | 20.82 | 20.8 |
| | | 25 | 25 | 20.98 | 20.86 | 21.16 |
| | | 50 | 0 | 20.73 | 20.82 | 21.12 |
| | 16QAM | 1 | 0 | 20.94 | 20.82 | 21.07 |
| | | 1 | 25 | 20.87 | 20.9 | 21.21 |
| | | 1 | 49 | 20.83 | 20.81 | 21.02 |
| | | 25 | 0 | 19.87 | 19.82 | 19.82 |
| | | 25 | 13 | 19.74 | 19.79 | 19.79 |
| | | 25 | 25 | 20 | 19.89 | 20.04 |
| | | 50 | 0 | 19.64 | 19.75 | 20.1 |
| Bandwidth | Mode | RB Size | RB Offset | Actual output power(dBm) | | |
| | | | | Channel 20825 2507.5MHz | Channel 21100 2535MHz | Channel 21375 2562.5MHz |
| 15MHz | QPSK | 1 | 0 | 21.68 | 21.76 | 21.74 |

| | | | | | | |
|-----------------------------|-----------|------|---------|-----------|-----------------------------|-----------------------------|
| | | 1 | 38 | 21.72 | 21.83 | 22.03 |
| | | 1 | 74 | 22.06 | 21.86 | 22.16 |
| | | 36 | 0 | 20.86 | 20.87 | 20.79 |
| | | 36 | 18 | 20.92 | 20.78 | 20.94 |
| | | 36 | 39 | 20.89 | 20.91 | 21.25 |
| | | 75 | 0 | 20.86 | 20.85 | 20.95 |
| | 16QAM | 1 | 0 | 20.68 | 20.75 | 20.76 |
| | | 1 | 38 | 20.7 | 20.84 | 21.01 |
| | | 1 | 74 | 20.95 | 20.79 | 21.03 |
| | | 36 | 0 | 19.92 | 19.79 | 19.8 |
| | | 36 | 18 | 19.85 | 19.75 | 20.01 |
| | | 36 | 39 | 19.91 | 19.93 | 20.13 |
| | | 75 | 0 | 19.76 | 19.81 | 19.93 |
| | Bandwidth | Mode | RB Size | RB Offset | Actual output power(dBm) | |
| Channel 20850 2510MHz | | | | | Channel 21100 2535MHz | Channel 21350 2560MHz |
| 20MHz | QPSK | 1 | 0 | 22.21 | 22.25 | 22.15 |
| | | 1 | 50 | 21.91 | 21.78 | 21.94 |
| | | 1 | 99 | 21.97 | 21.74 | 22.04 |
| | | 50 | 0 | 21.48 | 21.49 | 21.45 |
| | | 50 | 25 | 21.31 | 21.36 | 21.24 |
| | | 50 | 50 | 20.82 | 21.27 | 21.23 |
| | | 100 | 0 | 20.73 | 21.12 | 21.02 |
| | 16QAM | 1 | 0 | 21.33 | 21.21 | 21.17 |
| | | 1 | 50 | 20.89 | 20.85 | 20.82 |
| | | 1 | 99 | 20.96 | 20.67 | 20.84 |
| | | 50 | 0 | 20.54 | 20.41 | 20.21 |
| | | 50 | 25 | 20.24 | 20.43 | 20.31 |
| | | 50 | 50 | 19.73 | 20.29 | 20.15 |
| | | 100 | 0 | 19.63 | 20.08 | 20 |

Table 11.17: The conducted Power for LTE BAND 2/4/5/7 Sensor on

| Band2 | | | | | | |
|-----------|-------|---------|-----------|-------------------------------|-----------------------------|-------------------------------|
| Bandwidth | Mode | RB Size | RB Offset | Actual output power(dBm) | | |
| | | | | Channel 18625 1852.5MHz | Channel 18900 1880MHz | Channel 19175 1907.5MHz |
| 5MHz | QPSK | 1 | 0 | 12.77 | 12.91 | 12.25 |
| | | 1 | 13 | 12.94 | 13.02 | 12.64 |
| | | 1 | 24 | 12.86 | 12.99 | 11.59 |
| | | 12 | 0 | 12.92 | 13.01 | 12.58 |
| | | 12 | 6 | 12.95 | 13.08 | 12.67 |
| | | 12 | 13 | 12.92 | 13.05 | 12.23 |
| | | 25 | 0 | 12.87 | 13.00 | 12.48 |
| | 16QAM | 1 | 0 | 12.64 | 12.81 | 12.56 |
| | | 1 | 13 | 13.29 | 13.30 | 12.89 |
| | | 1 | 24 | 12.78 | 12.75 | 11.85 |
| | | 12 | 0 | 12.95 | 12.96 | 12.67 |
| | | 12 | 6 | 13.03 | 13.07 | 12.72 |
| | | 12 | 13 | 12.90 | 13.00 | 12.29 |
| | | 25 | 0 | 12.97 | 13.12 | 12.53 |
| Bandwidth | Mode | RB Size | RB Offset | Actual output power(dBm) | | |
| | | | | Channel 18650 1855MHz | Channel 18900 1880MHz | Channel 19150 1905MHz |
| 10MHz | QPSK | 1 | 0 | 13.23 | 13.31 | 13.19 |
| | | 1 | 25 | 12.74 | 12.93 | 12.74 |
| | | 1 | 49 | 12.81 | 12.96 | 11.74 |
| | | 25 | 0 | 12.96 | 13.11 | 13.00 |
| | | 25 | 13 | 13.00 | 13.08 | 12.94 |
| | | 25 | 25 | 13.04 | 13.16 | 12.54 |
| | | 50 | 0 | 12.90 | 13.11 | 12.74 |
| | 16QAM | 1 | 0 | 12.64 | 12.84 | 12.45 |
| | | 1 | 25 | 12.91 | 13.16 | 12.91 |
| | | 1 | 49 | 12.78 | 12.78 | 11.48 |
| | | 25 | 0 | 12.87 | 13.07 | 12.98 |
| | | 25 | 13 | 12.92 | 13.05 | 12.89 |
| | | 25 | 25 | 12.96 | 13.08 | 12.51 |
| | | 50 | 0 | 12.91 | 13.01 | 12.69 |
| Bandwidth | Mode | RB Size | RB Offset | Actual output power(dBm) | | |
| | | | | Channel 18675 | Channel 18900 | Channel 19125 |

| Bandwidth | Mode | RB Size | RB Offset | 1857.5MHz | 1880MHz | 1902.5MHz |
|-----------|-------|---------|-----------|-----------------------------|-----------------------------|-----------------------------|
| | | | | Channel 18700 1860MHz | Channel 18900 1880MHz | Channel 19100 1900MHz |
| 15MHz | QPSK | 1 | 0 | 12.78 | 12.88 | 12.75 |
| | | 1 | 37 | 13.30 | 13.31 | 13.25 |
| | | 1 | 74 | 12.66 | 12.94 | 11.13 |
| | | 36 | 0 | 12.91 | 13.04 | 12.77 |
| | | 36 | 19 | 13.06 | 13.03 | 13.00 |
| | | 36 | 38 | 12.88 | 13.07 | 12.62 |
| | | 75 | 0 | 12.94 | 13.02 | 12.64 |
| | 16QAM | 1 | 0 | 12.79 | 12.96 | 13.14 |
| | | 1 | 37 | 13.11 | 13.00 | 13.25 |
| | | 1 | 74 | 12.83 | 12.88 | 12.54 |
| | | 36 | 0 | 12.94 | 13.04 | 13.09 |
| | | 36 | 19 | 12.97 | 12.98 | 13.14 |
| | | 36 | 38 | 12.80 | 13.01 | 12.53 |
| | | 75 | 0 | 12.87 | 13.01 | 12.59 |
| 20MHz | QPSK | 1 | 0 | 13.31 | 13.32 | 13.22 |
| | | 1 | 50 | 12.91 | 13.01 | 13.04 |
| | | 1 | 99 | 12.79 | 12.85 | 10.99 |
| | | 50 | 0 | 13.07 | 13.18 | 13.11 |
| | | 50 | 25 | 12.98 | 13.02 | 13.05 |
| | | 50 | 50 | 12.85 | 12.98 | 12.45 |
| | | 100 | 0 | 13.03 | 13.12 | 12.88 |
| | 16QAM | 1 | 0 | 12.64 | 12.91 | 12.33 |
| | | 1 | 50 | 13.17 | 13.15 | 13.16 |
| | | 1 | 99 | 12.71 | 12.64 | 11.33 |
| | | 50 | 0 | 12.94 | 12.98 | 12.89 |
| | | 50 | 25 | 13.09 | 13.06 | 13.14 |
| | | 50 | 50 | 12.88 | 12.99 | 12.58 |
| | | 100 | 0 | 12.86 | 13.01 | 12.73 |
| 3MHz | QPSK | 1 | 0 | 12.59 | 12.83 | 12.49 |
| | | 1 | 7 | 12.96 | 13.08 | 12.43 |
| | | 1 | 14 | 12.79 | 12.92 | 11.95 |
| | | 8 | 0 | 12.92 | 13.10 | 12.54 |
| | | 8 | 4 | 12.93 | 13.10 | 12.46 |

| Bandwidth | Mode | RB Size | RB Offset | Actual output power(dBm) | | |
|-----------|-------|---------|-----------|----------------------------|--------------------------|----------------------------|
| | | | | Channel 18607 1850.7MHz | Channel 18900 1880MHz | Channel 19193 1909.3MHz |
| | 16QAM | 8 | 7 | 12.89 | 13.07 | 12.27 |
| | | 15 | 0 | 12.94 | 13.02 | 12.39 |
| | | 1 | 0 | 12.93 | 13.18 | 12.76 |
| | | 1 | 7 | 13.24 | 13.15 | 12.75 |
| | | 1 | 14 | 13.19 | 13.04 | 12.24 |
| | | 8 | 0 | 13.02 | 13.14 | 12.64 |
| | | 8 | 4 | 13.06 | 13.16 | 12.57 |
| | | 8 | 7 | 13.04 | 13.16 | 12.37 |
| | | 15 | 0 | 12.95 | 13.02 | 12.46 |
| 1.4MHz | QPSK | 1 | 0 | 12.94 | 13.09 | 12.76 |
| | | 1 | 3 | 13.14 | 13.28 | 12.85 |
| | | 1 | 5 | 13.21 | 13.31 | 12.83 |
| | | 3 | 0 | 13.07 | 13.16 | 12.56 |
| | | 3 | 1 | 12.85 | 13.17 | 12.60 |
| | | 3 | 3 | 12.88 | 13.11 | 12.61 |
| | | 6 | 0 | 12.94 | 13.11 | 12.68 |
| | 16QAM | 1 | 0 | 12.59 | 12.83 | 12.50 |
| | | 1 | 3 | 12.71 | 13.08 | 12.54 |
| | | 1 | 5 | 12.91 | 13.09 | 12.51 |
| | | 3 | 0 | 12.87 | 13.01 | 12.50 |
| | | 3 | 1 | 12.85 | 13.02 | 12.54 |
| | | 3 | 3 | 12.80 | 13.07 | 12.54 |
| | | 6 | 0 | 12.78 | 13.05 | 12.55 |

| Band4 | | | | | | |
|-----------|-------|---------|-----------|----------------------------|----------------------------|----------------------------|
| Bandwidth | Mode | RB Size | RB Offset | Actual output power(dBm) | | |
| | | | | Channel 19975 1712.5MHz | Channel 20175 1732.5MHz | Channel 20375 1752.5MHz |
| 5MHz | QPSK | 1 | 0 | 13.06 | 13.31 | 13.11 |
| | | 1 | 13 | 12.73 | 13.16 | 12.78 |
| | | 1 | 24 | 11.99 | 13.01 | 12.22 |
| | | 12 | 0 | 12.48 | 13.18 | 12.68 |
| | | 12 | 6 | 12.71 | 13.20 | 12.69 |
| | | 12 | 13 | 12.41 | 13.17 | 12.56 |
| | | 25 | 0 | 12.52 | 13.17 | 12.61 |
| | 16QAM | 1 | 0 | 12.33 | 12.89 | 12.51 |

| | | 1 | 13 | 12.83 | 13.02 | 12.27 |
|-----------|-------|---------|-----------|-------------------------------|-------------------------------|-------------------------------|
| | | 1 | 24 | 12.28 | 12.88 | 12.48 |
| | | 12 | 0 | 12.53 | 13.26 | 12.60 |
| | | 12 | 6 | 12.71 | 13.26 | 12.73 |
| | | 12 | 13 | 12.41 | 13.23 | 12.56 |
| | | 25 | 0 | 12.50 | 13.19 | 12.67 |
| Bandwidth | Mode | RB Size | RB Offset | Actual output power(dBm) | | |
| | | | | Channel 20000 1715MHz | Channel 20175 1732.5MHz | Channel 20350 1750MHz |
| 10MHz | QPSK | 1 | 0 | 12.10 | 12.83 | 12.28 |
| | | 1 | 25 | 12.92 | 13.28 | 13.12 |
| | | 1 | 49 | 12.29 | 12.89 | 12.18 |
| | | 25 | 0 | 12.44 | 13.17 | 12.50 |
| | | 25 | 13 | 12.56 | 13.26 | 12.71 |
| | | 25 | 25 | 12.37 | 13.25 | 12.49 |
| | | 50 | 0 | 12.36 | 13.33 | 12.64 |
| | 16QAM | 1 | 0 | 12.64 | 12.78 | 12.99 |
| | | 1 | 25 | 12.63 | 13.07 | 13.13 |
| | | 1 | 49 | 12.04 | 12.83 | 12.91 |
| | | 25 | 0 | 12.45 | 13.24 | 13.14 |
| | | 25 | 13 | 12.57 | 13.21 | 12.79 |
| | | 25 | 25 | 12.40 | 13.20 | 12.47 |
| | | 50 | 0 | 12.38 | 13.19 | 12.70 |
| Bandwidth | Mode | RB Size | RB Offset | Actual output power(dBm) | | |
| | | | | Channel 20025 1717.5MHz | Channel 20175 1732.5MHz | Channel 20325 1747.5MHz |
| 15MHz | QPSK | 1 | 0 | 12.71 | 12.95 | 13.18 |
| | | 1 | 38 | 13.16 | 13.20 | 13.18 |
| | | 1 | 74 | 11.70 | 12.72 | 12.79 |
| | | 36 | 0 | 12.11 | 13.15 | 13.31 |
| | | 36 | 18 | 12.72 | 13.27 | 13.11 |
| | | 36 | 39 | 12.50 | 13.04 | 13.10 |
| | | 75 | 0 | 12.35 | 13.08 | 13.14 |
| | 16QAM | 1 | 0 | 12.84 | 13.21 | 13.13 |
| | | 1 | 38 | 12.85 | 13.04 | 13.04 |
| | | 1 | 74 | 11.46 | 12.99 | 13.01 |
| | | 36 | 0 | 12.11 | 13.14 | 13.38 |
| | | 36 | 18 | 12.71 | 13.19 | 13.06 |
| | | 36 | 39 | 12.50 | 13.11 | 13.01 |
| | | 75 | 0 | 12.36 | 13.14 | 13.15 |
| Bandwidth | Mode | RB Size | RB Offset | Actual output power(dBm) | | |

| | | | | Channel 20050 1720MHz | Channel 20175 1732.5MHz | Channel 20300 1745MHz |
|-----------|-------|---------|-----------|-------------------------------|-------------------------------|-------------------------------|
| | | | | Channel 19965 1711.5MHz | Channel 20175 1732.5MHz | Channel 20385 1753.5MHz |
| 20MHz | QPSK | 1 | 0 | 13.28 | 13.41 | 13.31 |
| | | 1 | 50 | 12.80 | 13.14 | 13.05 |
| | | 1 | 99 | 11.72 | 12.96 | 12.99 |
| | | 50 | 0 | 13.10 | 13.28 | 13.10 |
| | | 50 | 25 | 12.59 | 13.22 | 13.03 |
| | | 50 | 50 | 12.38 | 13.17 | 12.95 |
| | | 100 | 0 | 13.10 | 13.37 | 13.07 |
| | 16QAM | 1 | 0 | 12.76 | 12.96 | 12.99 |
| | | 1 | 50 | 13.10 | 13.32 | 13.00 |
| | | 1 | 99 | 12.01 | 12.12 | 11.69 |
| | | 50 | 0 | 12.23 | 13.14 | 12.33 |
| | | 50 | 25 | 12.61 | 13.18 | 12.69 |
| | | 50 | 50 | 12.39 | 13.14 | 12.29 |
| | | 100 | 0 | 12.33 | 13.25 | 12.31 |
| Bandwidth | Mode | RB Size | RB Offset | Actual output power(dBm) | | |
| | | | | Channel 19965 1711.5MHz | Channel 20175 1732.5MHz | Channel 20385 1753.5MHz |
| 3MHz | QPSK | 1 | 0 | 12.42 | 13.19 | 12.50 |
| | | 1 | 8 | 12.70 | 13.07 | 12.90 |
| | | 1 | 14 | 12.47 | 13.05 | 12.63 |
| | | 8 | 0 | 12.66 | 13.18 | 12.68 |
| | | 8 | 4 | 12.70 | 13.20 | 12.80 |
| | | 8 | 7 | 12.58 | 13.23 | 12.77 |
| | | 15 | 0 | 12.61 | 13.18 | 12.72 |
| | 16QAM | 1 | 0 | 12.67 | 13.27 | 12.78 |
| | | 1 | 8 | 13.03 | 13.36 | 13.21 |
| | | 1 | 15 | 12.74 | 13.32 | 12.90 |
| | | 8 | 0 | 12.76 | 13.39 | 12.81 |
| | | 8 | 4 | 12.81 | 13.45 | 12.85 |
| | | 8 | 7 | 12.68 | 13.47 | 12.82 |
| | | 15 | 0 | 12.68 | 13.33 | 12.73 |
| Bandwidth | Mode | RB Size | RB Offset | Actual output power(dBm) | | |
| | | | | Channel 19957 1710.7MHz | Channel 20175 1732.5MHz | Channel 20393 1754.3MHz |
| 1.4MHz | QPSK | 1 | 0 | 12.71 | 13.23 | 12.80 |
| | | 1 | 2 | 12.86 | 13.30 | 13.05 |
| | | 1 | 5 | 13.04 | 13.31 | 13.07 |
| | | 3 | 0 | 12.49 | 13.09 | 12.56 |

| | | | | | |
|-------|---|---|-------|-------|-------|
| 16QAM | 3 | 1 | 12.58 | 13.11 | 12.76 |
| | 3 | 2 | 12.75 | 13.12 | 12.78 |
| | 6 | 0 | 12.64 | 13.18 | 12.82 |
| | 1 | 0 | 12.43 | 13.05 | 12.50 |
| | 1 | 2 | 12.54 | 13.08 | 12.67 |
| | 1 | 5 | 12.71 | 13.10 | 12.70 |
| | 3 | 0 | 12.47 | 13.15 | 12.52 |
| | 3 | 1 | 12.55 | 13.14 | 12.68 |
| | 3 | 2 | 12.68 | 13.14 | 12.70 |
| | 6 | 0 | 12.54 | 13.15 | 12.68 |

| Band5 | | | | | | |
|-----------|-------|---------|-----------|---------------------------|---------------------------|---------------------------|
| Bandwidth | Mode | RB Size | RB Offset | Actual output power(dBm) | | |
| | | | | Channel 20425 826.5MHz | Channel 20525 836.5MHz | Channel 20625 846.5MHz |
| 5MHz | QPSK | 1 | 0 | 15.65 | 16.27 | 15.8 |
| | | 1 | 12 | 16.09 | 16.25 | 15.64 |
| | | 1 | 24 | 16.07 | 16.1 | 15.62 |
| | | 12 | 0 | 14.93 | 15.57 | 14.69 |
| | | 12 | 6 | 14.92 | 15.44 | 14.74 |
| | | 12 | 13 | 15.06 | 15.37 | 14.57 |
| | | 25 | 0 | 14.9 | 15.51 | 14.71 |
| | 16QAM | 1 | 0 | 14.68 | 15.33 | 14.82 |
| | | 1 | 12 | 15.07 | 15.33 | 14.53 |
| | | 1 | 24 | 15.06 | 15.03 | 14.42 |
| | | 12 | 0 | 13.99 | 14.52 | 13.44 |
| | | 12 | 6 | 13.87 | 14.51 | 13.81 |
| | | 12 | 13 | 13.97 | 14.4 | 13.49 |
| | | 25 | 0 | 13.79 | 14.45 | 13.66 |
| Bandwidth | Mode | RB Size | RB Offset | Actual output power(dBm) | | |
| | | | | Channel 20450 829MHz | Channel 20525 836.5MHz | Channel 20600 844MHz |
| 10MHz | QPSK | 1 | 0 | 16.14 | 16.41 | 16.19 |
| | | 1 | 25 | 16.28 | 16.3 | 15.97 |
| | | 1 | 49 | 16.16 | 15.86 | 15.36 |
| | | 25 | 0 | 15.44 | 15.67 | 15.49 |
| | | 25 | 13 | 15.23 | 15.4 | 14.85 |
| | | 25 | 25 | 15.48 | 15.28 | 14.7 |
| | | 50 | 0 | 15.3 | 15.46 | 14.82 |

| | | | | | | |
|-----------|-------|---------|-----------|---------------------------|------------------------------|---------------------------|
| | | 1 | 0 | 15.19 | 15.38 | 15.21 |
| | | 1 | 25 | 15.27 | 15.37 | 14.85 |
| | | 1 | 49 | 15.15 | 14.8 | 14.16 |
| | 16QAM | 25 | 0 | 14.01 | 14.59 | 13.44 |
| | | 25 | 13 | 14.16 | 14.46 | 13.92 |
| | | 25 | 25 | 14.4 | 14.3 | 13.62 |
| | | 50 | 0 | 14.2 | 14.42 | 13.8 |
| Bandwidth | Mode | RB Size | RB Offset | Channel 20415 825.5MHz | | |
| | | | | Channel 20415 825.5MHz | Channel 20525 836.5MHz | Channel 20635 847.5MHz |
| 3MHz | QPSK | 1 | 0 | 15.47 | 16.19 | 15.39 |
| | | 1 | 7 | 15.6 | 16.14 | 15.5 |
| | | 1 | 14 | 15.67 | 16.1 | 15.27 |
| | | 8 | 0 | 14.77 | 15.63 | 14.88 |
| | | 8 | 4 | 14.91 | 15.49 | 14.65 |
| | | 8 | 7 | 14.91 | 15.32 | 14.59 |
| | | 15 | 0 | 14.97 | 15.57 | 14.56 |
| | 16QAM | 1 | 0 | 14.47 | 15.18 | 14.41 |
| | | 1 | 7 | 14.58 | 15.15 | 14.48 |
| | | 1 | 14 | 14.56 | 15.03 | 14.14 |
| | | 8 | 0 | 13.83 | 14.55 | 13.89 |
| | | 8 | 4 | 13.84 | 14.46 | 13.72 |
| | | 8 | 7 | 13.93 | 14.34 | 13.47 |
| | | 15 | 0 | 13.87 | 14.53 | 13.54 |
| Bandwidth | Mode | RB Size | RB Offset | Actual output power(dBm) | | |
| | | | | Channel 20407 824.7MHz | Channel 20525 836.5MHz | Channel 20643 848.3MHz |
| 1.4MHz | QPSK | 1 | 0 | 15.58 | 16.18 | 15.28 |
| | | 1 | 2 | 15.75 | 16.17 | 15.43 |
| | | 1 | 5 | 15.59 | 16.06 | 15.31 |
| | | 3 | 0 | 14.98 | 15.49 | 15.58 |
| | | 3 | 2 | 14.94 | 15.43 | 15.76 |
| | | 3 | 3 | 15.04 | 15.55 | 15.56 |
| | | 6 | 0 | 14.74 | 15.45 | 14.55 |
| | 16QAM | 1 | 0 | 14.6 | 14.87 | 14.85 |
| | | 1 | 2 | 14.64 | 14.88 | 14.95 |
| | | 1 | 5 | 14.62 | 14.57 | 14.6 |
| | | 3 | 0 | 14.68 | 14.68 | 14.78 |
| | | 3 | 2 | 14.76 | 14.8 | 14.8 |
| | | 3 | 3 | 14.94 | 14.89 | 14.95 |
| | | 6 | 0 | 13.78 | 13.8 | 13.82 |

| Band7 | | | | | | |
|-----------|-------|---------|-----------|----------------------------|--------------------------|----------------------------|
| Bandwidth | Mode | RB Size | RB Offset | Actual output power(dBm) | | |
| | | | | Channel 20775 2502.5MHz | Channel 21100 2535MHz | Channel 21425 2567.5MHz |
| 5MHz | QPSK | 1 | 0 | 11.04 | 11.01 | 11.4 |
| | | 1 | 13 | 11.63 | 11.61 | 11.61 |
| | | 1 | 24 | 10.75 | 10.85 | 11.45 |
| | | 12 | 0 | 11.45 | 11.38 | 11.45 |
| | | 12 | 6 | 11.48 | 11.41 | 11.42 |
| | | 12 | 13 | 11.38 | 11.38 | 11.42 |
| | | 25 | 0 | 11.39 | 11.37 | 11.31 |
| | 16QAM | 1 | 0 | 11.02 | 10.51 | 11.32 |
| | | 1 | 13 | 11.32 | 11.30 | 11.32 |
| | | 1 | 24 | 10.71 | 10.82 | 11.35 |
| | | 12 | 0 | 11.45 | 11.32 | 11.35 |
| | | 12 | 6 | 11.32 | 11.31 | 11.37 |
| | | 12 | 13 | 11.35 | 11.34 | 11.32 |
| | | 25 | 0 | 11.42 | 11.31 | 11.31 |
| Bandwidth | Mode | RB Size | RB Offset | Actual output power(dBm) | | |
| | | | | Channel 20800 2505MHz | Channel 21100 2535MHz | Channel 21400 2565MHz |
| 10MHz | QPSK | 1 | 0 | 11.02 | 11.24 | 11.07 |
| | | 1 | 25 | 11.44 | 11.42 | 11.47 |
| | | 1 | 49 | 10.65 | 10.8 | 11.34 |
| | | 25 | 0 | 11.47 | 11.34 | 11.37 |
| | | 25 | 13 | 11.32 | 11.41 | 11.38 |
| | | 25 | 25 | 11.24 | 11.36 | 11.32 |
| | | 50 | 0 | 11.26 | 11.35 | 11.33 |
| | 16QAM | 1 | 0 | 11.01 | 11.21 | 11.09 |
| | | 1 | 25 | 11.31 | 11.22 | 11.32 |
| | | 1 | 49 | 10.61 | 10.56 | 11.32 |
| | | 25 | 0 | 11.42 | 11.32 | 11.31 |
| | | 25 | 13 | 11.42 | 11.41 | 11.48 |
| | | 25 | 25 | 11.14 | 11.36 | 11.32 |
| | | 50 | 0 | 11.24 | 11.32 | 11.33 |
| Bandwidth | Mode | RB Size | RB Offset | Actual output power(dBm) | | |
| | | | | Channel 20825 2507.5MHz | Channel 21100 2535MHz | Channel 21375 2562.5MHz |
| 15MHz | QPSK | 1 | 0 | 10.73 | 10.65 | 10.72 |
| | | 1 | 38 | 11.36 | 11.57 | 11.56 |

| | | | | | | |
|-------|-----------|------|---------|--------------------------|--------------------------|--------------------------|
| | | 1 | 74 | 10.62 | 10.74 | 11.29 |
| | | 36 | 0 | 11.33 | 11.39 | 11.42 |
| | | 36 | 18 | 11.38 | 11.31 | 11.32 |
| | | 36 | 39 | 11.28 | 11.3 | 11.25 |
| | | 75 | 0 | 11.31 | 11.3 | 11.39 |
| | 16QAM | 1 | 0 | 10.53 | 10.55 | 10.62 |
| | | 1 | 38 | 11.32 | 11.51 | 11.56 |
| | | 1 | 74 | 10.42 | 10.34 | 11.22 |
| | | 36 | 0 | 11.32 | 11.33 | 11.42 |
| | | 36 | 18 | 11.42 | 11.37 | 11.32 |
| | | 36 | 39 | 11.22 | 11.21 | 11.35 |
| | | 75 | 0 | 11.24 | 11.21 | 11.39 |
| | Bandwidth | Mode | RB Size | RB Offset | Actual output power(dBm) | |
| | | | | Channel 20850 2510MHz | Channel 21100 2535MHz | Channel 21350 2560MHz |
| 20MHz | QPSK | 1 | 0 | 11.52 | 11.64 | 11.57 |
| | | 1 | 50 | 11.34 | 11.07 | 11.47 |
| | | 1 | 99 | 10.65 | 10.8 | 11.34 |
| | | 50 | 0 | 11.23 | 11.48 | 11.43 |
| | | 50 | 25 | 11.54 | 11.4 | 11.51 |
| | | 50 | 50 | 11.34 | 11.39 | 11.32 |
| | | 100 | 0 | 11.36 | 11.42 | 11.37 |
| | 16QAM | 1 | 0 | 11.51 | 11.62 | 11.53 |
| | | 1 | 50 | 11.31 | 11.02 | 11.42 |
| | | 1 | 99 | 10.63 | 10.77 | 11.32 |
| | | 50 | 0 | 11.22 | 11.43 | 11.42 |
| | | 50 | 25 | 11.52 | 11.38 | 11.41 |
| | | 50 | 50 | 11.34 | 11.41 | 11.42 |
| | | 100 | 0 | 11.26 | 11.41 | 11.27 |

11.4.LTE Carrier Aggregation

LTE Carrier Aggregation Conducted Power (Downlink)

1. According to KDB941225 D05A v01r02, Uplink maximum output power measurement with downlink carrier aggregation active should be measured, using the highest output channel measured without downlink carrier aggregation, to confirm that uplink maximum output power with downlink carrier aggregation active remains within the specified tune-up tolerance limits and not more than ¼ dB higher than the maximum output measured without downlink carrier aggregation active.
2. Uplink maximum output power with downlink carrier aggregation active does not show more than ¼ dB higher than the maximum output power without downlink carrier aggregation active, therefore SAR evaluation with downlink carrier aggregation active can be excluded.
3. For power measurement were control and acknowledge data is sent on uplink channels that operate identical to specifications when downlink carrier aggregation is inactive.
4. Selected highest measured power when downlink carrier aggregation is inactive for conducted power comparison with downlink carrier aggregation is active, to confirm that when downlink carrier aggregation is active uplink maximum output power remains within the specified tune-up tolerance limits and not more than ¼ dB higher than the maximum output power measured when downlink carrier aggregation inactive.
5. For inter-band CA, the SCC selected highest bandwidth and near the middle of its transmission band. For SCC DL RB size and offset will base on the PCC corresponding RB allocation.

Maximum Average RF Power (Proximity Sensor off)

| | PCC | | | | | | SCC | | | | Power | |
|-----------|----------|----------|-------------|---------|--------|--------------|----------|----------|-------------|---------|---------------------------|--------------------------|
| | LTE Band | BW (MHz) | Freq. (MHz) | Channel | UL# RB | UL RB Offset | LTE Band | BW (MHz) | Freq. (MHz) | Channel | LTE Rel 10 Tx.Power (dBm) | LTE Rel 8 Tx.Power (dBm) |
| Configure | 4 | 20 | 1732.5 | 20175 | 1 | 0 | 13 | 10 | 751 | 5230 | 23.43 | 23.45 |
| | 13 | 10 | 782 | 23230 | 1 | 0 | 4 | 20 | 2132.5 | 2175 | 23.92 | 23.97 |
| | 2 | 20 | 1880 | 18900 | 1 | 0 | 13 | 10 | 751 | 5230 | 23.25 | 23.26 |
| | 13 | 10 | 782 | 23230 | 1 | 0 | 2 | 20 | 1950 | 800 | 23.96 | 23.97 |
| | 2 | 20 | 1880 | 18900 | 1 | 0 | 4 | 20 | 2132.5 | 2175 | 23.27 | 23.26 |
| | 4 | 20 | 1732.5 | 20175 | 1 | 0 | 2 | 20 | 1950 | 800 | 23.41 | 23.45 |
| | 2 | 20 | 1880 | 18900 | 1 | 0 | 2 | 20 | 1950 | 800 | 23.24 | 23.26 |
| | 4 | 20 | 1732.5 | 20175 | 1 | 0 | 4 | 20 | 2132.5 | 2175 | 23.41 | 23.45 |
| | 4 | 20 | 1732.5 | 20175 | 1 | 0 | 5 | 10 | 881.5 | 2525 | 23.46 | 23.45 |
| | 5 | 10 | 836.5 | 20525 | 1 | 0 | 4 | 20 | 2132.5 | 2175 | 23.41 | 23.44 |
| | 2 | 20 | 1880 | 18900 | 1 | 0 | 5 | 10 | 881.5 | 2525 | 23.21 | 23.26 |
| | 5 | 10 | 836.5 | 20525 | 1 | 0 | 2 | 20 | 1950 | 800 | 23.42 | 23.44 |

Maximum Average RF Power (Proximity Sensor on)

| | PCC | | | | | | SCC | | | | Power | |
|-----------|----------|----------|-------------|---------|--------|--------------|----------|----------|-------------|---------|---------------------------|--------------------------|
| | LTE Band | BW (MHz) | Freq. (MHz) | Channel | UL# RB | UL RB Offset | LTE Band | BW (MHz) | Freq. (MHz) | Channel | LTE Rel 10 Tx.Power (dBm) | LTE Rel 8 Tx.Power (dBm) |
| Configure | 4 | 20 | 1732.5 | 20175 | 1 | 0 | 13 | 10 | 751 | 5230 | 13.31 | 13.33 |
| | 13 | 10 | 782 | 23230 | 1 | 0 | 4 | 20 | 2132.5 | 2175 | 17.99 | 17.96 |
| | 2 | 20 | 1880 | 18900 | 1 | 0 | 13 | 10 | 751 | 5230 | 13.35 | 13.32 |
| | 13 | 10 | 782 | 23230 | 1 | 0 | 2 | 20 | 1950 | 800 | 17.95 | 17.96 |
| | 2 | 20 | 1880 | 18900 | 1 | 0 | 4 | 20 | 2132.5 | 2175 | 13.31 | 13.32 |
| | 4 | 20 | 1732.5 | 20175 | 1 | 0 | 2 | 20 | 1950 | 800 | 13.34 | 13.33 |
| | 2 | 20 | 1880 | 18900 | 1 | 0 | 2 | 20 | 1950 | 800 | 13.33 | 13.32 |
| | 4 | 20 | 1732.5 | 20175 | 1 | 0 | 4 | 20 | 2132.5 | 2175 | 13.31 | 13.33 |
| | 4 | 20 | 1732.5 | 20175 | 1 | 0 | 5 | 10 | 881.5 | 2525 | 13.36 | 13.33 |
| | 5 | 10 | 836.5 | 20525 | 1 | 0 | 4 | 20 | 2132.5 | 2175 | 16.42 | 16.41 |
| | 2 | 20 | 1880 | 18900 | 1 | 0 | 5 | 10 | 881.5 | 2525 | 13.34 | 13.32 |
| | 5 | 10 | 836.5 | 20525 | 1 | 0 | 2 | 20 | 1950 | 800 | 16.45 | 16.41 |

11.5. Wi-Fi and BT Measurement result

Table 11.18: The conducted power for Bluetooth

| GFSK | | | |
|---------------------------------|----------------|----------------|----------------|
| Channel | Ch0 (2402 MHz) | Ch39 (2441MHz) | CH78 (2480MHz) |
| Conducted Output Power (dBm) | 2.031 | 2.932 | 0.459 |
| $\pi/4$ DQPSK | | | |
| Channel | Ch0 (2402 MHz) | Ch39 (2441MHz) | CH78 (2480MHz) |
| Conducted Output Power (dBm) | 1.444 | 2.397 | -0.09 |
| 8DPSK | | | |
| Channel | Ch0 (2402 MHz) | Ch39 (2441MHz) | CH78 (2480MHz) |
| Conducted Output Power (dBm) | 1.657 | 2.604 | 0.139 |

Table 11.19: The conducted power for Bluetooth 4.0

| GFSK | | | |
|------------------------------|--------------|---------------|---------------|
| Channel | Ch0 2402 MHz | Ch19 2440 MHz | CH39 2480 MHz |
| Conducted Output Power (dBm) | -2.45 | -1.901 | -4.754 |

NOTE: According to KDB447498 D01 BT standalone SAR are not required, because maximum average output power is less than 10mW.

According to RSS 102 issue5 section 2.5.1 Exemption Limits for Routine Evaluation – SAR Evaluation, BT standalone SAR are not required, because maximum average output power is less than 4mW.

| Frequency (MHz) | Exemption Limits (mW) | | | | |
|-----------------|---------------------------------------|---------------------------------|---------------------------------|---------------------------------|---------------------------------|
| | At separation distance of ≤ 5 mm | At separation distance of 10 mm | At separation distance of 15 mm | At separation distance of 20 mm | At separation distance of 25 mm |
| ≤ 300 | 71 mW | 101 mW | 132 mW | 162 mW | 193 mW |
| 450 | 52 mW | 70 mW | 88 mW | 106 mW | 123 mW |
| 835 | 17 mW | 30 mW | 42 mW | 55 mW | 67 mW |
| 1900 | 7 mW | 10 mW | 18 mW | 34 mW | 60 mW |
| 2450 | 4 mW | 7 mW | 15 mW | 30 mW | 52 mW |
| 3500 | 2 mW | 6 mW | 16 mW | 32 mW | 55 mW |
| 5800 | 1 mW | 6 mW | 15 mW | 27 mW | 41 mW |

When the standalone SAR test exclusion is applied to an antenna that transmits simultaneously with other antennas, the standalone SAR must be estimated according to the following to determine simultaneous transmission SAR test exclusion:

(max. power of channel, including tune-up tolerance, mW)/(min. test separation distance, mm)]·[$\sqrt{f(\text{GHz})/x}$] W/kg for test separation distances ≤ 50 mm;
where $x = 7.5$ for 1-g SAR, and $x = 18.75$ for 10-g SAR.

SAR body value of BT is 0.083 W/Kg.

The default power measurement procedures are:

- a) Power must be measured at each transmit antenna port according to the DSSS and OFDM transmission configurations in each standalone and aggregated frequency band.
- b) Power measurement is required for the transmission mode configuration with the highest maximum output power specified for production units.
 - 1) When the same highest maximum output power specification applies to multiple transmission modes, the largest channel bandwidth configuration with the lowest order modulation and lowest data rate is measured.
 - 2) When the same highest maximum output power is specified for multiple largest channel bandwidth configurations with the same lowest order modulation or lowest order modulation and lowest data rate, power measurement is required for all equivalent 802.11 configurations with the same maximum output power.
- c) For each transmission mode configuration, power must be measured for the highest and lowest channels; and at the mid-band channel(s) when there are at least 3 channels. For configurations with multiple mid-band channels, due to an even number of channels, both channels should be measured.

During WLAN SAR testing EUT is configured with the WLAN continuous TX tool, and the transmission duty factor was monitored on the spectrum analyzer with zero-span setting.

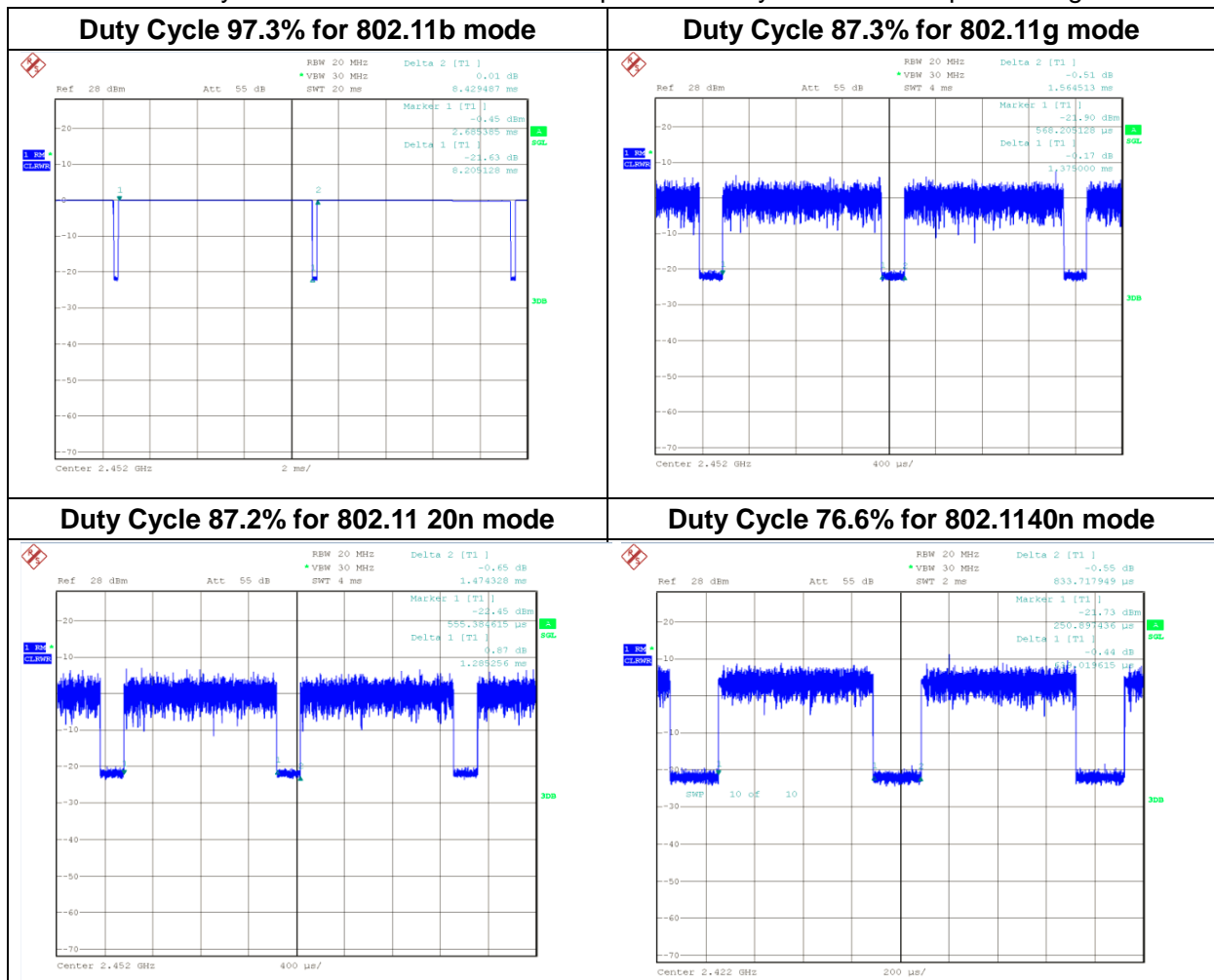

Table 11.19: The average conducted power for WiFi

| Mode | Channel | Frequency | Average power(dBm) |
|----------------------------|---------|-----------|--------------------|
| 802.11 b Sensor off | 1 | 2412 MHZ | 14.77 |
| | 6 | 2437 MHZ | 14.63 |
| | 11 | 2462 MHZ | 13.47 |
| 802.11 g Sensor off | 1 | 2412 MHZ | 14.51 |
| | 6 | 2437 MHZ | 13.97 |
| | 11 | 2462 MHZ | 13.22 |
| 802.11 n 20M Sensor off | 1 | 2412 MHZ | 14.05 |
| | 6 | 2437 MHZ | 13.82 |
| | 11 | 2462 MHZ | 14.41 |
| 802.11 n 40M Sensor off | 3 | 2422 MHZ | 14.18 |
| | 6 | 2437 MHZ | 14.03 |
| | 9 | 2452 MHZ | 13.53 |
| 802.11 b Sensor on | 1 | 2412 MHZ | 9.31 |
| | 6 | 2437 MHZ | 9.25 |
| | 11 | 2462 MHZ | 8.29 |
| 802.11 g Sensor on | 1 | 2412 MHZ | 8.41 |
| | 6 | 2437 MHZ | 8.29 |
| | 11 | 2462 MHZ | 7.51 |
| 802.11 n 20M Sensor on | 1 | 2412 MHZ | 8.39 |
| | 6 | 2437 MHZ | 8.27 |
| | 11 | 2462 MHZ | 7.39 |
| 802.11 n 40M Sensor on | 3 | 2422 MHZ | 8.37 |
| | 6 | 2437 MHZ | 8.14 |
| | 9 | 2452 MHZ | 7.80 |

2.4 GHz 802.11g/n OFDM SAR Test Exclusion Requirements

When SAR measurement is required for 2.4 GHz 802.11g/n OFDM configurations, the measurement and test reduction procedures for OFDM are applied. SAR is not required for the following 2.4 GHz OFDM conditions.

- a) When KDB Publication 447498 D01 SAR test exclusion applies to the OFDM configuration.
- b) When the highest *reported* SAR for DSSS is adjusted by the ratio of OFDM to DSSS specified maximum output power and the adjusted SAR is ≤ 1.2 W/kg.

12. Simultaneous TX SAR Considerations

12.1. Introduction

The following procedures adopted from “FCC SAR Considerations for Cell Phones with Multiple Transmitters” are applicable to handsets with built-in unlicensed transmitters such as 802.11 a/b/g and Bluetooth devices which may simultaneously transmit with the licensed transmitter.

For this device, the BT and Wi-Fi 2.4GHz can transmit simultaneous with other transmitters.

Wi-Fi 5GHz not support hotspot mode, so simultaneously transmit not required.

12.2. Transmit Antenna Separation Distances

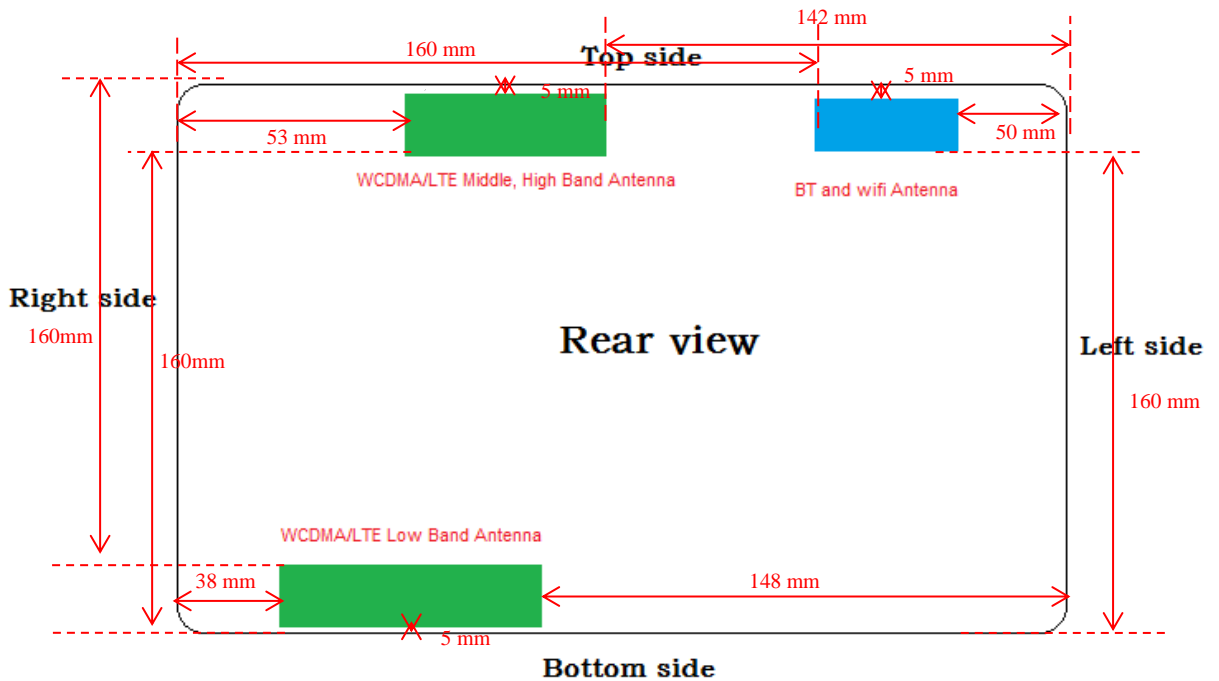

Picture 12.1 Antenna Locations

12.3. Standalone SAR Test Exclusion Considerations

Standalone 1-g head or body SAR evaluation by measurement or numerical simulation is not required when the corresponding SAR Exclusion Threshold condition, listed below, is satisfied.

The 1-g SAR test exclusion threshold for 100 MHz to 6 GHz at test separation distances ≤ 50 mm are determined by:

$$\left[\frac{\text{(max. power of channel, including tune-up tolerance, mW)}}{\text{(min. test separation distance, mm)}} \cdot \sqrt{f(\text{GHz})} \right] \leq 3.0$$
 for 1-g SAR, where

- $f(\text{GHz})$ is the RF channel transmit frequency in GHz
- Power and distance are rounded to the nearest mW and mm before calculation
- The result is rounded to one decimal place for comparison

According to the KDB447498 appendix A, the SAR test exclusion threshold for 2450MHz at 5mm test separation distances is 10mW.

$$\frac{\text{(max. power of channel, including tune-up tolerance, mW)}}{\text{(min. test separation distance, mm)}} \cdot \sqrt{\text{Frequency (GHz)}} \leq 3.0$$

Based on the above equation, Bluetooth SAR was not required:

Evaluation=0.626 < 3.0

Based on the above equation, WiFi SAR was required:

Evaluation=9.92 > 3.0

12.4. SAR Measurement Positions

The following SAR test exclusion Thresholds based on KDB 447498 D01 General RF Exposure Guidance v06 4.3.1

| Exposure Position | Wireless Interface | WCDMA | | LTE | | | | WLAN |
|-------------------|-------------------------|------------|------------|------------|------------|------------|------------|------------|
| | | Band2 | Band5 | Band2 | Band4 | Band5 | Band7 | 802.11 b |
| Exposure Position | Maximum power | 23.5 | 23.5 | 23.5 | 23.5 | 23.5 | 22.5 | 15 |
| | Maximum rated power(mW) | 223.87 | 223.87 | 223.87 | 223.87 | 223.87 | 117.83 | 31.62 |
| Rear view | Antenna to user (mm) | 5 | 5 | 5 | 5 | 5 | 5 | 5 |
| | SAR exclusion threshold | 10.88 | 16.27 | 10.88 | 11.18 | 16.27 | 9.03 | 9.58 |
| | SAR testing required? | Yes | Yes | Yes | Yes | Yes | Yes | Yes |
| Top | Antenna to user (mm) | 5 | 160 | 5 | 5 | 160 | 5 | 5 |
| | SAR exclusion threshold | 10.88 | 787.33 | 10.88 | 11.18 | 787.33 | 9.03 | 9.58 |
| | SAR testing required? | Yes | No | Yes | Yes | No | Yes | Yes |
| Left | Antenna to user (mm) | 142 | 148 | 142 | 142 | 148 | 142 | 50 |
| | SAR exclusion threshold | 1029.00 | 719.33 | 1029.00 | 1029.00 | 719.33 | 1029.00 | 95.83 |
| | SAR testing required? | No | No | No | No | No | No | No |
| Bottom | Antenna to user (mm) | 160 | 5 | 160 | 160 | 5 | 160 | 160 |
| | SAR exclusion threshold | 1209.00 | 16.27 | 1209.00 | 1209.00 | 16.27 | 1209.00 | 1196 |
| | SAR testing required? | No | Yes | No | No | Yes | No | No |
| Right | Antenna to user (mm) | 53 | 38 | 53 | 53 | 38 | 53 | 160 |
| | SAR exclusion threshold | 139.00 | 123.65 | 139.00 | 139.00 | 123.65 | 139.00 | 1196 |
| | SAR testing required? | Yes | Yes | Yes | Yes | Yes | Yes | No |

13. Power Reduction by Proximity Sensing

A proximity sensor for power reduction is implemented in this device to address RF exposure compliance when the cellular antenna is positioned close to the user's body. The sensor's mechanical structure is designed to fit within the enclosure design used in this device and also extended around the edge and top of the antenna element in order to optimize sensitivity in these orientations. This design combines the antenna printed directly on a plastic part and proximity sensor FPC (Flexible Printed Circuit) bonded together into one piece. According to KDB 616217 D04 SAR for laptop and tablets v01r02 6)

13.1. Procedures for determining proximity sensor triggering distances

The following procedures should be applied to determine proximity sensor triggering distances for the back surface and individual edges of a tablet. Conducted power is monitored qualitatively to identify the general triggering characteristics and recorded quantitatively, versus spacing, as required by the procedures. Unless there is built-in test software that reports the triggering conditions and enables the power levels to be confirmed separately, monitoring of conducted power during the triggering tests typically requires internal access to the antenna ports inside the tablet, which may interfere with the triggering tests.

- (1) The relevant transmitter should be set to operate at its normal maximum output power.
- (2) The entire back surface or edge of the tablet is positioned below a flat phantom filled with the required tissue-equivalent medium, and positioned at least 20 mm further than the distance that triggers power reduction.
- (3) It should be ensured that the cables required for power measurements are not interfering with the proximity sensor. Cable losses should be properly compensated to report the measured power results.
- (4) The back surface or edge is moved toward the phantom in 3 mm steps until the sensor triggers.
- (5) The back surface or edge is then moved back (further away) from the phantom by at least 5 mm or until maximum output power is returned to the normal maximum level.
- (6) The back surface or edge is again moved toward the phantom, but in 1 mm steps, until it is at least 5 mm past the triggering point or touching the phantom. If 1 mm resolution is not suitable for the sensor triggering sensitivity, a KDB inquiry should be submitted to determine alternative test configurations.
- (7) If the tablet is not touching the phantom, it is moved in 3 mm steps until it touches the phantom to confirm that the sensor remains triggered and the maximum power stays reduced.
- (8) The process is then reversed by moving the tablet away from the phantom according to steps 4) to 7), to determine triggering release, until it is at least 10 mm beyond the point that triggers the return of normal maximum power.
- (9) The measured output power within ± 5 mm of the triggering points, or until the tablet is touching the phantom, for movements to and from the phantom should be tabulated in the SAR report.

- (10) If the sensor design and implementation allow additional variations for triggering distance tolerances, multiple samples should be tested to determine the most conservative distance required for SAR evaluation.
- (11) To ensure all production units are compliant, it is generally necessary to reduce the triggering distance determined from the triggering tests by 1 mm, or more if it is necessary, and use the smallest distance for movements to and from the phantom, minus 1 mm, as the sensor triggering distance for determining the SAR measurement distance.

13.2. Procedures for determining antenna and proximity sensor coverage

The sensing regions are usually limited to areas near the sensor element. If a sensor is spatially offset from the antenna(s), it is necessary to verify sensor triggering for conditions where the antenna is next to the user but the sensor is laterally further away to ensure sensor coverage is sufficient for reducing the power to maintain compliance. The following are used to determine if additional SAR measurements may be necessary due to sensor and antenna offset. 25 These procedures do not apply and are not required for configurations where the antenna and sensor are collocated and the peak SAR location is overlapping with the sensor.

- (1) The back surface or edge of the tablet is positioned at a test separation distance less than or equal to the distance required for back surface or edge triggering, with both the antenna and sensor pad located at least 20 mm laterally outside the edge (boundary) of the phantom, along the direction of maximum antenna and sensor offset. For the back surface, if the direction of maximum offset is not aligned with the tablet coordinates (physical edges) the tablet test position would not be aligned with the phantom coordinates (orientations). Each applicable tablet edge should be positioned perpendicularly to the phantom to determine sensor coverage. For antennas and/or sensors located near the corner of a tablet, both adjacent edges must be considered.
- (2) The similar sequence of steps applied to determine sensor triggering distance in section 6.2 are used to verify back surface and edge sensor coverage by moving the tablet (sensor and antenna) horizontally toward the phantom while maintaining the same vertical separation between the back surface or edge and the phantom.
- (3) After the exact location where triggering of power reduction is determined, with respect to the sensor and antenna, the tablet movement should be continued, in 3 mm increments, until both the sensor and antenna(s) are fully under the phantom and at least 20 mm inside the phantom edge.
- (4) The process is then repeated from the opposite direction, starting at the other end of the maximum antenna and sensor offset, by rotating the tablet 180° along the vertical axis.
- (5) The triggering points should be documented graphically, with the antenna and sensor clearly identified, along with all relevant dimensions.
- (6) If the subsequently measured peak SAR location for the antenna is not between the triggering points, established by the sensor coverage tests from opposite ends of the antenna and sensor, additional SAR tests may be required for conditions where only part of the back

surface or edge of a tablet corresponding to the antenna is in proximity to the user and the sensor may not be triggering as desired. A KDB inquiry must be submitted by the test lab to determine if additional tests are required and the proper test configurations to use for testing. This may include situations where the sensor coverage region is too small for the antenna, the sensor is located too far away from the antenna, the sensor location is insufficient to cover multiple antennas or the antenna is at the corner of a tablet etc.

13.3. Proximity Sensor Status Table of trigger distance

As per the KDB 616217 D04 SAR for laptop and tablets v01r02, section 6.2, the following procedure is used to determine the triggering distances.

Proximity Sensor Status Table when DUT is moving towards the phantom

| Distance to the DUT (mm) | Proximity Sensor Status – Rear Surface | Proximity Sensor Status – Bottom-Edge | Proximity Sensor Status – Top-Edge |
|--------------------------|--|---------------------------------------|------------------------------------|
| 30 | OFF | OFF | OFF |
| 27 | OFF | OFF | OFF |
| 25 | OFF | OFF | OFF |
| 24 | ON | OFF | OFF |
| 23 | ON | OFF | OFF |
| 22 | ON | OFF | OFF |
| 21 | ON | OFF | OFF |
| 20 | ON | OFF | OFF |
| 19 | ON | OFF | OFF |
| 18 | ON | OFF | OFF |
| 17 | ON | OFF | OFF |
| 16 | ON | OFF | OFF |
| 15 | ON | ON | ON |
| 14 | ON | ON | ON |
| 13 | ON | ON | ON |
| 12 | ON | ON | ON |
| 11 | ON | ON | ON |
| 10 | ON | ON | ON |
| 9 | ON | ON | ON |
| 8 | ON | ON | ON |
| 7 | ON | ON | ON |
| 6 | ON | ON | ON |
| 5 | ON | ON | ON |
| 4 | ON | ON | ON |
| 3 | ON | ON | ON |
| 2 | ON | ON | ON |
| 1 | ON | ON | ON |
| 0 | ON | ON | ON |

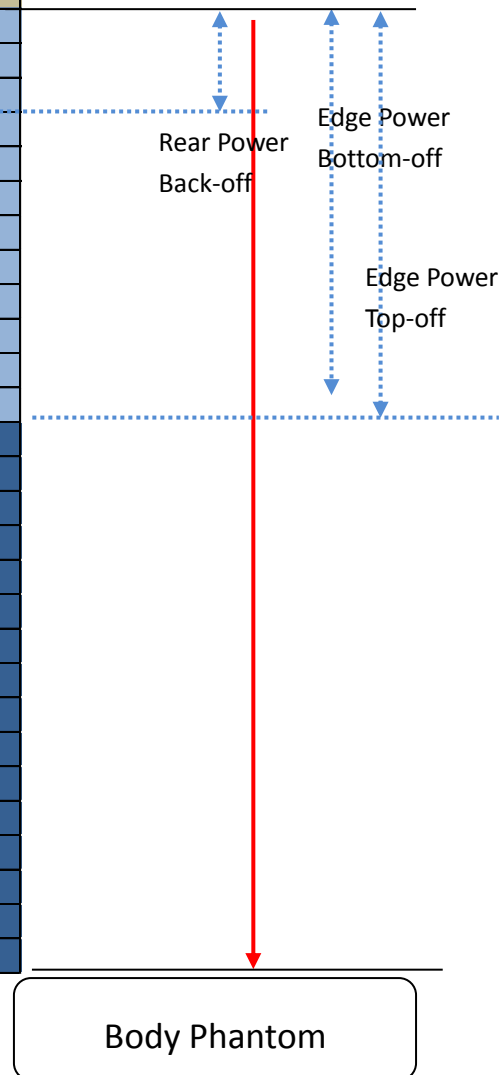

Proximity Sensor Status Table when DUT is moving away the phantom

Body Phantom

| Distance to the DUT (mm) | Proximity Sensor Status – Rear Surface | Proximity Sensor Status – Bottom-Edge | Proximity Sensor Status – Top-Edge |
|--------------------------|--|---------------------------------------|------------------------------------|
| 0 | ON | ON | ON |
| 1 | ON | ON | ON |
| 2 | ON | ON | ON |
| 3 | ON | ON | ON |
| 4 | ON | ON | ON |
| 5 | ON | ON | ON |
| 6 | ON | ON | ON |
| 7 | ON | ON | ON |
| 8 | ON | ON | ON |
| 9 | ON | ON | ON |
| 10 | ON | ON | ON |
| 11 | ON | ON | ON |
| 12 | ON | ON | ON |
| 13 | ON | ON | ON |
| 14 | ON | ON | ON |
| 15 | ON | ON | ON |
| 16 | ON | OFF | OFF |
| 17 | ON | OFF | OFF |
| 18 | ON | OFF | OFF |
| 19 | ON | OFF | OFF |
| 20 | ON | OFF | OFF |
| 21 | ON | OFF | OFF |
| 22 | ON | OFF | OFF |
| 23 | ON | OFF | OFF |
| 24 | ON | OFF | OFF |
| 25 | OFF | OFF | OFF |
| 26 | OFF | OFF | OFF |
| 27 | OFF | OFF | OFF |
| 28 | OFF | OFF | OFF |
| 29 | OFF | OFF | OFF |
| 30 | OFF | OFF | OFF |

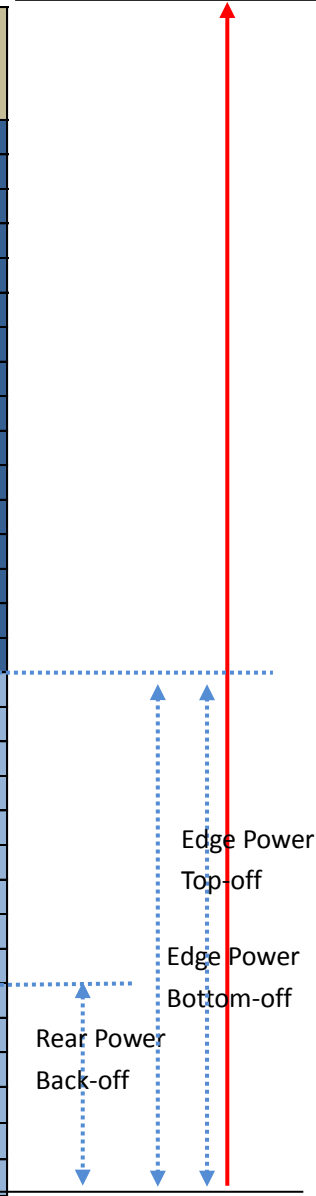

13.4. Tilt angle influences to proximity sensor triggering

As per the KDB 616217 D04 SAR for laptop and tablets v01r02, section 6.4, the following procedure is used to determine the tilt angle influences to proximity sensor triggering.

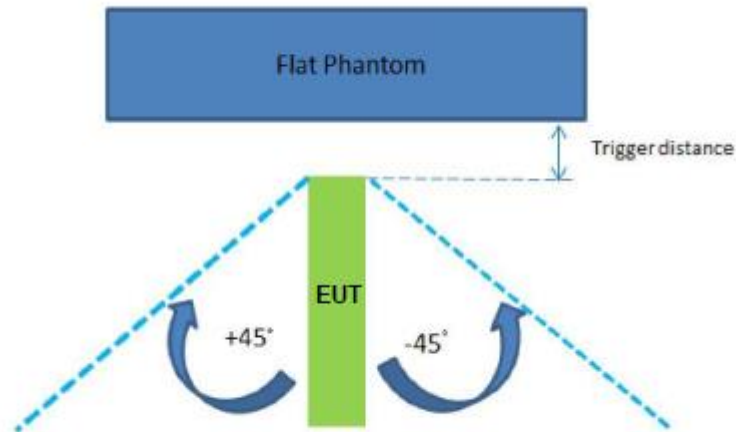

| Distance to the DUT (mm) | Proximity Sensor Status 0° to +45° | Proximity Sensor Status 0° to -45° |
|--------------------------|------------------------------------|------------------------------------|
| 15 | ON | ON |
| 14 | ON | ON |
| 13 | ON | ON |
| 12 | ON | ON |
| 11 | ON | ON |
| 10 | ON | ON |
| 9 | ON | ON |
| 8 | ON | ON |
| 7 | ON | ON |
| 6 | ON | ON |
| 5 | ON | ON |
| 4 | ON | ON |
| 3 | ON | ON |
| 2 | ON | ON |
| 1 | ON | ON |
| 0 | ON | ON |

13.5. Power Reduction per Air-interface

The following graphs show the power level and the distance from the DUT to the flat phantom for the Right-Edge, Bottom-Edge and Rear Surface.

Rear Surface

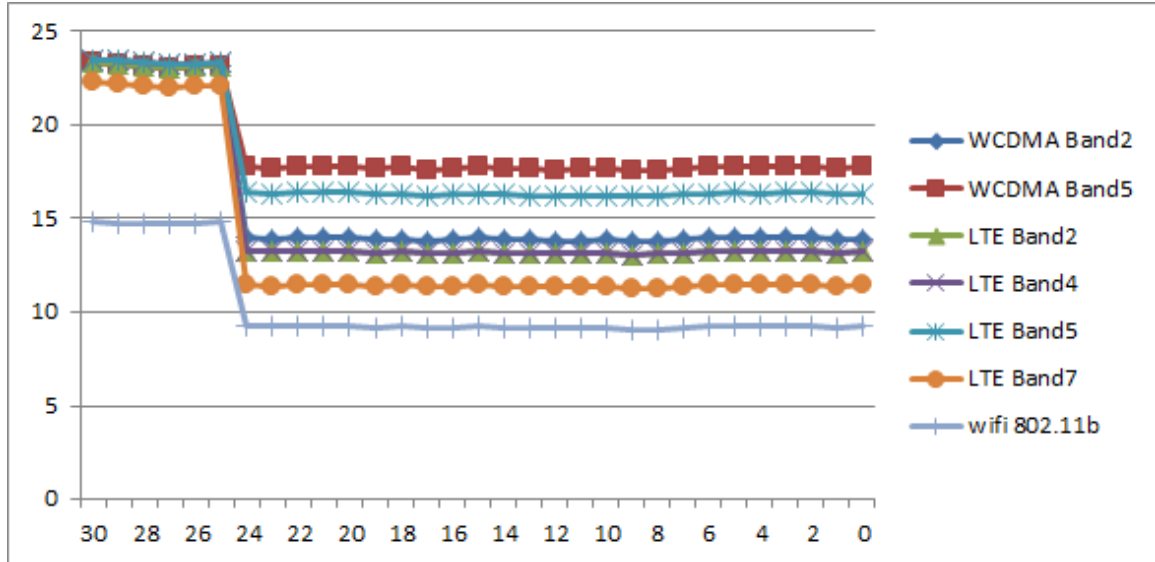

Bottom-Edge

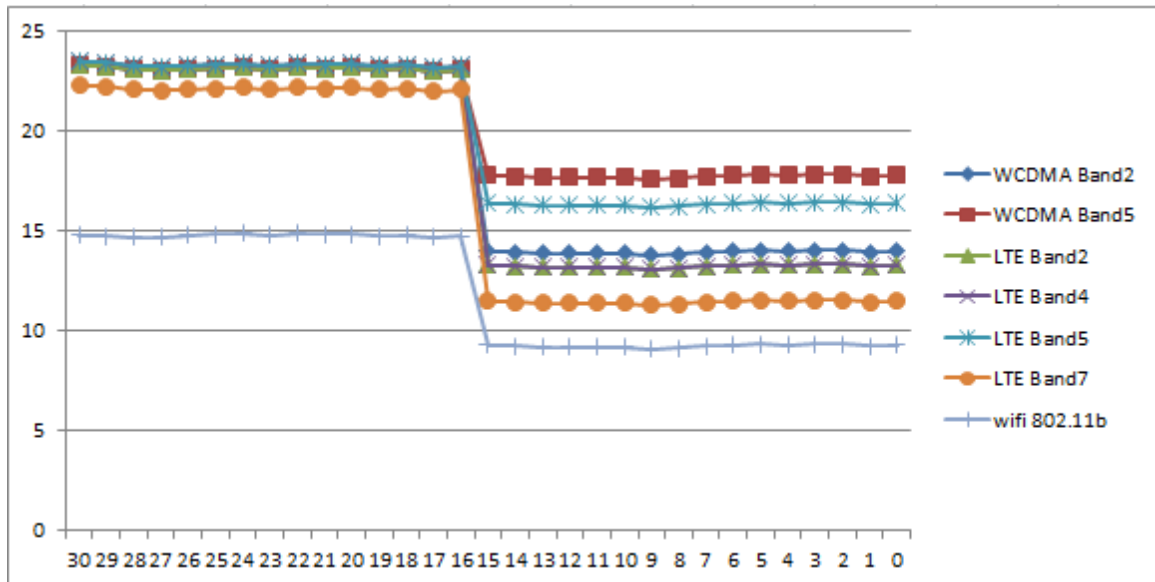

Top-Edge

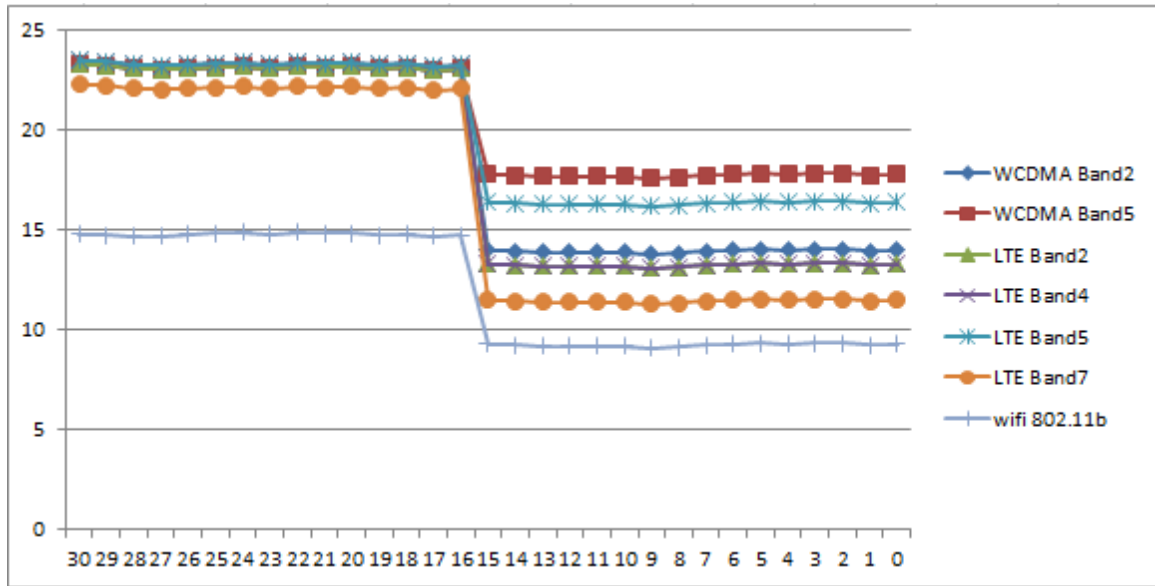

13.6. Proximity Sensor Coverage Area

According to KDB 616217 D04, Proximity Sensor Coverage Area of not request when the antenna and sensor are collocated and the peak SAR location is overlapping with the sensor.

14. Evaluation of Simultaneous

Table 14.1: Summary of Transmitters for FCC

| Band/Mode | Frequency (GHz) | SAR test exclusion threshold(mW) | RF output power (mW) |
|--------------------------|-----------------|----------------------------------|----------------------|
| Bluetooth | 2.41 | 10 | 1.995 |
| 2.4GHz WLAN 802.11 b/g/n | 2.45 | 10 | 31.623 |

Table 14.2: Summary of Transmitters for IC

| Band/Mode | Frequency (GHz) | SAR test exclusion threshold(mW) | RF output power (mW) |
|--------------------------|-----------------|----------------------------------|----------------------|
| Bluetooth | 2.41 | 4 | 1.995 |
| 2.4GHz WLAN 802.11 b/g/n | 2.45 | 4 | 31.623 |

Table 14.3 Simultaneous transmission SAR

| Standalone SAR for 3G (W/Kg) | | | | |
|------------------------------|-------------|---------------|--------------|-------------|
| Test Position | | WCDMA Band II | WCDMA Band V | Highest SAR |
| Body 14mm | Ground Side | 1.155 | 0.413 | 1.155 |
| | Right Side | -- | -- | -- |
| | Bottom Side | -- | 0.208 | 0.208 |
| | Top Side | 0.573 | -- | 0.573 |
| Body 0 mm | Ground Side | 1.092 | 0.478 | 1.092 |
| | Right Side | 0.276 | 0.256 | 0.276 |
| | Bottom Side | -- | 0.248 | 0.248 |
| | Top Side | 0.492 | -- | 0.492 |

| Standalone SAR for 4G (W/Kg) | | | | | | | | |
|------------------------------|-------------|------------|------------|------------|------------|-------------|-------------|-------------|
| Test Position | | LTE Band 2 | LTE Band 4 | LTE Band 5 | LTE Band 7 | LTE Band 12 | LTE Band 13 | Highest SAR |
| Body 14mm | Ground Side | 0.777 | 1.012 | 0.503 | 0.796 | 0.228 | 0.427 | 1.012 |
| | Right Side | -- | -- | -- | -- | -- | -- | -- |
| | Bottom Side | -- | -- | 0.153 | -- | 0.133 | 0.051 | 0.153 |
| | Top Side | 0.604 | 0.638 | -- | 1.138 | -- | -- | 1.138 |
| Body 0 mm | Ground Side | 0.948 | 1.023 | 0.493 | 0.521 | 0.758 | 0.504 | 1.023 |
| | Right Side | 0.303 | 0.511 | 0.171 | 0.016 | 0.067 | 0.216 | 0.511 |

| | | | | | | | | |
|--|-------------|-------|-------|-------|-------|-------|-------|-------|
| | Bottom Side | -- | -- | 0.222 | -- | 0.334 | 0.235 | 0.334 |
| | Top Side | 0.309 | 0.528 | -- | 0.864 | -- | -- | 0.864 |

The LTE Band12/13 and Wi-Fi 5GHz test result are reference **TA Technology (Shanghai) Co.,Ltd** and the report No. is **RXA1704-0095SAR**.

| Standalone SAR for 5G (W/Kg) | | | | | |
|------------------------------|-------------|---------|----------|---------|-------------|
| Test Position | | U-NII-1 | U-NII-2C | U-NII-3 | Highest SAR |
| Body 14mm | Ground Side | 0.137 | 0.131 | 0.013 | 0.137 |
| | Right Side | -- | -- | -- | -- |
| | Bottom Side | -- | -- | -- | -- |
| | Top Side | 0.257 | 0.245 | 0.135 | 0.257 |
| Body 0 mm | Ground Side | 0.207 | 0.223 | 0.102 | 0.223 |
| | Right Side | -- | -- | -- | -- |
| | Bottom Side | -- | -- | -- | -- |
| | Top Side | 0.313 | 0.341 | 0.103 | 0.341 |

The LTE Band12/13 and Wi-Fi 5GHz test result are reference **TA Technology (Shanghai) Co.,Ltd** and the report No. is **RXA1704-0095SAR**.

| Transmission SAR(W/Kg) | | | | | | |
|------------------------|-------------|-------|-------|----------------|-------|-------|
| Test Position | | 3G | 4G | WIFI 2.4GHz | BT | SUM |
| Body 14mm | Ground Side | 1.155 | 1.012 | 0.127 | 0.083 | 1.292 |
| | Right Side | -- | -- | -- | 0.083 | 0.083 |
| | Bottom Side | 0.208 | 0.153 | -- | 0.083 | 0.291 |
| | Top Side | 0.573 | 1.138 | 0.093 | 0.083 | 1.231 |
| Body 0 mm | Ground Side | 1.092 | 1.023 | 0.370 | 0.083 | 1.462 |
| | Right Side | 0.276 | 0.511 | -- | 0.083 | 0.594 |
| | Bottom Side | 0.248 | 0.334 | -- | 0.083 | 0.417 |
| | Top Side | 0.492 | 0.864 | 0.138 | 0.083 | 1.002 |

According to the conducted power measurement result, we can draw the conclusion that: stand-alone SAR for WiFi should be performed. Then, simultaneous transmission SAR for WiFi/BT is considered with measurement results of WCDMA/LTE and WiFi/BT. According to the above table, the sum of reported SAR values for WCDMA/LTE and WiFi<1.6W/kg. So the simultaneous transmission SAR is not required for WiFi/BT transmitter.

Wi-Fi 5GHz not support hotspot mode, so simultaneously transmit not required.

15. SAR Test Result

15.1. SAR results for Fast SAR

Table 15.1: Duty Cycle

| Duty Cycle | |
|----------------------|---------|
| WCDMA Band II/Band V | 1:1 |
| LTE Band 2/4/5/7 | 1:1 |
| WiFi | 1:0.973 |

Table 15.2: SAR Values Sensor off (WCDMA Band II)

| Frequency | | Mode | Distance (mm) | Test Position | Figure No. | Measured average power(dBm) | Maximum allowed Power (dBm) | Scaling factor | Measured SAR(1g) (W/kg) | Reported SAR(1g) (W/kg) | Power Drift (dB) |
|-----------|------|-----------|---------------|---------------|------------|-----------------------------|-----------------------------|----------------|-------------------------|-------------------------|------------------|
| MHz | Ch. | | | | | | | | | | |
| 1880 | 2788 | 12.2K RMC | 14 | Ground | / | 23.14 | 23.5 | 1.086 | 0.936 | 1.017 | 0.04 |
| 1880 | 2788 | 12.2K RMC | 0 | Right | / | 23.14 | 23.5 | 1.086 | 0.254 | 0.276 | 0.10 |
| 1880 | 2788 | 12.2K RMC | 14 | Top | / | 23.14 | 23.5 | 1.086 | 0.527 | 0.573 | -0.06 |
| 1852.4 | 2712 | 12.2K RMC | 14 | Ground | / | 23.31 | 23.5 | 1.045 | 0.912 | 0.953 | -0.14 |
| 1907.6 | 2863 | 12.2K RMC | 14 | Ground | Fig.1 | 23.21 | 23.5 | 1.069 | 1.06 | 1.133 | 0.18 |
| Repeated | | | | | | | | | | | |
| 1907.6 | 2863 | 12.2K RMC | 14 | Ground | Fig.2 | 23.21 | 23.5 | 1.069 | 1.08 | 1.155 | 0.12 |

Table 15.3: SAR Values Sensor on(WCDMA Band II)

| Frequency | | Mode | Distance (mm) | Test Position | Figure No. | Measured average power(dBm) | Maximum allowed Power (dBm) | Scaling factor | Measured SAR(1g) (W/kg) | Reported SAR(1g) (W/kg) | Power Drift (dB) |
|-----------|------|-----------|---------------|---------------|------------|-----------------------------|-----------------------------|----------------|-------------------------|-------------------------|------------------|
| MHz | Ch. | | | | | | | | | | |
| 1880 | 2788 | 12.2K RMC | 0 | Ground | / | 13.94 | 14 | 1.014 | 0.703 | 0.713 | 0.12 |
| 1880 | 2788 | 12.2K RMC | 0 | Top | / | 13.94 | 14 | 1.014 | 0.485 | 0.492 | 0.10 |
| 1852.4 | 2712 | 12.2K RMC | 0 | Ground | Fig.3 | 13.91 | 14 | 1.021 | 1.04 | 1.062 | 0.07 |
| 1907.6 | 2863 | 12.2K RMC | 0 | Ground | / | 13.62 | 14 | 1.091 | 0.648 | 0.707 | 0.06 |
| Repeated | | | | | | | | | | | |

| | | | | | | | | | | | |
|--------|------|-----------|---|--------|-------|-------|----|-------|------|-------|-------|
| 1852.4 | 2712 | 12.2K RMC | 0 | Ground | Fig.4 | 13.91 | 14 | 1.021 | 1.07 | 1.092 | -0.10 |
|--------|------|-----------|---|--------|-------|-------|----|-------|------|-------|-------|

Table 15.4: SAR Values Sensor off (WCDMA Band V)

| Frequency | | Mode | Distance (mm) | Test Position | Figure No. | Measured average power(dBm) | Maximum allowed Power (dBm) | Scaling factor | Measured SAR(1g) (W/kg) | Reported SAR(1g) (W/kg) | Power Drift (dB) |
|-----------|------|-----------|---------------|---------------|------------|-----------------------------|-----------------------------|----------------|-------------------------|-------------------------|------------------|
| MHz | Ch. | | | | | | | | | | |
| 836.6 | 4182 | 12.2K RMC | 14 | Ground | / | 23.27 | 23.5 | 1.054 | 0.377 | 0.398 | 0.12 |
| 836.6 | 4182 | 12.2K RMC | 0 | Right | / | 23.27 | 23.5 | 1.054 | 0.243 | 0.256 | -0.15 |
| 836.6 | 4182 | 12.2K RMC | 14 | Bottom | / | 23.27 | 23.5 | 1.054 | 0.197 | 0.208 | 0.03 |
| 826.4 | 4132 | 12.2K RMC | 14 | Ground | / | 23.33 | 23.5 | 1.040 | 0.325 | 0.338 | 0.05 |
| 846.6 | 4233 | 12.2K RMC | 14 | Ground | Fig.5 | 23.24 | 23.5 | 1.062 | 0.389 | 0.413 | 0.12 |

Table 15.5: SAR Values Sensor on (WCDMA Band V)

| Frequency | | Mode | Distance (mm) | Test Position | Figure No. | Measured average power(dBm) | Maximum allowed Power (dBm) | Scaling factor | Measured SAR(1g) (W/kg) | Reported SAR(1g) (W/kg) | Power Drift (dB) |
|-----------|------|-----------|---------------|---------------|------------|-----------------------------|-----------------------------|----------------|-------------------------|-------------------------|------------------|
| MHz | Ch. | | | | | | | | | | |
| 836.6 | 4182 | 12.2K RMC | 0 | Ground | / | 17.88 | 18 | 1.028 | 0.320 | 0.329 | -0.14 |
| 836.6 | 4182 | 12.2K RMC | 0 | Bottom | / | 17.88 | 18 | 1.028 | 0.241 | 0.248 | 0.14 |
| 826.4 | 4132 | 12.2K RMC | 0 | Ground | / | 17.86 | 18 | 1.033 | 0.300 | 0.310 | 0.04 |
| 846.6 | 4233 | 12.2K RMC | 0 | Ground | Fig.6 | 17.74 | 18 | 1.062 | 0.45 | 0.478 | -0.08 |

Table 15.6: SAR Values Sensor off (LTE Band2)

| Frequency | | Distance (mm) | Configuration | Test Position | Figure No. | Measured average power (dBm) | Maximum allowed Power (dBm) | Scaling factor | Measured SAR(1g) (W/kg) | Reported SAR(1g) (W/kg) | Power Drift(dB) |
|-----------|-------|---------------|-----------------------------|------------------|------------|------------------------------|-----------------------------|----------------|-------------------------|-------------------------|-----------------|
| MHz | Ch. | | | | | | | | | | |
| 1880 | 18900 | 14 | QPSK_20MHz 1RB_0 offset | Toward Ground | Fig.7 | 23.26 | 23.5 | 1.057 | 0.735 | 0.777 | 0.19 |
| | | | QPSK_20MHz 50RB_0 offset | Toward Ground | Fig.8 | 21.99 | 22 | 1.002 | 0.642 | 0.643 | 0.18 |
| 1880 | 18900 | 0 | QPSK_20MHz 1RB_0 offset | Toward Right | / | 23.26 | 23.5 | 1.057 | 0.287 | 0.303 | 0.19 |
| | | | QPSK_20MHz 50RB_0 offset | Toward Right | / | 21.99 | 22 | 1.002 | 0.204 | 0.204 | 0.12 |
| 1880 | 18900 | 14 | QPSK_20MHz 1RB_0 offset | Toward Top | / | 23.26 | 23.5 | 1.057 | 0.572 | 0.604 | 0.08 |
| | | | QPSK_20MHz 50RB_0 offset | Toward Top | / | 21.99 | 22 | 1.002 | 0.456 | 0.457 | -0.15 |
| 1860 | 18700 | 14 | QPSK_20MHz 1RB_0 offset | Toward Ground | / | 23.23 | 23.5 | 1.064 | 0.655 | 0.697 | 0.03 |
| | | | QPSK_20MHz 50RB_0 offset | Toward Ground | / | 21.89 | 22 | 1.026 | 0.400 | 0.410 | 0.06 |
| 1900 | 19100 | 14 | QPSK_20MHz 1RB_0 offset | Toward Ground | / | 23.24 | 23.5 | 1.062 | 0.460 | 0.488 | 0.13 |
| | | | QPSK_20MHz 50RB_0 offset | Toward Ground | / | 21.91 | 22 | 1.021 | 0.429 | 0.438 | -0.13 |

Table 15.7: SAR Values Sensor on (LTE Band2)

| Frequency | | Distance (mm) | Configuration | Test Position | Figure No. | Measured average power (dBm) | Maximum allowed Power (dBm) | Scaling factor | Measured SAR(1g) (W/kg) | Reported SAR(1g) (W/kg) | Power Drift(dB) |
|-----------|-------|---------------|-----------------------------|------------------|------------|------------------------------|-----------------------------|----------------|-------------------------|-------------------------|-----------------|
| MHz | Ch. | | | | | | | | | | |
| 1880 | 18900 | 0 | QPSK_20MHz 1RB_0 offset | Toward Ground | Fig.9 | 13.32 | 13.5 | 1.042 | 0.735 | 0.766 | 0.09 |
| | | | QPSK_20MHz 50RB_0 offset | Toward Ground | Fig.10 | 13.18 | 13.5 | 1.076 | 0.874 | 0.941 | -0.10 |
| 1880 | 18900 | 0 | QPSK_20MHz 1RB_0 offset | Toward Top | / | 13.32 | 13.5 | 1.042 | 0.282 | 0.294 | 0.12 |
| | | | QPSK_20MHz 50RB_0 offset | Toward Top | / | 13.18 | 13.5 | 1.076 | 0.287 | 0.309 | 0.08 |
| 1860 | 18700 | 0 | QPSK_20MHz 1RB_0 offset | Toward Ground | / | 13.31 | 13.5 | 1.045 | 0.655 | 0.684 | -0.15 |
| | | | QPSK_20MHz 50RB_0 offset | Toward Ground | / | 13.07 | 13.5 | 1.104 | 0.824 | 0.910 | 0.03 |

| | | | | | | | | | | | |
|----------|-------|---|------------------------------|------------------|--------|-------|------|-------|-------|-------|-------|
| 1900 | 19100 | 0 | QPSK_20MHz 1RB_0 offset | Toward Ground | / | 13.22 | 13.5 | 1.067 | 0.460 | 0.491 | 0.06 |
| | | | QPSK_20MHz 50RB_0 offset | Toward Ground | / | 13.11 | 13.5 | 1.094 | 0.802 | 0.877 | 0.13 |
| 1880 | 18900 | 0 | QPSK_20MHz 100RB_0 offset | Toward Ground | Fig.11 | 13.12 | 13.5 | 1.091 | 0.869 | 0.948 | -0.18 |
| Repeated | | | | | | | | | | | |
| 1880 | 18900 | 0 | QPSK_20MHz 50RB_0 offset | Toward Ground | Fig.12 | 13.18 | 13.5 | 1.076 | 0.874 | 0.941 | -0.15 |

Table 15.8: SAR Values Sensor off (LTE Band 4)

| Frequency | | Distance (mm) | Configuration | Test Position | Figure No. | Measured average power (dBm) | Maximum allowed Power (dBm) | Scaling factor | Measured SAR(1g) (W/kg) | Reported SAR(1g) (W/kg) | Power Drift(dB) |
|-----------|-------|------------------|------------------------------|------------------|---------------|---------------------------------------|--------------------------------------|-------------------|-------------------------------|-------------------------------|--------------------|
| MHz | Ch. | | | | | | | | | | |
| 1732.5 | 20175 | 14 | QPSK_20MHz 1RB_0 offset | Toward Ground | / | 23.45 | 23.5 | 1.012 | 0.860 | 0.870 | 0.11 |
| | | | QPSK_20MHz 50RB_0 offset | Toward Ground | Fig.14 | 22.76 | 23 | 1.057 | 0.743 | 0.785 | -0.14 |
| 1732.5 | 20175 | 0 | QPSK_20MHz 1RB_0 offset | Toward Right | / | 23.45 | 23.5 | 1.012 | 0.505 | 0.511 | 0.08 |
| | | | QPSK_20MHz 50RB_0 offset | Toward Right | / | 22.76 | 23 | 1.057 | 0.370 | 0.391 | -0.15 |
| 1732.5 | 20175 | 14 | QPSK_20MHz 1RB_0 offset | Toward Top | / | 23.45 | 23.5 | 1.012 | 0.631 | 0.638 | 0.06 |
| | | | QPSK_20MHz 50RB_0 offset | Toward Top | / | 22.76 | 23 | 1.057 | 0.565 | 0.597 | 0.01 |
| 1720 | 20050 | 14 | QPSK_20MHz 1RB_0 offset | Toward Ground | / | 23.36 | 23.5 | 1.033 | 0.831 | 0.858 | 0.07 |
| | | | QPSK_20MHz 50RB_0 offset | Toward Ground | / | 22.73 | 23 | 1.064 | 0.583 | 0.620 | 0.15 |
| 1745 | 20300 | 14 | QPSK_20MHz 1RB_0 offset | Toward Ground | Fig.13 | 23.41 | 23.5 | 1.021 | 0.957 | 0.977 | 0.14 |
| | | | QPSK_20MHz 50RB_0 offset | Toward Ground | / | 22.72 | 23 | 1.067 | 0.627 | 0.669 | -0.15 |
| 1732.5 | 20175 | 14 | QPSK_20MHz 100RB_0 offset | Toward Ground | Fig.15 | 22.45 | 22.5 | 1.012 | 0.743 | 0.752 | 0.12 |
| Repeated | | | | | | | | | | | |
| 1745 | 20300 | 14 | QPSK_20MHz 1RB_0 offset | Toward Ground | Fig.16 | 23.41 | 23.5 | 1.021 | 0.991 | 1.012 | 0.11 |

Table 15.9: SAR Values Sensor on (LTE Band 4)

| Frequency | | Distance (mm) | Configuration | Test Position | Figure No. | Measured average power (dBm) | Maximum allowed Power (dBm) | Scaling factor | Measured SAR(1g) (W/kg) | Reported SAR(1g) (W/kg) | Power Drift(dB) |
|-----------|-------|---------------|------------------------------|------------------|------------|------------------------------|-----------------------------|----------------|-------------------------|-------------------------|-----------------|
| MHz | Ch. | | | | | | | | | | |
| 1732.5 | 20175 | 0 | QPSK_20MHz 1RB_0 offset | Toward Ground | / | 13.33 | 13.5 | 1.040 | 0.845 | 0.879 | 0.08 |
| | | | QPSK_20MHz 50RB_0 offset | Toward Ground | / | 13.28 | 13.5 | 1.052 | 0.855 | 0.899 | -0.15 |
| 1732.5 | 20175 | 0 | QPSK_20MHz 1RB_0 offset | Toward Top | / | 13.33 | 13.5 | 1.040 | 0.326 | 0.339 | 0.06 |
| | | | QPSK_20MHz 50RB_0 offset | Toward Top | / | 13.28 | 13.5 | 1.052 | 0.502 | 0.528 | 0.01 |
| 1720 | 20050 | 0 | QPSK_20MHz 1RB_0 offset | Toward Ground | / | 13.28 | 13.5 | 1.052 | 0.838 | 0.882 | 0.07 |
| | | | QPSK_20MHz 50RB_0 offset | Toward Ground | / | 13.10 | 13.5 | 1.096 | 0.791 | 0.867 | 0.15 |
| 1745 | 20300 | 0 | QPSK_20MHz 1RB_0 offset | Toward Ground | Fig.17 | 13.31 | 13.5 | 1.045 | 0.96 | 1.003 | 0.13 |
| | | | QPSK_20MHz 50RB_0 offset | Toward Ground | Fig.18 | 13.10 | 13.5 | 1.096 | 0.933 | 1.023 | -0.12 |
| 1732.5 | 20175 | 0 | QPSK_20MHz 100RB_0 offset | Toward Ground | Fig.19 | 13.37 | 13.5 | 1.030 | 0.899 | 0.926 | -0.16 |
| Repeated | | | | | | | | | | | |
| 1745 | 20300 | 0 | QPSK_20MHz 1RB_0 offset | Toward Ground | Fig.20 | 13.31 | 13.5 | 1.045 | 0.976 | 1.020 | 0.17 |

Table 15.10: SAR Values Sensor off (LTE Band 5)

| Frequency | | Distance (mm) | Configuration | Test Position | Figure No. | Measured average power (dBm) | Maximum allowed Power (dBm) | Scaling factor | Measured SAR(1g) (W/kg) | Reported SAR(1g) (W/kg) | Power Drift(dB) |
|-----------|-----------|---------------|-----------------------------|---------------|------------|------------------------------|-----------------------------|----------------|-------------------------|-------------------------|-----------------|
| MHz | Ch. | | | | | | | | | | |
| 836.5 | 2525 | 14 | QPSK_10MHz 1RB_0 offset | Toward Ground | / | 23.44 | 23.5 | 1.014 | 0.452 | 0.458 | -0.09 |
| | | | QPSK_10MHz 25RB_0 offset | Toward Ground | Fig.22 | 22.70 | 23 | 1.072 | 0.384 | 0.410 | 0.05 |
| 836.5 | 2525 | 0 | QPSK_10MHz 1RB_0 offset | Toward Right | / | 23.44 | 23.5 | 1.014 | 0.169 | 0.171 | 0.04 |
| | | | QPSK_10MHz 25RB_0 offset | Toward Right | / | 22.70 | 23 | 1.072 | 0.134 | 0.144 | -0.18 |
| 836.5 | 2525 | 14 | QPSK_10MHz 1RB_0 offset | Toward Bottom | / | 23.44 | 23.5 | 1.014 | 0.151 | 0.153 | 0.04 |
| | | | QPSK_10MHz 25RB_0 offset | Toward Bottom | / | 22.70 | 23 | 1.072 | 0.132 | 0.141 | -0.12 |
| 829 | 2045 0 | 14 | QPSK_10MHz 1RB_0 offset | Toward Ground | / | 23.26 | 23.5 | 1.057 | 0.424 | 0.448 | 0.07 |
| | | | QPSK_10MHz 25RB_0 offset | Toward Ground | / | 22.46 | 23 | 1.132 | 0.352 | 0.399 | 0.12 |
| 844 | 2060 0 | 14 | QPSK_10MHz 1RB_0 offset | Toward Ground | Fig.21 | 23.30 | 23.5 | 1.047 | 0.48 | 0.503 | -0.13 |
| | | | QPSK_10MHz 25RB_0 offset | Toward Ground | / | 22.45 | 23 | 1.135 | 0.355 | 0.403 | 0.12 |

Table 15.11: SAR Values Sensor on (LTE Band 5)

| Frequency | | Distance (mm) | Configuration | Test Position | Figure No. | Measured average power (dBm) | Maximum allowed Power (dBm) | Scaling factor | Measured SAR(1g) (W/kg) | Reported SAR(1g) (W/kg) | Power Drift(dB) |
|-----------|-----------|---------------|-----------------------------|---------------|------------|------------------------------|-----------------------------|----------------|-------------------------|-------------------------|-----------------|
| MHz | Ch. | | | | | | | | | | |
| 836.5 | 2525 | 0 | QPSK_10MHz 1RB_0 offset | Toward Ground | / | 16.41 | 16.5 | 1.021 | 0.397 | 0.405 | 0.07 |
| | | | QPSK_10MHz 25RB_0 offset | Toward Ground | / | 15.67 | 16 | 1.079 | 0.373 | 0.402 | 0.15 |
| 836.5 | 2525 | 0 | QPSK_10MHz 1RB_0 offset | Toward Bottom | / | 16.41 | 16.5 | 1.021 | 0.187 | 0.191 | 0.19 |
| | | | QPSK_10MHz 25RB_0 offset | Toward Bottom | / | 15.67 | 16 | 1.079 | 0.206 | 0.222 | 0.11 |
| 829 | 2045 0 | 0 | QPSK_10MHz 1RB_0 offset | Toward Ground | Fig.23 | 16.14 | 16.5 | 1.086 | 0.409 | 0.444 | 0.05 |
| | | | QPSK_10MHz | Toward | Fig.24 | 15.44 | 16 | 1.138 | 0.433 | 0.493 | -0.01 |

| | | | | | | | | | | | |
|---------------|--------|---|---------------|--------|---|-------|------|-------|-------|-------|-------|
| | | | 25RB_0 offset | Ground | | | | | | | |
| 844 | 2060 | 0 | QPSK_10MHz | Toward | / | 16.19 | 16.5 | 1.074 | 0.362 | 0.389 | -0.18 |
| | | | 1RB_0 offset | Ground | | | | | | | |
| | | | QPSK_10MHz | Toward | / | 15.49 | 16 | 1.125 | 0.369 | 0.415 | 0.04 |
| 25RB_0 offset | Ground | | | | | | | | | | |

Table 15.12: SAR Values Sensor off (WiFi2450 802.11b)

| Frequency | | Distance (mm) | Test Position | Figure No. | Measured average power(dBm) | Maximum allowed Power (dBm) | Scaling factor | Duty cycle factor | Measured SAR(1g) (W/kg) | Reported SAR(1g) (W/kg) | Power Drift (dB) |
|-----------|-----|---------------|---------------|------------|-----------------------------|-----------------------------|----------------|-------------------|-------------------------|-------------------------|------------------|
| MHz | Ch. | | | | | | | | | | |
| 2412 | 1 | 14 | Ground | Fig.25 | 14.77 | 15 | 1.054 | 1.031 | 0.117 | 0.127 | -0.05 |
| 2437 | 6 | 14 | Ground | / | 14.63 | 15 | 1.089 | 1.031 | 0.059 | 0.066 | 0.01 |
| 2462 | 11 | 14 | Ground | / | 13.47 | 15 | 1.422 | 1.031 | 0.045 | 0.066 | 0.12 |
| 2412 | 1 | 14 | Top | / | 14.77 | 15 | 1.054 | 1.031 | 0.086 | 0.093 | 0.01 |

Table 15.13: SAR Values Sensor on (WiFi2450 802.11b)

| Frequency | | Distance (mm) | Test Position | Figure No. | Measured average power(dBm) | Maximum allowed Power (dBm) | Scaling factor | Duty cycle factor | Measured SAR(1g) (W/kg) | Reported SAR(1g) (W/kg) | Power Drift (dB) |
|-----------|-----|---------------|---------------|------------|-----------------------------|-----------------------------|----------------|-------------------|-------------------------|-------------------------|------------------|
| MHz | Ch. | | | | | | | | | | |
| 2412 | 1 | 0 | Ground | Fig.26 | 9.31 | 9.5 | 1.045 | 1.031 | 0.344 | 0.370 | 0.12 |
| 2437 | 6 | 0 | Ground | / | 9.25 | 9.5 | 1.059 | 1.031 | 0.229 | 0.250 | 0.05 |
| 2462 | 11 | 0 | Ground | / | 8.29 | 9.5 | 1.321 | 1.031 | 0.172 | 0.234 | -0.12 |
| 2412 | 1 | 0 | Top | / | 9.31 | 9.5 | 1.045 | 1.031 | 0.128 | 0.138 | 0.06 |

Note: SAR is not required for OFDM because the 802.11b adjusted SAR \leq 1.2 W/kg.

Table 15.14: SAR Values Sensor off (LTE Band 7)

| Frequency | | Distance (mm) | Configuration | Test Position | Figure No. | Measured average power (dBm) | Maximum allowed Power (dBm) | Scaling factor | Measured SAR(1g) (W/kg) | Reported SAR(1g) (W/kg) | Power Drift(dB) |
|-----------|-------|---------------|---------------|---------------|------------|------------------------------|-----------------------------|----------------|-------------------------|-------------------------|-----------------|
| MHz | Ch. | | | | | | | | | | |
| 2535 | 21100 | 14 | QPSK_20MHz | Toward | / | 22.25 | 22.5 | 1.059 | 0.752 | 0.796 | -0.18 |
| | | | 1RB_0 offset | Ground | | | | | | | |
| 2535 | 21100 | 0 | QPSK_20MHz | Toward | / | 21.49 | 21.5 | 1.002 | 0.762 | 0.764 | 0.04 |
| | | | 50RB_0 offset | Ground | | | | | | | |
| 2535 | 21100 | 0 | QPSK_20MHz | Toward | / | 22.25 | 22.5 | 1.059 | 0.015 | 0.016 | -0.12 |
| | | | 1RB_0 offset | Right | | | | | | | |

| | | | | | | | | | | | |
|----------|-------|----|------------------------------|-----------------|--------|-------|------|-------|-------|-------|-------|
| | | | QPSK_20MHz 50RB_0 offset | Toward Right | / | 21.49 | 21.5 | 1.002 | 0.014 | 0.014 | 0.07 |
| 2535 | 21100 | 14 | QPSK_20MHz 1RB_0 offset | Toward Top | / | 22.25 | 22.5 | 1.059 | 1.00 | 1.059 | 0.12 |
| | | | QPSK_20MHz 50RB_0 offset | Toward Top | / | 21.49 | 21.5 | 1.002 | 0.754 | 0.756 | 0.04 |
| 2510 | 20850 | 14 | QPSK_20MHz 1RB_0 offset | Toward Top | / | 22.21 | 22.5 | 1.069 | 0.829 | 0.886 | -0.12 |
| | | | QPSK_20MHz 50RB_0 offset | Toward Top | / | 21.48 | 21.5 | 1.005 | 0.594 | 0.597 | 0.07 |
| 2560 | 21350 | 14 | QPSK_20MHz 1RB_0 offset | Toward Top | Fig.27 | 22.15 | 22.5 | 1.084 | 1.05 | 1.138 | 0.08 |
| | | | QPSK_20MHz 50RB_0 offset | Toward Top | Fig.28 | 21.45 | 21.5 | 1.012 | 0.848 | 0.858 | -0.02 |
| 2535 | 21100 | 14 | QPSK_20MHz 100RB_0 offset | Toward Top | / | 21.12 | 21.5 | 1.091 | 0.606 | 0.661 | 0.19 |
| Repeated | | | | | | | | | | | |
| 2560 | 21350 | 14 | QPSK_20MHz 1RB_0 offset | Toward Top | Fig.29 | 22.15 | 22.5 | 1.084 | 1.03 | 1.116 | -0.06 |

Table 15.15: SAR Values Sensor on (LTE Band 7)

| Frequency | | Distance (mm) | Configuration | Test Position | Figure No. | Measured average power (dBm) | Maximum allowed Power (dBm) | Scaling factor | Measured SAR(1g) (W/kg) | Reported SAR(1g) (W/kg) | Power Drift(dB) |
|-----------|-------|---------------|------------------------------|------------------|------------|------------------------------|-----------------------------|----------------|-------------------------|-------------------------|-----------------|
| MHz | Ch. | | | | | | | | | | |
| 2535 | 21100 | 0 | QPSK_20MHz 1RB_0 offset | Toward Ground | Fig.30 | 11.64 | 12 | 1.086 | 0.48 | 0.521 | 0.02 |
| | | | QPSK_20MHz 50RB_0 offset | Toward Ground | / | 11.48 | 11.5 | 1.005 | 0.488 | 0.490 | 0.04 |
| 2535 | 21100 | 0 | QPSK_20MHz 1RB_0 offset | Toward Top | / | 11.64 | 12 | 1.086 | 0.309 | 0.336 | -0.12 |
| | | | QPSK_20MHz 50RB_0 offset | Toward Top | / | 11.48 | 11.5 | 1.005 | 0.507 | 0.509 | 0.07 |
| 2510 | 20850 | 0 | QPSK_20MHz 1RB_0 offset | Toward Ground | / | 11.52 | 12 | 1.117 | 0.264 | 0.295 | 0.08 |
| | | | QPSK_20MHz 50RB_0 offset | Toward Top | / | 11.23 | 11.5 | 1.064 | 0.478 | 0.509 | -0.02 |
| 2560 | 21350 | 0 | QPSK_20MHz 1RB_0 offset | Toward Ground | / | 11.57 | 12 | 1.104 | 0.326 | 0.360 | 0.19 |
| | | | QPSK_20MHz 50RB_0 offset | Toward Top | Fig.31 | 11.43 | 11.5 | 1.016 | 0.847 | 0.861 | -0.17 |
| 2535 | 21100 | 0 | QPSK_20MHz 100RB_0 offset | Toward Top | / | 11.42 | 11.5 | 1.019 | 0.629 | 0.641 | 0.13 |
| Repeated | | | | | | | | | | | |
| 2560 | 21350 | 0 | QPSK_20MHz 1RB_0 offset | Toward Top | Fig.32 | 11.43 | 11.5 | 1.016 | 0.85 | 0.864 | -0.11 |

SAR results for Standard procedure

There is zoom scan measurement to be added for the highest measured SAR in each exposure configuration/band.

Table 15.16:SAR Values Sensor off (WCDMA Band II)

| Frequency | | Mode | Distance (mm) | Test Position | Figure No. | Measured average power(dBm) | Maximum allowed Power (dBm) | Scaling factor | Measured SAR(1g) (W/kg) | Reported SAR(1g) (W/kg) | Power Drift (dB) |
|-----------|------|-----------|---------------|---------------|------------|-----------------------------|-----------------------------|----------------|-------------------------|-------------------------|------------------|
| MHz | Ch. | | | | | | | | | | |
| 1907.6 | 2863 | 12.2K RMC | 14 | Ground | Fig.1 | 23.21 | 23.5 | 1.069 | 1.06 | 1.133 | 0.18 |
| Repeated | | | | | | | | | | | |
| 1907.6 | 2863 | 12.2K RMC | 14 | Ground | Fig.2 | 23.21 | 23.5 | 1.069 | 1.08 | 1.155 | 0.12 |

Table 15.17:SAR Values Sensor on(WCDMA Band II)

| Frequency | | Mode | Distance (mm) | Test Position | Figure No. | Measured average power(dBm) | Maximum allowed Power (dBm) | Scaling factor | Measured SAR(1g) (W/kg) | Reported SAR(1g) (W/kg) | Power Drift (dB) |
|-----------|------|-----------|---------------|---------------|------------|-----------------------------|-----------------------------|----------------|-------------------------|-------------------------|------------------|
| MHz | Ch. | | | | | | | | | | |
| 1852.4 | 2712 | 12.2K RMC | 0 | Ground | Fig.3 | 13.91 | 14 | 1.021 | 1.04 | 1.062 | 0.07 |
| Repeated | | | | | | | | | | | |
| 1852.4 | 2712 | 12.2K RMC | 0 | Ground | Fig.4 | 13.91 | 14 | 1.021 | 1.07 | 1.092 | -0.10 |

Table 15.18: SAR Values Sensor off (WCDMA Band V)

| Frequency | | Mode | Distance (mm) | Test Position | Figure No. | Measured average power(dBm) | Maximum allowed Power (dBm) | Scaling factor | Measured SAR(1g) (W/kg) | Reported SAR(1g) (W/kg) | Power Drift (dB) |
|-----------|------|-----------|---------------|---------------|------------|-----------------------------|-----------------------------|----------------|-------------------------|-------------------------|------------------|
| MHz | Ch. | | | | | | | | | | |
| 846.6 | 4233 | 12.2K RMC | 14 | Ground | Fig.5 | 23.24 | 23.5 | 1.062 | 0.389 | 0.413 | 0.12 |

Table 15.19: SAR Values Sensor on (WCDMA Band V)

| Frequency | | Mode | Distance (mm) | Test Position | Figure No. | Measured average power(dBm) | Maximum allowed Power (dBm) | Scaling factor | Measured SAR(1g) (W/kg) | Reported SAR(1g) (W/kg) | Power Drift (dB) |
|-----------|------|-----------|---------------|---------------|------------|-----------------------------|-----------------------------|----------------|-------------------------|-------------------------|------------------|
| MHz | Ch. | | | | | | | | | | |
| 846.6 | 4233 | 12.2K RMC | 0 | Ground | Fig.6 | 17.74 | 18 | 1.062 | 0.45 | 0.478 | -0.08 |

Table 15.20: SAR Values Sensor off (LTE Band2)

| Frequency | | Distance (mm) | Configuration | Test Position | Figure No. | Measured average power (dBm) | Maximum allowed Power (dBm) | Scaling factor | Measured SAR(1g) (W/kg) | Reported SAR(1g) (W/kg) | Power Drift(dB) |
|-----------|-------|---------------|-----------------------------|------------------|------------|------------------------------|-----------------------------|----------------|-------------------------|-------------------------|-----------------|
| MHz | Ch. | | | | | | | | | | |
| 1880 | 18900 | 14 | QPSK_20MHz 1RB_0 offset | Toward Ground | Fig.7 | 23.26 | 23.5 | 1.057 | 0.735 | 0.777 | 0.19 |
| | | | QPSK_20MHz 50RB_0 offset | Toward Ground | Fig.8 | 21.99 | 22 | 1.002 | 0.642 | 0.643 | 0.18 |

Table 15.21: SAR Values Sensor on (LTE Band2)

| Frequency | | Distance (mm) | Configuration | Test Position | Figure No. | Measured average power (dBm) | Maximum allowed Power (dBm) | Scaling factor | Measured SAR(1g) (W/kg) | Reported SAR(1g) (W/kg) | Power Drift(dB) |
|-----------|-------|---------------|------------------------------|------------------|------------|------------------------------|-----------------------------|----------------|-------------------------|-------------------------|-----------------|
| MHz | Ch. | | | | | | | | | | |
| 1880 | 18900 | 0 | QPSK_20MHz 1RB_0 offset | Toward Ground | Fig.9 | 13.32 | 13.5 | 1.042 | 0.735 | 0.766 | 0.09 |
| | | | QPSK_20MHz 50RB_0 offset | Toward Ground | Fig.10 | 13.18 | 13.5 | 1.076 | 0.874 | 0.941 | -0.10 |
| 1880 | 18900 | 0 | QPSK_20MHz 100RB_0 offset | Toward Ground | Fig.11 | 13.12 | 13.5 | 1.091 | 0.869 | 0.948 | -0.18 |
| Repeated | | | | | | | | | | | |
| 1880 | 18900 | 0 | QPSK_20MHz 50RB_0 offset | Toward Ground | Fig.12 | 13.18 | 13.5 | 1.076 | 0.874 | 0.892 | -0.15 |

Table 15.22: SAR Values Sensor off (LTE Band 4)

| Frequency | | Distance (mm) | Configuration | Test Position | Figure No. | Measured average power (dBm) | Maximum allowed Power (dBm) | Scaling factor | Measured SAR(1g) (W/kg) | Reported SAR(1g) (W/kg) | Power Drift(dB) |
|-----------|-------|---------------|------------------------------|------------------|------------|------------------------------|-----------------------------|----------------|-------------------------|-------------------------|-----------------|
| MHz | Ch. | | | | | | | | | | |
| 1732.5 | 20175 | 14 | QPSK_20MHz 50RB_0 offset | Toward Ground | Fig.14 | 22.76 | 23 | 1.057 | 0.743 | 0.785 | -0.14 |
| 1745 | 20300 | 14 | QPSK_20MHz 1RB_0 offset | Toward Ground | Fig.13 | 23.41 | 23.5 | 1.021 | 0.957 | 0.977 | 0.14 |
| 1732.5 | 20175 | 14 | QPSK_20MHz 100RB_0 offset | Toward Ground | Fig.15 | 22.45 | 22.5 | 1.012 | 0.743 | 0.752 | 0.12 |
| Repeated | | | | | | | | | | | |
| 1745 | 20300 | 14 | QPSK_20MHz 1RB_0 offset | Toward Ground | Fig.16 | 23.41 | 23.5 | 1.021 | 0.991 | 1.012 | 0.11 |

Table 15.23: SAR Values Sensor on (LTE Band 4)

| Frequency | | Distance (mm) | Configuration | Test Position | Figure No. | Measured average power (dBm) | Maximum allowed Power (dBm) | Scaling factor | Measured SAR(1g) (W/kg) | Reported SAR(1g) (W/kg) | Power Drift(dB) |
|-----------|-------|---------------|------------------------------|------------------|------------|------------------------------|-----------------------------|----------------|-------------------------|-------------------------|-----------------|
| MHz | Ch. | | | | | | | | | | |
| 1745 | 20300 | 0 | QPSK_20MHz 1RB_0 offset | Toward Ground | Fig.17 | 13.31 | 13.5 | 1.045 | 0.96 | 1.003 | 0.13 |
| | | | QPSK_20MHz 50RB_0 offset | Toward Ground | Fig.18 | 13.10 | 13.5 | 1.096 | 0.933 | 1.023 | -0.12 |
| 1732.5 | 20175 | 0 | QPSK_20MHz 100RB_0 offset | Toward Ground | Fig.19 | 13.37 | 13.5 | 1.030 | 0.899 | 0.926 | -0.16 |
| Repeated | | | | | | | | | | | |
| 1745 | 20300 | 0 | QPSK_20MHz 1RB_0 offset | Toward Ground | Fig.20 | 13.31 | 13.5 | 1.045 | 0.976 | 1.020 | 0.17 |

Table 15.24: SAR Values Sensor off (LTE Band 5)

| Frequency | | Distance (mm) | Configuration | Test Position | Figure No. | Measured average power (dBm) | Maximum allowed Power (dBm) | Scaling factor | Measured SAR(1g) (W/kg) | Reported SAR(1g) (W/kg) | Power Drift(dB) |
|-----------|-----------|---------------|-----------------------------|------------------|------------|------------------------------|-----------------------------|----------------|-------------------------|-------------------------|-----------------|
| MHz | Ch. | | | | | | | | | | |
| 836.5 | 2525 0 | 14 | QPSK_10MHz 25RB_0 offset | Toward Ground | Fig.22 | 22.70 | 23 | 1.072 | 0.384 | 0.410 | 0.05 |
| 844 | 2060 0 | 14 | QPSK_10MHz 1RB_0 offset | Toward Ground | Fig.21 | 23.30 | 23.5 | 1.047 | 0.48 | 0.503 | -0.13 |

Table 15.25: SAR Values Sensor on (LTE Band 5)

| Frequency | | Distance (mm) | Configuration | Test Position | Figure No. | Measured average power (dBm) | Maximum allowed Power (dBm) | Scaling factor | Measured SAR(1g) (W/kg) | Reported SAR(1g) (W/kg) | Power Drift(dB) |
|-----------|-----------|---------------|-----------------------------|------------------|------------|------------------------------|-----------------------------|----------------|-------------------------|-------------------------|-----------------|
| MHz | Ch. | | | | | | | | | | |
| 829 | 2045 0 | 0 | QPSK_10MHz 1RB_0 offset | Toward Ground | Fig.23 | 16.14 | 16.5 | 1.086 | 0.409 | 0.444 | 0.05 |
| | | | QPSK_10MHz 25RB_0 offset | Toward Ground | Fig.24 | 15.44 | 16 | 1.138 | 0.433 | 0.493 | -0.01 |

Table 15.26: SAR Values Sensor off (WiFi2450 802.11b)

| Frequency | | Distance (mm) | Test Position | Figure No. | Measured average power(dBm) | Maximum allowed Power (dBm) | Scaling factor | Duty cycle factor | Measured SAR(1g) (W/kg) | Reported SAR(1g) (W/kg) | Power Drift (dB) |
|-----------|-----|---------------|---------------|------------|-----------------------------|-----------------------------|----------------|-------------------|-------------------------|-------------------------|------------------|
| MHz | Ch. | | | | | | | | | | |
| 2412 | 1 | 14 | Ground | Fig.25 | 14.77 | 15 | 1.054 | 1.031 | 0.117 | 0.127 | -0.05 |

Table 15.27: SAR Values Sensor on (WiFi2450 802.11b)

| Frequency | | Distance (mm) | Test Position | Figure No. | Measured average power(dBm) | Maximum allowed Power (dBm) | Scaling factor | Duty cycle factor | Measured SAR(1g) (W/kg) | Reported SAR(1g) (W/kg) | Power Drift (dB) |
|-----------|-----|---------------|---------------|------------|-----------------------------|-----------------------------|----------------|-------------------|-------------------------|-------------------------|------------------|
| MHz | Ch. | | | | | | | | | | |
| 2412 | 1 | 0 | Ground | Fig.26 | 9.31 | 9.5 | 1.045 | 1.031 | 0.344 | 0.370 | 0.12 |

Note: SAR is not required for OFDM because the 802.11b adjusted SAR≤1.2 W/kg.

Table 15.28: SAR Values Sensor off (LTE Band 7)

| Frequency | | Distance (mm) | Configuration | Test Position | Figure No. | Measured average power (dBm) | Maximum allowed Power (dBm) | Scaling factor | Measured SAR(1g) (W/kg) | Reported SAR(1g) (W/kg) | Power Drift(dB) |
|-----------|-------|---------------|-----------------------------|---------------|------------|------------------------------|-----------------------------|----------------|-------------------------|-------------------------|-----------------|
| MHz | Ch. | | | | | | | | | | |
| 2560 | 21350 | 14 | QPSK_20MHz 1RB_0 offset | Toward Top | Fig.27 | 22.15 | 22.5 | 1.084 | 1.05 | 1.138 | 0.08 |
| | | | QPSK_20MHz 50RB_0 offset | Toward Top | Fig.28 | 21.45 | 21.5 | 1.012 | 0.848 | 0.858 | -0.02 |
| Repeated | | | | | | | | | | | |
| 2560 | 21350 | 14 | QPSK_20MHz 1RB_0 offset | Toward Top | Fig.29 | 22.15 | 22.5 | 1.084 | 1.03 | 1.116 | -0.06 |

Table 15.29: SAR Values Sensor on (LTE Band 7)

| Frequency | | Distance (mm) | Configuration | Test Position | Figure No. | Measured average power (dBm) | Maximum allowed Power (dBm) | Scaling factor | Measured SAR(1g) (W/kg) | Reported SAR(1g) (W/kg) | Power Drift(dB) |
|-----------|-------|---------------|-----------------------------|------------------|------------|------------------------------|-----------------------------|----------------|-------------------------|-------------------------|-----------------|
| MHz | Ch. | | | | | | | | | | |
| 2535 | 21100 | 0 | QPSK_20MHz 1RB_0 offset | Toward Ground | Fig.30 | 11.64 | 12 | 1.086 | 0.48 | 0.521 | 0.02 |
| 2560 | 21350 | 0 | QPSK_20MHz 50RB_0 offset | Toward Top | Fig.31 | 11.43 | 11.5 | 1.016 | 0.847 | 0.861 | -0.17 |
| Repeated | | | | | | | | | | | |
| 2560 | 21350 | 0 | QPSK_20MHz 1RB_0 offset | Toward Top | Fig.32 | 11.43 | 11.5 | 1.016 | 0.85 | 0.864 | -0.11 |

16. SAR Measurement Variability

SAR measurement variability must be assessed for each frequency band, which is determined by the SAR probe calibration point and tissue-equivalent medium used for the device measurements. When both head and body tissue-equivalent media are required for SAR measurements in a frequency band, the variability measurement procedures should be applied to the tissue medium with the highest measured SAR, using the highest measured SAR configuration for that tissue-equivalent medium.

The following procedures are applied to determine if repeated measurements are required.

- 1) Repeated measurement is not required when the original highest measured SAR is < 0.80 W/kg; steps 2) through 4) do not apply.
- 2) When the original highest measured SAR is ≥ 0.80 W/kg, repeat that measurement once.
- 3) Perform a second repeated measurement only if the ratio of largest to smallest SAR for the original and first repeated measurements is > 1.20 or when the original or repeated measurement is ≥ 1.45 W/kg (~ 10% from the 1-g SAR limit).
- 4) Perform a third repeated measurement only if the original, first or second repeated measurement is ≥ 1.5 W/kg and the ratio of largest to smallest SAR for the original, first and second repeated measurements is > 1.20.

Table 16.1: SAR Measurement Variability (1g)

| Frequency | | Mode | Test Position | Original SAR (W/kg) | First Repeated SAR (W/kg) | The Ratio | Second Repeated (W/kg) |
|-----------|-----------|-----------------------------|---------------|---------------------|---------------------------|-----------|------------------------|
| MHz | Ch. | | | | | | |
| 1907.6 | 2863 | 12.2K RMC | Ground | 1.06 | 1.08 | 1.02 | N/A |
| 1852.4 | 2712 | 12.2K RMC | Ground | 1.04 | 1.07 | 1.03 | N/A |
| 1880 | 1890 0 | QPSK_20MHz 50RB_0 offset | Ground | 0.874 | 0.874 | 1.00 | N/A |
| 1745 | 2030 0 | QPSK_20MHz 1RB_0 offset | Ground | 0.957 | 0.991 | 1.04 | N/A |
| 1745 | 2030 0 | QPSK_20MHz 1RB_0 offset | Ground | 0.96 | 0.976 | 1.02 | N/A |
| 2560 | 2135 0 | QPSK_20MHz 1RB_0 offset | Top | 1.05 | 1.03 | 1.02 | N/A |
| 2560 | 2135 0 | QPSK_20MHz 5RB_0 offset | Top | 0.847 | 0.85 | 1.00 | N/A |

Note: According to the KDB 865664 D01 repeated measurement is not required when the original highest measured SAR is < 0.8 W/kg.

17. Measurement Uncertainty

| Measurement uncertainty for 750 MHz to 3 GHz averaged over 1 gram | | | | | | |
|---|-------------|-------------|------------|-------------|-----------------|--------------------|
| Uncertainty Component | Uncertainty | Prob. | Div. | $C_{i(1g)}$ | Std. Unc. (1-g) | V_i or V_{eff} |
| Measurement System | | | | | | |
| Probe Calibration ($k=1$) | 5.4 | Normal | 2 | 1 | 5.40 | ∞ |
| Probe Isotropy | 4.70 | Rectangular | $\sqrt{3}$ | 0.7 | 1.90 | ∞ |
| Modulation Response | 2.40 | Rectangular | $\sqrt{3}$ | 1 | 1.39 | ∞ |
| Hemispherical Isotropy | 2.60 | Rectangular | $\sqrt{3}$ | 0.7 | 1.05 | ∞ |
| Boundary Effect | 1.00 | Rectangular | $\sqrt{3}$ | 1 | 0.58 | ∞ |
| Linearity | 4.70 | Rectangular | $\sqrt{3}$ | 1 | 2.71 | ∞ |
| System Detection Limit | 1.00 | Rectangular | $\sqrt{3}$ | 1 | 0.58 | ∞ |
| Readout Electronics | 0.30 | Normal | 1 | 1 | 0.30 | ∞ |
| Response Time | 0.80 | Rectangular | $\sqrt{3}$ | 1 | 0.46 | ∞ |
| Integration Time | 2.60 | Rectangular | $\sqrt{3}$ | 1 | 1.50 | ∞ |
| RF Ambient Noise | 0.00 | Rectangular | $\sqrt{3}$ | 1 | 0.00 | ∞ |
| RF Ambient Reflections | 0.00 | Rectangular | $\sqrt{3}$ | 1 | 0.00 | ∞ |
| Probe Positioner | 0.40 | Rectangular | $\sqrt{3}$ | 1 | 0.23 | ∞ |
| Probe Positioning | 2.90 | Rectangular | $\sqrt{3}$ | 1 | 1.67 | ∞ |
| Post-processing | 1.00 | Rectangular | $\sqrt{3}$ | 1 | 0.58 | ∞ |
| Test sample Related | | | | | | |
| Test sample Positioning | 1.2 | Normal | 1 | 1 | 1.2 | 5 |
| Device Holder Uncertainty | 3.2 | Normal | 1 | 1 | 3.2 | 71 |
| Power drift | 5 | Rectangular | $\sqrt{3}$ | 1 | 2.89 | ∞ |
| Power Scaling | 0 | Rectangular | $\sqrt{3}$ | 1 | 0.00 | ∞ |
| Phantom and Tissue Parameters | | | | | | |
| Phantom Uncertainty | 4 | Rectangular | $\sqrt{3}$ | 1 | 2.31 | ∞ |
| SAR correction | 1.9 | Rectangular | $\sqrt{3}$ | 1 | 1.10 | ∞ |
| Liquid Conductivity (meas) | 4.19 | Rectangular | 1 | 0.78 | 3.27 | ∞ |
| Liquid Permittivity (meas) | 4.4 | Rectangular | 1 | 0.26 | 1.14 | ∞ |
| Temp. unc. - Conductivity | 0.18 | Rectangular | $\sqrt{3}$ | 0.78 | 0.08 | ∞ |
| Temp. unc. - Permittivity | 0.54 | Rectangular | $\sqrt{3}$ | 0.23 | 0.07 | ∞ |
| Combined Std. Uncertainty | | RSS | | | 9.39 | |
| Expanded STD Uncertainty | | $k=2$ | | | 18.77% | |

| System check uncertainty for 750 MHz to 3 GHz averaged over 1 gram | | | | | | |
|--|-------------|-------------|------------|-------------|-----------------|--------------------|
| Uncertainty Component | Uncertainty | Prob. | Div. | $C_{i(1g)}$ | Std. Unc. (1-g) | V_i or V_{eff} |
| Measurement System | | | | | | |
| Probe Calibration ($k=1$) | 5.40 | Normal | 1 | 1 | 5.40 | ∞ |
| Probe Isotropy | 4.70 | Rectangular | $\sqrt{3}$ | 0.7 | 1.90 | ∞ |
| Modulation Response | 2.40 | Rectangular | $\sqrt{3}$ | 1 | 1.39 | ∞ |
| Hemispherical Isotropy | 2.60 | Rectangular | $\sqrt{3}$ | 0.7 | 1.05 | ∞ |
| Boundary Effect | 1.00 | Rectangular | $\sqrt{3}$ | 1 | 0.58 | ∞ |
| Linearity | 4.70 | Rectangular | $\sqrt{3}$ | 1 | 2.71 | ∞ |
| System Detection Limit | 1.00 | Rectangular | $\sqrt{3}$ | 1 | 0.58 | ∞ |
| Readout Electronics | 0.30 | Normal | 1 | 1 | 0.30 | ∞ |
| Response Time | 0.80 | Rectangular | $\sqrt{3}$ | 1 | 0.46 | ∞ |
| Integration Time | 2.60 | Rectangular | $\sqrt{3}$ | 1 | 1.50 | ∞ |
| RF Ambient Noise | 0.00 | Rectangular | $\sqrt{3}$ | 1 | 0.00 | ∞ |
| RF Ambient Reflections | 0.00 | Rectangular | $\sqrt{3}$ | 1 | 0.00 | ∞ |
| Probe Positioner | 0.40 | Rectangular | $\sqrt{3}$ | 1 | 0.23 | ∞ |
| Probe Positioning | 2.90 | Rectangular | $\sqrt{3}$ | 1 | 1.67 | ∞ |
| Post-processing | 1.00 | Rectangular | $\sqrt{3}$ | 1 | 0.58 | ∞ |
| Field source | | | | | | |
| Deviation of the experimental source from numerical source | 5.5 | Normal | 1 | 1 | 5.5 | ∞ |
| Source to liquid distance | 2 | Rectangular | $\sqrt{3}$ | 1 | 1.15 | ∞ |
| Power drift | 5 | Rectangular | $\sqrt{3}$ | 1 | 2.89 | ∞ |
| Phantom and Tissue Parameters | | | | | | |
| Phantom Uncertainty | 4 | Rectangular | $\sqrt{3}$ | 1 | 2.31 | ∞ |
| SAR correction | 1.9 | Rectangular | $\sqrt{3}$ | 1 | 1.10 | ∞ |
| Liquid Conductivity (meas) | 4.19 | Normal | 1 | 0.78 | 3.27 | ∞ |
| Liquid Permittivity (meas) | 4.4 | Normal | 1 | 0.26 | 1.14 | ∞ |
| Temp. unc. - Conductivity | 0.18 | Rectangular | $\sqrt{3}$ | 0.78 | 0.08 | ∞ |
| Temp. unc. - Permittivity | 0.54 | Rectangular | $\sqrt{3}$ | 0.23 | 0.07 | ∞ |
| Combined Std. Uncertainty | | RSS | | | 10.39 | |
| Expanded STD Uncertainty | | $k=2$ | | | 20.79% | |

18. Main Test Instrument

Table 18.1: List of Main Instruments

| No. | Name | Type | Serial Number | Calibration Date | Valid Period |
|-----|-----------------------|----------------|---------------|--------------------------|--------------|
| 01 | Network analyzer | N5242A | MY51221755 | Jan 6, 2017 | 1 year |
| 02 | Power meter | NRVD | 102257 | May 11, 2017 | 1 year |
| 03 | Power sensor | NRV-Z5 | 100241 | | |
| | | | 100644 | | |
| 04 | Signal Generator | E4438C | MY49072044 | May 11, 2017 | 1 Year |
| 05 | Amplifier | NTWPA-0086010F | 12023024 | No Calibration Requested | |
| 06 | Coupler | 778D | MY4825551 | May 11, 2017 | 1 year |
| 07 | BTS | E5515C | MY50266468 | Jan 6, 2017 | 1 year |
| 08 | BTS | MT8820C | 6201240338 | May 11, 2017 | 1 year |
| 09 | E-field Probe | EX3DV4 | 3754 | Jan 13, 2017 | 1 year |
| 10 | DAE | SPEAG DAE4 | 1244 | Dec 12,2016 | 1 year |
| 11 | Dipole Validation Kit | SPEAG D835V2 | 4d112 | Oct 22, 2015 | 2 year |
| | | SPEAG D1750V2 | 1044 | Nov 3,2015 | 2 year |
| | | SPEAG D1900V2 | 5d134 | Nov 4,2015 | 2 year |
| | | SPEAG D2450V2 | 858 | Oct 30,2015 | 2 year |
| | | SPEAG D2600V2 | 1031 | Oct 30,2015 | 2 year |

ANNEX A. GRAPH RESULTS

WCDMA Band2 Ground Mode High 14mm

Date/Time: 2017/4/27

Electronics: DAE4 Sn1244

Medium: Body 1900MHz

Medium parameters used (extrapolated): $f = 1907.6$ MHz; $\sigma = 1.579$ S/m; $\epsilon_r = 54.555$; $\rho = 1000$ kg/m³

Ambient Temperature:22°C Liquid Temperature:22°C

Communication System: WCDMA Professional Band II; Frequency: 1907.6 MHz; Duty Cycle: 1:1

Probe: EX3DV4 - SN3754ConvF(7.6, 7.6, 7.6); Calibrated: 1/13/2017

WCDMA Band2 Ground Mode High/Area Scan (131x211x1):

Measurement grid: dx=10 mm, dy=10 mm

Maximum value of SAR (Measurement) = 1.15 W/kg

WCDMA Band2 Ground Mode High/Zoom Scan (7x7x7)/Cube 0:

Measurement grid: dx=5mm, dy=5mm, dz=5mm

Reference Value = 9.791 V/m; Power Drift = 0.18 dB

Peak SAR (extrapolated) = 1.86 W/kg

SAR(1 g) = 1.06 W/kg; SAR(10 g) = 0.577 W/kg

Maximum value of SAR (measured) = 1.18 W/kg

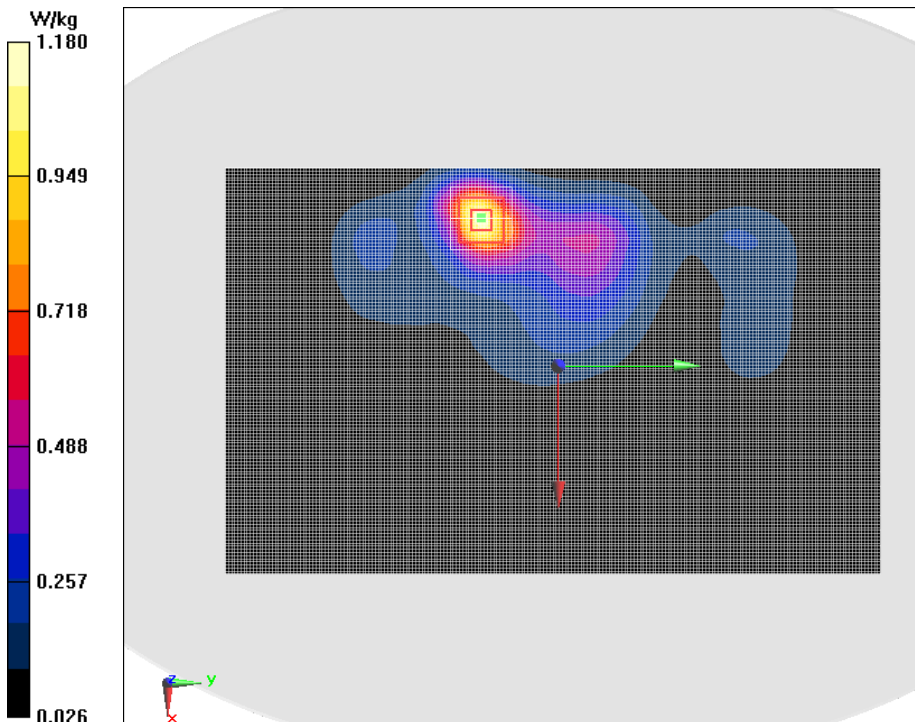

Fig.1 WCDMA Band2 Ground Mode High

WCDMA Band2 Ground Mode repeated 14mm

Date/Time: 2017/4/27

Electronics: DAE4 Sn1244

Medium: Body 1900MHz

Medium parameters used (extrapolated): $f = 1907.6$ MHz; $\sigma = 1.579$ S/m; $\epsilon_r = 54.555$; $\rho = 1000$ kg/m³

Ambient Temperature:22°C Liquid Temperature:22°C

Communication System: WCDMA Professional Band II; Frequency: 1907.6 MHz; Duty Cycle: 1:1

Probe: EX3DV4 - SN3754ConvF(7.6, 7.6, 7.6); Calibrated: 1/13/2017

WCDMA Band2 Ground Mode repeated/Area Scan (131x211x1):

Measurement grid: dx=10 mm, dy=10 mm

Maximum value of SAR (Measurement) = 1.18 W/kg

WCDMA Band2 Ground Mode repeated/Zoom Scan (7x7x7)/Cube 0:

Measurement grid: dx=5mm, dy=5mm, dz=5mm

Reference Value = 9.821 V/m; Power Drift = 0.12 dB

Peak SAR (extrapolated) = 1.90 W/kg

SAR(1 g) = 1.08 W/kg; SAR(10 g) = 0.590 W/kg

Maximum value of SAR (measured) = 1.21 W/kg

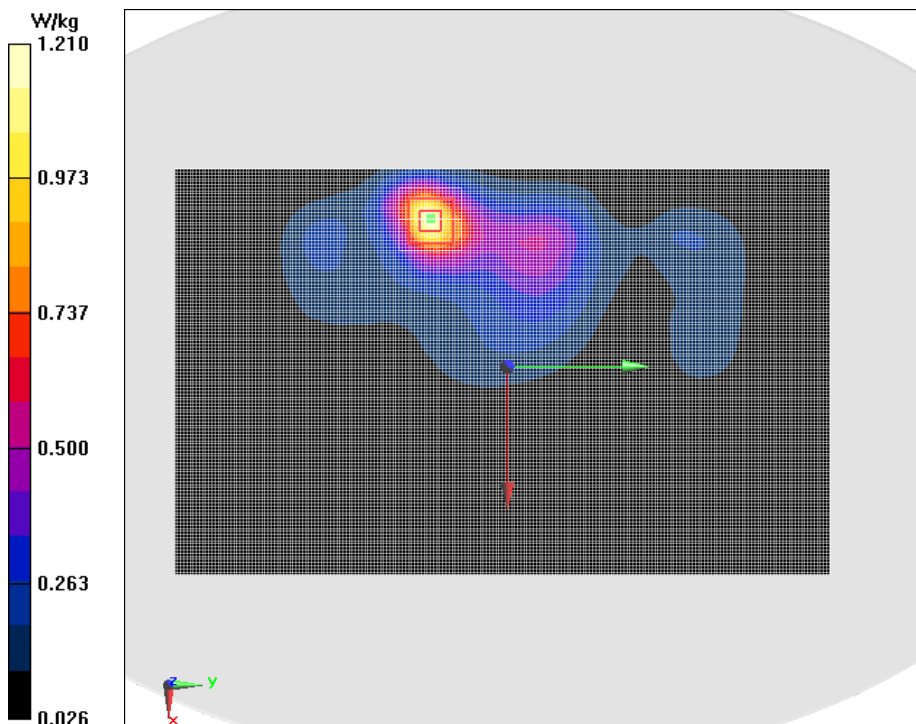

Fig.2 WCDMA Band2 Ground Mode repeated

WCDMA Band2 Ground Mode Low 0mm

Date/Time: 2017/4/27

Electronics: DAE4 Sn1244

Medium: Body 1900MHz

Medium parameters used (interpolated): $f = 1852.4$ MHz; $\sigma = 1.523$ S/m; $\epsilon_r = 54.779$; $\rho = 1000$ kg/m³

Ambient Temperature:22°C Liquid Temperature:22°C

Communication System: WCDMA Professional Band II; Frequency: 1852.4 MHz; Duty Cycle: 1:1

Probe: EX3DV4 - SN3754ConvF(7.6, 7.6, 7.6); Calibrated: 1/13/2017

WCDMA Band2 Ground Mode Low/Area Scan (131x211x1):

Measurement grid: dx=10 mm, dy=10 mm

Maximum value of SAR (Measurement) = 1.10 W/kg

WCDMA Band2 Ground Mode Low/Zoom Scan (7x7x7)/Cube 0:

Measurement grid: dx=5mm, dy=5mm, dz=5mm

Reference Value = 1.103 V/m; Power Drift = 0.07 dB

Peak SAR (extrapolated) = 2.42 W/kg

SAR(1 g) = 1.04 W/kg; SAR(10 g) = 0.462 W/kg

Maximum value of SAR (measured) = 1.20 W/kg

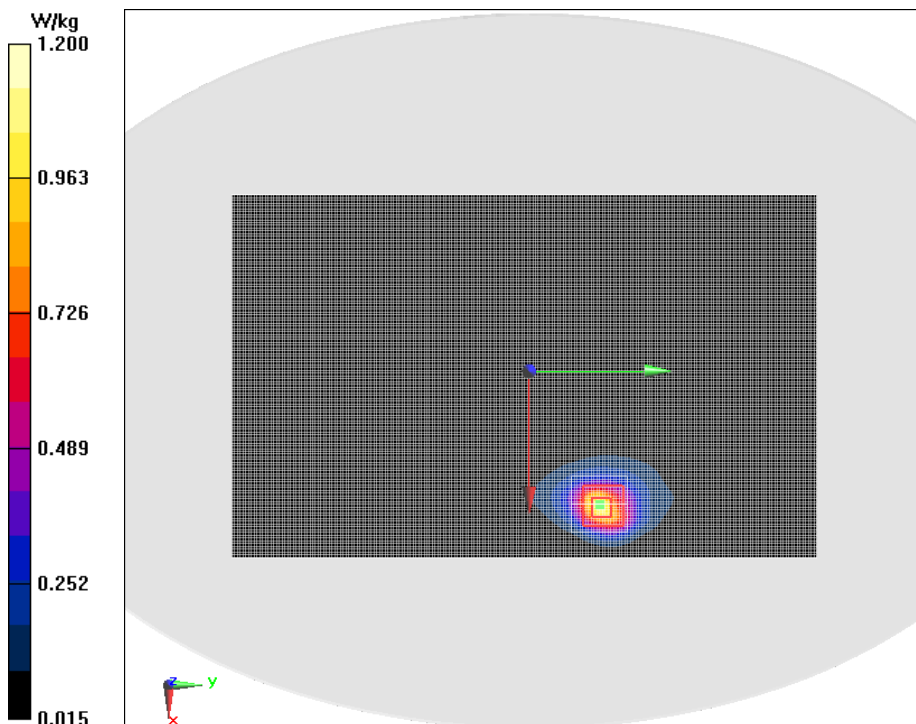

Fig.3 WCDMA Band2 Ground Mode Low

WCDMA Band2 Ground Mode Low repeated 0mm

Date/Time: 2017/4/27

Electronics: DAE4 Sn1244

Medium: Body 1900MHz

Medium parameters used (interpolated): $f = 1852.4$ MHz; $\sigma = 1.523$ S/m; $\epsilon_r = 54.779$; $\rho = 1000$ kg/m³

Ambient Temperature:22°C Liquid Temperature:22°C

Communication System: WCDMA Professional Band II; Frequency: 1852.4 MHz; Duty Cycle: 1:1

Probe: EX3DV4 - SN3754ConvF(7.6, 7.6, 7.6); Calibrated: 1/13/2017

WCDMA Band2 Ground Mode Low repeated/Area Scan (131x211x1):

Measurement grid: dx=10 mm, dy=10 mm

Maximum value of SAR (Measurement) = 1.15 W/kg

WCDMA Band2 Ground Mode Low repeated/Zoom Scan (7x7x7)/Cube 0:

Measurement grid: dx=5mm, dy=5mm, dz=5mm

Reference Value = 1.173 V/m; Power Drift = -0.10 dB

Peak SAR (extrapolated) = 2.49 W/kg

SAR(1 g) = 1.07 W/kg; SAR(10 g) = 0.473 W/kg

Maximum value of SAR (measured) = 1.25 W/kg

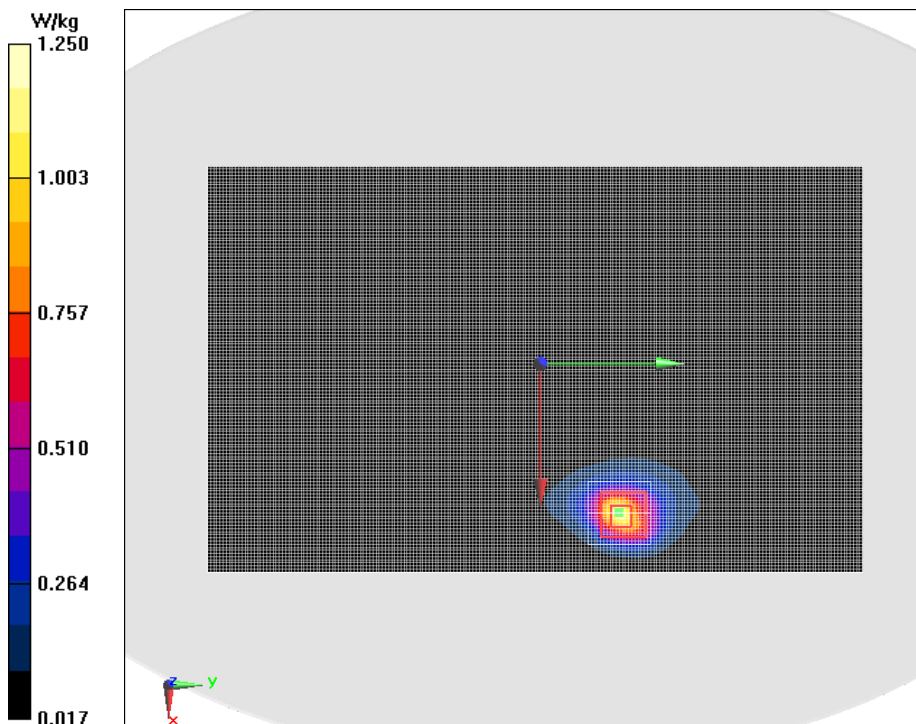

Fig.4 WCDMA Band2 Ground Mode Low repeated

WCDMA Band5 Ground Mode High 14mm

Date/Time: 2017/4/28

Electronics: DAE4 Sn1244

Medium: Body 835MHz

Medium parameters used: $f = 847$ MHz; $\sigma = 1.012$ S/m; $\epsilon_r = 55.214$; $\rho = 1000$ kg/m³

Ambient Temperature: 22°C Liquid Temperature: 22°C

Communication System: WCDMA Professional Band V; Frequency: 846.6 MHz; Duty Cycle: 1:1

Probe: EX3DV4 - SN3754ConvF(9.66, 9.66, 9.66); Calibrated: 1/13/2017

WCDMA Band5 Ground Mode High/Area Scan (141x211x1):

Measurement grid: $dx=10$ mm, $dy=10$ mm

Maximum value of SAR (Measurement) = 0.426 W/kg

WCDMA Band5 Ground Mode High/Zoom Scan (7x7x7)/Cube 0:

Measurement grid: $dx=5$ mm, $dy=5$ mm, $dz=5$ mm

Reference Value = 3.938 V/m; Power Drift = 0.12 dB

Peak SAR (extrapolated) = 0.604 W/kg

SAR(1 g) = 0.389 W/kg; SAR(10 g) = 0.243 W/kg

Maximum value of SAR (measured) = 0.424 W/kg

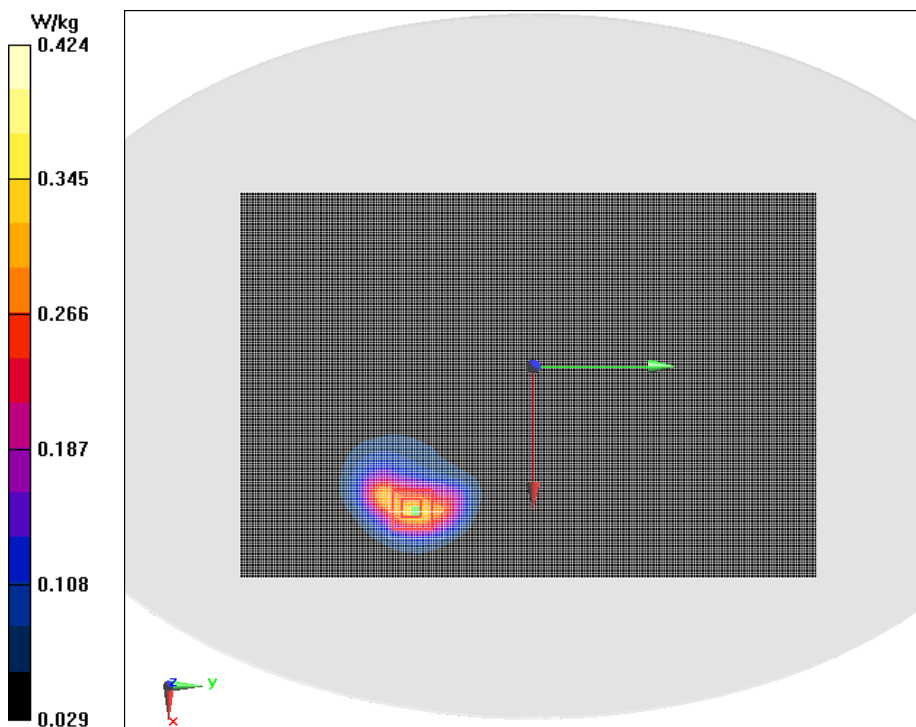

Fig.5 WCDMA Band5 Ground Mode High 14mm

WCDMA Band5 Ground Mode Low 0mm

Date/Time: 2017/4/28

Electronics: DAE4 Sn1244

Medium: Body 835MHz

Medium parameters used (interpolated): $f = 826.4$ MHz; $\sigma = 0.994$ S/m; $\epsilon_r = 55.147$; $\rho = 1000$ kg/m³

Ambient Temperature:22°C Liquid Temperature:22°C

Communication System: WCDMA Professional Band V; Frequency: 826.4 MHz; Duty Cycle: 1:1

Probe: EX3DV4 - SN3754ConvF(9.66, 9.66, 9.66); Calibrated: 1/13/2017

WCDMA Band5 Ground Mode Low/Area Scan (141x211x1):

Measurement grid: dx=10 mm, dy=10 mm

Maximum value of SAR (Measurement) = 0.385 W/kg

WCDMA Band5 Ground Mode Low/Zoom Scan (7x7x7)/Cube 0:

Measurement grid: dx=5mm, dy=5mm, dz=5mm

Reference Value = 0.8110 V/m; Power Drift = -0.08 dB

Peak SAR (extrapolated) = 1.04 W/kg

SAR(1 g) = 0.450 W/kg; SAR(10 g) = 0.221 W/kg

Maximum value of SAR (measured) = 0.488 W/kg

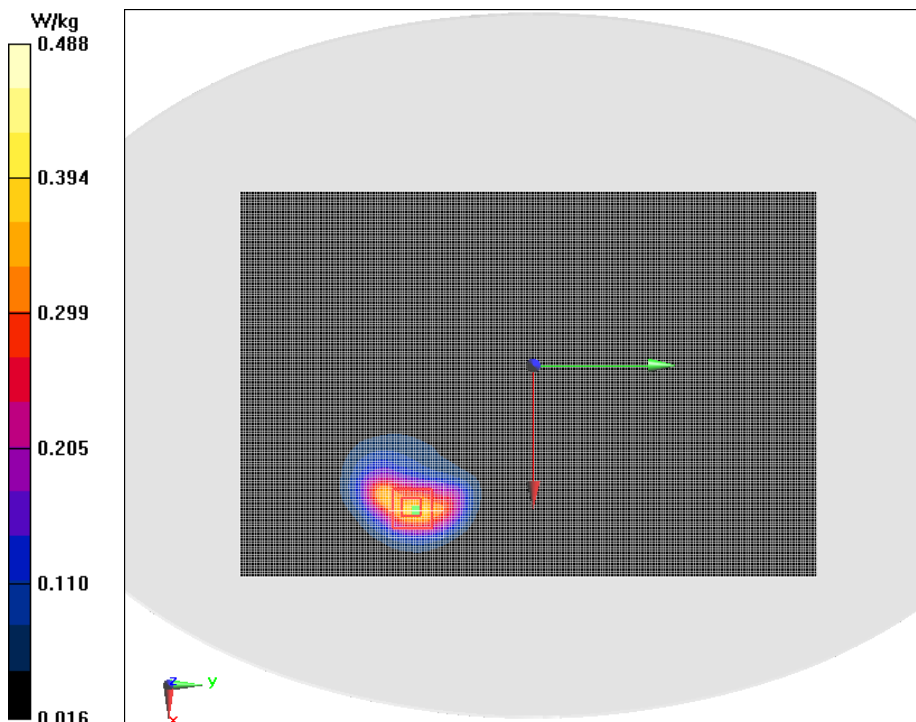

Fig.6 WCDMA Band5 Ground Mode Low

LTE Band 2 20MHz 1RB 0offset Ground Mode Middle 14mm

Date/Time: 2017/4/27

Electronics: DAE4 Sn1244

Medium: Body 1900MHz

Medium parameters used: $f = 1880$ MHz; $\sigma = 1.551$ S/m; $\epsilon_r = 54.667$; $\rho = 1000$ kg/m³

Ambient Temperature:22°C Liquid Temperature:22°C

Communication System: LTE Band 2 Professional 1900MHz; Frequency: 1880 MHz; Duty Cycle: 1:1

Probe: EX3DV4 - SN3754ConvF(7.6, 7.6, 7.6); Calibrated: 1/13/2017

LTE Band 2 20MHz 1RB 0offset Ground Mode Middle 14mm/Area Scan (151x201x1):

Measurement grid: dx=10 mm, dy=10 mm

Maximum value of SAR (Measurement) = 1.09 W/kg

LTE Band 2 20MHz 1RB 0offset Ground Mode Middle 14mm/Zoom Scan (7x7x7)/Cube 0:

Measurement grid: dx=5mm, dy=5mm, dz=5mm

Reference Value = 0.4110 V/m; Power Drift = 0.19 dB

Peak SAR (extrapolated) = 1.71 W/kg

SAR(1 g) = 0.735 W/kg; SAR(10 g) = 0.329 W/kg

Maximum value of SAR (measured) = 0.866 W/kg

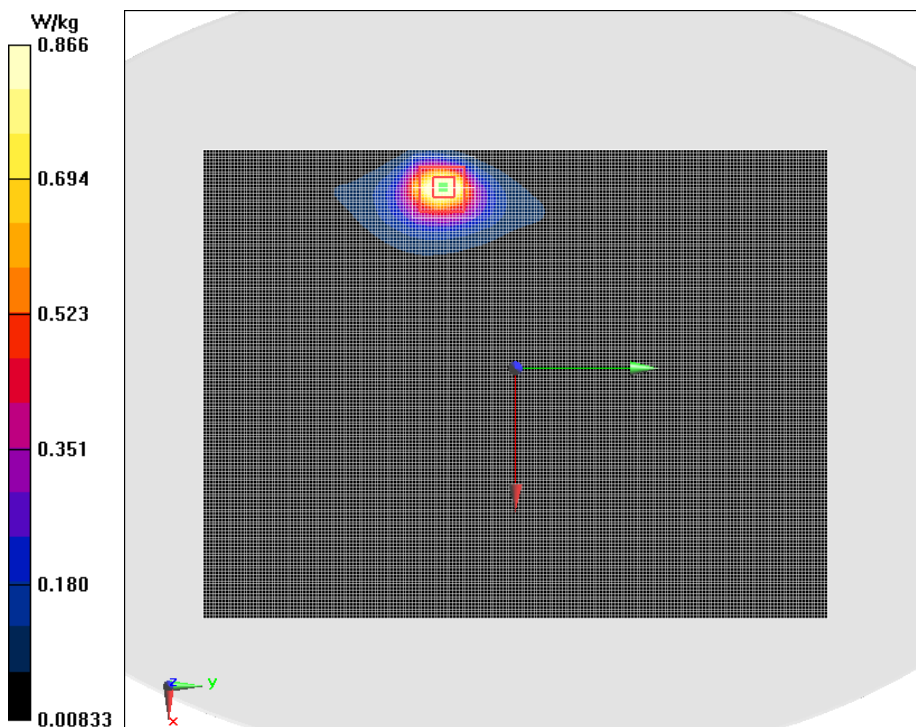

Fig.7 LTE Band 2 20MHz 1RB 0offset Ground Mode Middle 14mm

LTE Band 2 20MHz 50RB 0offset Ground Mode Middle 14mm

Date/Time: 2017/4/27

Electronics: DAE4 Sn1244

Medium: Body 1900MHz

Medium parameters used: $f = 1880 \text{ MHz}$; $\sigma = 1.551 \text{ S/m}$; $\epsilon_r = 54.667$; $\rho = 1000 \text{ kg/m}^3$

Ambient Temperature: 22°C Liquid Temperature: 22°C

Communication System: LTE Band 2 Professional 1900MHz; Frequency: 1880 MHz; Duty Cycle: 1:1

Probe: EX3DV4 - SN3754ConvF(7.6, 7.6, 7.6); Calibrated: 1/13/2017

LTE Band 2 20MHz 50RB 0offset Ground Mode Middle 14mm/Area Scan (131x211x1):

Measurement grid: $dx=10 \text{ mm}$, $dy=10 \text{ mm}$

Maximum value of SAR (Measurement) = 0.712 W/kg

LTE Band 2 20MHz 50RB 0offset Ground Mode Middle 14mm/Zoom Scan (7x7x7)/Cube 0:

Measurement grid: $dx=5\text{mm}$, $dy=5\text{mm}$, $dz=5\text{mm}$

Reference Value = 6.753 V/m; Power Drift = 0.18 dB

Peak SAR (extrapolated) = 1.12 W/kg

SAR(1 g) = 0.642 W/kg; SAR(10 g) = 0.356 W/kg

Maximum value of SAR (measured) = 0.713 W/kg

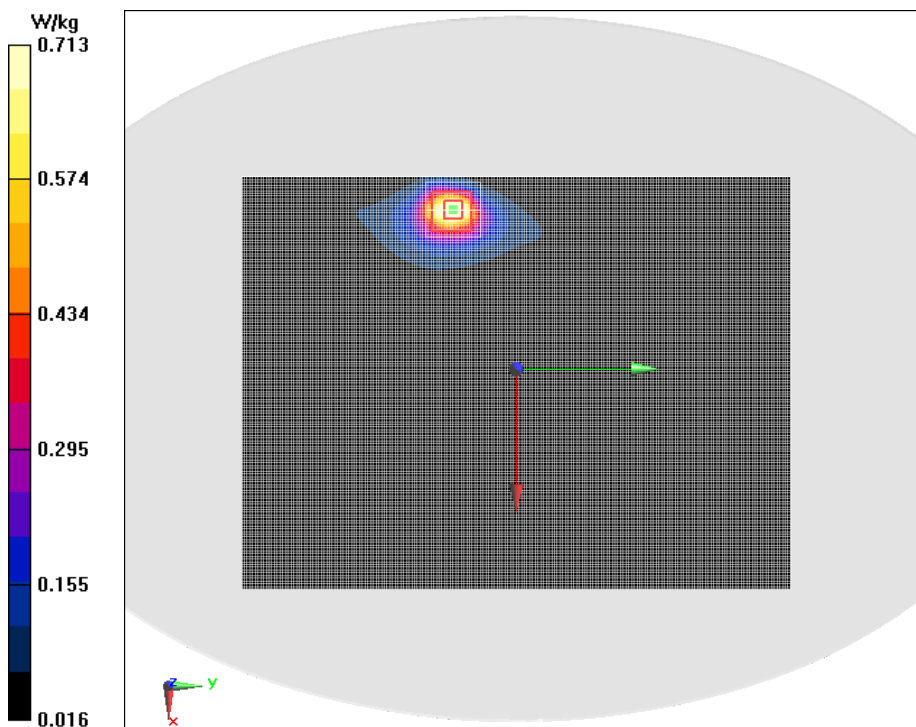

Fig.8 LTE Band 2 20MHz 50RB 0offset Ground Mode Middle 14mm

LTE Band 2 20MHz 1RB 0offset Ground Mode Middle 0mm

Date/Time: 2017/4/27

Electronics: DAE4 Sn1244

Medium: Body 1900MHz

Medium parameters used: $f = 1880 \text{ MHz}$; $\sigma = 1.551 \text{ S/m}$; $\epsilon_r = 54.667$; $\rho = 1000 \text{ kg/m}^3$

Ambient Temperature: 22°C Liquid Temperature: 22°C

Communication System: LTE Band 2 Professional 1900MHz; Frequency: 1880 MHz; Duty Cycle: 1:1

Probe: EX3DV4 - SN3754ConvF(7.6, 7.6, 7.6); Calibrated: 1/13/2017

LTE Band 2 20MHz 1RB 0offset Ground Mode Middle/Area Scan (151x201x1):

Measurement grid: $dx=10 \text{ mm}$, $dy=10 \text{ mm}$

Maximum value of SAR (Measurement) = 1.09 W/kg

LTE Band 2 20MHz 1RB 0offset Ground Mode Middle/Zoom Scan (7x7x7)/Cube 0:

Measurement grid: $dx=5\text{mm}$, $dy=5\text{mm}$, $dz=5\text{mm}$

Reference Value = 0.4110 V/m; Power Drift = 0.09 dB

Peak SAR (extrapolated) = 1.71 W/kg

SAR(1 g) = 0.735 W/kg; SAR(10 g) = 0.329 W/kg

Maximum value of SAR (measured) = 0.866 W/kg

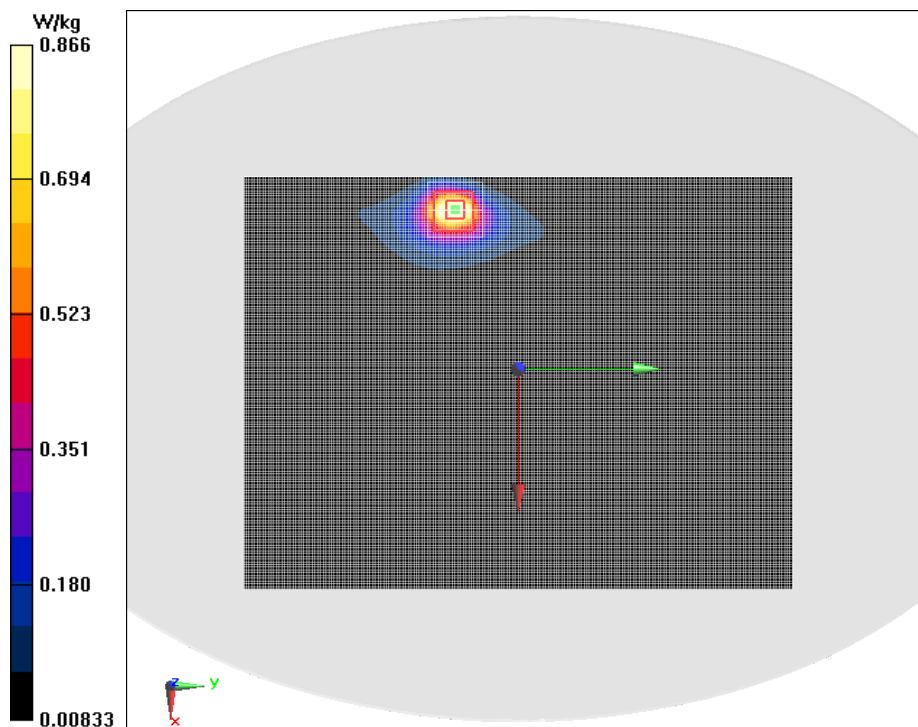

Fig.9 LTE Band 2 20MHz 1RB 0offset Ground Mode Middle

LTE Band 2 20MHz 50RB 0offset Ground Mode Middle 0mm

Date/Time: 2017/4/27

Electronics: DAE4 Sn1244

Medium: Body 1900MHz

Medium parameters used: $f = 1880$ MHz; $\sigma = 1.551$ S/m; $\epsilon_r = 54.667$; $\rho = 1000$ kg/m³

Ambient Temperature: 22°C Liquid Temperature: 22°C

Communication System: LTE Band 2 Professional 1900MHz; Frequency: 1880 MHz; Duty Cycle: 1:1

Probe: EX3DV4 - SN3754ConvF(7.6, 7.6, 7.6); Calibrated: 1/13/2017

LTE Band 2 20MHz 50RB 0offset Ground Mode Middle/Area Scan (131x211x1):

Measurement grid: $dx=10$ mm, $dy=10$ mm

Maximum value of SAR (Measurement) = 1.02 W/kg

LTE Band 2 20MHz 50RB 0offset Ground Mode Middle/Zoom Scan (7x7x7)/Cube 0:

Measurement grid: $dx=5$ mm, $dy=5$ mm, $dz=5$ mm

Reference Value = 0.7480 V/m; Power Drift = -0.10 dB

Peak SAR (extrapolated) = 2.03 W/kg

SAR(1 g) = 0.874 W/kg; SAR(10 g) = 0.386 W/kg

Maximum value of SAR (measured) = 0.982 W/kg

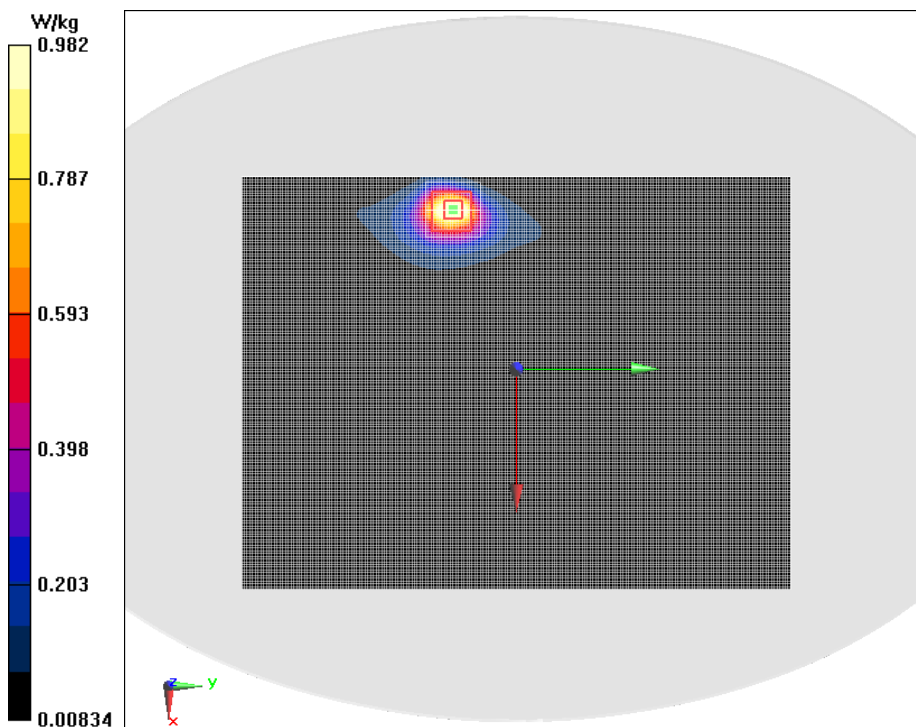

Fig.10 LTE Band 2 20MHz 50RB 0offset Ground Mode Middle

LTE Band 2 20MHz 100RB 0offset Ground Mode 0mm

Date/Time: 2017/4/27

Electronics: DAE4 Sn1244

Medium: Body 1900MHz

Medium parameters used: $f = 1880 \text{ MHz}$; $\sigma = 1.551 \text{ S/m}$; $\epsilon_r = 54.667$; $\rho = 1000 \text{ kg/m}^3$

Ambient Temperature: 22°C Liquid Temperature: 22°C

Communication System: LTE Band 2 Professional 1900MHz; Frequency: 1880 MHz; Duty Cycle: 1:1

Probe: EX3DV4 - SN3754ConvF(7.6, 7.6, 7.6); Calibrated: 1/13/2017

LTE Band 2 20MHz 100RB 0offset Ground Mode/Area Scan (131x211x1):

Measurement grid: $dx=10 \text{ mm}$, $dy=10 \text{ mm}$

Maximum value of SAR (Measurement) = 1.09 W/kg

LTE Band 2 20MHz 100RB 0offset Ground Mode/Zoom Scan (7x7x7)/Cube 0:

Measurement grid: $dx=5\text{mm}$, $dy=5\text{mm}$, $dz=5\text{mm}$

Reference Value = 0.6240 V/m; Power Drift = -0.18 dB

Peak SAR (extrapolated) = 2.04 W/kg

SAR(1 g) = 0.869 W/kg; SAR(10 g) = 0.383 W/kg

Maximum value of SAR (measured) = 1.03 W/kg

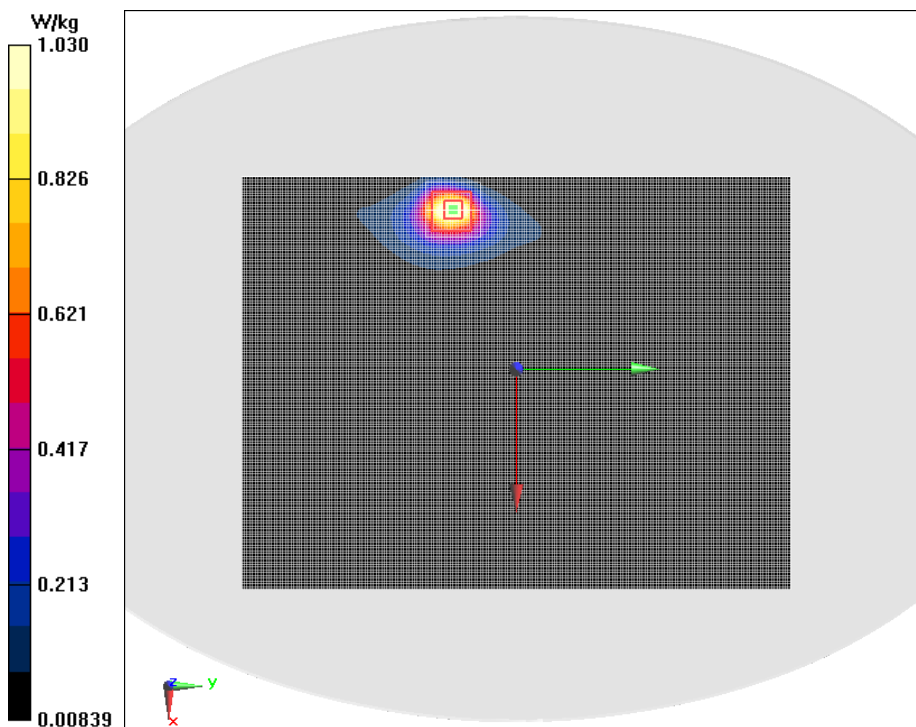

Fig.11 LTE Band 2 20MHz 100RB 0offset Ground Mode

LTE Band 2 20MHz 50RB 0offset Ground Mode Middle repeated 0mm

Date/Time: 2017/4/27

Electronics: DAE4 Sn1244

Medium: Body 1900MHz

Medium parameters used: $f = 1880 \text{ MHz}$; $\sigma = 1.551 \text{ S/m}$; $\epsilon_r = 54.667$; $\rho = 1000 \text{ kg/m}^3$

Ambient Temperature: 22°C Liquid Temperature: 22°C

Communication System: LTE Band 2 Professional 1900MHz; Frequency: 1880 MHz; Duty Cycle: 1:1

Probe: EX3DV4 - SN3754ConvF(7.6, 7.6, 7.6); Calibrated: 1/13/2017

LTE Band 2 20MHz 50RB 0offset Ground Mode Middle repeated/Area Scan (131x211x1):

Measurement grid: $dx=10 \text{ mm}$, $dy=10 \text{ mm}$

Maximum value of SAR (Measurement) = 1.01 W/kg

LTE Band 2 20MHz 50RB 0offset Ground Mode Middle repeated/Zoom Scan (7x7x7)/Cube 0:

Measurement grid: $dx=5\text{mm}$, $dy=5\text{mm}$, $dz=5\text{mm}$

Reference Value = 1.404 V/m; Power Drift = -0.15 dB

Peak SAR (extrapolated) = 2.03 W/kg

SAR(1 g) = 0.874 W/kg; SAR(10 g) = 0.386 W/kg

Maximum value of SAR (measured) = 0.983 W/kg

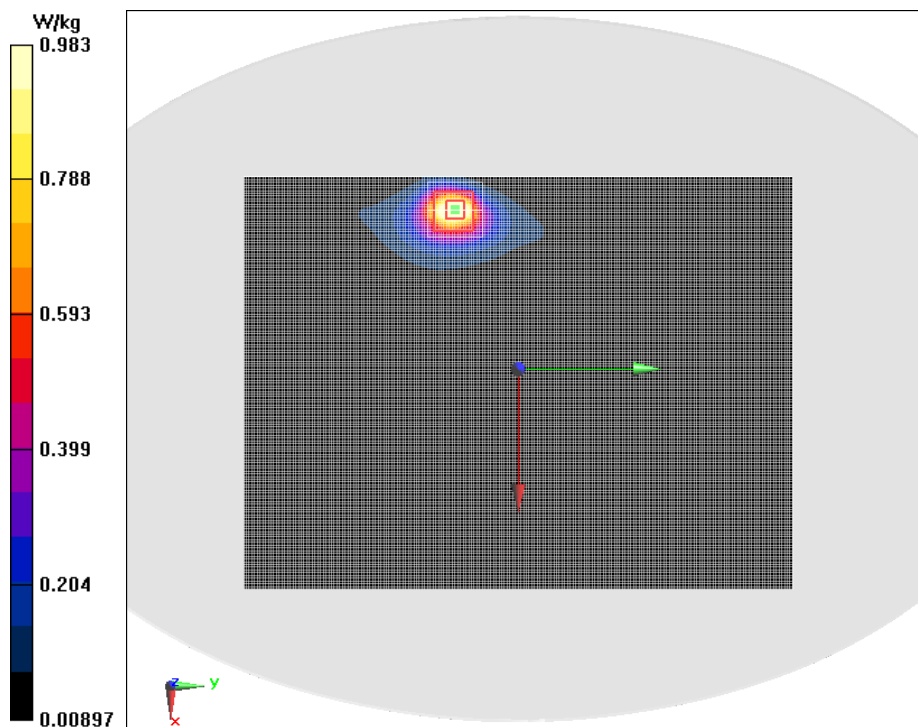

Fig.12 LTE Band 2 20MHz 50RB 0offset Ground Mode Middle repeated

LTE Band 4 20MHz 1RB 0offset Ground Mode High 14mm

Date/Time: 2017/4/29

Electronics: DAE4 Sn1244

Medium: Body 1800MHz

Medium parameters used: $f = 1745 \text{ MHz}$; $\sigma = 1.435 \text{ S/m}$; $\epsilon_r = 52.3$; $\rho = 1000 \text{ kg/m}^3$

Ambient Temperature: 22°C Liquid Temperature: 22°C

Communication System: LTE Band 4 Professional 1800MHz; Frequency: 1745 MHz; Duty Cycle: 1:1

Probe: EX3DV4 - SN3754ConvF(7.8, 7.8, 7.8); Calibrated: 1/13/2017

LTE Band 4 20MHz 1RB 0offset Ground Mode High 14mm/Area Scan (131x211x1):

Measurement grid: $dx=10 \text{ mm}$, $dy=10 \text{ mm}$

Maximum value of SAR (Measurement) = 1.03 W/kg

LTE Band 4 20MHz 1RB 0offset Ground Mode High 14mm/Zoom Scan (7x7x7)/Cube 0:

Measurement grid: $dx=5\text{mm}$, $dy=5\text{mm}$, $dz=5\text{mm}$

Reference Value = 6.714 V/m; Power Drift = 0.14 dB

Peak SAR (extrapolated) = 1.59 W/kg

SAR(1 g) = 0.957 W/kg; SAR(10 g) = 0.572 W/kg

Maximum value of SAR (measured) = 1.03 W/kg

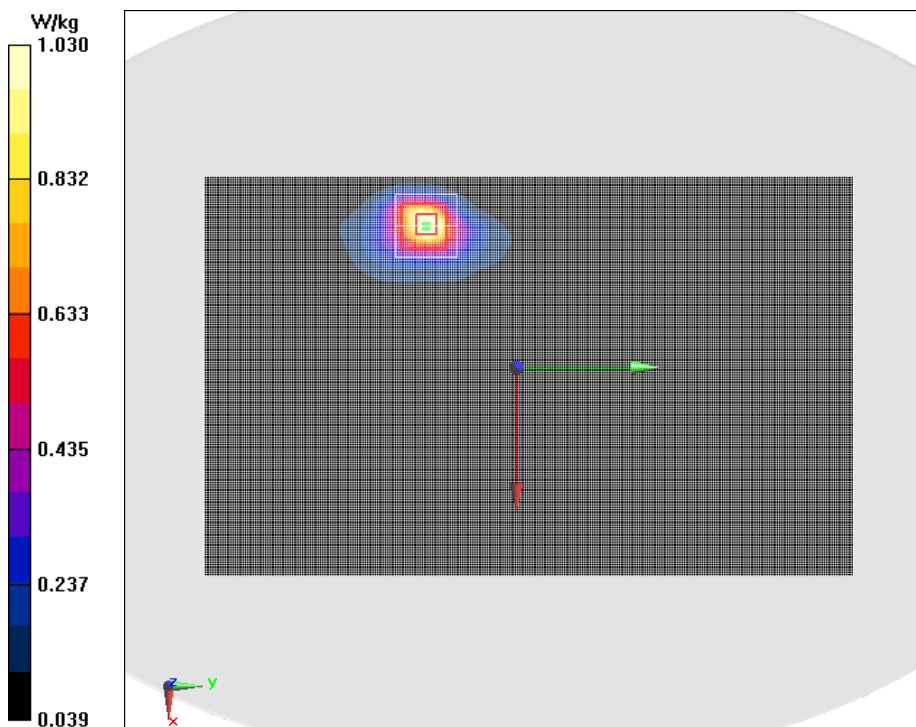

Fig.13 LTE Band 4 20MHz 1RB 0offset Ground Mode High 14mm

LTE Band 4 20MHz 50RB 0offset Ground Mode Middle 14mm

Date/Time: 2017/4/29

Electronics: DAE4 Sn1244

Medium: Body 1800MHz

Medium parameters used (interpolated): $f = 1732.5$ MHz; $\sigma = 1.422$ S/m; $\epsilon_r = 52.305$; $\rho = 1000$ kg/m³

Ambient Temperature:22°C Liquid Temperature:22°C

Communication System: LTE Band 4 Professional 1800MHz; Frequency: 1732.5 MHz; Duty Cycle: 1:1

Probe: EX3DV4 - SN3754ConvF(7.8, 7.8, 7.8); Calibrated: 1/13/2017

LTE Band 4 20MHz 50RB 0offset Ground Mode Middle 14mm/Area Scan (131x211x1):

Measurement grid: dx=10 mm, dy=10 mm

Maximum value of SAR (Measurement) = 0.815 W/kg

LTE Band 4 20MHz 50RB 0offset Ground Mode Middle 14mm/Zoom Scan (7x7x7)/Cube 0:

Measurement grid: dx=5mm, dy=5mm, dz=5mm

Reference Value = 6.176 V/m; Power Drift = -0.14 dB

Peak SAR (extrapolated) = 1.22 W/kg

SAR(1 g) = 0.743 W/kg; SAR(10 g) = 0.439 W/kg

Maximum value of SAR (measured) = 0.817 W/kg

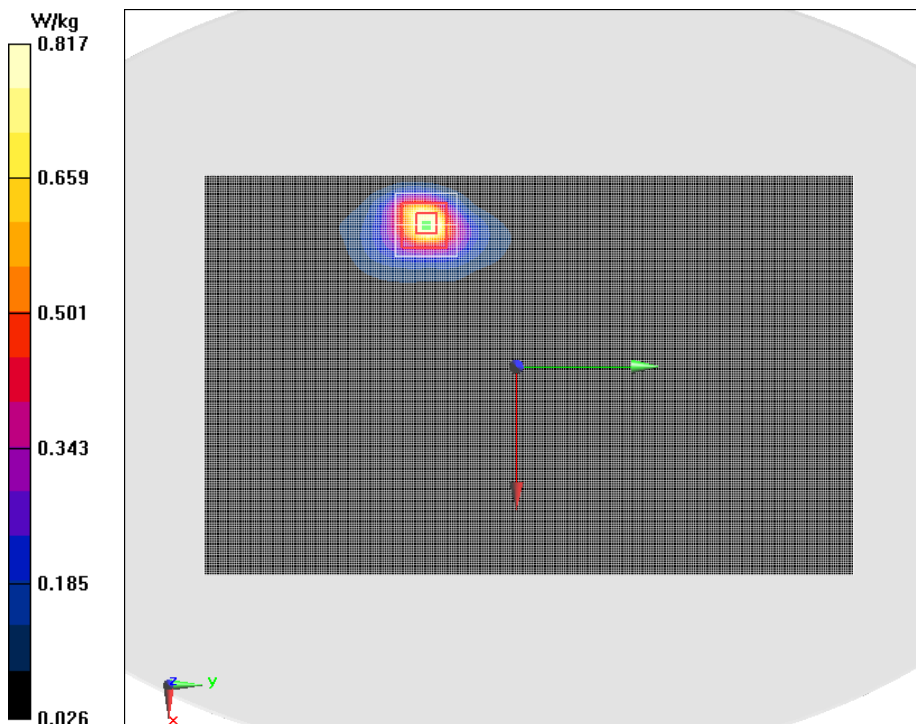

Fig.14 LTE Band 4 20MHz 50RB 0offset Ground Mode Middle 14mm

LTE Band 4 20MHz 100RB 0offset Ground Mode Middle 14mm

Date/Time: 2017/4/29

Electronics: DAE4 Sn1244

Medium: Body 1800MHz

Medium parameters used (interpolated): $f = 1732.5$ MHz; $\sigma = 1.422$ S/m; $\epsilon_r = 52.305$; $\rho = 1000$ kg/m³

Ambient Temperature:22°C Liquid Temperature:22°C

Communication System: LTE Band 4 Professional 1800MHz; Frequency: 1732.5 MHz; Duty Cycle: 1:1

Probe: EX3DV4 - SN3754ConvF(7.8, 7.8, 7.8); Calibrated: 1/13/2017

LTE Band 4 20MHz 100RB 0offset Ground Mode Middle 14mm/Area Scan (131x211x1):

Measurement grid: dx=10 mm, dy=10 mm

Maximum value of SAR (Measurement) = 0.798 W/kg

LTE Band 4 20MHz 100RB 0offset Ground Mode Middle 14mm/Zoom Scan (7x7x7)/Cube 0:

Measurement grid: dx=5mm, dy=5mm, dz=5mm

Reference Value = 7.592 V/m; Power Drift = 0.12 dB

Peak SAR (extrapolated) = 1.31 W/kg

SAR(1 g) = 0.743 W/kg; SAR(10 g) = 0.418 W/kg

Maximum value of SAR (measured) = 0.833 W/kg

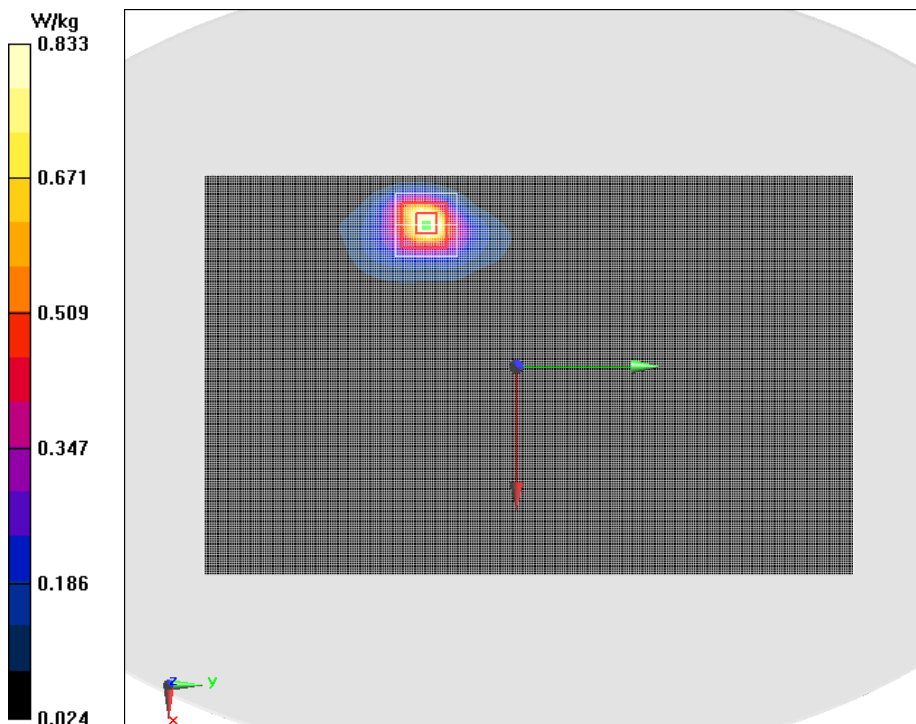

Fig.15 LTE Band 4 20MHz 100RB 0offset Ground Mode Middle 14mm

LTE Band 4 20MHz 1RB 0offset Ground Mode High 14mm repeated

Date/Time: 2017/4/29

Electronics: DAE4 Sn1244

Medium: Body 1800MHz

Medium parameters used: $f = 1745 \text{ MHz}$; $\sigma = 1.435 \text{ S/m}$; $\epsilon_r = 52.3$; $\rho = 1000 \text{ kg/m}^3$

Ambient Temperature: 22°C Liquid Temperature: 22°C

Communication System: LTE Band 4 Professional 1800MHz; Frequency: 1745 MHz; Duty Cycle: 1:1

Probe: EX3DV4 - SN3754ConvF(7.8, 7.8, 7.8); Calibrated: 1/13/2017

LTE Band 4 20MHz 1RB 0offset Ground Mode High 14mm repeated/Area Scan (131x211x1):

Measurement grid: $dx=10 \text{ mm}$, $dy=10 \text{ mm}$

Maximum value of SAR (Measurement) = 1.11 W/kg

LTE Band 4 20MHz 1RB 0offset Ground Mode High 14mm repeated/Zoom Scan (7x7x7)/Cube 0:

Measurement grid: $dx=5\text{mm}$, $dy=5\text{mm}$, $dz=5\text{mm}$

Reference Value = 6.996 V/m; Power Drift = 0.11 dB

Peak SAR (extrapolated) = 1.65 W/kg

SAR(1 g) = 0.991 W/kg; SAR(10 g) = 0.584 W/kg

Maximum value of SAR (measured) = 1.08 W/kg

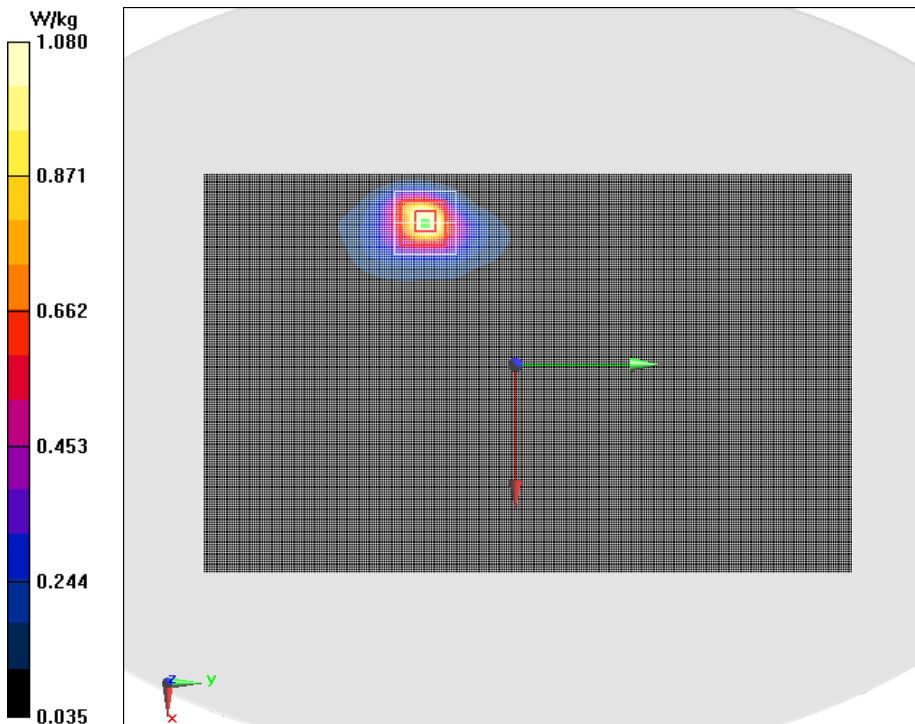

Fig.16 LTE Band 4 20MHz 1RB 0offset Ground Mode High 14mm repeated

LTE Band 4 20MHz 1RB 0offset Ground Mode High 0mm

Date/Time: 2017/4/29

Electronics: DAE4 Sn1244

Medium: Body 1800MHz

Medium parameters used: $f = 1745$ MHz; $\sigma = 1.435$ S/m; $\epsilon_r = 52.3$; $\rho = 1000$ kg/m³

Ambient Temperature: 22°C Liquid Temperature: 22°C

Communication System: LTE Band 4 Professional 1800MHz; Frequency: 1745 MHz; Duty Cycle: 1:1

Probe: EX3DV4 - SN3754ConvF(7.8, 7.8, 7.8); Calibrated: 1/13/2017

LTE Band 4 20MHz 1RB 0offset Ground Mode High/Area Scan (131x211x1):

Measurement grid: dx=10 mm, dy=10 mm

Maximum value of SAR (Measurement) = 1.20 W/kg

LTE Band 4 20MHz 1RB 0offset Ground Mode High/Zoom Scan (7x7x7)/Cube 0:

Measurement grid: dx=5mm, dy=5mm, dz=5mm

Reference Value = 3.061 V/m; Power Drift = 0.13 dB

Peak SAR (extrapolated) = 2.20 W/kg

SAR(1 g) = 0.960 W/kg; SAR(10 g) = 0.447 W/kg

Maximum value of SAR (measured) = 1.15 W/kg

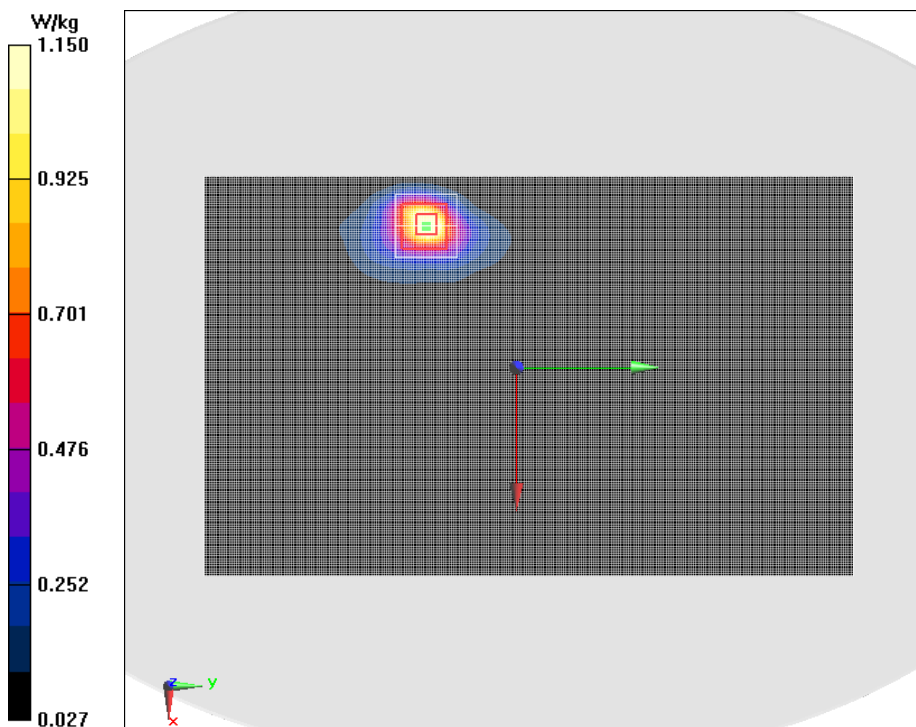

Fig.17 LTE Band 4 20MHz 1RB 0offset Ground Mode High

LTE Band 4 20MHz 1RB 50offset Ground Mode High 0mm

Date/Time: 2017/4/29

Electronics: DAE4 Sn1244

Medium: Body 1800MHz

Medium parameters used: $f = 1745$ MHz; $\sigma = 1.435$ S/m; $\epsilon_r = 52.3$; $\rho = 1000$ kg/m³

Ambient Temperature: 22°C Liquid Temperature: 22°C

Communication System: LTE Band 4 Professional 1800MHz; Frequency: 1745 MHz; Duty Cycle: 1:1

Probe: EX3DV4 - SN3754ConvF(7.8, 7.8, 7.8); Calibrated: 1/13/2017

LTE Band 4 20MHz 1RB 50offset Ground Mode High/Area Scan (161x261x1):

Measurement grid: dx=10 mm, dy=10 mm

Maximum value of SAR (Measurement) = 1.10 W/kg

LTE Band 4 20MHz 1RB 50offset Ground Mode High/Zoom Scan (7x7x7)/Cube 0:

Measurement grid: dx=5mm, dy=5mm, dz=5mm

Reference Value = 1.896 V/m; Power Drift = -0.12 dB

Peak SAR (extrapolated) = 2.12 W/kg

SAR(1 g) = 0.933 W/kg; SAR(10 g) = 0.420 W/kg

Maximum value of SAR (measured) = 1.06 W/kg

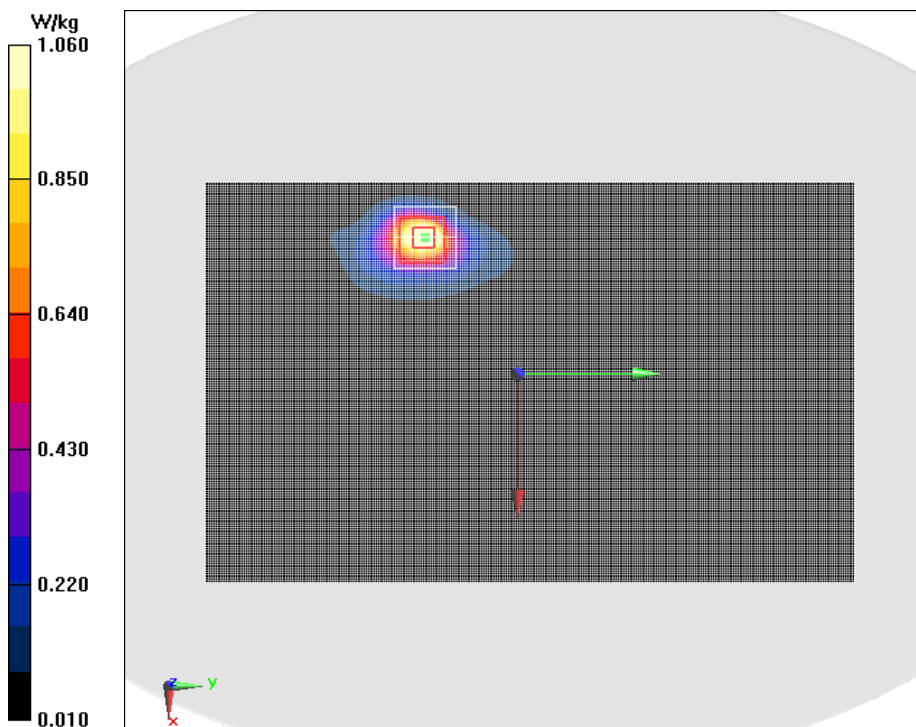

Fig.18 LTE Band 4 20MHz 1RB 50offset Ground Mode High

LTE Band 4 20MHz 1RB 100offset Ground Mode Middle 0mm

Date/Time: 2017/4/29

Electronics: DAE4 Sn1244

Medium: Body 1800MHz

Medium parameters used (interpolated): $f = 1732.5$ MHz; $\sigma = 1.422$ S/m; $\epsilon_r = 52.305$; $\rho = 1000$ kg/m³

Ambient Temperature:22°C Liquid Temperature:22°C

Communication System: LTE Band 4 Professional 1800MHz; Frequency: 1732.5 MHz; Duty Cycle: 1:1

Probe: EX3DV4 - SN3754ConvF(7.8, 7.8, 7.8); Calibrated: 1/13/2017

LTE Band 4 20MHz 1RB 100offset Ground Mode Middle 0mm/Area Scan (161x261x1):

Measurement grid: dx=10 mm, dy=10 mm

Maximum value of SAR (Measurement) = 1.39 W/kg

LTE Band 4 20MHz 1RB 100offset Ground Mode Middle 0mm/Zoom Scan (7x7x7)/Cube 0:

Measurement grid: dx=5mm, dy=5mm, dz=5mm

Reference Value = 0.7520 V/m; Power Drift = -0.16 dB

Peak SAR (extrapolated) = 2.02 W/kg

SAR(1 g) = 0.899 W/kg; SAR(10 g) = 0.409 W/kg

Maximum value of SAR (measured) = 1.05 W/kg

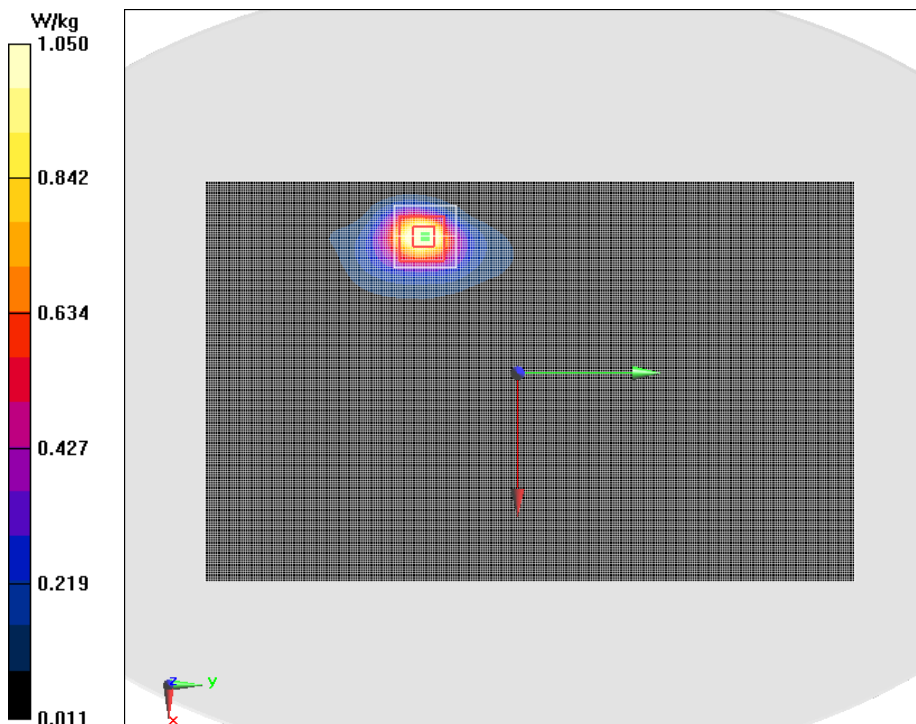

Fig.19 LTE Band 4 20MHz 1RB 100offset Ground Mode Middle 0mm

LTE Band 4 20MHz 1RB 0offset Ground Mode High repeated 0mm

Date/Time: 2017/4/29

Electronics: DAE4 Sn1244

Medium: Body 1800MHz

Medium parameters used: $f = 1745 \text{ MHz}$; $\sigma = 1.435 \text{ S/m}$; $\epsilon_r = 52.3$; $\rho = 1000 \text{ kg/m}^3$

Ambient Temperature: 22°C Liquid Temperature: 22°C

Communication System: LTE Band 4 Professional 1800MHz; Frequency: 1745 MHz; Duty Cycle: 1:1

Probe: EX3DV4 - SN3754ConvF(7.8, 7.8, 7.8); Calibrated: 1/13/2017

LTE Band 4 20MHz 1RB 0offset Ground Mode High repeated/Area Scan (161x261x1):

Measurement grid: $dx=10 \text{ mm}$, $dy=10 \text{ mm}$

Maximum value of SAR (Measurement) = 1.36 W/kg

LTE Band 4 20MHz 1RB 0offset Ground Mode High repeated/Zoom Scan (7x7x7)/Cube 0:

Measurement grid: $dx=5\text{mm}$, $dy=5\text{mm}$, $dz=5\text{mm}$

Reference Value = 3.016 V/m; Power Drift = 0.17 dB

Peak SAR (extrapolated) = 2.18 W/kg

SAR(1 g) = 0.976 W/kg; SAR(10 g) = 0.452 W/kg

Maximum value of SAR (measured) = 1.58 W/kg

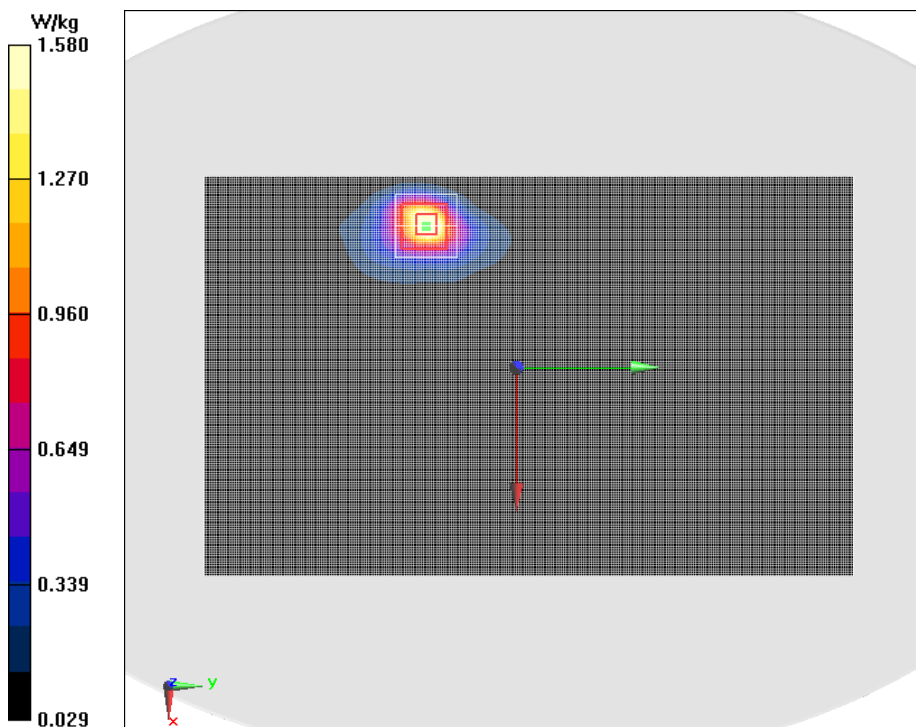

Fig.20 LTE Band 4 20MHz 1RB 0offset Ground Mode High repeated

LTE Band 5 10MHz 1RB 0offset Ground Mode High 14mm

Date/Time: 2017/4/28

Electronics: DAE4 Sn1244

Medium: Body 835MHz

Medium parameters used: $f = 844$ MHz; $\sigma = 1.008$ S/m; $\epsilon_r = 55.203$; $\rho = 1000$ kg/m³

Ambient Temperature: 22°C Liquid Temperature: 22°C

Communication System: LTE Band 5 Professional 850MHz; Frequency: 844 MHz; Duty Cycle: 1:1

Probe: EX3DV4 - SN3754ConvF(9.66, 9.66, 9.66); Calibrated: 1/13/2017

LTE Band 5 10MHz 1RB 0offset Ground Mode High 14mm/Area Scan (131x211x1):

Measurement grid: $dx=10$ mm, $dy=10$ mm

Maximum value of SAR (Measurement) = 0.558 W/kg

LTE Band 5 10MHz 1RB 0offset Ground Mode High 14mm/Zoom Scan (7x7x7)/Cube 0:

Measurement grid: $dx=5$ mm, $dy=5$ mm, $dz=5$ mm

Reference Value = 3.882 V/m; Power Drift = -0.13 dB

Peak SAR (extrapolated) = 0.759 W/kg

SAR(1 g) = 0.480 W/kg; SAR(10 g) = 0.296 W/kg

Maximum value of SAR (measured) = 0.518 W/kg

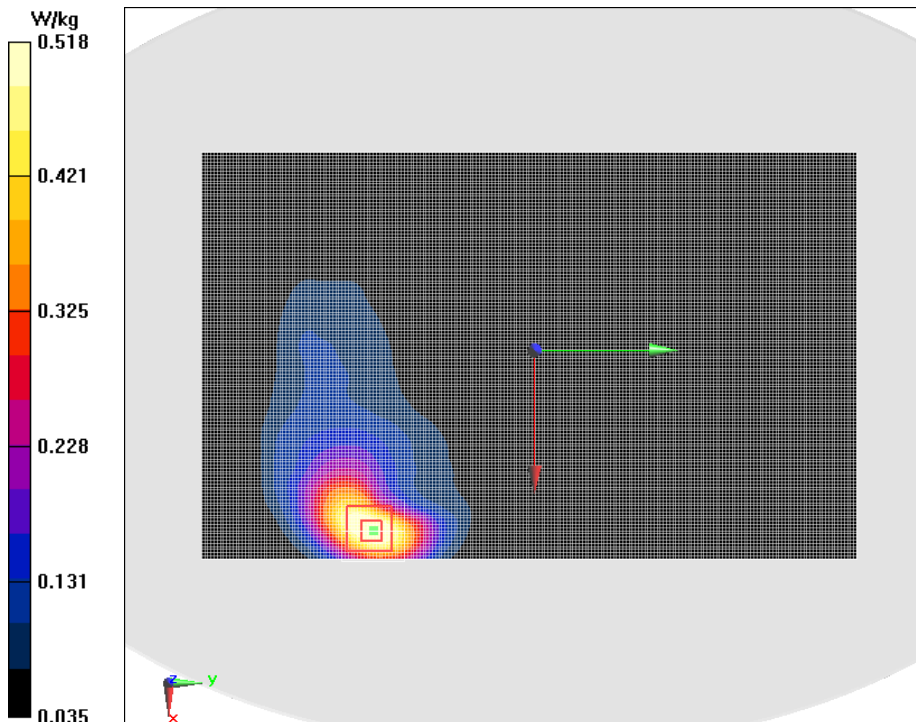

Fig.21 LTE Band 5 10MHz 1RB 0offset Ground Mode High 14mm

LTE Band 5 10MHz 25RB 0offset Ground Mode Middle 14mm

Date/Time: 2017/4/28

Electronics: DAE4 Sn1244

Medium: Body 835MHz

Medium parameters used (interpolated): $f = 836.5$ MHz; $\sigma = 0.997$ S/m; $\epsilon_r = 55.152$; $\rho = 1000$ kg/m³

Ambient Temperature:22°C Liquid Temperature:22°C

Communication System: LTE Band 5 Professional 850MHz; Frequency: 836.5 MHz; Duty Cycle: 1:1

Probe: EX3DV4 - SN3754ConvF(9.66, 9.66, 9.66); Calibrated: 1/13/2017

LTE Band 5 10MHz 25RB 0offset Ground Mode Middle 14mm/Area Scan (151x201x1):

Measurement grid: dx=10 mm, dy=10 mm

Maximum value of SAR (Measurement) = 0.427 W/kg

LTE Band 5 10MHz 25RB 0offset Ground Mode Middle 14mm/Zoom Scan (7x7x7)/Cube 0:

Measurement grid: dx=5mm, dy=5mm, dz=5mm

Reference Value = 3.476 V/m; Power Drift = 0.05 dB

Peak SAR (extrapolated) = 0.614 W/kg

SAR(1 g) = 0.384 W/kg; SAR(10 g) = 0.236 W/kg

Maximum value of SAR (measured) = 0.419 W/kg

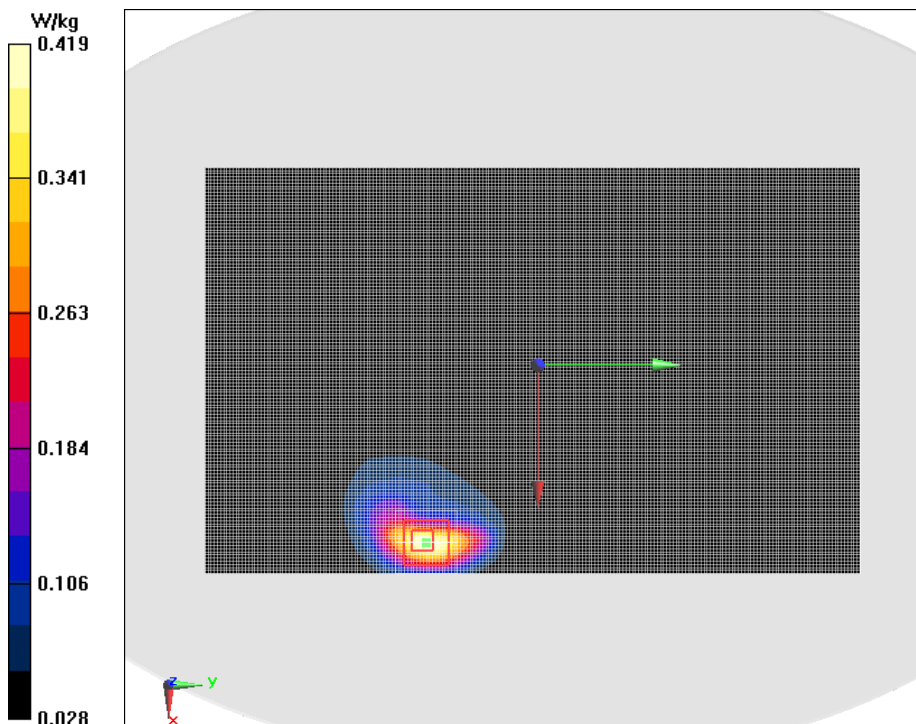

Fig.22 LTE Band 5 10MHz 25RB 0offset Ground Mode Middle 14mm

LTE Band 5 10MHz 1RB 0offset Ground Mode Low 0mm

Date/Time: 2017/4/28

Electronics: DAE4 Sn1244

Medium: Body 835MHz

Medium parameters used: $f = 829 \text{ MHz}$; $\sigma = 0.995 \text{ S/m}$; $\epsilon_r = 55.141$; $\rho = 1000 \text{ kg/m}^3$

Ambient Temperature: 22°C Liquid Temperature: 22°C

Communication System: LTE Band 5 Professional 850MHz; Frequency: 829 MHz; Duty Cycle: 1:1

Probe: EX3DV4 - SN3754ConvF(9.66, 9.66, 9.66); Calibrated: 1/13/2017

LTE Band 5 10MHz 1RB 0offset Ground Mode Low 0mm/Area Scan (131x211x1):

Measurement grid: $dx=10 \text{ mm}$, $dy=10 \text{ mm}$

Maximum value of SAR (Measurement) = 0.464 W/kg

LTE Band 5 10MHz 1RB 0offset Ground Mode Low 0mm/Zoom Scan (7x7x7)/Cube 0:

Measurement grid: $dx=5\text{mm}$, $dy=5\text{mm}$, $dz=5\text{mm}$

Reference Value = 0.7010 V/m; Power Drift = 0.05 dB

Peak SAR (extrapolated) = 0.930 W/kg

SAR(1 g) = 0.409 W/kg; SAR(10 g) = 0.201 W/kg

Maximum value of SAR (measured) = 0.458 W/kg

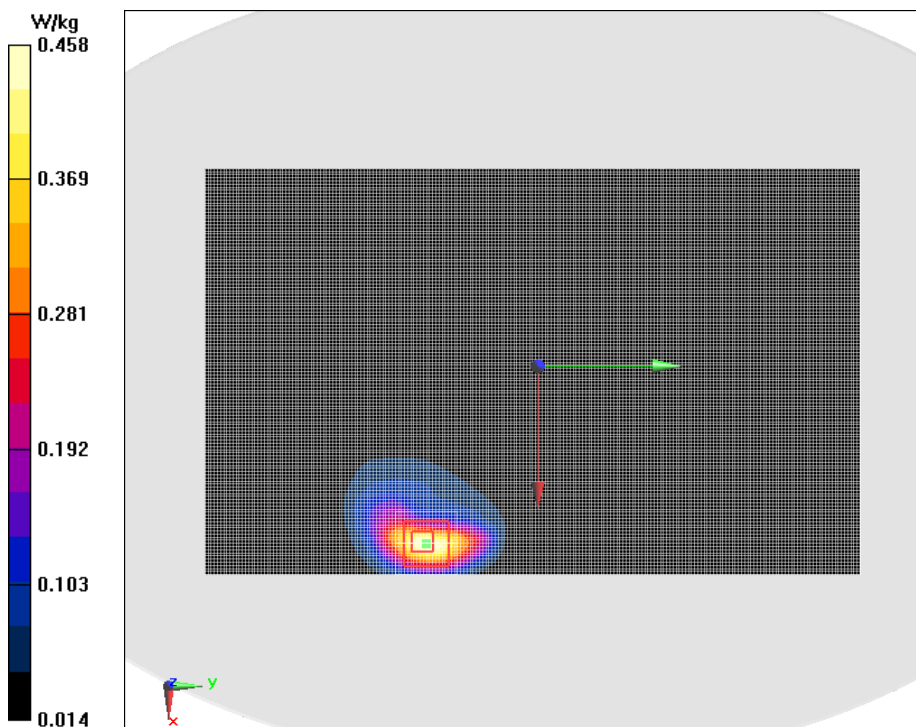

Fig.23 LTE Band 5 10MHz 1RB 0offset Ground Mode Low 0mm

LTE Band 5 10MHz 25RB 0offset Ground Mode Low 0mm

Date/Time: 2017/4/28

Electronics: DAE4 Sn1244

Medium: Body 835MHz

Medium parameters used: $f = 829 \text{ MHz}$; $\sigma = 0.995 \text{ S/m}$; $\epsilon_r = 55.141$; $\rho = 1000 \text{ kg/m}^3$

Ambient Temperature: 22°C Liquid Temperature: 22°C

Communication System: LTE Band 5 Professional 850MHz; Frequency: 829 MHz; Duty Cycle: 1:1

Probe: EX3DV4 - SN3754ConvF(9.66, 9.66, 9.66); Calibrated: 1/13/2017

LTE Band 5 10MHz 25RB 0offset Ground Mode Low 0mm/Area Scan (131x211x1):

Measurement grid: $dx=10 \text{ mm}$, $dy=10 \text{ mm}$

Maximum value of SAR (Measurement) = 0.459 W/kg

LTE Band 5 10MHz 25RB 0offset Ground Mode Low 0mm/Zoom Scan (7x7x7)/Cube 0:

Measurement grid: $dx=5\text{mm}$, $dy=5\text{mm}$, $dz=5\text{mm}$

Reference Value = 1.173 V/m; Power Drift = -0.01 dB

Peak SAR (extrapolated) = 0.955 W/kg

SAR(1 g) = 0.433 W/kg; SAR(10 g) = 0.216 W/kg

Maximum value of SAR (measured) = 0.490 W/kg

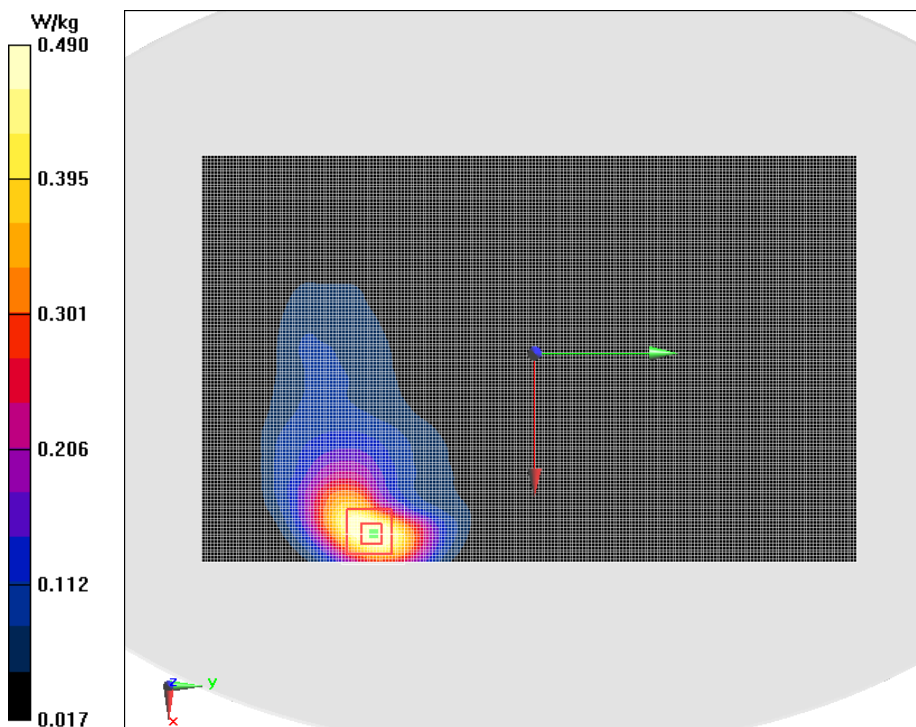

Fig.24 LTE Band 5 10MHz 25RB 0offset Ground Mode Low 0mm

802.11b Ground Mode Low 14mm

Date/Time: 2017/5/23

Electronics: DAE4 Sn1244

Medium: Body 2450MHz

Medium parameters used: $f = 2412 \text{ MHz}$; $\sigma = 1.932 \text{ S/m}$; $\epsilon_r = 53.051$; $\rho = 1000 \text{ kg/m}^3$

Ambient Temperature: 22°C Liquid Temperature: 22°C

Communication System: Wifi 2450 2450MHz; Frequency: 2412 MHz; Duty Cycle: 1:1

Probe: EX3DV4 - SN3754ConvF(7.22, 7.22, 7.22); Calibrated: 1/13/2017

802.11b Ground Mode Low 14mm/Area Scan (131x211x1):

Measurement grid: $dx=10 \text{ mm}$, $dy=10 \text{ mm}$

Maximum value of SAR (Measurement) = 0.128 W/kg

802.11b Ground Mode Low 14mm/Zoom Scan (7x7x7)/Cube 0:

Measurement grid: $dx=5\text{mm}$, $dy=5\text{mm}$, $dz=5\text{mm}$

Reference Value = 2.111 V/m; Power Drift = -0.05 dB

Peak SAR (extrapolated) = 0.245 W/kg

SAR(1 g) = 0.117 W/kg; SAR(10 g) = 0.059 W/kg

Maximum value of SAR (measured) = 0.126 W/kg

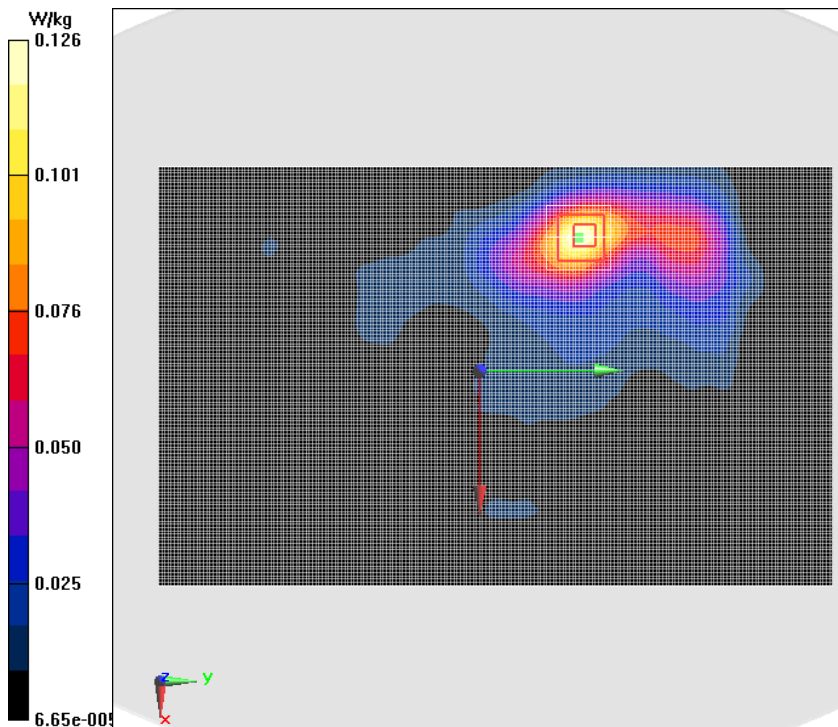

Fig.25 802.11b Ground Mode Low 14mm

802.11b Ground Mode Low

Date/Time: 2017/5/23

Electronics: DAE4 Sn1244

Medium: Body 2450MHz

Medium parameters used: $f = 2412 \text{ MHz}$; $\sigma = 1.932 \text{ S/m}$; $\epsilon_r = 53.051$; $\rho = 1000 \text{ kg/m}^3$

Ambient Temperature:22°C Liquid Temperature:22°C

Communication System: Wifi 2450 2450MHz; Frequency: 2412 MHz; Duty Cycle: 1:1

Probe: EX3DV4 - SN3754ConvF(7.22, 7.22, 7.22); Calibrated: 1/13/2017

802.11b Ground Mode Low/Area Scan (141x201x1):

Measurement grid: $dx=10 \text{ mm}$, $dy=10 \text{ mm}$

Maximum value of SAR (Measurement) = 0.491 W/kg

802.11b Ground Mode Low/Zoom Scan (7x7x7)/Cube 0:

Measurement grid: $dx=5\text{mm}$, $dy=5\text{mm}$, $dz=5\text{mm}$

Reference Value = 0 V/m; Power Drift = 0.12 dB

Peak SAR (extrapolated) = 1.02 W/kg

SAR(1 g) = 0.344 W/kg; SAR(10 g) = 0.137 W/kg

Maximum value of SAR (measured) = 0.385 W/kg

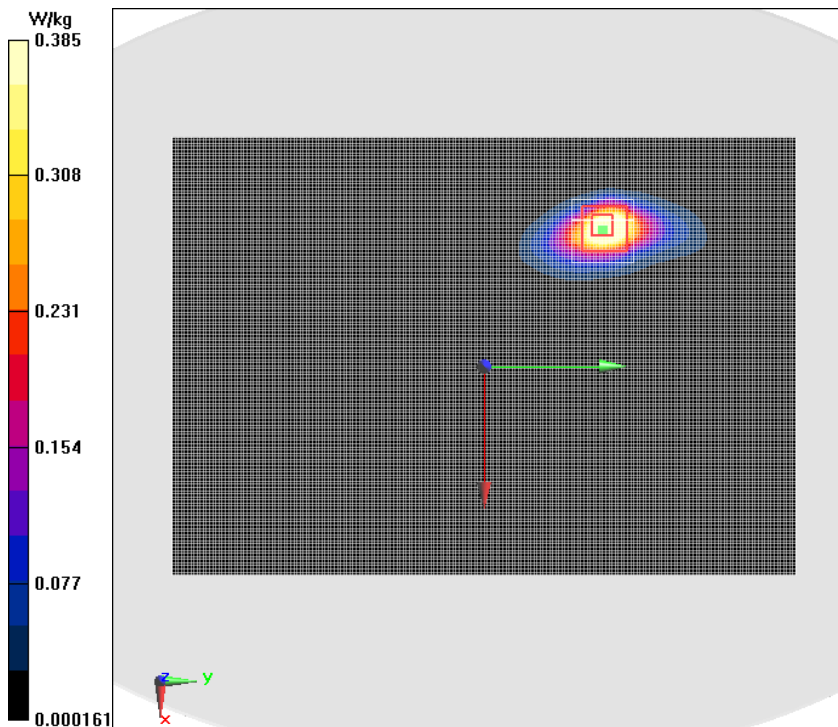

Fig.26 802.11b Ground Mode Low

LTE Band 7 20MHz 1RB 0offset Top Mode High 14mm

Date/Time: 2017/6/5

Electronics: DAE4 Sn1244

Medium: Body 2600MHz

Medium parameters used (interpolated): $f = 2560$ MHz; $\sigma = 2.044$ S/m; $\epsilon_r = 53.474$; $\rho = 1000$ kg/m³

Ambient Temperature:22°C Liquid Temperature:22°C

Communication System: LTE Band 7 Professional 2600MHz; Frequency: 2560 MHz; Duty Cycle: 1:1

Probe: EX3DV4 - SN3754ConvF(7.15, 7.15, 7.15); Calibrated: 1/13/2017

LTE Band 7 20MHz 1RB 0offset Top Mode High 14mm/Area Scan (41x191x1):

Measurement grid: dx=10 mm, dy=10 mm

Maximum value of SAR (Measurement) = 1.18 W/kg

LTE Band 7 20MHz 1RB 0offset Top Mode High 14mm/Zoom Scan (7x7x7)/Cube 0:

Measurement grid: dx=5mm, dy=5mm, dz=5mm

Reference Value = 14.74 V/m; Power Drift = 0.08 dB

Peak SAR (extrapolated) = 1.82 W/kg

SAR(1 g) = 1.05 W/kg; SAR(10 g) = 0.569 W/kg

Maximum value of SAR (measured) = 1.17 W/kg

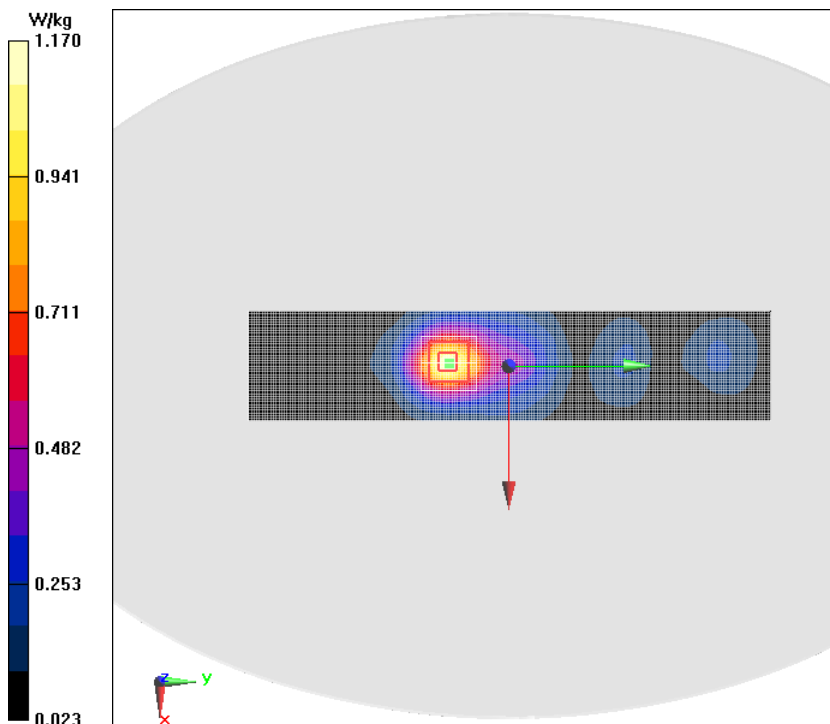

Fig.27 LTE Band 7 20MHz 1RB 0offset Top Mode High 14mm/

LTE Band 7 20MHz 50RB 0offset Top Mode High 14mm

Date/Time: 2017/6/5

Electronics: DAE4 Sn1244

Medium: Body 2600MHz

Medium parameters used (interpolated): $f = 2560$ MHz; $\sigma = 2.044$ S/m; $\epsilon_r = 53.474$; $\rho = 1000$ kg/m³

Ambient Temperature:22°C Liquid Temperature:22°C

Communication System: LTE Band 7 Professional 2600MHz; Frequency: 2560 MHz; Duty Cycle: 1:1

Probe: EX3DV4 - SN3754ConvF(7.15, 7.15, 7.15); Calibrated: 1/13/2017

LTE Band 7 20MHz 50RB 0offset Top Mode High 14mm/Area Scan (41x191x1):

Measurement grid: dx=10 mm, dy=10 mm

Maximum value of SAR (Measurement) = 0.966 W/kg

LTE Band 7 20MHz 50RB 0offset Top Mode High 14mm/Zoom Scan (7x7x7)/Cube 0:

Measurement grid: dx=5mm, dy=5mm, dz=5mm

Reference Value = 13.20 V/m; Power Drift = -0.02 dB

Peak SAR (extrapolated) = 1.50 W/kg

SAR(1 g) = 0.848 W/kg; SAR(10 g) = 0.460 W/kg

Maximum value of SAR (measured) = 0.939 W/kg

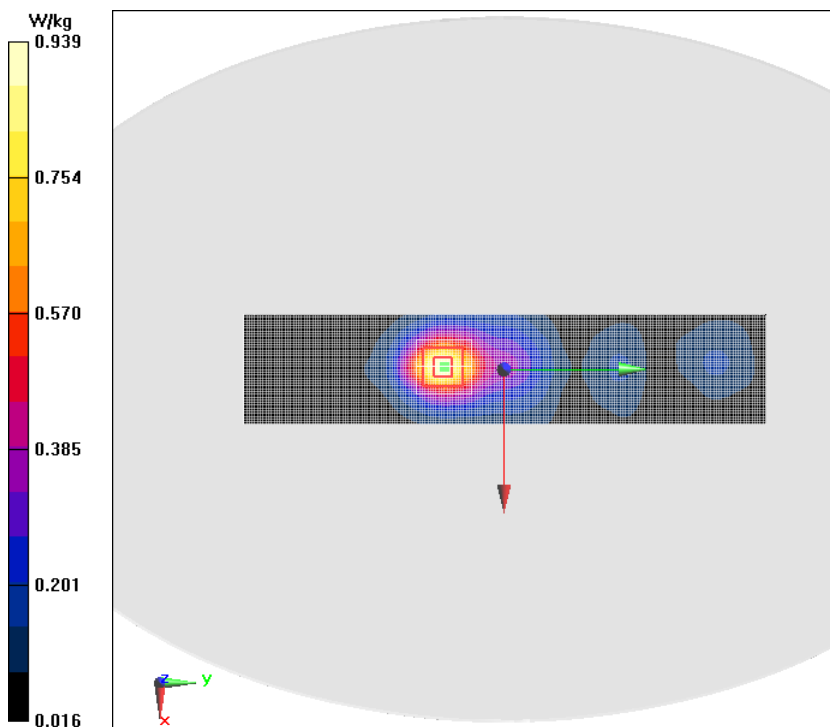

Fig.28 LTE Band 7 20MHz 50RB 0offset Top Mode High 14mm

LTE Band 7 20MHz 1RB 0offset Top Mode High 14mm repeated

Date/Time: 2017/6/5

Electronics: DAE4 Sn1244

Medium: Body 2600MHz

Medium parameters used (interpolated): $f = 2560$ MHz; $\sigma = 2.044$ S/m; $\epsilon_r = 53.474$; $\rho = 1000$ kg/m³

Ambient Temperature: 22°C Liquid Temperature: 22°C

Communication System: LTE Band 7 Professional 2600MHz; Frequency: 2560 MHz; Duty Cycle: 1:1

Probe: EX3DV4 - SN3754ConvF(7.15, 7.15, 7.15); Calibrated: 1/13/2017

LTE Band 7 20MHz 1RB 0offset Top Mode High 14mm repeated/Area Scan (41x191x1):

Measurement grid: dx=10 mm, dy=10 mm

Maximum value of SAR (Measurement) = 1.15 W/kg

LTE Band 7 20MHz 1RB 0offset Top Mode High 14mm repeated/Zoom Scan (7x7x7)/Cube 0:

Measurement grid: dx=5mm, dy=5mm, dz=5mm

Reference Value = 14.73 V/m; Power Drift = -0.06 dB

Peak SAR (extrapolated) = 1.79 W/kg

SAR(1 g) = 1.03 W/kg; SAR(10 g) = 0.553 W/kg

Maximum value of SAR (measured) = 1.14 W/kg

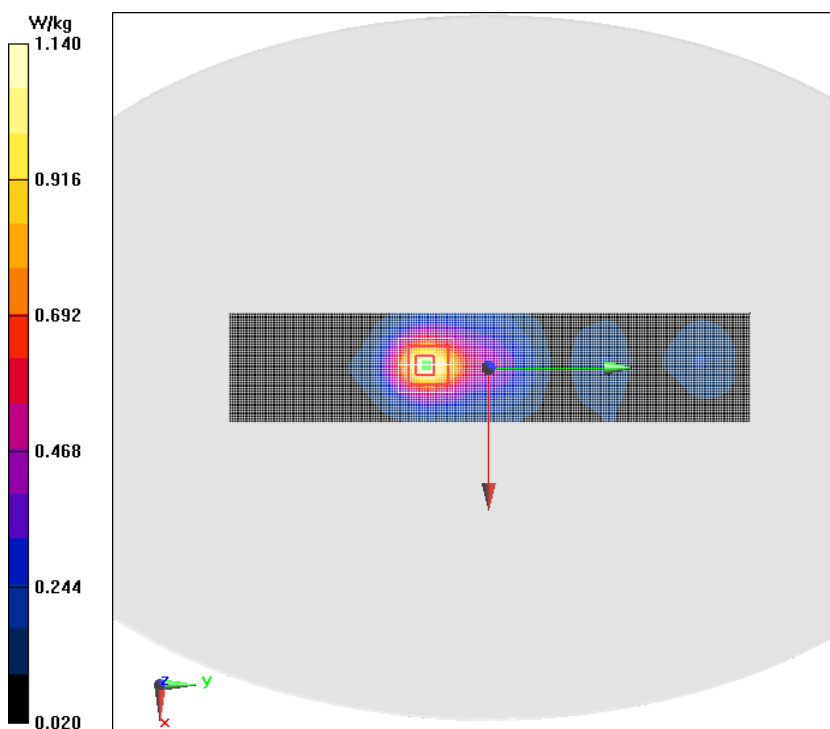

Fig.29 LTE Band 7 20MHz 1RB 0offset Top Mode High 14mm repeated

LTE Band 7 20MHz 1RB 0offset Ground Mode Middle 0mm

Date/Time: 2017/6/5

Electronics: DAE4 Sn1244

Medium: Body 2600MHz

Medium parameters used: $f = 2535 \text{ MHz}$; $\sigma = 2.004 \text{ S/m}$; $\epsilon_r = 53.723$; $\rho = 1000 \text{ kg/m}^3$

Ambient Temperature: 22°C Liquid Temperature: 22°C

Communication System: LTE Band 7 Professional 2600MHz; Frequency: 2535 MHz; Duty Cycle: 1:1

Probe: EX3DV4 - SN3754ConvF(7.22, 7.22, 7.22); Calibrated: 1/13/2017

LTE Band 7 20MHz 1RB 0offset Ground Mode Middle 0mm/Area Scan (151x201x1):

Measurement grid: $dx=10 \text{ mm}$, $dy=10 \text{ mm}$

Maximum value of SAR (Measurement) = 0.469 W/kg

LTE Band 7 20MHz 1RB 0offset Ground Mode Middle 0mm/Zoom Scan (7x7x7)/Cube 0:

Measurement grid: $dx=5\text{mm}$, $dy=5\text{mm}$, $dz=5\text{mm}$

Reference Value = 0.5960 V/m; Power Drift = 0.02 dB

Peak SAR (extrapolated) = 1.16 W/kg

SAR(1 g) = 0.480 W/kg; SAR(10 g) = 0.187 W/kg

Maximum value of SAR (measured) = 0.498 W/kg

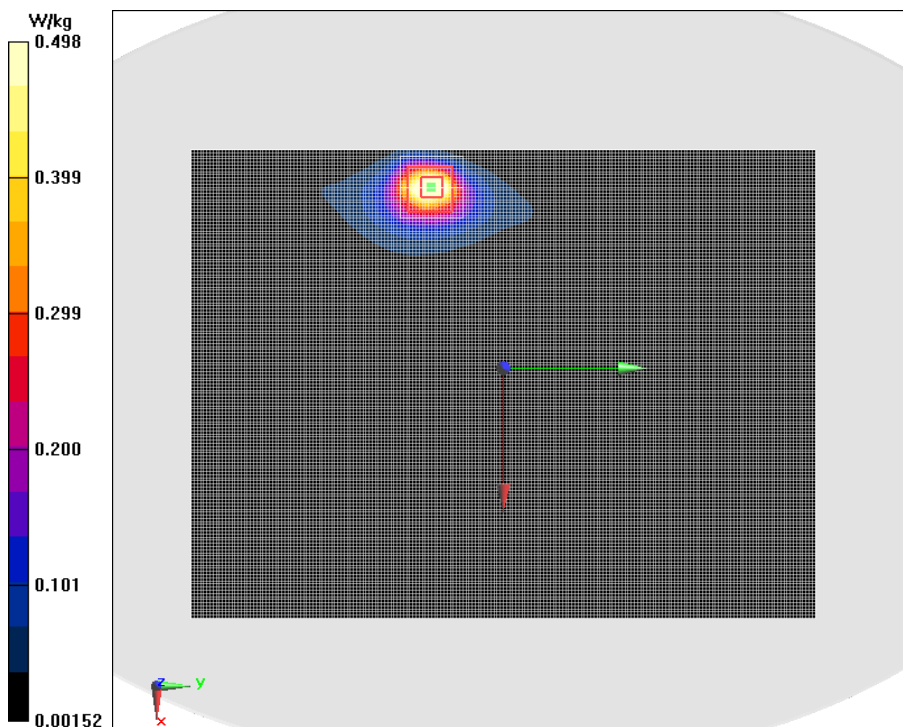

Fig.30 LTE Band 7 20MHz 1RB 0offset Ground Mode Middle 0mm

LTE Band 7 20MHz 50RB 0offset Top Mode High 0mm

Date/Time: 2017/6/5

Electronics: DAE4 Sn1244

Medium: Body 2600MHz

Medium parameters used (interpolated): $f = 2560$ MHz; $\sigma = 2.044$ S/m; $\epsilon_r = 53.474$; $\rho = 1000$ kg/m³

Ambient Temperature:22°C Liquid Temperature:22°C

Communication System: LTE Band 7 Professional 2600MHz; Frequency: 2560 MHz; Duty Cycle: 1:1

Probe: EX3DV4 - SN3754ConvF(7.15, 7.15, 7.15); Calibrated: 1/13/2017

LTE Band 7 20MHz 50RB 0offset Top Mode High 0mm/Area Scan (41x191x1):

Measurement grid: dx=10 mm, dy=10 mm

Maximum value of SAR (Measurement) = 0.838 W/kg

LTE Band 7 20MHz 50RB 0offset Top Mode High 0mm/Zoom Scan (7x7x7)/Cube 0:

Measurement grid: dx=5mm, dy=5mm, dz=5mm

Reference Value = 4.663 V/m; Power Drift = -0.17 dB

Peak SAR (extrapolated) = 1.85 W/kg

SAR(1 g) = 0.847 W/kg; SAR(10 g) = 0.338 W/kg

Maximum value of SAR (measured) = 1.03 W/kg

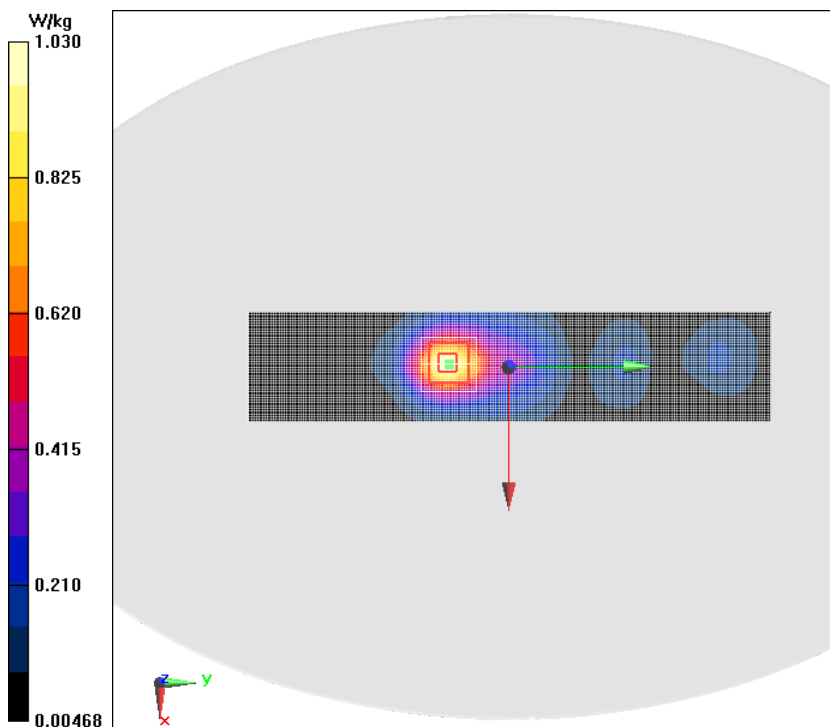

Fig.31 LTE Band 7 20MHz 50RB 0offset Top Mode High 0mm

LTE Band 7 20MHz 50RB 0offset Top Mode High 0mm repeated

Date/Time: 2017/6/5

Electronics: DAE4 Sn1244

Medium: Body 2600MHz

Medium parameters used (interpolated): $f = 2560$ MHz; $\sigma = 2.044$ S/m; $\epsilon_r = 53.474$; $\rho = 1000$ kg/m³

Ambient Temperature:22°C Liquid Temperature:22°C

Communication System: LTE Band 7 Professional 2600MHz; Frequency: 2560 MHz; Duty Cycle: 1:1

Probe: EX3DV4 - SN3754ConvF(7.15, 7.15, 7.15); Calibrated: 1/13/2017

LTE Band 7 20MHz 50RB 0offset Top Mode High 0mm repeated/Area Scan (41x191x1):

Measurement grid: dx=10 mm, dy=10 mm

Maximum value of SAR (Measurement) = 0.817 W/kg

LTE Band 7 20MHz 50RB 0offset Top Mode High 0mm repeated/Zoom Scan (7x7x7)/Cube 0:

Measurement grid: dx=5mm, dy=5mm, dz=5mm

Reference Value = 4.578 V/m; Power Drift = -0.11 dB

Peak SAR (extrapolated) = 1.87 W/kg

SAR(1 g) = 0.850 W/kg; SAR(10 g) = 0.339 W/kg

Maximum value of SAR (measured) = 1.03 W/kg

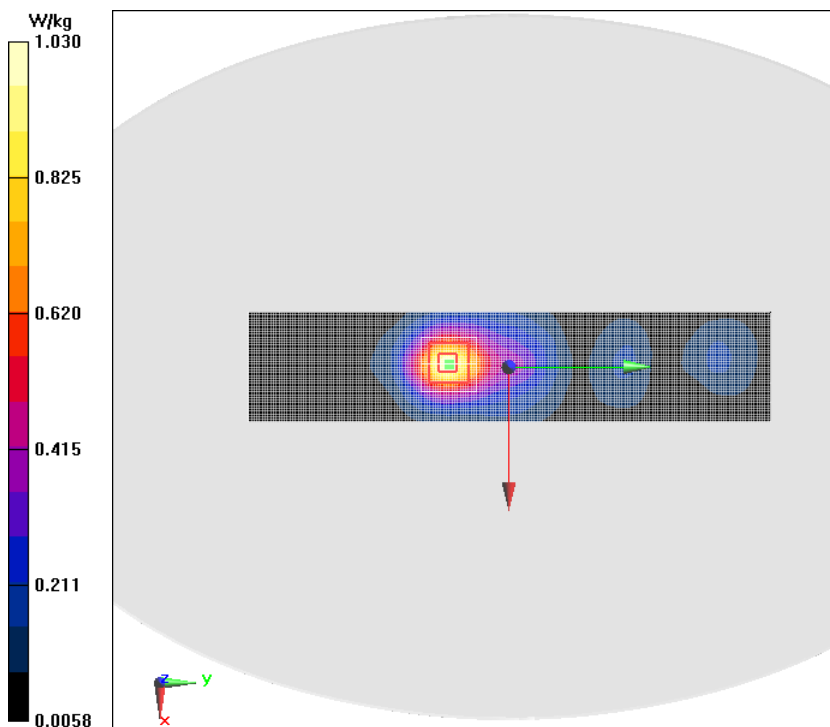

Fig.32 LTE Band 7 20MHz 50RB 0offset Top Mode High 0mm repeated

ANNEX B. SYSTEM VALIDATION RESULTS

835MHz

Date/Time: 2017/4/28

Electronics: DAE4 Sn1244

Medium: Body 835MHz

Medium parameters used: $f = 835 \text{ MHz}$; $\sigma = 0.996 \text{ S/m}$; $\epsilon_r = 55.15$; $\rho = 1000 \text{ kg/m}^3$

Ambient Temperature: 22°C Liquid Temperature: 22°C

Communication System: CW 850MHz; Frequency: 835 MHz; Duty Cycle: 1:1

Probe: EX3DV4 - SN3754ConvF(9.66, 9.66, 9.66); Calibrated: 1/13/2017

System Validation/Area Scan (61x131x1):

Measurement grid: $dx=10 \text{ mm}$, $dy=10 \text{ mm}$

Maximum value of SAR (Measurement) = 2.96 W/kg

System Validation/Zoom Scan (7x7x7) /Cube 0:

Measurement grid: $dx=5\text{mm}$, $dy=5\text{mm}$, $dz=5\text{mm}$

Reference Value = 55.69 V/m; Power Drift = -0.01 dB

Peak SAR (extrapolated) = 3.45 W/kg

SAR(1 g) = 2.39 W/kg; SAR(10 g) = 1.59 W/kg

Maximum value of SAR (measured) = 2.98 W/kg

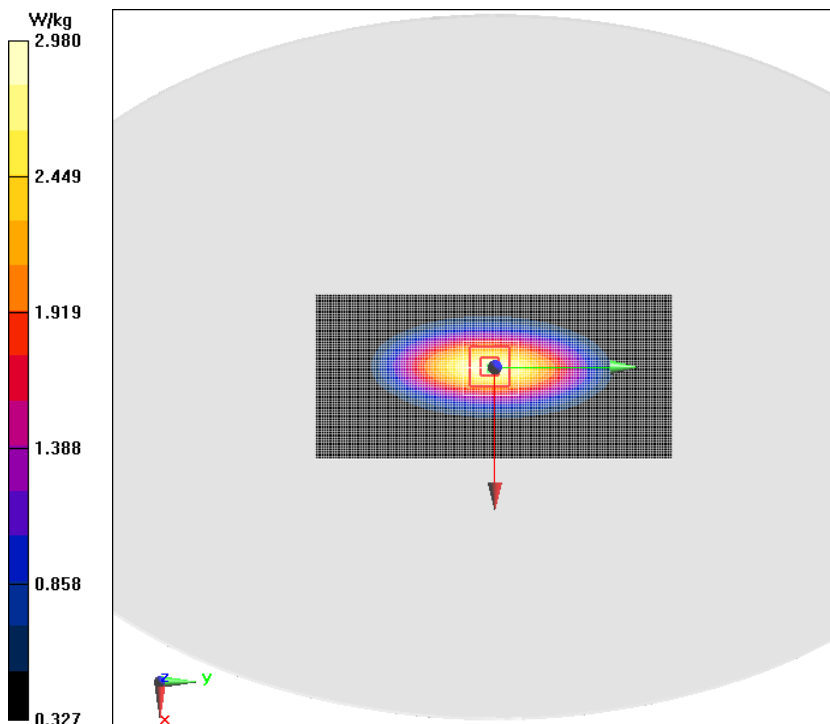

1750MHz

Date/Time: 2017/4/29

Electronics: DAE4 Sn1244

Medium: Body 1800MHz

Medium parameters used (extrapolated): $f = 1750$ MHz; $\sigma = 1.44$ S/m; $\epsilon_r = 52.294$; $\rho = 1000$ kg/m³

Ambient Temperature:22°C Liquid Temperature:22°C

Communication System: 1900MHz; Frequency: 1750 MHz; Duty Cycle: 1:1

Probe: EX3DV4 - SN3754ConvF(7.8, 7.8, 7.8); Calibrated: 1/13/2017

System Validation/Area Scan (81x81x1):

Measurement grid: dx=10 mm, dy=10 mm

Maximum value of SAR (Measurement) = 12.0 W/kg

System Validation/Zoom Scan (7x7x7)/Cube 0:

Measurement grid: dx=5mm, dy=5mm, dz=5mm

Reference Value = 91.91 V/m; Power Drift = 0.04 dB

Peak SAR (extrapolated) = 18.4 W/kg

SAR(1 g) = 9.57 W/kg; SAR(10 g) = 5.18 W/kg

Maximum value of SAR (measured) = 11.7 W/kg

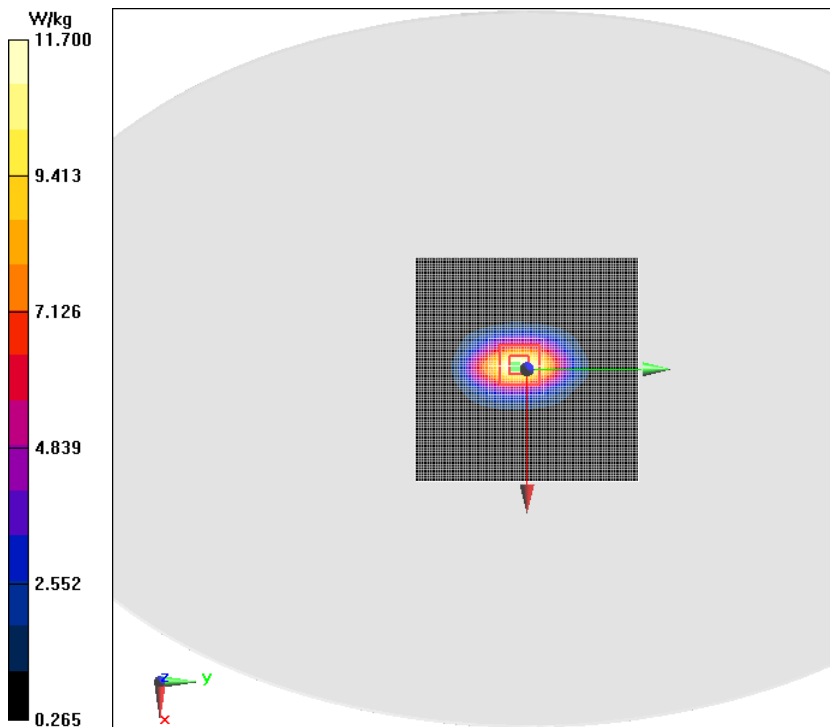

1900MHz

Date/Time: 2017/4/27

Electronics: DAE4 Sn1244

Medium: Body 1900MHz

Medium parameters used: $f = 1900$ MHz; $\sigma = 1.571$ S/m; $\epsilon_r = 54.586$; $\rho = 1000$ kg/m³

Ambient Temperature: 22°C Liquid Temperature: 22°C

Communication System: CW 1900MHz; Frequency: 1900 MHz; Duty Cycle: 1:1

Probe: EX3DV4 - SN3754ConvF(7.6, 7.6, 7.6); Calibrated: 1/13/2017

System Validation/Area Scan (61x61x1):

Measurement grid: $dx=10$ mm, $dy=10$ mm

Maximum value of SAR (Measurement) = 16.0 W/kg

System Validation/Zoom Scan (7x7x7) /Cube 0:

Measurement grid: $dx=5$ mm, $dy=5$ mm, $dz=5$ mm

Reference Value = 103.3 V/m; Power Drift = -0.10 dB

Peak SAR (extrapolated) = 20.6 W/kg

SAR(1 g) = 10.6 W/kg; SAR(10 g) = 5.48 W/kg

Maximum value of SAR (measured) = 16.1 W/kg

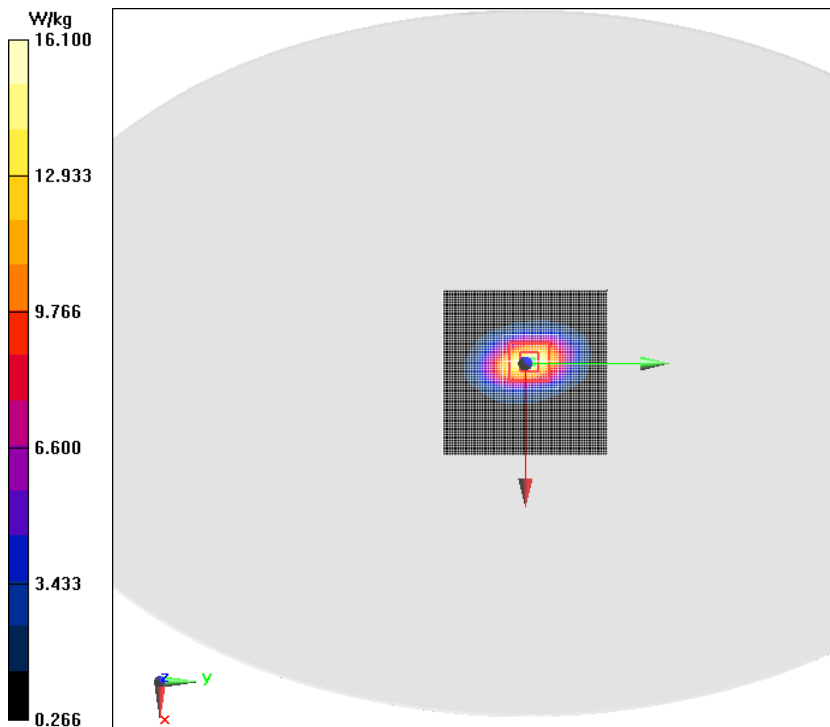

2450MHz

Date/Time: 2017/5/23

Electronics: DAE4 Sn1244

Medium: Body 2450MHz

Medium parameters used: $f = 2450$ MHz; $\sigma = 1.976$ S/m; $\epsilon_r = 52.926$; $\rho = 1000$ kg/m³

Ambient Temperature: 22°C Liquid Temperature: 22°C

Communication System: CW 2450MHz; Frequency: 2450 MHz; Duty Cycle: 1:1

Probe: EX3DV4 - SN3754ConvF(7.22, 7.22, 7.22); Calibrated: 1/13/2017

System Validation/Area Scan (111x111x1):

Measurement grid: $dx=10$ mm, $dy=10$ mm

Maximum value of SAR (Measurement) = 21.8 W/kg

System Validation/Zoom Scan (7x7x7) /Cube 0:

Measurement grid: $dx=5$ mm, $dy=5$ mm, $dz=5$ mm

Reference Value = 109.4 V/m; Power Drift = -0.02 dB

Peak SAR (extrapolated) = 29.0 W/kg

SAR(1 g) = 13.9 W/kg; SAR(10 g) = 6.34 W/kg

Maximum value of SAR (measured) = 21.5 W/kg

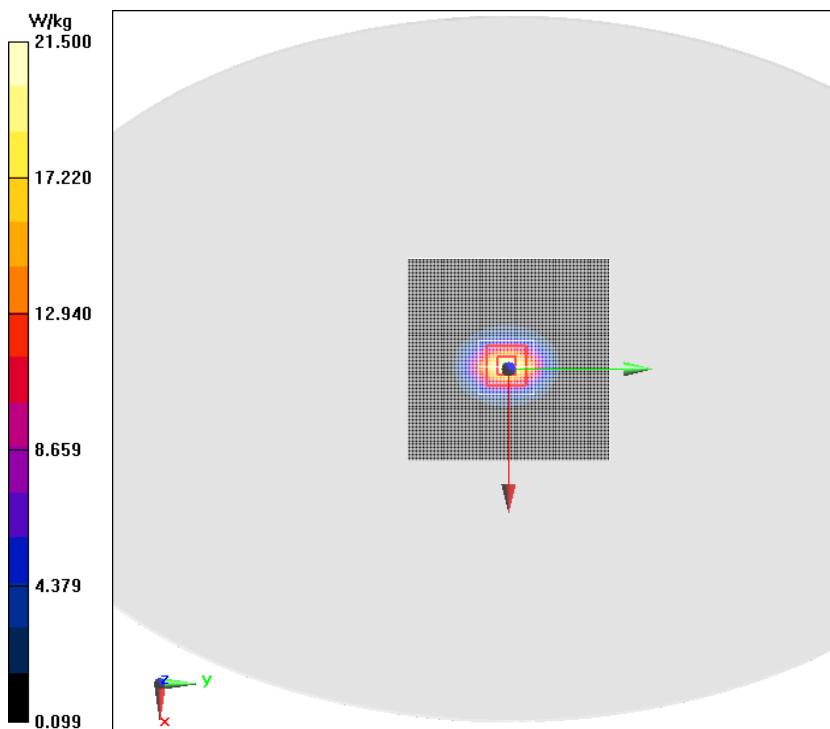

2600MHz

Date/Time: 2017/6/5

Electronics: DAE4 Sn1244

Medium: Body 2600MHz

Medium parameters used: $f = 2600$ MHz; $\sigma = 2.136$ S/m; $\epsilon_r = 52.686$; $\rho = 1000$ kg/m³

Ambient Temperature: 22°C Liquid Temperature: 22°C

Communication System: CW 2600MHz; Frequency: 2600 MHz; Duty Cycle: 1:1

Probe: EX3DV4 - SN3754ConvF(7.15, 7.15, 7.15); Calibrated: 1/13/2017

System Validation/Area Scan (71x81x1):

Measurement grid: $dx=10$ mm, $dy=10$ mm

Maximum value of SAR (Measurement) = 23.3 W/kg

System Validation/Zoom Scan (7x7x7)/Cube 0:

Measurement grid: $dx=5$ mm, $dy=5$ mm, $dz=5$ mm

Reference Value = 88.14 V/m; Power Drift = -0.13 dB

Peak SAR (extrapolated) = 29.9 W/kg

SAR(1 g) = 13.9 W/kg; SAR(10 g) = 6.08 W/kg

Maximum value of SAR (measured) = 21.6 W/kg

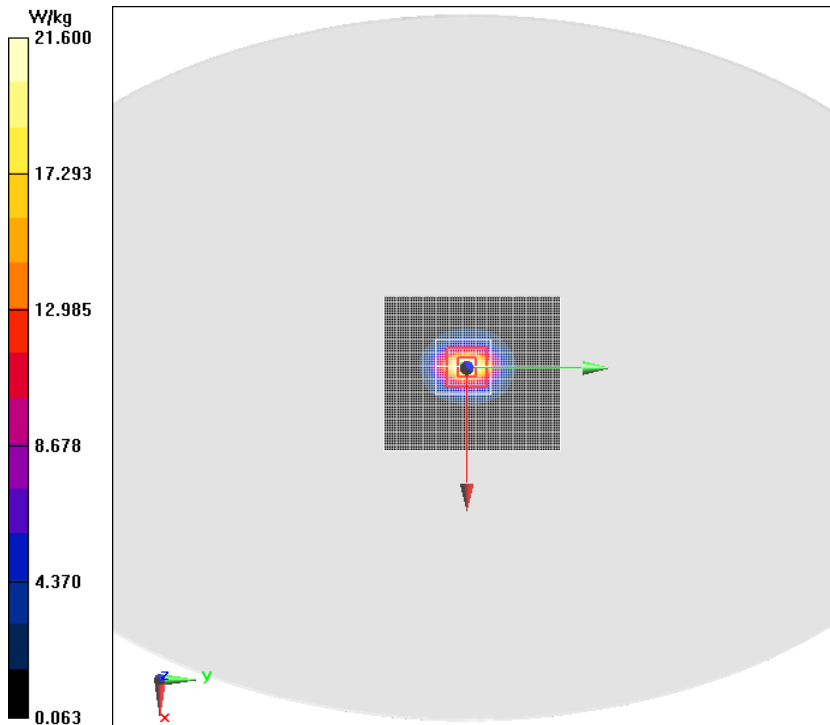

ANNEX C. SAR Measurement Setup

C.1. Measurement Set-up

The DASY5 system for performing compliance tests is illustrated above graphically. This system consists of the following items:

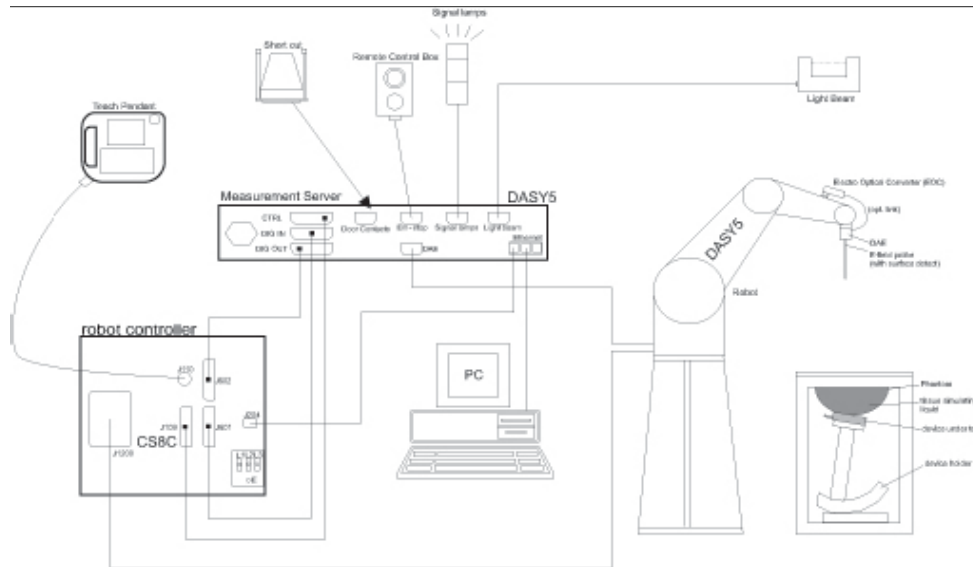

Picture C.1 SAR Lab Test Measurement Set-up

- A standard high precision 6-axis robot (Stäubli TX=RX family) with controller, teach pendant and software. An arm extension for accommodating the data acquisition electronics (DAE).
- An isotropic field probe optimized and calibrated for the targeted measurement.
- A data acquisition electronics (DAE) which performs the signal amplification, signal multiplexing, AD-conversion, offset measurements, mechanical surface detection, collision detection, etc. The unit is battery powered with standard or rechargeable batteries. The signal is optically transmitted to the EOC.
- The Electro-optical converter (EOC) performs the conversion from optical to electrical signals for the digital communication to the DAE. To use optical surface detection, a special version of the EOC is required. The EOC signal is transmitted to the measurement server.
- The function of the measurement server is to perform the time critical tasks such as signal filtering, control of the robot operation and fast movement interrupts.
- The Light Beam used is for probe alignment. This improves the (absolute) accuracy of the probe positioning.
- A computer running WinXP and the DASY5 software.
- Remote control and teach pendant as well as additional circuitry for robot safety such as
- warning lamps, etc.

- The phantom, the device holder and other accessories according to the targeted measurement.

C.2. DASY5 E-field Probe System

The SAR measurements were conducted with the dosimetric probe designed in the classical triangular configuration and optimized for dosimetric evaluation. The probe is constructed using the thick film technique; with printed resistive lines on ceramic substrates. The probe is equipped with an optical multifiber line ending at the front of the probe tip. It is connected to the EOC box on the robot arm and provides an automatic detection of the phantom surface. Half of the fibers are connected to a pulsed infrared transmitter, the other half to a synchronized receiver. As the probe approaches the surface, the reflection from the surface produces a coupling from the transmitting to the receiving fibers. This reflection increases first during the approach, reaches maximum and then decreases. If the probe is flatly touching the surface, the coupling is zero. The distance of the coupling maximum to the surface is independent of the surface reflectivity and largely independent of the surface to probe angle. The DASY5 software reads the reflection during a software approach and looks for the maximum using 2nd order curve fitting. The approach is stopped at reaching the maximum.

Probe Specifications:

- Model:** ES3DV3, EX3DV4
- Frequency**
- Range:** 700MHz — 2.6GHz(ES3DV3)
- Calibration:** In head and body simulating tissue at
Frequencies from 835 up to 2450MHz
- Linearity:**
 ± 0.2 dB(700MHz — 2.0GHz) for ES3DV3
- Dynamic Range:** 10 mW/kg — 100W/kg
- Probe Length:** 330 mm
- Probe Tip**
- Length:** 20 mm
- Body Diameter:** 12 mm
- Tip Diameter:** 2.5 mm (3.9 mm for ES3DV3)
- Tip-Center:** 1 mm (2.0mm for ES3DV3)
- Application:**SAR Dosimetry Testing
- Compliance tests of mobile phones**
- Dosimetry in strong gradient fields**



Picture C.2 Near-field Probe



Picture C.3 E-field Probe

C.3. E-field Probe Calibration

Each E-Probe/Probe Amplifier combination has unique calibration parameters. A TEM cell calibration procedure is conducted to determine the proper amplifier settings to enter in the probe parameters. The amplifier settings are determined for a given frequency by subjecting the probe to a known E-field density (1 mW/cm^2) using an RF Signal generator, TEM cell, and RF Power Meter.

The free space E-field from amplified probe outputs is determined in a test chamber. This calibration can be performed in a TEM cell if the frequency is below 1 GHz and in a waveguide or other methodologies above 1 GHz for free space. For the free space calibration, the probe is placed in the volumetric center of the cavity and at the proper orientation with the field. The probe is then rotated 360 degrees until the three channels show the maximum reading. The power density readings equate to 1 mW/cm^2 .

E-field temperature correlation calibration is performed in a flat phantom filled with the appropriate simulated brain tissue. The E-field in the medium correlates with the temperature rise in the dielectric medium. For temperature correlation calibration a RF transparent thermistor-based temperature probe is used in conjunction with the E-field probe.

$$SAR = C \frac{\Delta T}{\Delta t}$$

Where:

Δt = Exposure time (30 seconds),

C = Heat capacity of tissue (brain or muscle),

ΔT = Temperature increase due to RF exposure.

$$SAR = \frac{|E|^2 \cdot \sigma}{\rho}$$

Where:

σ = Simulated tissue conductivity,

ρ = Tissue density (kg/m^3).

C.4. Other Test Equipment

C.4.1. Data Acquisition Electronics(DAE)

The data acquisition electronics consist of a highly sensitive electrometer-grade preamplifier with auto-zeroing, a channel and gain-switching multiplexer, a fast 16 bit AD-converter and a command decoder with a control logic unit. Transmission to the measurement server is accomplished through an optical downlink for data and status information, as well as an optical uplink for commands and the clock.

The mechanical probe mounting device includes two different sensor systems for frontal and

sideways probe contacts. They are used for mechanical surface detection and probe collision detection.

The input impedance of the DAE is 200 MOhm; the inputs are symmetrical and floating. Common mode rejection is above 80 dB.



PictureC.4: DAE

C.4.2. Robot

The SPEAG DASY system uses the high precision robots (DASY5: RX90L) type from Stäubli SA (France). For the 6-axis controller system, the robot controller version from Stäubli is used. The Stäubli robot series have many features that are important for our application:

- High precision (repeatability 0.02mm)
- High reliability (industrial design)
- Low maintenance costs (virtually maintenance free due to direct drive gears; no belt drives)
- Jerk-free straight movements (brushless synchron motors; no stepper motors)
- Low ELF interference (motor control fields shielded via the closed metallic construction shields)



Picture C.5 DASY 5

C.4.3. Measurement Server

The Measurement server is based on a PC/104 CPU board with CPU (DASY5: 400 MHz, Intel Celeron), chipdisk (DASY5: 128MB), RAM (DASY5: 128MB). The necessary circuits for communication with the DAE electronic box, as well as the 16 bit AD converter system for optical detection and digital I/O interface are contained on the DASY I/O board, which is directly connected to the PC/104 bus of the CPU board.

The measurement server performs all real-time data evaluation of field measurements and surface

detection, controls robot movements and handles safety operation. The PC operating system cannot interfere with these time critical processes. All connections are supervised by a watchdog, and disconnection of any of the cables to the measurement server will automatically disarm the robot and disable all program-controlled robot movements. Furthermore, the measurement server is equipped with an expansion port which is reserved for future applications. Please note that this expansion port does not have a standardized pinout, and therefore only devices provided by SPEAG can be connected. Devices from any other supplier could seriously damage the measurement server.



Picture C.6 Server for DASY 5

C.4.4. Device Holder for Phantom

The SAR in the phantom is approximately inversely proportional to the square of the distance between the source and the liquid surface. For a source at 5mm distance, a positioning uncertainty of $\pm 0.5\text{mm}$ would produce a SAR uncertainty of $\pm 20\%$. Accurate device positioning is therefore crucial for accurate and repeatable measurements. The positions in which the devices must be measured are defined by the standards.

The DASY device holder is designed to cope with the different positions given in the standard. It has two scales for device rotation (with respect to the body axis) and device inclination (with respect to the line between the ear reference points). The rotation centers for both scales is the ear reference point (ERP). Thus the device needs no repositioning when changing the angles.

The DASY device holder is constructed of low-loss POM material having the following dielectric parameters: relative permittivity $\epsilon = 3$ and loss tangent $\delta = 0.02$. The amount of dielectric material has been reduced in the closest vicinity of the device, since measurements have suggested that the influence of the clamp on the test results could thus be lowered.

<Laptop Extension Kit>

The extension is lightweight and made of POM, acrylic glass and foam. It fits easily on the upper part of the Mounting Device in place of the phone positioner. The extension is fully compatible with the Twin-SAM and ELI phantoms.



Picture C.7: Device Holder

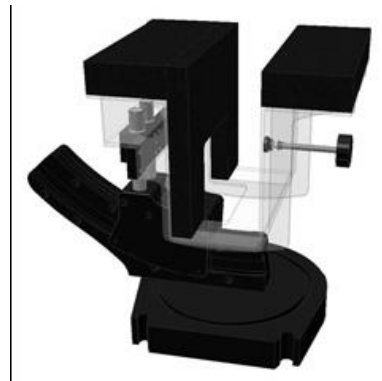

Picture C.8: Laptop Extension Kit

C.4.5. Phantom

The SAM Twin Phantom V4.0 is constructed of a fiberglass shell integrated in a table. The shape of the shell is based on data from an anatomical study designed to represent the 90th percentile of the population. The phantom enables the dissymmetric evaluation of SAR for both left and right handed handset usage, as well as body-worn usage using the flat phantom region. Reference markings on the Phantom allow the complete setup of all predefined phantom positions and measurement grids by manually teaching three points in the robot. The shell phantom has a 2mm shell thickness (except the ear region where shell thickness increases to 6 mm).

Shell Thickness: 2 ± 0.2 mm

Filling Volume: Approx. 25 liters

Dimensions: 810 x 1000 x 500 mm (H x L x W)

Available: Special



Picture C.9: SAM Twin Phantom

ANNEX D. Position of the wireless device in relation to the phantom

D.1. General considerations

This standard specifies two handset test positions against the head phantom – the “cheek” position and the “tilt” position.

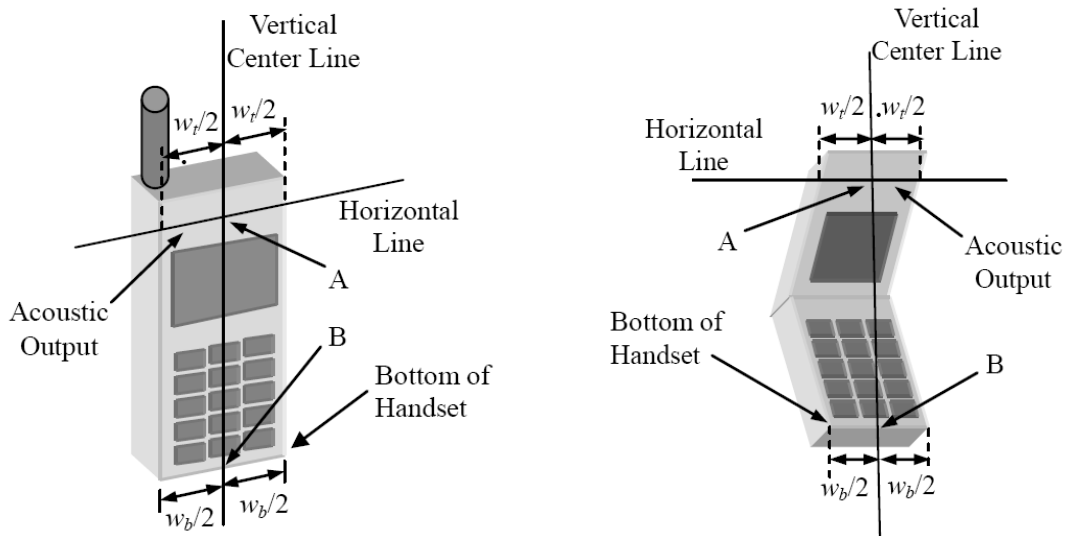

- w_t Width of the handset at the level of the acoustic
- w_b Width of the bottom of the handset
- A Midpoint of the width w_t of the handset at the level of the acoustic output
- B Midpoint of the width w_b of the bottom of the handset

Picture D.1-a Typical “fixed” case handset Picture D.1-b Typical “clam-shell” case handset

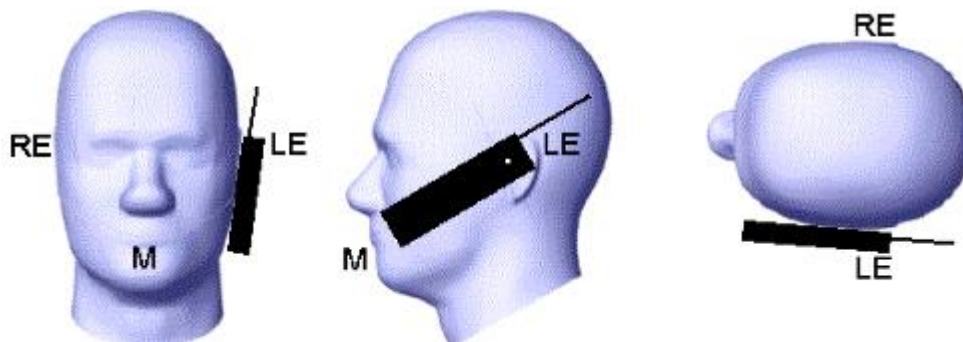

Picture D.2 Cheek position of the wireless device on the left side of SAM

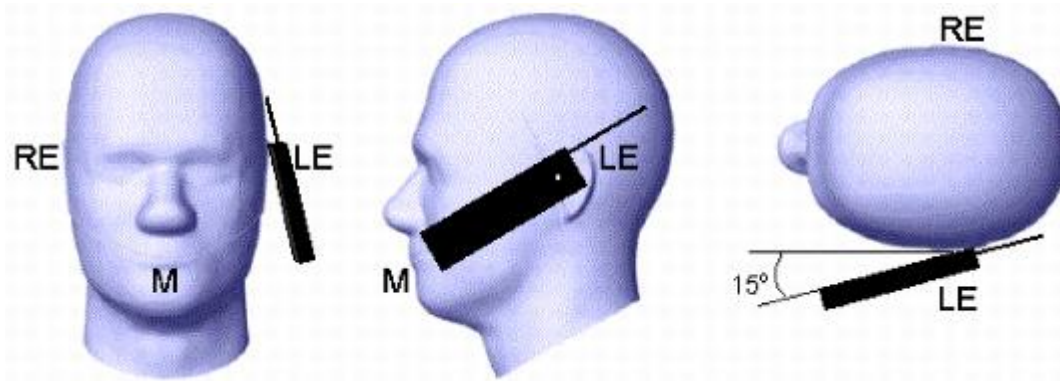

Picture D.3 Tilt position of the wireless device on the left side of SAM

D.2. Body-worn device

A typical example of a body-worn device is a mobile phone, wireless enabled PDA or other battery operated wireless device with the ability to transmit while mounted on a person's body using a carry accessory approved by the wireless device manufacturer.

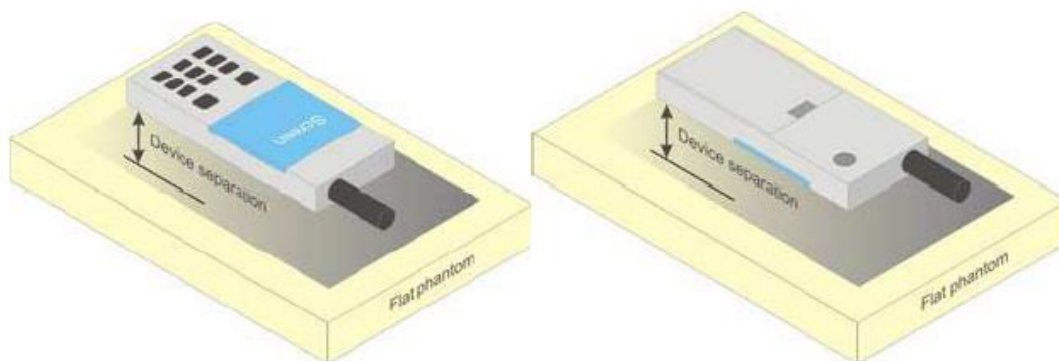

Picture D.4 Test positions for body-worn devices

D.3. Desktop device

A typical example of a desktop device is a wireless enabled desktop computer placed on a table or desk when used.

The DUT shall be positioned at the distance and in the orientation to the phantom that corresponds to the intended use as specified by the manufacturer in the user instructions. For devices that employ an external antenna with variable positions, tests shall be performed for all antenna positions specified. Picture 8.5 show positions for desktop device SAR tests. If the intended use is not specified, the device shall be tested directly against the flat phantom.

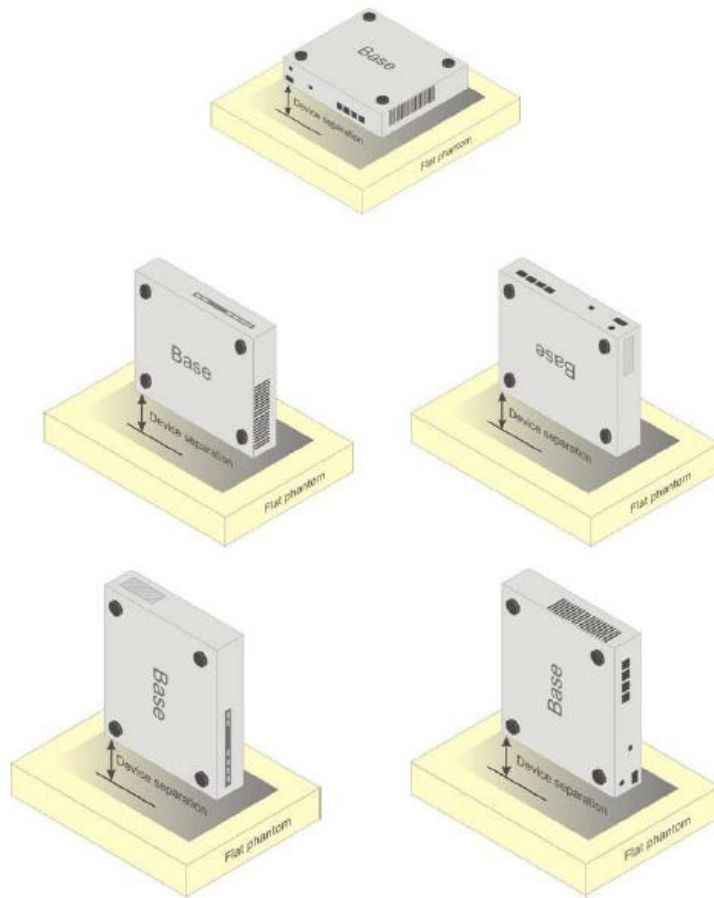

Picture D.5 Test positions for desktop devices

D.4. DUT Setup Photos

Picture D.6 DSY5 system Set-up

Note:

The photos of test sample and test positions show in additional document.

ANNEX E. Equivalent Media Recipes

The liquid used for the frequency range of 800-3000 MHz consisted of water, sugar, salt, preventol, glycol monobutyl and Cellulose. The liquid has been previously proven to be suited for worst-case. The Table E.1 shows the detail solution. It's satisfying the latest tissue dielectric parameters requirements proposed by the IEEE 1528 and IEC 62209.

Table E.1: Composition of the Tissue Equivalent Matter

| Frequency (MHz) | 835 Head | 835 Body | 1900 Head | 1900 Body | 2450 Head | 2450 Body |
|--|----------------------------------|----------------------------------|----------------------------------|----------------------------------|----------------------------------|----------------------------------|
| Ingredients (% by weight) | | | | | | |
| Water | 41.45 | 52.5 | 55.242 | 69.91 | 58.79 | 72.60 |
| Sugar | 56.0 | 45.0 | \ | \ | \ | \ |
| Salt | 1.45 | 1.4 | 0.306 | 0.13 | 0.06 | 0.18 |
| Preventol | 0.1 | 0.1 | \ | \ | \ | \ |
| Cellulose | 1.0 | 1.0 | \ | \ | \ | \ |
| Glycol Monobutyl | \ | \ | 44.452 | 29.96 | 41.15 | 27.22 |
| Dielectric Parameters Target Value | $\epsilon=41.5$ $\sigma=0.90$ | $\epsilon=55.2$ $\sigma=0.97$ | $\epsilon=40.0$ $\sigma=1.40$ | $\epsilon=53.3$ $\sigma=1.52$ | $\epsilon=39.2$ $\sigma=1.80$ | $\epsilon=52.7$ $\sigma=1.95$ |

ANNEX F. System Validation

The SAR system must be validated against its performance specifications before it is deployed. When SAR probes, system components or software are changed, upgraded or recalibrated, these must be validated with the SAR system(s) that operates with such components.

Table F.1: System Validation Part 1

| System No. | Probe SN. | Liquid name | Validation date | Frequency point | Permittivity ϵ | Conductivity σ (S/m) |
|------------|-----------|--------------|-----------------|-----------------|-------------------------|-----------------------------|
| 1 | 3754 | Body 835MHz | April 28, 2017 | 835MHz | 55.15 | 0.996 |
| 2 | 3754 | Body 1750MHz | April 29, 2017 | 1750MHz | 52.013 | 1.496 |
| 3 | 3754 | Body 1900MHz | April 27, 2017 | 1900MHz | 54.586 | 1.571 |
| 4 | 3754 | Body 2450MHz | May 23, 2017 | 2450MHz | 52.926 | 1.976 |
| 5 | 3754 | Body 2600MHz | June 5, 2017 | 2600MHz | 52.686 | 2.136 |

Table F.2: System Validation Part 2

| | | | |
|----------------|-----------------|------|------|
| CW Validation | Sensitivity | PASS | PASS |
| | Probe linearity | PASS | PASS |
| | Probe Isotropy | PASS | PASS |
| Mod Validation | MOD.type | GMSK | GMSK |
| | MOD.type | OFDM | OFDM |
| | Duty factor | PASS | PASS |
| | PAR | PASS | PASS |

ANNEX G. Probe and DAE Calibration Certificate

Schmid & Partner Engineering AG

Zeughausstrasse 43, 8004 Zurich, Switzerland
Phone +41 44 245 9700, Fax +41 44 245 9779
info@speag.com, http://www.speag.com

s p e a g

1244

IMPORTANT NOTICE

USAGE OF THE DAE 4

The DAE unit is a delicate, high precision instrument and requires careful treatment by the user. There are no serviceable parts inside the DAE. Special attention shall be given to the following points:

Battery Exchange: The battery cover of the DAE4 unit is closed using a screw, over tightening the screw may cause the threads inside the DAE to wear out.

Shipping of the DAE: Before shipping the DAE to SPEAG for calibration, remove the batteries and pack the DAE in an antistatic bag. This antistatic bag shall then be packed into a larger box or container which protects the DAE from impacts during transportation. The package shall be marked to indicate that a fragile instrument is inside.

E-Stop Failures: Touch detection may be malfunctioning due to broken magnets in the E-stop. Rough handling of the E-stop may lead to damage of these magnets. Touch and collision errors are often caused by dust and dirt accumulated in the E-stop. To prevent E-stop failure, the customer shall always mount the probe to the DAE carefully and keep the DAE unit in a non-dusty environment if not used for measurements.

Repair: Minor repairs are performed at no extra cost during the annual calibration. However, SPEAG reserves the right to charge for any repair especially if rough unprofessional handling caused the defect.

DASY Configuration Files: Since the exact values of the DAE input resistances, as measured during the calibration procedure of a DAE unit, are not used by the DASY software, a nominal value of 200 MOhm is given in the corresponding configuration file.

Important Note:

Warranty and calibration is void if the DAE unit is disassembled partly or fully by the Customer.

Important Note:

Never attempt to grease or oil the E-stop assembly. Cleaning and readjusting of the E-stop assembly is allowed by certified SPEAG personnel only and is part of the annual calibration procedure.

Important Note:

To prevent damage of the DAE probe connector pins, use great care when installing the probe to the DAE. Carefully connect the probe with the connector notch oriented in the mating position. Avoid any rotational movement of the probe body versus the DAE while turning the locking nut of the connector. The same care shall be used when disconnecting the probe from the DAE.

Schmid & Partner Engineering

TN_BR040315AD DAE4.doc

11.12.2009

**Calibration Laboratory of
Schmid & Partner
Engineering AG**
Zeughausstrasse 43, 8004 Zurich, Switzerland



S Schweizerischer Kalibrierdienst
C Service suisse d'étalonnage
S Servizio svizzero di taratura
S Swiss Calibration Service

Accredited by the Swiss Accreditation Service (SAS)
The Swiss Accreditation Service is one of the signatories to the EA
Multilateral Agreement for the recognition of calibration certificates

Accreditation No.: **SCS 0108**

Client **TMC - SH (Auden)**

Certificate No: **DAE4-1244_Dec16**

CALIBRATION CERTIFICATE

Object: **DAE4 - SD 000 D04 BM - SN: 1244**

Calibration procedure(s): **QA CAL-06.v29
Calibration procedure for the data acquisition electronics (DAE)**



Calibration date: **December 12, 2016**

This calibration certificate documents the traceability to national standards, which realize the physical units of measurements (SI).
The measurements and the uncertainties with confidence probability are given on the following pages and are part of the certificate.

All calibrations have been conducted in the closed laboratory facility: environment temperature (22 ± 3)°C and humidity < 70%.

Calibration Equipment used (M&TE critical for calibration)

| Primary Standards | ID # | Cal Date (Certificate No.) | Scheduled Calibration |
|-------------------------------|--------------------|----------------------------|------------------------|
| Keithley Multimeter Type 2001 | SN: 0810278 | 09-Sep-16 (No:19065) | Sep-17 |
| Secondary Standards | ID # | Check Date (in house) | Scheduled Check |
| Auto DAE Calibration Unit | SE UWS 053 AA 1001 | 05-Jan-16 (in house check) | In house check: Jan-17 |
| Calibrator Box V2.1 | SE UMS 006 AA 1002 | 05-Jan-16 (in house check) | In house check: Jan-17 |

| | Name | Function | Signature |
|----------------|-------------------|--------------------------|---|
| Calibrated by: | Dominique Steffen | Technician |  |
| Approved by: | Fin Bomholt | Deputy Technical Manager |  |

Issued: December 13, 2016

This calibration certificate shall not be reproduced except in full without written approval of the laboratory.

Calibration Laboratory of
Schmid & Partner
Engineering AG
Zeughausstrasse 43, 8004 Zurich, Switzerland



S Schweizerischer Kalibrierdienst
S Service suisse d'étalonnage
C Servizio svizzero di taratura
S Swiss Calibration Service

Accredited by the Swiss Accreditation Service (SAS)
The Swiss Accreditation Service is one of the signatories to the EA
Multilateral Agreement for the recognition of calibration certificates

Accreditation No.: **SCS 0108**

Glossary

DAE data acquisition electronics
Connector angle information used in DASY system to align probe sensor X to the robot coordinate system.

Methods Applied and Interpretation of Parameters

- **DC Voltage Measurement:** Calibration Factor assessed for use in DASY system by comparison with a calibrated instrument traceable to national standards. The figure given corresponds to the full scale range of the voltmeter in the respective range.
- **Connector angle:** The angle of the connector is assessed measuring the angle mechanically by a tool inserted. Uncertainty is not required.
- The following parameters as documented in the Appendix contain technical information as a result from the performance test and require no uncertainty.
 - **DC Voltage Measurement Linearity:** Verification of the Linearity at +10% and -10% of the nominal calibration voltage. Influence of offset voltage is included in this measurement.
 - **Common mode sensitivity:** Influence of a positive or negative common mode voltage on the differential measurement.
 - **Channel separation:** Influence of a voltage on the neighbor channels not subject to an input voltage.
 - **AD Converter Values with inputs shorted:** Values on the internal AD converter corresponding to zero input voltage
 - **Input Offset Measurement:** Output voltage and statistical results over a large number of zero voltage measurements.
 - **Input Offset Current:** Typical value for information; Maximum channel input offset current, not considering the input resistance.
 - **Input resistance:** Typical value for information; DAE input resistance at the connector, during internal auto-zeroing and during measurement.
 - **Low Battery Alarm Voltage:** Typical value for information. Below this voltage, a battery alarm signal is generated.
 - **Power consumption:** Typical value for information. Supply currents in various operating modes.

DC Voltage Measurement

A/D - Converter Resolution nominal

High Range: 1LSB = 6.1 μ V, full range = -100...+300 mV

Low Range: 1LSB = 61nV, full range = -1.....+3mV

DASY measurement parameters: Auto Zero Time: 3 sec; Measuring time: 3 sec

| Calibration Factors | X | Y | Z |
|---------------------|---------------------------|---------------------------|---------------------------|
| High Range | 403.872 \pm 0.02% (k=2) | 403.613 \pm 0.02% (k=2) | 404.527 \pm 0.02% (k=2) |
| Low Range | 3.95409 \pm 1.50% (k=2) | 3.97148 \pm 1.50% (k=2) | 3.98215 \pm 1.50% (k=2) |

Connector Angle

| | |
|---|-------------------------|
| Connector Angle to be used in DASY system | 22.0 \pm 1 $^{\circ}$ |
|---|-------------------------|

Appendix (Additional assessments outside the scope of SCS0108)

1. DC Voltage Linearity

| High Range | Reading (μV) | Difference (μV) | Error (%) |
|-------------------|---------------------------|------------------------------|-----------|
| Channel X + Input | 199995.09 | -0.83 | -0.00 |
| Channel X + Input | 20004.47 | 2.58 | 0.01 |
| Channel X - Input | -19997.82 | 2.60 | -0.01 |
| Channel Y + Input | 199993.65 | -2.29 | -0.00 |
| Channel Y + Input | 20001.27 | -0.51 | -0.00 |
| Channel Y - Input | -19997.58 | 2.97 | -0.01 |
| Channel Z + Input | 199992.15 | -3.40 | -0.00 |
| Channel Z + Input | 19999.95 | -1.78 | -0.01 |
| Channel Z - Input | -20002.51 | -1.92 | 0.01 |

| Low Range | Reading (μV) | Difference (μV) | Error (%) |
|-------------------|---------------------------|------------------------------|-----------|
| Channel X + Input | 2002.00 | 0.39 | 0.02 |
| Channel X + Input | 202.04 | 0.13 | 0.07 |
| Channel X - Input | -197.82 | 0.13 | -0.06 |
| Channel Y + Input | 2000.90 | -0.59 | -0.03 |
| Channel Y + Input | 202.65 | 0.73 | 0.36 |
| Channel Y - Input | -197.74 | 0.13 | -0.06 |
| Channel Z + Input | 2001.79 | 0.42 | 0.02 |
| Channel Z + Input | 200.75 | -1.05 | -0.52 |
| Channel Z - Input | -199.15 | -1.06 | 0.53 |

2. Common mode sensitivity

DASY measurement parameters: Auto Zero Time: 3 sec; Measuring time: 3 sec

| | Common mode Input Voltage (mV) | High Range Average Reading (μV) | Low Range Average Reading (μV) |
|-----------|--------------------------------|--|---|
| Channel X | 200 | -3.59 | -5.16 |
| | -200 | 6.94 | 5.14 |
| Channel Y | 200 | -3.41 | -3.57 |
| | -200 | 2.60 | 2.96 |
| Channel Z | 200 | -8.21 | -8.18 |
| | -200 | 5.71 | 5.56 |

3. Channel separation

DASY measurement parameters: Auto Zero Time: 3 sec; Measuring time: 3 sec

| | Input Voltage (mV) | Channel X (μV) | Channel Y (μV) | Channel Z (μV) |
|-----------|--------------------|-----------------------------|-----------------------------|-----------------------------|
| Channel X | 200 | - | 1.06 | -4.10 |
| Channel Y | 200 | 7.19 | - | 1.88 |
| Channel Z | 200 | 9.77 | 4.29 | - |

4. AD-Converter Values with inputs shorted

DASY measurement parameters: Auto Zero Time: 3 sec; Measuring time: 3 sec

| | High Range (LSB) | Low Range (LSB) |
|-----------|------------------|-----------------|
| Channel X | 16885 | 16322 |
| Channel Y | 16457 | 16417 |
| Channel Z | 15874 | 17196 |

5. Input Offset Measurement

DASY measurement parameters: Auto Zero Time: 3 sec; Measuring time: 3 sec

Input 10MΩ

| | Average (μV) | min. Offset (μV) | max. Offset (μV) | Std. Deviation (μV) |
|-----------|--------------|------------------|------------------|---------------------|
| Channel X | -0.50 | -1.93 | 1.16 | 0.62 |
| Channel Y | 0.32 | -1.78 | 2.06 | 0.72 |
| Channel Z | -2.19 | -4.30 | -0.47 | 0.66 |

6. Input Offset Current

Nominal Input circuitry offset current on all channels: <25fA

7. Input Resistance (Typical values for information)

| | Zeroing (kOhm) | Measuring (MOhm) |
|-----------|----------------|------------------|
| Channel X | 200 | 200 |
| Channel Y | 200 | 200 |
| Channel Z | 200 | 200 |

8. Low Battery Alarm Voltage (Typical values for information)

| Typical values | Alarm Level (VDC) |
|----------------|-------------------|
| Supply (+ Vcc) | +7.9 |
| Supply (- Vcc) | -7.6 |

9. Power Consumption (Typical values for information)

| Typical values | Switched off (mA) | Stand by (mA) | Transmitting (mA) |
|----------------|-------------------|---------------|-------------------|
| Supply (+ Vcc) | +0.01 | +6 | +14 |
| Supply (- Vcc) | -0.01 | -8 | -9 |



Add: No.51 Xueyuan Road, Haidian District, Beijing, 100191, China
 Tel: +86-10-62304633-2218 Fax: +86-10-62304633-2209
 E-mail: cttl@chinattl.com [Http://www.chinattl.cn](http://www.chinattl.cn)

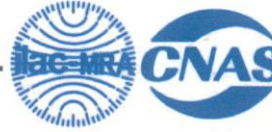

中国认可
 国际互认
 校准
 CALIBRATION
 CNAS L0570

Client **ECIT** Certificate No: **Z17-97010**

CALIBRATION CERTIFICATE

Object: EX3DV4 - SN:3754
 Calibration Procedure(s): FD-Z11-004-01
 Calibration Procedures for Dosimetric E-field Probes
 Calibration date: January 13, 2017

This calibration Certificate documents the traceability to national standards, which realize the physical units of measurements(SI). The measurements and the uncertainties with confidence probability are given on the following pages and are part of the certificate.

All calibrations have been conducted in the closed laboratory facility: environment temperature(22±3)°C and humidity<70%.

Calibration Equipment used (M&TE critical for calibration)

| Primary Standards | ID # | Cal Date(Calibrated by, Certificate No.) | Scheduled Calibration |
|-------------------------|-------------|--|-----------------------|
| Power Meter NRP2 | 101919 | 27-Jun-16 (CTTL, No.J16X04777) | Jun-17 |
| Power sensor NRP-Z91 | 101547 | 27-Jun-16 (CTTL, No.J16X04777) | Jun-17 |
| Power sensor NRP-Z91 | 101548 | 27-Jun-16 (CTTL, No.J16X04777) | Jun-17 |
| Reference10dBAttenuator | 18N50W-10dB | 13-Mar-16(CTTL,No.J16X01547) | Mar-18 |
| Reference20dBAttenuator | 18N50W-20dB | 13-Mar-16(CTTL, No.J16X01548) | Mar-18 |
| Reference Probe EX3DV4 | SN 7433 | 26-Sep-16(SPEAG,No.EX3-7433_Sep16) | Sep-17 |
| DAE4 | SN 1331 | 21-Jan-16(SPEAG, No.DAE4-1331_Jan16) | Jan -17 |
| Secondary Standards | ID # | Cal Date(Calibrated by, Certificate No.) | Scheduled Calibration |
| SignalGeneratorMG3700A | 6201052605 | 27-Jun-16 (CTTL, No.J16X04776) | Jun-17 |
| Network Analyzer E5071C | MY46110673 | 26-Jan-16 (CTTL, No.J16X00894) | Jan -17 |

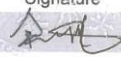
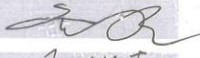
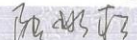
| | Name | Function | Signature |
|----------------|-------------|-----------------------------------|--|
| Calibrated by: | Yu Zongying | SAR Test Engineer |  |
| Reviewed by: | Qi Dianyuan | SAR Project Leader |  |
| Approved by: | Lu Bingsong | Deputy Director of the laboratory |  |

Issued: January 14, 2017

This calibration certificate shall not be reproduced except in full without written approval of the laboratory.



Add: No.51 Xueyuan Road, Haidian District, Beijing, 100191, China
Tel: +86-10-62304633-2218 Fax: +86-10-62304633-2209
E-mail: cttl@chinattl.com [Http://www.chinattl.cn](http://www.chinattl.cn)

Glossary:

| | |
|-----------------------|---|
| TSL | tissue simulating liquid |
| NORM _{x,y,z} | sensitivity in free space |
| ConvF | sensitivity in TSL / NORM _{x,y,z} |
| DCP | diode compression point |
| CF | crest factor (1/duty_cycle) of the RF signal |
| A,B,C,D | modulation dependent linearization parameters |
| Polarization Φ | Φ rotation around probe axis |
| Polarization θ | θ rotation around an axis that is in the plane normal to probe axis (at measurement center), i $\theta=0$ is normal to probe axis |

Connector Angle information used in DASY system to align probe sensor X to the robot coordinate system

Calibration is Performed According to the Following Standards:

- IEEE Std 1528-2013, "IEEE Recommended Practice for Determining the Peak Spatial-Averaged Specific Absorption Rate (SAR) in the Human Head from Wireless Communications Devices: Measurement Techniques", June 2013
- IEC 62209-1, "Procedure to measure the Specific Absorption Rate (SAR) for hand-held devices used in close proximity to the ear (frequency range of 300MHz to 3GHz)", February 2005
- IEC 62209-2, "Procedure to determine the Specific Absorption Rate (SAR) for wireless communication devices used in close proximity to the human body (frequency range of 30 MHz to 6 GHz)", March 2010
- KDB 865664, "SAR Measurement Requirements for 100 MHz to 6 GHz"

Methods Applied and Interpretation of Parameters:

- NORM_{x,y,z}**: Assessed for E-field polarization $\theta=0$ ($f \leq 900\text{MHz}$ in TEM-cell; $f > 1800\text{MHz}$: waveguide). NORM_{x,y,z} are only intermediate values, i.e., the uncertainties of NORM_{x,y,z} does not effect the E^2 -field uncertainty inside TSL (see below ConvF).
- NORM(f)_{x,y,z} = NORM_{x,y,z} * frequency_response** (see Frequency Response Chart). This linearization is implemented in DASY4 software versions later than 4.2. The uncertainty of the frequency response is included in the stated uncertainty of ConvF.
- DCP_{x,y,z}**: DCP are numerical linearization parameters assessed based on the data of power sweep (no uncertainty required). DCP does not depend on frequency nor media.
- PAR**: PAR is the Peak to Average Ratio that is not calibrated but determined based on the signal characteristics.
- A_{x,y,z}; B_{x,y,z}; C_{x,y,z}; VR_{x,y,z}; A,B,C** are numerical linearization parameters assessed based on the data of power sweep for specific modulation signal. The parameters do not depend on frequency nor media. VR is the maximum calibration range expressed in RMS voltage across the diode.
- ConvF and Boundary Effect Parameters**: Assessed in flat phantom using E-field (or Temperature Transfer Standard for $f \leq 800\text{MHz}$) and inside waveguide using analytical field distributions based on power measurements for $f > 800\text{MHz}$. The same setups are used for assessment of the parameters applied for boundary compensation (alpha, depth) of which typical uncertainty valued are given. These parameters are used in DASY4 software to improve probe accuracy close to the boundary. The sensitivity in TSL corresponds to NORM_{x,y,z} * ConvF whereby the uncertainty corresponds to that given for ConvF. A frequency dependent ConvF is used in DASY version 4.4 and higher which allows extending the validity from $\pm 50\text{MHz}$ to $\pm 100\text{MHz}$.
- Spherical isotropy (3D deviation from isotropy)**: in a field of low gradients realized using a flat phantom exposed by a patch antenna.
- Sensor Offset**: The sensor offset corresponds to the offset of virtual measurement center from the probe tip (on probe axis). No tolerance required.
- Connector Angle**: The angle is assessed using the information gained by determining the NORM_x (no uncertainty required).



Add: No.51 Xueyuan Road, Haidian District, Beijing, 100191, China
Tel: +86-10-62304633-2218 Fax: +86-10-62304633-2209
E-mail: ctl@chinattl.com [Http://www.chinattl.cn](http://www.chinattl.cn)

Probe EX3DV4

SN: 3754

Calibrated: January 13, 2017

Calibrated for DASY/EASY Systems

(Note: non-compatible with DASY2 system!)



In Collaboration with
TTL s p e a g
 CALIBRATION LABORATORY
 Add: No.51 Xueyuan Road, Haidian District, Beijing, 100191, China
 Tel: +86-10-62304633-2218 Fax: +86-10-62304633-2209
 E-mail: cttl@chinattl.com [Http://www.chinattl.cn](http://www.chinattl.cn)

DASY/EASY – Parameters of Probe: EX3DV4 – SN: 3754

Basic Calibration Parameters

| | Sensor X | Sensor Y | Sensor Z | Unc (k=2) |
|--|----------|----------|----------|--------------|
| Norm($\mu\text{V}/(\text{V}/\text{m})^2$) ^A | 0.48 | 0.41 | 0.59 | $\pm 10.8\%$ |
| DCP(mV) ^B | 102.4 | 100.9 | 102.7 | |

Modulation Calibration Parameters

| UID | Communication System Name | | A dB | B dB $\sqrt{\mu\text{V}}$ | C | D dB | VR mV | Unc ^E (k=2) |
|-----|---------------------------|---|---------|------------------------------|-----|---------|----------|---------------------------|
| 0 | CW | X | 0.0 | 0.0 | 1.0 | 0.00 | 198.9 | $\pm 2.0\%$ |
| | | Y | 0.0 | 0.0 | 1.0 | | 175.6 | |
| | | Z | 0.0 | 0.0 | 1.0 | | 221.1 | |

The reported uncertainty of measurement is stated as the standard uncertainty of Measurement multiplied by the coverage factor k=2, which for a normal distribution corresponds to a coverage probability of approximately 95%.

^A The uncertainties of Norm X, Y, Z do not affect the E²-field uncertainty inside TSL (see Page 5 and Page 6).

^B Numerical linearization parameter: uncertainty not required.

^E Uncertainty is determined using the max. deviation from linear response applying rectangular distribution and is expressed for the square of the field value.



In Collaboration with
TTL SPEAG
CALIBRATION LABORATORY
 Add: No.51 Xueyuan Road, Haidian District, Beijing, 100191, China
 Tel: +86-10-62304633-2218 Fax: +86-10-62304633-2209
 E-mail: cttl@chinattl.com [Http://www.chinattl.cn](http://www.chinattl.cn)

DASY/EASY – Parameters of Probe: EX3DV4 – SN: 3754

Calibration Parameter Determined in Head Tissue Simulating Media

| f [MHz] ^C | Relative Permittivity ^F | Conductivity (S/m) ^F | ConvF X | ConvF Y | ConvF Z | Alpha ^G | Depth ^G (mm) | Unct. (k=2) |
|----------------------|------------------------------------|---------------------------------|---------|---------|---------|--------------------|-------------------------|-------------|
| 750 | 41.9 | 0.89 | 9.41 | 9.41 | 9.41 | 0.30 | 0.70 | ±12% |
| 900 | 41.5 | 0.97 | 9.10 | 9.10 | 9.10 | 0.13 | 1.52 | ±12% |
| 1750 | 40.1 | 1.37 | 8.08 | 8.08 | 8.08 | 0.17 | 1.23 | ±12% |
| 1900 | 40.0 | 1.40 | 7.85 | 7.85 | 7.85 | 0.24 | 1.05 | ±12% |
| 2100 | 39.8 | 1.49 | 7.73 | 7.73 | 7.73 | 0.23 | 1.12 | ±12% |
| 2300 | 39.5 | 1.67 | 7.58 | 7.58 | 7.58 | 0.56 | 0.72 | ±12% |
| 2450 | 39.2 | 1.80 | 7.26 | 7.26 | 7.26 | 0.55 | 0.73 | ±12% |
| 2600 | 39.0 | 1.96 | 7.05 | 7.05 | 7.05 | 0.60 | 0.70 | ±12% |
| 5250 | 35.9 | 4.71 | 5.20 | 5.20 | 5.20 | 0.45 | 1.30 | ±13% |
| 5600 | 35.5 | 5.07 | 4.62 | 4.62 | 4.62 | 0.45 | 1.35 | ±13% |
| 5750 | 35.4 | 5.22 | 4.73 | 4.73 | 4.73 | 0.45 | 1.55 | ±13% |

^C Frequency validity above 300 MHz of ±100MHz only applies for DASY v4.4 and higher (Page 2), else it is restricted to ±50MHz. The uncertainty is the RSS of ConvF uncertainty at calibration frequency and the uncertainty for the indicated frequency band. Frequency validity below 300 MHz is ± 10, 25, 40, 50 and 70 MHz for ConvF assessments at 30, 64, 128, 150 and 220 MHz respectively. Above 5 GHz frequency validity can be extended to ± 110 MHz.

^F At frequency below 3 GHz, the validity of tissue parameters (ϵ and σ) can be relaxed to ±10% if liquid compensation formula is applied to measured SAR values. At frequencies above 3 GHz, the validity of tissue parameters (ϵ and σ) is restricted to ±5%. The uncertainty is the RSS of the ConvF uncertainty for indicated target tissue parameters.

^G Alpha/Depth are determined during calibration. SPEAG warrants that the remaining deviation due to the boundary effect after compensation is always less than ± 1% for frequencies below 3 GHz and below ± 2% for the frequencies between 3-6 GHz at any distance larger than half the probe tip diameter from the boundary.



In Collaboration with
TTL SPEAG
CALIBRATION LABORATORY
 Add: No.51 Xueyuan Road, Haidian District, Beijing, 100191, China
 Tel: +86-10-62304633-2218 Fax: +86-10-62304633-2209
 E-mail: cttl@chinattl.com [Http://www.chinattl.cn](http://www.chinattl.cn)

DASY/EASY – Parameters of Probe: EX3DV4 – SN: 3754

Calibration Parameter Determined in Body Tissue Simulating Media

| f [MHz] ^C | Relative Permittivity ^F | Conductivity (S/m) ^F | ConvF X | ConvF Y | ConvF Z | Alpha ^G | Depth ^G (mm) | Unct. (k=2) |
|----------------------|------------------------------------|---------------------------------|---------|---------|---------|--------------------|-------------------------|-------------|
| 750 | 55.5 | 0.96 | 9.66 | 9.66 | 9.66 | 0.40 | 0.85 | ±12% |
| 900 | 55.0 | 1.05 | 9.31 | 9.31 | 9.31 | 0.23 | 1.17 | ±12% |
| 1750 | 53.4 | 1.49 | 7.80 | 7.80 | 7.80 | 0.22 | 1.14 | ±12% |
| 1900 | 53.3 | 1.52 | 7.60 | 7.60 | 7.60 | 0.20 | 1.22 | ±12% |
| 2100 | 53.2 | 1.62 | 7.96 | 7.96 | 7.96 | 0.23 | 1.24 | ±12% |
| 2300 | 52.9 | 1.81 | 7.43 | 7.43 | 7.43 | 0.41 | 1.01 | ±12% |
| 2450 | 52.7 | 1.95 | 7.22 | 7.22 | 7.22 | 0.40 | 1.04 | ±12% |
| 2600 | 52.5 | 2.16 | 7.15 | 7.15 | 7.15 | 0.45 | 0.92 | ±12% |
| 5250 | 48.9 | 5.36 | 4.79 | 4.79 | 4.79 | 0.50 | 1.55 | ±13% |
| 5600 | 48.5 | 5.77 | 4.09 | 4.09 | 4.09 | 0.55 | 1.50 | ±13% |
| 5750 | 48.3 | 5.94 | 4.55 | 4.55 | 4.55 | 0.58 | 1.70 | ±13% |

^C Frequency validity above 300 MHz of ±100MHz only applies for DASY v4.4 and higher (Page 2), else it is restricted to ±50MHz. The uncertainty is the RSS of ConvF uncertainty at calibration frequency and the uncertainty for the indicated frequency band. Frequency validity below 300 MHz is ± 10, 25, 40, 50 and 70 MHz for ConvF assessments at 30, 64, 128, 150 and 220 MHz respectively. Above 5 GHz frequency validity can be extended to ± 110 MHz.

^F At frequency below 3 GHz, the validity of tissue parameters (ϵ and σ) can be relaxed to ±10% if liquid compensation formula is applied to measured SAR values. At frequencies above 3 GHz, the validity of tissue parameters (ϵ and σ) is restricted to ±5%. The uncertainty is the RSS of the ConvF uncertainty for indicated target tissue parameters.

^G Alpha/Depth are determined during calibration. SPEAG warrants that the remaining deviation due to the boundary effect after compensation is always less than ± 1% for frequencies below 3 GHz and below ± 2% for the frequencies between 3-6 GHz at any distance larger than half the probe tip diameter from the boundary.