



# TEST REPORT

No. I17D00058-SAR01

*For*

**Client: Lenovo (Shanghai) Electronics**

**Technology Co., Ltd**

**Production: Portable Tablet Computer**

**Brand : Lenovo**

**Model Name: TB-X704V**

**Standard: ANSI C95.1-1999**

**FCC 47 CFR Part 2 ( 2.1093)**

**RSS 102 issue 5**

**FCC ID: O57TBX704V**

**IC: 10407A-TBX704V**

**Hardware Version: Lenovo Tablet TB-X704V**

**Software Version: TB-X704V\_RF01\_20170301**

**Issued date: 2017-6-23**

**Note:**

The test results in this test report relate only to the devices specified in this report. This report shall not be reproduced except in full without the written approval of ECIT Shanghai.

**Test Laboratory:**

ECIT Shanghai, East China Institute of Telecommunications

Add: 7-8F, G Area, No.668, Beijing East Road, Huangpu District, Shanghai, P. R. China

Tel: (+86)-021-63843300, E-Mail: [welcome@ecit.org.cn](mailto:welcome@ecit.org.cn)

**Revision Version**

<b>Report Number</b>	<b>Revision</b>	<b>Date</b>	<b>Memo</b>
I17D00058-SAR01	00	2017-6-16	Initial creation of test report
I17D00058-SAR01	01	2017-6-21	Second creation of test report
I17D00058-SAR01	02	2017-6-23	Third creation of test report

**CONTENTS**

1.	TEST LABORATORY .....	7
1.1.	TESTING LOCATION .....	7
1.2.	TESTING ENVIRONMENT .....	7
1.3.	PROJECT DATA.....	7
1.4.	SIGNATURE .....	7
2.	STATEMENT OF COMPLIANCE .....	8
3.	CLIENT INFORMATION.....	10
3.1.	APPLICANT INFORMATION .....	10
3.2.	MANUFACTURER INFORMATION .....	10
4.	EQUIPMENT UNDER TEST (EUT) AND ANCILLARY EQUIPMENT (AE) .....	11
4.1.	ABOUT EUT .....	11
4.2.	INTERNAL IDENTIFICATION OF EUT USED DURING THE TEST.....	12
4.3.	INTERNAL IDENTIFICATION OF AE USED DURING THE TEST .....	12
5.	TEST METHODOLOGY .....	13
5.1.	APPLICABLE LIMIT REGULATIONS .....	13
5.2.	APPLICABLE MEASUREMENT STANDARDS .....	13
6.	SPECIFIC ABSORPTION RATE (SAR).....	14
6.1.	INTRODUCTION.....	14
6.2.	SAR DEFINITION .....	14
7.	TISSUE SIMULATING LIQUIDS .....	15
7.1.	TARGETS FOR TISSUE SIMULATING LIQUID.....	15
7.2.	DIELECTRIC PERFORMANCE .....	15
8.	SYSTEM VERIFICATION .....	16
8.1.	SYSTEM SETUP .....	16
8.2.	SYSTEM VERIFICATION .....	17
9.	MEASUREMENT PROCEDURES .....	18

9.1. TESTS TO BE PERFORMED .....	18
9.2. GENERAL MEASUREMENT PROCEDURE .....	19
9.3. WCDMA MEASUREMENT PROCEDURES FOR SAR.....	20
9.4. SAR MEASUREMENT FOR LTE.....	21
9.5. BLUETOOTH & WI-FI MEASUREMENT PROCEDURES FOR SAR.....	22
9.6. POWER DRIFT .....	23
10. AREA SCAN BASED 1-G SAR .....	24
11. CONDUCTED OUTPUT POWER .....	25
11.1. MANUFACTURING TOLERANCE.....	25
11.2. WCDMA MEASUREMENT RESULT .....	29
11.3. LTE MEASUREMENT RESULT .....	31
11.4. WI-FI AND BT MEASUREMENT RESULT .....	50
12. SIMULTANEOUS TX SAR CONSIDERATIONS.....	54
12.1. INTRODUCTION.....	54
12.2. TRANSMIT ANTENNA SEPARATION DISTANCES.....	54
12.3. STANDALONE SAR TEST EXCLUSION CONSIDERATIONS .....	55
12.4. SAR MEASUREMENT POSITIONS .....	56
13. POWER REDUCTION BY PROXIMITY SENSING.....	57
13.1. PROCEDURES FOR DETERMINING PROXIMITY SENSOR TRIGGERING DISTANCES	57
13.2. PROCEDURES FOR DETERMINING ANTENNA AND PROXIMITY SENSOR COVERAGE	58
13.3. PROXIMITY SENSOR STATUS TABLE OF TRIGGER DISTANCE .....	60
13.4. TILT ANGLE INFLUENCES TO PROXIMITY SENSOR TRIGGERING.....	62
13.5. POWER REDUCTION PER AIR-INTERFACE.....	63
13.6. PROXIMITY SENSOR COVERAGE AREA .....	64
14. EVALUATION OF SIMULTANEOUS.....	65
15. SAR TEST RESULT .....	67
16. SAR MEASUREMENT VARIABILITY.....	80

17.	MEASUREMENT UNCERTAINTY .....	81
18.	MAIN TEST INSTRUMENT .....	83
ANNEX A.	GRAPH RESULTS .....	84
ANNEX B.	SYSTEM VALIDATION RESULTS .....	116
ANNEX C.	SAR MEASUREMENT SETUP .....	121
ANNEX D.	POSITION OF THE WIRELESS DEVICE IN RELATION TO THE PHANTOM....	130
ANNEX E.	EQUIVALENT MEDIA RECIPES .....	134
ANNEX F.	SYSTEM VALIDATION .....	135
ANNEX G.	PROBE AND DAE CALIBRATION CERTIFICATE.....	136
ANNEX H.	ACCREDITATION CERTIFICATE .....	213

## 1. Test Laboratory

### 1.1. Testing Location

Company Name:	ECIT Shanghai, East China Institute of Telecommunications
Address:	7-8F, G Area, No. 668, Beijing East Road, Huangpu District, Shanghai, P. R. China
Postal Code:	200001
Telephone:	(+86)-021-63843300
Fax:	(+86)-021-63843301
IC OAT' S Test Site Registration Number	10766A-1

### 1.2. Testing Environment

Normal Temperature:	18-25°C
Relative Humidity:	10-90%
Ambient noise & Reflection:	< 0.012 W/kg

### 1.3. Project Data

Project Leader:	Chen Minfei
Testing Start Date:	2017-04-27
Testing End Date:	2017-06-05

### 1.4. Signature



**Fu Erliang**  
(Prepared this test report)



**Song Kaihua**  
(Reviewed this test report)

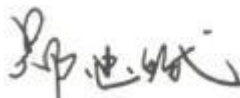

**Zheng Zhongbin**  
Director of the laboratory  
(Approved this test report)

## 2. Statement of Compliance

The maximum results of Specific Absorption Rate (SAR) found during testing for **TB-X704V** are as follows ( with expanded uncertainty 22.4%)

**Table 2.1: Max. Reported SAR (1g)**

Band	Position	SAR 1g (W/Kg)
WCDMA Band2	Body	1.155
WCDMA Band5	Body	0.478
LTE Band2	Body	0.948
LTE Band4	Body	1.023
LTE Band5	Body	0.503
LTE Band7	Body	1.138
LTE Band12	Body	0.758
LTE Band13	Body	0.504
Wi-Fi 2.4GHz	Body	0.370
Wi-Fi 5GHz	Body	0.341

The SAR values found for the Mobile Phone are below the maximum recommended levels of 1.6 W/Kg as averaged over any 1g tissue according to the ANSI C95.1-1999 and RSS 102 issue 5 .

For body worn operation, this device has been tested and meets FCC RF exposure guidelines when used with any accessory that contains no metal. Use of other accessories may not ensure compliance with FCC RF exposure guidelines.

The LTE Band12/13 and Wi-Fi 5GHz test result are reference **TA Technology (Shanghai) Co.,Ltd** and the report No. is **RXA1704-0095SAR**.

The measurement together with the test system set-up is described in chapter 7 of this test report. A detailed description of the equipment under test can be found in chapter 3 of this test report.



The sample has four TX antennas. One is main antenna for WCDMA/LTE Middle, High Band, One is main antenna for WCDMA/LTE Low Band and the other is for WiFi/BT and GPS. So simultaneous transmission is LTE/WCDMA and WiFi/BT.

**Table 2.2: Simultaneous SAR (1g)**

Transmission SAR(W/Kg)						
Test Position		3G	4G	WIFI 2.4GHz	BT	SUM
Body 14mm	Ground Side	1.155	1.012	0.127	0.083	1.292
	Right Side	--	--	--	0.083	0.083
	Bottom Side	0.208	0.153	--	0.083	0.291
	Top Side	0.573	1.138	0.093	0.083	1.231
Body 0 mm	Ground Side	1.092	1.023	0.370	0.083	1.462
	Right Side	0.276	0.511	--	0.083	0.594
	Bottom Side	0.248	0.334	--	0.083	0.417
	Top Side	0.492	0.864	0.138	0.083	1.002

According to the above table, the maximum sum of reported SAR values for WCDMA/LTE and WiFi is **1.462 W/kg** (1g). The detail for simultaneous transmission consideration is described in chapter 12.

### 3. Client Information

#### 3.1. Applicant Information

Company Name: Lenovo (Shanghai) Electronics Technology Co., Ltd  
Address: NO.68 BUILDING, 199 FENJU RD, Pilot Free Trade Zone, Shanghai,  
200131, China  
Email: liujl11@lenovo.com

#### 3.2. Manufacturer Information

Company Name: Lenovo PC HK Limited  
Address: 23/F, Lincoln House, Taikoo Place 979 King's Road, Quarry Bay, Hong Kong  
Email: liujl11@lenovo.com

## 4. Equipment Under Test (EUT) and Ancillary Equipment (AE)

### 4.1. About EUT

Description:	Portable Tablet Computer
Model name:	TB-X704V
Operation Model(s):	WCDMA Band II/V LTE Band 2/4/5/7,WIFI2450
Tx Frequency:	1852.4-1907.6 MHz (WCDMA Band II) 826.4-846.6MHz (WCDMA Band V) 1850MHz -1910 MHz (LTE Band 2) 1710MHz -1755 MHz (LTE Band 4) 824 MHz -849 MHz (LTE Band 5) 2500 MHz - 2570 MHz (LTE Band 7) 2412- 2462 MHz (Wi-Fi) 2400-2483.5 MHz (BT)
Test device Production information: GPRS/EGPRS Class Mode: GPRS/ EGPRS Multislot Class:	Production unit N/A N/A
Device type:	Portable device
UE category:	3
Antenna type:	Inner antenna
Accessories/Body-worn configurations:	Headset Battery
Dimensions: Hotspot Mode:	24.5cm×17.5cm×0.8cm Support simultaneous transmission of hotspot and voice ( or data)
FCC ID:	O57TBX704V
IC:	10407A-TBX704V
<p>The device employs proximity sensors that detect the presence of the user's body at the back faces and Top or bottom side of the device. when back body worn and Top or bottom side condition is detected, WCDMA Band II/V;LTE Band 2/4/5/7;WIFI 2.4GHz reduced power will be active.</p>	

**4.2. Internal Identification of EUT used during the test**

EUT ID*	SN or IMEI	HW Version	SW Version	Receive Date
N05	863923030004393	Lenovo Tablet TB-X704V	TB-X704V_RF01_20170 301	2017-3-17

\*EUT ID: is used to identify the test sample in the lab internally.

**4.3. Internal Identification of AE used during the test**

AE ID*	Description	Model	SN	Manufacturer
N/A	N/A	N/A	N/A	N/A

\*AE ID: is used to identify the test sample in the lab internally.

## 5. TEST METHODOLOGY

### 5.1. Applicable Limit Regulations

**ANSI C95.1–1999:**IEEE Standard for Safety Levels with Respect to Human Exposure to Radio Frequency Electromagnetic Fields, 3 kHz to 300 GHz.

**FCC 47 CFR Part 2 ( 2.1093):** Radiofrequency radiation exposure evaluation: portable devices.

**RSS-102 issue 5: 2015:** Radio Frequency (RF) Exposure Compliance of Radio communication Apparatus (All Frequency Bands)

It specifies the maximum exposure limit of **1.6 W/kg** as averaged over any 1 gram of tissue for portable devices being used within 20 cm of the user in the uncontrolled environment.

### 5.2. Applicable Measurement Standards

**IEEE 1528:2013:** Recommended Practice for Determining the Peak Spatial-Average Specific Absorption Rate (SAR) in the Human Body Due to Wireless Communications Devices: Experimental Techniques.

**IEC62209-2:2010:** Human exposure to radiofrequency fields from handheld and body mounted wireless communication devices — Human models, instrumentation, and procedures Part 2: Procedure to determine the specific absorption rate (SAR) for wireless communication devices used in close proximity to the human body(frequency range of 30 MHz to 6 GHz)

**KDB 616217 D04 SAR for laptop and tablets v01r02:** SAR evaluation considerations for laptop, notebook, netbook and tablet computers.

**KDB248227 D01 802 11 Wi-Fi SAR v02r02:** SAR measurement procedures for 802.112abg transmitters.

**KDB447498 D01 General RF Exposure Guidance v06:**Mobile and Portable Devices RF Exposure Procedures and Equipment Authorization Policies.

**KDB865664 D01 SAR Measurement 100 MHz to 6 GHz v01r04:**SAR Measurement Requirements for 100 MHz to 6 GHz

**KDB865664 D02 RF Exposure Reporting v01r02:**provides general reporting requirements as well as certain specific information required to support MPE and SAR compliance.

**KDB941225 D01 3G SAR Procedures v03r01:** 3G SAR Measurement Procedures.

**KDB941225 D05 SAR for LTE Devices v02r04:** SAR Evaluation Considerations for LTE Devices.

**KDB941225 D06 hotspot SAR v02r01:**SAR Evaluation Procedures for Portable Devices with Wireless Router Capabilities.

NOTE: KDB is not in A2LA Scope List.

## 6. Specific Absorption Rate (SAR)

### 6.1. Introduction

SAR is related to the rate at which energy is absorbed per unit mass in an object exposed to a radio field. The SAR distribution in a biological body is complicated and is usually carried out by experimental techniques or numerical modeling. The standard recommends limits for two tiers of groups, occupational/controlled and general population/uncontrolled, based on a person's awareness and ability to exercise control over his or her exposure. In general, occupational/controlled exposure limits are higher than the limits for general population/uncontrolled.

### 6.2. SAR Definition

The SAR definition is the time derivative (rate) of the incremental energy ( $dW$ ) absorbed by (dissipated in) an incremental mass ( $dm$ ) contained in a volume element ( $dv$ ) of a given density ( $\rho$ ). The equation description is as below:

$$SAR = \frac{d}{dt} \left( \frac{dW}{dm} \right) = \frac{d}{dt} \left( \frac{dW}{\rho dv} \right)$$

SAR is expressed in units of Watts per kilogram (W/kg)

SAR measurement can be either related to the temperature elevation in tissue by

$$SAR = c \left( \frac{\delta T}{\delta t} \right)$$

Where:  $C$  is the specific heat capacity,  $\delta T$  is the temperature rise and  $\delta t$  is the exposure duration, or related to the electrical field in the tissue by

$$SAR = \frac{\sigma |E|^2}{\rho}$$

Where:  $\sigma$  is the conductivity of the tissue,  $\rho$  is the mass density of tissue and  $E$  is the RMS electrical field strength.

However for evaluating SAR of low power transmitter, electrical field measurement is typically applied.

## 7. Tissue Simulating Liquids

### 7.1. Targets for tissue simulating liquid

**Table 7.1: Targets for tissue simulating liquid**

Frequency (MHz)	Liquid Type	Conductivity( $\sigma$ )	$\pm 5\%$ Range	Permittivity( $\epsilon$ )	$\pm 5\%$ Range
835	Head	0.90	0.86~0.95	41.5	39.4~43.6
835	Body	0.97	0.92~1.02	55.2	52.4~58.0
1800	Head	1.40	1.33~1.47	40.0	38.0~42.0
1800	Body	1.52	1.44~1.60	53.3	50.6~56.0
1900	Head	1.40	1.33~1.47	40.0	38.0~42.0
1900	Body	1.52	1.44~1.60	53.3	50.6~56.0
2450	Head	1.80	1.71~1.89	39.2	37.2~41.2
2450	Body	1.95	1.85~2.05	52.7	50.1~55.3
2600	Head	1.96	1.86~2.06	39	37.05~40.95
2600	Body	2.16	2.05~2.27	52.5	59.88~55.13

### 7.2. Dielectric Performance

**Table 7.2: Dielectric Performance of Tissue Simulating Liquid**

Measurement Value						
Liquid Temperature: 22.5 °C						
Type	Frequency	Permittivity $\epsilon$	Drift (%)	Conductivity $\sigma$	Drift (%)	Test Date
Body	826.4MHz	55.147	-0.10%	0.994	2.47%	2017-4-28
Body	846.6 MHz	55.214	0.09%	1.012	2.89%	2017-4-28
Body	829 MHz	55.141	-0.15%	0.995	2.63%	2017-4-28
Body	836.5 MHz	55.152	-0.08%	0.997	2.65%	2017-4-28
Body	844 MHz	55.203	0.06%	1.008	2.74%	2017-4-28
Body	1720MHz	52.301	-2.30%	1.411	-3.65%	2017-4-29
Body	1732.5MHz	52.305	-2.20%	1.422	-3.73%	2017-4-29
Body	1745MHz	52.3	-2.11%	1.435	-3.67%	2017-4-29
Body	1852.4MHz	54.779	2.77%	1.523	0.20%	2017-4-27
Body	1880.0MHz	54.667	2.56%	1.551	2.04%	2017-4-27
Body	1907.6MHz	54.555	2.35%	1.579	3.88%	2017-4-27
Body	1860MHz	54.749	2.72%	1.531	0.72%	2017-4-27
Body	1900MHz	54.586	2.41%	1.571	3.36%	2017-4-27
Body	2412 MHz	53.051	0.57%	1.932	0.96%	2017-5-23
Body	2437 MHz	52.966	0.47%	1.961	1.21%	2017-5-23
Body	2462 MHz	52.882	0.37%	1.991	1.22%	2017-5-23
Body	2510MHz	53.804	2.23%	1.978	-2.47%	2017-6-05
Body	2535MHz	53.723	2.15%	2.004	-3.21%	2017-6-05
Body	2560MHz	53.474	1.75%	2.044	-3.27%	2017-6-05

## 8. System verification

### 8.1. System Setup

In the simplified setup for system evaluation, the DUT is replaced by a calibrated dipole and the power source is replaced by a continuous wave that comes from a signal generator. The calibrated dipole must be placed beneath the flat phantom section of the SAM twin phantom with the correct distance holder. The distance holder should touch the phantom surface with a light pressure at the reference marking and be oriented parallel to the long side of the phantom. The equipment setup is shown below:

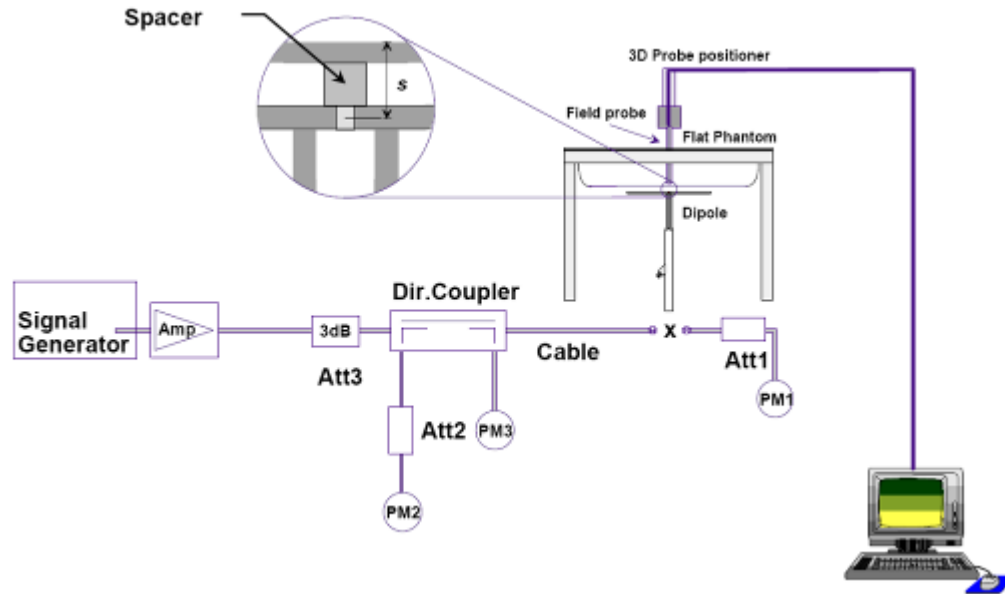

**Picture 8.1 System Setup for System Evaluation**



**Picture 8.2 Photo of Dipole Setup**



## 8.2. System Verification

SAR system verification is required to confirm measurement accuracy, according to the tissue dielectric media, probe calibration points and other system operating parameters required for measuring the SAR of test device. The system verification must be performed for each frequency band and within the valid range of each probe calibration point required for testing the device.

**Table 8.1: System Verification of Body**

Verification Results							
Input power level: 1W							
Frequency	Target value (W/kg)		Measured value (W/kg)		Deviation		Test date
	10 g Average	1 g Average	10 g Average	1 g Average	10 g Average	1 g Average	
835 MHz	6.29	9.57	6.36	9.56	1.11%	-0.10%	2017-4-28
1750 MHz	20.2	37.6	20.72	38.28	2.57%	1.81%	2017-4-29
1900 MHz	21.3	41.1	21.92	42.4	2.91%	3.16%	2017-4-27
2450 MHz	24.7	53.1	25.36	55.6	2.67%	4.71%	2017-5-23
2600 MHz	25.4	57.1	24.32	55.6	-4.25%	-2.63%	2017-6-05

## 9. Measurement Procedures

### 9.1. Tests to be performed

In order to determine the highest value of the peak spatial-average SAR of a handset, all device positions, configurations and operational modes shall be tested for each frequency band according to steps 1 to 3 below. A flowchart of the test process is shown in Picture 11.1.

**Step 1:** The tests described in 11.2 shall be performed at the channel that is closest to the centre of the transmit frequency band ( $f_c$ ) for:

- a) all device positions (cheek and tilt, for both left and right sides of the SAM phantom, as described in Chapter 8),
- b) all configurations for each device position in a), e.g., antenna extended and retracted, and
- c) all operational modes, e.g., analogue and digital, for each device position in a) and configuration in b) in each frequency band.

If more than three frequencies need to be tested according to 11.1 (i.e.,  $N_c > 3$ ), then all frequencies, configurations and modes shall be tested for all of the above test conditions.

**Step 2:** For the condition providing highest peak spatial-average SAR determined in Step 1, perform all tests described in 11.2 at all other test frequencies, i.e., lowest and highest frequencies. In addition, for all other conditions (device position, configuration and operational mode) where the peak spatial-average SAR value determined in Step 1 is within 3 dB of the applicable SAR limit, it is recommended that all other test frequencies shall be tested as well.

**Step 3:** Examine all data to determine the highest value of the peak spatial-average SAR found in Steps 1 to 2.

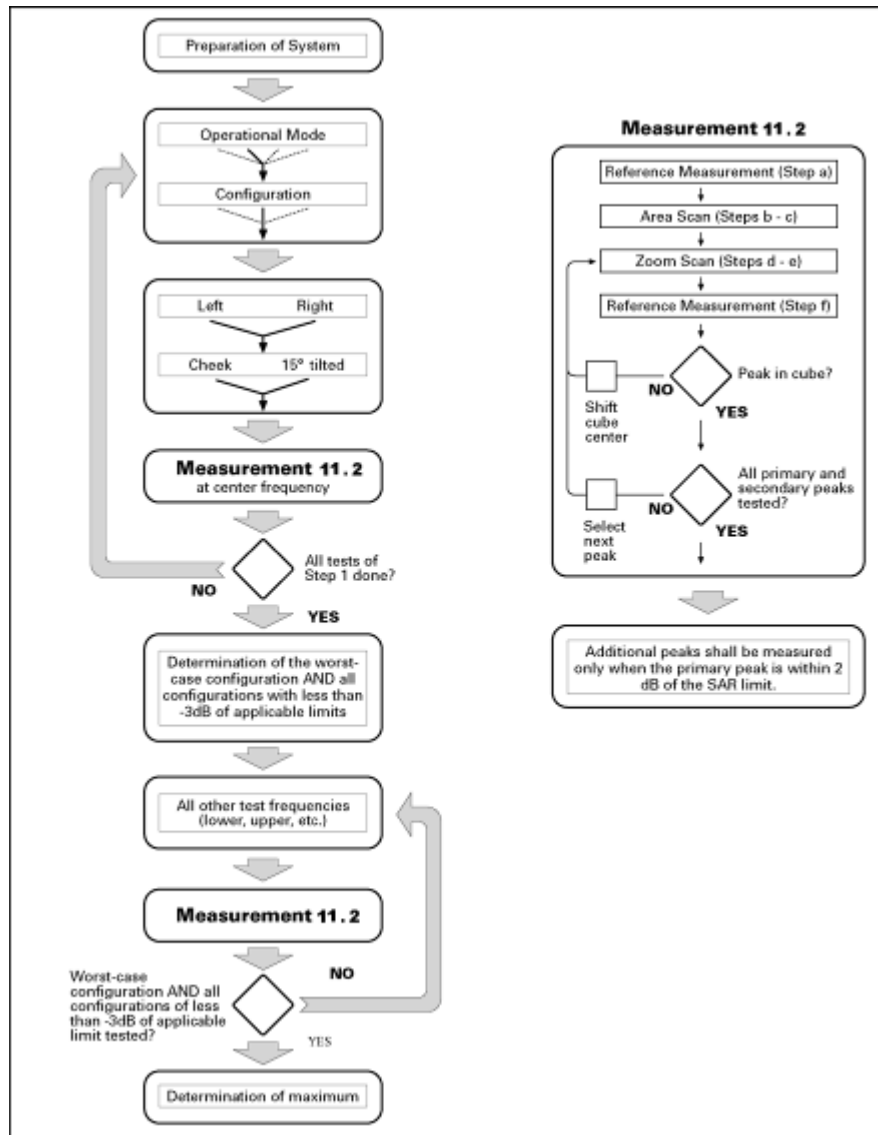

Picture 9.1 Block diagram of the tests to be performed

## 9.2. General Measurement Procedure

The following procedure shall be performed for each of the test conditions (see Picture 11.1) described in 11.1:

- a) Measure the local SAR at a test point within 8 mm or less in the normal direction from the inner surface of the phantom.
- b) Measure the two-dimensional SAR distribution within the phantom (area scan procedure). The boundary of the measurement area shall not be closer than 20 mm from the phantom side walls. The distance between the measurement points should enable the detection of the location of local maximum with an accuracy of better than half the linear dimension of the tissue cube after interpolation. A maximum grid spacing of 20 mm for frequencies below 3 GHz and  $(60/f \text{ [GHz]})$  mm for frequencies of 3GHz and greater is recommended. The maximum distance between the geometrical centre of the probe detectors and the inner surface of the phantom shall be 5 mm for frequencies below 3 GHz and  $0.5 \ln(2)/2$  mm for frequencies of 3 GHz and greater, where  $\delta$  is the plane wave skin depth and  $\ln(x)$  is the natural logarithm. The maximum variation of the sensor-phantom surface shall be  $\pm 1$  mm for frequencies below 3 GHz and  $\pm 0.5$  mm for frequencies of 3 GHz and greater. At all measurement points the angle of the probe with

respect to the line normal to the surface should be less than 5°. If this cannot be achieved for a measurement distance to the phantom inner surface shorter than the probe diameter, additional uncertainty evaluation is needed.

c) From the scanned SAR distribution, identify the position of the maximum SAR value, in addition identify the positions of any local maxima with SAR values within 2 dB of the maximum value that are not within the zoom-scan volume; additional peaks shall be measured only when the primary peak is within 2 dB of the SAR limit. This is consistent with the 2 dB threshold already stated;

d) Measure the three-dimensional SAR distribution at the local maxima locations identified in step c). The horizontal grid step shall be  $(24/f[\text{GHz}])$  mm or less but not more than 8 mm. The minimum zoom size of 30 mm by 30 mm and 30 mm for frequencies below 3 GHz. For higher frequencies, the minimum zoom size of 22 mm by 22 mm and 22 mm. The grid step in the vertical direction shall be  $(8 \cdot f[\text{GHz}])$  mm or less but not more than 5 mm, if uniform spacing is used. If variable spacing is used in the vertical direction, the maximum spacing between the two closest measured points to the phantom shell shall be  $(12 / f[\text{GHz}])$  mm or less but not more than 4 mm, and the spacing between further points shall increase by an incremental factor not exceeding 1.5. When variable spacing is used, extrapolation routines shall be tested with the same spacing as used in measurements. The maximum distance between the geometrical centre of the probe detectors and the inner surface of the phantom shall be 5 mm for frequencies below 3 GHz and  $\delta \ln(2)/2$  mm for frequencies of 3 GHz and greater, where  $\delta$  is the plane wave skin depth and  $\ln(x)$  is the natural logarithm. Separate grids shall be centered on each of the local SAR maxima found in step c). Uncertainties due to field distortion between the media boundary and the dielectric enclosure of the probe should also be minimized, which is achieved if the distance between the phantom surface and physical tip of the probe is larger than probe tip diameter. Other methods may utilize correction procedures for these boundary effects that enable high precision measurements closer than half the probe diameter. For all measurement points, the angle of the probe with respect to the flat phantom surface shall be less than 5°. If this cannot be achieved an additional uncertainty evaluation is needed.

e) Use post processing( e.g. interpolation and extrapolation ) procedures to determine the local SAR values at the spatial resolution needed for mass averaging.

### 9.3. WCDMA Measurement Procedures for SAR

The following procedures are applicable to WCDMA handsets operating under 3GPP Release99, Release 5 and Release 6. The default test configuration is to measure SAR with an established radio link between the DUT and a communication test set using a 12.2kbps RMC (reference measurement channel) configured in Test Loop Mode 1. SAR is selectively confirmed for other physical channel configurations (DPCCH & DPDCH<sub>n</sub>), HSDPA and HSPA (HSUPA/HSDPA) modes according to output power, exposure conditions and device operating capabilities. Both uplink and downlink should be configured with the same RMC or AMR, when required. SAR for Release 5 HSDPA and Release 6 HSPA are measured using the applicable FRC (fixed reference channel) and E-DCH reference channel configurations. Maximum output power is verified according to applicable versions of 3GPP TS 34.121 and SAR must be measured according to these maximum output conditions. When Maximum Power Reduction (MPR) is not implemented according to Cubic Metric (CM) requirements for Release 6 HSPA, the following procedures do not apply.

#### For Release 5 HSDPA Data Devices:

Sub-test	$\beta_c$	$\beta_d$	$\beta_d$ (SF)	$\beta_c / \beta_d$	$\beta_{hs}$	CM/dB	MPR/dB
1	2/15	15/15	64	2/15	4/15	2.0	0.0

2	12/15	15/15	64	12/15	24/25	2.0	0.0
3	15/15	8/15	64	15/8	30/15	2.0	0.0
4	15/15	4/15	64	15/4	30/15	2.0	0.0

### For Release 6 HSUPA Data Devices

Sub - test	$\beta_c$	$\beta_d$	$\beta_d$ (SF)	$\beta_c / \beta_d$	$\beta_{hs}$	$\beta_{ec}$	$\beta_{ed}$	$\beta_{ed}$ (SF)	$\beta_{ed}$ (codes)	CM (dB)	MP R (dB)	AG Index	E-TFC I
1	11/1 5	15/1 5	64	11/15	22/1 5	209/22 5	1039/225	4	1	2.0	1.0	20	75
2	6/15	15/1 5	64	6/15	12/1 5	12/15	12/15	4	1	2.0	1.0	12	67
3	15/1 5	9/15	64	15/9	30/1 5	30/15	$\beta_{ed1}:47/15$ $\beta_{ed2}:47/1$ 5	4	2	2.0	1.0	15	92
4	2/15	15/1 5	64	2/15	4/15	4/15	56/75	4	1	2.0	1.0	17	71
5	15/1 5	15/1 5	64	15/15	24/1 5	30/15	134/15	4	1	2.0	1.0	21	81

## 9.4. SAR Measurement for LTE

SAR tests for LTE are performed with a base station simulator, Anritsu 8820. Closed loop power control was used so the UE transmits with maximum output power during SAR testing. All powers were measured with the Anritsu 8820

It is performed for conducted power and SAR based on the KDB941225 D05.

SAR is evaluated separately according to the following procedures for the different test positions in each exposure condition – head, body, body-worn accessories and other use conditions. The procedures in the following subsections are applied separately to test each LTE frequency band

1) QPSK with 1 RB allocation

Start with the largest channel bandwidth and measure SAR for QPSK with 1 RB allocation, using the RB offset and required test channel combination with the highest maximum output power among RB offsets at the upper edge, middle and lower edge of each required test channel. When the reported SAR is  $\leq 0.8$  W/kg, testing of the remaining RB offset configurations and required test channels is not required for 1 RB allocation; otherwise, SAR is required for the remaining required test channels and only for the RB offset configuration with the highest output power for that channel. When the reported SAR of a required test channel is  $> 1.45$  W/kg, SAR is required for all three RB offset configurations for that required test channel.

2) QPSK with 50% RB allocation

The procedures required for 1 RB allocation in 1) are applied to measure the SAR for QPSK with 50% RB allocation.

3) QPSK with 100% RB allocation

For QPSK with 100% RB allocation, SAR is not required when the highest maximum output power for 100 % RB allocation is less than the highest maximum output power in 50% and 1 RB allocations and the highest reported SAR for 1 RB and 50% RB allocation in 1) and 2) are  $\leq 0.8$ W/kg. Otherwise, SAR is measured for the highest output power channel; and if the reported SAR is  $> 1.45$  W/kg, the remaining required test channels must also be tested.

## 9.5. Bluetooth & Wi-Fi Measurement Procedures for SAR

Normal network operating configurations are not suitable for measuring the SAR of 802.11 transmitters in general. Unpredictable fluctuations in network traffic and antenna diversity conditions can introduce undesirable variations in SAR results. The SAR for these devices should be measured using chipset based test mode software to ensure that the results are consistent and reliable.

Chipset based test mode software is hardware dependent and generally varies among manufacturers. The device operating parameters established in a test mode for SAR measurements must be identical to those programmed in production units, including output power levels, amplifier gain settings and other RF performance tuning parameters. The test frequencies should correspond to actual channel frequencies defined for domestic use. SAR for devices with switched diversity should be measured with only one antenna transmitting at a time during each SAR measurement, according to a fixed modulation and data rate. The same data pattern should

be used for all measurements.

### **9.6. Power Drift**

To control the output power stability during the SAR test, DASY5 system calculates the power drift by measuring the E-field at the same location at the beginning and at the end of the measurement for each test position. These drift values can be found in Section 15 labeled as: (Power Drift [dB]). This ensures that the power drift during one measurement is within 5%.

## 10. Area Scan Based 1-g SAR

### 10.1 Requirement of KDB

According to the KDB447498 D01 v06, when the implementation is based the specific polynomial fit algorithm as presented at the 29th Bioelectromagnetics Society meeting (2007) and the estimated 1-g SAR is  $\leq 1.2$  W/kg, a zoom scan measurement is not required provided it is also not needed for any other purpose; for example, if the peak SAR location required for simultaneous transmission SAR test exclusion can be determined accurately by the SAR system or manually to discriminate between distinctive peaks and scattered noisy SAR distributions from area scans.

There must not be any warning or alert messages due to various measurement concerns identified by the SAR system; for example, noise in measurements, peaks too close to scan boundary, peaks are too sharp, spatial resolution and uncertainty issues etc. The SAR system verification must also demonstrate that the area scan estimated 1-g SAR is within 3% of the zoom scan 1-g SAR (See Annex B). When all the SAR results for each exposure condition in a frequency band and wireless mode are based on estimated 1-g SAR, the 1-g SAR for the highest SAR configuration must be determined by a zoom scan.

### 10.2 Fast SAR Algorithms

The approach is based on the area scan measurement applying a frequency dependent attenuation parameter. This attenuation parameter was empirically determined by analyzing a large number of phones. The MOTOROLA FAST SAR was developed and validated by the MOTOROLA Research Group in Ft. Lauderdale.

In the initial study, an approximation algorithm based on Linear fit was developed. The accuracy of the algorithm has been demonstrated across a broad frequency range (136-2450 MHz) and for both 1- and 10-g averaged SAR using a sample of 264 SAR measurements from 55 wireless handsets. For the sample size studied, the root-mean-squared errors of the algorithm are 1.2% and 5.8% for 1- and 10-g averaged SAR, respectively. The paper describing the algorithm in detail is expected to be published in August 2004 within the Special Issue of Transactions on MTT.

In the second step, the same research group optimized the fitting algorithm to an Polynomial fit whereby the frequency validity was extended to cover the range 30-6000MHz. Details of this study can be found in the BEMS 2007 Proceedings.

Both algorithms are implemented in DASY software.



## 11. Conducted Output Power

### 11.1. Manufacturing tolerance

**Table 11.4: WCDMA**

WCDMA Band II Sensor off			
Channel	Channel 9262	Channel 9400	Channel 9538
Maximum Target Value (dBm)	23.5	23.5	23.5
WCDMA Band II Sensor on			
Channel	Channel 9262	Channel 9400	Channel 9538
Maximum Target Value (dBm)	14	14	14

**Table 11.5: HSDPA**

WCDMA Band II				
Channel		9262	9400	9538
1	Maximum Target Value (dBm)	23	23	23
2	Maximum Target Value (dBm)	23	23	23
3	Maximum Target Value (dBm)	22.5	22.5	22.5
4	Maximum Target Value (dBm)	22	22	22

**Table 11.6: HSUPA**

WCDMA Band II				
Channel		9262	9400	9538
1	Maximum Target Value (dBm)	22	22	22
2	Maximum Target Value (dBm)	21	21	21
3	Maximum Target Value (dBm)	21	21	21
4	Maximum Target Value (dBm)	22	22	22
5	Maximum Target Value (dBm)	22	22	22

**Table 11.7: WCDMA**

WCDMA Band V Sensor off			
Channel	4132	4182	4233
Maximum Target Value (dBm)	23.5	23.5	23.5
WCDMA Band V Sensor on			
Channel	4132	4182	4233
Maximum Target Value (dBm)	18	18	18

**Table 11.8: HSDPA**

WCDMA Band V				
Channel		4132	4182	4233
1	Maximum Target Value (dBm)	23	23	23
2	Maximum Target Value (dBm)	23	23	23
3	Maximum Target Value (dBm)	22.5	22.5	22.5
4	Maximum Target Value (dBm)	22.5	22.5	22.5

**Table 11.9: HSUPA**

WCDMA Band V				
Channel		4132	4182	4233
1	Maximum Target Value (dBm)	22.5	22.5	22.5
2	Maximum Target Value (dBm)	21	21	21

3	Maximum Target Value (dBm)	21	21	21
4	Maximum Target Value (dBm)	22	22	22
5	Maximum Target Value (dBm)	22	22	22

**Table 11.12: LTE**

LTE Band2 Sensor off			
RB Size	1	50%	100%
Maximum Target Value (dBm)	23.5	22	22
LTE Band4 Sensor off			
RB Size	1	50%	100%
Maximum Target Value (dBm)	23.5	23	22.5
LTE Band5 Sensor off			
RB Size	1	50%	100%
Maximum Target Value (dBm)	23.5	23	22.5
LTE Band7 Sensor off			
RB Size	1	50%	100%
Maximum Target Value (dBm)	22.5	21.5	21.5
LTE Band2 Sensor on			
RB Size	1	50%	100%
Maximum Target Value (dBm)	13.5	13.5	13.5
LTE Band4 Sensor on			
RB Size	1	50%	100%
Maximum Target Value (dBm)	13.5	13.5	13.5
LTE Band5 Sensor on			
RB Size	1	50%	100%
Maximum Target Value (dBm)	16.5	16	16
LTE Band7 Sensor on			
RB Size	1	50%	100%
Maximum Target Value (dBm)	12	11.5	11.5

**Table 11.13: WiFi**

WiFi 802.11b Sensor off			
Channel	Channel 1	Channel 6	Channel 11
Maximum Target Value (dBm)	15	15	15
WiFi 802.11g Sensor off			
Channel	Channel 1	Channel 6	Channel 11
Maximum Target Value (dBm)	14.5	14.5	14.5
WiFi 802.11n 20M Sensor off			
Channel	Channel 1	Channel 6	Channel 11
Maximum Target Value (dBm)	14.5	14.5	14.5
WiFi 802.11n 40M Sensor off			
Channel	Channel 1	Channel 6	Channel 11
Maximum Target Value (dBm)	14.5	14.5	14
WiFi 802.11b Sensor on			
Channel	Channel 1	Channel 6	Channel 11
Maximum Target Value (dBm)	9.5	9.5	9.5
WiFi 802.11g Sensor on			
Channel	Channel 1	Channel 6	Channel 11
Maximum Target Value (dBm)	8.5	8.5	8
WiFi 802.11n 20M Sensor on			
Channel	Channel 1	Channel 6	Channel 11
Maximum Target Value (dBm)	8.5	8.5	8
WiFi 802.11n 40M Sensor on			
Channel	Channel 1	Channel 6	Channel 11
Maximum Target Value (dBm)	8.5	8.5	8

**Table 11.12: Bluetooth**

Bluetooth 2.1			
Channel	Channel 0	Channel 39	Channel 78
Maximum Target Value (dBm)	3	3	1
Bluetooth 4.0			
Channel	Channel 0	Channel 19	Channel 39
Maximum Target Value (dBm)	-1.5	-1.5	-3

**11.2. WCDMA Measurement result**

**Table 11.16: The conducted Power for WCDMA Sensor off**

Item	band	WCDMA BAND II result(dBm)		
	ARFCN	2712 (1852.4MHz)	2788 (1880.0MHz)	2863 (1907.6MHz)
WCDMA	\	23.31	23.14	23.21
HSDPA	1	22.59	22.41	22.47
	2	22.37	22.21	22.29
	3	22.04	21.91	22
	4	21.96	21.81	21.87
HSUPA	1	21.94	21.81	21.86
	2	20.99	20.75	20.9
	3	20.98	20.89	20.83
	4	21.79	21.59	21.74
	5	21.59	21.49	21.63
Item	band	WCDMA BAND V result(dBm)		
	ARFCN	Channel 4132 (826.4MHz)	Channel 4182 (836.6MHz)	Channel 4233 (846.6MHz)
WCDMA	\	23.33	23.27	23.24
HSDPA	1	22.58	22.53	22.52
	2	22.38	22.35	22.28
	3	22.11	22.04	22.03
	4	22.01	21.97	21.93
HSUPA	1	22.01	21.94	21.86
	2	20.98	20.95	20.87
	3	20.98	21	20.91
	4	21.91	21.77	21.79
	5	21.62	21.6	21.62

**Table 11.16: The conducted Power for WCDMA Sensor on**

Item	band	WCDMA BAND II result(dBm)		
	ARFCN	2712 (1852.4MHz)	2788 (1880.0MHz)	2863 (1907.6MHz)
WCDMA	\	13.91	13.94	13.62
HSDPA	1	13.24	13.18	12.88
	2	13.02	12.98	12.7
	3	12.69	12.68	12.41
	4	12.61	12.58	12.28
HSUPA	1	12.59	12.58	12.27
	2	11.64	11.52	11.31
	3	11.63	11.66	11.24
	4	12.44	12.36	12.15

	5	12.24	12.26	12.04
Item	band	WCDMA BAND V result(dBm)		
	ARFCN	Channel 4132 (826.4MHz)	Channel 4183 (836.6MHz)	Channel 4233 (846.6MHz)
WCDMA	\	17.86	17.88	17.74
HSDPA	1	17.24	17.15	17
	2	17.02	16.95	16.82
	3	16.69	16.65	16.53
	4	16.61	16.55	16.4
HSUPA	1	16.59	16.55	16.39
	2	15.64	15.49	15.43
	3	15.63	15.63	15.36
	4	16.44	16.33	16.27
	5	16.24	16.23	16.16

**11.3. LTE Measurement result**

**Table 11.17: The conducted Power for LTE BAND 2/4/5/7 Sensor off**

Band2						
Bandwidth	Mode	RB Size	RB Offset	Actual output power(dBm)		
				Channel 18625 1852.5MHz	Channel 18900 1880MHz	Channel 19175 1907.5MHz
5MHz	QPSK	1	0	22.71	22.94	22.85
		1	13	22.77	22.76	22.84
		1	24	22.78	22.72	22.80
		12	0	21.80	21.85	21.91
		12	6	21.82	21.80	21.93
		12	13	21.72	21.80	21.86
		25	0	21.74	21.81	21.82
	16QAM	1	0	20.81	20.98	20.70
		1	13	20.84	21.00	20.82
		1	24	20.79	20.95	20.68
		12	0	19.87	20.27	20.11
		12	6	19.96	20.20	19.86
		12	13	19.89	20.22	20.00
		25	0	20.20	20.32	20.24
Bandwidth	Mode	RB Size	RB Offset	Actual output power(dBm)		
				Channel 18650 1855MHz	Channel 18900 1880MHz	Channel 19150 1905MHz
10MHz	QPSK	1	0	22.99	22.43	23.02
		1	25	23.00	22.91	22.94
		1	49	22.72	22.72	22.68
		25	0	21.92	21.77	21.86
		25	13	21.79	21.75	21.91
		25	25	21.91	21.81	21.90
		50	0	21.84	21.83	21.87
	16QAM	1	0	20.46	21.20	21.18
		1	25	21.05	21.21	21.31
		1	49	20.92	21.10	20.88
		25	0	20.27	20.41	20.48
		25	13	20.34	20.42	20.32
		25	25	20.25	20.30	20.02
		50	0	20.19	20.32	20.28
Bandwidth	Mode	RB Size	RB Offset	Actual output power(dBm)		

				Channel 18675 1857.5MHz	Channel 18900 1880MHz	Channel 19125 1902.5MHz
				Actual output power(dBm)		
Bandwidth	Mode	RB Size	RB Offset	Channel 18700 1860MHz	Channel 18900 1880MHz	Channel 19100 1900MHz
15MHz	QPSK	1	0	23.23	22.98	23.17
		1	37	22.88	22.77	22.76
		1	74	22.82	22.91	22.93
		36	0	21.88	21.67	21.87
		36	19	21.94	21.76	21.88
		36	38	21.95	21.64	21.92
		75	0	21.87	21.67	21.91
	16QAM	1	0	21.00	21.21	21.24
		1	37	20.90	21.11	20.85
		1	74	21.02	20.45	21.01
		36	0	19.91	20.26	20.17
		36	19	19.97	20.22	20.19
		36	38	20.05	20.22	20.07
		75	0	20.02	20.31	20.27
20MHz	QPSK	1	0	23.23	23.26	23.24
		1	50	23.02	22.94	23.10
		1	99	22.71	22.86	22.70
		50	0	21.89	21.99	21.91
		50	25	21.90	21.83	21.89
		50	50	21.97	21.87	21.83
		100	0	21.80	21.94	21.87
	16QAM	1	0	20.99	21.23	21.15
		1	50	21.14	21.35	21.49
		1	99	20.92	21.11	20.89
		50	0	20.37	20.22	20.48
		50	25	20.19	20.39	20.53
		50	50	20.21	20.37	20.28
		100	0	20.21	20.33	20.37
Bandwidth	Mode	RB Size	RB Offset	Actual output power(dBm)		
				Channel 18615 1851.5MHz	Channel 18900 1880MHz	Channel 19185 1908.5MHz
3MHz	QPSK	1	0	22.74	22.58	22.83
		1	7	22.58	22.63	22.49
		1	14	22.60	22.66	22.92
		8	0	21.68	21.67	21.94



Bandwidth	Mode	RB Size	RB Offset	Actual output power(dBm)		
				Channel 18607 1850.7MHz	Channel 18900 1880MHz	Channel 19193 1909.3MHz
	16QAM	8	4	21.77	21.64	21.87
		8	7	21.73	21.69	21.94
		15	0	21.77	21.63	21.88
		1	0	20.56	20.99	20.70
		1	7	20.88	21.06	20.89
		1	14	20.73	20.88	20.73
		8	0	20.05	20.44	20.09
		8	4	20.25	20.40	20.01
		8	7	20.41	20.37	20.13
		15	0	20.13	20.31	20.08
1.4MHz	QPSK	1	0	22.59	22.66	22.87
		1	3	22.60	22.67	22.91
		1	5	22.53	22.47	22.95
		3	0	22.66	22.70	22.93
		3	1	22.68	22.73	22.99
		3	3	22.79	22.70	22.95
		6	0	21.61	21.56	21.86
	16QAM	1	0	20.87	20.94	20.97
		1	3	20.85	21.44	20.93
		1	5	20.80	21.42	20.95
		3	0	20.97	21.24	21.02
		3	1	21.09	21.31	21.09
		3	3	21.16	21.40	21.13
		6	0	20.06	20.44	20.07

Band4						
Bandwidth	Mode	RB Size	RB Offset	Actual output power(dBm)		
				Channel 19975 1712.5MHz	Channel 20175 1732.5MHz	Channel 20375 1752.5MHz
5MHz	QPSK	1	0	22.68	23.10	23.30
		1	13	22.79	23.33	23.36
		1	24	22.68	23.25	23.42
		12	0	22.14	22.43	22.65
		12	6	21.96	22.44	22.63
		12	13	21.96	22.46	22.70
		25	0	21.91	22.41	22.41

	16QAM	1	0	20.80	21.09	20.59
		1	13	20.84	21.00	20.75
		1	24	20.70	21.00	20.96
		12	0	19.81	20.41	20.12
		12	6	20.00	20.01	19.94
		12	13	19.99	20.01	19.95
		25	0	19.97	20.19	20.06
Bandwidth	Mode	RB Size	RB Offset	Actual output power(dBm)		
				Channel 20000 1715MHz	Channel 20175 1732.5MHz	Channel 20350 1750MHz
10MHz	QPSK	1	0	22.74	23.15	23.25
		1	25	22.99	23.16	23.17
		1	49	22.82	23.05	23.11
		25	0	21.99	22.36	22.63
		25	13	22.01	22.34	22.62
		25	25	22.02	22.43	22.69
		50	0	22.02	22.38	22.42
	16QAM	1	0	20.90	21.03	21.23
		1	25	20.99	21.39	21.25
		1	49	20.77	21.06	21.02
		25	0	20.13	20.38	20.26
		25	13	20.10	20.31	20.18
		25	25	19.87	20.18	20.08
		50	0	19.91	20.32	20.31
Bandwidth	Mode	RB Size	RB Offset	Actual output power(dBm)		
				Channel 20025 1717.5MHz	Channel 20175 1732.5MHz	Channel 20325 1747.5MHz
15MHz	QPSK	1	0	22.97	22.97	23.40
		1	38	22.82	23.32	23.35
		1	74	22.88	23.17	23.33
		36	0	22.09	22.43	22.61
		36	18	22.02	22.40	22.52
		36	39	22.11	22.42	22.51
		75	0	22.13	22.35	22.28
	16QAM	1	0	21.01	21.17	21.22
		1	38	20.98	21.11	21.11
		1	74	20.88	21.09	20.94
		36	0	20.33	20.28	20.38
		36	18	20.24	20.40	20.27
		36	39	20.17	20.41	20.14
		75	0	20.25	20.45	20.35

Bandwidth	Mode	RB Size	RB Offset	Actual output power(dBm)		
				Channel 20050 1720MHz	Channel 20175 1732.5MHz	Channel 20300 1745MHz
20MHz	QPSK	1	0	23.36	23.45	23.41
		1	50	23.10	23.34	23.23
		1	99	23.12	23.20	23.40
		50	0	22.73	22.76	22.72
		50	25	22.11	22.38	22.53
		50	50	22.16	22.41	22.57
		100	0	22.35	22.45	22.37
	16QAM	1	0	20.96	20.37	21.44
		1	50	21.13	21.38	21.42
		1	99	20.93	21.02	20.96
		50	0	19.99	20.31	20.31
		50	25	20.10	20.37	20.26
		50	50	20.20	20.07	20.22
		100	0	20.18	20.19	20.34
Bandwidth	Mode	RB Size	RB Offset	Actual output power(dBm)		
				Channel 19965 1711.5MHz	Channel 20175 1732.5MHz	Channel 20385 1753.5MHz
3MHz	QPSK	1	0	22.74	23.24	23.42
		1	8	22.66	23.32	23.39
		1	14	22.88	23.26	23.37
		8	0	22.01	22.43	22.59
		8	4	22.08	22.30	22.48
		8	7	22.05	22.51	22.44
		15	0	22.03	22.35	22.31
	16QAM	1	0	20.92	20.97	20.85
		1	8	20.78	21.42	20.79
		1	15	20.92	21.42	20.83
		8	0	20.07	20.26	19.97
		8	4	20.11	20.09	20.08
		8	7	20.10	20.42	20.18
		15	0	19.99	20.31	20.00
Bandwidth	Mode	RB Size	RB Offset	Actual output power(dBm)		
				Channel 19957 1710.7MHz	Channel 20175 1732.5MHz	Channel 20393 1754.3MHz
1.4MHz	QPSK	1	0	22.90	23.10	23.36
		1	2	22.91	23.07	23.28

		1	5	22.79	23.03	23.26
		3	0	22.37	22.38	22.35
		3	1	22.39	22.36	22.34
		3	2	22.35	22.38	22.32
		6	0	22.10	22.25	22.30
	16QAM	1	0	20.94	21.24	20.92
		1	2	20.89	21.58	20.81
		1	5	20.93	21.00	20.82
		3	0	21.14	21.25	21.10
		3	1	21.11	21.44	21.15
		3	2	21.18	21.24	21.21
		6	0	20.03	20.30	20.08

Band5						
Bandwidth	Mode	RB Size	RB Offset	Actual output power(dBm)		
				Channel 20425 826.5MHz	Channel 20525 836.5MHz	Channel 20625 846.5MHz
5MHz	QPSK	1	0	22.77	23.30	22.91
		1	12	23.21	23.28	22.75
		1	24	23.19	23.13	22.73
		12	0	22.05	22.60	21.80
		12	6	22.04	22.47	21.85
		12	13	22.18	22.40	21.68
		25	0	22.02	22.44	21.82
	16QAM	1	0	21.8	22.36	21.93
		1	12	22.19	22.36	21.64
		1	24	22.18	22.06	21.53
		12	0	21.11	21.55	20.55
		12	6	20.99	21.54	20.92
		12	13	21.09	21.43	20.6
		25	0	20.91	21.48	20.77
Bandwidth	Mode	RB Size	RB Offset	Actual output power(dBm)		
				Channel 20450 829MHz	Channel 20525 836.5MHz	Channel 20600 844MHz
10MHz	QPSK	1	0	23.26	23.44	23.30
		1	25	23.40	23.33	23.08
		1	49	23.28	22.89	22.47
		25	0	22.46	22.70	22.45
		25	13	22.35	22.43	21.96
		25	25	22.60	22.31	21.81
		50	0	22.42	22.49	22.03
	16QAM	1	0	22.31	22.41	22.32
		1	25	22.39	22.4	21.96
		1	49	22.27	21.83	21.27
		25	0	21.13	21.62	20.55
		25	13	21.28	21.49	21.03
		25	25	21.52	21.33	20.73
		50	0	21.32	21.45	20.91
Bandwidth	Mode	RB Size	RB Offset	Channel 20415 825.5MHz		
				Channel 20415 825.5MHz	Channel 20525 836.5MHz	Channel 20635 847.5MHz
3MHz	QPSK	1	0	22.59	23.22	22.50

		1	7	22.72	23.17	22.61
		1	14	22.79	23.13	22.38
		8	0	21.89	22.66	21.99
		8	4	22.03	22.52	21.76
		8	7	22.03	22.35	21.70
		15	0	22.09	22.40	21.67
	16QAM	1	0	21.59	22.21	21.52
		1	7	21.7	22.18	21.59
		1	14	21.68	22.06	21.25
		8	0	20.95	21.58	21
		8	4	20.96	21.49	20.83
		8	7	21.05	21.37	20.58
		15	0	20.99	21.56	20.65
Bandwidth	Mode	RB Size	RB Offset	Actual output power(dBm)		
				Channel 20407 824.7MHz	Channel 20525 836.5MHz	Channel 20643 848.3MHz
1.4MHz	QPSK	1	0	22.69	23.31	22.41
		1	2	22.87	23.20	22.54
		1	5	22.71	23.09	22.42
		3	0	22.10	22.52	22.69
		3	2	22.06	22.46	22.67
		3	3	22.16	22.58	22.67
		6	0	21.86	22.48	21.66
	16QAM	1	0	21.72	21.90	21.96
		1	2	21.76	21.91	22.06
		1	5	21.74	21.60	21.71
		3	0	21.80	21.71	21.89
		3	2	21.88	21.83	21.91
		3	3	22.06	21.92	22.06
		6	0	20.90	20.83	20.93

Band7						
Bandwidth	Mode	RB Size	RB Offset	Actual output power(dBm)		
				Channel 20775 2502.5MHz	Channel 21100 2535MHz	Channel 21425 2567.5MHz
5MHz	QPSK	1	0	21.86	21.6	21.97
		1	13	21.94	21.76	22.11
		1	24	21.68	21.7	22.03
		12	0	20.85	20.83	21.24
		12	6	20.82	20.75	21.22
		12	13	20.69	20.82	21.18
		25	0	20.83	20.74	21.24
	16QAM	1	0	20.86	20.59	20.99
		1	13	20.92	20.77	21.09
		1	24	20.57	20.63	20.9
		12	0	19.91	19.75	20.25
		12	6	19.75	19.72	20.29
		12	13	19.71	19.84	20.06
		25	0	19.73	19.7	20.22
Bandwidth	Mode	RB Size	RB Offset	Actual output power(dBm)		
				Channel 20800 2505MHz	Channel 21100 2535MHz	Channel 21400 2565MHz
10MHz	QPSK	1	0	22.01	21.83	22.05
		1	25	21.89	21.89	22.23
		1	49	21.82	21.85	22.1
		25	0	20.81	20.9	20.81
		25	13	20.81	20.82	20.8
		25	25	20.98	20.86	21.16
		50	0	20.73	20.82	21.12
	16QAM	1	0	20.94	20.82	21.07
		1	25	20.87	20.9	21.21
		1	49	20.83	20.81	21.02
		25	0	19.87	19.82	19.82
		25	13	19.74	19.79	19.79
		25	25	20	19.89	20.04
		50	0	19.64	19.75	20.1
Bandwidth	Mode	RB Size	RB Offset	Actual output power(dBm)		
				Channel 20825 2507.5MHz	Channel 21100 2535MHz	Channel 21375 2562.5MHz
15MHz	QPSK	1	0	21.68	21.76	21.74

		1	38	21.72	21.83	22.03
		1	74	22.06	21.86	22.16
		36	0	20.86	20.87	20.79
		36	18	20.92	20.78	20.94
		36	39	20.89	20.91	21.25
		75	0	20.86	20.85	20.95
	16QAM	1	0	20.68	20.75	20.76
		1	38	20.7	20.84	21.01
		1	74	20.95	20.79	21.03
		36	0	19.92	19.79	19.8
		36	18	19.85	19.75	20.01
		36	39	19.91	19.93	20.13
		75	0	19.76	19.81	19.93
	Bandwidth	Mode	RB Size	RB Offset	Actual output power(dBm)	
Channel 20850 2510MHz					Channel 21100 2535MHz	Channel 21350 2560MHz
20MHz	QPSK	1	0	22.21	22.25	22.15
		1	50	21.91	21.78	21.94
		1	99	21.97	21.74	22.04
		50	0	21.48	21.49	21.45
		50	25	21.31	21.36	21.24
		50	50	20.82	21.27	21.23
		100	0	20.73	21.12	21.02
	16QAM	1	0	21.33	21.21	21.17
		1	50	20.89	20.85	20.82
		1	99	20.96	20.67	20.84
		50	0	20.54	20.41	20.21
		50	25	20.24	20.43	20.31
		50	50	19.73	20.29	20.15
		100	0	19.63	20.08	20



**Table 11.17: The conducted Power for LTE BAND 2/4/5/7 Sensor on**

Band2						
Bandwidth	Mode	RB Size	RB Offset	Actual output power(dBm)		
				Channel 18625 1852.5MHz	Channel 18900 1880MHz	Channel 19175 1907.5MHz
5MHz	QPSK	1	0	12.77	12.91	12.25
		1	13	12.94	13.02	12.64
		1	24	12.86	12.99	11.59
		12	0	12.92	13.01	12.58
		12	6	12.95	13.08	12.67
		12	13	12.92	13.05	12.23
		25	0	12.87	13.00	12.48
	16QAM	1	0	12.64	12.81	12.56
		1	13	13.29	13.30	12.89
		1	24	12.78	12.75	11.85
		12	0	12.95	12.96	12.67
		12	6	13.03	13.07	12.72
		12	13	12.90	13.00	12.29
		25	0	12.97	13.12	12.53
Bandwidth	Mode	RB Size	RB Offset	Actual output power(dBm)		
				Channel 18650 1855MHz	Channel 18900 1880MHz	Channel 19150 1905MHz
10MHz	QPSK	1	0	13.23	13.31	13.19
		1	25	12.74	12.93	12.74
		1	49	12.81	12.96	11.74
		25	0	12.96	13.11	13.00
		25	13	13.00	13.08	12.94
		25	25	13.04	13.16	12.54
		50	0	12.90	13.11	12.74
	16QAM	1	0	12.64	12.84	12.45
		1	25	12.91	13.16	12.91
		1	49	12.78	12.78	11.48
		25	0	12.87	13.07	12.98
		25	13	12.92	13.05	12.89
		25	25	12.96	13.08	12.51
		50	0	12.91	13.01	12.69
Bandwidth	Mode	RB Size	RB Offset	Actual output power(dBm)		
				Channel 18675	Channel 18900	Channel 19125

Bandwidth	Mode	RB Size	RB Offset	1857.5MHz	1880MHz	1902.5MHz	
				Channel 18700 1860MHz	Channel 18900 1880MHz	Channel 19100 1900MHz	
15MHz	QPSK	1	0	12.78	12.88	12.75	
		1	37	13.30	13.31	13.25	
		1	74	12.66	12.94	11.13	
		36	0	12.91	13.04	12.77	
		36	19	13.06	13.03	13.00	
		36	38	12.88	13.07	12.62	
		75	0	12.94	13.02	12.64	
	16QAM	1	0	12.79	12.96	13.14	
		1	37	13.11	13.00	13.25	
		1	74	12.83	12.88	12.54	
		36	0	12.94	13.04	13.09	
		36	19	12.97	12.98	13.14	
		36	38	12.80	13.01	12.53	
		75	0	12.87	13.01	12.59	
20MHz	QPSK	1	0	13.31	13.32	13.22	
		1	50	12.91	13.01	13.04	
		1	99	12.79	12.85	10.99	
		50	0	13.07	13.18	13.11	
		50	25	12.98	13.02	13.05	
		50	50	12.85	12.98	12.45	
		100	0	13.03	13.12	12.88	
	16QAM	1	0	12.64	12.91	12.33	
		1	50	13.17	13.15	13.16	
		1	99	12.71	12.64	11.33	
		50	0	12.94	12.98	12.89	
		50	25	13.09	13.06	13.14	
		50	50	12.88	12.99	12.58	
		100	0	12.86	13.01	12.73	
3MHz	QPSK	1	0	12.59	12.83	12.49	
		1	7	12.96	13.08	12.43	
		1	14	12.79	12.92	11.95	
		8	0	12.92	13.10	12.54	
		8	4	12.93	13.10	12.46	
					Actual output power(dBm)		
					Channel 18615 1851.5MHz	Channel 18900 1880MHz	Channel 19185 1908.5MHz

Bandwidth	Mode	RB Size	RB Offset	Actual output power(dBm)			
				Channel 18607 1850.7MHz	Channel 18900 1880MHz	Channel 19193 1909.3MHz	
1.4MHz	16QAM	8	7	12.89	13.07	12.27	
		15	0	12.94	13.02	12.39	
		1	0	12.93	13.18	12.76	
		1	7	13.24	13.15	12.75	
		1	14	13.19	13.04	12.24	
		8	0	13.02	13.14	12.64	
		8	4	13.06	13.16	12.57	
		8	7	13.04	13.16	12.37	
	15	0	12.95	13.02	12.46		
	1.4MHz	QPSK	1	0	12.94	13.09	12.76
			1	3	13.14	13.28	12.85
			1	5	13.21	13.31	12.83
			3	0	13.07	13.16	12.56
			3	1	12.85	13.17	12.60
			3	3	12.88	13.11	12.61
			6	0	12.94	13.11	12.68
16QAM		1	0	12.59	12.83	12.50	
		1	3	12.71	13.08	12.54	
		1	5	12.91	13.09	12.51	
		3	0	12.87	13.01	12.50	
		3	1	12.85	13.02	12.54	
		3	3	12.80	13.07	12.54	
		6	0	12.78	13.05	12.55	

Band4						
Bandwidth	Mode	RB Size	RB Offset	Actual output power(dBm)		
				Channel 19975 1712.5MHz	Channel 20175 1732.5MHz	Channel 20375 1752.5MHz
5MHz	QPSK	1	0	13.06	13.31	13.11
		1	13	12.73	13.16	12.78
		1	24	11.99	13.01	12.22
		12	0	12.48	13.18	12.68
		12	6	12.71	13.20	12.69
		12	13	12.41	13.17	12.56
		25	0	12.52	13.17	12.61
		16QAM	1	0	12.33	12.89

		1	13	12.83	13.02	12.27
		1	24	12.28	12.88	12.48
		12	0	12.53	13.26	12.60
		12	6	12.71	13.26	12.73
		12	13	12.41	13.23	12.56
		25	0	12.50	13.19	12.67
Bandwidth	Mode	RB Size	RB Offset	Actual output power(dBm)		
				Channel 20000 1715MHz	Channel 20175 1732.5MHz	Channel 20350 1750MHz
10MHz	QPSK	1	0	12.10	12.83	12.28
		1	25	12.92	13.28	13.12
		1	49	12.29	12.89	12.18
		25	0	12.44	13.17	12.50
		25	13	12.56	13.26	12.71
		25	25	12.37	13.25	12.49
		50	0	12.36	13.33	12.64
	16QAM	1	0	12.64	12.78	12.99
		1	25	12.63	13.07	13.13
		1	49	12.04	12.83	12.91
		25	0	12.45	13.24	13.14
		25	13	12.57	13.21	12.79
		25	25	12.40	13.20	12.47
		50	0	12.38	13.19	12.70
Bandwidth	Mode	RB Size	RB Offset	Actual output power(dBm)		
				Channel 20025 1717.5MHz	Channel 20175 1732.5MHz	Channel 20325 1747.5MHz
15MHz	QPSK	1	0	12.71	12.95	13.18
		1	38	13.16	13.20	13.18
		1	74	11.70	12.72	12.79
		36	0	12.11	13.15	13.31
		36	18	12.72	13.27	13.11
		36	39	12.50	13.04	13.10
		75	0	12.35	13.08	13.14
	16QAM	1	0	12.84	13.21	13.13
		1	38	12.85	13.04	13.04
		1	74	11.46	12.99	13.01
		36	0	12.11	13.14	13.38
		36	18	12.71	13.19	13.06
		36	39	12.50	13.11	13.01
		75	0	12.36	13.14	13.15
Bandwidth	Mode	RB Size	RB Offset	Actual output power(dBm)		

				Channel 20050 1720MHz	Channel 20175 1732.5MHz	Channel 20300 1745MHz
				Channel 19965 1711.5MHz	Channel 20175 1732.5MHz	Channel 20385 1753.5MHz
20MHz	QPSK	1	0	13.28	13.41	13.31
		1	50	12.80	13.14	13.05
		1	99	11.72	12.96	12.99
		50	0	13.10	13.28	13.10
		50	25	12.59	13.22	13.03
		50	50	12.38	13.17	12.95
		100	0	13.10	13.37	13.07
	16QAM	1	0	12.76	12.96	12.99
		1	50	13.10	13.32	13.00
		1	99	12.01	12.12	11.69
		50	0	12.23	13.14	12.33
		50	25	12.61	13.18	12.69
		50	50	12.39	13.14	12.29
		100	0	12.33	13.25	12.31
Bandwidth	Mode	RB Size	RB Offset	Actual output power(dBm)		
				Channel 19965 1711.5MHz	Channel 20175 1732.5MHz	Channel 20385 1753.5MHz
3MHz	QPSK	1	0	12.42	13.19	12.50
		1	8	12.70	13.07	12.90
		1	14	12.47	13.05	12.63
		8	0	12.66	13.18	12.68
		8	4	12.70	13.20	12.80
		8	7	12.58	13.23	12.77
		15	0	12.61	13.18	12.72
	16QAM	1	0	12.67	13.27	12.78
		1	8	13.03	13.36	13.21
		1	15	12.74	13.32	12.90
		8	0	12.76	13.39	12.81
		8	4	12.81	13.45	12.85
		8	7	12.68	13.47	12.82
		15	0	12.68	13.33	12.73
Bandwidth	Mode	RB Size	RB Offset	Actual output power(dBm)		
				Channel 19957 1710.7MHz	Channel 20175 1732.5MHz	Channel 20393 1754.3MHz
1.4MHz	QPSK	1	0	12.71	13.23	12.80
		1	2	12.86	13.30	13.05
		1	5	13.04	13.31	13.07
		3	0	12.49	13.09	12.56

16QAM	3	1	12.58	13.11	12.76
	3	2	12.75	13.12	12.78
	6	0	12.64	13.18	12.82
	1	0	12.43	13.05	12.50
	1	2	12.54	13.08	12.67
	1	5	12.71	13.10	12.70
	3	0	12.47	13.15	12.52
	3	1	12.55	13.14	12.68
	3	2	12.68	13.14	12.70
	6	0	12.54	13.15	12.68

Band5						
Bandwidth	Mode	RB Size	RB Offset	Actual output power(dBm)		
				Channel 20425 826.5MHz	Channel 20525 836.5MHz	Channel 20625 846.5MHz
5MHz	QPSK	1	0	15.65	16.27	15.8
		1	12	16.09	16.25	15.64
		1	24	16.07	16.1	15.62
		12	0	14.93	15.57	14.69
		12	6	14.92	15.44	14.74
		12	13	15.06	15.37	14.57
		25	0	14.9	15.51	14.71
	16QAM	1	0	14.68	15.33	14.82
		1	12	15.07	15.33	14.53
		1	24	15.06	15.03	14.42
		12	0	13.99	14.52	13.44
		12	6	13.87	14.51	13.81
		12	13	13.97	14.4	13.49
		25	0	13.79	14.45	13.66
Bandwidth	Mode	RB Size	RB Offset	Actual output power(dBm)		
				Channel 20450 829MHz	Channel 20525 836.5MHz	Channel 20600 844MHz
10MHz	QPSK	1	0	16.14	16.41	16.19
		1	25	16.28	16.3	15.97
		1	49	16.16	15.86	15.36
		25	0	15.44	15.67	15.49
		25	13	15.23	15.4	14.85
		25	25	15.48	15.28	14.7
		50	0	15.3	15.46	14.82

		1	0	15.19	15.38	15.21
		1	25	15.27	15.37	14.85
		1	49	15.15	14.8	14.16
	16QAM	25	0	14.01	14.59	13.44
		25	13	14.16	14.46	13.92
		25	25	14.4	14.3	13.62
		50	0	14.2	14.42	13.8
Bandwidth	Mode	RB Size	RB Offset	Channel 20415 825.5MHz		
				Channel 20415 825.5MHz	Channel 20525 836.5MHz	Channel 20635 847.5MHz
3MHz	QPSK	1	0	15.47	16.19	15.39
		1	7	15.6	16.14	15.5
		1	14	15.67	16.1	15.27
		8	0	14.77	15.63	14.88
		8	4	14.91	15.49	14.65
		8	7	14.91	15.32	14.59
		15	0	14.97	15.57	14.56
	16QAM	1	0	14.47	15.18	14.41
		1	7	14.58	15.15	14.48
		1	14	14.56	15.03	14.14
		8	0	13.83	14.55	13.89
		8	4	13.84	14.46	13.72
		8	7	13.93	14.34	13.47
		15	0	13.87	14.53	13.54
Bandwidth	Mode	RB Size	RB Offset	Actual output power(dBm)		
				Channel 20407 824.7MHz	Channel 20525 836.5MHz	Channel 20643 848.3MHz
1.4MHz	QPSK	1	0	15.58	16.18	15.28
		1	2	15.75	16.17	15.43
		1	5	15.59	16.06	15.31
		3	0	14.98	15.49	15.58
		3	2	14.94	15.43	15.76
		3	3	15.04	15.55	15.56
		6	0	14.74	15.45	14.55
	16QAM	1	0	14.6	14.87	14.85
		1	2	14.64	14.88	14.95
		1	5	14.62	14.57	14.6
		3	0	14.68	14.68	14.78
		3	2	14.76	14.8	14.8
		3	3	14.94	14.89	14.95
		6	0	13.78	13.8	13.82

Band7						
Bandwidth	Mode	RB Size	RB Offset	Actual output power(dBm)		
				Channel 20775 2502.5MHz	Channel 21100 2535MHz	Channel 21425 2567.5MHz
5MHz	QPSK	1	0	11.04	11.01	11.4
		1	13	11.63	11.61	11.61
		1	24	10.75	10.85	11.45
		12	0	11.45	11.38	11.45
		12	6	11.48	11.41	11.42
		12	13	11.38	11.38	11.42
		25	0	11.39	11.37	11.31
	16QAM	1	0	11.02	10.51	11.32
		1	13	11.32	11.30	11.32
		1	24	10.71	10.82	11.35
		12	0	11.45	11.32	11.35
		12	6	11.32	11.31	11.37
		12	13	11.35	11.34	11.32
		25	0	11.42	11.31	11.31
Bandwidth	Mode	RB Size	RB Offset	Actual output power(dBm)		
				Channel 20800 2505MHz	Channel 21100 2535MHz	Channel 21400 2565MHz
10MHz	QPSK	1	0	11.02	11.24	11.07
		1	25	11.44	11.42	11.47
		1	49	10.65	10.8	11.34
		25	0	11.47	11.34	11.37
		25	13	11.32	11.41	11.38
		25	25	11.24	11.36	11.32
		50	0	11.26	11.35	11.33
	16QAM	1	0	11.01	11.21	11.09
		1	25	11.31	11.22	11.32
		1	49	10.61	10.56	11.32
		25	0	11.42	11.32	11.31
		25	13	11.42	11.41	11.48
		25	25	11.14	11.36	11.32
		50	0	11.24	11.32	11.33
Bandwidth	Mode	RB Size	RB Offset	Actual output power(dBm)		
				Channel 20825 2507.5MHz	Channel 21100 2535MHz	Channel 21375 2562.5MHz
15MHz	QPSK	1	0	10.73	10.65	10.72
		1	38	11.36	11.57	11.56



		1	74	10.62	10.74	11.29
		36	0	11.33	11.39	11.42
		36	18	11.38	11.31	11.32
		36	39	11.28	11.3	11.25
		75	0	11.31	11.3	11.39
	16QAM	1	0	10.53	10.55	10.62
		1	38	11.32	11.51	11.56
		1	74	10.42	10.34	11.22
		36	0	11.32	11.33	11.42
		36	18	11.42	11.37	11.32
		36	39	11.22	11.21	11.35
		75	0	11.24	11.21	11.39
	Bandwidth	Mode	RB Size	RB Offset	Actual output power(dBm)	
Channel 20850 2510MHz					Channel 21100 2535MHz	Channel 21350 2560MHz
20MHz	QPSK	1	0	11.52	11.64	11.57
		1	50	11.34	11.07	11.47
		1	99	10.65	10.8	11.34
		50	0	11.23	11.48	11.43
		50	25	11.54	11.4	11.51
		50	50	11.34	11.39	11.32
		100	0	11.36	11.42	11.37
	16QAM	1	0	11.51	11.62	11.53
		1	50	11.31	11.02	11.42
		1	99	10.63	10.77	11.32
		50	0	11.22	11.43	11.42
		50	25	11.52	11.38	11.41
		50	50	11.34	11.41	11.42
		100	0	11.26	11.41	11.27

**11.4. Wi-Fi and BT Measurement result**

**Table 11.18: The conducted power for Bluetooth**

<b>GFSK</b>			
Channel	Ch0 (2402 MHz)	Ch39 (2441MHz)	CH78 (2480MHz)
Conducted Output Power (dBm)	2.031	2.932	0.459
<b><math>\pi/4</math> DQPSK</b>			
Channel	Ch0 (2402 MHz)	Ch39 (2441MHz)	CH78 (2480MHz)
Conducted Output Power (dBm)	1.444	2.397	-0.09
<b>8DPSK</b>			
Channel	Ch0 (2402 MHz)	Ch39 (2441MHz)	CH78 (2480MHz)
Conducted Output Power (dBm)	1.657	2.604	0.139

**Table 11.19: The conducted power for Bluetooth 4.0**

<b>GFSK</b>			
Channel	Ch0 2402 MHz	Ch19 2440 MHz	CH39 2480 MHz
Conducted Output Power (dBm)	-2.45	-1.901	-4.754

**NOTE:** According to KDB447498 D01 BT standalone SAR are not required, because maximum average output power is less than 10mW.

According to RSS 102 issue5 section 2.5.1 Exemption Limits for Routine Evaluation – SAR Evaluation, BT standalone SAR are not required, because maximum average output power is less than 4mW.

Frequency (MHz)	Exemption Limits (mW)				
	At separation distance of $\leq 5$ mm	At separation distance of 10 mm	At separation distance of 15 mm	At separation distance of 20 mm	At separation distance of 25 mm
$\leq 300$	71 mW	101 mW	132 mW	162 mW	193 mW
450	52 mW	70 mW	88 mW	106 mW	123 mW
835	17 mW	30 mW	42 mW	55 mW	67 mW
1900	7 mW	10 mW	18 mW	34 mW	60 mW
2450	4 mW	7 mW	15 mW	30 mW	52 mW
3500	2 mW	6 mW	16 mW	32 mW	55 mW
5800	1 mW	6 mW	15 mW	27 mW	41 mW

When the standalone SAR test exclusion is applied to an antenna that transmits simultaneously with other antennas, the standalone SAR must be estimated according to the following to determine simultaneous transmission SAR test exclusion:

(max. power of channel, including tune-up tolerance, mW)/(min. test separation distance, mm)]·[ $\sqrt{f(\text{GHz})/x}$ ] W/kg for test separation distances  $\leq 50$  mm;  
where  $x = 7.5$  for 1-g SAR, and  $x = 18.75$  for 10-g SAR.

SAR body value of BT is 0.083 W/Kg.

**The default power measurement procedures are:**

- a) Power must be measured at each transmit antenna port according to the DSSS and OFDM transmission configurations in each standalone and aggregated frequency band.
- b) Power measurement is required for the transmission mode configuration with the highest maximum output power specified for production units.
  - 1) When the same highest maximum output power specification applies to multiple transmission modes, the largest channel bandwidth configuration with the lowest order modulation and lowest data rate is measured.
  - 2) When the same highest maximum output power is specified for multiple largest channel bandwidth configurations with the same lowest order modulation or lowest order modulation and lowest data rate, power measurement is required for all equivalent 802.11 configurations with the same maximum output power.
- c) For each transmission mode configuration, power must be measured for the highest and lowest channels; and at the mid-band channel(s) when there are at least 3 channels. For configurations with multiple mid-band channels, due to an even number of channels, both channels should be measured.

During WLAN SAR testing EUT is configured with the WLAN continuous TX tool, and the transmission duty factor was monitored on the spectrum analyzer with zero-span setting.

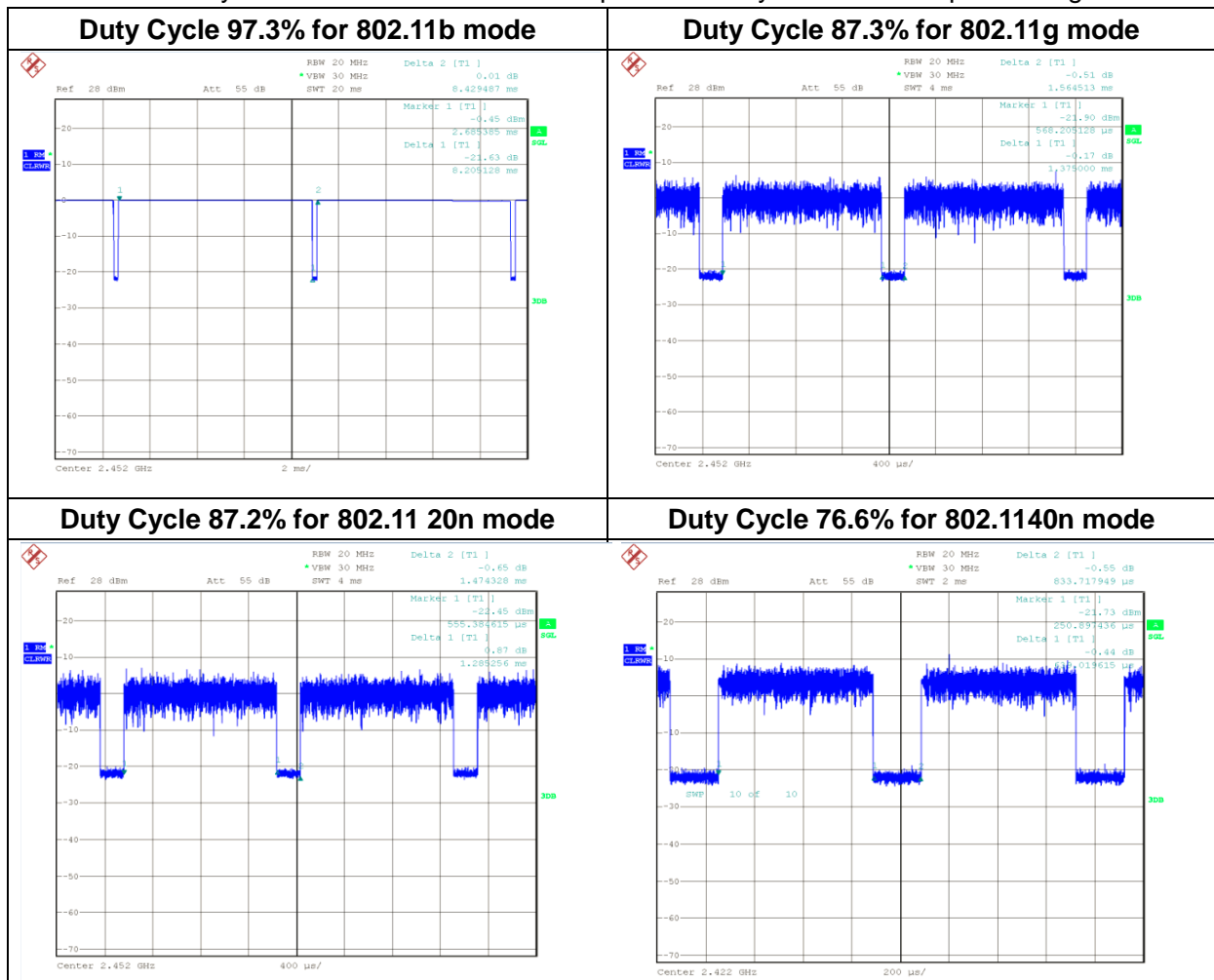

**Table 11.19: The average conducted power for WiFi**

Mode	Channel	Frequency	Average power(dBm)
802.11 b Sensor off	1	2412 MHZ	14.77
	6	2437 MHZ	14.63
	11	2462 MHZ	13.47
802.11 g Sensor off	1	2412 MHZ	14.51
	6	2437 MHZ	13.97
	11	2462 MHZ	13.22
802.11 n 20M Sensor off	1	2412 MHZ	14.05
	6	2437 MHZ	13.82
	11	2462 MHZ	14.41
802.11 n 40M Sensor off	3	2422 MHZ	14.18
	6	2437 MHZ	14.03
	9	2452 MHZ	13.53
802.11 b Sensor on	1	2412 MHZ	9.31
	6	2437 MHZ	9.25
	11	2462 MHZ	8.29
802.11 g Sensor on	1	2412 MHZ	8.41
	6	2437 MHZ	8.29
	11	2462 MHZ	7.51
802.11 n 20M Sensor on	1	2412 MHZ	8.39
	6	2437 MHZ	8.27
	11	2462 MHZ	7.39
802.11 n 40M Sensor on	3	2422 MHZ	8.37
	6	2437 MHZ	8.14
	9	2452 MHZ	7.80

**2.4 GHz 802.11g/n OFDM SAR Test Exclusion Requirements**

When SAR measurement is required for 2.4 GHz 802.11g/n OFDM configurations, the measurement and test reduction procedures for OFDM are applied. SAR is not required for the following 2.4 GHz OFDM conditions.

- a) When KDB Publication 447498 D01 SAR test exclusion applies to the OFDM configuration.
- b) When the highest *reported* SAR for DSSS is adjusted by the ratio of OFDM to DSSS specified maximum output power and the adjusted SAR is  $\leq 1.2$  W/kg.

## 12. Simultaneous TX SAR Considerations

### 12.1. Introduction

The following procedures adopted from “FCC SAR Considerations for Cell Phones with Multiple Transmitters” are applicable to handsets with built-in unlicensed transmitters such as 802.11 a/b/g and Bluetooth devices which may simultaneously transmit with the licensed transmitter.

For this device, the BT and Wi-Fi 2.4GHz can transmit simultaneous with other transmitters.

Wi-Fi 5GHz not support hotspot mode, so simultaneously transmit not required.

### 12.2. Transmit Antenna Separation Distances

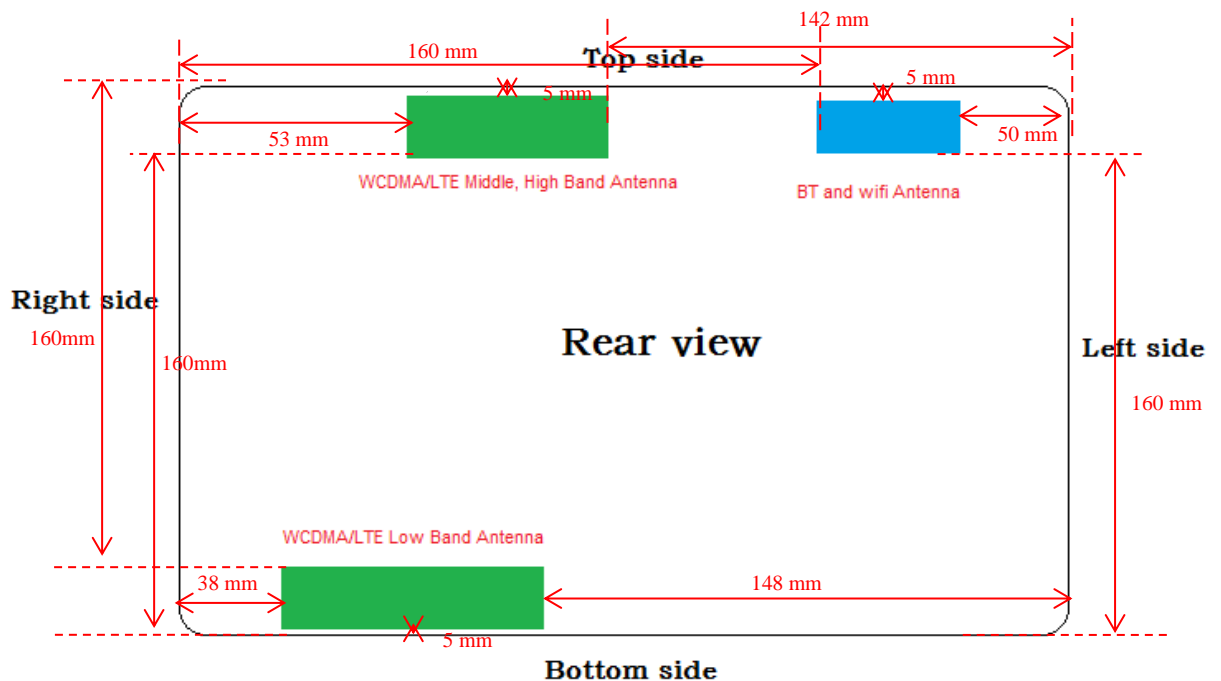

**Picture 12.1 Antenna Locations**

### 12.3. Standalone SAR Test Exclusion Considerations

Standalone 1-g head or body SAR evaluation by measurement or numerical simulation is not required when the corresponding SAR Exclusion Threshold condition, listed below, is satisfied.

The 1-g SAR test exclusion threshold for 100 MHz to 6 GHz at test separation distances  $\leq 50$  mm are determined by:

$$\left[ \frac{\text{(max. power of channel, including tune-up tolerance, mW)}}{\text{(min. test separation distance, mm)}} \cdot \sqrt{f(\text{GHz})} \right] \leq 3.0$$
 for 1-g SAR, where

- $f(\text{GHz})$  is the RF channel transmit frequency in GHz
- Power and distance are rounded to the nearest mW and mm before calculation
- The result is rounded to one decimal place for comparison

According to the KDB447498 appendix A, the SAR test exclusion threshold for 2450MHz at 5mm test separation distances is 10mW.

$$\frac{\text{(max. power of channel, including tune-up tolerance, mW)}}{\text{(min. test separation distance, mm)}} \cdot \sqrt{\text{Frequency (GHz)}} \leq 3.0$$

Based on the above equation, Bluetooth SAR was not required:

Evaluation=0.626 < 3.0

Based on the above equation, WiFi SAR was required:

Evaluation=9.92 > 3.0

## 12.4. SAR Measurement Positions

The following SAR test exclusion Thresholds based on KDB 447498 D01 General RF Exposure Guidance v06 4.3.1

Exposure Position	Wireless Interface	WCDMA		LTE				WLAN
		Band2	Band5	Band2	Band4	Band5	Band7	802.11 b
Exposure Position	Maximum power	23.5	23.5	23.5	23.5	23.5	22.5	15
	Maximum rated power(mW)	223.87	223.87	223.87	223.87	223.87	117.83	31.62
Rear view	Antenna to user (mm)	5	5	5	5	5	5	5
	SAR exclusion threshold	10.88	16.27	10.88	11.18	16.27	9.03	9.58
	SAR testing required?	<b>Yes</b>	<b>Yes</b>	<b>Yes</b>	<b>Yes</b>	<b>Yes</b>	<b>Yes</b>	<b>Yes</b>
Top	Antenna to user (mm)	5	160	5	5	160	5	5
	SAR exclusion threshold	10.88	787.33	10.88	11.18	787.33	9.03	9.58
	SAR testing required?	<b>Yes</b>	<b>No</b>	<b>Yes</b>	<b>Yes</b>	<b>No</b>	<b>Yes</b>	<b>Yes</b>
Left	Antenna to user (mm)	142	148	142	142	148	142	50
	SAR exclusion threshold	1029.00	719.33	1029.00	1029.00	719.33	1029.00	95.83
	SAR testing required?	<b>No</b>	<b>No</b>	<b>No</b>	<b>No</b>	<b>No</b>	<b>No</b>	<b>No</b>
Bottom	Antenna to user (mm)	160	5	160	160	5	160	160
	SAR exclusion threshold	1209.00	16.27	1209.00	1209.00	16.27	1209.00	1196
	SAR testing required?	<b>No</b>	<b>Yes</b>	<b>No</b>	<b>No</b>	<b>Yes</b>	<b>No</b>	<b>No</b>
Right	Antenna to user (mm)	53	38	53	53	38	53	160
	SAR exclusion threshold	139.00	123.65	139.00	139.00	123.65	139.00	1196
	SAR testing required?	<b>Yes</b>	<b>Yes</b>	<b>Yes</b>	<b>Yes</b>	<b>Yes</b>	<b>Yes</b>	<b>No</b>



## 13. Power Reduction by Proximity Sensing

A proximity sensor for power reduction is implemented in this device to address RF exposure compliance when the cellular antenna is positioned close to the user's body. The sensor's mechanical structure is designed to fit within the enclosure design used in this device and also extended around the edge and top of the antenna element in order to optimize sensitivity in these orientations. This design combines the antenna printed directly on a plastic part and proximity sensor FPC (Flexible Printed Circuit) bonded together into one piece. According to KDB 616217 D04 SAR for laptop and tablets v01r02 6)

### 13.1. Procedures for determining proximity sensor triggering distances

The following procedures should be applied to determine proximity sensor triggering distances for the back surface and individual edges of a tablet. Conducted power is monitored qualitatively to identify the general triggering characteristics and recorded quantitatively, versus spacing, as required by the procedures. Unless there is built-in test software that reports the triggering conditions and enables the power levels to be confirmed separately, monitoring of conducted power during the triggering tests typically requires internal access to the antenna ports inside the tablet, which may interfere with the triggering tests.

- (1) The relevant transmitter should be set to operate at its normal maximum output power.
- (2) The entire back surface or edge of the tablet is positioned below a flat phantom filled with the required tissue-equivalent medium, and positioned at least 20 mm further than the distance that triggers power reduction.
- (3) It should be ensured that the cables required for power measurements are not interfering with the proximity sensor. Cable losses should be properly compensated to report the measured power results.
- (4) The back surface or edge is moved toward the phantom in 3 mm steps until the sensor triggers.
- (5) The back surface or edge is then moved back (further away) from the phantom by at least 5 mm or until maximum output power is returned to the normal maximum level.
- (6) The back surface or edge is again moved toward the phantom, but in 1 mm steps, until it is at least 5 mm past the triggering point or touching the phantom. If 1 mm resolution is not suitable for the sensor triggering sensitivity, a KDB inquiry should be submitted to determine alternative test configurations.
- (7) If the tablet is not touching the phantom, it is moved in 3 mm steps until it touches the phantom to confirm that the sensor remains triggered and the maximum power stays reduced.
- (8) The process is then reversed by moving the tablet away from the phantom according to steps 4) to 7), to determine triggering release, until it is at least 10 mm beyond the point that triggers the return of normal maximum power.
- (9) The measured output power within  $\pm 5$  mm of the triggering points, or until the tablet is touching the phantom, for movements to and from the phantom should be tabulated in the SAR report.

- (10) If the sensor design and implementation allow additional variations for triggering distance tolerances, multiple samples should be tested to determine the most conservative distance required for SAR evaluation.
- (11) To ensure all production units are compliant, it is generally necessary to reduce the triggering distance determined from the triggering tests by 1 mm, or more if it is necessary, and use the smallest distance for movements to and from the phantom, minus 1 mm, as the sensor triggering distance for determining the SAR measurement distance.

### **13.2. Procedures for determining antenna and proximity sensor coverage**

The sensing regions are usually limited to areas near the sensor element. If a sensor is spatially offset from the antenna(s), it is necessary to verify sensor triggering for conditions where the antenna is next to the user but the sensor is laterally further away to ensure sensor coverage is sufficient for reducing the power to maintain compliance. The following are used to determine if additional SAR measurements may be necessary due to sensor and antenna offset. 25 These procedures do not apply and are not required for configurations where the antenna and sensor are collocated and the peak SAR location is overlapping with the sensor.

- (1) The back surface or edge of the tablet is positioned at a test separation distance less than or equal to the distance required for back surface or edge triggering, with both the antenna and sensor pad located at least 20 mm laterally outside the edge (boundary) of the phantom, along the direction of maximum antenna and sensor offset. For the back surface, if the direction of maximum offset is not aligned with the tablet coordinates (physical edges) the tablet test position would not be aligned with the phantom coordinates (orientations). Each applicable tablet edge should be positioned perpendicularly to the phantom to determine sensor coverage. For antennas and/or sensors located near the corner of a tablet, both adjacent edges must be considered.
- (2) The similar sequence of steps applied to determine sensor triggering distance in section 6.2 are used to verify back surface and edge sensor coverage by moving the tablet (sensor and antenna) horizontally toward the phantom while maintaining the same vertical separation between the back surface or edge and the phantom.
- (3) After the exact location where triggering of power reduction is determined, with respect to the sensor and antenna, the tablet movement should be continued, in 3 mm increments, until both the sensor and antenna(s) are fully under the phantom and at least 20 mm inside the phantom edge.
- (4) The process is then repeated from the opposite direction, starting at the other end of the maximum antenna and sensor offset, by rotating the tablet 180° along the vertical axis.
- (5) The triggering points should be documented graphically, with the antenna and sensor clearly identified, along with all relevant dimensions.
- (6) If the subsequently measured peak SAR location for the antenna is not between the triggering points, established by the sensor coverage tests from opposite ends of the antenna and sensor, additional SAR tests may be required for conditions where only part of the back

surface or edge of a tablet corresponding to the antenna is in proximity to the user and the sensor may not be triggering as desired. A KDB inquiry must be submitted by the test lab to determine if additional tests are required and the proper test configurations to use for testing. This may include situations where the sensor coverage region is too small for the antenna, the sensor is located too far away from the antenna, the sensor location is insufficient to cover multiple antennas or the antenna is at the corner of a tablet etc.

**13.3. Proximity Sensor Status Table of trigger distance**

As per the KDB 616217 D04 SAR for laptop and tablets v01r02, section 6.2, the following procedure is used to determine the triggering distances.

Proximity Sensor Status Table when DUT is moving towards the phantom

Distance to the DUT (mm)	Proximity Sensor Status – Rear Surface	Proximity Sensor Status – Bottom-Edge	Proximity Sensor Status – Top-Edge
30	OFF	OFF	OFF
27	OFF	OFF	OFF
25	OFF	OFF	OFF
24	ON	OFF	OFF
23	ON	OFF	OFF
22	ON	OFF	OFF
21	ON	OFF	OFF
20	ON	OFF	OFF
19	ON	OFF	OFF
18	ON	OFF	OFF
17	ON	OFF	OFF
16	ON	OFF	OFF
15	ON	ON	ON
14	ON	ON	ON
13	ON	ON	ON
12	ON	ON	ON
11	ON	ON	ON
10	ON	ON	ON
9	ON	ON	ON
8	ON	ON	ON
7	ON	ON	ON
6	ON	ON	ON
5	ON	ON	ON
4	ON	ON	ON
3	ON	ON	ON
2	ON	ON	ON
1	ON	ON	ON
0	ON	ON	ON

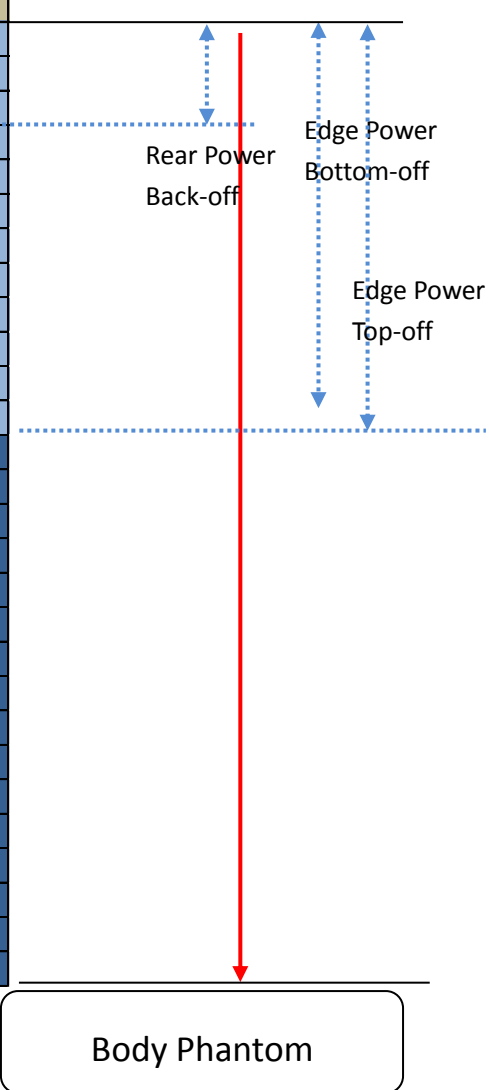

Proximity Sensor Status Table when DUT is moving away the phantom

Body Phantom

Distance to the DUT (mm)	Proximity Sensor Status – Rear Surface	Proximity Sensor Status – Bottom-Edge	Proximity Sensor Status – Top-Edge
0	ON	ON	ON
1	ON	ON	ON
2	ON	ON	ON
3	ON	ON	ON
4	ON	ON	ON
5	ON	ON	ON
6	ON	ON	ON
7	ON	ON	ON
8	ON	ON	ON
9	ON	ON	ON
10	ON	ON	ON
11	ON	ON	ON
12	ON	ON	ON
13	ON	ON	ON
14	ON	ON	ON
15	ON	ON	ON
16	ON	OFF	OFF
17	ON	OFF	OFF
18	ON	OFF	OFF
19	ON	OFF	OFF
20	ON	OFF	OFF
21	ON	OFF	OFF
22	ON	OFF	OFF
23	ON	OFF	OFF
24	ON	OFF	OFF
25	OFF	OFF	OFF
26	OFF	OFF	OFF
27	OFF	OFF	OFF
28	OFF	OFF	OFF
29	OFF	OFF	OFF
30	OFF	OFF	OFF

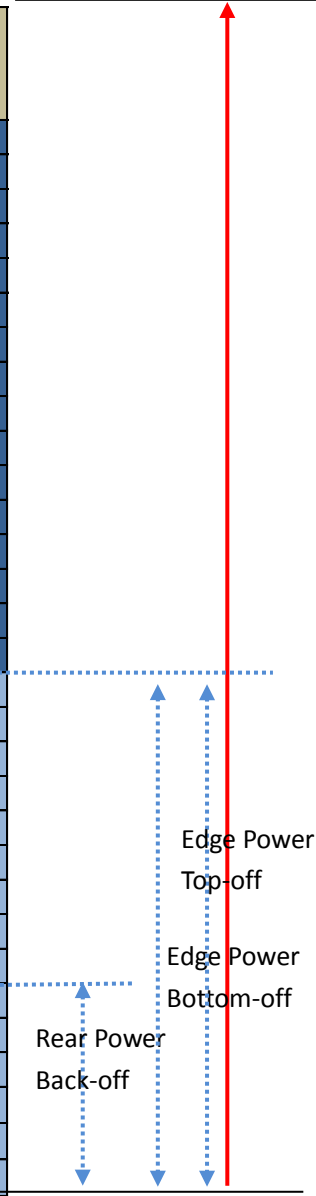

### 13.4. Tilt angle influences to proximity sensor triggering

As per the KDB 616217 D04 SAR for laptop and tablets v01r02, section 6.4, the following procedure is used to determine the tilt angle influences to proximity sensor triggering.

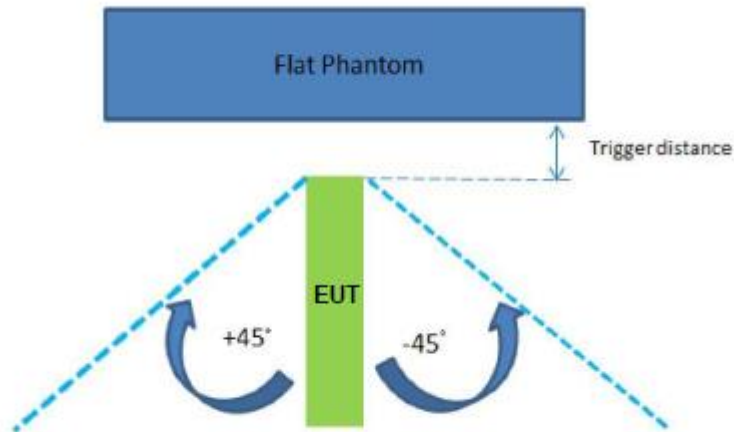

Distance to the DUT (mm)	Proximity Sensor Status 0° to +45°	Proximity Sensor Status 0° to -45°
15	ON	ON
14	ON	ON
13	ON	ON
12	ON	ON
11	ON	ON
10	ON	ON
9	ON	ON
8	ON	ON
7	ON	ON
6	ON	ON
5	ON	ON
4	ON	ON
3	ON	ON
2	ON	ON
1	ON	ON
0	ON	ON

**13.5. Power Reduction per Air-interface**

The following graphs show the power level and the distance from the DUT to the flat phantom for the Right-Edge, Bottom-Edge and Rear Surface.

**Rear Surface**

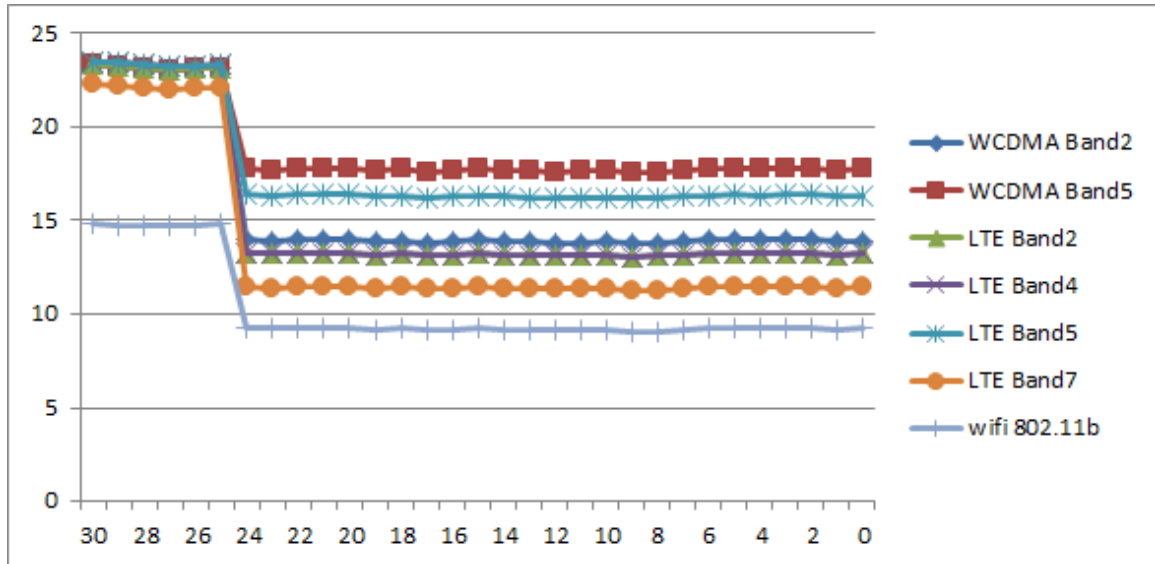

**Bottom-Edge**

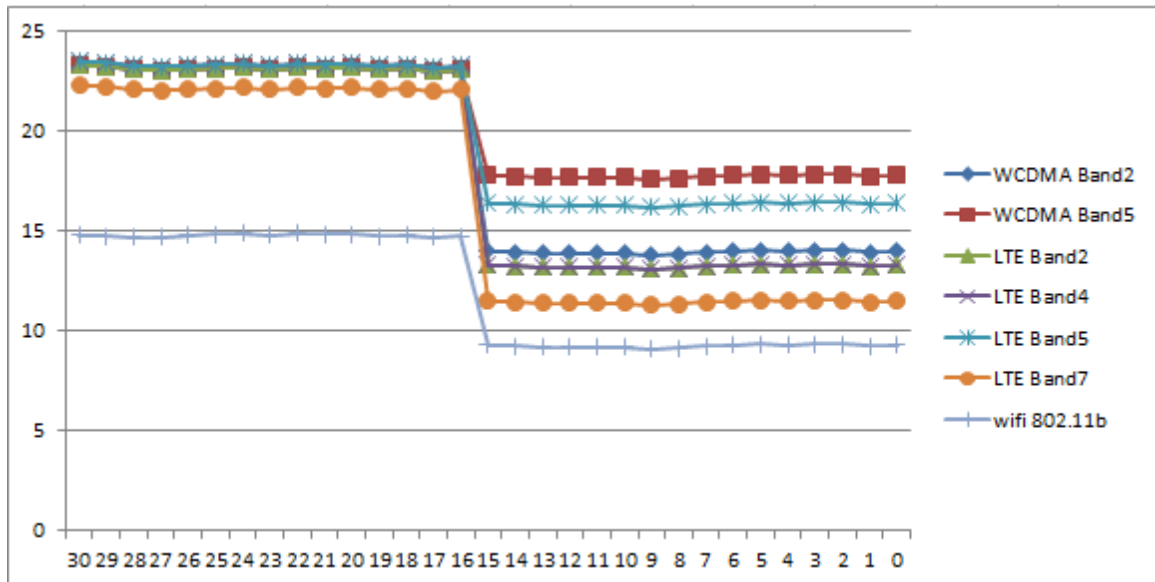

**Top-Edge**

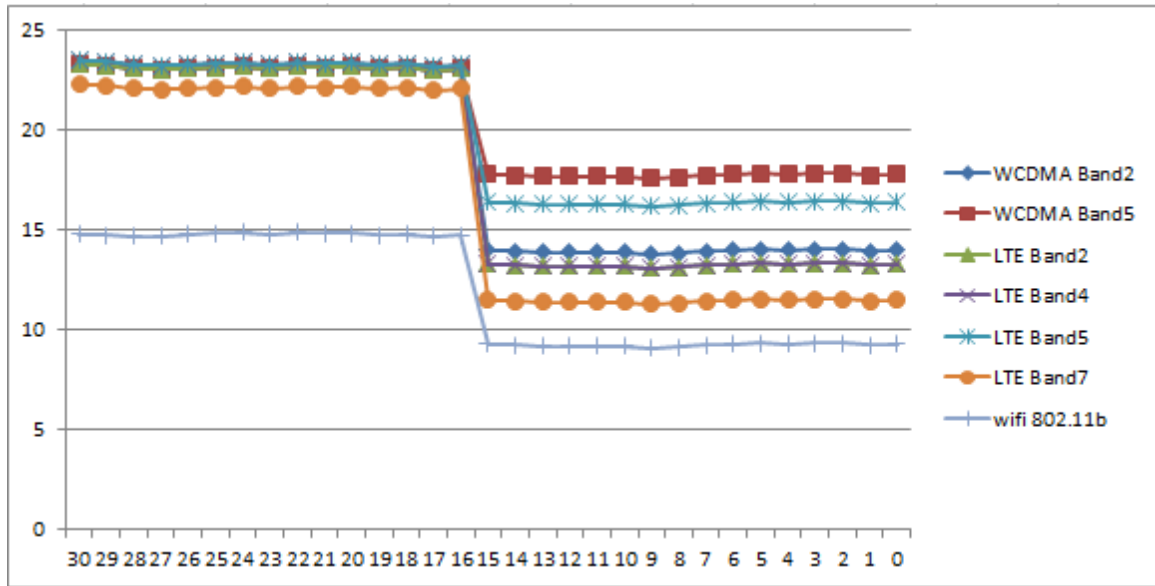

**13.6. Proximity Sensor Coverage Area**

According to KDB 616217 D04, Proximity Sensor Coverage Area of not request when the antenna and sensor are collocated and the peak SAR location is overlapping with the sensor.



## 14. Evaluation of Simultaneous

**Table 13.1: Summary of Transmitters**

Band/Mode	Frequency (GHz)	SAR test exclusion threshold(mW)	RF output power (mW)
Bluetooth	2.41	10	1.995
2.4GHz WLAN 802.11 b/g/n	2.45	10	31.623

**Table13.2 Simultaneous transmission SAR**

Standalone SAR for 3G (W/Kg)				
Test Position		WCDMA	WCDMA	Highest
		Band II	Band V	SAR
Body 14mm	Ground Side	1.155	0.413	1.155
	Right Side	--	--	--
	Bottom Side	--	0.208	0.208
	Top Side	0.573	--	0.573
Body 0 mm	Ground Side	1.092	0.478	1.092
	Right Side	0.276	0.256	0.276
	Bottom Side	--	0.248	0.248
	Top Side	0.492	--	0.492

Standalone SAR for 4G (W/Kg)								
Test Position		LTE	LTE	LTE	LTE	LTE	LTE	Highest SAR
		Band 2	Band 4	Band 5	Band 7	Band 12	Band 13	
Body 14mm	Ground Side	0.777	1.012	0.503	0.796	0.228	0.427	1.012
	Right Side	--	--	--	--	--		--
	Bottom Side	--	--	0.153	--	0.133	0.051	0.153
	Top Side	0.604	0.638	--	1.138	--		1.138
Body 0 mm	Ground Side	0.948	1.023	0.493	0.521	0.758	0.504	1.023
	Right Side	0.303	0.511	0.171	0.016	0.067	0.216	0.511
	Bottom Side	--	--	0.222	--	0.334	0.235	0.334
	Top Side	0.309	0.528	--	0.864	--		0.864

The LTE Band12/13 and Wi-Fi 5GHz test result are reference **TA Technology (Shanghai) Co.,Ltd** and the report No. is **RXA1704-0095SAR**.

Standalone SAR for 5G (W/Kg)					
Test Position		U-NII-1	U-NII-2C	U-NII-3	Highest SAR
Body 14mm	Ground Side	0.137	0.131	0.013	0.137
	Right Side	--	--	--	--
	Bottom Side	--	--	--	--
	Top Side	0.257	0.245	0.135	0.257
Body 0 mm	Ground Side	0.207	0.223	0.102	0.223
	Right Side	--	--	--	--
	Bottom Side	--	--	--	--
	Top Side	0.313	0.341	0.103	0.341

The LTE Band12/13 and Wi-Fi 5GHz test result are reference **TA Technology (Shanghai) Co.,Ltd** and the report No. is **RXA1704-0095SAR**.

Transmission SAR(W/Kg)						
Test Position		3G	4G	WIFI 2.4GHz	BT	SUM
Body 14mm	Ground Side	1.155	1.012	0.127	0.083	1.292
	Right Side	--	--	--	0.083	0.083
	Bottom Side	0.208	0.153	--	0.083	0.291
	Top Side	0.573	1.138	0.093	0.083	1.231
Body 0 mm	Ground Side	1.092	1.023	0.370	0.083	1.462
	Right Side	0.276	0.511	--	0.083	0.594
	Bottom Side	0.248	0.334	--	0.083	0.417
	Top Side	0.492	0.864	0.138	0.083	1.002

According to the conducted power measurement result, we can draw the conclusion that: stand-alone SAR for WiFi should be performed. Then, simultaneous transmission SAR for WiFi/BT is considered with measurement results of WCDMA/LTE and WiFi/BT. According to the above table, the sum of reported SAR values for WCDMA/LTE and WiFi < 1.6W/kg. So the simultaneous transmission SAR is not required for WiFi/BT transmitter.

Wi-Fi 5GHz not support hotspot mode, so simultaneously transmit not required.

## 15. SAR Test Result

### 15.1. SAR results for Fast SAR

**Table 15.1: Duty Cycle**

Duty Cycle	
WCDMA Band II/Band V	1:1
LTE Band 2/4/5/7	1:1
WiFi	1:0.973

**Table 15.2: SAR Values Sensor off (WCDMA Band II)**

Frequency		Mode	Distance (mm)	Test Position	Figure No.	Measured average power(dBm)	Maximum allowed Power (dBm)	Scaling factor	Measured SAR(1g) (W/kg)	Reported SAR(1g) (W/kg)	Power Drift (dB)
MHz	Ch.										
1880	2788	12.2K RMC	14	Ground	/	23.14	23.5	1.086	0.936	1.017	0.04
1880	2788	12.2K RMC	0	Right	/	23.14	23.5	1.086	0.254	0.276	0.10
1880	2788	12.2K RMC	14	Top	/	23.14	23.5	1.086	0.527	0.573	-0.06
1852.4	2712	12.2K RMC	14	Ground	/	23.31	23.5	1.045	0.912	0.953	-0.14
1907.6	2863	12.2K RMC	14	Ground	Fig.1	23.21	23.5	1.069	1.06	1.133	0.18
Repeated											
1907.6	2863	12.2K RMC	14	Ground	Fig.2	23.21	23.5	1.069	1.08	1.155	0.12

**Table 15.3: SAR Values Sensor on(WCDMA Band II)**

Frequency		Mode	Distance (mm)	Test Position	Figure No.	Measured average power(dBm)	Maximum allowed Power (dBm)	Scaling factor	Measured SAR(1g) (W/kg)	Reported SAR(1g) (W/kg)	Power Drift (dB)
MHz	Ch.										
1880	2788	12.2K RMC	0	Ground	/	13.94	14	1.014	0.703	0.713	0.12
1880	2788	12.2K RMC	0	Top	/	13.94	14	1.014	0.485	0.492	0.10
1852.4	2712	12.2K RMC	0	Ground	Fig.3	13.91	14	1.021	1.04	1.062	0.07
1907.6	2863	12.2K RMC	0	Ground	/	13.62	14	1.091	0.648	0.707	0.06
Repeated											

1852.4	2712	12.2K RMC	0	Ground	Fig.4	13.91	14	1.021	1.07	1.092	-0.10
--------	------	--------------	---	--------	-------	-------	----	-------	------	-------	-------

**Table 15.4: SAR Values Sensor off (WCDMA Band V )**

Frequency		Mode	Distance (mm)	Test Position	Figure No.	Measured average power(dBm)	Maximum allowed Power (dBm)	Scaling factor	Measured SAR(1g) (W/kg)	Reported SAR(1g) (W/kg)	Power Drift (dB)
MHz	Ch.										
836.6	4182	12.2K RMC	14	Ground	/	23.27	23.5	1.054	0.377	0.398	0.12
836.6	4182	12.2K RMC	0	Right	/	23.27	23.5	1.054	0.243	0.256	-0.15
836.6	4182	12.2K RMC	14	Bottom	/	23.27	23.5	1.054	0.197	0.208	0.03
826.4	4132	12.2K RMC	14	Ground	/	23.33	23.5	1.040	0.325	0.338	0.05
846.6	4233	12.2K RMC	14	Ground	Fig.5	23.24	23.5	1.062	0.389	0.413	0.12

**Table 15.5: SAR Values Sensor on (WCDMA Band V )**

Frequency		Mode	Distance (mm)	Test Position	Figure No.	Measured average power(dBm)	Maximum allowed Power (dBm)	Scaling factor	Measured SAR(1g) (W/kg)	Reported SAR(1g) (W/kg)	Power Drift (dB)
MHz	Ch.										
836.6	4182	12.2K RMC	0	Ground	/	17.88	18	1.028	0.320	0.329	-0.14
836.6	4182	12.2K RMC	0	Bottom	/	17.88	18	1.028	0.241	0.248	0.14
826.4	4132	12.2K RMC	0	Ground	/	17.86	18	1.033	0.300	0.310	0.04
846.6	4233	12.2K RMC	0	Ground	Fig.6	17.74	18	1.062	0.45	0.478	-0.08

**Table 15.6: SAR Values Sensor off (LTE Band2)**

Frequency		Distance (mm)	Configuration	Test Position	Figure No.	Measured average power (dBm)	Maximum allowed Power (dBm)	Scaling factor	Measured SAR(1g) (W/kg)	Reported SAR(1g) (W/kg)	Power Drift(dB)
MHz	Ch.										
1880	18900	14	QPSK_20MHz 1RB_0 offset	Toward Ground	Fig.7	23.26	23.5	1.057	0.735	0.777	0.19
			QPSK_20MHz 50RB_0 offset	Toward Ground	Fig.8	21.99	22	1.002	0.642	0.643	0.18
1880	18900	0	QPSK_20MHz 1RB_0 offset	Toward Right	/	23.26	23.5	1.057	0.287	0.303	0.19
			QPSK_20MHz 50RB_0 offset	Toward Right	/	21.99	22	1.002	0.204	0.204	0.12
1880	18900	14	QPSK_20MHz 1RB_0 offset	Toward Top	/	23.26	23.5	1.057	0.572	0.604	0.08
			QPSK_20MHz 50RB_0 offset	Toward Top	/	21.99	22	1.002	0.456	0.457	-0.15
1860	18700	14	QPSK_20MHz 1RB_0 offset	Toward Ground	/	23.23	23.5	1.064	0.655	0.697	0.03
			QPSK_20MHz 50RB_0 offset	Toward Ground	/	21.89	22	1.026	0.400	0.410	0.06
1900	19100	14	QPSK_20MHz 1RB_0 offset	Toward Ground	/	23.24	23.5	1.062	0.460	0.488	0.13
			QPSK_20MHz 50RB_0 offset	Toward Ground	/	21.91	22	1.021	0.429	0.438	-0.13

**Table 15.7: SAR Values Sensor on (LTE Band2)**

Frequency		Distance (mm)	Configuration	Test Position	Figure No.	Measured average power (dBm)	Maximum allowed Power (dBm)	Scaling factor	Measured SAR(1g) (W/kg)	Reported SAR(1g) (W/kg)	Power Drift(dB)
MHz	Ch.										
1880	18900	0	QPSK_20MHz 1RB_0 offset	Toward Ground	Fig.9	13.32	13.5	1.042	0.735	0.766	0.09
			QPSK_20MHz 50RB_0 offset	Toward Ground	Fig.10	13.18	13.5	1.076	0.874	0.941	-0.10
1880	18900	0	QPSK_20MHz 1RB_0 offset	Toward Top	/	13.32	13.5	1.042	0.282	0.294	0.12
			QPSK_20MHz 50RB_0 offset	Toward Top	/	13.18	13.5	1.076	0.287	0.309	0.08
1860	18700	0	QPSK_20MHz 1RB_0 offset	Toward Ground	/	13.31	13.5	1.045	0.655	0.684	-0.15
			QPSK_20MHz 50RB_0 offset	Toward Ground	/	13.07	13.5	1.104	0.824	0.910	0.03

1900	19100	0	QPSK_20MHz 1RB_0 offset	Toward Ground	/	13.22	13.5	1.067	0.460	0.491	0.06
			QPSK_20MHz 50RB_0 offset	Toward Ground	/	13.11	13.5	1.094	0.802	0.877	0.13
1880	18900	0	QPSK_20MHz 100RB_0 offset	Toward Ground	Fig.11	13.12	13.5	1.091	0.869	0.948	-0.18
Repeated											
1880	18900	0	QPSK_20MHz 50RB_0 offset	Toward Ground	Fig.12	13.18	13.5	1.076	0.874	0.941	-0.15

**Table 15.8: SAR Values Sensor off (LTE Band 4)**

Frequency		Distance (mm)	Configuration	Test Position	Figure No.	Measured average power (dBm)	Maximum allowed Power (dBm)	Scaling factor	Measured SAR(1g) (W/kg)	Reported SAR(1g) (W/kg)	Power Drift(dB)
MHz	Ch.										
1732.5	20175	14	QPSK_20MHz 1RB_0 offset	Toward Ground	/	23.45	23.5	1.012	0.860	0.870	0.11
			QPSK_20MHz 50RB_0 offset	Toward Ground	Fig.14	22.76	23	1.057	0.743	0.785	-0.14
1732.5	20175	0	QPSK_20MHz 1RB_0 offset	Toward Right	/	23.45	23.5	1.012	0.505	0.511	0.08
			QPSK_20MHz 50RB_0 offset	Toward Right	/	22.76	23	1.057	0.370	0.391	-0.15
1732.5	20175	14	QPSK_20MHz 1RB_0 offset	Toward Top	/	23.45	23.5	1.012	0.631	0.638	0.06
			QPSK_20MHz 50RB_0 offset	Toward Top	/	22.76	23	1.057	0.565	0.597	0.01
1720	20050	14	QPSK_20MHz 1RB_0 offset	Toward Ground	/	23.36	23.5	1.033	0.831	0.858	0.07
			QPSK_20MHz 50RB_0 offset	Toward Ground	/	22.73	23	1.064	0.583	0.620	0.15
1745	20300	14	QPSK_20MHz 1RB_0 offset	Toward Ground	Fig.13	23.41	23.5	1.021	0.957	0.977	0.14
			QPSK_20MHz 50RB_0 offset	Toward Ground	/	22.72	23	1.067	0.627	0.669	-0.15
1732.5	20175	14	QPSK_20MHz 100RB_0 offset	Toward Ground	Fig.15	22.45	22.5	1.012	0.743	0.752	0.12
Repeated											
1745	20300	14	QPSK_20MHz 1RB_0 offset	Toward Ground	Fig.16	23.41	23.5	1.021	0.991	1.012	0.11

**Table 15.9: SAR Values Sensor on (LTE Band 4)**

Frequency		Distance (mm)	Configuration	Test Position	Figure No.	Measured average power (dBm)	Maximum allowed Power (dBm)	Scaling factor	Measured SAR(1g) (W/kg)	Reported SAR(1g) (W/kg)	Power Drift(dB)
MHz	Ch.										
1732.5	20175	0	QPSK_20MHz 1RB_0 offset	Toward Ground	/	13.33	13.5	1.040	0.845	0.879	0.08
			QPSK_20MHz 50RB_0 offset	Toward Ground	/	13.28	13.5	1.052	0.855	0.899	-0.15
1732.5	20175	0	QPSK_20MHz 1RB_0 offset	Toward Top	/	13.33	13.5	1.040	0.326	0.339	0.06
			QPSK_20MHz 50RB_0 offset	Toward Top	/	13.28	13.5	1.052	0.502	0.528	0.01
1720	20050	0	QPSK_20MHz 1RB_0 offset	Toward Ground	/	13.28	13.5	1.052	0.838	0.882	0.07
			QPSK_20MHz 50RB_0 offset	Toward Ground	/	13.10	13.5	1.096	0.791	0.867	0.15
1745	20300	0	QPSK_20MHz 1RB_0 offset	Toward Ground	Fig.17	13.31	13.5	1.045	0.96	1.003	0.13
			QPSK_20MHz 50RB_0 offset	Toward Ground	Fig.18	13.10	13.5	1.096	0.933	1.023	-0.12
1732.5	20175	0	QPSK_20MHz 100RB_0 offset	Toward Ground	Fig.19	13.37	13.5	1.030	0.899	0.926	-0.16
Repeated											
1745	20300	0	QPSK_20MHz 1RB_0 offset	Toward Ground	Fig.20	13.31	13.5	1.045	0.976	1.020	0.17

**Table 15.10: SAR Values Sensor off (LTE Band 5)**

Frequency		Distance (mm)	Configuration	Test Position	Figure No.	Measured average power (dBm)	Maximum allowed Power (dBm)	Scaling factor	Measured SAR(1g) (W/kg)	Reported SAR(1g) (W/kg)	Power Drift(dB)
MHz	Ch.										
836.5	2525	14	QPSK_10MHz 1RB_0 offset	Toward Ground	/	23.44	23.5	1.014	0.452	0.458	-0.09
			QPSK_10MHz 25RB_0 offset	Toward Ground	Fig.22	22.70	23	1.072	0.384	0.410	0.05
836.5	2525	0	QPSK_10MHz 1RB_0 offset	Toward Right	/	23.44	23.5	1.014	0.169	0.171	0.04
			QPSK_10MHz 25RB_0 offset	Toward Right	/	22.70	23	1.072	0.134	0.144	-0.18
836.5	2525	14	QPSK_10MHz 1RB_0 offset	Toward Bottom	/	23.44	23.5	1.014	0.151	0.153	0.04
			QPSK_10MHz 25RB_0 offset	Toward Bottom	/	22.70	23	1.072	0.132	0.141	-0.12
829	2045 0	14	QPSK_10MHz 1RB_0 offset	Toward Ground	/	23.26	23.5	1.057	0.424	0.448	0.07
			QPSK_10MHz 25RB_0 offset	Toward Ground	/	22.46	23	1.132	0.352	0.399	0.12
844	2060 0	14	QPSK_10MHz 1RB_0 offset	Toward Ground	Fig.21	23.30	23.5	1.047	0.48	0.503	-0.13
			QPSK_10MHz 25RB_0 offset	Toward Ground	/	22.45	23	1.135	0.355	0.403	0.12

**Table 15.11: SAR Values Sensor on (LTE Band 5)**

Frequency		Distance (mm)	Configuration	Test Position	Figure No.	Measured average power (dBm)	Maximum allowed Power (dBm)	Scaling factor	Measured SAR(1g) (W/kg)	Reported SAR(1g) (W/kg)	Power Drift(dB)
MHz	Ch.										
836.5	2525	0	QPSK_10MHz 1RB_0 offset	Toward Ground	/	16.41	16.5	1.021	0.397	0.405	0.07
			QPSK_10MHz 25RB_0 offset	Toward Ground	/	15.67	16	1.079	0.373	0.402	0.15
836.5	2525	0	QPSK_10MHz 1RB_0 offset	Toward Bottom	/	16.41	16.5	1.021	0.187	0.191	0.19
			QPSK_10MHz 25RB_0 offset	Toward Bottom	/	15.67	16	1.079	0.206	0.222	0.11
829	2045 0	0	QPSK_10MHz 1RB_0 offset	Toward Ground	Fig.23	16.14	16.5	1.086	0.409	0.444	0.05
			QPSK_10MHz	Toward	Fig.24	15.44	16	1.138	0.433	0.493	-0.01



			25RB_0 offset	Ground							
844	2060	0	QPSK_10MHz	Toward	/	16.19	16.5	1.074	0.362	0.389	-0.18
			1RB_0 offset	Ground							
			QPSK_10MHz	Toward	/	15.49	16	1.125	0.369	0.415	0.04
25RB_0 offset	Ground										

**Table 15.12: SAR Values Sensor off (WiFi2450 802.11b )**

Frequency		Distance (mm)	Test Position	Figure No.	Measured average power(dBm)	Maximum allowed Power (dBm)	Scaling factor	Duty cycle factor	Measured SAR(1g) (W/kg)	Reported SAR(1g) (W/kg)	Power Drift (dB)
MHz	Ch.										
2412	1	14	Ground	Fig.25	14.77	15	1.054	1.031	0.117	0.127	-0.05
2437	6	14	Ground	/	14.63	15	1.089	1.031	0.059	0.066	0.01
2462	11	14	Ground	/	13.47	15	1.422	1.031	0.045	0.066	0.12
2412	1	14	Top	/	14.77	15	1.054	1.031	0.086	0.093	0.01

**Table 15.13: SAR Values Sensor on (WiFi2450 802.11b )**

Frequency		Distance (mm)	Test Position	Figure No.	Measured average power(dBm)	Maximum allowed Power (dBm)	Scaling factor	Duty cycle factor	Measured SAR(1g) (W/kg)	Reported SAR(1g) (W/kg)	Power Drift (dB)
MHz	Ch.										
2412	1	0	Ground	Fig.26	9.31	9.5	1.045	1.031	0.344	0.370	0.12
2437	6	0	Ground	/	9.25	9.5	1.059	1.031	0.229	0.250	0.05
2462	11	0	Ground	/	8.29	9.5	1.321	1.031	0.172	0.234	-0.12
2412	1	0	Top	/	9.31	9.5	1.045	1.031	0.128	0.138	0.06

Note: SAR is not required for OFDM because the 802.11b adjusted SAR≤1.2 W/kg.

**Table 15.14: SAR Values Sensor off (LTE Band 7)**

Frequency		Distance (mm)	Configuration	Test Position	Figure No.	Measured average power (dBm)	Maximum allowed Power (dBm)	Scaling factor	Measured SAR(1g) (W/kg)	Reported SAR(1g) (W/kg)	Power Drift(dB)
MHz	Ch.										
2535	21100	14	QPSK_20MHz	Toward	/	22.25	22.5	1.059	0.752	0.796	-0.18
			1RB_0 offset	Ground							
2535	21100	0	QPSK_20MHz	Toward	/	21.49	21.5	1.002	0.762	0.764	0.04
			50RB_0 offset	Ground							
2535	21100	0	QPSK_20MHz	Toward	/	22.25	22.5	1.059	0.015	0.016	-0.12
			1RB_0 offset	Right							

			QPSK_20MHz 50RB_0 offset	Toward Right	/	21.49	21.5	1.002	0.014	0.014	0.07
2535	21100	14	QPSK_20MHz 1RB_0 offset	Toward Top	/	22.25	22.5	1.059	1.00	1.059	0.12
			QPSK_20MHz 50RB_0 offset	Toward Top	/	21.49	21.5	1.002	0.754	0.756	0.04
2510	20850	14	QPSK_20MHz 1RB_0 offset	Toward Top	/	22.21	22.5	1.069	0.829	0.886	-0.12
			QPSK_20MHz 50RB_0 offset	Toward Top	/	21.48	21.5	1.005	0.594	0.597	0.07
2560	21350	14	QPSK_20MHz 1RB_0 offset	Toward Top	Fig.27	22.15	22.5	1.084	1.05	1.138	0.08
			QPSK_20MHz 50RB_0 offset	Toward Top	Fig.28	21.45	21.5	1.012	0.848	0.858	-0.02
2535	21100	14	QPSK_20MHz 100RB_0 offset	Toward Top	/	21.12	21.5	1.091	0.606	0.661	0.19
Repeated											
2560	21350	14	QPSK_20MHz 1RB_0 offset	Toward Top	Fig.29	22.15	22.5	1.084	1.03	1.116	-0.06

**Table 15.15: SAR Values Sensor on (LTE Band 7)**

Frequency		Distance (mm)	Configuration	Test Position	Figure No.	Measured average power (dBm)	Maximum allowed Power (dBm)	Scaling factor	Measured SAR(1g) (W/kg)	Reported SAR(1g) (W/kg)	Power Drift(dB)
MHz	Ch.										
2535	21100	0	QPSK_20MHz 1RB_0 offset	Toward Ground	Fig.30	11.64	12	1.086	0.48	0.521	0.02
			QPSK_20MHz 50RB_0 offset	Toward Ground	/	11.48	11.5	1.005	0.488	0.490	0.04
2535	21100	0	QPSK_20MHz 1RB_0 offset	Toward Top	/	11.64	12	1.086	0.309	0.336	-0.12
			QPSK_20MHz 50RB_0 offset	Toward Top	/	11.48	11.5	1.005	0.507	0.509	0.07
2510	20850	0	QPSK_20MHz 1RB_0 offset	Toward Ground	/	11.52	12	1.117	0.264	0.295	0.08
			QPSK_20MHz 50RB_0 offset	Toward Top	/	11.23	11.5	1.064	0.478	0.509	-0.02
2560	21350	0	QPSK_20MHz 1RB_0 offset	Toward Ground	/	11.57	12	1.104	0.326	0.360	0.19
			QPSK_20MHz 50RB_0 offset	Toward Top	Fig.31	11.43	11.5	1.016	0.847	0.861	-0.17
2535	21100	0	QPSK_20MHz 100RB_0 offset	Toward Top	/	11.42	11.5	1.019	0.629	0.641	0.13
Repeated											
2560	21350	0	QPSK_20MHz 1RB_0 offset	Toward Top	Fig.32	11.43	11.5	1.016	0.85	0.864	-0.11

## SAR results for Standard procedure

There is zoom scan measurement to be added for the highest measured SAR in each exposure configuration/band.

**Table 15.16: SAR Values Sensor off (WCDMA Band II)**

Frequency		Mode	Distance (mm)	Test Position	Figure No.	Measured average power(dBm)	Maximum allowed Power (dBm)	Scaling factor	Measured SAR(1g) (W/kg)	Reported SAR(1g) (W/kg)	Power Drift (dB)
MHz	Ch.										
1907.6	2863	12.2K RMC	14	Ground	Fig.1	23.21	23.5	1.069	1.06	1.133	0.18
Repeated											
1907.6	2863	12.2K RMC	14	Ground	Fig.2	23.21	23.5	1.069	1.08	1.155	0.12

**Table 15.17: SAR Values Sensor on(WCDMA Band II)**

Frequency		Mode	Distance (mm)	Test Position	Figure No.	Measured average power(dBm)	Maximum allowed Power (dBm)	Scaling factor	Measured SAR(1g) (W/kg)	Reported SAR(1g) (W/kg)	Power Drift (dB)
MHz	Ch.										
1852.4	2712	12.2K RMC	0	Ground	Fig.3	13.91	14	1.021	1.04	1.062	0.07
Repeated											
1852.4	2712	12.2K RMC	0	Ground	Fig.4	13.91	14	1.021	1.07	1.092	-0.10

**Table 15.18: SAR Values Sensor off (WCDMA Band V )**

Frequency		Mode	Distance (mm)	Test Position	Figure No.	Measured average power(dBm)	Maximum allowed Power (dBm)	Scaling factor	Measured SAR(1g) (W/kg)	Reported SAR(1g) (W/kg)	Power Drift (dB)
MHz	Ch.										
846.6	4233	12.2K RMC	14	Ground	Fig.5	23.24	23.5	1.062	0.389	0.413	0.12

**Table 15.19: SAR Values Sensor on (WCDMA Band V )**

Frequency		Mode	Distance (mm)	Test Position	Figure No.	Measured average power(dBm)	Maximum allowed Power (dBm)	Scaling factor	Measured SAR(1g) (W/kg)	Reported SAR(1g) (W/kg)	Power Drift (dB)
MHz	Ch.										
846.6	4233	12.2K RMC	0	Ground	Fig.6	17.74	18	1.062	0.45	0.478	-0.08

**Table 15.20: SAR Values Sensor off (LTE Band2)**

Frequency		Distance (mm)	Configuration	Test Position	Figure No.	Measured average power (dBm)	Maximum allowed Power (dBm)	Scaling factor	Measured SAR(1g) (W/kg)	Reported SAR(1g) (W/kg)	Power Drift(dB)
MHz	Ch.										
1880	18900	14	QPSK_20MHz 1RB_0 offset	Toward Ground	Fig.7	23.26	23.5	1.057	0.735	0.777	0.19
			QPSK_20MHz 50RB_0 offset	Toward Ground	Fig.8	21.99	22	1.002	0.642	0.643	0.18

**Table 15.21: SAR Values Sensor on (LTE Band2)**

Frequency		Distance (mm)	Configuration	Test Position	Figure No.	Measured average power (dBm)	Maximum allowed Power (dBm)	Scaling factor	Measured SAR(1g) (W/kg)	Reported SAR(1g) (W/kg)	Power Drift(dB)
MHz	Ch.										
1880	18900	0	QPSK_20MHz 1RB_0 offset	Toward Ground	Fig.9	13.32	13.5	1.042	0.735	0.766	0.09
			QPSK_20MHz 50RB_0 offset	Toward Ground	Fig.10	13.18	13.5	1.076	0.874	0.941	-0.10
1880	18900	0	QPSK_20MHz 100RB_0 offset	Toward Ground	Fig.11	13.12	13.5	1.091	0.869	0.948	-0.18
Repeated											
1880	18900	0	QPSK_20MHz 50RB_0 offset	Toward Ground	Fig.12	13.18	13.5	1.076	0.874	0.892	-0.15

**Table 15.22: SAR Values Sensor off (LTE Band 4)**

Frequency		Distance (mm)	Configuration	Test Position	Figure No.	Measured average power (dBm)	Maximum allowed Power (dBm)	Scaling factor	Measured SAR(1g) (W/kg)	Reported SAR(1g) (W/kg)	Power Drift(dB)
MHz	Ch.										
1732.5	20175	14	QPSK_20MHz 50RB_0 offset	Toward Ground	Fig.14	22.76	23	1.057	0.743	0.785	-0.14
1745	20300	14	QPSK_20MHz 1RB_0 offset	Toward Ground	Fig.13	23.41	23.5	1.021	0.957	0.977	0.14
1732.5	20175	14	QPSK_20MHz 100RB_0 offset	Toward Ground	Fig.15	22.45	22.5	1.012	0.743	0.752	0.12
Repeated											
1745	20300	14	QPSK_20MHz 1RB_0 offset	Toward Ground	Fig.16	23.41	23.5	1.021	0.991	1.012	0.11

**Table 15.23: SAR Values Sensor on (LTE Band 4)**

Frequency		Distance (mm)	Configuration	Test Position	Figure No.	Measured average power (dBm)	Maximum allowed Power (dBm)	Scaling factor	Measured SAR(1g) (W/kg)	Reported SAR(1g) (W/kg)	Power Drift(dB)
MHz	Ch.										
1745	20300	0	QPSK_20MHz 1RB_0 offset	Toward Ground	Fig.17	13.31	13.5	1.045	0.96	1.003	0.13
			QPSK_20MHz 50RB_0 offset	Toward Ground	Fig.18	13.10	13.5	1.096	0.933	1.023	-0.12
1732.5	20175	0	QPSK_20MHz 100RB_0 offset	Toward Ground	Fig.19	13.37	13.5	1.030	0.899	0.926	-0.16
Repeated											
1745	20300	0	QPSK_20MHz 1RB_0 offset	Toward Ground	Fig.20	13.31	13.5	1.045	0.976	1.020	0.17

**Table 15.24: SAR Values Sensor off (LTE Band 5)**

Frequency		Distance (mm)	Configuration	Test Position	Figure No.	Measured average power (dBm)	Maximum allowed Power (dBm)	Scaling factor	Measured SAR(1g) (W/kg)	Reported SAR(1g) (W/kg)	Power Drift(dB)
MHz	Ch.										
836.5	2525 0	14	QPSK_10MHz 25RB_0 offset	Toward Ground	Fig.22	22.70	23	1.072	0.384	0.410	0.05
844	2060 0	14	QPSK_10MHz 1RB_0 offset	Toward Ground	Fig.21	23.30	23.5	1.047	0.48	0.503	-0.13

**Table 15.25: SAR Values Sensor on (LTE Band 5)**

Frequency		Distance (mm)	Configuration	Test Position	Figure No.	Measured average power (dBm)	Maximum allowed Power (dBm)	Scaling factor	Measured SAR(1g) (W/kg)	Reported SAR(1g) (W/kg)	Power Drift(dB)
MHz	Ch.										
829	2045 0	0	QPSK_10MHz 1RB_0 offset	Toward Ground	Fig.23	16.14	16.5	1.086	0.409	0.444	0.05
			QPSK_10MHz 25RB_0 offset	Toward Ground	Fig.24	15.44	16	1.138	0.433	0.493	-0.01

**Table 15.26: SAR Values Sensor off (WiFi2450 802.11b )**

Frequency		Distance (mm)	Test Position	Figure No.	Measured average power(dBm)	Maximum allowed Power (dBm)	Scaling factor	Duty cycle factor	Measured SAR(1g) (W/kg)	Reported SAR(1g) (W/kg)	Power Drift (dB)
MHz	Ch.										
2412	1	14	Ground	Fig.25	14.77	15	1.054	1.031	0.117	0.127	-0.05

**Table 15.27: SAR Values Sensor on (WiFi2450 802.11b )**

Frequency		Distance (mm)	Test Position	Figure No.	Measured average power(dBm)	Maximum allowed Power (dBm)	Scaling factor	Duty cycle factor	Measured SAR(1g) (W/kg)	Reported SAR(1g) (W/kg)	Power Drift (dB)
MHz	Ch.										
2412	1	0	Ground	Fig.26	9.31	9.5	1.045	1.031	0.344	0.370	0.12

Note: SAR is not required for OFDM because the 802.11b adjusted SAR≤1.2 W/kg.

**Table 15.28: SAR Values Sensor off (LTE Band 7)**

Frequency		Distance (mm)	Configuration	Test Position	Figure No.	Measured average power (dBm)	Maximum allowed Power (dBm)	Scaling factor	Measured SAR(1g) (W/kg)	Reported SAR(1g) (W/kg)	Power Drift(dB)
MHz	Ch.										
2560	21350	14	QPSK_20MHz 1RB_0 offset	Toward Top	Fig.27	22.15	22.5	1.084	1.05	1.138	0.08
			QPSK_20MHz 50RB_0 offset	Toward Top	Fig.28	21.45	21.5	1.012	0.848	0.858	-0.02
Repeated											
2560	21350	14	QPSK_20MHz 1RB_0 offset	Toward Top	Fig.29	22.15	22.5	1.084	1.03	1.116	-0.06

**Table 15.29: SAR Values Sensor on (LTE Band 7)**

Frequency		Distance (mm)	Configuration	Test Position	Figure No.	Measured average power (dBm)	Maximum allowed Power (dBm)	Scaling factor	Measured SAR(1g) (W/kg)	Reported SAR(1g) (W/kg)	Power Drift(dB)
MHz	Ch.										
2535	21100	0	QPSK_20MHz 1RB_0 offset	Toward Ground	Fig.30	11.64	12	1.086	0.48	0.521	0.02
2560	21350	0	QPSK_20MHz 50RB_0 offset	Toward Top	Fig.31	11.43	11.5	1.016	0.847	0.861	-0.17
Repeated											
2560	21350	0	QPSK_20MHz 1RB_0 offset	Toward Top	Fig.32	11.43	11.5	1.016	0.85	0.864	-0.11

## 16. SAR Measurement Variability

SAR measurement variability must be assessed for each frequency band, which is determined by the SAR probe calibration point and tissue-equivalent medium used for the device measurements. When both head and body tissue-equivalent media are required for SAR measurements in a frequency band, the variability measurement procedures should be applied to the tissue medium with the highest measured SAR, using the highest measured SAR configuration for that tissue-equivalent medium.

The following procedures are applied to determine if repeated measurements are required.

- 1) Repeated measurement is not required when the original highest measured SAR is < 0.80 W/kg; steps 2) through 4) do not apply.
- 2) When the original highest measured SAR is  $\geq 0.80$  W/kg, repeat that measurement once.
- 3) Perform a second repeated measurement only if the ratio of largest to smallest SAR for the original and first repeated measurements is > 1.20 or when the original or repeated measurement is  $\geq 1.45$  W/kg (~ 10% from the 1-g SAR limit).
- 4) Perform a third repeated measurement only if the original, first or second repeated measurement is  $\geq 1.5$  W/kg and the ratio of largest to smallest SAR for the original, first and second repeated measurements is > 1.20.

**Table 16.1: SAR Measurement Variability (1g)**

Frequency		Mode	Test Position	Original SAR (W/kg)	First Repeated SAR (W/kg)	The Ratio	Second Repeated (W/kg)
MHz	Ch.						
1907.6	2863	12.2K RMC	Ground	1.06	1.08	1.02	N/A
1852.4	2712	12.2K RMC	Ground	1.04	1.07	1.03	N/A
1880	1890 0	QPSK_20MHz 50RB_0 offset	Ground	0.874	0.874	1.00	N/A
1745	2030 0	QPSK_20MHz 1RB_0 offset	Ground	0.957	0.991	1.04	N/A
1745	2030 0	QPSK_20MHz 1RB_0 offset	Ground	0.96	0.976	1.02	N/A
2560	2135 0	QPSK_20MHz 1RB_0 offset	Top	1.05	1.03	1.02	N/A
2560	2135 0	QPSK_20MHz 5RB_0 offset	Top	0.847	0.85	1.00	N/A

**Note:** According to the KDB 865664 D01 repeated measurement is not required when the original highest measured SAR is < 0.8 W/kg.



## 17. Measurement Uncertainty

Measurement uncertainty for 750 MHz to 3 GHz averaged over 1 gram						
Uncertainty Component	Uncertainty	Prob.	Div.	$C_{i(1g)}$	Std. Unc. (1-g)	$V_i$ or $V_{eff}$
<b>Measurement System</b>						
Probe Calibration ( $k=1$ )	5.4	Normal	2	1	5.40	$\infty$
Probe Isotropy	4.70	Rectangular	$\sqrt{3}$	0.7	1.90	$\infty$
Modulation Response	2.40	Rectangular	$\sqrt{3}$	1	1.39	$\infty$
Hemispherical Isotropy	2.60	Rectangular	$\sqrt{3}$	0.7	1.05	$\infty$
Boundary Effect	1.00	Rectangular	$\sqrt{3}$	1	0.58	$\infty$
Linearity	4.70	Rectangular	$\sqrt{3}$	1	2.71	$\infty$
System Detection Limit	1.00	Rectangular	$\sqrt{3}$	1	0.58	$\infty$
Readout Electronics	0.30	Normal	1	1	0.30	$\infty$
Response Time	0.80	Rectangular	$\sqrt{3}$	1	0.46	$\infty$
Integration Time	2.60	Rectangular	$\sqrt{3}$	1	1.50	$\infty$
RF Ambient Noise	0.00	Rectangular	$\sqrt{3}$	1	0.00	$\infty$
RF Ambient Reflections	0.00	Rectangular	$\sqrt{3}$	1	0.00	$\infty$
Probe Positioner	0.40	Rectangular	$\sqrt{3}$	1	0.23	$\infty$
Probe Positioning	2.90	Rectangular	$\sqrt{3}$	1	1.67	$\infty$
Post-processing	1.00	Rectangular	$\sqrt{3}$	1	0.58	$\infty$
<b>Test sample Related</b>						
Test sample Positioning	1.2	Normal	1	1	1.2	5
Device Holder Uncertainty	3.2	Normal	1	1	3.2	71
Power drift	5	Rectangular	$\sqrt{3}$	1	2.89	$\infty$
Power Scaling	0	Rectangular	$\sqrt{3}$	1	0.00	$\infty$
<b>Phantom and Tissue Parameters</b>						
Phantom Uncertainty	4	Rectangular	$\sqrt{3}$	1	2.31	$\infty$
SAR correction	1.9	Rectangular	$\sqrt{3}$	1	1.10	$\infty$
Liquid Conductivity (meas)	4.19	Rectangular	1	0.78	3.27	$\infty$
Liquid Permittivity (meas)	4.4	Rectangular	1	0.26	1.14	$\infty$
Temp. unc. - Conductivity	0.18	Rectangular	$\sqrt{3}$	0.78	0.08	$\infty$
Temp. unc. - Permittivity	0.54	Rectangular	$\sqrt{3}$	0.23	0.07	$\infty$
<b>Combined Std. Uncertainty</b>		RSS			9.39	
<b>Expanded STD Uncertainty</b>		$k=2$			18.77%	

System check uncertainty for 750 MHz to 3 GHz averaged over 1 gram						
Uncertainty Component	Uncertainty	Prob.	Div.	$C_{i(1g)}$	Std. Unc. (1-g)	$V_i$ or $V_{eff}$
<b>Measurement System</b>						
Probe Calibration ( $k=1$ )	5.40	Normal	1	1	5.40	$\infty$
Probe Isotropy	4.70	Rectangular	$\sqrt{3}$	0.7	1.90	$\infty$
Modulation Response	2.40	Rectangular	$\sqrt{3}$	1	1.39	$\infty$
Hemispherical Isotropy	2.60	Rectangular	$\sqrt{3}$	0.7	1.05	$\infty$
Boundary Effect	1.00	Rectangular	$\sqrt{3}$	1	0.58	$\infty$
Linearity	4.70	Rectangular	$\sqrt{3}$	1	2.71	$\infty$
System Detection Limit	1.00	Rectangular	$\sqrt{3}$	1	0.58	$\infty$
Readout Electronics	0.30	Normal	1	1	0.30	$\infty$
Response Time	0.80	Rectangular	$\sqrt{3}$	1	0.46	$\infty$
Integration Time	2.60	Rectangular	$\sqrt{3}$	1	1.50	$\infty$
RF Ambient Noise	0.00	Rectangular	$\sqrt{3}$	1	0.00	$\infty$
RF Ambient Reflections	0.00	Rectangular	$\sqrt{3}$	1	0.00	$\infty$
Probe Positioner	0.40	Rectangular	$\sqrt{3}$	1	0.23	$\infty$
Probe Positioning	2.90	Rectangular	$\sqrt{3}$	1	1.67	$\infty$
Post-processing	1.00	Rectangular	$\sqrt{3}$	1	0.58	$\infty$
<b>Field source</b>						
Deviation of the experimental source from numerical source	5.5	Normal	1	1	5.5	$\infty$
Source to liquid distance	2	Rectangular	$\sqrt{3}$	1	1.15	$\infty$
Power drift	5	Rectangular	$\sqrt{3}$	1	2.89	$\infty$
<b>Phantom and Tissue Parameters</b>						
Phantom Uncertainty	4	Rectangular	$\sqrt{3}$	1	2.31	$\infty$
SAR correction	1.9	Rectangular	$\sqrt{3}$	1	1.10	$\infty$
Liquid Conductivity (meas)	4.19	Normal	1	0.78	3.27	$\infty$
Liquid Permittivity (meas)	4.4	Normal	1	0.26	1.14	$\infty$
Temp. unc. - Conductivity	0.18	Rectangular	$\sqrt{3}$	0.78	0.08	$\infty$
Temp. unc. - Permittivity	0.54	Rectangular	$\sqrt{3}$	0.23	0.07	$\infty$
<b>Combined Std. Uncertainty</b>		RSS			10.39	
<b>Expanded STD Uncertainty</b>		$k=2$			20.79%	

## 18. Main Test Instrument

**Table 18.1: List of Main Instruments**

No.	Name	Type	Serial Number	Calibration Date	Valid Period
01	Network analyzer	N5242A	MY51221755	Jan 6, 2017	1 year
02	Power meter	NRVD	102257	May 11, 2017	1 year
03	Power sensor	NRV-Z5	100241		
			100644		
04	Signal Generator	E4438C	MY49072044	May 11, 2017	1 Year
05	Amplifier	NTWPA-0086010F	12023024	No Calibration Requested	
06	Coupler	778D	MY4825551	May 11, 2017	1 year
07	BTS	E5515C	MY50266468	Jan 6, 2017	1 year
08	BTS	MT8820C	6201240338	May 11, 2017	
09	E-field Probe	EX3DV4	3754	Jan 13, 2017	1 year
10	DAE	SPEAG DAE4	1244	Dec 12,2016	1 year
11	Dipole Validation Kit	SPEAG D835V2	4d112	Oct 22, 2015	2 year
		SPEAG D1750V2	1044	Nov 3,2015	2 year
		SPEAG D1900V2	5d134	Nov 4,2015	2 year
		SPEAG D2450V2	858	Oct 30,2015	2 year
		SPEAG D2600V2	1031	Oct 30,2015	2 year

## ANNEX A. GRAPH RESULTS

### WCDMA Band2 Ground Mode High 14mm

Date/Time: 2017/4/27

Electronics: DAE4 Sn1244

Medium: Body 1900MHz

Medium parameters used (extrapolated):  $f = 1907.6$  MHz;  $\sigma = 1.579$  S/m;  $\epsilon_r = 54.555$ ;  $\rho = 1000$  kg/m<sup>3</sup>

Ambient Temperature:22°C      Liquid Temperature:22°C

Communication System: WCDMA Professional Band II; Frequency: 1907.6 MHz; Duty Cycle: 1:1

Probe: EX3DV4 - SN3754ConvF(7.6, 7.6, 7.6); Calibrated: 1/13/2017

### WCDMA Band2 Ground Mode High/Area Scan (131x211x1):

Measurement grid: dx=10 mm, dy=10 mm

Maximum value of SAR (Measurement) = 1.15 W/kg

### WCDMA Band2 Ground Mode High/Zoom Scan (7x7x7)/Cube 0:

Measurement grid: dx=5mm, dy=5mm, dz=5mm

Reference Value = 9.791 V/m; Power Drift = 0.18 dB

Peak SAR (extrapolated) = 1.86 W/kg

SAR(1 g) = 1.06 W/kg; SAR(10 g) = 0.577 W/kg

Maximum value of SAR (measured) = 1.18 W/kg

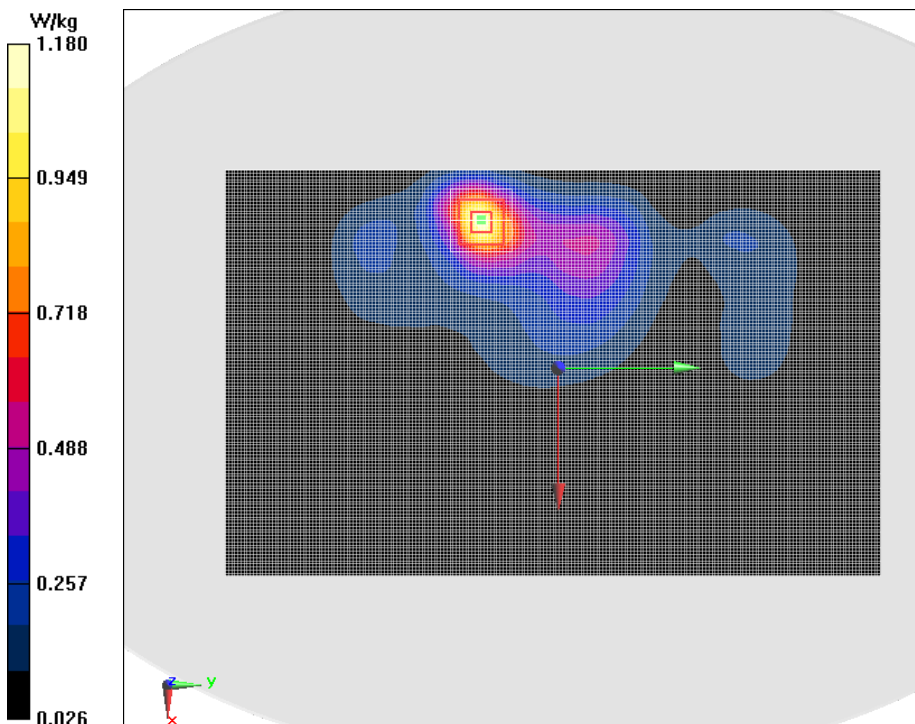

**Fig.1 WCDMA Band2 Ground Mode High**

## WCDMA Band2 Ground Mode repeated 14mm

Date/Time: 2017/4/27

Electronics: DAE4 Sn1244

Medium: Body 1900MHz

Medium parameters used (extrapolated):  $f = 1907.6$  MHz;  $\sigma = 1.579$  S/m;  $\epsilon_r = 54.555$ ;  $\rho = 1000$  kg/m<sup>3</sup>

Ambient Temperature: 22°C      Liquid Temperature: 22°C

Communication System: WCDMA Professional Band II; Frequency: 1907.6 MHz; Duty Cycle: 1:1

Probe: EX3DV4 - SN3754ConvF(7.6, 7.6, 7.6); Calibrated: 1/13/2017

## WCDMA Band2 Ground Mode repeated/Area Scan (131x211x1):

Measurement grid: dx=10 mm, dy=10 mm

Maximum value of SAR (Measurement) = 1.18 W/kg

## WCDMA Band2 Ground Mode repeated/Zoom Scan (7x7x7)/Cube 0:

Measurement grid: dx=5mm, dy=5mm, dz=5mm

Reference Value = 9.821 V/m; Power Drift = 0.12 dB

Peak SAR (extrapolated) = 1.90 W/kg

SAR(1 g) = 1.08 W/kg; SAR(10 g) = 0.590 W/kg

Maximum value of SAR (measured) = 1.21 W/kg

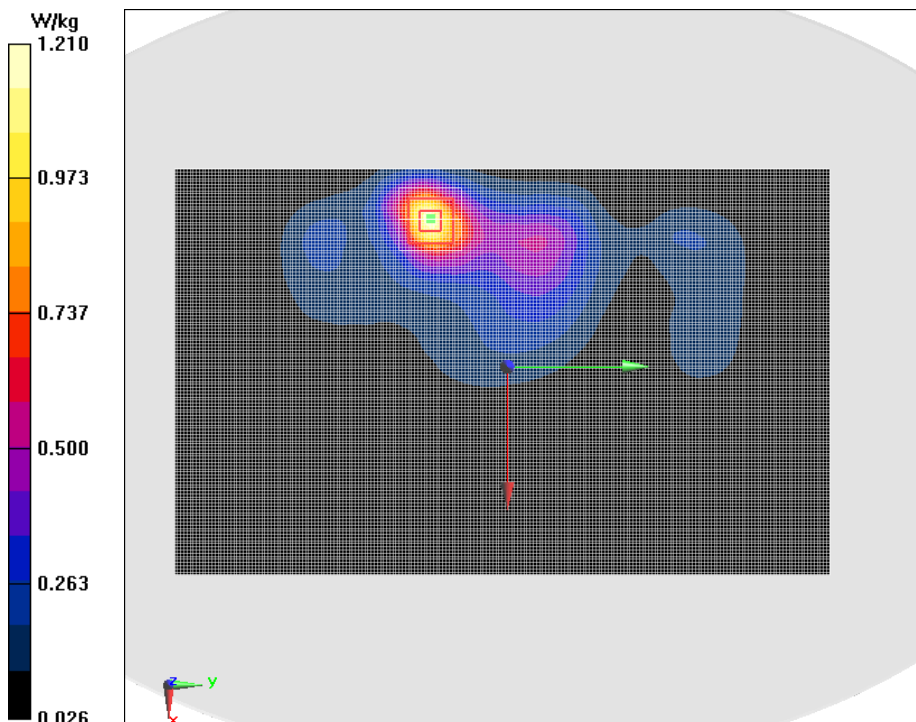

Fig.2 WCDMA Band2 Ground Mode repeated

**WCDMA Band2 Ground Mode Low 0mm**

Date/Time: 2017/4/27

Electronics: DAE4 Sn1244

Medium: Body 1900MHz

Medium parameters used (interpolated):  $f = 1852.4$  MHz;  $\sigma = 1.523$  S/m;  $\epsilon_r = 54.779$ ;  $\rho = 1000$  kg/m<sup>3</sup>

Ambient Temperature:22°C      Liquid Temperature:22°C

Communication System: WCDMA Professional Band II; Frequency: 1852.4 MHz; Duty Cycle: 1:1

Probe: EX3DV4 - SN3754ConvF(7.6, 7.6, 7.6); Calibrated: 1/13/2017

**WCDMA Band2 Ground Mode Low/Area Scan (131x211x1):**

Measurement grid: dx=10 mm, dy=10 mm

Maximum value of SAR (Measurement) = 1.10 W/kg

**WCDMA Band2 Ground Mode Low/Zoom Scan (7x7x7)/Cube 0:**

Measurement grid: dx=5mm, dy=5mm, dz=5mm

Reference Value = 1.103 V/m; Power Drift = 0.07 dB

Peak SAR (extrapolated) = 2.42 W/kg

SAR(1 g) = 1.04 W/kg; SAR(10 g) = 0.462 W/kg

Maximum value of SAR (measured) = 1.20 W/kg

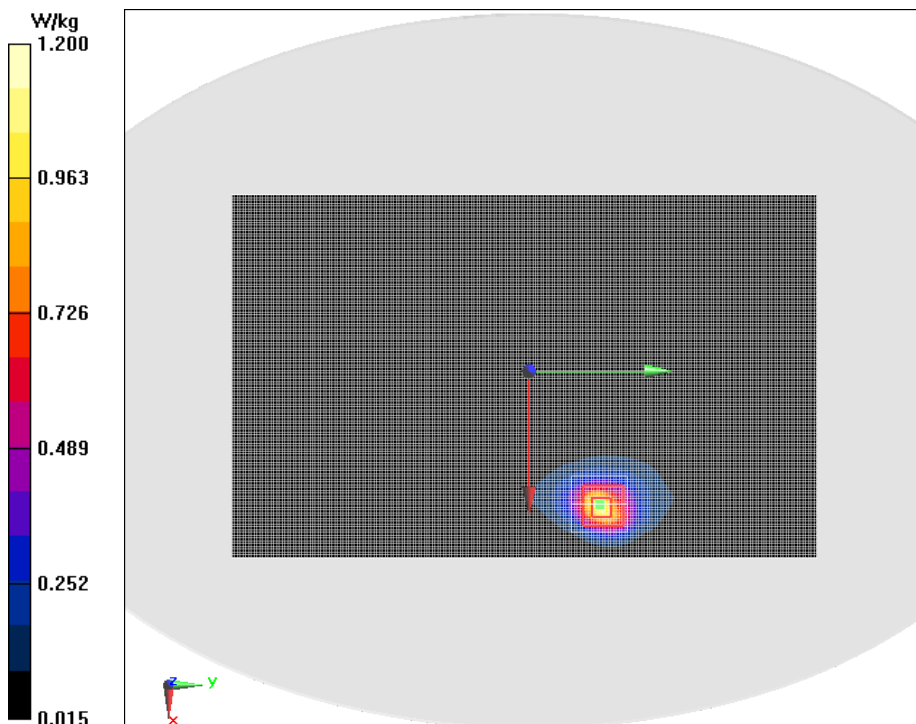

**Fig.3 WCDMA Band2 Ground Mode Low**

## WCDMA Band2 Ground Mode Low repeated 0mm

Date/Time: 2017/4/27

Electronics: DAE4 Sn1244

Medium: Body 1900MHz

Medium parameters used (interpolated):  $f = 1852.4$  MHz;  $\sigma = 1.523$  S/m;  $\epsilon_r = 54.779$ ;  $\rho = 1000$  kg/m<sup>3</sup>

Ambient Temperature:22°C      Liquid Temperature:22°C

Communication System: WCDMA Professional Band II; Frequency: 1852.4 MHz; Duty Cycle: 1:1

Probe: EX3DV4 - SN3754ConvF(7.6, 7.6, 7.6); Calibrated: 1/13/2017

## WCDMA Band2 Ground Mode Low repeated/Area Scan (131x211x1):

Measurement grid: dx=10 mm, dy=10 mm

Maximum value of SAR (Measurement) = 1.15 W/kg

## WCDMA Band2 Ground Mode Low repeated/Zoom Scan (7x7x7)/Cube 0:

Measurement grid: dx=5mm, dy=5mm, dz=5mm

Reference Value = 1.173 V/m; Power Drift = -0.10 dB

Peak SAR (extrapolated) = 2.49 W/kg

SAR(1 g) = 1.07 W/kg; SAR(10 g) = 0.473 W/kg

Maximum value of SAR (measured) = 1.25 W/kg

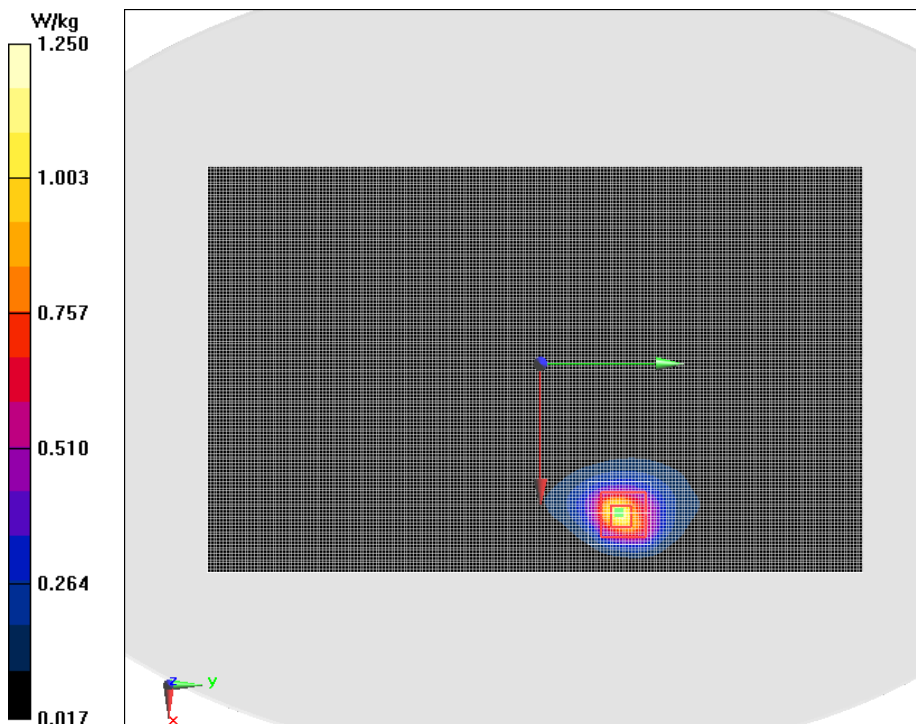

Fig.4 WCDMA Band2 Ground Mode Low repeated



**WCDMA Band5 Ground Mode High 14mm**

Date/Time: 2017/4/28

Electronics: DAE4 Sn1244

Medium: Body 835MHz

Medium parameters used:  $f = 847$  MHz;  $\sigma = 1.012$  S/m;  $\epsilon_r = 55.214$ ;  $\rho = 1000$  kg/m<sup>3</sup>

Ambient Temperature:22°C Liquid Temperature:22°C

Communication System: WCDMA Professional Band V; Frequency: 846.6 MHz; Duty Cycle: 1:1

Probe: EX3DV4 - SN3754ConvF(9.66, 9.66, 9.66); Calibrated: 1/13/2017

**WCDMA Band5 Ground Mode High/Area Scan (141x211x1):**

Measurement grid: dx=10 mm, dy=10 mm

Maximum value of SAR (Measurement) = 0.426 W/kg

**WCDMA Band5 Ground Mode High/Zoom Scan (7x7x7)/Cube 0:**

Measurement grid: dx=5mm, dy=5mm, dz=5mm

Reference Value = 3.938 V/m; Power Drift = 0.12 dB

Peak SAR (extrapolated) = 0.604 W/kg

SAR(1 g) = 0.389 W/kg; SAR(10 g) = 0.243 W/kg

Maximum value of SAR (measured) = 0.424 W/kg

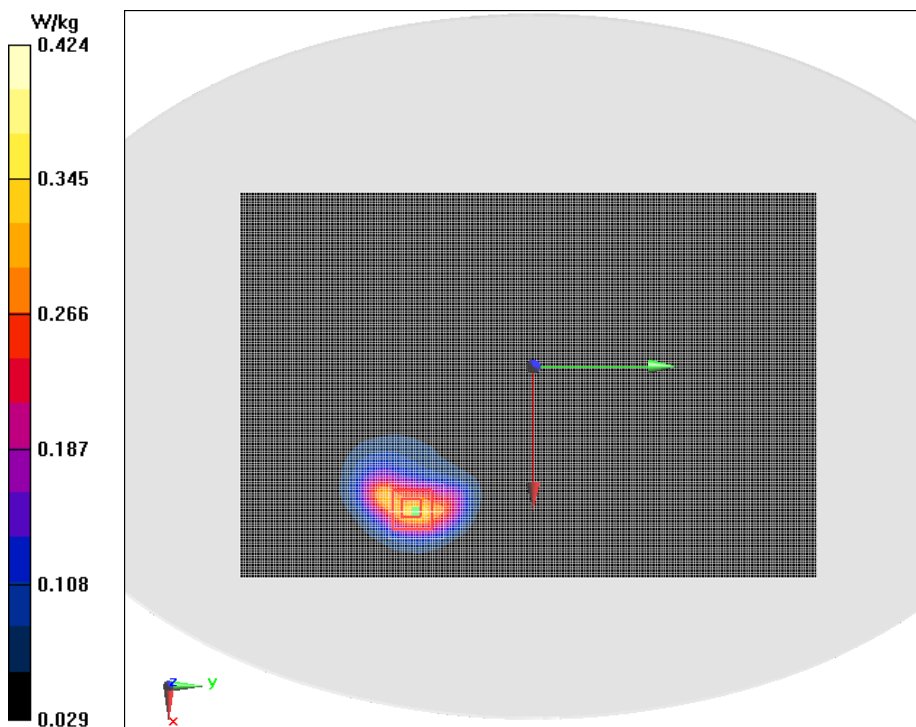

**Fig.5 WCDMA Band5 Ground Mode High 14mm**



## WCDMA Band5 Ground Mode Low 0mm

Date/Time: 2017/4/28

Electronics: DAE4 Sn1244

Medium: Body 835MHz

Medium parameters used (interpolated):  $f = 826.4$  MHz;  $\sigma = 0.994$  S/m;  $\epsilon_r = 55.147$ ;  $\rho = 1000$  kg/m<sup>3</sup>

Ambient Temperature: 22°C      Liquid Temperature: 22°C

Communication System: WCDMA Professional Band V; Frequency: 826.4 MHz; Duty Cycle: 1:1

Probe: EX3DV4 - SN3754ConvF(9.66, 9.66, 9.66); Calibrated: 1/13/2017

## WCDMA Band5 Ground Mode Low/Area Scan (141x211x1):

Measurement grid: dx=10 mm, dy=10 mm

Maximum value of SAR (Measurement) = 0.385 W/kg

## WCDMA Band5 Ground Mode Low/Zoom Scan (7x7x7)/Cube 0:

Measurement grid: dx=5mm, dy=5mm, dz=5mm

Reference Value = 0.8110 V/m; Power Drift = -0.08 dB

Peak SAR (extrapolated) = 1.04 W/kg

SAR(1 g) = 0.450 W/kg; SAR(10 g) = 0.221 W/kg

Maximum value of SAR (measured) = 0.488 W/kg

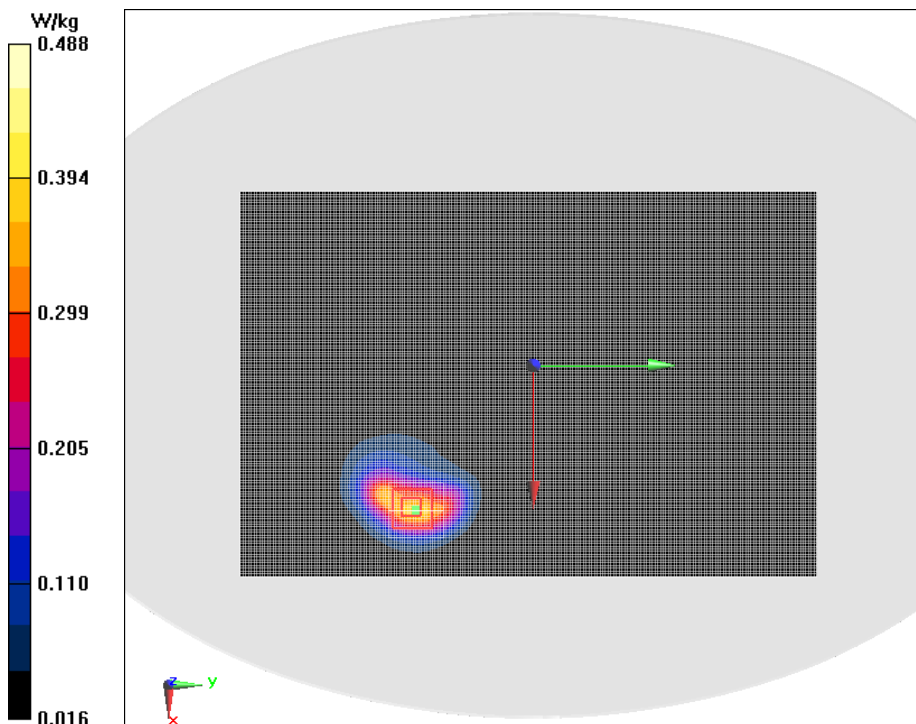

Fig.6 WCDMA Band5 Ground Mode Low

**LTE Band 2 20MHz 1RB 0offset Ground Mode Middle 14mm**

Date/Time: 2017/4/27

Electronics: DAE4 Sn1244

Medium: Body 1900MHz

Medium parameters used:  $f = 1880$  MHz;  $\sigma = 1.551$  S/m;  $\epsilon_r = 54.667$ ;  $\rho = 1000$  kg/m<sup>3</sup>

Ambient Temperature:22°C Liquid Temperature:22°C

Communication System: LTE Band 2 Professional 1900MHz; Frequency: 1880 MHz; Duty Cycle: 1:1

Probe: EX3DV4 - SN3754ConvF(7.6, 7.6, 7.6); Calibrated: 1/13/2017

**LTE Band 2 20MHz 1RB 0offset Ground Mode Middle 14mm/Area Scan (151x201x1):**

Measurement grid: dx=10 mm, dy=10 mm

Maximum value of SAR (Measurement) = 1.09 W/kg

**LTE Band 2 20MHz 1RB 0offset Ground Mode Middle 14mm/Zoom Scan (7x7x7)/Cube 0:**

Measurement grid: dx=5mm, dy=5mm, dz=5mm

Reference Value = 0.4110 V/m; Power Drift = 0.19 dB

Peak SAR (extrapolated) = 1.71 W/kg

SAR(1 g) = 0.735 W/kg; SAR(10 g) = 0.329 W/kg

Maximum value of SAR (measured) = 0.866 W/kg

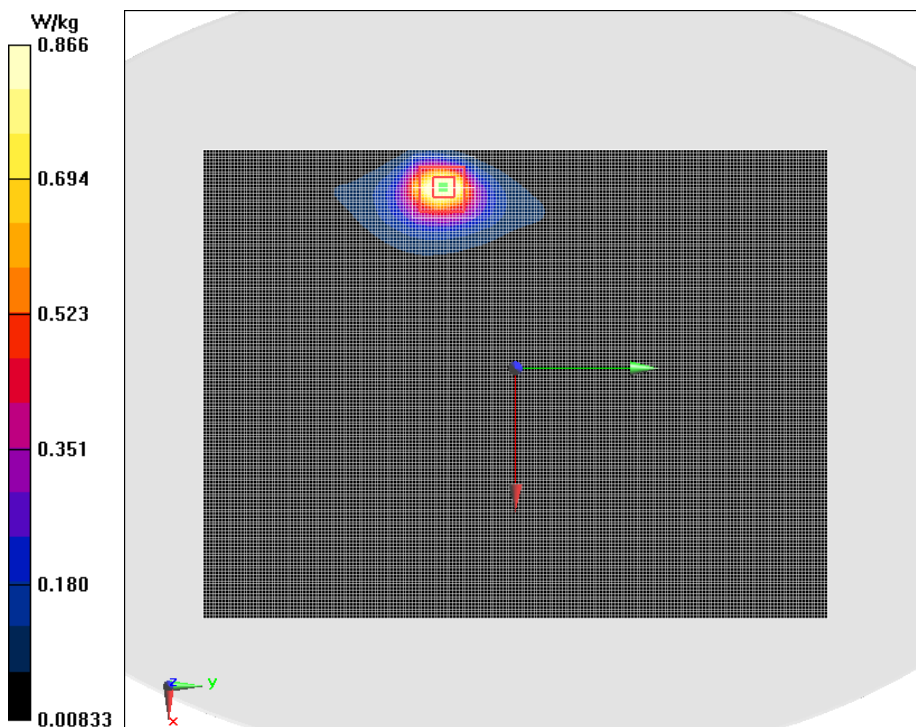

**Fig.7 LTE Band 2 20MHz 1RB 0offset Ground Mode Middle 14mm**

**LTE Band 2 20MHz 50RB 0offset Ground Mode Middle 14mm**

Date/Time: 2017/4/27

Electronics: DAE4 Sn1244

Medium: Body 1900MHz

Medium parameters used:  $f = 1880 \text{ MHz}$ ;  $\sigma = 1.551 \text{ S/m}$ ;  $\epsilon_r = 54.667$ ;  $\rho = 1000 \text{ kg/m}^3$

Ambient Temperature: 22°C    Liquid Temperature: 22°C

Communication System: LTE Band 2 Professional 1900MHz;    Frequency: 1880 MHz; Duty Cycle: 1:1

Probe: EX3DV4 - SN3754ConvF(7.6, 7.6, 7.6); Calibrated: 1/13/2017

**LTE Band 2 20MHz 50RB 0offset Ground Mode Middle 14mm/Area Scan (131x211x1):**

Measurement grid:  $dx=10 \text{ mm}$ ,  $dy=10 \text{ mm}$

Maximum value of SAR (Measurement) = 0.712 W/kg

**LTE Band 2 20MHz 50RB 0offset Ground Mode Middle 14mm/Zoom Scan (7x7x7)/Cube 0:**

Measurement grid:  $dx=5\text{mm}$ ,  $dy=5\text{mm}$ ,  $dz=5\text{mm}$

Reference Value = 6.753 V/m; Power Drift = 0.18 dB

Peak SAR (extrapolated) = 1.12 W/kg

SAR(1 g) = 0.642 W/kg; SAR(10 g) = 0.356 W/kg

Maximum value of SAR (measured) = 0.713 W/kg

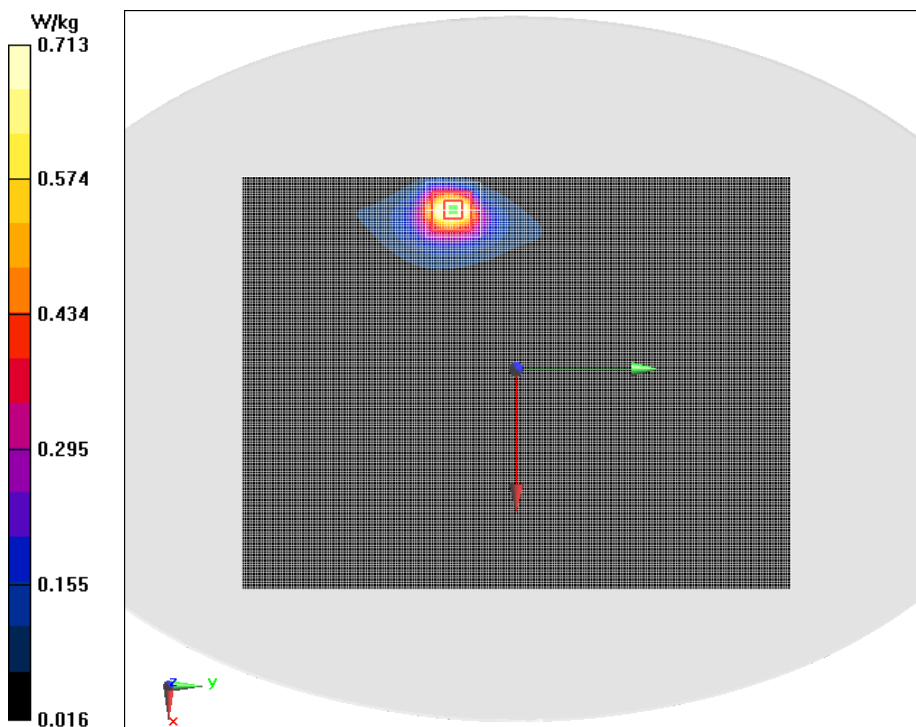

**Fig.8 LTE Band 2 20MHz 50RB 0offset Ground Mode Middle 14mm**

**LTE Band 2 20MHz 1RB 0offset Ground Mode Middle 0mm**

Date/Time: 2017/4/27

Electronics: DAE4 Sn1244

Medium: Body 1900MHz

Medium parameters used:  $f = 1880$  MHz;  $\sigma = 1.551$  S/m;  $\epsilon_r = 54.667$ ;  $\rho = 1000$  kg/m<sup>3</sup>

Ambient Temperature:22°C Liquid Temperature:22°C

Communication System: LTE Band 2 Professional 1900MHz; Frequency: 1880 MHz; Duty Cycle: 1:1

Probe: EX3DV4 - SN3754ConvF(7.6, 7.6, 7.6); Calibrated: 1/13/2017

**LTE Band 2 20MHz 1RB 0offset Ground Mode Middle/Area Scan (151x201x1):**

Measurement grid: dx=10 mm, dy=10 mm

Maximum value of SAR (Measurement) = 1.09 W/kg

**LTE Band 2 20MHz 1RB 0offset Ground Mode Middle/Zoom Scan (7x7x7)/Cube 0:**

Measurement grid: dx=5mm, dy=5mm, dz=5mm

Reference Value = 0.4110 V/m; Power Drift = 0.09 dB

Peak SAR (extrapolated) = 1.71 W/kg

SAR(1 g) = 0.735 W/kg; SAR(10 g) = 0.329 W/kg

Maximum value of SAR (measured) = 0.866 W/kg

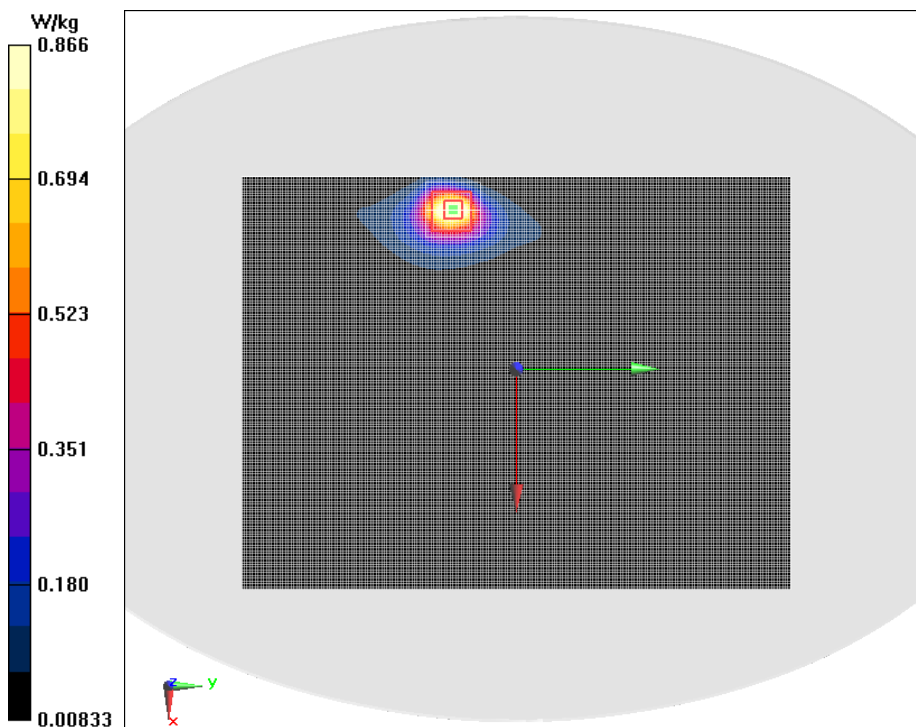

**Fig.9 LTE Band 2 20MHz 1RB 0offset Ground Mode Middle**

**LTE Band 2 20MHz 50RB 0offset Ground Mode Middle 0mm**

Date/Time: 2017/4/27

Electronics: DAE4 Sn1244

Medium: Body 1900MHz

Medium parameters used:  $f = 1880 \text{ MHz}$ ;  $\sigma = 1.551 \text{ S/m}$ ;  $\epsilon_r = 54.667$ ;  $\rho = 1000 \text{ kg/m}^3$

Ambient Temperature: 22°C Liquid Temperature: 22°C

Communication System: LTE Band 2 Professional 1900MHz; Frequency: 1880 MHz; Duty Cycle: 1:1

Probe: EX3DV4 - SN3754ConvF(7.6, 7.6, 7.6); Calibrated: 1/13/2017

**LTE Band 2 20MHz 50RB 0offset Ground Mode Middle/Area Scan (131x211x1):**

Measurement grid:  $dx=10 \text{ mm}$ ,  $dy=10 \text{ mm}$

Maximum value of SAR (Measurement) = 1.02 W/kg

**LTE Band 2 20MHz 50RB 0offset Ground Mode Middle/Zoom Scan (7x7x7)/Cube 0:**

Measurement grid:  $dx=5\text{mm}$ ,  $dy=5\text{mm}$ ,  $dz=5\text{mm}$

Reference Value = 0.7480 V/m; Power Drift = -0.10 dB

Peak SAR (extrapolated) = 2.03 W/kg

SAR(1 g) = 0.874 W/kg; SAR(10 g) = 0.386 W/kg

Maximum value of SAR (measured) = 0.982 W/kg

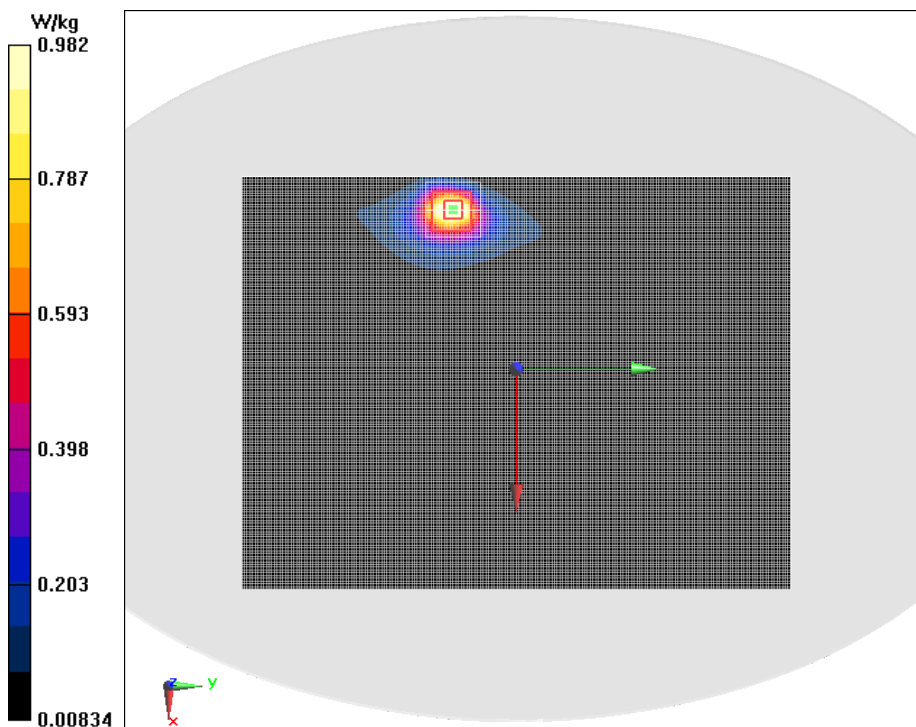

**Fig.10 LTE Band 2 20MHz 50RB 0offset Ground Mode Middle**



**LTE Band 2 20MHz 100RB 0offset Ground Mode 0mm**

Date/Time: 2017/4/27

Electronics: DAE4 Sn1244

Medium: Body 1900MHz

Medium parameters used:  $f = 1880$  MHz;  $\sigma = 1.551$  S/m;  $\epsilon_r = 54.667$ ;  $\rho = 1000$  kg/m<sup>3</sup>

Ambient Temperature: 22°C Liquid Temperature: 22°C

Communication System: LTE Band 2 Professional 1900MHz; Frequency: 1880 MHz; Duty Cycle: 1:1

Probe: EX3DV4 - SN3754ConvF(7.6, 7.6, 7.6); Calibrated: 1/13/2017

**LTE Band 2 20MHz 100RB 0offset Ground Mode/Area Scan (131x211x1):**

Measurement grid: dx=10 mm, dy=10 mm

Maximum value of SAR (Measurement) = 1.09 W/kg

**LTE Band 2 20MHz 100RB 0offset Ground Mode/Zoom Scan (7x7x7)/Cube 0:**

Measurement grid: dx=5mm, dy=5mm, dz=5mm

Reference Value = 0.6240 V/m; Power Drift = -0.18 dB

Peak SAR (extrapolated) = 2.04 W/kg

SAR(1 g) = 0.869 W/kg; SAR(10 g) = 0.383 W/kg

Maximum value of SAR (measured) = 1.03 W/kg

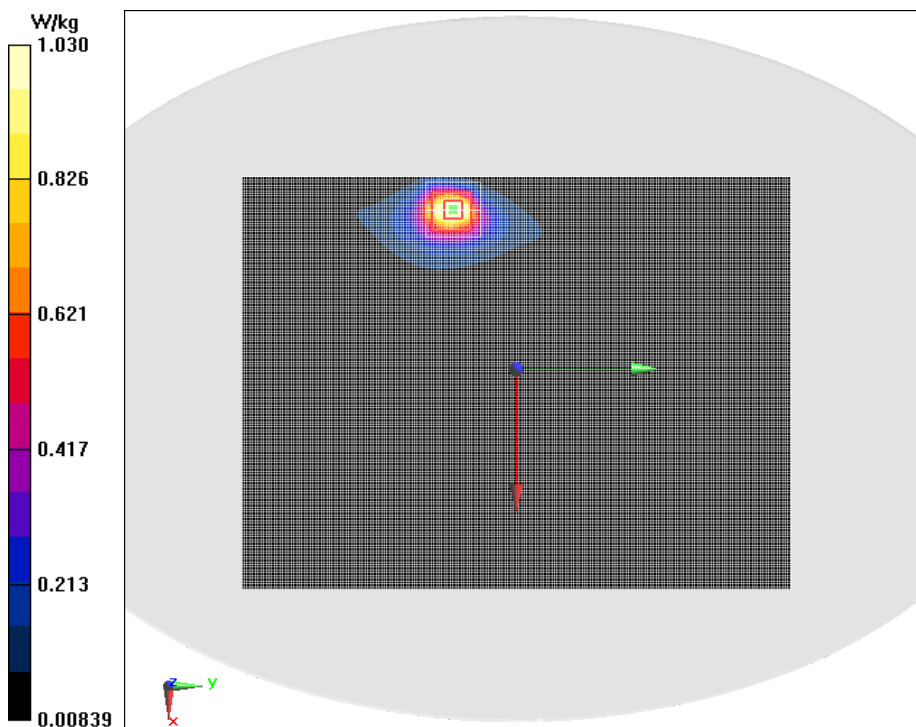

**Fig.11 LTE Band 2 20MHz 100RB 0offset Ground Mode**

**LTE Band 2 20MHz 50RB 0offset Ground Mode Middle repeated 0mm**

Date/Time: 2017/4/27

Electronics: DAE4 Sn1244

Medium: Body 1900MHz

Medium parameters used:  $f = 1880 \text{ MHz}$ ;  $\sigma = 1.551 \text{ S/m}$ ;  $\epsilon_r = 54.667$ ;  $\rho = 1000 \text{ kg/m}^3$

Ambient Temperature: 22°C    Liquid Temperature: 22°C

Communication System: LTE Band 2 Professional 1900MHz;    Frequency: 1880 MHz; Duty Cycle: 1:1

Probe: EX3DV4 - SN3754ConvF(7.6, 7.6, 7.6); Calibrated: 1/13/2017

**LTE Band 2 20MHz 50RB 0offset Ground Mode Middle repeated/Area Scan (131x211x1):**

Measurement grid:  $dx=10 \text{ mm}$ ,  $dy=10 \text{ mm}$

Maximum value of SAR (Measurement) = 1.01 W/kg

**LTE Band 2 20MHz 50RB 0offset Ground Mode Middle repeated/Zoom Scan (7x7x7)/Cube 0:**

Measurement grid:  $dx=5\text{mm}$ ,  $dy=5\text{mm}$ ,  $dz=5\text{mm}$

Reference Value = 1.404 V/m; Power Drift = -0.15 dB

Peak SAR (extrapolated) = 2.03 W/kg

SAR(1 g) = 0.874 W/kg; SAR(10 g) = 0.386 W/kg

Maximum value of SAR (measured) = 0.983 W/kg

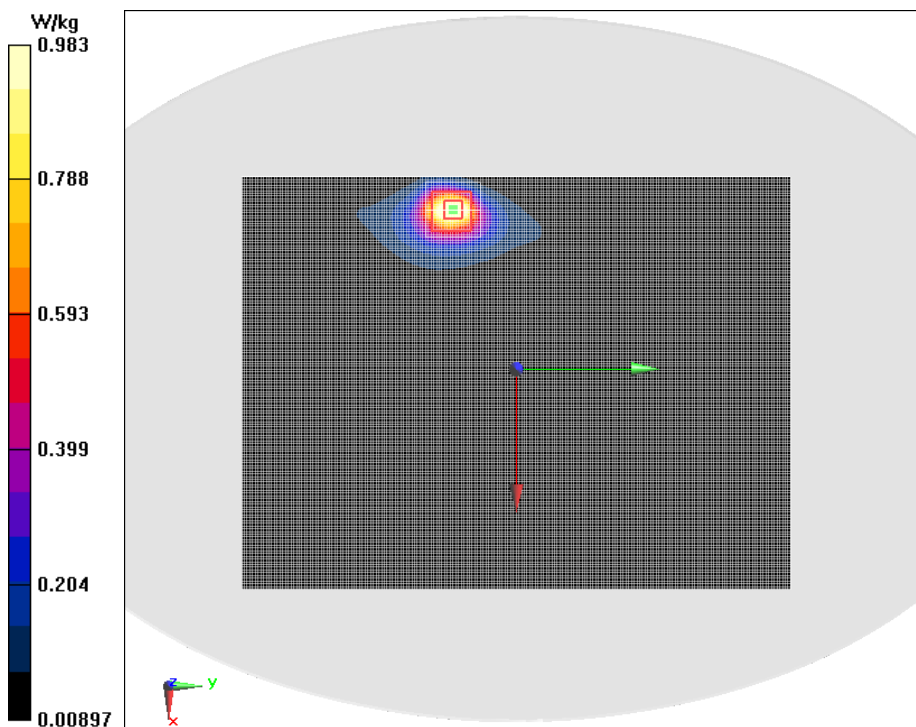

**Fig.12 LTE Band 2 20MHz 50RB 0offset Ground Mode Middle repeated**

**LTE Band 4 20MHz 1RB 0offset Ground Mode High 14mm**

Date/Time: 2017/4/29

Electronics: DAE4 Sn1244

Medium: Body 1800MHz

Medium parameters used:  $f = 1745 \text{ MHz}$ ;  $\sigma = 1.435 \text{ S/m}$ ;  $\epsilon_r = 52.3$ ;  $\rho = 1000 \text{ kg/m}^3$

Ambient Temperature: 22°C      Liquid Temperature: 22°C

Communication System: LTE Band 4 Professional 1800MHz;    Frequency: 1745 MHz; Duty Cycle: 1:1

Probe: EX3DV4 - SN3754ConvF(7.8, 7.8, 7.8); Calibrated: 1/13/2017

**LTE Band 4 20MHz 1RB 0offset Ground Mode High 14mm/Area Scan (131x211x1):**

Measurement grid:  $dx=10 \text{ mm}$ ,  $dy=10 \text{ mm}$

Maximum value of SAR (Measurement) = 1.03 W/kg

**LTE Band 4 20MHz 1RB 0offset Ground Mode High 14mm/Zoom Scan (7x7x7)/Cube 0:**

Measurement grid:  $dx=5\text{mm}$ ,  $dy=5\text{mm}$ ,  $dz=5\text{mm}$

Reference Value = 6.714 V/m; Power Drift = 0.14 dB

Peak SAR (extrapolated) = 1.59 W/kg

SAR(1 g) = 0.957 W/kg; SAR(10 g) = 0.572 W/kg

Maximum value of SAR (measured) = 1.03 W/kg

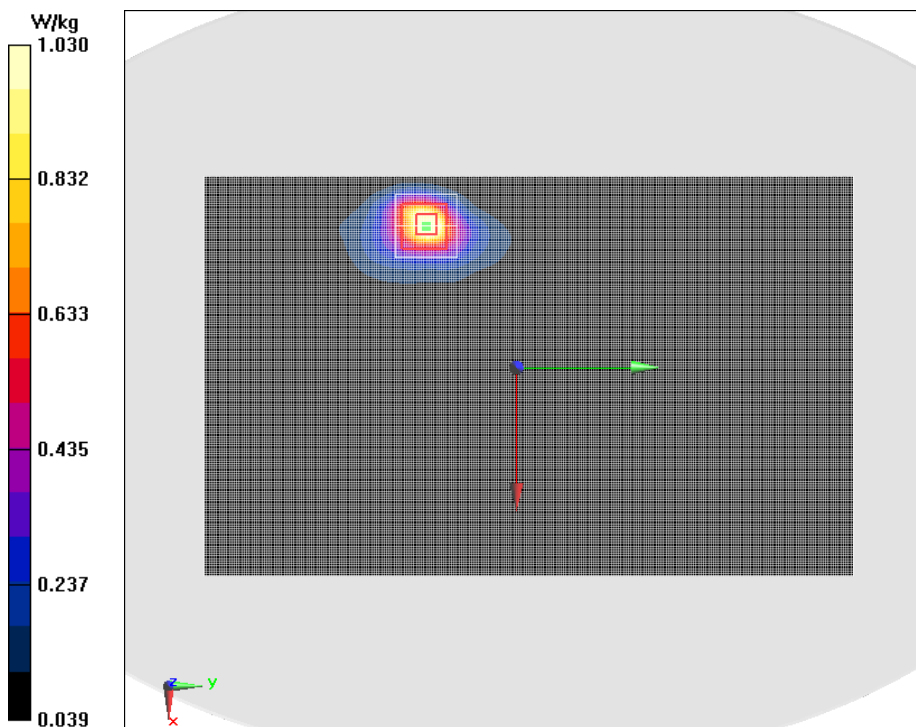

**Fig.13 LTE Band 4 20MHz 1RB 0offset Ground Mode High 14mm**



**LTE Band 4 20MHz 50RB 0offset Ground Mode Middle 14mm**

Date/Time: 2017/4/29

Electronics: DAE4 Sn1244

Medium: Body 1800MHz

Medium parameters used (interpolated):  $f = 1732.5$  MHz;  $\sigma = 1.422$  S/m;  $\epsilon_r = 52.305$ ;  $\rho = 1000$  kg/m<sup>3</sup>

Ambient Temperature:22°C      Liquid Temperature:22°C

Communication System: LTE Band 4 Professional 1800MHz; Frequency: 1732.5 MHz; Duty Cycle: 1:1

Probe: EX3DV4 - SN3754ConvF(7.8, 7.8, 7.8); Calibrated: 1/13/2017

**LTE Band 4 20MHz 50RB 0offset Ground Mode Middle 14mm/Area Scan (131x211x1):**

Measurement grid: dx=10 mm, dy=10 mm

Maximum value of SAR (Measurement) = 0.815 W/kg

**LTE Band 4 20MHz 50RB 0offset Ground Mode Middle 14mm/Zoom Scan (7x7x7)/Cube 0:**

Measurement grid: dx=5mm, dy=5mm, dz=5mm

Reference Value = 6.176 V/m; Power Drift = -0.14 dB

Peak SAR (extrapolated) = 1.22 W/kg

SAR(1 g) = 0.743 W/kg; SAR(10 g) = 0.439 W/kg

Maximum value of SAR (measured) = 0.817 W/kg

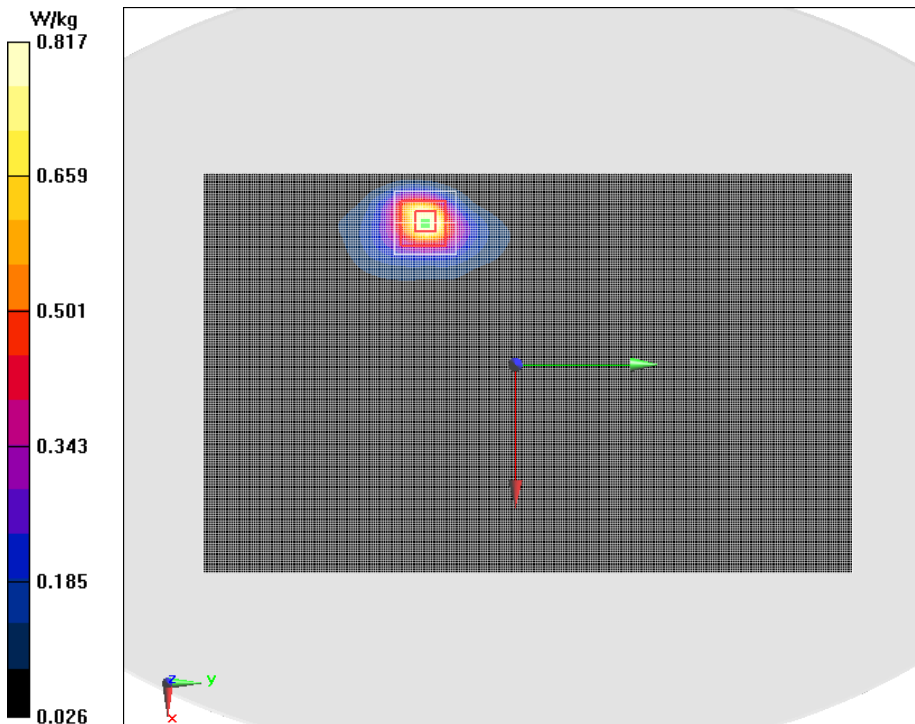

**Fig.14 LTE Band 4 20MHz 50RB 0offset Ground Mode Middle 14mm**

**LTE Band 4 20MHz 100RB 0offset Ground Mode Middle 14mm**

Date/Time: 2017/4/29

Electronics: DAE4 Sn1244

Medium: Body 1800MHz

Medium parameters used (interpolated):  $f = 1732.5$  MHz;  $\sigma = 1.422$  S/m;  $\epsilon_r = 52.305$ ;  $\rho = 1000$  kg/m<sup>3</sup>

Ambient Temperature:22°C      Liquid Temperature:22°C

Communication System: LTE Band 4 Professional 1800MHz; Frequency: 1732.5 MHz; Duty Cycle: 1:1

Probe: EX3DV4 - SN3754ConvF(7.8, 7.8, 7.8); Calibrated: 1/13/2017

**LTE Band 4 20MHz 100RB 0offset Ground Mode Middle 14mm/Area Scan (131x211x1):**

Measurement grid: dx=10 mm, dy=10 mm

Maximum value of SAR (Measurement) = 0.798 W/kg

**LTE Band 4 20MHz 100RB 0offset Ground Mode Middle 14mm/Zoom Scan (7x7x7)/Cube 0:**

Measurement grid: dx=5mm, dy=5mm, dz=5mm

Reference Value = 7.592 V/m; Power Drift = 0.12 dB

Peak SAR (extrapolated) = 1.31 W/kg

SAR(1 g) = 0.743 W/kg; SAR(10 g) = 0.418 W/kg

Maximum value of SAR (measured) = 0.833 W/kg

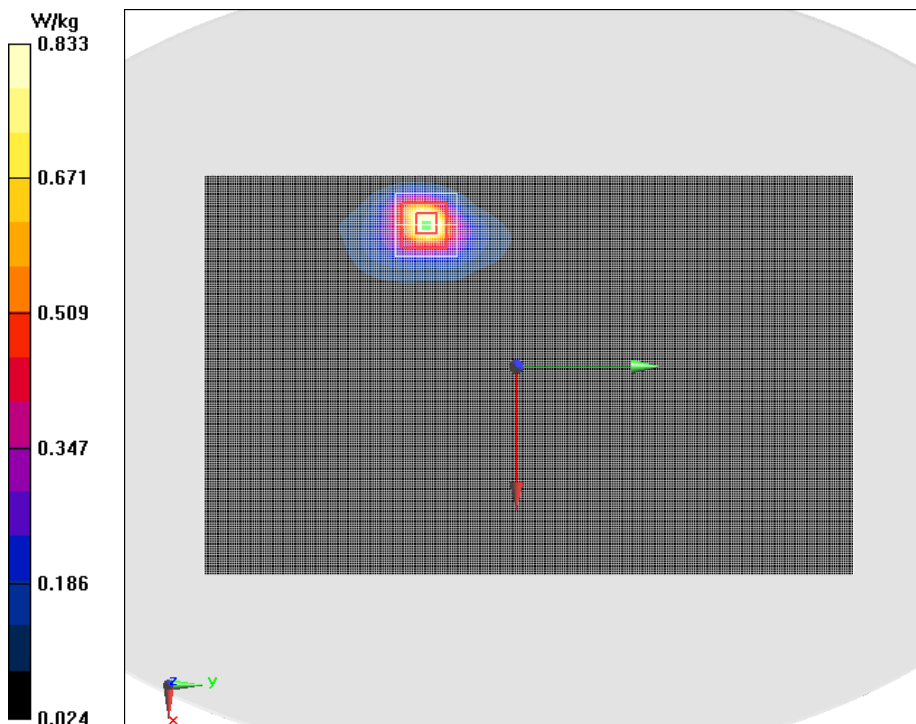

**Fig.15 LTE Band 4 20MHz 100RB 0offset Ground Mode Middle 14mm**

**LTE Band 4 20MHz 1RB 0offset Ground Mode High 14mm repeated**

Date/Time: 2017/4/29

Electronics: DAE4 Sn1244

Medium: Body 1800MHz

Medium parameters used:  $f = 1745 \text{ MHz}$ ;  $\sigma = 1.435 \text{ S/m}$ ;  $\epsilon_r = 52.3$ ;  $\rho = 1000 \text{ kg/m}^3$

Ambient Temperature: 22°C      Liquid Temperature: 22°C

Communication System: LTE Band 4 Professional 1800MHz;    Frequency: 1745 MHz; Duty Cycle: 1:1

Probe: EX3DV4 - SN3754ConvF(7.8, 7.8, 7.8); Calibrated: 1/13/2017

**LTE Band 4 20MHz 1RB 0offset Ground Mode High 14mm repeated/Area Scan (131x211x1):**

Measurement grid:  $dx=10 \text{ mm}$ ,  $dy=10 \text{ mm}$

Maximum value of SAR (Measurement) = 1.11 W/kg

**LTE Band 4 20MHz 1RB 0offset Ground Mode High 14mm repeated/Zoom Scan (7x7x7)/Cube 0:**

Measurement grid:  $dx=5\text{mm}$ ,  $dy=5\text{mm}$ ,  $dz=5\text{mm}$

Reference Value = 6.996 V/m; Power Drift = 0.11 dB

Peak SAR (extrapolated) = 1.65 W/kg

SAR(1 g) = 0.991 W/kg; SAR(10 g) = 0.584 W/kg

Maximum value of SAR (measured) = 1.08 W/kg

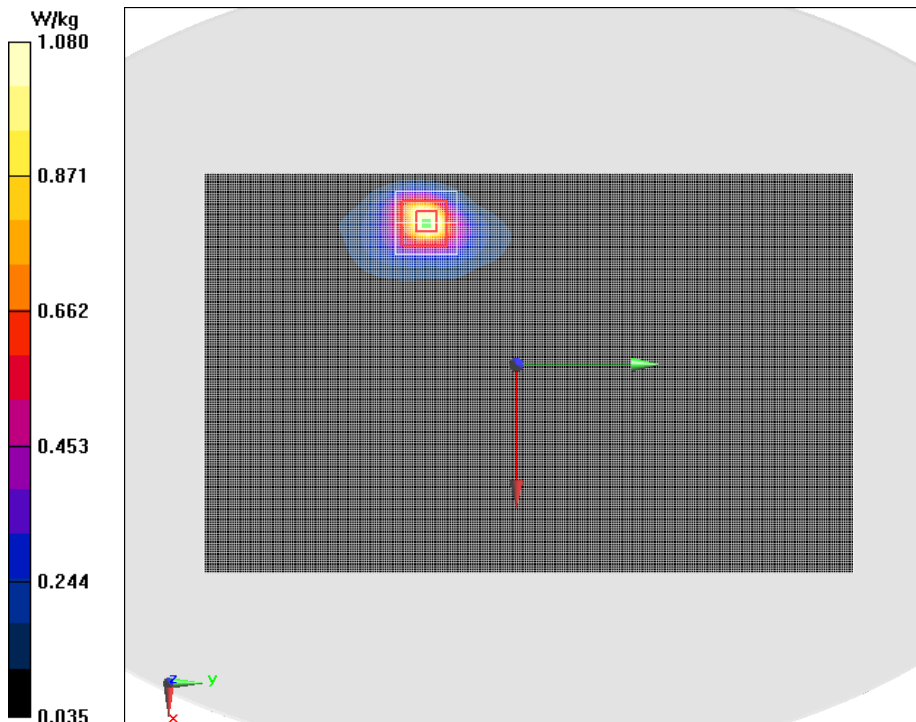

**Fig.16 LTE Band 4 20MHz 1RB 0offset Ground Mode High 14mm repeated**

## LTE Band 4 20MHz 1RB 0offset Ground Mode High 0mm

Date/Time: 2017/4/29

Electronics: DAE4 Sn1244

Medium: Body 1800MHz

Medium parameters used:  $f = 1745 \text{ MHz}$ ;  $\sigma = 1.435 \text{ S/m}$ ;  $\epsilon_r = 52.3$ ;  $\rho = 1000 \text{ kg/m}^3$

Ambient Temperature:  $22^\circ\text{C}$     Liquid Temperature:  $22^\circ\text{C}$

Communication System: LTE Band 4 Professional 1800MHz;    Frequency: 1745 MHz; Duty Cycle: 1:1

Probe: EX3DV4 - SN3754ConvF(7.8, 7.8, 7.8); Calibrated: 1/13/2017

## LTE Band 4 20MHz 1RB 0offset Ground Mode High/Area Scan (131x211x1):

Measurement grid:  $dx=10 \text{ mm}$ ,  $dy=10 \text{ mm}$

Maximum value of SAR (Measurement) = 1.20 W/kg

## LTE Band 4 20MHz 1RB 0offset Ground Mode High/Zoom Scan (7x7x7)/Cube 0:

Measurement grid:  $dx=5\text{mm}$ ,  $dy=5\text{mm}$ ,  $dz=5\text{mm}$

Reference Value = 3.061 V/m; Power Drift = 0.13 dB

Peak SAR (extrapolated) = 2.20 W/kg

SAR(1 g) = 0.960 W/kg; SAR(10 g) = 0.447 W/kg

Maximum value of SAR (measured) = 1.15 W/kg

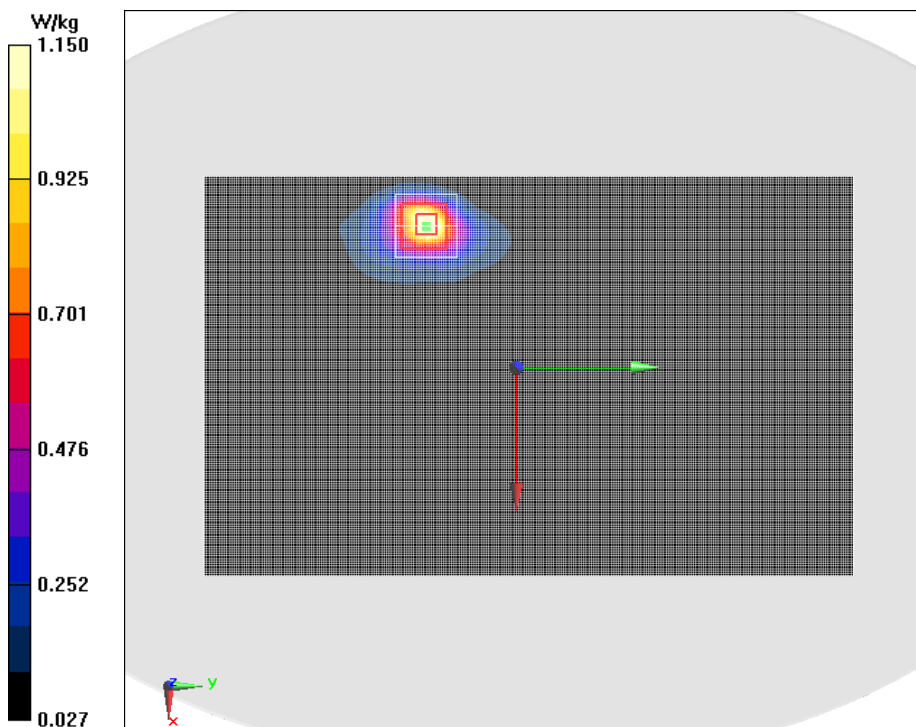

Fig.17 LTE Band 4 20MHz 1RB 0offset Ground Mode High

**LTE Band 4 20MHz 1RB 50offset Ground Mode High 0mm**

Date/Time: 2017/4/29

Electronics: DAE4 Sn1244

Medium: Body 1800MHz

Medium parameters used:  $f = 1745 \text{ MHz}$ ;  $\sigma = 1.435 \text{ S/m}$ ;  $\epsilon_r = 52.3$ ;  $\rho = 1000 \text{ kg/m}^3$

Ambient Temperature: 22°C    Liquid Temperature: 22°C

Communication System: LTE Band 4 Professional 1800MHz;    Frequency: 1745 MHz; Duty Cycle: 1:1

Probe: EX3DV4 - SN3754ConvF(7.8, 7.8, 7.8); Calibrated: 1/13/2017

**LTE Band 4 20MHz 1RB 50offset Ground Mode High/Area Scan (161x261x1):**

Measurement grid:  $dx=10 \text{ mm}$ ,  $dy=10 \text{ mm}$

Maximum value of SAR (Measurement) = 1.10 W/kg

**LTE Band 4 20MHz 1RB 50offset Ground Mode High/Zoom Scan (7x7x7)/Cube 0:**

Measurement grid:  $dx=5\text{mm}$ ,  $dy=5\text{mm}$ ,  $dz=5\text{mm}$

Reference Value = 1.896 V/m; Power Drift = -0.12 dB

Peak SAR (extrapolated) = 2.12 W/kg

SAR(1 g) = 0.933 W/kg; SAR(10 g) = 0.420 W/kg

Maximum value of SAR (measured) = 1.06 W/kg

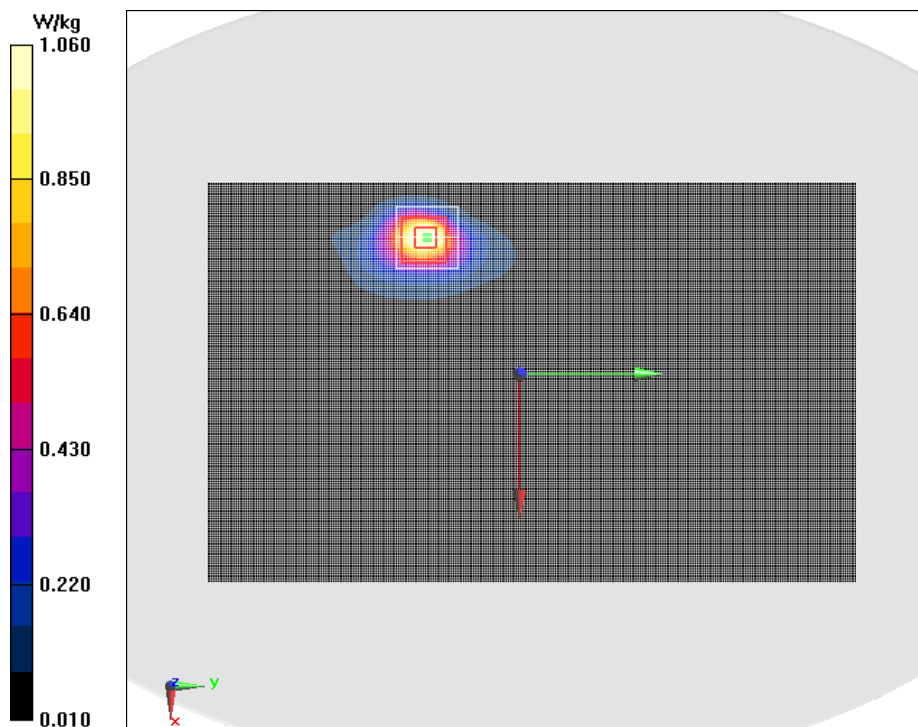

**Fig.18 LTE Band 4 20MHz 1RB 50offset Ground Mode High**

**LTE Band 4 20MHz 1RB 100offset Ground Mode Middle 0mm**

Date/Time: 2017/4/29

Electronics: DAE4 Sn1244

Medium: Body 1800MHz

Medium parameters used (interpolated):  $f = 1732.5$  MHz;  $\sigma = 1.422$  S/m;  $\epsilon_r = 52.305$ ;  $\rho = 1000$  kg/m<sup>3</sup>

Ambient Temperature:22°C      Liquid Temperature:22°C

Communication System: LTE Band 4 Professional 1800MHz; Frequency: 1732.5 MHz; Duty Cycle: 1:1

Probe: EX3DV4 - SN3754ConvF(7.8, 7.8, 7.8); Calibrated: 1/13/2017

**LTE Band 4 20MHz 1RB 100offset Ground Mode Middle 0mm/Area Scan (161x261x1):**

Measurement grid: dx=10 mm, dy=10 mm

Maximum value of SAR (Measurement) = 1.39 W/kg

**LTE Band 4 20MHz 1RB 100offset Ground Mode Middle 0mm/Zoom Scan (7x7x7)/Cube 0:**

Measurement grid: dx=5mm, dy=5mm, dz=5mm

Reference Value = 0.7520 V/m; Power Drift = -0.16 dB

Peak SAR (extrapolated) = 2.02 W/kg

SAR(1 g) = 0.899 W/kg; SAR(10 g) = 0.409 W/kg

Maximum value of SAR (measured) = 1.05 W/kg

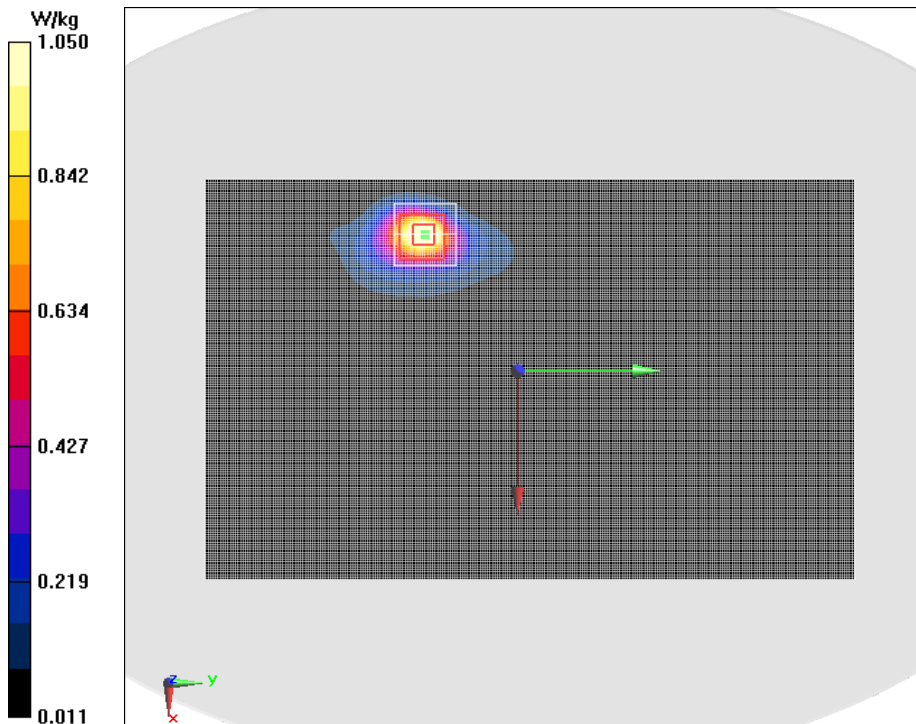

**Fig.19 LTE Band 4 20MHz 1RB 100offset Ground Mode Middle 0mm**



**LTE Band 4 20MHz 1RB 0offset Ground Mode High repeated 0mm**

Date/Time: 2017/4/29

Electronics: DAE4 Sn1244

Medium: Body 1800MHz

Medium parameters used:  $f = 1745 \text{ MHz}$ ;  $\sigma = 1.435 \text{ S/m}$ ;  $\epsilon_r = 52.3$ ;  $\rho = 1000 \text{ kg/m}^3$

Ambient Temperature: 22°C    Liquid Temperature: 22°C

Communication System: LTE Band 4 Professional 1800MHz;    Frequency: 1745 MHz; Duty Cycle: 1:1

Probe: EX3DV4 - SN3754ConvF(7.8, 7.8, 7.8); Calibrated: 1/13/2017

**LTE Band 4 20MHz 1RB 0offset Ground Mode High repeated/Area Scan (161x261x1):**

Measurement grid:  $dx=10 \text{ mm}$ ,  $dy=10 \text{ mm}$

Maximum value of SAR (Measurement) = 1.36 W/kg

**LTE Band 4 20MHz 1RB 0offset Ground Mode High repeated/Zoom Scan (7x7x7)/Cube 0:**

Measurement grid:  $dx=5\text{mm}$ ,  $dy=5\text{mm}$ ,  $dz=5\text{mm}$

Reference Value = 3.016 V/m; Power Drift = 0.17 dB

Peak SAR (extrapolated) = 2.18 W/kg

SAR(1 g) = 0.976 W/kg; SAR(10 g) = 0.452 W/kg

Maximum value of SAR (measured) = 1.58 W/kg

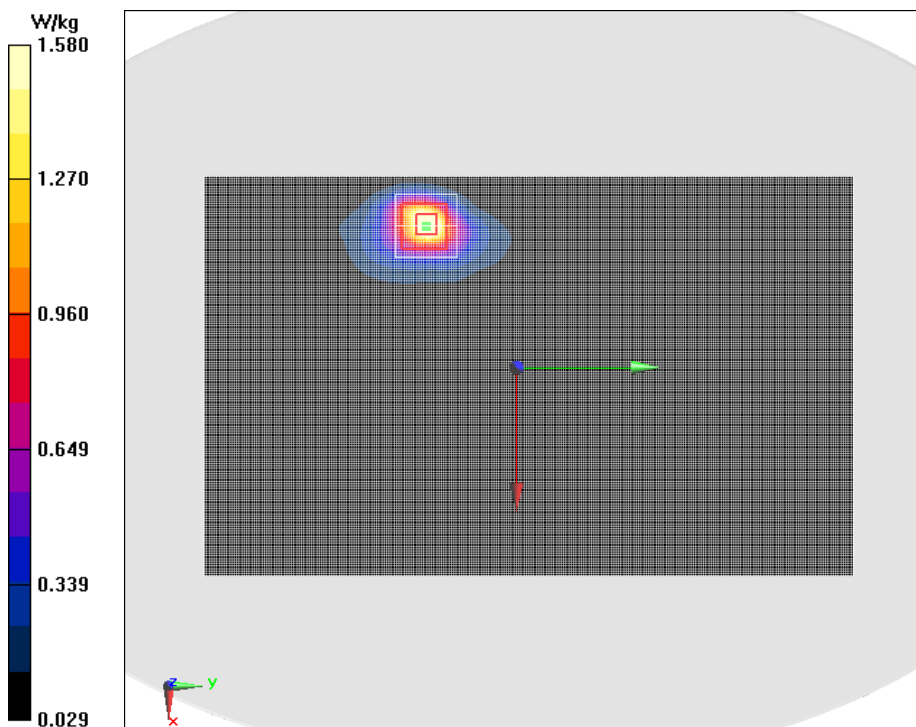

**Fig.20 LTE Band 4 20MHz 1RB 0offset Ground Mode High repeated**

**LTE Band 5 10MHz 1RB 0offset Ground Mode High 14mm**

Date/Time: 2017/4/28

Electronics: DAE4 Sn1244

Medium: Body 835MHz

Medium parameters used:  $f = 844 \text{ MHz}$ ;  $\sigma = 1.008 \text{ S/m}$ ;  $\epsilon_r = 55.203$ ;  $\rho = 1000 \text{ kg/m}^3$

Ambient Temperature: 22°C      Liquid Temperature: 22°C

Communication System: LTE Band 5 Professional 850MHz;    Frequency: 844 MHz; Duty Cycle: 1:1

Probe: EX3DV4 - SN3754ConvF(9.66, 9.66, 9.66); Calibrated: 1/13/2017

**LTE Band 5 10MHz 1RB 0offset Ground Mode High 14mm/Area Scan (131x211x1):**

Measurement grid:  $dx=10 \text{ mm}$ ,  $dy=10 \text{ mm}$

Maximum value of SAR (Measurement) = 0.558 W/kg

**LTE Band 5 10MHz 1RB 0offset Ground Mode High 14mm/Zoom Scan (7x7x7)/Cube 0:**

Measurement grid:  $dx=5\text{mm}$ ,  $dy=5\text{mm}$ ,  $dz=5\text{mm}$

Reference Value = 3.882 V/m; Power Drift = -0.13 dB

Peak SAR (extrapolated) = 0.759 W/kg

SAR(1 g) = 0.480 W/kg; SAR(10 g) = 0.296 W/kg

Maximum value of SAR (measured) = 0.518 W/kg

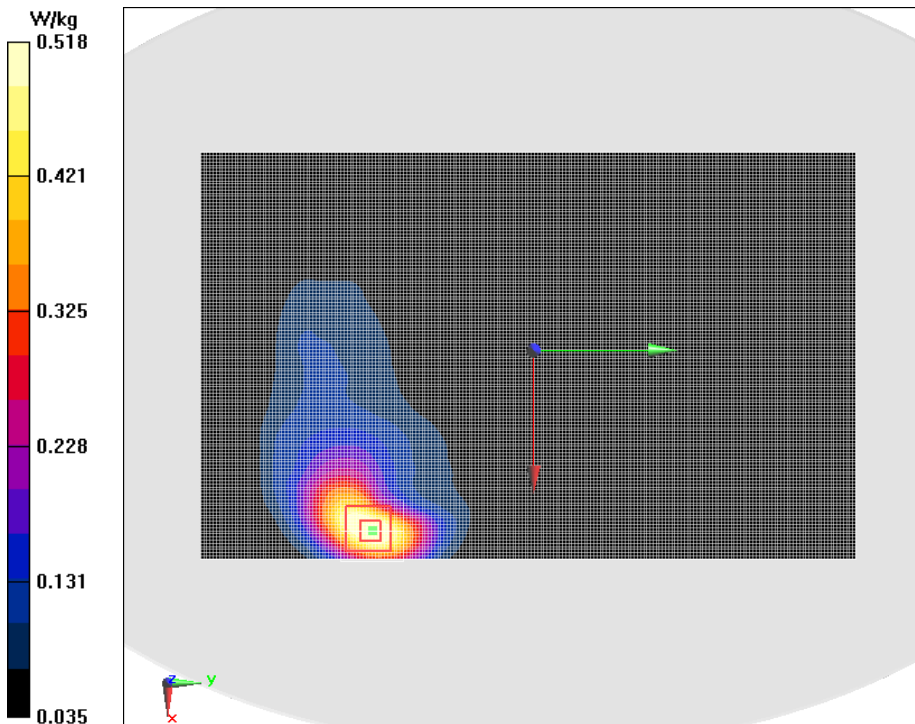

**Fig.21 LTE Band 5 10MHz 1RB 0offset Ground Mode High 14mm**



## LTE Band 5 10MHz 25RB 0offset Ground Mode Middle 14mm

Date/Time: 2017/4/28

Electronics: DAE4 Sn1244

Medium: Body 835MHz

Medium parameters used (interpolated):  $f = 836.5$  MHz;  $\sigma = 0.997$  S/m;  $\epsilon_r = 55.152$ ;  $\rho = 1000$  kg/m<sup>3</sup>

Ambient Temperature:22°C      Liquid Temperature:22°C

Communication System: LTE Band 5 Professional 850MHz;    Frequency: 836.5 MHz; Duty Cycle: 1:1

Probe: EX3DV4 - SN3754ConvF(9.66, 9.66, 9.66); Calibrated: 1/13/2017

## LTE Band 5 10MHz 25RB 0offset Ground Mode Middle 14mm/Area Scan (151x201x1):

Measurement grid: dx=10 mm, dy=10 mm

Maximum value of SAR (Measurement) = 0.427 W/kg

## LTE Band 5 10MHz 25RB 0offset Ground Mode Middle 14mm/Zoom Scan (7x7x7)/Cube 0:

Measurement grid: dx=5mm, dy=5mm, dz=5mm

Reference Value = 3.476 V/m; Power Drift = 0.05 dB

Peak SAR (extrapolated) = 0.614 W/kg

SAR(1 g) = 0.384 W/kg; SAR(10 g) = 0.236 W/kg

Maximum value of SAR (measured) = 0.419 W/kg

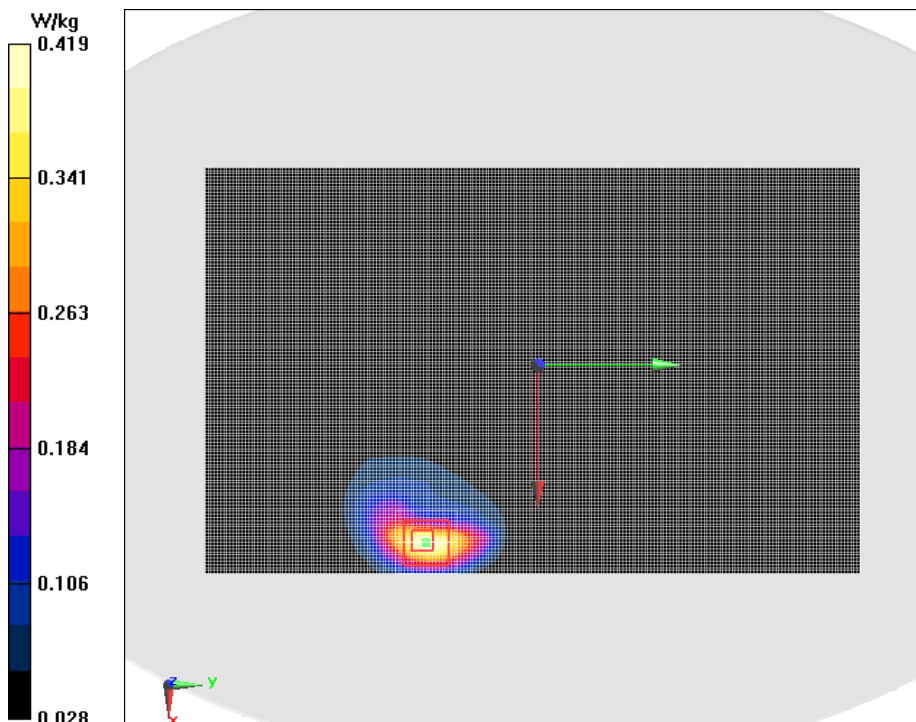

Fig.22 LTE Band 5 10MHz 25RB 0offset Ground Mode Middle 14mm

## LTE Band 5 10MHz 1RB 0offset Ground Mode Low 0mm

Date/Time: 2017/4/28

Electronics: DAE4 Sn1244

Medium: Body 835MHz

Medium parameters used:  $f = 829$  MHz;  $\sigma = 0.995$  S/m;  $\epsilon_r = 55.141$ ;  $\rho = 1000$  kg/m<sup>3</sup>

Ambient Temperature: 22°C    Liquid Temperature: 22°C

Communication System: LTE Band 5 Professional 850MHz;    Frequency: 829 MHz; Duty Cycle: 1:1

Probe: EX3DV4 - SN3754ConvF(9.66, 9.66, 9.66); Calibrated: 1/13/2017

## LTE Band 5 10MHz 1RB 0offset Ground Mode Low 0mm/Area Scan (131x211x1):

Measurement grid: dx=10 mm, dy=10 mm

Maximum value of SAR (Measurement) = 0.464 W/kg

## LTE Band 5 10MHz 1RB 0offset Ground Mode Low 0mm/Zoom Scan (7x7x7)/Cube 0:

Measurement grid: dx=5mm, dy=5mm, dz=5mm

Reference Value = 0.7010 V/m; Power Drift = 0.05 dB

Peak SAR (extrapolated) = 0.930 W/kg

SAR(1 g) = 0.409 W/kg; SAR(10 g) = 0.201 W/kg

Maximum value of SAR (measured) = 0.458 W/kg

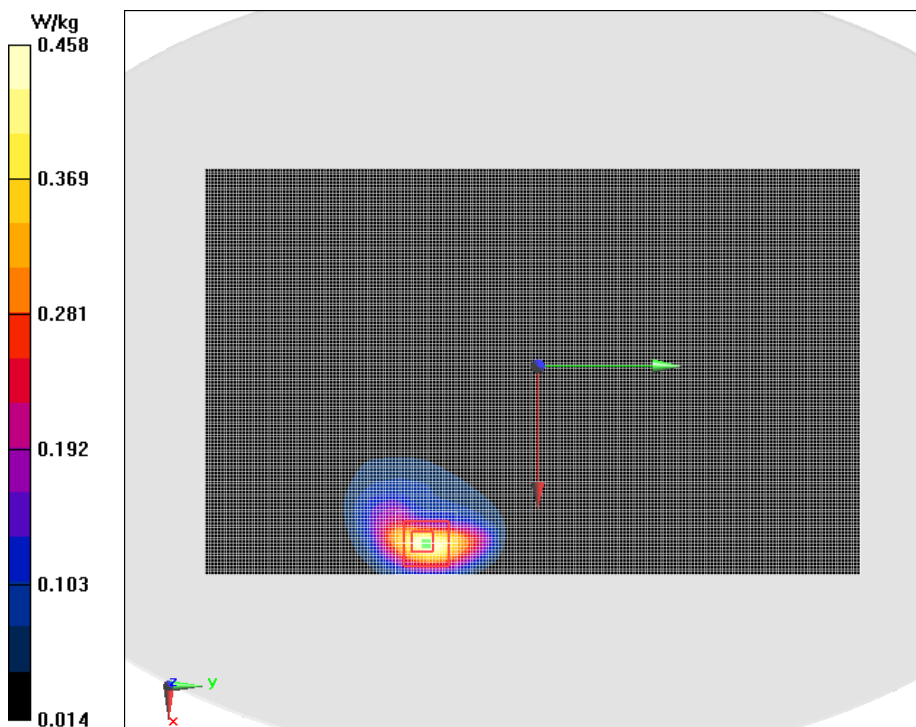

Fig.23 LTE Band 5 10MHz 1RB 0offset Ground Mode Low 0mm

**LTE Band 5 10MHz 25RB 0offset Ground Mode Low 0mm**

Date/Time: 2017/4/28

Electronics: DAE4 Sn1244

Medium: Body 835MHz

Medium parameters used:  $f = 829 \text{ MHz}$ ;  $\sigma = 0.995 \text{ S/m}$ ;  $\epsilon_r = 55.141$ ;  $\rho = 1000 \text{ kg/m}^3$

Ambient Temperature: 22°C    Liquid Temperature: 22°C

Communication System: LTE Band 5 Professional 850MHz;    Frequency: 829 MHz; Duty Cycle: 1:1

Probe: EX3DV4 - SN3754ConvF(9.66, 9.66, 9.66); Calibrated: 1/13/2017

**LTE Band 5 10MHz 25RB 0offset Ground Mode Low 0mm/Area Scan (131x211x1):**

Measurement grid:  $dx=10 \text{ mm}$ ,  $dy=10 \text{ mm}$

Maximum value of SAR (Measurement) = 0.459 W/kg

**LTE Band 5 10MHz 25RB 0offset Ground Mode Low 0mm/Zoom Scan (7x7x7)/Cube 0:**

Measurement grid:  $dx=5\text{mm}$ ,  $dy=5\text{mm}$ ,  $dz=5\text{mm}$

Reference Value = 1.173 V/m; Power Drift = -0.01 dB

Peak SAR (extrapolated) = 0.955 W/kg

SAR(1 g) = 0.433 W/kg; SAR(10 g) = 0.216 W/kg

Maximum value of SAR (measured) = 0.490 W/kg

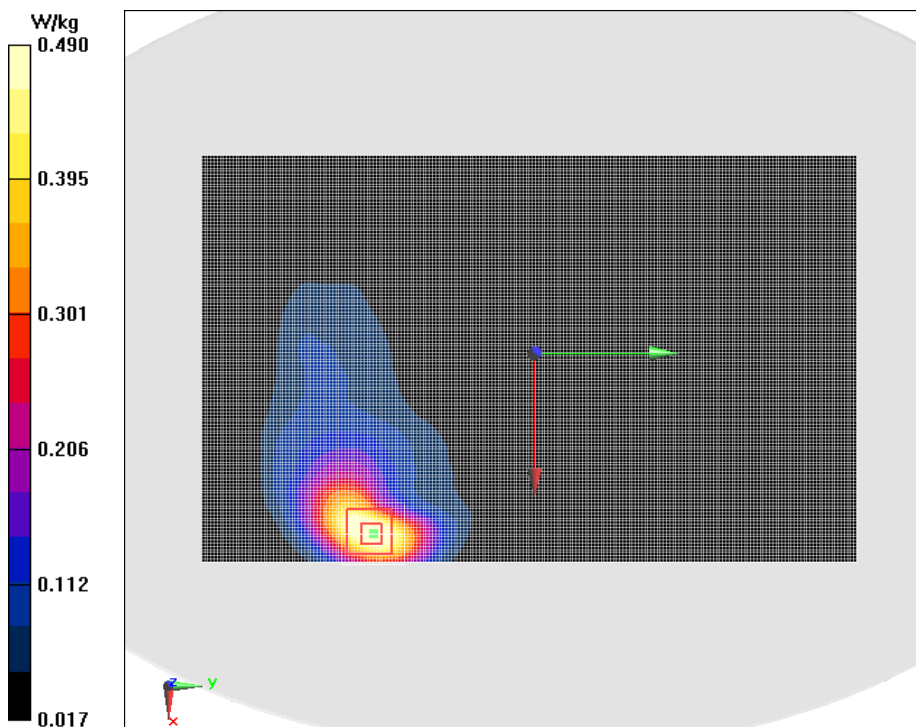

**Fig.24 LTE Band 5 10MHz 25RB 0offset Ground Mode Low 0mm**

**802.11b Ground Mode Low 14mm**

Date/Time: 2017/5/23

Electronics: DAE4 Sn1244

Medium: Body 2450MHz

Medium parameters used:  $f = 2412 \text{ MHz}$ ;  $\sigma = 1.932 \text{ S/m}$ ;  $\epsilon_r = 53.051$ ;  $\rho = 1000 \text{ kg/m}^3$

Ambient Temperature:  $22^\circ\text{C}$     Liquid Temperature:  $22^\circ\text{C}$

Communication System: Wifi 2450 2450MHz;    Frequency: 2412 MHz; Duty Cycle: 1:1

Probe: EX3DV4 - SN3754ConvF(7.22, 7.22, 7.22); Calibrated: 1/13/2017

**802.11b Ground Mode Low 14mm/Area Scan (131x211x1):**

Measurement grid:  $dx=10 \text{ mm}$ ,  $dy=10 \text{ mm}$

Maximum value of SAR (Measurement) = 0.128 W/kg

**802.11b Ground Mode Low 14mm/Zoom Scan (7x7x7)/Cube 0:**

Measurement grid:  $dx=5\text{mm}$ ,  $dy=5\text{mm}$ ,  $dz=5\text{mm}$

Reference Value = 2.111 V/m; Power Drift = -0.05 dB

Peak SAR (extrapolated) = 0.245 W/kg

SAR(1 g) = 0.117 W/kg; SAR(10 g) = 0.059 W/kg

Maximum value of SAR (measured) = 0.126 W/kg

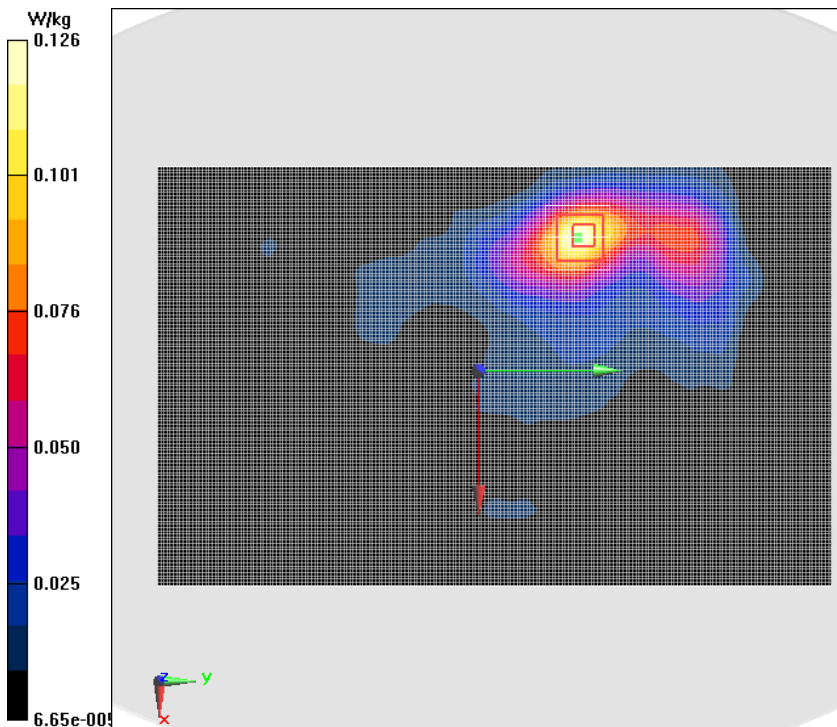

**Fig.25 802.11b Ground Mode Low 14mm**

**802.11b Ground Mode Low**

Date/Time: 2017/5/23

Electronics: DAE4 Sn1244

Medium: Body 2450MHz

Medium parameters used:  $f = 2412 \text{ MHz}$ ;  $\sigma = 1.932 \text{ S/m}$ ;  $\epsilon_r = 53.051$ ;  $\rho = 1000 \text{ kg/m}^3$

Ambient Temperature: 22°C    Liquid Temperature: 22°C

Communication System: Wifi 2450 2450MHz;    Frequency: 2412 MHz; Duty Cycle: 1:1

Probe: EX3DV4 - SN3754ConvF(7.22, 7.22, 7.22); Calibrated: 1/13/2017

**802.11b Ground Mode Low/Area Scan (141x201x1):**

Measurement grid:  $dx=10 \text{ mm}$ ,  $dy=10 \text{ mm}$

Maximum value of SAR (Measurement) = 0.491 W/kg

**802.11b Ground Mode Low/Zoom Scan (7x7x7)/Cube 0:**

Measurement grid:  $dx=5\text{mm}$ ,  $dy=5\text{mm}$ ,  $dz=5\text{mm}$

Reference Value = 0 V/m; Power Drift = 0.12 dB

Peak SAR (extrapolated) = 1.02 W/kg

SAR(1 g) = 0.344 W/kg; SAR(10 g) = 0.137 W/kg

Maximum value of SAR (measured) = 0.385 W/kg

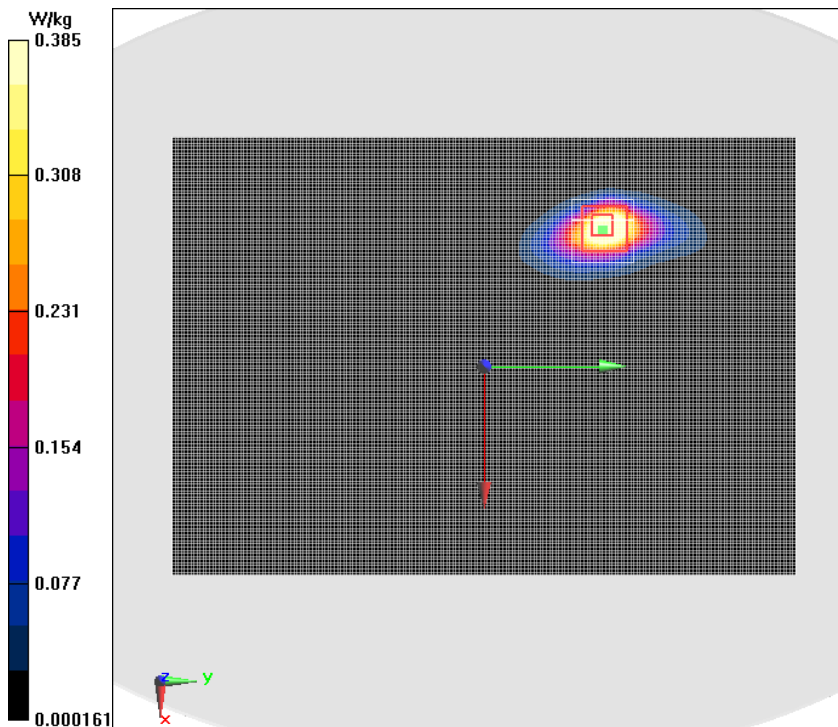

**Fig.26 802.11b Ground Mode Low**

**LTE Band 7 20MHz 1RB 0offset Top Mode High 14mm**

Date/Time: 2017/6/5

Electronics: DAE4 Sn1244

Medium: Body 2600MHz

Medium parameters used (interpolated):  $f = 2560$  MHz;  $\sigma = 2.044$  S/m;  $\epsilon_r = 53.474$ ;  $\rho = 1000$  kg/m<sup>3</sup>

Ambient Temperature:22°C Liquid Temperature:22°C

Communication System: LTE Band 7 Professional 2600MHz; Frequency: 2560 MHz; Duty Cycle: 1:1

Probe: EX3DV4 - SN3754ConvF(7.15, 7.15, 7.15); Calibrated: 1/13/2017

**LTE Band 7 20MHz 1RB 0offset Top Mode High 14mm/Area Scan (41x191x1):**

Measurement grid: dx=10 mm, dy=10 mm

Maximum value of SAR (Measurement) = 1.18 W/kg

**LTE Band 7 20MHz 1RB 0offset Top Mode High 14mm/Zoom Scan (7x7x7)/Cube 0:**

Measurement grid: dx=5mm, dy=5mm, dz=5mm

Reference Value = 14.74 V/m; Power Drift = 0.08 dB

Peak SAR (extrapolated) = 1.82 W/kg

SAR(1 g) = 1.05 W/kg; SAR(10 g) = 0.569 W/kg

Maximum value of SAR (measured) = 1.17 W/kg

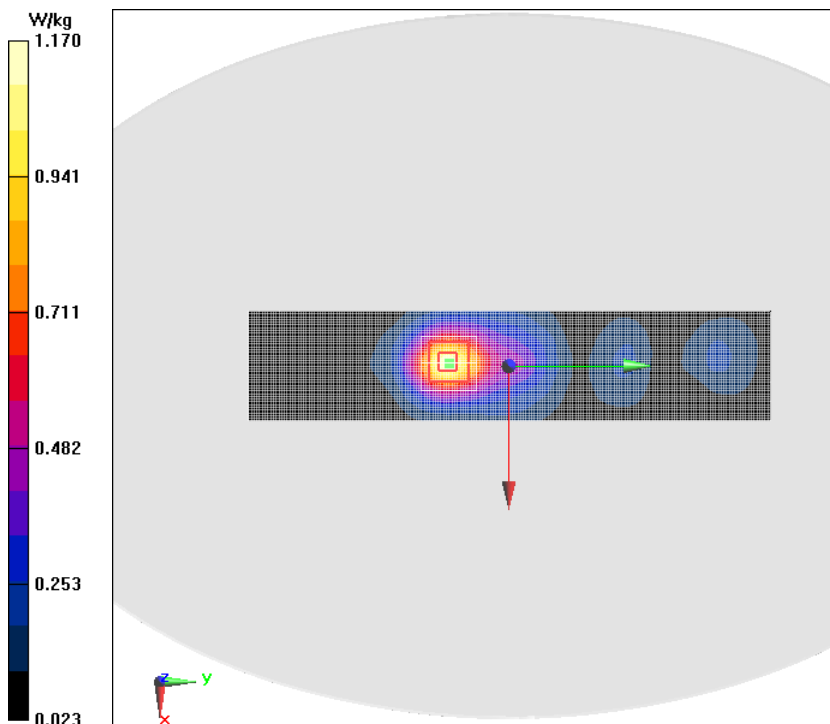

**Fig.27 LTE Band 7 20MHz 1RB 0offset Top Mode High 14mm/**



**LTE Band 7 20MHz 50RB 0offset Top Mode High 14mm**

Date/Time: 2017/6/5

Electronics: DAE4 Sn1244

Medium: Body 2600MHz

Medium parameters used (interpolated):  $f = 2560$  MHz;  $\sigma = 2.044$  S/m;  $\epsilon_r = 53.474$ ;  $\rho = 1000$  kg/m<sup>3</sup>

Ambient Temperature:22°C Liquid Temperature:22°C

Communication System: LTE Band 7 Professional 2600MHz; Frequency: 2560 MHz; Duty Cycle: 1:1

Probe: EX3DV4 - SN3754ConvF(7.15, 7.15, 7.15); Calibrated: 1/13/2017

**LTE Band 7 20MHz 50RB 0offset Top Mode High 14mm/Area Scan (41x191x1):**

Measurement grid: dx=10 mm, dy=10 mm

Maximum value of SAR (Measurement) = 0.966 W/kg

**LTE Band 7 20MHz 50RB 0offset Top Mode High 14mm/Zoom Scan (7x7x7)/Cube 0:**

Measurement grid: dx=5mm, dy=5mm, dz=5mm

Reference Value = 13.20 V/m; Power Drift = -0.02 dB

Peak SAR (extrapolated) = 1.50 W/kg

SAR(1 g) = 0.848 W/kg; SAR(10 g) = 0.460 W/kg

Maximum value of SAR (measured) = 0.939 W/kg

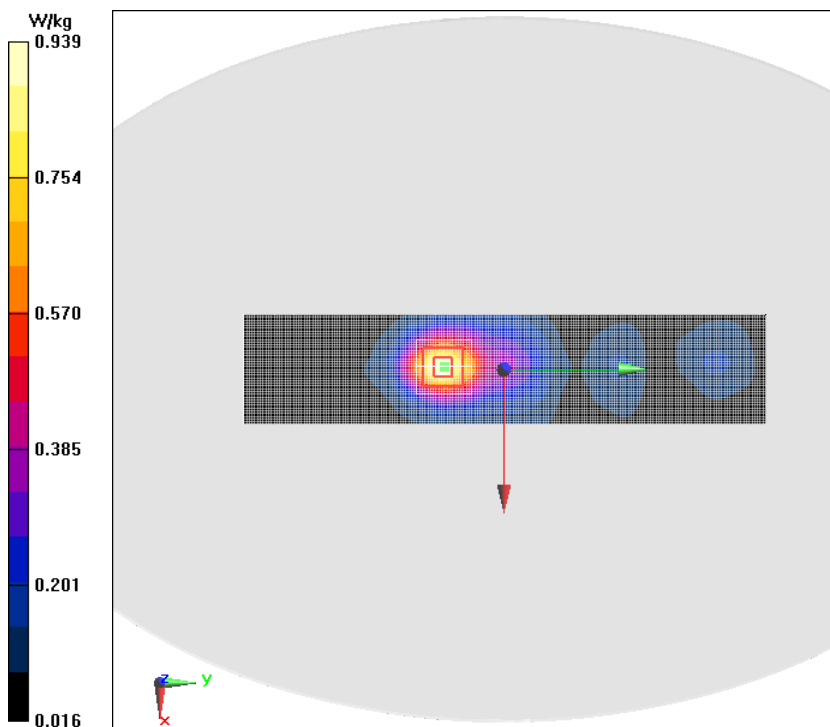

**Fig.28 LTE Band 7 20MHz 50RB 0offset Top Mode High 14mm**

**LTE Band 7 20MHz 1RB 0offset Top Mode High 14mm repeated**

Date/Time: 2017/6/5

Electronics: DAE4 Sn1244

Medium: Body 2600MHz

Medium parameters used (interpolated):  $f = 2560$  MHz;  $\sigma = 2.044$  S/m;  $\epsilon_r = 53.474$ ;  $\rho = 1000$  kg/m<sup>3</sup>

Ambient Temperature:22°C Liquid Temperature:22°C

Communication System: LTE Band 7 Professional 2600MHz; Frequency: 2560 MHz; Duty Cycle: 1:1

Probe: EX3DV4 - SN3754ConvF(7.15, 7.15, 7.15); Calibrated: 1/13/2017

**LTE Band 7 20MHz 1RB 0offset Top Mode High 14mm repeated/Area Scan (41x191x1):**

Measurement grid: dx=10 mm, dy=10 mm

Maximum value of SAR (Measurement) = 1.15 W/kg

**LTE Band 7 20MHz 1RB 0offset Top Mode High 14mm repeated/Zoom Scan (7x7x7)/Cube 0:**

Measurement grid: dx=5mm, dy=5mm, dz=5mm

Reference Value = 14.73 V/m; Power Drift = -0.06 dB

Peak SAR (extrapolated) = 1.79 W/kg

SAR(1 g) = 1.03 W/kg; SAR(10 g) = 0.553 W/kg

Maximum value of SAR (measured) = 1.14 W/kg

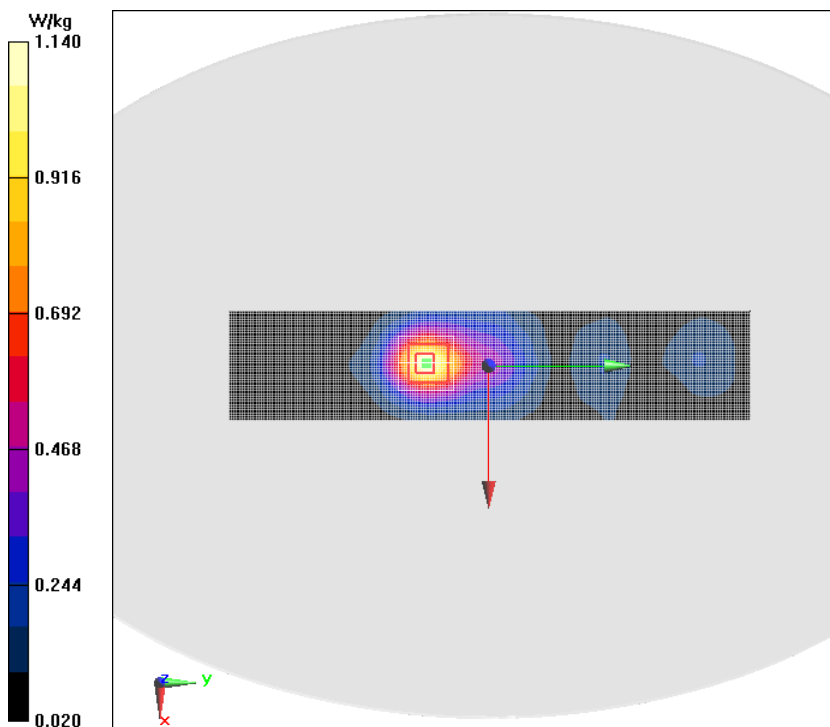

**Fig.29 LTE Band 7 20MHz 1RB 0offset Top Mode High 14mm repeated**



**LTE Band 7 20MHz 1RB 0offset Ground Mode Middle 0mm**

Date/Time: 2017/6/5

Electronics: DAE4 Sn1244

Medium: Body 2600MHz

Medium parameters used:  $f = 2535$  MHz;  $\sigma = 2.004$  S/m;  $\epsilon_r = 53.723$ ;  $\rho = 1000$  kg/m<sup>3</sup>

Ambient Temperature:22°C    Liquid Temperature:22°C

Communication System: LTE Band 7 Professional 2600MHz;    Frequency: 2535 MHz; Duty Cycle: 1:1

Probe: EX3DV4 - SN3754ConvF(7.22, 7.22, 7.22); Calibrated: 1/13/2017

**LTE Band 7 20MHz 1RB 0offset Ground Mode Middle 0mm/Area Scan (151x201x1):**

Measurement grid: dx=10 mm, dy=10 mm

Maximum value of SAR (Measurement) = 0.469 W/kg

**LTE Band 7 20MHz 1RB 0offset Ground Mode Middle 0mm/Zoom Scan (7x7x7)/Cube 0:**

Measurement grid: dx=5mm, dy=5mm, dz=5mm

Reference Value = 0.5960 V/m; Power Drift = 0.02 dB

Peak SAR (extrapolated) = 1.16 W/kg

SAR(1 g) = 0.480 W/kg; SAR(10 g) = 0.187 W/kg

Maximum value of SAR (measured) = 0.498 W/kg

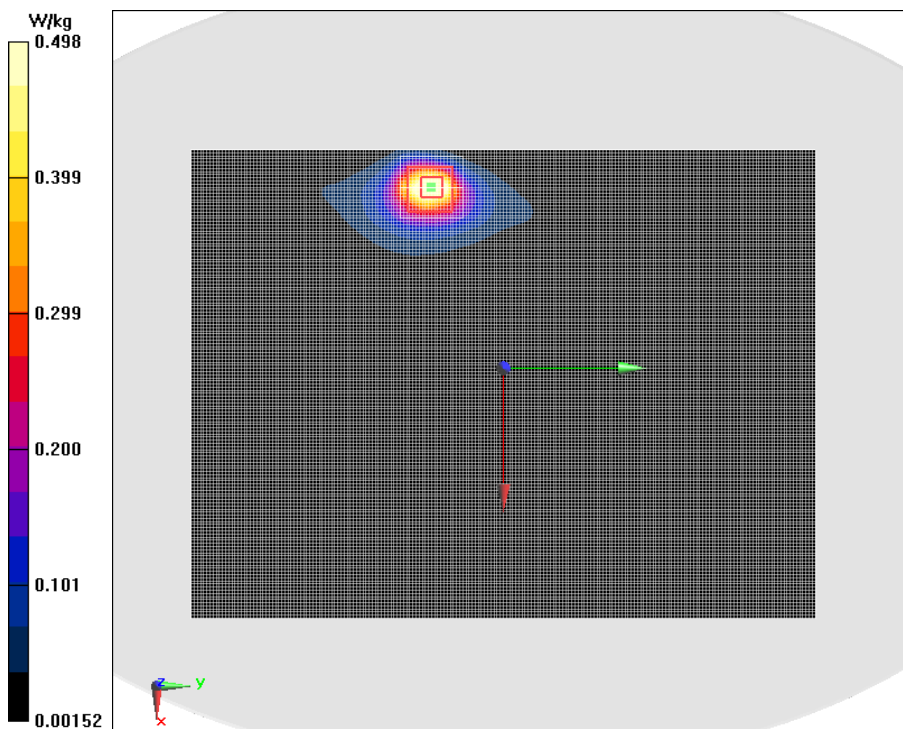

**Fig.30 LTE Band 7 20MHz 1RB 0offset Ground Mode Middle 0mm**

**LTE Band 7 20MHz 50RB 0offset Top Mode High 0mm**

Date/Time: 2017/6/5

Electronics: DAE4 Sn1244

Medium: Body 2600MHz

Medium parameters used (interpolated):  $f = 2560$  MHz;  $\sigma = 2.044$  S/m;  $\epsilon_r = 53.474$ ;  $\rho = 1000$  kg/m<sup>3</sup>

Ambient Temperature:22°C Liquid Temperature:22°C

Communication System: LTE Band 7 Professional 2600MHz; Frequency: 2560 MHz; Duty Cycle: 1:1

Probe: EX3DV4 - SN3754ConvF(7.15, 7.15, 7.15); Calibrated: 1/13/2017

**LTE Band 7 20MHz 50RB 0offset Top Mode High 0mm/Area Scan (41x191x1):**

Measurement grid: dx=10 mm, dy=10 mm

Maximum value of SAR (Measurement) = 0.838 W/kg

**LTE Band 7 20MHz 50RB 0offset Top Mode High 0mm/Zoom Scan (7x7x7)/Cube 0:**

Measurement grid: dx=5mm, dy=5mm, dz=5mm

Reference Value = 4.663 V/m; Power Drift = -0.17 dB

Peak SAR (extrapolated) = 1.85 W/kg

SAR(1 g) = 0.847 W/kg; SAR(10 g) = 0.338 W/kg

Maximum value of SAR (measured) = 1.03 W/kg

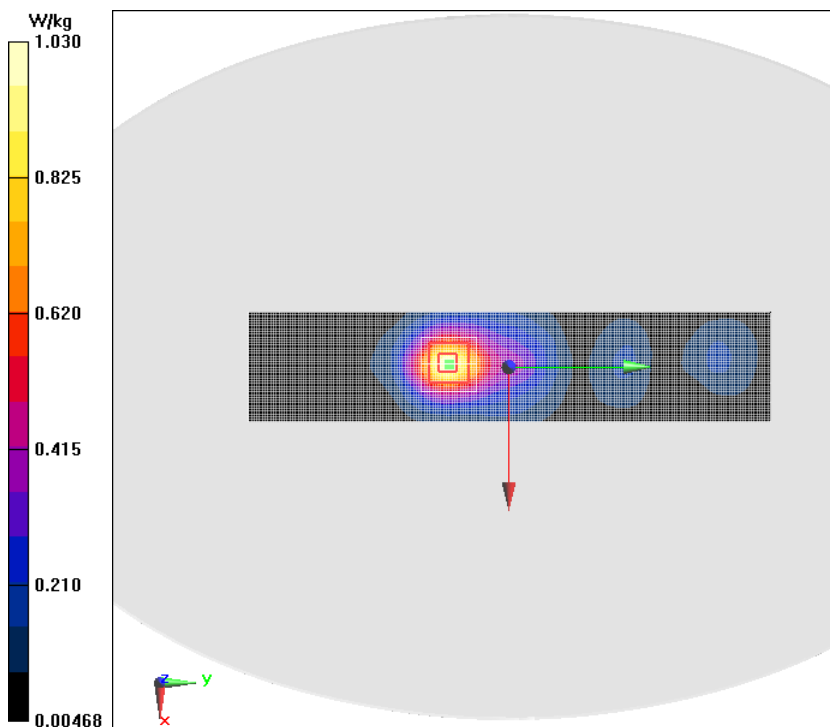

**Fig.31 LTE Band 7 20MHz 50RB 0offset Top Mode High 0mm**

**LTE Band 7 20MHz 50RB 0offset Top Mode High 0mm repeated**

Date/Time: 2017/6/5

Electronics: DAE4 Sn1244

Medium: Body 2600MHz

Medium parameters used (interpolated):  $f = 2560$  MHz;  $\sigma = 2.044$  S/m;  $\epsilon_r = 53.474$ ;  $\rho = 1000$  kg/m<sup>3</sup>

Ambient Temperature:22°C Liquid Temperature:22°C

Communication System: LTE Band 7 Professional 2600MHz; Frequency: 2560 MHz; Duty Cycle: 1:1

Probe: EX3DV4 - SN3754ConvF(7.15, 7.15, 7.15); Calibrated: 1/13/2017

**LTE Band 7 20MHz 50RB 0offset Top Mode High 0mm repeated/Area Scan (41x191x1):**

Measurement grid: dx=10 mm, dy=10 mm

Maximum value of SAR (Measurement) = 0.817 W/kg

**LTE Band 7 20MHz 50RB 0offset Top Mode High 0mm repeated/Zoom Scan (7x7x7)/Cube 0:**

Measurement grid: dx=5mm, dy=5mm, dz=5mm

Reference Value = 4.578 V/m; Power Drift = -0.11 dB

Peak SAR (extrapolated) = 1.87 W/kg

SAR(1 g) = 0.850 W/kg; SAR(10 g) = 0.339 W/kg

Maximum value of SAR (measured) = 1.03 W/kg

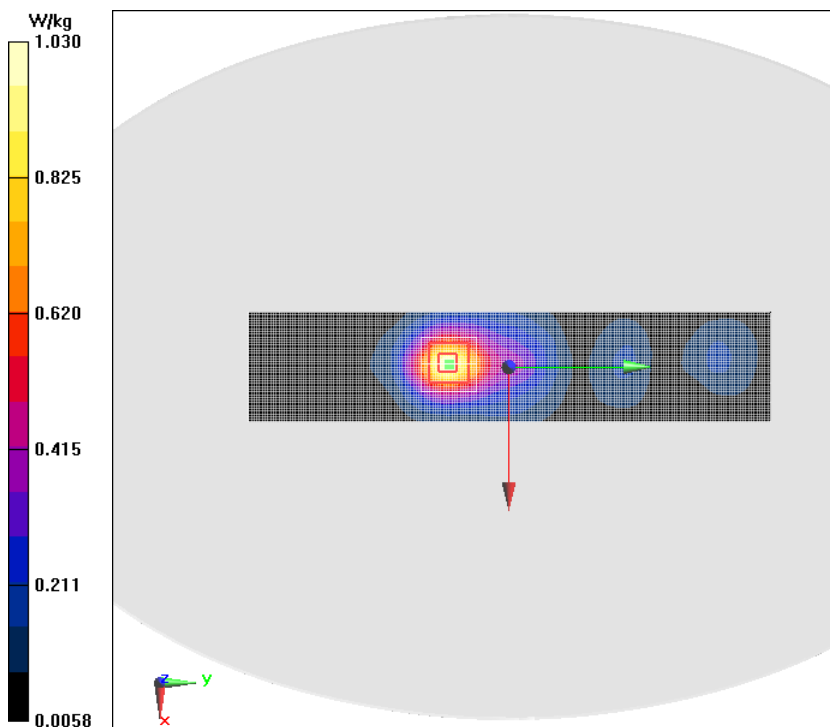

**Fig.32 LTE Band 7 20MHz 50RB 0offset Top Mode High 0mm repeated**

## ANNEX B. SYSTEM VALIDATION RESULTS

### 835MHz

Date/Time: 2017/4/28

Electronics: DAE4 Sn1244

Medium: Body 835MHz

Medium parameters used:  $f = 835 \text{ MHz}$ ;  $\sigma = 0.996 \text{ S/m}$ ;  $\epsilon_r = 55.15$ ;  $\rho = 1000 \text{ kg/m}^3$

Ambient Temperature: 22°C    Liquid Temperature: 22°C

Communication System: CW 850MHz;    Frequency: 835 MHz; Duty Cycle: 1:1

Probe: EX3DV4 - SN3754ConvF(9.66, 9.66, 9.66); Calibrated: 1/13/2017

#### System Validation/Area Scan (61x131x1):

Measurement grid:  $dx=10 \text{ mm}$ ,  $dy=10 \text{ mm}$

Maximum value of SAR (Measurement) = 2.96 W/kg

#### System Validation/Zoom Scan (7x7x7) /Cube 0:

Measurement grid:  $dx=5\text{mm}$ ,  $dy=5\text{mm}$ ,  $dz=5\text{mm}$

Reference Value = 55.69 V/m; Power Drift = -0.01 dB

Peak SAR (extrapolated) = 3.45 W/kg

SAR(1 g) = 2.39 W/kg; SAR(10 g) = 1.59 W/kg

Maximum value of SAR (measured) = 2.98 W/kg

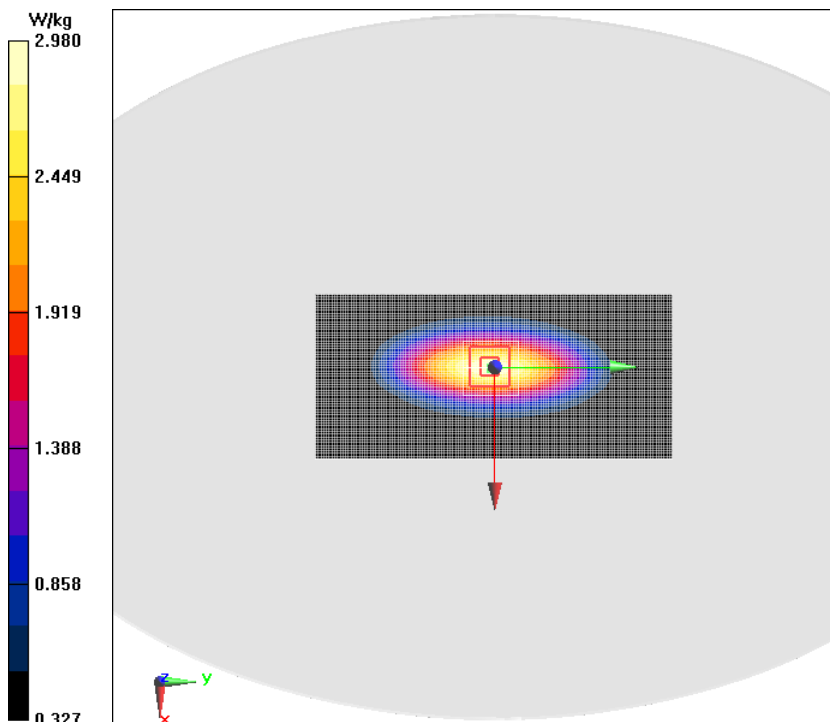

## 1750MHz

Date/Time: 2017/4/29

Electronics: DAE4 Sn1244

Medium: Body 1800MHz

Medium parameters used (extrapolated):  $f = 1750$  MHz;  $\sigma = 1.44$  S/m;  $\epsilon_r = 52.294$ ;  $\rho = 1000$  kg/m<sup>3</sup>

Ambient Temperature:22°C    Liquid Temperature:22°C

Communication System: 1900MHz;    Frequency: 1750 MHz; Duty Cycle: 1:1

Probe: EX3DV4 - SN3754ConvF(7.8, 7.8, 7.8); Calibrated: 1/13/2017

### System Validation/Area Scan (81x81x1):

Measurement grid:  $dx=10$  mm,  $dy=10$  mm

Maximum value of SAR (Measurement) = 12.0 W/kg

### System Validation/Zoom Scan (7x7x7)/Cube 0:

Measurement grid:  $dx=5$ mm,  $dy=5$ mm,  $dz=5$ mm

Reference Value = 91.91 V/m; Power Drift = 0.04 dB

Peak SAR (extrapolated) = 18.4 W/kg

SAR(1 g) = 9.57 W/kg; SAR(10 g) = 5.18 W/kg

Maximum value of SAR (measured) = 11.7 W/kg

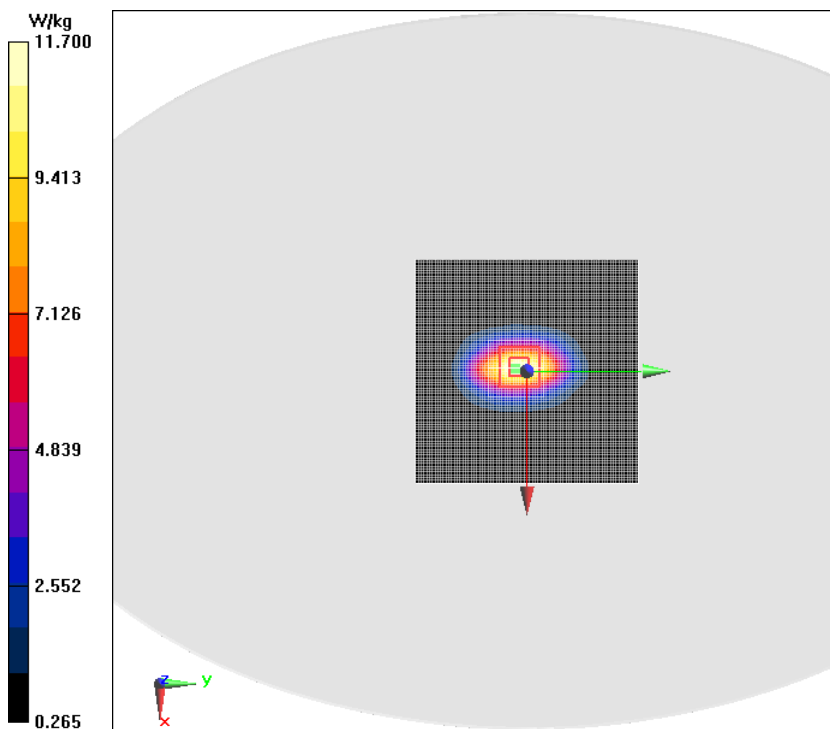

## 1900MHz

Date/Time: 2017/4/27

Electronics: DAE4 Sn1244

Medium: Body 1900MHz

Medium parameters used:  $f = 1900 \text{ MHz}$ ;  $\sigma = 1.571 \text{ S/m}$ ;  $\epsilon_r = 54.586$ ;  $\rho = 1000 \text{ kg/m}^3$

Ambient Temperature:  $22^\circ\text{C}$     Liquid Temperature:  $22^\circ\text{C}$

Communication System: CW 1900MHz;    Frequency: 1900 MHz; Duty Cycle: 1:1

Probe: EX3DV4 - SN3754ConvF(7.6, 7.6, 7.6); Calibrated: 1/13/2017

### System Validation/Area Scan (61x61x1):

Measurement grid:  $dx=10 \text{ mm}$ ,  $dy=10 \text{ mm}$

Maximum value of SAR (Measurement) =  $16.0 \text{ W/kg}$

### System Validation/Zoom Scan (7x7x7) /Cube 0:

Measurement grid:  $dx=5\text{mm}$ ,  $dy=5\text{mm}$ ,  $dz=5\text{mm}$

Reference Value =  $103.3 \text{ V/m}$ ; Power Drift =  $-0.10 \text{ dB}$

Peak SAR (extrapolated) =  $20.6 \text{ W/kg}$

SAR(1 g) =  $10.6 \text{ W/kg}$ ; SAR(10 g) =  $5.48 \text{ W/kg}$

Maximum value of SAR (measured) =  $16.1 \text{ W/kg}$

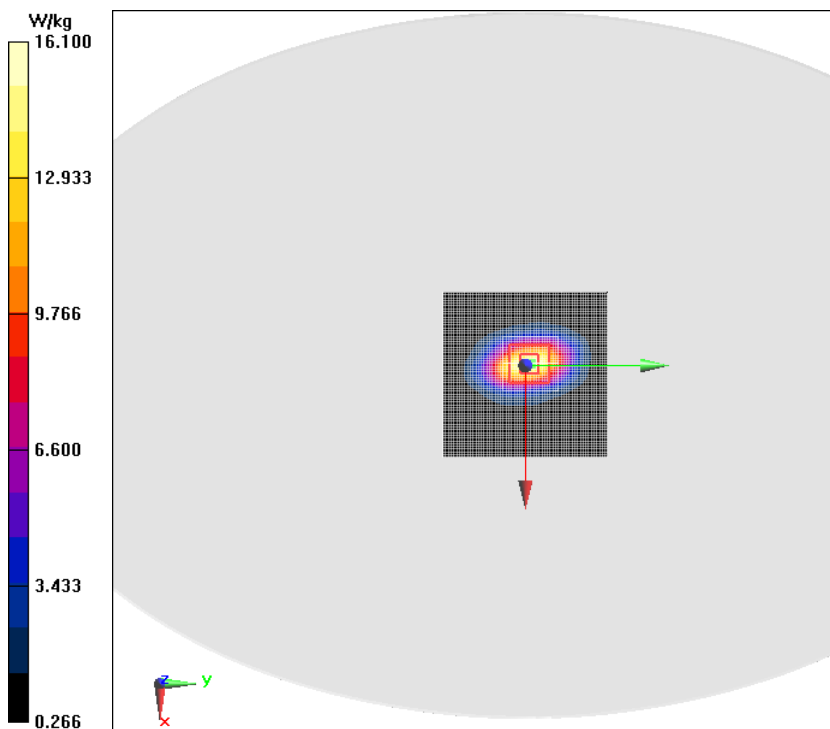

## 2450MHz

Date/Time: 2017/5/23

Electronics: DAE4 Sn1244

Medium: Body 2450MHz

Medium parameters used:  $f = 2450$  MHz;  $\sigma = 1.976$  S/m;  $\epsilon_r = 52.926$ ;  $\rho = 1000$  kg/m<sup>3</sup>

Ambient Temperature: 22°C    Liquid Temperature: 22°C

Communication System: CW 2450MHz;    Frequency: 2450 MHz; Duty Cycle: 1:1

Probe: EX3DV4 - SN3754ConvF(7.22, 7.22, 7.22); Calibrated: 1/13/2017

### System Validation/Area Scan (111x111x1):

Measurement grid:  $dx=10$  mm,  $dy=10$  mm

Maximum value of SAR (Measurement) = 21.8 W/kg

### System Validation/Zoom Scan (7x7x7) /Cube 0:

Measurement grid:  $dx=5$ mm,  $dy=5$ mm,  $dz=5$ mm

Reference Value = 109.4 V/m; Power Drift = -0.02 dB

Peak SAR (extrapolated) = 29.0 W/kg

SAR(1 g) = 13.9 W/kg; SAR(10 g) = 6.34 W/kg

Maximum value of SAR (measured) = 21.5 W/kg

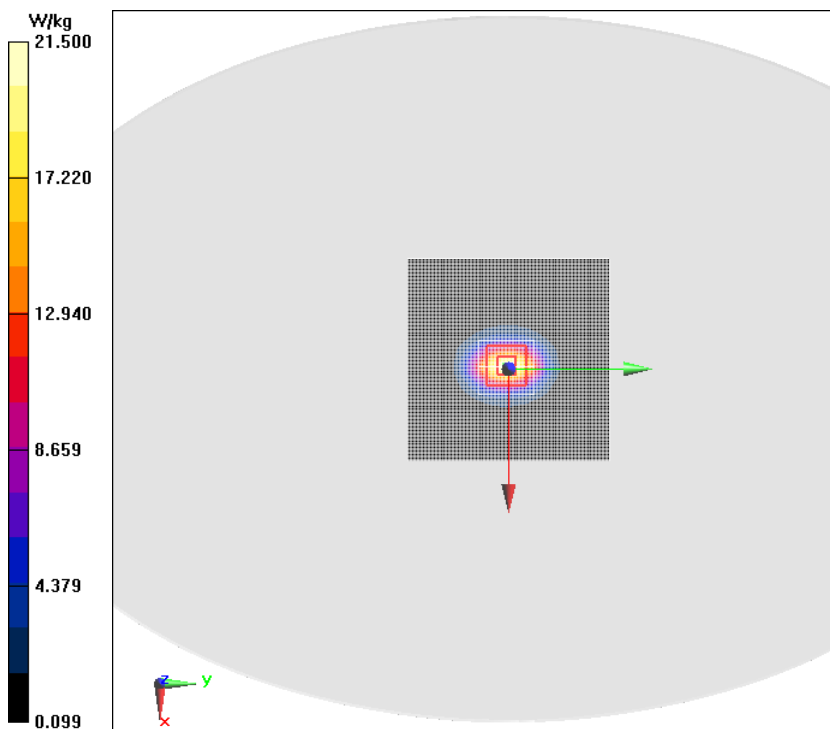

## 2600MHz

Date/Time: 2017/6/5

Electronics: DAE4 Sn1244

Medium: Body 2600MHz

Medium parameters used:  $f = 2600$  MHz;  $\sigma = 2.136$  S/m;  $\epsilon_r = 52.686$ ;  $\rho = 1000$  kg/m<sup>3</sup>

Ambient Temperature: 22°C    Liquid Temperature: 22°C

Communication System: CW 2600MHz;    Frequency: 2600 MHz; Duty Cycle: 1:1

Probe: EX3DV4 - SN3754ConvF(7.15, 7.15, 7.15); Calibrated: 1/13/2017

### System Validation/Area Scan (71x81x1):

Measurement grid:  $dx=10$  mm,  $dy=10$  mm

Maximum value of SAR (Measurement) = 23.3 W/kg

### System Validation/Zoom Scan (7x7x7)/Cube 0:

Measurement grid:  $dx=5$ mm,  $dy=5$ mm,  $dz=5$ mm

Reference Value = 88.14 V/m; Power Drift = -0.13 dB

Peak SAR (extrapolated) = 29.9 W/kg

SAR(1 g) = 13.9 W/kg; SAR(10 g) = 6.08 W/kg

Maximum value of SAR (measured) = 21.6 W/kg

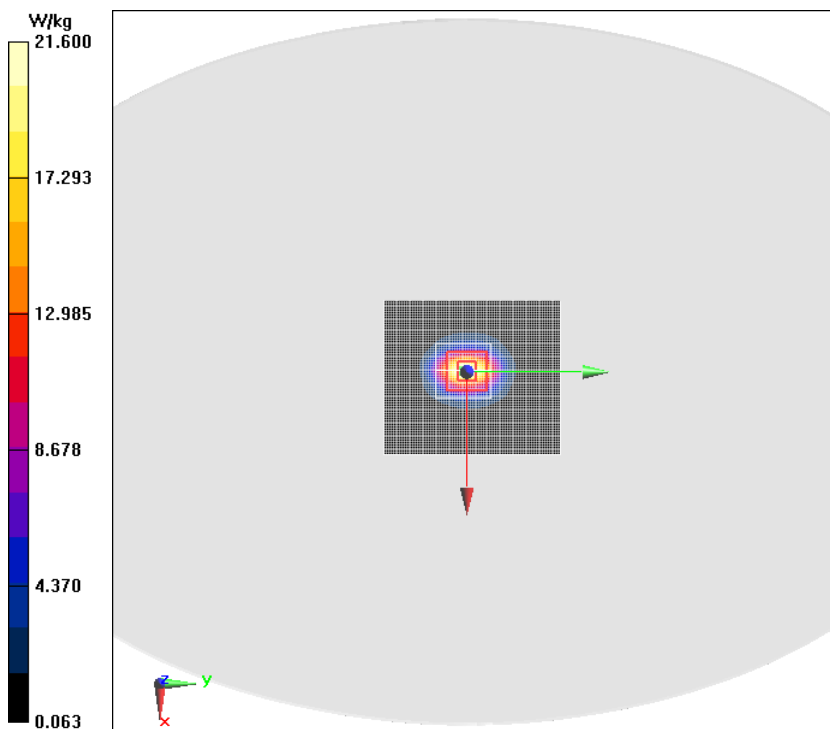



## ANNEX C. SAR Measurement Setup

### C.1. Measurement Set-up

The DASY5 system for performing compliance tests is illustrated above graphically. This system consists of the following items:

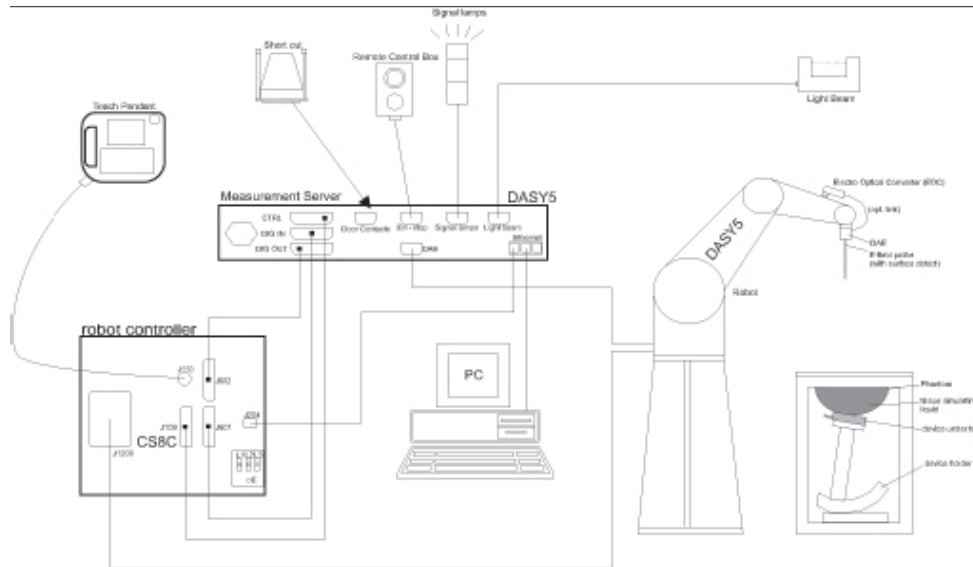

**Picture C.1 SAR Lab Test Measurement Set-up**

- A standard high precision 6-axis robot (Stäubli TX=RX family) with controller, teach pendant and software. An arm extension for accommodating the data acquisition electronics (DAE).
- An isotropic field probe optimized and calibrated for the targeted measurement.
- A data acquisition electronics (DAE) which performs the signal amplification, signal multiplexing, AD-conversion, offset measurements, mechanical surface detection, collision detection, etc. The unit is battery powered with standard or rechargeable batteries. The signal is optically transmitted to the EOC.
- The Electro-optical converter (EOC) performs the conversion from optical to electrical signals for the digital communication to the DAE. To use optical surface detection, a special version of the EOC is required. The EOC signal is transmitted to the measurement server.
- The function of the measurement server is to perform the time critical tasks such as signal filtering, control of the robot operation and fast movement interrupts.
- The Light Beam used is for probe alignment. This improves the (absolute) accuracy of the probe positioning.
- A computer running WinXP and the DASY5 software.
- Remote control and teach pendant as well as additional circuitry for robot safety such as
- warning lamps, etc.

- The phantom, the device holder and other accessories according to the targeted measurement.

## C.2. DASY5 E-field Probe System

The SAR measurements were conducted with the dosimetric probe designed in the classical triangular configuration and optimized for dosimetric evaluation. The probe is constructed using the thick film technique; with printed resistive lines on ceramic substrates. The probe is equipped with an optical multifiber line ending at the front of the probe tip. It is connected to the EOC box on the robot arm and provides an automatic detection of the phantom surface. Half of the fibers are connected to a pulsed infrared transmitter, the other half to a synchronized receiver. As the probe approaches the surface, the reflection from the surface produces a coupling from the transmitting to the receiving fibers. This reflection increases first during the approach, reaches maximum and then decreases. If the probe is flatly touching the surface, the coupling is zero. The distance of the coupling maximum to the surface is independent of the surface reflectivity and largely independent of the surface to probe angle. The DASY5 software reads the reflection during a software approach and looks for the maximum using 2<sup>nd</sup> order curve fitting. The approach is stopped at reaching the maximum.

### Probe Specifications:

**Model:** ES3DV3, EX3DV4

**Frequency**

**Range:** 700MHz — 2.6GHz(ES3DV3)

**Calibration:** In head and body simulating tissue at  
Frequencies from 835 up to 2450MHz

**Linearity:**

$\pm 0.2$  dB(700MHz — 2.0GHz) for ES3DV3

**Dynamic Range:** 10 mW/kg — 100W/kg

**Probe Length:** 330 mm

**Probe Tip**

**Length:** 20 mm

**Body Diameter:** 12 mm

**Tip Diameter:** 2.5 mm (3.9 mm for ES3DV3)

**Tip-Center:** 1 mm (2.0mm for ES3DV3)

**Application:**SAR Dosimetry Testing

Compliance tests of mobile phones

Dosimetry in strong gradient fields



Picture C.2 Near-field Probe



Picture C.3 E-field Probe

## C.3. E-field Probe Calibration

Each E-Probe/Probe Amplifier combination has unique calibration parameters. A TEM cell calibration procedure is conducted to determine the proper amplifier settings to enter in the probe parameters. The amplifier settings are determined for a given frequency by subjecting the probe to a known E-field density ( $1 \text{ mW/cm}^2$ ) using an RF Signal generator, TEM cell, and RF Power Meter.

The free space E-field from amplified probe outputs is determined in a test chamber. This calibration can be performed in a TEM cell if the frequency is below 1 GHz and in a waveguide or other methodologies above 1 GHz for free space. For the free space calibration, the probe is placed in the volumetric center of the cavity and at the proper orientation with the field. The probe is then rotated 360 degrees until the three channels show the maximum reading. The power density readings equate to  $1 \text{ mW/cm}^2$ .

E-field temperature correlation calibration is performed in a flat phantom filled with the appropriate simulated brain tissue. The E-field in the medium correlates with the temperature rise in the dielectric medium. For temperature correlation calibration a RF transparent thermistor-based temperature probe is used in conjunction with the E-field probe.

$$SAR = C \frac{\Delta T}{\Delta t}$$

Where:

$\Delta t$  = Exposure time (30 seconds),

C = Heat capacity of tissue (brain or muscle),

$\Delta T$  = Temperature increase due to RF exposure.

$$SAR = \frac{|E|^2 \cdot \sigma}{\rho}$$

Where:

$\sigma$  = Simulated tissue conductivity,

$\rho$  = Tissue density ( $\text{kg/m}^3$ ).

## **C.4. Other Test Equipment**

### **C.4.1. Data Acquisition Electronics(DAE)**

The data acquisition electronics consist of a highly sensitive electrometer-grade preamplifier with auto-zeroing, a channel and gain-switching multiplexer, a fast 16 bit AD-converter and a command decoder with a control logic unit. Transmission to the measurement server is accomplished through an optical downlink for data and status information, as well as an optical uplink for commands and the clock.

The mechanical probe mounting device includes two different sensor systems for frontal and

sideways probe contacts. They are used for mechanical surface detection and probe collision detection.

The input impedance of the DAE is 200 MOhm; the inputs are symmetrical and floating. Common mode rejection is above 80 dB.



**PictureC.4: DAE**

### C.4.2. Robot

The SPEAG DASY system uses the high precision robots (DASY5: RX90L) type from Stäubli SA (France). For the 6-axis controller system, the robot controller version from Stäubli is used. The Stäubli robot series have many features that are important for our application:

- High precision (repeatability 0.02mm)
- High reliability (industrial design)
- Low maintenance costs (virtually maintenance free due to direct drive gears; no belt drives)
- Jerk-free straight movements (brushless synchron motors; no stepper motors)
- Low ELF interference (motor control fields shielded via the closed metallic construction shields)



**Picture C.5 DASY 5**

### C.4.3. Measurement Server

The Measurement server is based on a PC/104 CPU board with CPU (DASY5: 400 MHz, Intel Celeron), chipdisk (DASY5: 128MB), RAM (DASY5: 128MB). The necessary circuits for communication with the DAE electronic box, as well as the 16 bit AD converter system for optical detection and digital I/O interface are contained on the DASY I/O board, which is directly connected to the PC/104 bus of the CPU board.

The measurement server performs all real-time data evaluation of field measurements and surface

detection, controls robot movements and handles safety operation. The PC operating system cannot interfere with these time critical processes. All connections are supervised by a watchdog, and disconnection of any of the cables to the measurement server will automatically disarm the robot and disable all program-controlled robot movements. Furthermore, the measurement server is equipped with an expansion port which is reserved for future applications. Please note that this expansion port does not have a standardized pinout, and therefore only devices provided by SPEAG can be connected. Devices from any other supplier could seriously damage the measurement server.



**Picture C.6 Server for DASY 5**

#### **C.4.4. Device Holder for Phantom**

The SAR in the phantom is approximately inversely proportional to the square of the distance between the source and the liquid surface. For a source at 5mm distance, a positioning uncertainty of  $\pm 0.5\text{mm}$  would produce a SAR uncertainty of  $\pm 20\%$ . Accurate device positioning is therefore crucial for accurate and repeatable measurements. The positions in which the devices must be measured are defined by the standards.

The DASY device holder is designed to cope with the different positions given in the standard. It has two scales for device rotation (with respect to the body axis) and device inclination (with respect to the line between the ear reference points). The rotation centers for both scales is the ear reference point (ERP). Thus the device needs no repositioning when changing the angles.

The DASY device holder is constructed of low-loss POM material having the following dielectric parameters: relative permittivity  $\epsilon = 3$  and loss tangent  $\delta = 0.02$ . The amount of dielectric material has been reduced in the closest vicinity of the device, since measurements have suggested that the influence of the clamp on the test results could thus be lowered.

<Laptop Extension Kit>

The extension is lightweight and made of POM, acrylic glass and foam. It fits easily on the upper part of the Mounting Device in place of the phone positioner. The extension is fully compatible with the Twin-SAM and ELI phantoms.



**Picture C.7: Device Holder**

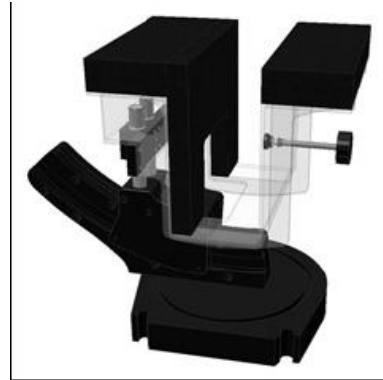

**Picture C.8: Laptop Extension Kit**



### C.4.5. Phantom

The SAM Twin Phantom V4.0 is constructed of a fiberglass shell integrated in a table. The shape of the shell is based on data from an anatomical study designed to represent the 90<sup>th</sup> percentile of the population. The phantom enables the dissymmetric evaluation of SAR for both left and right handed handset usage, as well as body-worn usage using the flat phantom region. Reference markings on the Phantom allow the complete setup of all predefined phantom positions and measurement grids by manually teaching three points in the robot. The shell phantom has a 2mm shell thickness (except the ear region where shell thickness increases to 6 mm).

Shell Thickness:  $2 \pm 0.2$  mm

Filling Volume: Approx. 25 liters

Dimensions: 810 x 1000 x 500 mm (H x L x W)

Available: Special



**Picture C.9: SAM Twin Phantom**

## ANNEX D. Position of the wireless device in relation to the phantom

### D.1. General considerations

This standard specifies two handset test positions against the head phantom – the “cheek” position and the “tilt” position.

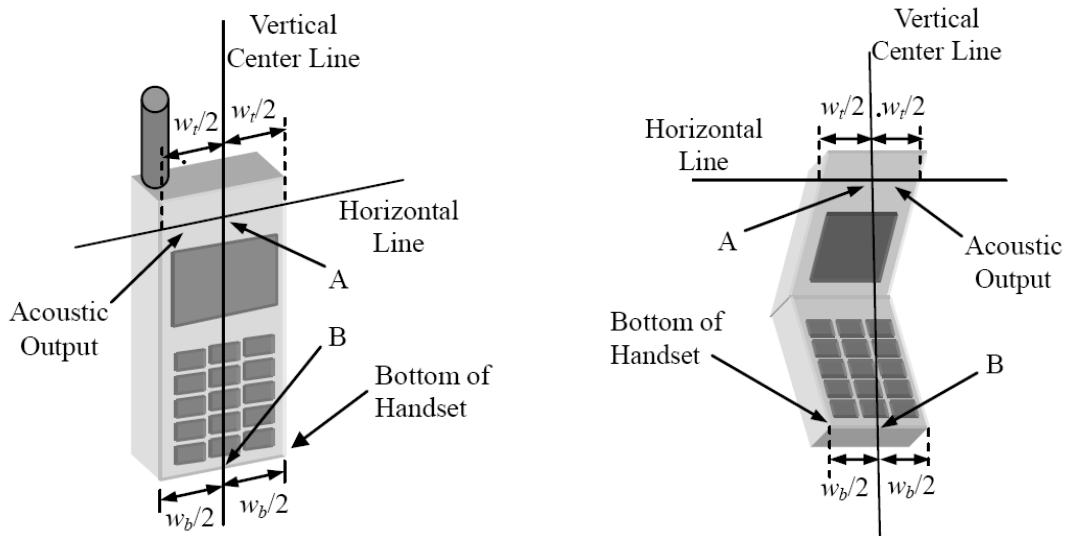

- $w_t$  Width of the handset at the level of the acoustic
- $w_b$  Width of the bottom of the handset
- A Midpoint of the width  $w_t$  of the handset at the level of the acoustic output
- B Midpoint of the width  $w_b$  of the bottom of the handset

Picture D.1-a Typical “fixed” case handset      Picture D.1-b Typical “clam-shell” case handset

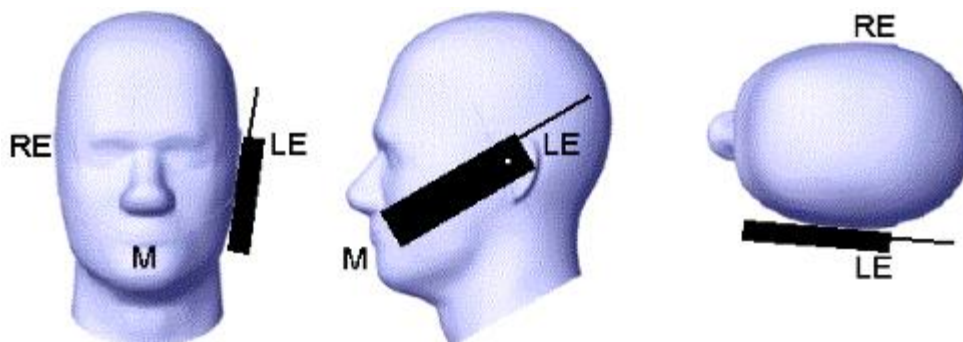

Picture D.2 Cheek position of the wireless device on the left side of SAM

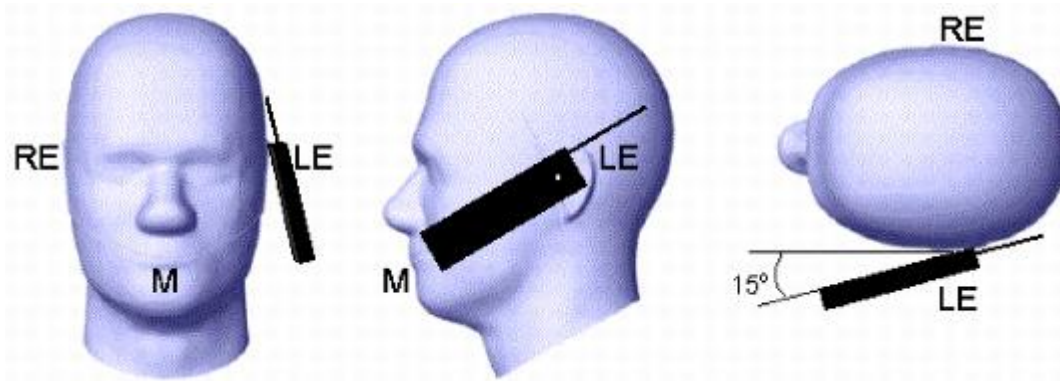

**Picture D.3 Tilt position of the wireless device on the left side of SAM**

### D.2. Body-worn device

A typical example of a body-worn device is a mobile phone, wireless enabled PDA or other battery operated wireless device with the ability to transmit while mounted on a person's body using a carry accessory approved by the wireless device manufacturer.

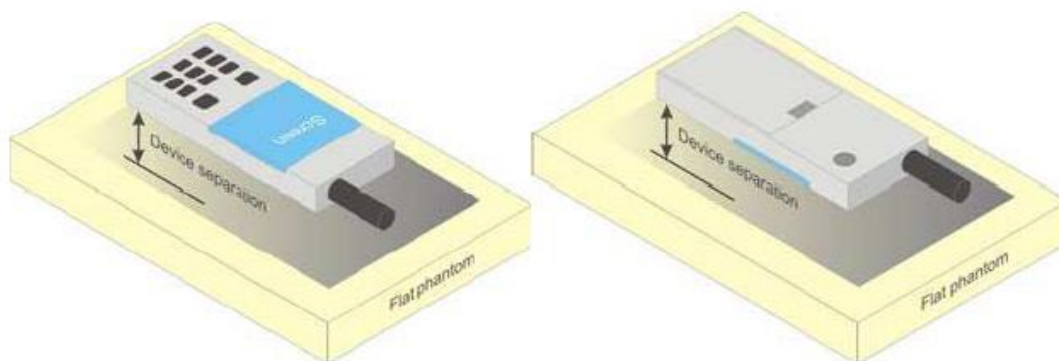

**Picture D.4 Test positions for body-worn devices**

### D.3. Desktop device

A typical example of a desktop device is a wireless enabled desktop computer placed on a table or desk when used.

The DUT shall be positioned at the distance and in the orientation to the phantom that corresponds to the intended use as specified by the manufacturer in the user instructions. For devices that employ an external antenna with variable positions, tests shall be performed for all antenna positions specified. Picture 8.5 show positions for desktop device SAR tests. If the intended use is not specified, the device shall be tested directly against the flat phantom.

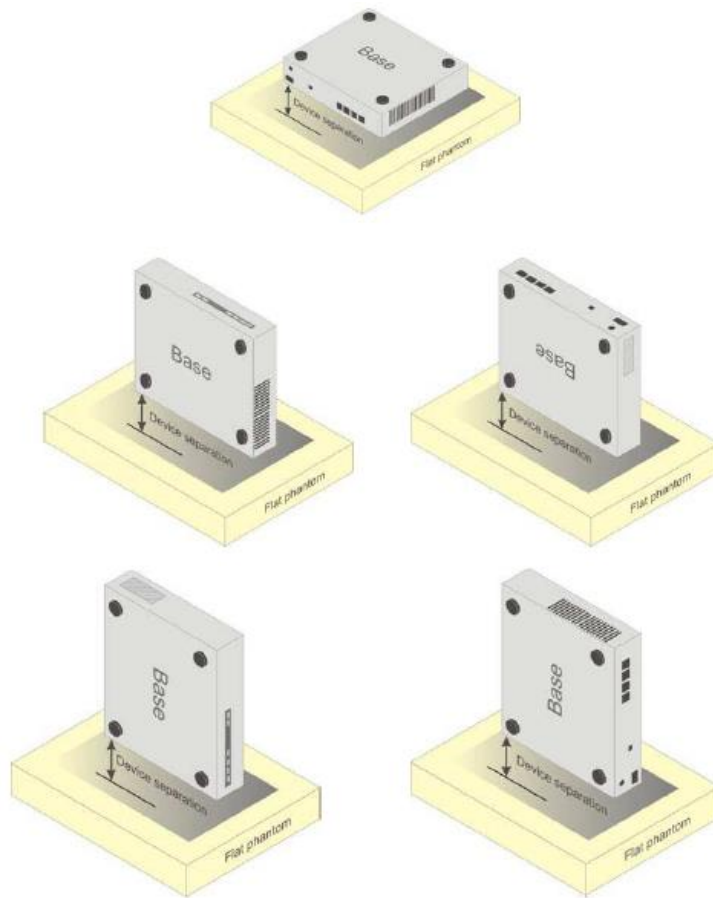

**Picture D.5 Test positions for desktop devices**

**D.4. DUT Setup Photos****Picture D.6 DSY5 system Set-up****Note:**

The photos of test sample and test positions show in additional document.

## ANNEX E. Equivalent Media Recipes

The liquid used for the frequency range of 800-3000 MHz consisted of water, sugar, salt, preventol, glycol monobutyl and Cellulose. The liquid has been previously proven to be suited for worst-case. The Table E.1 shows the detail solution. It's satisfying the latest tissue dielectric parameters requirements proposed by the IEEE 1528 and IEC 62209.

**Table E.1: Composition of the Tissue Equivalent Matter**

Frequency (MHz)	835 Head	835 Body	1900 Head	1900 Body	2450 Head	2450 Body
Ingredients (% by weight)						
Water	41.45	52.5	55.242	69.91	58.79	72.60
Sugar	56.0	45.0	\	\	\	\
Salt	1.45	1.4	0.306	0.13	0.06	0.18
Preventol	0.1	0.1	\	\	\	\
Cellulose	1.0	1.0	\	\	\	\
Glycol Monobutyl	\	\	44.452	29.96	41.15	27.22
Dielectric Parameters Target Value	$\epsilon=41.5$ $\sigma=0.90$	$\epsilon=55.2$ $\sigma=0.97$	$\epsilon=40.0$ $\sigma=1.40$	$\epsilon=53.3$ $\sigma=1.52$	$\epsilon=39.2$ $\sigma=1.80$	$\epsilon=52.7$ $\sigma=1.95$

## ANNEX F. System Validation

The SAR system must be validated against its performance specifications before it is deployed. When SAR probes, system components or software are changed, upgraded or recalibrated, these must be validated with the SAR system(s) that operates with such components.

**Table F.1: System Validation Part 1**

System No.	Probe SN.	Liquid name	Validation date	Frequency point	Permittivity $\epsilon$	Conductivity $\sigma$ (S/m)
1	3754	Body 835MHz	April 28, 2017	835MHz	55.15	0.996
2	3754	Body 1750MHz	April 29, 2017	1750MHz	52.013	1.496
3	3754	Body 1900MHz	April 27, 2017	1900MHz	54.586	1.571
4	3754	Body 2450MHz	May 23, 2017	2450MHz	52.926	1.976
5	3754	Body 2600MHz	June 5, 2017	2600MHz	52.686	2.136

**Table F.2: System Validation Part 2**

CW Validation	Sensitivity	PASS	PASS
	Probe linearity	PASS	PASS
	Probe Isotropy	PASS	PASS
Mod Validation	MOD.type	GMSK	GMSK
	MOD.type	OFDM	OFDM
	Duty factor	PASS	PASS
	PAR	PASS	PASS



## ANNEX G. Probe and DAE Calibration Certificate

Schmid & Partner Engineering AG

s p e a g

Zeughausstrasse 43, 8004 Zurich, Switzerland  
Phone +41 44 245 9700, Fax +41 44 245 9779  
info@speag.com, http://www.speag.com

1244

### IMPORTANT NOTICE

#### USAGE OF THE DAE 4

The DAE unit is a delicate, high precision instrument and requires careful treatment by the user. There are no serviceable parts inside the DAE. Special attention shall be given to the following points:

**Battery Exchange:** The battery cover of the DAE4 unit is closed using a screw, over tightening the screw may cause the threads inside the DAE to wear out.

**Shipping of the DAE:** Before shipping the DAE to SPEAG for calibration, remove the batteries and pack the DAE in an antistatic bag. This antistatic bag shall then be packed into a larger box or container which protects the DAE from impacts during transportation. The package shall be marked to indicate that a fragile instrument is inside.

**E-Stop Failures:** Touch detection may be malfunctioning due to broken magnets in the E-stop. Rough handling of the E-stop may lead to damage of these magnets. Touch and collision errors are often caused by dust and dirt accumulated in the E-stop. To prevent E-stop failure, the customer shall always mount the probe to the DAE carefully and keep the DAE unit in a non-dusty environment if not used for measurements.

**Repair:** Minor repairs are performed at no extra cost during the annual calibration. However, SPEAG reserves the right to charge for any repair especially if rough unprofessional handling caused the defect.

**DASY Configuration Files:** Since the exact values of the DAE input resistances, as measured during the calibration procedure of a DAE unit, are not used by the DASY software, a nominal value of 200 MOhm is given in the corresponding configuration file.

**Important Note:**

**Warranty and calibration is void if the DAE unit is disassembled partly or fully by the Customer.**

**Important Note:**

**Never attempt to grease or oil the E-stop assembly. Cleaning and readjusting of the E-stop assembly is allowed by certified SPEAG personnel only and is part of the annual calibration procedure.**

**Important Note:**

**To prevent damage of the DAE probe connector pins, use great care when installing the probe to the DAE. Carefully connect the probe with the connector notch oriented in the mating position. Avoid any rotational movement of the probe body versus the DAE while turning the locking nut of the connector. The same care shall be used when disconnecting the probe from the DAE.**

Schmid & Partner Engineering

TN\_BR040315AD DAE4.doc

11.12.2009



**Calibration Laboratory of**  
**Schmid & Partner**  
**Engineering AG**  
 Zeughausstrasse 43, 8004 Zurich, Switzerland



**S** Schweizerischer Kalibrierdienst  
**C** Service suisse d'étalonnage  
**S** Servizio svizzero di taratura  
**S** Swiss Calibration Service

Accredited by the Swiss Accreditation Service (SAS)  
 The Swiss Accreditation Service is one of the signatories to the EA  
 Multilateral Agreement for the recognition of calibration certificates

Accreditation No.: **SCS 0108**

Client **TMC - SH (Auden)**

Certificate No: **DAE4-1244\_Dec16**

## CALIBRATION CERTIFICATE

Object **DAE4 - SD 000 D04 BM - SN: 1244**

Calibration procedure(s) **QA CAL-06.v29  
 Calibration procedure for the data acquisition electronics (DAE)**



Calibration date: **December 12, 2016**

This calibration certificate documents the traceability to national standards, which realize the physical units of measurements (SI).  
 The measurements and the uncertainties with confidence probability are given on the following pages and are part of the certificate.

All calibrations have been conducted in the closed laboratory facility: environment temperature (22 ± 3)°C and humidity < 70%.

Calibration Equipment used (M&TE critical for calibration)

Primary Standards	ID #	Cal Date (Certificate No.)	Scheduled Calibration
Keithley Multimeter Type 2001	SN: 0810278	09-Sep-16 (No:19065)	Sep-17
Secondary Standards	ID #	Check Date (in house)	Scheduled Check
Auto DAE Calibration Unit	SE UWS 053 AA 1001	05-Jan-16 (in house check)	In house check: Jan-17
Calibrator Box V2.1	SE UMS 006 AA 1002	05-Jan-16 (in house check)	In house check: Jan-17

	Name	Function	Signature
Calibrated by:	Dominique Steffen	Technician	
Approved by:	Fin Bomholt	Deputy Technical Manager	

Issued: December 13, 2016

This calibration certificate shall not be reproduced except in full without written approval of the laboratory.

**Calibration Laboratory of**  
Schmid & Partner  
Engineering AG  
Zeughausstrasse 43, 8004 Zurich, Switzerland



**S** Schweizerischer Kalibrierdienst  
**S** Service suisse d'étalonnage  
**C** Servizio svizzero di taratura  
**S** Swiss Calibration Service

Accredited by the Swiss Accreditation Service (SAS)  
The Swiss Accreditation Service is one of the signatories to the EA  
Multilateral Agreement for the recognition of calibration certificates

Accreditation No.: **SCS 0108**

## Glossary

DAE data acquisition electronics  
Connector angle information used in DASY system to align probe sensor X to the robot coordinate system.

## Methods Applied and Interpretation of Parameters

- **DC Voltage Measurement:** Calibration Factor assessed for use in DASY system by comparison with a calibrated instrument traceable to national standards. The figure given corresponds to the full scale range of the voltmeter in the respective range.
- **Connector angle:** The angle of the connector is assessed measuring the angle mechanically by a tool inserted. Uncertainty is not required.
- The following parameters as documented in the Appendix contain technical information as a result from the performance test and require no uncertainty.
  - **DC Voltage Measurement Linearity:** Verification of the Linearity at +10% and -10% of the nominal calibration voltage. Influence of offset voltage is included in this measurement.
  - **Common mode sensitivity:** Influence of a positive or negative common mode voltage on the differential measurement.
  - **Channel separation:** Influence of a voltage on the neighbor channels not subject to an input voltage.
  - **AD Converter Values with inputs shorted:** Values on the internal AD converter corresponding to zero input voltage
  - **Input Offset Measurement:** Output voltage and statistical results over a large number of zero voltage measurements.
  - **Input Offset Current:** Typical value for information; Maximum channel input offset current, not considering the input resistance.
  - **Input resistance:** Typical value for information; DAE input resistance at the connector, during internal auto-zeroing and during measurement.
  - **Low Battery Alarm Voltage:** Typical value for information. Below this voltage, a battery alarm signal is generated.
  - **Power consumption:** Typical value for information. Supply currents in various operating modes.

### DC Voltage Measurement

A/D - Converter Resolution nominal

High Range: 1LSB = 6.1 $\mu$ V, full range = -100...+300 mV

Low Range: 1LSB = 61nV, full range = -1.....+3mV

DASY measurement parameters: Auto Zero Time: 3 sec; Measuring time: 3 sec

Calibration Factors	X	Y	Z
High Range	403.872 $\pm$ 0.02% (k=2)	403.613 $\pm$ 0.02% (k=2)	404.527 $\pm$ 0.02% (k=2)
Low Range	3.95409 $\pm$ 1.50% (k=2)	3.97148 $\pm$ 1.50% (k=2)	3.98215 $\pm$ 1.50% (k=2)

### Connector Angle

Connector Angle to be used in DASY system	22.0 $\pm$ 1 $^{\circ}$
-------------------------------------------	-------------------------

## Appendix (Additional assessments outside the scope of SCS0108)

### 1. DC Voltage Linearity

High Range	Reading ( $\mu\text{V}$ )	Difference ( $\mu\text{V}$ )	Error (%)
Channel X + Input	199995.09	-0.83	-0.00
Channel X + Input	20004.47	2.58	0.01
Channel X - Input	-19997.82	2.60	-0.01
Channel Y + Input	199993.65	-2.29	-0.00
Channel Y + Input	20001.27	-0.51	-0.00
Channel Y - Input	-19997.58	2.97	-0.01
Channel Z + Input	199992.15	-3.40	-0.00
Channel Z + Input	19999.95	-1.78	-0.01
Channel Z - Input	-20002.51	-1.92	0.01

Low Range	Reading ( $\mu\text{V}$ )	Difference ( $\mu\text{V}$ )	Error (%)
Channel X + Input	2002.00	0.39	0.02
Channel X + Input	202.04	0.13	0.07
Channel X - Input	-197.82	0.13	-0.06
Channel Y + Input	2000.90	-0.59	-0.03
Channel Y + Input	202.65	0.73	0.36
Channel Y - Input	-197.74	0.13	-0.06
Channel Z + Input	2001.79	0.42	0.02
Channel Z + Input	200.75	-1.05	-0.52
Channel Z - Input	-199.15	-1.06	0.53

### 2. Common mode sensitivity

DASY measurement parameters: Auto Zero Time: 3 sec; Measuring time: 3 sec

	Common mode Input Voltage (mV)	High Range Average Reading ( $\mu\text{V}$ )	Low Range Average Reading ( $\mu\text{V}$ )
Channel X	200	-3.59	-5.16
	-200	6.94	5.14
Channel Y	200	-3.41	-3.57
	-200	2.60	2.96
Channel Z	200	-8.21	-8.18
	-200	5.71	5.56

### 3. Channel separation

DASY measurement parameters: Auto Zero Time: 3 sec; Measuring time: 3 sec

	Input Voltage (mV)	Channel X ( $\mu\text{V}$ )	Channel Y ( $\mu\text{V}$ )	Channel Z ( $\mu\text{V}$ )
Channel X	200	-	1.06	-4.10
Channel Y	200	7.19	-	1.88
Channel Z	200	9.77	4.29	-

#### 4. AD-Converter Values with inputs shorted

DASY measurement parameters: Auto Zero Time: 3 sec; Measuring time: 3 sec

	High Range (LSB)	Low Range (LSB)
Channel X	16885	16322
Channel Y	16457	16417
Channel Z	15874	17196

#### 5. Input Offset Measurement

DASY measurement parameters: Auto Zero Time: 3 sec; Measuring time: 3 sec

Input 10MΩ

	Average (μV)	min. Offset (μV)	max. Offset (μV)	Std. Deviation (μV)
Channel X	-0.50	-1.93	1.16	0.62
Channel Y	0.32	-1.78	2.06	0.72
Channel Z	-2.19	-4.30	-0.47	0.66

#### 6. Input Offset Current

Nominal Input circuitry offset current on all channels: <25fA

#### 7. Input Resistance (Typical values for information)

	Zeroing (kOhm)	Measuring (MOhm)
Channel X	200	200
Channel Y	200	200
Channel Z	200	200

#### 8. Low Battery Alarm Voltage (Typical values for information)

Typical values	Alarm Level (VDC)
Supply (+ Vcc)	+7.9
Supply (- Vcc)	-7.6

#### 9. Power Consumption (Typical values for information)

Typical values	Switched off (mA)	Stand by (mA)	Transmitting (mA)
Supply (+ Vcc)	+0.01	+6	+14
Supply (- Vcc)	-0.01	-8	-9





Add: No.51 Xueyuan Road, Haidian District, Beijing, 100191, China  
 Tel: +86-10-62304633-2218 Fax: +86-10-62304633-2209  
 E-mail: cttl@chinattl.com [Http://www.chinattl.cn](http://www.chinattl.cn)

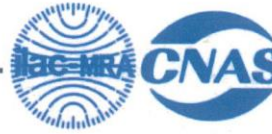

中国认可  
 国际互认  
 校准  
 CALIBRATION  
 CNAS L0570

Client

ECIT

Certificate No: Z17-97010

## CALIBRATION CERTIFICATE

Object: EX3DV4 - SN:3754

Calibration Procedure(s): FD-Z11-004-01  
 Calibration Procedures for Dosimetric E-field Probes

Calibration date: January 13, 2017

This calibration Certificate documents the traceability to national standards, which realize the physical units of measurements(SI). The measurements and the uncertainties with confidence probability are given on the following pages and are part of the certificate.

All calibrations have been conducted in the closed laboratory facility: environment temperature(22±3)°C and humidity<70%.

Calibration Equipment used (M&TE critical for calibration)

Primary Standards	ID #	Cal Date(Calibrated by, Certificate No.)	Scheduled Calibration
Power Meter NRP2	101919	27-Jun-16 (CTTL, No.J16X04777)	Jun-17
Power sensor NRP-Z91	101547	27-Jun-16 (CTTL, No.J16X04777)	Jun-17
Power sensor NRP-Z91	101548	27-Jun-16 (CTTL, No.J16X04777)	Jun-17
Reference10dBAttenuator	18N50W-10dB	13-Mar-16(CTTL,No.J16X01547)	Mar-18
Reference20dBAttenuator	18N50W-20dB	13-Mar-16(CTTL, No.J16X01548)	Mar-18
Reference Probe EX3DV4	SN 7433	26-Sep-16(SPEAG,No.EX3-7433_Sep16)	Sep-17
DAE4	SN 1331	21-Jan-16(SPEAG, No.DAE4-1331_Jan16)	Jan -17
Secondary Standards	ID #	Cal Date(Calibrated by, Certificate No.)	Scheduled Calibration
SignalGeneratorMG3700A	6201052605	27-Jun-16 (CTTL, No.J16X04776)	Jun-17
Network Analyzer E5071C	MY46110673	26-Jan-16 (CTTL, No.J16X00894)	Jan -17

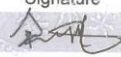
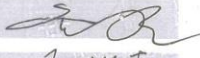
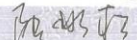
	Name	Function	Signature
Calibrated by:	Yu Zongying	SAR Test Engineer	
Reviewed by:	Qi Dianyuan	SAR Project Leader	
Approved by:	Lu Bingsong	Deputy Director of the laboratory	

Issued: January 14, 2017

This calibration certificate shall not be reproduced except in full without written approval of the laboratory.



Add: No.51 Xueyuan Road, Haidian District, Beijing, 100191, China  
 Tel: +86-10-62304633-2218 Fax: +86-10-62304633-2209  
 E-mail: cttl@chinattl.com [Http://www.chinattl.cn](http://www.chinattl.cn)

### Glossary:

TSL	tissue simulating liquid
NORM <sub>x,y,z</sub>	sensitivity in free space
ConvF	sensitivity in TSL / NORM <sub>x,y,z</sub>
DCP	diode compression point
CF	crest factor (1/duty_cycle) of the RF signal
A,B,C,D	modulation dependent linearization parameters
Polarization $\Phi$	$\Phi$ rotation around probe axis
Polarization $\theta$	$\theta$ rotation around an axis that is in the plane normal to probe axis (at measurement center), i $\theta=0$ is normal to probe axis

Connector Angle information used in DASY system to align probe sensor X to the robot coordinate system

### Calibration is Performed According to the Following Standards:

- a) IEEE Std 1528-2013, "IEEE Recommended Practice for Determining the Peak Spatial-Averaged Specific Absorption Rate (SAR) in the Human Head from Wireless Communications Devices: Measurement Techniques", June 2013
- b) IEC 62209-1, "Procedure to measure the Specific Absorption Rate (SAR) for hand-held devices used in close proximity to the ear (frequency range of 300MHz to 3GHz)", February 2005
- c) IEC 62209-2, "Procedure to determine the Specific Absorption Rate (SAR) for wireless communication devices used in close proximity to the human body (frequency range of 30 MHz to 6 GHz)", March 2010
- d) KDB 865664, "SAR Measurement Requirements for 100 MHz to 6 GHz"

### Methods Applied and Interpretation of Parameters:

- **NORM<sub>x,y,z</sub>**: Assessed for E-field polarization  $\theta=0$  ( $f \leq 900\text{MHz}$  in TEM-cell;  $f > 1800\text{MHz}$ : waveguide). NORM<sub>x,y,z</sub> are only intermediate values, i.e., the uncertainties of NORM<sub>x,y,z</sub> does not effect the  $E^2$ -field uncertainty inside TSL (see below ConvF).
- **NORM(f)<sub>x,y,z</sub> = NORM<sub>x,y,z</sub> \* frequency\_response** (see Frequency Response Chart). This linearization is implemented in DASY4 software versions later than 4.2. The uncertainty of the frequency response is included in the stated uncertainty of ConvF.
- **DCP<sub>x,y,z</sub>**: DCP are numerical linearization parameters assessed based on the data of power sweep (no uncertainty required). DCP does not depend on frequency nor media.
- **PAR**: PAR is the Peak to Average Ratio that is not calibrated but determined based on the signal characteristics.
- **A<sub>x,y,z</sub>; B<sub>x,y,z</sub>; C<sub>x,y,z</sub>; VR<sub>x,y,z</sub>; A,B,C** are numerical linearization parameters assessed based on the data of power sweep for specific modulation signal. The parameters do not depend on frequency nor media. VR is the maximum calibration range expressed in RMS voltage across the diode.
- **ConvF and Boundary Effect Parameters**: Assessed in flat phantom using E-field (or Temperature Transfer Standard for  $f \leq 800\text{MHz}$ ) and inside waveguide using analytical field distributions based on power measurements for  $f > 800\text{MHz}$ . The same setups are used for assessment of the parameters applied for boundary compensation (alpha, depth) of which typical uncertainty valued are given. These parameters are used in DASY4 software to improve probe accuracy close to the boundary. The sensitivity in TSL corresponds to NORM<sub>x,y,z</sub> \* ConvF whereby the uncertainty corresponds to that given for ConvF. A frequency dependent ConvF is used in DASY version 4.4 and higher which allows extending the validity from  $\pm 50\text{MHz}$  to  $\pm 100\text{MHz}$ .
- **Spherical isotropy (3D deviation from isotropy)**: in a field of low gradients realized using a flat phantom exposed by a patch antenna.
- **Sensor Offset**: The sensor offset corresponds to the offset of virtual measurement center from the probe tip (on probe axis). No tolerance required.
- **Connector Angle**: The angle is assessed using the information gained by determining the NORM<sub>x</sub> (no uncertainty required).



Add: No.51 Xueyuan Road, Haidian District, Beijing, 100191, China  
Tel: +86-10-62304633-2218 Fax: +86-10-62304633-2209  
E-mail: [ctl@chinattl.com](mailto:ctl@chinattl.com) [Http://www.chinattl.cn](http://www.chinattl.cn)

## Probe EX3DV4

### SN: 3754

Calibrated: January 13, 2017

Calibrated for DASY/EASY Systems

(Note: non-compatible with DASY2 system!)





In Collaboration with  
**TTL s p e a g**  
**CALIBRATION LABORATORY**  
 Add: No.51 Xueyuan Road, Haidian District, Beijing, 100191, China  
 Tel: +86-10-62304633-2218 Fax: +86-10-62304633-2209  
 E-mail: cttl@chinattl.com [Http://www.chinattl.cn](http://www.chinattl.cn)

## DASY/EASY – Parameters of Probe: EX3DV4 – SN: 3754

### Basic Calibration Parameters

	Sensor X	Sensor Y	Sensor Z	Unc (k=2)
Norm( $\mu\text{V}/(\text{V}/\text{m})^2$ ) <sup>A</sup>	0.48	0.41	0.59	$\pm 10.8\%$
DCP(mV) <sup>B</sup>	102.4	100.9	102.7	

### Modulation Calibration Parameters

UID	Communication System Name		A dB	B dB $\sqrt{\mu\text{V}}$	C	D dB	VR mV	Unc <sup>E</sup> (k=2)
0	CW	X	0.0	0.0	1.0	0.00	198.9	$\pm 2.0\%$
		Y	0.0	0.0	1.0		175.6	
		Z	0.0	0.0	1.0		221.1	

The reported uncertainty of measurement is stated as the standard uncertainty of Measurement multiplied by the coverage factor k=2, which for a normal distribution corresponds to a coverage probability of approximately 95%.

<sup>A</sup> The uncertainties of Norm X, Y, Z do not affect the E<sup>2</sup>-field uncertainty inside TSL (see Page 5 and Page 6).

<sup>B</sup> Numerical linearization parameter: uncertainty not required.

<sup>E</sup> Uncertainty is determined using the max. deviation from linear response applying rectangular distribution and is expressed for the square of the field value.



In Collaboration with  
**TTL SPEAG**  
**CALIBRATION LABORATORY**  
 Add: No.51 Xueyuan Road, Haidian District, Beijing, 100191, China  
 Tel: +86-10-62304633-2218 Fax: +86-10-62304633-2209  
 E-mail: cttl@chinattl.com [Http://www.chinattl.cn](http://www.chinattl.cn)

## DASY/EASY – Parameters of Probe: EX3DV4 – SN: 3754

### Calibration Parameter Determined in Head Tissue Simulating Media

f [MHz] <sup>C</sup>	Relative Permittivity <sup>F</sup>	Conductivity (S/m) <sup>F</sup>	ConvF X	ConvF Y	ConvF Z	Alpha <sup>G</sup>	Depth <sup>G</sup> (mm)	Unct. (k=2)
750	41.9	0.89	9.41	9.41	9.41	0.30	0.70	±12%
900	41.5	0.97	9.10	9.10	9.10	0.13	1.52	±12%
1750	40.1	1.37	8.08	8.08	8.08	0.17	1.23	±12%
1900	40.0	1.40	7.85	7.85	7.85	0.24	1.05	±12%
2100	39.8	1.49	7.73	7.73	7.73	0.23	1.12	±12%
2300	39.5	1.67	7.58	7.58	7.58	0.56	0.72	±12%
2450	39.2	1.80	7.26	7.26	7.26	0.55	0.73	±12%
2600	39.0	1.96	7.05	7.05	7.05	0.60	0.70	±12%
5250	35.9	4.71	5.20	5.20	5.20	0.45	1.30	±13%
5600	35.5	5.07	4.62	4.62	4.62	0.45	1.35	±13%
5750	35.4	5.22	4.73	4.73	4.73	0.45	1.55	±13%

<sup>C</sup> Frequency validity above 300 MHz of ±100MHz only applies for DASY v4.4 and higher (Page 2), else it is restricted to ±50MHz. The uncertainty is the RSS of ConvF uncertainty at calibration frequency and the uncertainty for the indicated frequency band. Frequency validity below 300 MHz is ± 10, 25, 40, 50 and 70 MHz for ConvF assessments at 30, 64, 128, 150 and 220 MHz respectively. Above 5 GHz frequency validity can be extended to ± 110 MHz.

<sup>F</sup> At frequency below 3 GHz, the validity of tissue parameters ( $\epsilon$  and  $\sigma$ ) can be relaxed to ±10% if liquid compensation formula is applied to measured SAR values. At frequencies above 3 GHz, the validity of tissue parameters ( $\epsilon$  and  $\sigma$ ) is restricted to ±5%. The uncertainty is the RSS of the ConvF uncertainty for indicated target tissue parameters.

<sup>G</sup> Alpha/Depth are determined during calibration. SPEAG warrants that the remaining deviation due to the boundary effect after compensation is always less than ± 1% for frequencies below 3 GHz and below ± 2% for the frequencies between 3-6 GHz at any distance larger than half the probe tip diameter from the boundary.



In Collaboration with  
**TTL SPEAG**  
**CALIBRATION LABORATORY**  
 Add: No.51 Xueyuan Road, Haidian District, Beijing, 100191, China  
 Tel: +86-10-62304633-2218 Fax: +86-10-62304633-2209  
 E-mail: cttl@chinattl.com [Http://www.chinattl.cn](http://www.chinattl.cn)

## DASY/EASY – Parameters of Probe: EX3DV4 – SN: 3754

### Calibration Parameter Determined in Body Tissue Simulating Media

f [MHz] <sup>C</sup>	Relative Permittivity <sup>F</sup>	Conductivity (S/m) <sup>F</sup>	ConvF X	ConvF Y	ConvF Z	Alpha <sup>G</sup>	Depth <sup>G</sup> (mm)	Unct. (k=2)
750	55.5	0.96	9.66	9.66	9.66	0.40	0.85	±12%
900	55.0	1.05	9.31	9.31	9.31	0.23	1.17	±12%
1750	53.4	1.49	7.80	7.80	7.80	0.22	1.14	±12%
1900	53.3	1.52	7.60	7.60	7.60	0.20	1.22	±12%
2100	53.2	1.62	7.96	7.96	7.96	0.23	1.24	±12%
2300	52.9	1.81	7.43	7.43	7.43	0.41	1.01	±12%
2450	52.7	1.95	7.22	7.22	7.22	0.40	1.04	±12%
2600	52.5	2.16	7.15	7.15	7.15	0.45	0.92	±12%
5250	48.9	5.36	4.79	4.79	4.79	0.50	1.55	±13%
5600	48.5	5.77	4.09	4.09	4.09	0.55	1.50	±13%
5750	48.3	5.94	4.55	4.55	4.55	0.58	1.70	±13%

<sup>C</sup> Frequency validity above 300 MHz of ±100MHz only applies for DASY v4.4 and higher (Page 2), else it is restricted to ±50MHz. The uncertainty is the RSS of ConvF uncertainty at calibration frequency and the uncertainty for the indicated frequency band. Frequency validity below 300 MHz is ± 10, 25, 40, 50 and 70 MHz for ConvF assessments at 30, 64, 128, 150 and 220 MHz respectively. Above 5 GHz frequency validity can be extended to ± 110 MHz.

<sup>F</sup> At frequency below 3 GHz, the validity of tissue parameters ( $\epsilon$  and  $\sigma$ ) can be relaxed to ±10% if liquid compensation formula is applied to measured SAR values. At frequencies above 3 GHz, the validity of tissue parameters ( $\epsilon$  and  $\sigma$ ) is restricted to ±5%. The uncertainty is the RSS of the ConvF uncertainty for indicated target tissue parameters.

<sup>G</sup> Alpha/Depth are determined during calibration. SPEAG warrants that the remaining deviation due to the boundary effect after compensation is always less than ± 1% for frequencies below 3 GHz and below ± 2% for the frequencies between 3-6 GHz at any distance larger than half the probe tip diameter from the boundary.



In Collaboration with  
**TTLspeag**  
**CALIBRATION LABORATORY**  
 Add: No.51 Xueyuan Road, Haidian District, Beijing, 100191, China  
 Tel: +86-10-62304633-2218 Fax: +86-10-62304633-2209  
 E-mail: cttl@chinattl.com [Http://www.chinattl.cn](http://www.chinattl.cn)

## Frequency Response of E-Field (TEM-Cell: ifi110 EXX, Waveguide: R22)

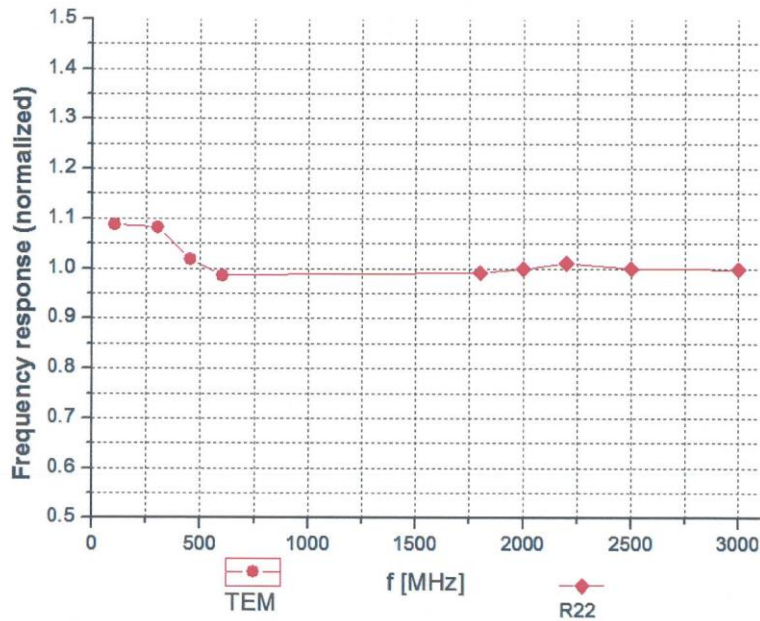

Uncertainty of Frequency Response of E-field:  $\pm 7.5\%$  (k=2)



In Collaboration with  
**TTL Speaq**  
 CALIBRATION LABORATORY  
 Add: No.51 Xueyuan Road, Haidian District, Beijing, 100191, China  
 Tel: +86-10-62304633-2218 Fax: +86-10-62304633-2209  
 E-mail: cttl@chinattl.com [Http://www.chinattl.cn](http://www.chinattl.cn)

## Receiving Pattern ( $\Phi$ ), $\theta=0^\circ$

**f=600 MHz, TEM**

**f=1800 MHz, R22**

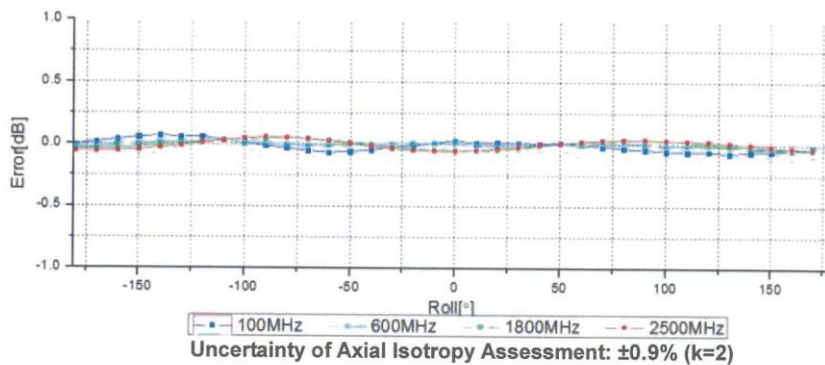
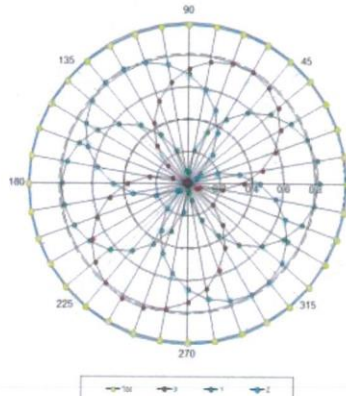
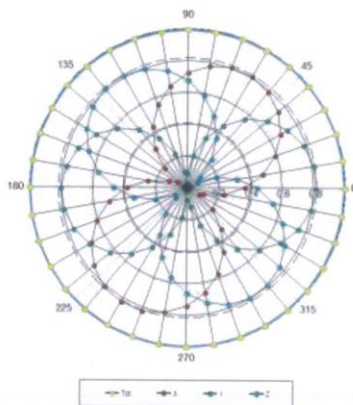





Add: No.51 Xueyuan Road, Haidian District, Beijing, 100191, China  
 Tel: +86-10-62304633-2218 Fax: +86-10-62304633-2209  
 E-mail: cttl@chinattl.com [Http://www.chinattl.cn](http://www.chinattl.cn)

## Dynamic Range f(SAR<sub>head</sub>) (TEM cell, f = 900 MHz)

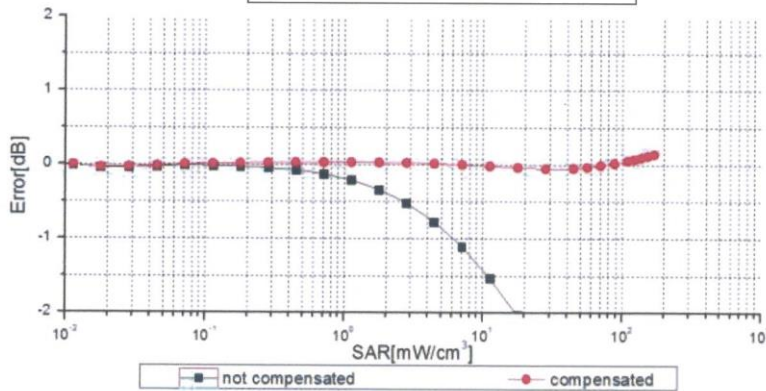
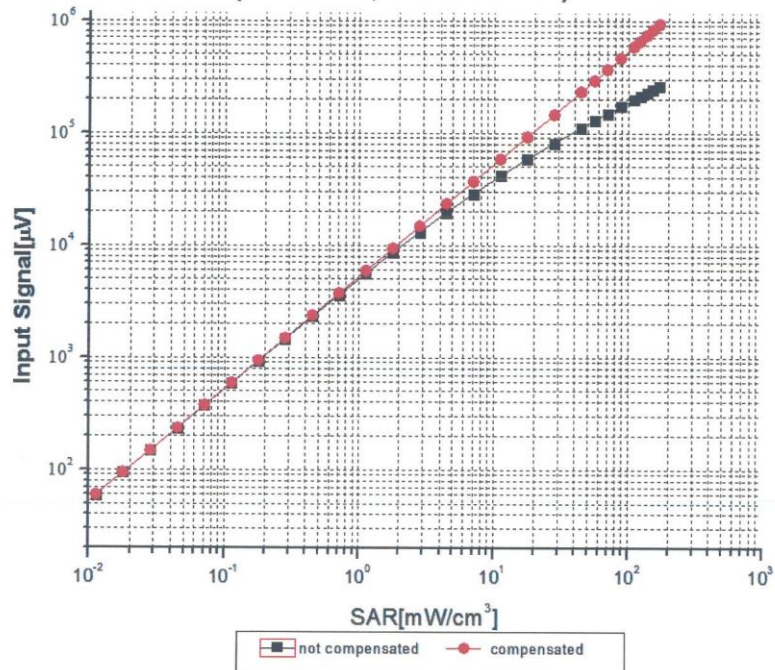

Uncertainty of Linearity Assessment: ±0.9% (k=2)