



TEST REPORT

No. I17D00058-EMC

For

**Client : Lenovo (Shanghai) Electronics Technology
Co., Ltd**

Production: Portable Tablet Computer

Model Name : TB-X704V

Hardware Version: Lenovo Tablet TB-X704V

Software Version: TB-X704V_RF01_20170301

Brand: Lenovo

FCC ID: O57TBX704V

IC ID: 10407A-TBX704V

Issued date: 2017-06-22

Note:

The test results in this test report relate only to the devices specified in this report. This report shall not be reproduced except in full without the written approval of ECIT Shanghai.

Test Laboratory:

ECIT Shanghai, East China Institute of Telecommunications

Add: 7F, G Area, No.668, Beijing East Road, Huangpu District, Shanghai, P. R. China

Tel: (+86)-021-63843300, E-Mail: welcome@ecit.org.cn

Revision Version

Report Number	Revision	Date	Memo
I17D00058-EMC	00	2017-06-22	Initial creation of test report

CONTENTS

1. TEST LABORATORY
1.1. TESTING LOCATION
1.2. TESTING ENVIRONMENT
1.3. PROJECT DATA
1.4. SIGNATURE.....
2. CLIENT INFORMATION
2.1. APPLICANT INFORMATION.....
2.2. MANUFACTURER INFORMATION.....
3. EQUIPMENT UNDER TEST (EUT) AND ANCILLARY EQUIPMENT (AE).....
3.1. ABOUT EUT.....
3.2. INTERNAL IDENTIFICATION OF EUT USED DURING THE TEST
3.3. INTERNAL IDENTIFICATION OF AE USED DURING THE TEST
3.4. EQUIPMENT UNDER TEST (EUT) OF THE DESCRIBED
4. REFERENCE DOCUMENTS
4.1 REFERENCE DOCUMENTS FOR TESTING
5. TEST RESULTS.....
5.1 SUMMARY OF TEST RESULTS
5.2 STATEMENTS.....
6. TEST EQUIPMENTS UTILIZED
6.1 RADIATED EMISSION EQUIPMENTS LIST
6.2 CE EQUIPMENTS LIST
7. SYSTEM CONFIGURATION DURING TEST.....
7.1 TEST MODE.....
7.2 CONNECTION DIAGRAM OF TEST SYSTEM.....
8. MEASUREMENT RESULTS.....

8.1 RADIATED EMISSION 30MHZ-12.75GHZ

8.2 CONDUCTED EMISSION.....

1. Test Laboratory

1.1. Testing Location

Company Name: ECIT Shanghai, East China Institute of Telecommunications
Address: 7F, G Area, No. 668, Beijing East Road, Huangpu District, Shanghai,
P. R. China
Postal Code: 200001
Telephone: 86-21-63843300
Fax: 86-21-63843301
FCC registration No: 489729
IC OAT'S Test Site
registration No: 10766A-1

1.2. Testing Environment

Normal Temperature: 15-35°C
Relative Humidity: 30-60%

1.3. Project data

Project Leader: Chen Minfei
Testing Start Date: 04-25, 2017
Testing End Date: 06-22, 2017

1.4. Signature



Tong Daocheng

(Prepared this test report)



You Jinjun

(Reviewed this test report)

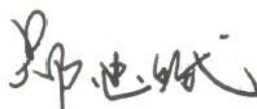

Zheng Zhongbin

Director of the laboratory

(Approved this test report)

2. Client Information

2.1. Applicant Information

Company Name: Lenovo (Shanghai) Electronics Technology Co., Ltd
Address /Post: NO.68 BUILDING, 199 FENJU RD, Pilot Free Trade Zone, Shanghai,
200131, China
Tel: 13776306969
City: /
Country: /

2.2. Manufacturer Information

Company Name: Lenovo PC HK Limited
Address /Post: 23/F, Lincoln House, Taikoo Place979 King's Road, Quarry Bay, Hong
Kong
Tel: 13776306969
City: /
Country: /

3. Equipment under Test (EUT) and Ancillary Equipment (AE)

3.1. About EUT

EUT Description	Portable Tablet Computer
Model name	TB-X704V
Serial Number or IMEI	863923030005473/803923030008303
HW Version	Lenovo Tablet TB-X704V
SW Version	TB-X704V_RF01_20170301
UMTS Frequency Band	WCDMA Band II /Band V
LTE Frequency Band	FDD 2/4/5/7/12/13
Additional Communication Function	BT 2.1,EDR,3.0,4.0,4.2,BLE/WIFI 802.11a,b,g,n,ac

3.2. Internal Identification of EUT used during the test

EUT ID*	SN or IMEI	HW Version	SW Version	Date of receipt
N06	863923030005473	Lenovo Tablet TB-X704V	TB-X704V_RF01_2 0170301	2017-3-31
N20	803923030008303	Lenovo Tablet TB-X704V	TB-X704V_RF01_2 0170301	2017-3-31

*EUT ID: is used to identify the test sample in the lab internally.

3.3. Internal Identification of AE used during the test

AE ID*	Description	Model	SN	Remake
C105	Adapter	C-P35	NA	100-240V~50/60Hz 0.3A
C202	Adapter	C-P35	NA	100-240V~50/60Hz 0.5A
U104	USB Cable	NA	NA	NA
AE4	Desktop PC	OptiPlex 790 DT	X8RP1 A01 APCC	NA
AE5	Notebook PC	DELL Latitude E5250	NA	NA
AE6	LAN Cable	NA	NA	NA
AE7	VGA Cable	NA	NA	NA
AE8	RS232 Cable	NA	NA	NA
AE9	Keyboard	KB212-B	CN-0Y88XT-65890- 12I-005Q-A00	NA
AE10	Mouse	MS111-P	CN-011D3V-71581- 19J-1A64	NA

*AE ID: is used to identify the test sample in the lab internally.

3.4. Equipment Under Test (EUT) of the Described

After assessment, sample 1 has worse test result and is chosen to perform all other tests as representative.

component	Sample 1(N06)	Sample 2(N20)
CPU	Qualcomm MSM-8953-3-857NSP-TR-01-0-AB	Qualcomm MSM-8953-3-857NSP-TR-01-0-AB
BT/WIFI Module	Qualcomm WCN-3680B-0-79BWLNSP-TR-05-1	Qualcomm WCN-3680B-0-79BWLNSP-TR-05-1
RAM/EMMC	2G+16G Samsung KMQE10013M-B318 MCP_16GB+16Gb,LPDDR3	2G+16G Hynix H9TQ17ABJTBCUR-KUM MCP_16GB+16Gb,LPDDR3
LCD	INX P101KDA-AF0	BOE TV101WUM-NL1
Battery	SCUD L16D2P31 3.85V/7000mAh	Celxpert L16D2P31 3.85V/7000mAh
Camera front	Q Tech F5695AK	AVC BFL05006
Camera rear	Q Tech FX219BH	film L8856A10

4. Reference Documents

4.1 Reference Documents for testing

The following documents listed in this section are referred for testing.

Reference	Title	Version
FCC Part 15, Subpart B	Radio frequency devices	10-1-10 Edition
ANSI C63.4	Method of Measurement of Radio-Noise Emissions from Low-Voltage Electrical and Electronic Equipment in the Range of 9 kHz to 40 GHz	2014
ICES-003	Information Technology Equipment(Including Digital Apparatus)-Limits and Methods of Measurement	2016

5. Test Results

5.1 Summary of Test Results

Items	Test List	Clause in FCC rules	Verdict
1	Radiated Emission	15.109(a)	Pass
2	Conducted Emission	15.107(a)	Pass

5.2 Statements

The Portable Tablet Computer, manufactured by Lenovo PC HK Limited is a new product for testing. ECIT performed test cases which identified with Pass/Fail/Inc result in section 5.1.

ECIT has verified that the compliance of the tested device specified in section 3 of this test report is successfully evaluated according to the procedure and test methods as defined in type certification requirement listed in section 4 of this test report.

6. Test Equipments Utilized

6.1 Radiated Emission Equipments list

No.	Name	Type	Series Number	Producer	Cal. Date	Cal. interval
1	Universal Radio Communication	CMU200	123126	R&S	2017-05-11	1 Year
2	Test Receiver	ESU40	100307	R&S	2017-05-11	1 Year
3	Trilog Antenna	VULB9163	VULB9163-515	Schwarzbeck	2017-02-25	3 Year
4	Double Ridged Guide	ETS-3117	00135890	ETS	2017-01-11	3 Year
5	EMI Test Software	EMC32 V9.15	NA	R&S	NA	NA

6.2 CE Equipments list

No.	Name	Type	Series Number	Producer	Cal. Date	Cal. interval
1	Universal Radio	CMU200	123123	R&S	2017-05-11	1 Year
2	Test Receiver	ESCI	101235	R&S	2017-05-11	1 Year
3	2-Line V-Network	ENV216	101380	R&S	2017-05-11	1 Year
4	EMI Test Software	EMC32 V9.15	NA	R&S	NA	NA

7. System Configuration during Test

7.1 Test Mode

N06 Sample1

Test Item	Function Type
AC Conducted Emission	Mode 1: USB cable (Data Link with PC) <Figure 1> Mode 2: Adapter charging +C105<Figure 2> Mode 3: Adapter charging +C202<Figure 2>
Radiated Emission	Mode 1: USB cable (Data Link with PC) <Figure 1> Mode 2: Adapter charging +C105 <Figure 2> Mode 3: Adapter charging +C202<Figure 2>
Remark: 1. All test modes are performed, only the worst cases test data are recorded in this report. 2. Data Link with PC means data application transferred mode between EUT and PC.	

N20 Sample2

Test Item	Function Type
AC Conducted Emission	Mode 1: USB cable (Data Link with PC) <Figure 1> Mode 2: Adapter charging +C105<Figure 2> Mode 3: Adapter charging +C202<Figure 2>
Radiated Emission	Mode 1: USB cable (Data Link with PC) <Figure 1> Mode 2: Adapter charging +C105 <Figure 2> Mode 3: Adapter charging +C202<Figure 2>
Remark: 3. All test modes are performed, only the worst cases test data are recorded in this report. 4. Data Link with PC means data application transferred mode between EUT and PC.	

7.2 Connection Diagram of Test System

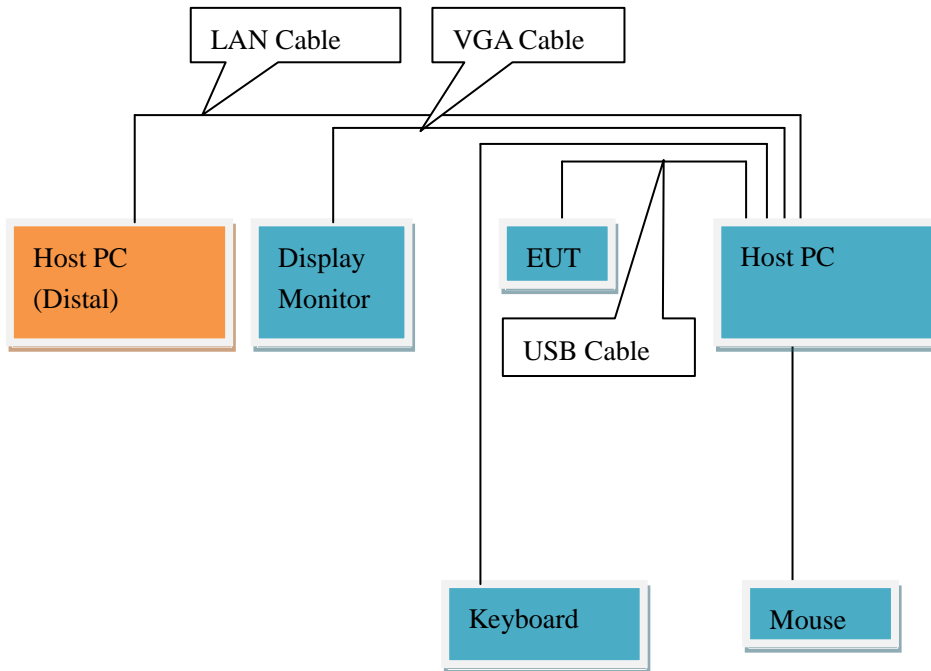

<Figure 1>

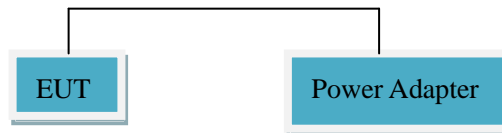

<Figure 2>

8. Measurement Results

Only the worst test result was shown in this report.

8.1 Radiated Emission 30MHz-12.75GHz

Method of Measurement

For 30-1000MHz, the EUT was placed on the top of a rotating 0.8-m table above the ground at a semi-anechoic chamber. The distance between the EUT and the received antenna was 3 meters. The table was rotated 360 degree and the received antenna mounted on a variable-height antenna tower was varied from 1m to 4m to find the maximum value of the field strength. Both horizontal and vertical polarizations of the antenna were set during the measurement. Tested in accordance with the procedures of ANSI C63.4-2014, section 8.3.

For 1000-12750MHz, The maximal emission value was acquired by adjusting the antenna height, The table was rotated 360 degree to determine the maximum value of the field strength. Both horizontal and vertical polarizations of the antenna were set during the measurement.

Limits for Radiated Emission at a measuring distance of 3m

Frequency Range (MHz)	Quasi-Peak (dBuV/m)
30-88	40
88-216	43.5
216-960	46
Above 960	54

Frequency Range (MHz)	Peak (dBuV/m)	Average (dBuV/m)
Above 1000	74	54

Test conditions

Frequency Range (MHz)	RBW/VBW	Sweep Time (s)
30-1000	120KHz/300KHz	Auto
1000-12750	1MHz/3MHz	Auto

Uncertainty Measurement

The measurement uncertainty is 5.82dB (k=2).

Test Results

N06 Mode 1: USB cable (Data Link with PC)

Frequency Range: 30MHz – 1GHz

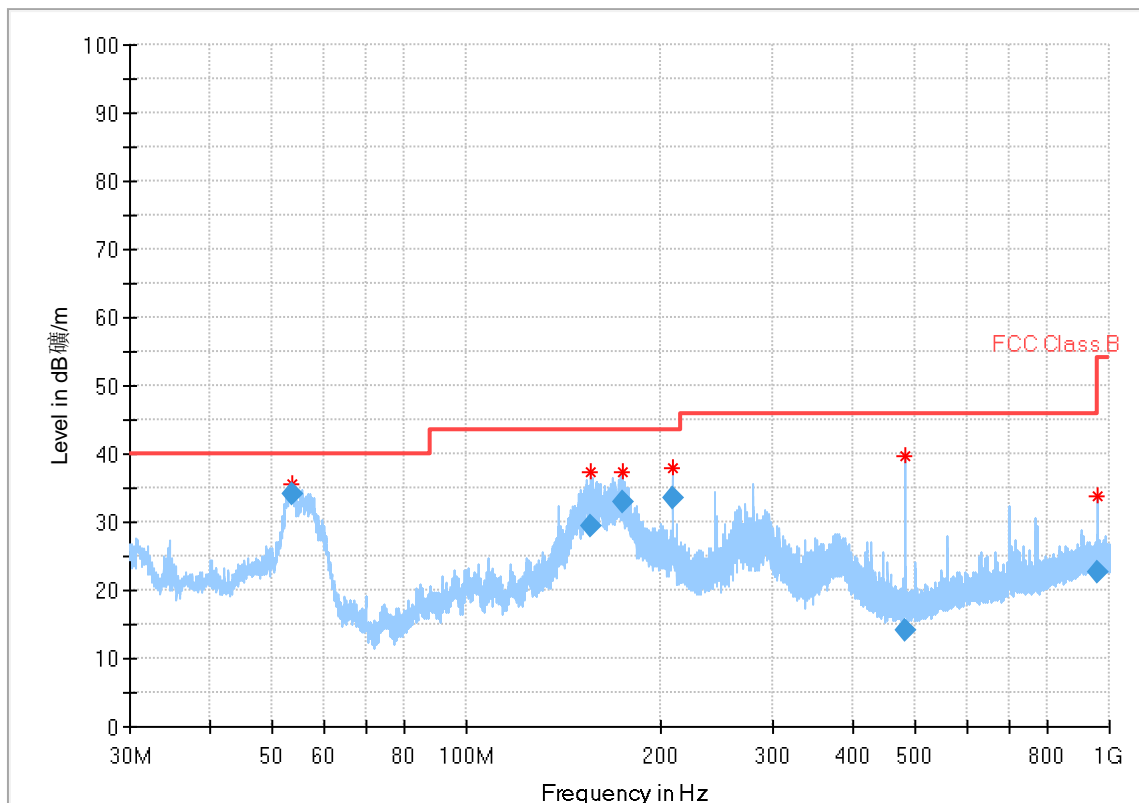

Frequency (MHz)	QuasiPeak (dBµV/m)	Limit (dBµV/m)	Margin (dB)	Meas. Time (ms)	Bandwidth (kHz)	Height (cm)	Pol	Azimuth (deg)	Corr. (dB)
53.458347	34.16	40.00	5.84	1000.0	120.000	100.0	V	96.0	-23.9
156.077107	29.27	43.50	14.23	1000.0	120.000	106.0	H	115.0	-27.6
175.616400	32.89	43.50	10.61	1000.0	120.000	181.0	H	102.0	-26.3
209.124296	33.42	43.50	10.08	1000.0	120.000	125.0	H	83.0	-24.4
479.956616	14.08	46.00	31.92	1000.0	120.000	100.0	H	114.0	-16.7
960.012440	22.70	54.00	31.30	1000.0	120.000	175.0	H	145.0	-9.2

Note:

1. Emission level(QP)=Raw value by receiver + Corr(Antenna factor + cable loss - preamplifier gain)
2. The raw value is used to calculate by software which is not shown in the sheet.
3. Margin=limit value – emission level.

N06 Mode 1: USB cable (Data Link with PC)

Frequency Range:

1GHz –12.75GHz

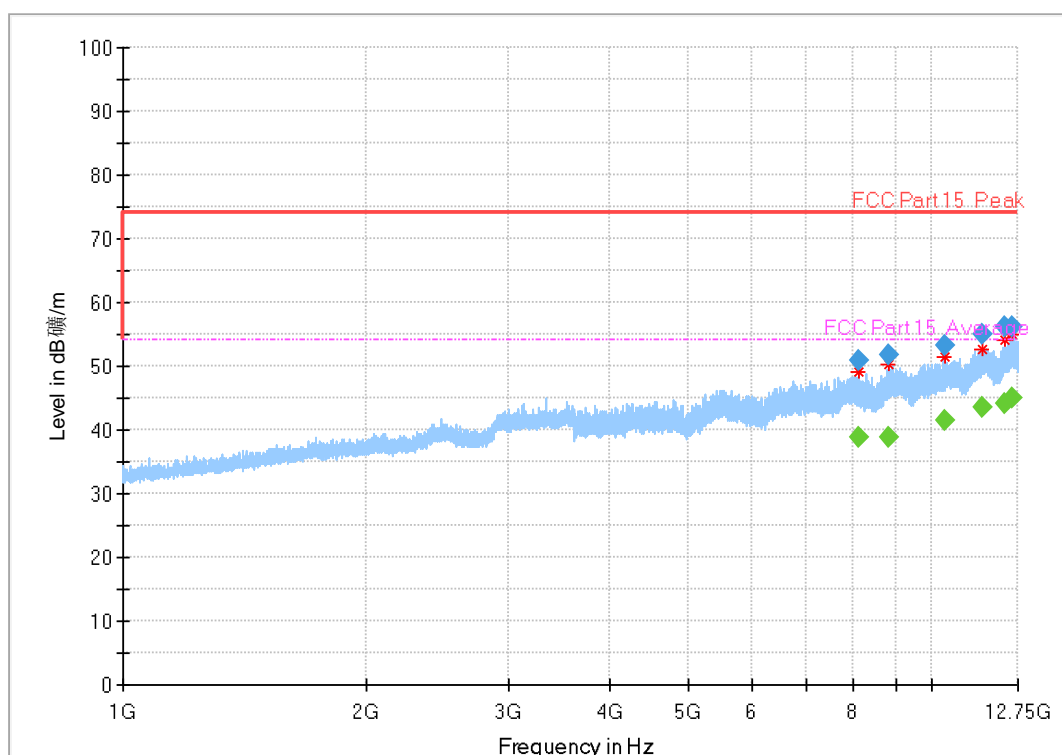

Final Result

Frequency (MHz)	MaxPeak (dBuV/m)	Average (dBuV/m)	Limit (dBuV/m)	Margin (dB)	Meas. Time	Bandwidth (kHz)	Height	Po	Azim	Corr. (dB)
8093.689866	51.01	---	74.00	22.99	50.0	1000.000	300.0	H	19.0	9.3
8093.689866	---	38.70	54.00	15.30	50.0	1000.000	300.0	H	19.0	9.3
8837.185800	---	38.97	54.00	15.03	50.0	1000.000	300.0	H	37.0	9.8
8837.185800	51.87	---	74.00	22.13	50.0	1000.000	300.0	H	37.0	9.8
10383.402533	53.26	---	74.00	20.74	50.0	1000.000	300.0	H	340.0	12.6
10383.402533	---	41.38	54.00	12.62	50.0	1000.000	300.0	H	340.0	12.6
11494.230333	---	43.61	54.00	10.39	50.0	1000.000	100.0	H	197.0	15.1
11494.230333	55.13	---	74.00	18.87	50.0	1000.000	100.0	H	197.0	15.1
12277.972533	56.15	---	74.00	17.85	50.0	1000.000	300.0	H	215.0	15.9
12277.972533	---	44.18	54.00	9.82	50.0	1000.000	300.0	H	215.0	15.9
12540.364133	56.16	---	74.00	17.84	50.0	1000.000	100.0	H	22.0	16.6
12540.364133	---	44.87	54.00	9.13	50.0	1000.000	100.0	H	22.0	16.6

Note:

1. Emission level(peak or average)=Raw value by receiver + Corr(Antenna factor+ cable loss - preamplifier gain)
2. The raw value is used to calculate by software which is not shown in the sheet.
3. Margin=limit value – emission level.

Frequency Range:

1GHz –12.75GHz

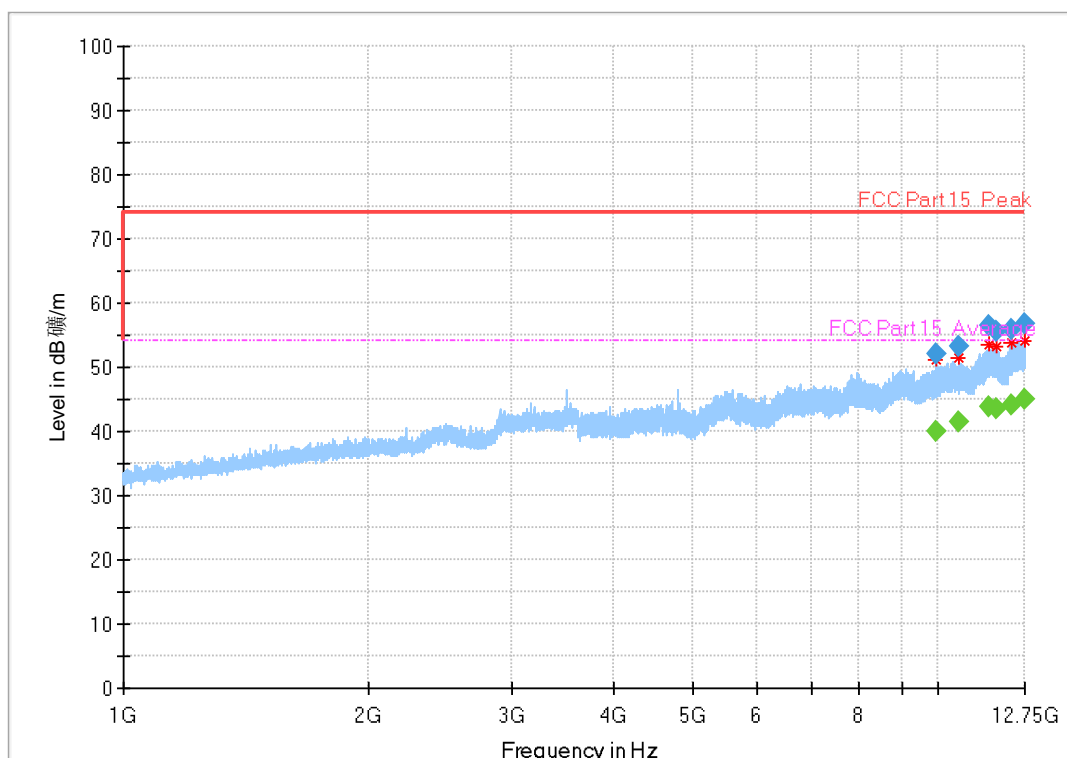

Final Result

Frequency (MHz)	MaxPeak (dBuV/m)	Average (dBuV/m)	Limit (dBuV/m)	Margi n	Meas. Time	Bandwidt h	Heigh t	Po l	Azimuth (deg)	Corr. (dB)
9914.667133	52.16	---	74.00	21.84	50.0	1000.000	100.0	V	199.0	11.2
9914.667133	---	39.87	54.00	14.13	50.0	1000.000	100.0	V	199.0	11.2
10570.687067	53.13	---	74.00	20.87	50.0	1000.000	300.0	V	308.0	13.1
10570.687067	---	41.57	54.00	12.43	50.0	1000.000	300.0	V	308.0	13.1
11508.250533	56.51	---	74.00	17.49	50.0	1000.000	200.0	V	31.0	15.1
11508.250533	---	43.72	54.00	10.28	50.0	1000.000	200.0	V	31.0	15.1
11777.812467	---	43.59	54.00	10.41	50.0	1000.000	300.0	V	221.0	15.2
11777.812467	55.61	---	74.00	18.39	50.0	1000.000	300.0	V	221.0	15.2
12263.200134	---	44.14	54.00	9.86	50.0	1000.000	300.0	V	-9.0	15.8
12263.200134	55.90	---	74.00	18.10	50.0	1000.000	300.0	V	-9.0	15.8
12733.036267	56.63	---	74.00	17.37	50.0	1000.000	200.0	V	160.0	16.8
12733.036267	---	45.08	54.00	8.92	50.0	1000.000	200.0	V	160.0	16.8

Note:

1. Emission level(peak or average)=Raw value by receiver + Corr(Antenna factor+ cable loss - preamplifier gain)
2. The raw value is used to calculate by software which is not shown in the sheet.
3. Margin=limit value – emission level.

N20 Mode 1: USB cable (Data Link with PC)

Frequency Range:

30MHz – 1GHz

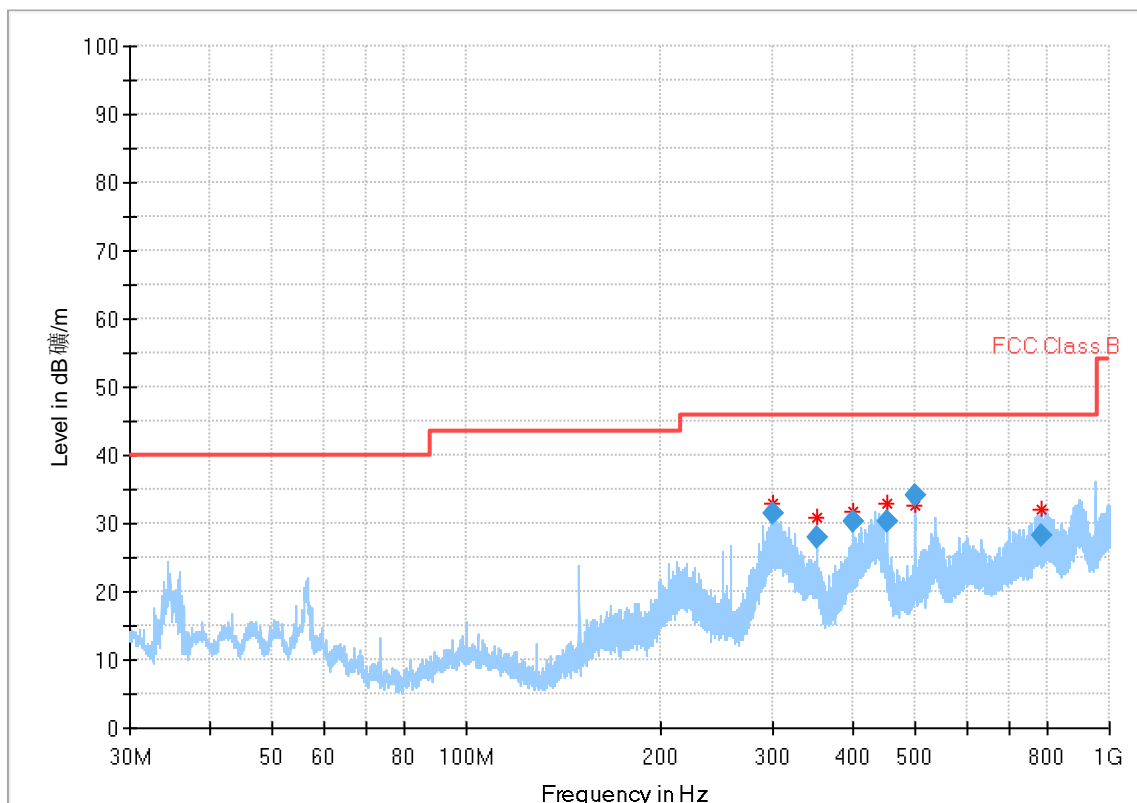

Frequency (MHz)	QuasiPeak (dBµV/m)	Limit (dBµV/m)	Margin (dB)	Meas. Time (ms)	Bandwidth (kHz)	Height (cm)	Pol	Azimuth (deg)	Corr. (dB)
300.014565	31.51	46.00	14.49	1000.0	120.000	100.0	H	169.0	-21.4
349.931677	27.90	46.00	18.10	1000.0	120.000	100.0	H	256.0	-19.7
399.986845	30.27	46.00	15.73	1000.0	120.000	100.0	H	77.0	-18.4
449.896088	30.40	46.00	15.60	1000.0	120.000	100.0	H	54.0	-17.3
499.988581	34.23	46.00	11.77	1000.0	120.000	275.0	H	31.0	-16.3
782.988672	28.14	46.00	17.86	1000.0	120.000	100.0	H	140.0	-11.8

Note:

- Emission level(QP)=Raw value by receiver + Corr(Antenna factor + cable loss - preamplifier gain)
- The raw value is used to calculate by software which is not shown in the sheet.
- Margin=limit value – emission level.

N20 Mode 1: USB cable (Data Link with PC)

Frequency Range:

1GHz –12.75GHz

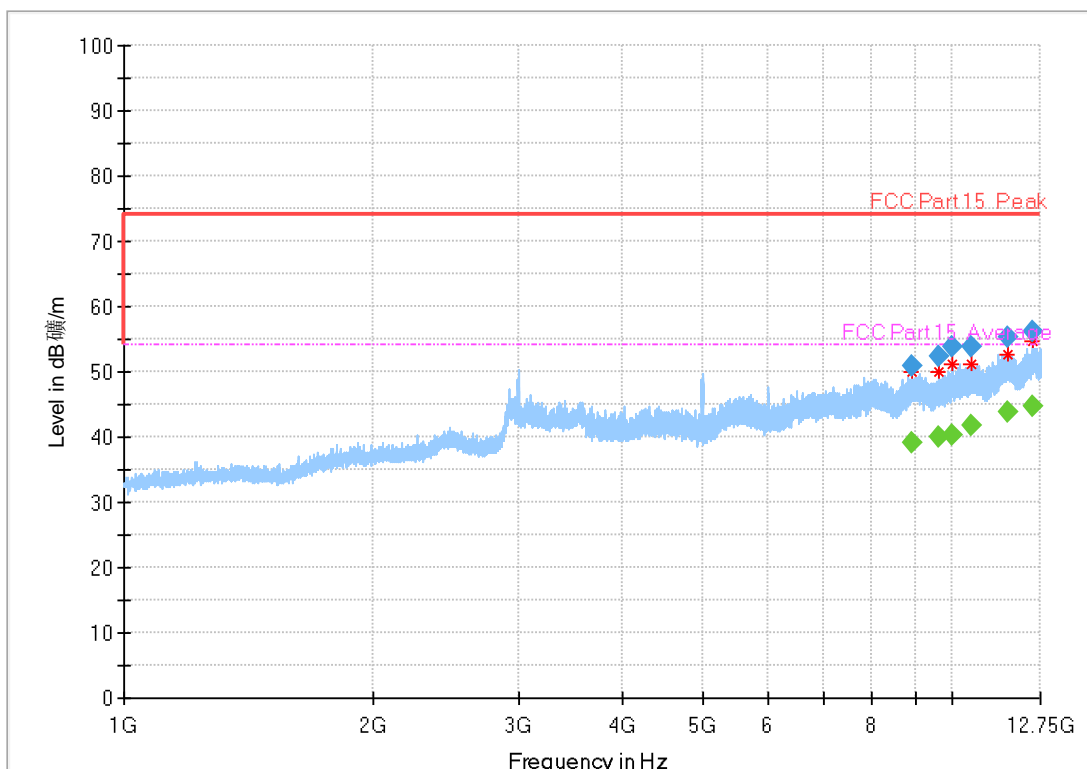

Final Result

Frequency (MHz)	MaxPeak (dBuV/m)	Average (dBuV/m)	Limit (dBuV/m)	Margin (dB)	Meas. Time	Bandwidth (kHz)	Height	Po	Azimuth	Corr. (dB)
8943.773533	---	39.17	54.00	14.83	50.0	1000.000	200.0	H	201.0	10.1
8943.773533	51.01	---	74.00	22.99	50.0	1000.000	200.0	H	201.0	10.1
9619.072066	---	40.05	54.00	13.95	50.0	1000.000	200.0	H	-18.0	11.0
9619.072066	52.46	---	74.00	21.54	50.0	1000.000	200.0	H	-18.0	11.0
9968.233067	53.78	---	74.00	20.22	50.0	1000.000	300.0	H	185.0	11.3
9968.233067	---	40.40	54.00	13.60	50.0	1000.000	300.0	H	185.0	11.3
10499.323267	---	41.83	54.00	12.17	50.0	1000.000	300.0	H	131.0	13.1
10499.323267	53.95	---	74.00	20.05	50.0	1000.000	300.0	H	131.0	13.1
11618.457333	---	43.73	54.00	10.27	50.0	1000.000	300.0	H	-9.0	15.2
11618.457333	55.16	---	74.00	18.84	50.0	1000.000	300.0	H	-9.0	15.2
12465.498134	56.26	---	74.00	17.74	50.0	1000.000	200.0	H	43.0	16.4
12465.498134	---	44.61	54.00	9.39	50.0	1000.000	200.0	H	43.0	16.4

Note:

1. Emission level(peak or average)=Raw value by receiver + Corr(Antenna factor+ cable loss - preamplifier gain)
2. The raw value is used to calculate by software which is not shown in the sheet.
3. Margin=limit value – emission level.

Frequency Range:

1GHz – 12.75GHz

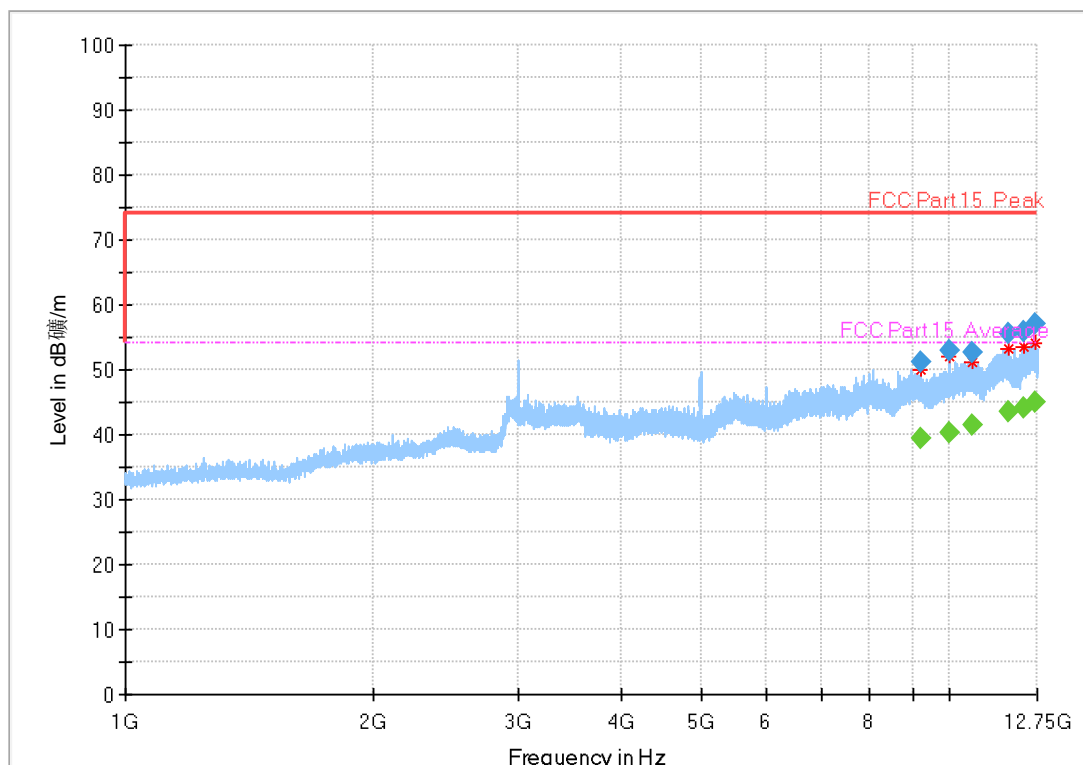

Final Result

Frequency (MHz)	MaxPea k	Average (dBuV/)	Limit (dBuV/)	Margi n	Meas .	Bandwidt h	Heigh t	Pol	Azimuth (deg)	Corr. (dB)
9202.533467	51.23	---	74.00	22.77	50.0	1000.000	100.0	V	288.0	10.4
9202.533467	---	39.35	54.00	14.65	50.0	1000.000	100.0	V	288.0	10.4
9992.641200	---	40.32	54.00	13.68	50.0	1000.000	100.0	V	13.0	11.3
9992.641200	53.08	---	74.00	20.92	50.0	1000.000	100.0	V	13.0	11.3
10627.74173	---	41.46	54.00	12.54	50.0	1000.000	200.0	V	23.0	13.0
10627.74173	52.68	---	74.00	21.32	50.0	1000.000	200.0	V	23.0	13.0
11760.34813	---	43.58	54.00	10.42	50.0	1000.000	300.0	V	359.0	15.1
11760.34813	55.65	---	74.00	18.35	50.0	1000.000	300.0	V	359.0	15.1
12260.68340	---	44.23	54.00	9.77	50.0	1000.000	300.0	V	78.0	15.8
12260.68340	55.98	---	74.00	18.02	50.0	1000.000	300.0	V	78.0	15.8
12655.77386	57.11	---	74.00	16.89	50.0	1000.000	100.0	V	352.0	16.8
12655.77386	---	45.05	54.00	8.95	50.0	1000.000	100.0	V	352.0	16.8

Note:

1. Emission level(peak or average)=Raw value by receiver + Corr(Antenna factor+ cable loss - preamplifier gain)
2. The raw value is used to calculate by software which is not shown in the sheet.
3. Margin=limit value – emission level.

8.2 Conducted Emission

Method of Measurement

For equipment that is designed to be connected to the public utility (AC) power line, the radio frequency voltage that is conducted back onto the AC power line on any frequency or frequencies with the band 150 kHz to 30MHz shall not exceed the limits. Both lines of the power mains connected to the EUT were checked for maximum conducted interference. Tested in accordance with the procedures of ANSI C63.4-2014, section 7.3

Limit of Conducted Emission

Frequency Range (MHz)	Conducted Limit (dBuV)	
	Quasi-peak	Average
0.15-0.5	66 to 56*	56 to 46*
0.5-5	56	46
5-30	60	50

*Decreases with the logarithm of the frequency

Test Condition in Charging Mode

Voltage (V)	Frequency (Hz)	RBW	Sweep Time (s)
120	60	9 KHz	Auto

Uncertainty Measurement

The measurement uncertainty is 3.47dB (k=2).

Test Results

N06 Mode 1: USB cable (Data Link with PC)

Frequency Range:

150kHz – 30MHz

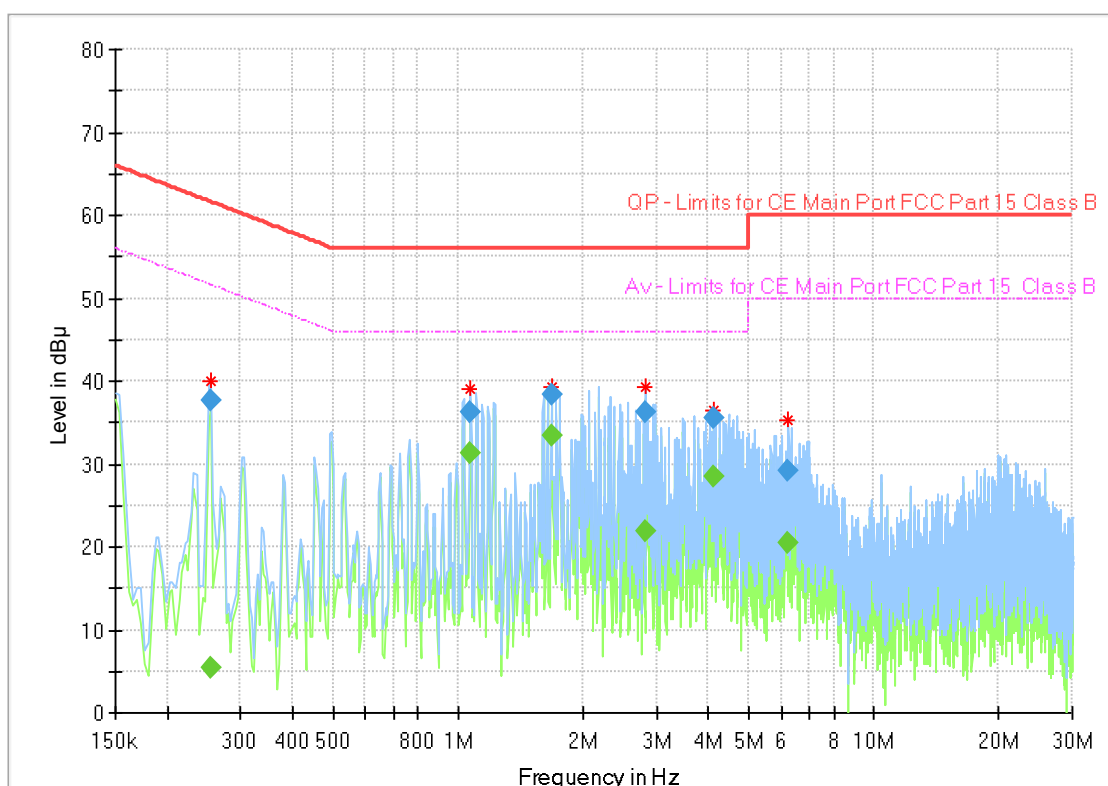

Frequency (MHz)	QuasiPeak (dBµ V)	Average (dBµ V)	Limit (dBµ V)	Margin (dB)	Meas. Time	Bandwidth (kHz)	Line	Filter	Corr. (dB)
0.254475	37.53	---	61.61	24.08	1000.0	9.000	N	ON	9.7
0.254475	---	5.52	51.61	46.09	1000.0	9.000	N	ON	9.7
1.067888	36.12	---	56.00	19.88	1000.0	9.000	L1	ON	9.7
1.067888	---	31.33	46.00	14.67	1000.0	9.000	L1	ON	9.7
1.679812	---	33.45	46.00	12.55	1000.0	9.000	L1	ON	9.7
1.679812	38.47	---	56.00	17.53	1000.0	9.000	L1	ON	9.7
2.832769	---	21.99	46.00	24.01	1000.0	9.000	N	ON	9.7
2.832769	36.17	---	56.00	19.83	1000.0	9.000	N	ON	9.7
4.127512	---	28.48	46.00	17.52	1000.0	9.000	L1	ON	9.7
4.127512	35.52	---	56.00	20.48	1000.0	9.000	L1	ON	9.7
6.239400	---	20.50	50.00	29.50	1000.0	9.000	L1	ON	9.8
6.239400	29.27	---	60.00	30.73	1000.0	9.000	L1	ON	9.8

Note:

1. Emission level(quasi-peak or Average peak)=Raw value by receiver + Corr(Insertion loss+cable loss)
2. The raw value is used to calculate by software which is not shown in the sheet.
3. Margin=limit value – emission level.
4. L1 and N line is all have been tested, the result of them is synthesized in the above data diagram.

N20 Mode 1: USB cable (Data Link with PC)

Frequency Range:

150kHz – 30MHz

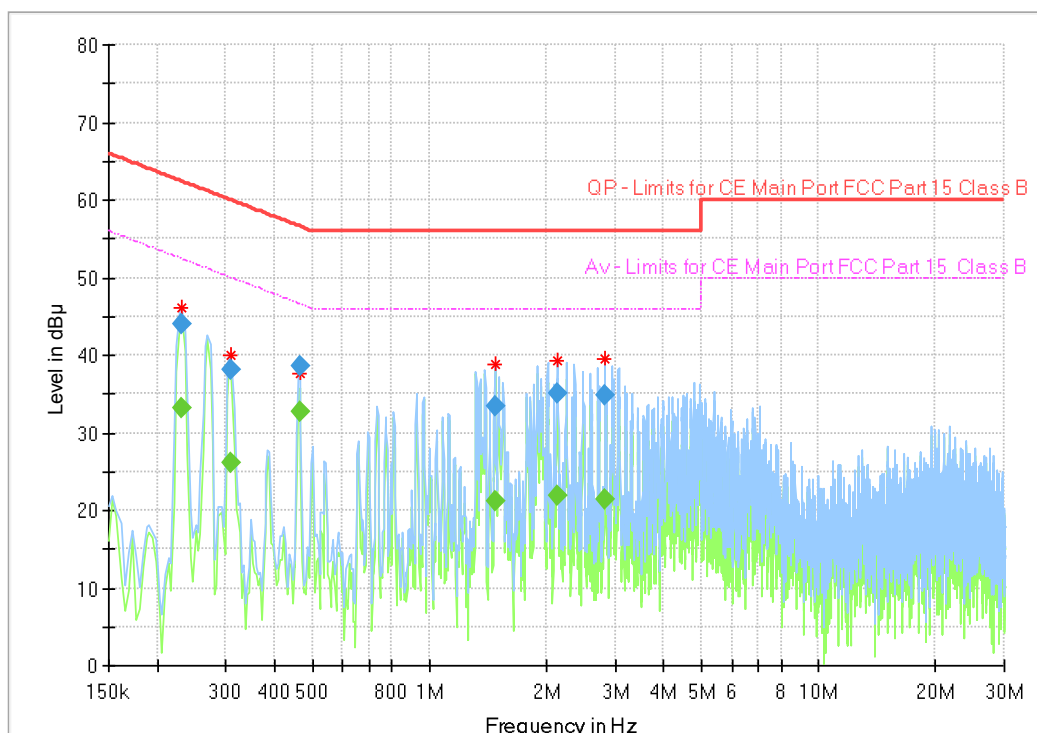

Frequency (MHz)	QuasiPeak (dBu V)	Average (dBu V)	Limit (dBu V)	Margin (dB)	Meas. Time	Bandwidth (kHz)	Line	Filter	Corr. (dB)
0.232088	44.00	---	62.37	18.37	1000.0	9.000	N	ON	9.7
0.232088	---	33.13	52.37	19.24	1000.0	9.000	N	ON	9.7
0.310444	38.01	---	59.96	21.95	1000.0	9.000	N	ON	9.7
0.310444	---	26.19	49.96	23.77	1000.0	9.000	N	ON	9.7
0.463425	38.49	---	56.63	18.14	1000.0	9.000	L1	ON	9.6
0.463425	---	32.82	46.63	13.81	1000.0	9.000	L1	ON	9.6
1.474594	33.41	---	56.00	22.59	1000.0	9.000	N	ON	9.7
1.474594	---	21.07	46.00	24.93	1000.0	9.000	N	ON	9.7
2.131294	---	21.81	46.00	24.19	1000.0	9.000	N	ON	9.7
2.131294	35.03	---	56.00	20.97	1000.0	9.000	N	ON	9.7
2.829038	---	21.32	46.00	24.68	1000.0	9.000	L1	ON	9.7
2.829038	34.82	---	56.00	21.18	1000.0	9.000	L1	ON	9.7

Note:

1. Emission level(quasi-peak or Average peak)=Raw value by receiver + Corr(Insertion loss+ cable loss)
2. The raw value is used to calculate by software which is not shown in the sheet.
3. Margin=limit value – emission level.
4. L1 and N line is all have been tested, the result of them is synthesized in the above data diagram.

*****End the Report*****