

FCC TEST REPORT (PART 27)



Applicant:	Lenovo (Shanghai) Electronics Technology Co., Ltd.
Address:	Section 304-305, Building No. 4, # 222, Meiyue Road, China (Shanghai) Pilot Free Trade Zone

Manufacturer or Supplier:	Lenovo PC HK Limited
Address:	23/F, Lincoln House, Taikoo Place 979 King's Road, Quarry Bay, Hong Kong, P.R.China
Product:	Portable Tablet Computer
Brand Name:	Lenovo
Model Name:	Lenovo TB-X606X
FCC ID:	O57TBX6C6X
Date of tests:	Feb. 19, 2021 ~ Mar. 30, 2021

The tests have been carried out according to the requirements of the following standard:

- FCC Part 27, Subpart C, M** **ANSI/TIA/EIA-603-D**
 FCC Part 2 **ANSI/TIA/EIA-603-E** **ANSI C63.26-2015**

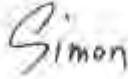
CONCLUSION: The submitted sample was found to COMPLY with the test requirement

Prepared by Simon Wang Engineer / Mobile Department	Approved by Luke Lu Manager / Mobile Department
	
Date: Apr. 08, 2021	Date: Apr. 08, 2021

This report is governed by, and incorporates by reference, CPS Conditions of Service as posted at the date of issuance of this report at <http://www.bureauveritas.com/home/about-us/our-business/cps/about-us/terms-conditions> and is intended for your exclusive use. Any copying or replication of this report to or for any other person or entity, or use of our name or trademark, is permitted only with our prior written permission. This report sets forth our findings solely with respect to the test samples identified herein. The results set forth in this report are not indicative or representative of the quality or characteristics of the lot from which a test sample was taken or any similar or identical product unless specifically and expressly noted. Our report includes all of the tests requested by you and the results thereof based upon the information that you provided to us. Measurement uncertainty is only provided upon request for accredited tests. You have 60 days from date of issuance of this report to notify us of any material error or omission caused by our negligence or if you require measurement uncertainty; provided, however, that such notice shall be in writing and shall specifically address the issue you wish to raise. A failure to raise such issue within the prescribed time shall constitute your unqualified acceptance of the completeness of this report, the tests conducted and the correctness of the report contents.



TABLE OF CONTENTS

RELEASE CONTROL RECORD	3
1 SUMMARY OF TEST RESULTS	4
1.1 MEASUREMENT UNCERTAINTY	4
1.2 TEST SITE AND INSTRUMENTS	5
2 GENERAL INFORMATION	7
2.1 GENERAL DESCRIPTION OF EUT	7
2.2 CONFIGURATION OF SYSTEM UNDER TEST	11
2.3 DESCRIPTION OF SUPPORT UNITS	12
2.4 TEST ITEM AND TEST CONFIGURATION	12
2.5 GENERAL DESCRIPTION OF APPLIED STANDARDS	17
3 TEST TYPES AND RESULTS	18
3.1 OUTPUT POWER MEASUREMENT	18
3.1.1 LIMITS OF OUTPUT POWER MEASUREMENT	18
3.1.2 TEST PROCEDURES	18
3.1.3 TEST SETUP	19
3.1.4 TEST RESULTS	20
3.2 FREQUENCY STABILITY MEASUREMENT	45
3.2.1 LIMITS OF FREQUENCY STABILITY MEASUREMENT	45
3.2.2 TEST PROCEDURE	45
3.2.3 TEST SETUP	45
3.2.4 TEST RESULTS	46
3.3 OCCUPIED BANDWIDTH MEASUREMENT	59
3.3.1 LIMITS OF OCCUPIED BANDWIDTH MEASUREMENT	59
3.3.2 TEST SETUP	59
3.3.3 TEST PROCEDURES	59
3.3.4 TEST RESULTS	60
3.4 BAND EDGE MEASUREMENT	73
3.4.1 LIMITS OF BAND EDGE MEASUREMENT	73
3.4.2 TEST SETUP	73
3.4.3 TEST PROCEDURES	74
3.4.4 TEST RESULTS	75
3.5 CONDUCTED SPURIOUS EMISSIONS	100
3.5.1 LIMITS OF CONDUCTED SPURIOUS EMISSIONS MEASUREMENT	100
3.5.2 TEST PROCEDURE	100
3.5.3 TEST SETUP	100
3.5.4 TEST RESULTS	101
3.6 RADIATED EMISSION MEASUREMENT	114
3.6.1 LIMITS OF RADIATED EMISSION MEASUREMENT	114
3.6.2 TEST PROCEDURES	114
3.6.3 DEVIATION FROM TEST STANDARD	114
3.6.4 TEST SETUP	115
3.6.5 TEST RESULTS	116
4 INFORMATION ON THE TESTING LABORATORIES	160
5 APPENDIX A – MODIFICATIONS RECORDERS FOR ENGINEERING CHANGES TO THE EUT BY THE LAB	161



Test Report No.: RFA210218W001-5

RELEASE CONTROL RECORD

ISSUE NO.	REASON FOR CHANGE	DATE ISSUED
RFA210218W001-7	Original release	Apr. 08, 2021

1 SUMMARY OF TEST RESULTS

The EUT has been tested according to the following specifications:

APPLIED STANDARD: FCC Part 27 & Part 2		
STANDARD SECTION	1.1.1.1.1 TEST TYPE AND LIMIT	RESULT
2.1046 27.50(h)(2)	Equivalent Isotropically Radiated Power	Compliance
2.1055 27.54	Frequency Stability	Compliance
2.1049 27.53(m)(6)	Occupied Bandwidth	Compliance
2.1051 27.53(m)(4)(6)	Band Edge Measurements	Compliance
2.1051 27.53(m)(4)(6)	Conducted Spurious Emissions	Compliance
2.1053 27.53(m)(4)(6)	Radiated Spurious Emissions	Compliance

1.1 MEASUREMENT UNCERTAINTY

Where relevant, the following measurement uncertainty levels have been estimated for tests performed on the EUT as specified in CISPR 16-4-2:

MEASUREMENT	UNCERTAINTY
Frequency Stability	$\pm 76.97\text{Hz}$
Radiated emissions & Radiated Power (30MHz~1GMHz)	$\pm 4.98\text{dB}$
Radiated emissions & Radiated Power (1GMHz ~6GMHz)	$\pm 4.70\text{dB}$
Radiated emissions (6GMHz ~18GMHz)	$\pm 4.60\text{dB}$
Radiated emissions (18GMHz ~40GMHz)	$\pm 4.12\text{dB}$
Conducted emissions	$\pm 4.01\text{dB}$
Occupied Channel Bandwidth	$\pm 43.58\text{KHz}$
Conducted Output power	$\pm 2.06\text{dB}$
Band Edge Measurements	$\pm 4.70\text{dB}$

This uncertainty represents an expanded uncertainty expressed at approximately the 95% confidence level using a coverage factor of $k=2$.



BUREAU
VERITAS

Test Report No.: RFA210218W001-5

1.2 TEST SITE AND INSTRUMENTS

Equipment	Manufacturer	Model No.	Serial No.	Last Cal.	Next Cal.
MXE EMI Receiver	KEYSIGHT	N9038A-544	MY54450026	Apr. 27,20	Apr. 26,21
EXA Signal Analyzer	KEYSIGHT	N9010A-526	MY54510322	Feb. 25,21	Feb. 24,22
EXA Signal Analyzer	KEYSIGHT	N9010A-526	MY54510322	Feb. 26,20	Feb. 25,21
Signal Analyzer	Rohde&Schwarz	FSV7	101561	Mar. 26,21	Mar. 25,22
Signal Analyzer	Rohde&Schwarz	FSV7	101561	Mar. 27,20	Mar. 26,21
Bilog Antenna	ETS-LINDGREN	3143B	00161965	Mar. 26,21	Mar. 25,22
Bilog Antenna	ETS-LINDGREN	3143B	00161965	Mar. 27,20	Mar. 26,21
Horn Antenna (1GHz-18GHz)	ETS-LINDGREN	3117	00168692	Nov. 24, 20	Nov. 23, 21
Horn Antenna (18GHz-40GHz)	N/A	QWH-SL-18-40 -K-SG/QMS-00 361	15433	Feb. 26,21	Feb. 25,22
Horn Antenna (18GHz-40GHz)	N/A	QWH-SL-18-40 -K-SG/QMS-00 361	15433	Feb. 27,20	Feb. 26,21
Radio Communication Analyzer	ANRITSU	MT8820C	6201465426	Jun. 02,20	Jun. 01,21
Signal Pre-Amplifier	EMSI	EMC 9135	980249	Jun. 02,20	Jun. 01,21
Signal Pre-Amplifier	EMSI	EMC 012645B	980257	Jun. 02,20	Jun. 01,21
Signal Pre-Amplifier	EMSI	EMC 184045B	980259	Apr. 30,20	Apr. 29,21
3m Semi-anechoic Chamber	ETS-LINDGREN	9m*6m*6m	Euroshieldpn- CT0001143-1216	May. 19,20	May. 19,21
Test Software	E3	V 9.160323	N/A	N/A	N/A
Test Software	ADT	ADT_Radiated V7.6.15.9.2	N/A	Jun. 03,20	Jun. 02,21
10dB Attenuator	JFW/USA	50HF-010-SM A	1505	Feb. 25,21	Feb. 24,22
10dB Attenuator	JFW/USA	50HF-010-SM A	1505	Feb. 26,20	Feb. 25,21
Power Meter	Anritsu	ML2495A	1506002	Feb. 25,21	Feb. 24,22
Power Meter	Anritsu	ML2495A	1506002	Feb. 26,20	Feb. 25,21
Power Sensor	Anritsu	MA2411B	1339352	Jun. 02,20	Jun. 01,21
Humid & Temp Programmable Tester	Juyi	ITH-120-45-CP -AR	IAA1504-001	Mar. 10,21	Mar. 09,22
Humid & Temp Programmable Tester	Juyi	ITH-120-45-CP -AR	IAA1504-001	Mar. 11,20	Mar. 10,21
MXG Analog Microvave Signal Generator	KEYSIGHT	N5183A	MY50143024	Apr. 27,20	Apr. 26,21
Power Divider	MCLI/USA	PS2-15	24880	N/A	N/A

- NOTE:**
1. The calibration interval of the above test instruments is 12 months or 24 months and the calibrations are traceable to CEPREI/CHINA, GRGT/CHINA and NIM/CHINA.
 2. The test was performed in 3m Semi-anechoic Chamber and RF Oven Room.
 3. The horn antenna is used only for the measurement of emission frequency above 1GHz if tested.
 4. The FCC Site Registration No. is 525120; The Designation No. is CN1171.



Test Report No.: RFA210218W001-5

2 GENERAL INFORMATION

2.1 GENERAL DESCRIPTION OF EUT

PRODUCT	Portable Tablet Computer	
BRAND NAME	Lenovo	
MODEL NAME	Lenovo TB-X606X	
NOMINAL VOLTAGE	5.0Vdc (adapter or host equipment) 3.86Vdc (Li-ion, battery)	
MODULATION TECHNOLOGY	WCDMA IV	HSDPA, HSUPA, DC-HSDPA
	LTE	QPSK, 16QAM
FREQUENCY RANGE	WCDMA IV	1712.4MHz ~ 1752.6MHz
	LTE Band 7 Channel Bandwidth: 5MHz	2502.5MHz ~ 2567.5MHz
	LTE Band 7 Channel Bandwidth: 10MHz	2505MHz ~ 2565MHz
	LTE Band 7 Channel Bandwidth: 15MHz	2507.5MHz ~ 2562.5MHz
	LTE Band 7 Channel Bandwidth: 20MHz	2510MHz ~ 2560MHz
	LTE Band 38 Channel Bandwidth: 5MHz	2572.5MHz ~ 2617.5MHz
	LTE Band 38 Channel Bandwidth: 10MHz	2575MHz ~ 2615MHz
	LTE Band 38 Channel Bandwidth: 15MHz	2577.5MHz ~ 2612.5MHz
	LTE Band 38 Channel Bandwidth: 20MHz	2580MHz ~ 2610MHz
	LTE Band 41 Channel Bandwidth: 5MHz	2498.5MHz ~ 2687.5MHz
	LTE Band 41 Channel Bandwidth: 10MHz	2501MHz ~ 2685MHz
	LTE Band 41 Channel Bandwidth: 15MHz	2503.5MHz ~ 2682.5MHz
	LTE Band 41 Channel Bandwidth: 20MHz	2506MHz ~ 2680MHz



Test Report No.: RFA210218W001-5

EMISSION DESIGNATOR	WCDMA IV	4M18F9W
	LTE Band 7	QPSK: 4M49G7D
	Channel Bandwidth: 5MHz	16QAM: 4M48W7D
	LTE Band 7	QPSK: 8M95G7D
	Channel Bandwidth: 10MHz	16QAM: 8M95W7D
	LTE Band 7	QPSK: 13M4G7D
	Channel Bandwidth: 15MHz	16QAM: 13M4W7D
	LTE Band 7	QPSK: 17M9G7D
	Channel Bandwidth: 20MHz	16QAM: 17M9W7D
	LTE Band 38	QPSK: 4M48G7D
	Channel Bandwidth: 5MHz	16QAM: 4M47W7D
	LTE Band 38	QPSK: 8M96G7D
	Channel Bandwidth: 10MHz	16QAM: 8M95W7D
	LTE Band 38	QPSK: 13M4G7D
	Channel Bandwidth: 15MHz	16QAM: 13M4W7D
LTE Band 38	QPSK: 17M9G7D	
Channel Bandwidth: 20MHz	16QAM: 17M9W7D	
LTE Band 41	QPSK: 4M46G7D	
Channel Bandwidth: 5MHz	16QAM: 4M47W7D	
LTE Band 41	QPSK: 8M92G7D	
Channel Bandwidth: 10MHz	16QAM: 8M93W7D	
LTE Band 41	QPSK: 13M4G7D	
Channel Bandwidth: 15MHz	16QAM: 13M4W7D	
LTE Band 41	QPSK: 17M8G7D	
Channel Bandwidth: 20MHz	16QAM: 17M8W7D	

MAX. EIRP POWER	WCDMA IV	266.69mW
	LTE Band 7 Channel Bandwidth: 5MHz	114.82mW
	LTE Band 7 Channel Bandwidth: 10MHz	115.08mW
	LTE Band 7 Channel Bandwidth: 15MHz	113.76mW
	LTE Band 7 Channel Bandwidth: 20MHz	115.35mW
	LTE Band 38 Channel Bandwidth: 5MHz	276.06mW
	LTE Band 38 Channel Bandwidth: 10MHz	276.06mW
	LTE Band 38 Channel Bandwidth: 15MHz	274.79mW
	LTE Band 38 Channel Bandwidth: 20MHz	277.33mW
	LTE Band 41 Channel Bandwidth: 5MHz	117.22mW
	LTE Band 41 Channel Bandwidth: 10MHz	117.49mW
	LTE Band 41 Channel Bandwidth: 15MHz	116.14mW
	LTE Band 41 Channel Bandwidth: 20MHz	117.76mW
	ANTENNA TYPE	PIFA Antenna with -2dBi gain for LTE7/38/41; PIFA Antenna with 1.6dBi gain for WCDMA IV
HW VERSION	Lenovo TB-X6C6X	
SW VERSION	TB-X6C6X_RF01_210430	
I/O PORTS	Refer to user's manual	
CABLE SUPPLIED	USB cable: shielded, detachable, 1meter	
EXTREME TEMPERATURE	-10-55 °C	
EXTREME VOLTAGE	3.6-4.4 V	

NOTE:

1. For a more detailed features description, please refer to the manufacturer's specifications or the user's manual.
2. For the test results, the EUT had been tested with all conditions. But only the worst case was shown in test report.



**BUREAU
VERITAS**

Test Report No.: RFA210218W001-5

List of Accessory:

ACCESSORIES	BRAND	MODEL	SPECIFICATION
Battery 1	Sunwoda	L20D1P32	Capacity : 3.86vdc 7500mAh
Battery 2	SCUD	L20D1P32	Capacity : 3.86vdc 7500mAh
AC Adapter 1	Salom	SC-41	I/P:100-240Vac, 0.3A O/P: 5Vdc, 2A
AC Adapter 2	AcBel	SC-41	I/P:100-240Vac, 0.3A O/P: 5Vdc, 2A
USB Cable 1	BRL	GSZ-209H-A3120	Shielded, 1.0meter
USB Cable 2	Leagtech	CDG-203T-A05WF	Shielded, 1.0meter

2.2 CONFIGURATION OF SYSTEM UNDER TEST

FOR RADIATION EMISSION TEST

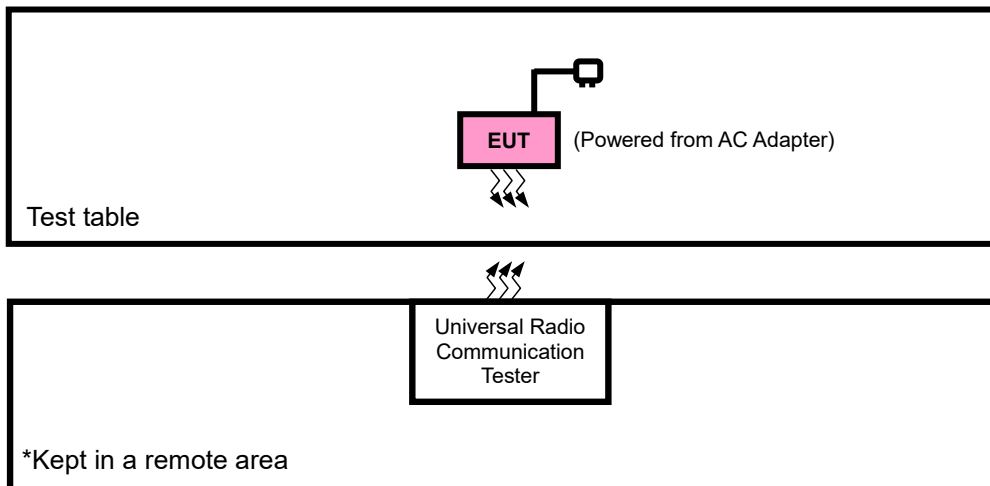

2.3 DESCRIPTION OF SUPPORT UNITS

The EUT has been tested as an independent unit together with other necessary accessories or support units. The following support units or accessories were used to form a representative test configuration during the tests.

NO.	PRODUCT	BRAND	MODEL NO.	SERIAL NO.	FCC ID
1	DC source	LONG WEI	PS-6403D	010934269	N/A

NO.	SIGNAL CABLE DESCRIPTION OF THE ABOVE SUPPORT UNITS
1	DC Line: Unshielded, Detachable 1.8m

2.4 TEST ITEM AND TEST CONFIGURATION

Pre-Scan has been conducted to determine the worst-case mode from all possible combinations between available modulations, data rates, XYZ axis and antenna ports. The worst case was found when positioned on Y-plane for EIRP and X-axis for radiated emission. Following channel(s) was (were) selected for the final test as listed below:

EUT CONFIGURE MODE	1.1.1.1.2DESCRIPTION
A	EUT + Adapter + USB Cable with LTE link
B	EUT + Battery with LTE link

WCDMA MODE

EUT CONFIGURE MODE	TEST ITEM	AVAILABLE CHANNEL	TESTED CHANNEL	MODE
B	EIRP	1312 to 1513	1312, 1413, 1513	WCDMA
B	FREQUENCY STABILITY	1312 to 1513	1312, 1513	WCDMA
B	OCCUPIED BANDWIDTH	1312 to 1513	1312, 1413, 1513	WCDMA
B	BAND EDGE	1312 to 1513	1312, 1513	WCDMA
B	PEAK TO AVERAGE RATIO	1312 to 1513	1312, 1413, 1513	WCDMA
B	CONDCUDED EMISSION	1312 to 1513	1312, 1413, 1513	WCDMA
A	RADIATED EMISSION	1312 to 1513	1312, 1413, 1513	WCDMA

LTE BAND 7 MODE

EUT CONFIGURE MODE	TEST ITEM	AVAILABLE CHANNEL	TESTED CHANNEL	CHANNEL BANDWIDT H	MODULATION	MODE		
B	EIRP	20775 to 21425	20775, 21100, 21425	5MHz	QPSK, 16QAM	1 RB / 0 RB Offset		
		20800 to 21400	20800, 21100, 21400	10MHz	QPSK, 16QAM	1 RB / 0RB Offset		
		20825 to 21375	20825, 21100, 21375	15MHz	QPSK, 16QAM	1 RB / 0 RB Offset		
		20850 to 21350	20850, 21100, 21350	20MHz	QPSK, 16QAM	1 RB / 0 RB Offset		
B	FREQUENCY STABILITY	20775 to 21425	20775, 21425	5MHz	QPSK	1 RB / 0 RB Offset		
		20800 to 21400	20800, 21400	10MHz	QPSK	1 RB / 0RB Offset		
		20825 to 21375	20825, 21375	15MHz	QPSK	1 RB / 0 RB Offset		
		20850 to 21350	20850, 21350	20MHz	QPSK	1 RB / 0 RB Offset		
B	OCCUPIED BANDWIDTH	20775 to 21425	20775, 21100, 21425	5MHz	QPSK, 16QAM	25 RB / 0 RB Offset		
		20800 to 21400	20800, 21100, 21400	10MHz	QPSK, 16QAM	50 RB / 0 RB Offset		
		20825 to 21375	20825, 21100, 21375	15MHz	QPSK, 16QAM	75 RB / 0 RB Offset		
		20850 to 21350	20850, 21100, 21350	20MHz	QPSK, 16QAM	100 RB / 0 RB Offset		
B	BAND EDGE	20775 to 21425	20775	5MHz	QPSK, 16QAM	1 RB / 0 RB Offset 25 RB / 0 RB Offset		
			21425	5MHz	QPSK, 16QAM	1 RB / 24 RB Offset 25 RB / 0 RB Offset		
		20800 to 21400	20800	10MHz	QPSK, 16QAM	1 RB / 0 RB Offset 50 RB / 0 RB Offset		
			21400	10MHz	QPSK, 16QAM	1 RB / 49 RB Offset 50 RB / 0 RB Offset		
		20825 to 21375	20825	15MHz	QPSK, 16QAM	1 RB / 0 RB Offset 75 RB / 0 RB Offset		
			21375	15MHz	QPSK, 16QAM	1 RB / 74 RB Offset 75 RB / 0 RB Offset		
		20850 to 21350	20850	20MHz	QPSK, 16QAM	1 RB / 0 RB Offset 100 RB / 0 RB Offset		
			21350	20MHz	QPSK, 16QAM	1 RB / 99 RB Offset 100 RB / 0 RB Offset		
		B	CONDCUDED EMISSION	20775 to 21425	20775, 21100, 21425	5MHz	QPSK	1 RB / 0 RB Offset
				20800 to 21400	20800, 21100, 21400	10MHz	QPSK	1 RB / 0RB Offset
				20825 to 21375	20825, 21100, 21375	15MHz	QPSK	1 RB / 0 RB Offset
				20850 to 21350	20850, 21100, 21350	20MHz	QPSK	1 RB / 0 RB Offset
A	RADIATED EMISSION	20775 to 21425	20775, 21100, 21425	5MHz	QPSK	1 RB / 0 RB Offset		
		20800 to 21400	21100	10MHz	QPSK	1 RB / 0 RB Offset		
		20825 to 21375	21100	15MHz	QPSK	1 RB / 0 RB Offset		
		20850 to 21350	21100	20MHz	QPSK	1 RB / 0 RB Offset		

Note: This device was tested under all bandwidths, RB configurations and modulations. The worst case was found in QPSK modulation.

LTE BAND 38 MODE

EUT CONFIGURE MODE	TEST ITEM	AVAILABLE CHANNEL	TESTED CHANNEL	CHANNEL BANDWIDTH	MODULATION	MODE		
B	EIRP	37775 to 38225	37775, 38000, 38225	5MHz	QPSK, 16QAM	1 RB / 0 RB Offset		
		37800 to 38200	37800, 38000, 38200	10MHz	QPSK, 16QAM	1 RB / 0RB Offset		
		37825 to 38175	37825, 38000, 38175	15MHz	QPSK, 16QAM	1 RB / 0 RB Offset		
		37850 to38150	37850, 38000, 38150	20MHz	QPSK, 16QAM	1 RB / 0 RB Offset		
B	FREQUENCY STABILITY	37775 to 38225	37775, 38225	5MHz	QPSK	1 RB / 0 RB Offset		
		37800 to 38200	37800, 38200	10MHz	QPSK	1 RB / 0RB Offset		
		37825 to 38175	37825, 38175	15MHz	QPSK	1 RB / 0 RB Offset		
		37850 to38150	37850, 38150	20MHz	QPSK	1 RB / 0 RB Offset		
B	OCCUPIED BANDWIDTH	37775 to 38225	37775, 38000, 38225	5MHz	QPSK, 16QAM	25 RB / 0 RB Offset		
		37800 to 38200	37800, 38000, 38200	10MHz	QPSK, 16QAM	50 RB / 0 RB Offset		
		37825 to 38175	37825, 38000, 38175	15MHz	QPSK, 16QAM	75 RB / 0 RB Offset		
		37850 to38150	37850, 38000, 38150	20MHz	QPSK, 16QAM	100 RB / 0 RB Offset		
B	BAND EDGE	37775 to 38225	37775	5MHz	QPSK, 16QAM	1 RB / 0 RB Offset		
			38825	5MHz	QPSK, 16QAM	25 RB / 0 RB Offset		
		37800 to 38200	37800	10MHz	QPSK, 16QAM	1 RB / 24 RB Offset		
			38200	10MHz	QPSK, 16QAM	25 RB / 0 RB Offset		
		37825 to 38175	37825	15MHz	QPSK, 16QAM	1 RB / 0 RB Offset		
			38175	15MHz	QPSK, 16QAM	1 RB / 49 RB Offset		
		37850 to38150	37850	20MHz	QPSK, 16QAM	50 RB / 0 RB Offset		
			38150	20MHz	QPSK, 16QAM	1 RB / 74 RB Offset		
		B	CONDCUDED EMISSION	37775 to 38225	37775, 38000, 38225	5MHz	QPSK	75 RB / 0 RB Offset
				37800 to 38200	37800, 38000, 38200	10MHz	QPSK	1 RB / 0 RB Offset
				37825 to 38175	37825, 38000, 38175	15MHz	QPSK	1 RB / 0RB Offset
				37850 to38150	37850, 38000, 38150	20MHz	QPSK	1 RB / 0 RB Offset
A	RADIATED EMISSION	37775 to 38225	38000	5MHz	QPSK	1 RB / 0 RB Offset		
		37800 to 38200	37800, 38000, 38200	10MHz	QPSK	1 RB / 0RB Offset		
		37825 to 38175	38000	15MHz	QPSK	1 RB / 0 RB Offset		
		37850 to38150	38000	20MHz	QPSK	1 RB / 0 RB Offset		

Note: This device was tested under all bandwidths, RB configurations and modulations. The worst case was found in QPSK modulation.

LTE BAND 41 MODE

TEST ITEM	AVAILABLE CHANNEL	TESTED CHANNEL	CHANNEL BANDWIDTH	MODULATION	MODE	
EIRP	39675 to 41565	39675, 40620, 41565	5MHz	QPSK, 16QAM	1 RB / 0 RB Offset	
	39700 to 41540	39700, 40620, 41540	10MHz	QPSK, 16QAM	1 RB / 0RB Offset	
	39725 to 41515	39725, 40620, 41515	15MHz	QPSK, 16QAM	1 RB / 0 RB Offset	
	39750 to 41490	39750, 40620, 41490	20MHz	QPSK, 16QAM	1 RB / 0 RB Offset	
FREQUENCY STABILITY	39675 to 41565	39675, 41565	5MHz	QPSK	1 RB / 0 RB Offset	
	39700 to 41540	39700, 41540	10MHz	QPSK	1 RB / 0RB Offset	
	39725 to 41515	39725, 41515	15MHz	QPSK	1 RB / 0 RB Offset	
	39750 to 41490	39750, 41490	20MHz	QPSK	1 RB / 0 RB Offset	
OCCUPIED BANDWIDTH	39675 to 41565	39675, 40620, 41565	5MHz	QPSK, 16QAM	25 RB / 0 RB Offset	
	39700 to 41540	39700, 40620, 41540	10MHz	QPSK, 16QAM	50 RB / 0 RB Offset	
	39725 to 41515	39725, 40620, 41515	15MHz	QPSK, 16QAM	75 RB / 0 RB Offset	
	39750 to 41490	39750, 40620, 41490	20MHz	QPSK, 16QAM	100 RB / 0 RB Offset	
BAND EDGE	39675 to 41565	39675	5MHz	QPSK, 16QAM	1 RB / 0 RB Offset 25 RB / 0 RB Offset	
		41565	5MHz	QPSK, 16QAM	1 RB / 24 RB Offset 25 RB / 0 RB Offset	
	39700 to 41540	39700	10MHz	QPSK, 16QAM	1 RB / 0 RB Offset 50 RB / 0 RB Offset	
		41540	10MHz	QPSK, 16QAM	1 RB / 49 RB Offset 50 RB / 0 RB Offset	
	39725 to 41515	39725	15MHz	QPSK, 16QAM	1 RB / 0 RB Offset 75 RB / 0 RB Offset	
		41515	15MHz	QPSK, 16QAM	1 RB / 74 RB Offset 75 RB / 0 RB Offset	
	39750 to 41490	39750	20MHz	QPSK, 16QAM	1 RB / 0 RB Offset 100 RB / 0 RB Offset	
		41490	20MHz	QPSK, 16QAM	1 RB / 99 RB Offset 100 RB / 0 RB Offset	
	CONDUCEDEMISSION	39675 to 41565	39675, 40620, 41565	5MHz	QPSK	1 RB / 0 RB Offset
		39700 to 41540	39700, 40620, 41540	10MHz	QPSK	1 RB / 0RB Offset
		39725 to 41515	39725, 40620, 41515	15MHz	QPSK	1 RB / 0 RB Offset
		39750 to 41490	39750, 40620, 41490	20MHz	QPSK	1 RB / 0 RB Offset
RADIATED EMISSION	39675 to 41565	40620	5MHz	QPSK	1 RB / 0 RB Offset	
	39700 to 41540	39700, 40620, 41540	10MHz	QPSK	1 RB / 0RB Offset	
	39725 to 41515	40620	15MHz	QPSK	1 RB / 0 RB Offset	
	39750 to 41490	40620	20MHz	QPSK	1 RB / 0 RB Offset	

Note: This device was tested under all bandwidths, RB configurations and modulations. The worst case was found in QPSK modulation.



Test Report No.: RFA210218W001-5

TEST CONDITION:

TEST ITEM	ENVIRONMENTAL CONDITIONS	INPUT POWER	TESTED BY
ERP	23deg. C, 70%RH	DC 5V By Adapter	Jace Hu
FREQUENCY STABILITY	23deg. C, 70%RH	DC 3.6V/3.8V/4.4V	Chase Zhou
OCCUPIED BANDWIDTH	23deg. C, 70%RH	DC 3.86V By Battery	Chase Zhou
BAND EDGE	23deg. C, 70%RH	DC 3.86V By Battery	Chase Zhou
CONDCUDED EMISSION	23deg. C, 70%RH	DC 3.86V By Battery	Chase Zhou
RADIATED EMISSION	23deg. C, 70%RH	DC 5V By Adapter	Jace Hu



Test Report No.: RFA210218W001-5

2.5 GENERAL DESCRIPTION OF APPLIED STANDARDS

The EUT is a RF product. According to the specifications of the manufacturer, it must comply with the requirements of the following standards:

FCC 47 CFR Part 2

FCC 47 CFR Part 27

KDB 971168 D01 Power Meas License Digital Systems v03r01

ANSI/TIA/EIA-603-D

ANSI/TIA/EIA-603-E

ANSI C63.26-2015

NOTE: All test items have been performed and recorded as per the above standards.



3 TEST TYPES AND RESULTS

3.1 OUTPUT POWER MEASUREMENT

3.1.1 LIMITS OF OUTPUT POWER MEASUREMENT

The radiated peak output power shall be according to the specific rule Part 27.50(h)(2) that “User stations are limited to 2 watts” and 27.50(i) specific that “Peak transmit power must be measure over any interval of continuous transmission using instrumentation calibration in terms of rms-equivalent voltage.”

Fixed, mobile, and portable (hand-held) stations operating in the 1710-1755 MHz band and mobile and portable stations operating in the 1695-1710 MHz and 1755-1780 MHz bands are limited to 1 watt EIRP

3.1.2 TEST PROCEDURES

EIRP MEASUREMENT:

Per KDB 971168 D01 Power Meas License Digital Systems v03r01 or subclause 5.2.5.5 of ANSI C63.26-2015, the relevant equation for determining the ERP or EIRP from the conducted RF output power measured using the guidance provided above is:

$$\text{ERP or EIRP} = P_{\text{Meas}} + G_{\text{T}} - L_{\text{C}}$$

Where:

ERP or EIRP = effective radiated power or equivalent isotropically radiated power, respectively
(expressed in the same units as P_{Meas} , typically dBW or dBm);

P_{Meas} = measured transmitter output power or PSD, in dBm or dBW;

G_{T} = gain of the transmitting antenna, in dBd (ERP) or dBi (EIRP);

L_{C} = signal attenuation in the connecting cable between the transmitter and antenna, in dB.

CONDUCTED POWER MEASUREMENT:

- a. The EUT was set up for the maximum power with LTE link data modulation and link up with simulator.
- b. Set the EUT to transmit under low, middle and high channel and record the power level shown on simulator.



Test Report No.: RFA210218W001-5

3.1.3 TEST SETUP

CONDUCTED POWER MEASUREMENT:

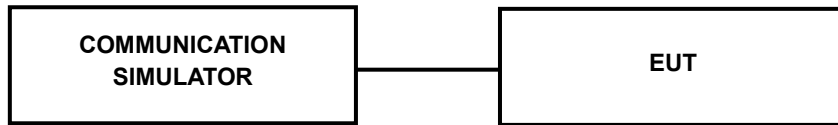

For the actual test configuration, please refer to the attached file (Test Setup Photo).



Test Report No.: RFA210218W001-5

3.1.4 TEST RESULTS

AVERAGE CONDUCTED OUTPUT POWER (dBm)

Band	WCDMA IV		
	1312	1413	1513
Channel	1712.4	1732.6	1752.6
Frequency (MHz)	1712.4	1732.6	1752.6
RMC 12.2K	22.52	22.54	22.66
HSDPA Subtest-1	21.88	21.91	21.96
HSDPA Subtest-2	21.83	21.92	21.98
HSDPA Subtest-3	21.51	21.56	21.63
HSDPA Subtest-4	21.51	21.52	21.56
DC-HSDPA Subtest-1	21.83	21.89	21.98
DC-HSDPA Subtest-2	21.85	21.93	21.96
DC-HSDPA Subtest-3	21.59	21.50	21.52
DC-HSDPA Subtest-4	21.49	21.50	21.45
HSUPA Subtest-1	21.18	21.15	21.10
HSUPA Subtest-2	21.07	21.04	21.09
HSUPA Subtest-3	19.98	20.00	19.96
HSUPA Subtest-4	19.93	19.91	20.04
HSUPA Subtest-5	19.25	19.23	19.22
HSPA+ Subtest-1	21.72	21.41	21.55



**BUREAU
VERITAS**

Test Report No.: RFA210218W001-5

LTE Band 7

Band/BW	Modulation	RB Size	RB Offset	Low CH 20775	Mid CH 21100	High CH 21425	MPR
				Frequency 2502.5 MHz	Frequency 2535 MHz	Frequency 2567.5 MHz	
7/5	QPSK	1	0	21.93	21.99	22.09	0
		1	12	22.44	22.46	22.60	0
		1	24	22.11	22.16	22.31	0
		12	0	21.28	21.35	21.43	1
		12	6	21.36	21.51	21.55	1
		12	13	21.46	21.53	21.65	1
		25	0	21.39	21.51	21.56	1
	16QAM	1	0	21.26	21.36	21.47	1
		1	12	21.67	21.81	21.86	1
		1	24	21.47	21.49	21.63	1
		12	0	20.28	20.38	20.44	2
		12	6	20.45	20.57	20.61	2
		12	13	20.48	20.58	20.69	2
		25	0	20.42	20.49	20.59	2



Test Report No.: RFA210218W001-5

Band/BW	Modulation	RB Size	RB Offset	Low CH 20800	Mid CH 21100	High CH 21400	MPR
				Frequency 2505 MHz	Frequency 2535 MHz	Frequency 2565 MHz	
7/ 10	QPSK	1	0	21.90	22.02	22.09	0
		1	24	22.44	22.46	22.61	0
		1	49	22.08	22.20	22.27	0
		25	0	21.29	21.34	21.46	1
		25	12	21.42	21.45	21.55	1
		25	25	21.44	21.50	21.64	1
		50	0	21.44	21.51	21.53	1
	16QAM	1	0	21.26	21.33	21.43	1
		1	24	21.72	21.77	21.89	1
		1	49	21.47	21.50	21.60	1
		25	0	20.30	20.36	20.50	2
		25	12	20.49	20.51	20.66	2
		25	25	20.47	20.59	20.66	2
		50	0	20.46	20.48	20.63	2



Test Report No.: RFA210218W001-5

Band/BW	Modulation	RB Size	RB Offset	Low CH 20825	Mid CH 21100	High CH 21375	MPR
				Frequency 2507.5 MHz	Frequency 2535 MHz	Frequency 2562.5 MHz	
7/ 15	QPSK	1	0	21.97	22.02	22.06	0
		1	37	22.42	22.51	22.56	0
		1	74	22.14	22.23	22.28	0
		36	0	21.26	21.35	21.47	1
		36	19	21.43	21.50	21.55	1
		36	39	21.42	21.51	21.64	1
		75	0	21.44	21.49	21.58	1
	16QAM	1	0	21.30	21.40	21.43	1
		1	37	21.71	21.78	21.89	1
		1	74	21.43	21.55	21.62	1
		36	0	20.34	20.36	20.51	2
		36	19	20.43	20.55	20.62	2
		36	39	20.52	20.57	20.69	2
		75	0	20.47	20.51	20.56	2



Test Report No.: RFA210218W001-5

Band/BW	Modulation	RB Size	RB Offset	Low CH 20850	Mid CH 21100	High CH 21350	MPR
				Frequency 2510 MHz	Frequency 2535 MHz	Frequency 2560 MHz	
7/20	QPSK	1	0	21.98	22.06	22.14	0
		1	50	22.46	22.54	22.62	0
		1	99	22.16	22.24	22.32	0
		50	0	21.32	21.40	21.48	1
		50	25	21.44	21.52	21.60	1
		50	50	21.50	21.58	21.66	1
		100	0	21.45	21.53	21.61	1
	16QAM	1	0	21.33	21.41	21.49	1
		1	50	21.75	21.83	21.91	1
		1	99	21.49	21.57	21.65	1
		50	0	20.36	20.44	20.52	2
		50	25	20.51	20.59	20.67	2
		50	50	20.55	20.63	20.71	2
		100	0	20.48	20.56	20.64	2



**BUREAU
VERITAS**

Test Report No.: RFA210218W001-5

LTE Band 38

Band/BW	Modulation	RB Size	RB Offset	Low CH 37775	Mid CH 38000	High CH 38225	MPR
				Frequency 2572.5 MHz	Frequency 2595 MHz	Frequency 2617.5MHz	
38/ 5	QPSK	1	0	22.13	22.09	22.08	0
		1	12	22.41	22.33	22.36	0
		1	24	22.10	22.05	22.09	0
		12	0	21.25	21.22	21.19	1
		12	6	21.33	21.38	21.31	1
		12	13	21.35	21.32	21.33	1
		25	0	21.31	21.33	21.27	1
	16QAM	1	0	21.17	21.17	21.17	1
		1	12	21.41	21.45	21.39	1
		1	24	21.19	21.11	21.14	1
		12	0	20.33	20.33	20.28	2
		12	6	20.47	20.49	20.42	2
		12	13	20.40	20.40	20.40	2
		25	0	20.42	20.39	20.38	2



Test Report No.: RFA210218W001-5

Band/BW	Modulation	RB Size	RB Offset	Low CH 37800	Mid CH 38000	High CH 38200	MPR
				Frequency 2575 MHz	Frequency 2595 MHz	Frequency 2615 MHz	
38/ 10	QPSK	1	0	22.10	22.12	22.08	0
		1	24	22.41	22.33	22.37	0
		1	49	22.07	22.09	22.05	0
		25	0	21.26	21.21	21.22	1
		25	12	21.39	21.32	21.31	1
		25	25	21.33	21.29	21.32	1
		50	0	21.36	21.33	21.24	1
	16QAM	1	0	21.17	21.14	21.13	1
		1	24	21.46	21.41	21.42	1
		1	49	21.19	21.12	21.11	1
		25	0	20.35	20.31	20.34	2
		25	12	20.51	20.43	20.47	2
		25	25	20.39	20.41	20.37	2
		50	0	20.46	20.38	20.42	2



Test Report No.: RFA210218W001-5

Band/BW	Modulation	RB Size	RB Offset	Low CH 37825	Mid CH 38000	High CH 38175	MPR
				Frequency 2577.5 MHz	Frequency 2595 MHz	Frequency 2612.5MHz	
38/ 15	QPSK	1	0	22.17	22.12	22.05	0
		1	37	22.39	22.38	22.32	0
		1	74	22.13	22.12	22.06	0
		36	0	21.23	21.22	21.23	1
		36	19	21.40	21.37	21.31	1
		36	39	21.31	21.30	21.32	1
		75	0	21.36	21.31	21.29	1
	16QAM	1	0	21.21	21.21	21.13	1
		1	37	21.45	21.42	21.42	1
		1	74	21.15	21.17	21.13	1
		36	0	20.39	20.31	20.35	2
		36	19	20.45	20.47	20.43	2
		36	39	20.44	20.39	20.40	2
		75	0	20.47	20.41	20.35	2



Test Report No.: RFA210218W001-5

Band/BW	Modulation	RB Size	RB Offset	Low CH 37850	Mid CH 38000	High CH 38150	MPR
				Frequency 2580 MHz	Frequency 2595 MHz	Frequency 2610 MHz	
38/ 20	QPSK	1	0	22.18	22.16	22.13	0
		1	50	22.43	22.41	22.38	0
		1	99	22.15	22.13	22.10	0
		50	0	21.29	21.27	21.24	1
		50	25	21.41	21.39	21.36	1
		50	50	21.39	21.37	21.34	1
		100	0	21.37	21.35	21.32	1
	16QAM	1	0	21.24	21.22	21.19	1
		1	50	21.49	21.47	21.44	1
		1	99	21.21	21.19	21.16	1
		50	0	20.41	20.39	20.36	2
		50	25	20.53	20.51	20.48	2
		50	50	20.47	20.45	20.42	2
		100	0	20.48	20.46	20.43	2



**BUREAU
VERITAS**

Test Report No.: RFA210218W001-5

LTE Band 41

Band/BW	Modulation	RB Size	RB Offset	Low CH (39675)	Mid CH (40620)	High CH (41565)	MPR
				Frequency (2498.5)MHz	Frequency (2593)MHz	Frequency (2687.5)MHz	
41/ 5	QPSK	1	0	21.96	22.19	22.09	0
		1	12	22.46	22.69	22.55	0
		1	24	21.98	22.25	22.11	0
		12	0	21.17	21.39	21.28	1
		12	6	21.18	21.44	21.32	1
		12	13	21.25	21.51	21.37	1
		25	0	21.26	21.50	21.44	1
	16QAM	1	0	20.98	21.26	21.14	1
		1	12	21.45	21.71	21.66	1
		1	24	21.06	21.29	21.17	1
		12	0	20.20	20.43	20.40	2
		12	6	20.28	20.51	20.43	2
		12	13	20.32	20.60	20.51	2
		25	0	20.31	20.55	20.50	2



Test Report No.: RFA210218W001-5

Band/BW	Modulation	RB Size	RB Offset	Low CH (39700)	Mid CH (40620)	High CH (41540)	MPR
				Frequency (2501)MHz	Frequency (2593)MHz	Frequency (2685)MHz	
41/ 10	QPSK	1	0	21.93	22.19	22.07	0
		1	24	22.46	22.70	22.60	0
		1	49	21.95	22.21	22.09	0
		25	0	21.18	21.42	21.32	1
		25	12	21.24	21.44	21.38	1
		25	25	21.23	21.50	21.38	1
		50	0	21.31	21.47	21.44	1
	16QAM	1	0	20.98	21.22	21.14	1
		1	24	21.50	21.74	21.65	1
		1	49	21.06	21.26	21.14	1
		25	0	20.22	20.49	20.36	2
		25	12	20.32	20.56	20.42	2
		25	25	20.31	20.57	20.46	2
		50	0	20.35	20.59	20.43	2



Test Report No.: RFA210218W001-5

Band/BW	Modulation	RB Size	RB Offset	Low CH (39725)	Mid CH (40620)	High CH (41515)	MPR
				Frequency (2503.5)MHz	Frequency (2593)MHz	Frequency (2682.5)MHz	
41/ 15	QPSK	1	0	22.00	22.16	22.09	0
		1	37	22.44	22.65	22.60	0
		1	74	22.01	22.22	22.11	0
		36	0	21.15	21.43	21.34	1
		36	19	21.25	21.44	21.33	1
		36	39	21.21	21.50	21.41	1
		75	0	21.31	21.52	21.41	1
	16QAM	1	0	21.02	21.22	21.17	1
		1	37	21.49	21.74	21.60	1
		1	74	21.02	21.28	21.18	1
		36	0	20.26	20.50	20.41	2
		36	19	20.26	20.52	20.43	2
		36	39	20.36	20.60	20.51	2
		75	0	20.36	20.52	20.45	2



Test Report No.: RFA210218W001-5

Band/BW	Modulation	RB Size	RB Offset	Low CH (39750)	Mid CH (40620)	High CH (41490)	MPR
				Frequency (2506)MHz	Frequency (2593)MHz	Frequency (2680)MHz	
41/ 20	QPSK	1	0	22.01	22.24	22.15	0
		1	50	22.48	22.71	22.62	0
		1	99	22.03	22.26	22.17	0
		50	0	21.21	21.44	21.35	1
		50	25	21.26	21.49	21.40	1
		50	50	21.29	21.52	21.43	1
		100	0	21.32	21.55	21.46	1
	16QAM	1	0	21.05	21.28	21.19	1
		1	50	21.53	21.76	21.67	1
		1	99	21.08	21.31	21.22	1
		50	0	20.28	20.51	20.42	2
		50	25	20.34	20.57	20.48	2
		50	50	20.39	20.62	20.53	2
		100	0	20.37	20.60	20.51	2



BUREAU
VERITAS

Test Report No.: RFA210218W001-5

EIRP

WCDMA IV

Channel	Frequency (MHz)	Conducted Power (dBm)	G _T -L _c (dB)	EIRP (dBm)	EIRP (mW)	Limit (W)
9662	1852.4	22.52	1.6	24.12	258.23	1
9800	1880	22.54	1.6	24.14	259.42	1
9938	1907.6	22.66	1.6	24.26	266.69	1

LTE BAND 7

CHANNEL BANDWIDTH: 5MHz QPSK

Channel	Frequency (MHz)	Conducted Power (dBm)	G _T -L _c (dB)	EIRP (dBm)	EIRP (mW)	Limit (W)
20775	2502.5	22.44	-2	20.44	110.66	2
21100	2535.0	22.46	-2	20.46	111.17	2
21425	2567.5	22.6	-2	20.6	114.82	2

CHANNEL BANDWIDTH: 5MHz 16QAM

Channel	Frequency (MHz)	Conducted Power (dBm)	G _T -L _c (dB)	EIRP (dBm)	EIRP (mW)	Limit (W)
20775	2502.5	21.67	-2	19.67	92.68	2
21100	2535.0	21.81	-2	19.81	95.72	2
21425	2567.5	21.86	-2	19.86	96.83	2



BUREAU
VERITAS

Test Report No.: RFA210218W001-5

CHANNEL BANDWIDTH: 10MHz QPSK

Channel	Frequency (MHz)	Conducted Power (dBm)	G _T -L _c (dB)	EIRP (dBm)	EIRP (mW)	Limit (W)
20800	2505.0	22.44	-2	20.44	110.66	2
21100	2535.0	22.46	-2	20.46	111.17	2
21400	2565.0	22.61	-2	20.61	115.08	2

CHANNEL BANDWIDTH: 10MHz 16QAM

Channel	Frequency (MHz)	Conducted Power (dBm)	G _T -L _c (dB)	EIRP (dBm)	EIRP (mW)	Limit (W)
20800	2505.0	21.72	-2	19.72	93.76	2
21100	2535.0	21.77	-2	19.77	94.84	2
21400	2565.0	21.89	-2	19.89	97.5	2



**BUREAU
VERITAS**

Test Report No.: RFA210218W001-5

CHANNEL BANDWIDTH: 15MHz QPSK

Channel	Frequency (MHz)	Conducted Power (dBm)	G _T -L _c (dB)	EIRP (dBm)	EIRP (mW)	Limit (W)
20825	2507.5	22.42	-2	20.42	110.15	2
21100	2535.0	22.51	-2	20.51	112.46	2
21375	2562.5	22.56	-2	20.56	113.76	2

CHANNEL BANDWIDTH: 15MHz 16QAM

Channel	Frequency (MHz)	Conducted Power (dBm)	G _T -L _c (dB)	EIRP (dBm)	EIRP (mW)	Limit (W)
20825	2507.5	21.71	-2	19.71	93.54	2
21100	2535.0	21.78	-2	19.78	95.06	2
21375	2562.5	21.89	-2	19.89	97.5	2



**BUREAU
VERITAS**

Test Report No.: RFA210218W001-5

CHANNEL BANDWIDTH: 20MHz QPSK

Channel	Frequency (MHz)	Conducted Power (dBm)	G _T -L _c (dB)	EIRP (dBm)	EIRP (mW)	Limit (W)
20850	2510.0	22.46	-2	20.46	111.17	2
21100	2535.0	22.54	-2	20.54	113.24	2
21350	2560.0	22.62	-2	20.62	115.35	2

CHANNEL BANDWIDTH: 20MHz 16QAM

Channel	Frequency (MHz)	Conducted Power (dBm)	G _T -L _c (dB)	EIRP (dBm)	EIRP (mW)	Limit (W)
20850	2510.0	21.75	-2	19.75	94.41	2
21100	2535.0	21.83	-2	19.83	96.16	2
21350	2560.0	21.91	-2	19.91	97.95	2

REMARKS: ERP Output Power (dBm) = EIRP (dBm) -2.15(dB).



**BUREAU
VERITAS**

Test Report No.: RFA210218W001-5

LTE BAND 38

CHANNEL BANDWIDTH: 5MHz QPSK

Channel	Frequency (MHz)	Conducted Power (dBm)	G _{T-Lc} (dB)	EIRP (dBm)	EIRP (mW)	Limit (W)
37775	2572.5	22.41	2	24.41	276.06	2
38000	2595.0	22.33	2	24.33	271.02	2
38225	2617.5	22.36	2	24.36	272.9	2

CHANNEL BANDWIDTH: 5MHz 16QAM

Channel	Frequency (MHz)	Conducted Power (dBm)	G _{T-Lc} (dB)	EIRP (dBm)	EIRP (mW)	Limit (W)
37775	2572.5	21.41	2	23.41	219.28	2
38000	2595.0	21.45	2	23.45	221.31	2
38225	2617.5	21.39	2	23.39	218.27	2



**BUREAU
VERITAS**

Test Report No.: RFA210218W001-5

CHANNEL BANDWIDTH: 10MHz QPSK

Channel	Frequency (MHz)	Conducted Power (dBm)	G _T -L _c (dB)	EIRP (dBm)	EIRP (mW)	Limit (W)
37800	2575.0	22.41	2	24.41	276.06	2
38000	2595.0	22.33	2	24.33	271.02	2
38200	2615.0	22.37	2	24.37	273.53	2

CHANNEL BANDWIDTH: 10MHz 16QAM

Channel	Frequency (MHz)	Conducted Power (dBm)	G _T -L _c (dB)	EIRP (dBm)	EIRP (mW)	Limit (W)
37800	2575.0	21.46	2	23.46	221.82	2
38000	2595.0	21.41	2	23.41	219.28	2
38200	2615.0	21.42	2	23.42	219.79	2



BUREAU
VERITAS

Test Report No.: RFA210218W001-5

CHANNEL BANDWIDTH: 15MHz QPSK

Channel	Frequency (MHz)	Conducted Power (dBm)	G _T -L _c (dB)	EIRP (dBm)	EIRP (mW)	Limit (W)
37825	2577.5	22.39	2	24.39	274.79	2
38000	2595.0	22.38	2	24.38	274.16	2
38175	2612.5	22.32	2	24.32	270.4	2

CHANNEL BANDWIDTH: 15MHz 16QAM

Channel	Frequency (MHz)	Conducted Power (dBm)	G _T -L _c (dB)	EIRP (dBm)	EIRP (mW)	Limit (W)
37825	2577.5	21.45	2	23.45	221.31	2
38000	2595.0	21.42	2	23.42	219.79	2
38175	2612.5	21.42	2	23.42	219.79	2



BUREAU
VERITAS

Test Report No.: RFA210218W001-5

CHANNEL BANDWIDTH: 20MHz QPSK

Channel	Frequency (MHz)	Conducted Power (dBm)	G _T -L _c (dB)	EIRP (dBm)	EIRP (mW)	Limit (W)
37850	2580.0	22.43	2	24.43	277.33	2
38000	2595.0	22.41	2	24.41	276.06	2
38150	2610.0	22.38	2	24.38	274.16	2

CHANNEL BANDWIDTH: 20MHz 16QAM

Channel	Frequency (MHz)	Conducted Power (dBm)	G _T -L _c (dB)	EIRP (dBm)	EIRP (mW)	Limit (W)
37850	2580.0	21.49	2	23.49	223.36	2
38000	2595.0	21.47	2	23.47	222.33	2
38150	2610.0	21.44	2	23.44	220.8	2



BUREAU
VERITAS

Test Report No.: RFA210218W001-5

LTE BAND 41

CHANNEL BANDWIDTH: 5MHz QPSK

Channel	Frequency (MHz)	Conducted Power (dBm)	G _T -L _c (dB)	EIRP (dBm)	EIRP (mW)	Limit (W)
39675	2498.5	22.46	-2	20.46	111.17	2
40620	2593.0	22.69	-2	20.69	117.22	2
41565	2687.5	22.55	-2	20.55	113.5	2

CHANNEL BANDWIDTH: 5MHz 16QAM

Channel	Frequency (MHz)	Conducted Power (dBm)	G _T -L _c (dB)	EIRP (dBm)	EIRP (mW)	Limit (W)
39675	2498.5	21.45	-2	19.45	88.1	2
40620	2593.0	21.71	-2	19.71	93.54	2
41565	2687.5	21.66	-2	19.66	92.47	2



**BUREAU
VERITAS**

Test Report No.: RFA210218W001-5

CHANNEL BANDWIDTH: 10MHz QPSK

Channel	Frequency (MHz)	Conducted Power (dBm)	G _T -L _c (dB)	EIRP (dBm)	EIRP (mW)	Limit (W)
39700	2501.0	22.46	-2	20.46	111.17	2
40620	2593.0	22.7	-2	20.7	117.49	2
41540	2685.0	22.6	-2	20.6	114.82	2

CHANNEL BANDWIDTH: 10MHz 16QAM

Channel	Frequency (MHz)	Conducted Power (dBm)	G _T -L _c (dB)	EIRP (dBm)	EIRP (mW)	Limit (W)
39700	2501.0	21.5	-2	19.5	89.13	2
40620	2593.0	21.74	-2	19.74	94.19	2
41540	2685.0	21.65	-2	19.65	92.26	2



**BUREAU
VERITAS**

Test Report No.: RFA210218W001-5

CHANNEL BANDWIDTH: 15MHz QPSK

Channel	Frequency (MHz)	Conducted Power (dBm)	G _T -L _c (dB)	EIRP (dBm)	EIRP (mW)	Limit (W)
39725	2503.5.0	22.44	-2	20.44	110.66	2
40620	2593.0	22.65	-2	20.65	116.14	2
41515	2682.5.0	22.6	-2	20.6	114.82	2

CHANNEL BANDWIDTH: 15MHz 16QAM

Channel	Frequency (MHz)	Conducted Power (dBm)	G _T -L _c (dB)	EIRP (dBm)	EIRP (mW)	Limit (W)
39725	2503.5.0	21.49	-2	19.49	88.92	2
40620	2593.0	21.74	-2	19.74	94.19	2
41515	2682.5.0	21.6	-2	19.6	91.2	2



**BUREAU
VERITAS**

Test Report No.: RFA210218W001-5

CHANNEL BANDWIDTH: 20MHz QPSK

Channel	Frequency (MHz)	Conducted Power (dBm)	G _T -L _c (dB)	EIRP (dBm)	EIRP (mW)	Limit (W)
39750	2506.0	22.48	-2	20.48	111.69	2
40620	2593.0	22.71	-2	20.71	117.76	2
41490	2680.0	22.62	-2	20.62	115.35	2

CHANNEL BANDWIDTH: 20MHz 16QAM

Channel	Frequency (MHz)	Conducted Power (dBm)	G _T -L _c (dB)	EIRP (dBm)	EIRP (mW)	Limit (W)
39750	2506.0	21.53	-2	19.53	89.74	2
40620	2593.0	21.76	-2	19.76	94.62	2
41490	2680.0	21.67	-2	19.67	92.68	2

3.2 FREQUENCY STABILITY MEASUREMENT

3.2.1 LIMITS OF FREQUENCY STABILITY MEASUREMENT

The frequency stability shall be sufficient to ensure that the fundamental emissions stay within the authorized bands of operation.

3.2.2 TEST PROCEDURE

- Device is placed at the oven room. The oven room could control the temperatures and humidity. Power warm up is at least 15 min and power applied should perform before recording frequency error.
- EUT is connected the external power supply to control the DC input power. The test voltage range is from minimum to maximum working voltage. Each step shall be record the frequency error rate.
- The temperature range step is 10 degrees in this test items. All temperature levels shall be hold the $\pm 0.5^{\circ}\text{C}$ during the measurement testing. The each temperature step shall be at least 0.5 hours, consider the EUT could be test under the stability condition.

NOTE: The frequency error was recorded frequency error from the communication simulator.

3.2.3 TEST SETUP

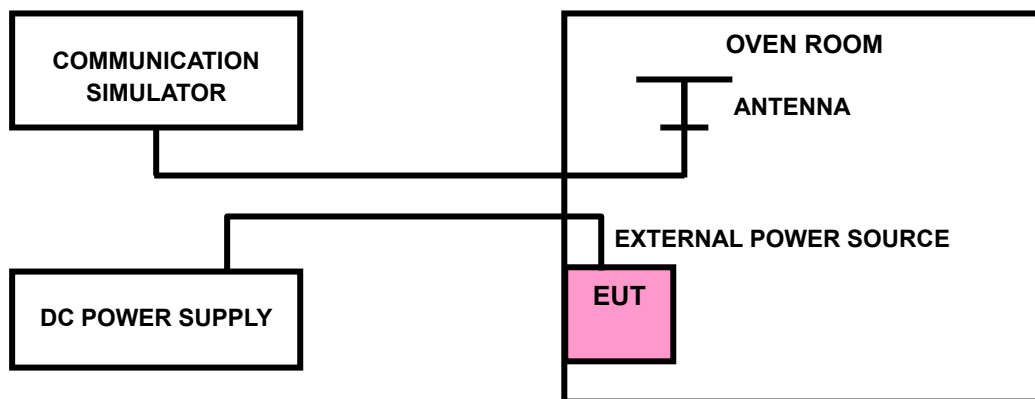

3.2.4 TEST RESULTS

WCDMA BAND IV

FREQUENCY ERROR VS. VOLTAGE

VOLTAGE (Volts)	FREQUENCY ERROR (ppm)		LIMIT (ppm)
	Low Channel	High Channel	
V_{nor}	0.0019	0.0017	2.5
V_{min}	-0.0022	-0.0021	2.5
V_{max}	0.0020	0.0019	2.5

NOTE: The applicant defined the normal working voltage of the battery is from V_{min} Vdc to V_{max} Vdc.

FREQUENCY ERROR vs. TEMPERATURE.

TEMP. (°C)	FREQUENCY ERROR (ppm)		LIMIT (ppm)
	Low Channel	High Channel	
-30	-0.0120	-0.0124	2.5
-20	-0.0119	-0.0108	2.5
-10	-0.0110	-0.0098	2.5
0	-0.0096	-0.0096	2.5
10	-0.0075	-0.0070	2.5
20	-0.0064	-0.0066	2.5
30	-0.0057	-0.0065	2.5
40	-0.0052	-0.0037	2.5
50	-0.0007	0.0010	2.5



BUREAU
VERITAS

Test Report No.: RFA210218W001-5

LTE BAND 7

FREQUENCY ERROR VS. VOLTAGE

VOLTAGE (Volts)	5MHz		LIMIT (ppm)
	FREQUENCY ERROR (ppm)		
	Low Channel	High Channel	
V _{nor}	0.0021	0.0025	2.5
V _{min}	-0.0023	-0.003	2.5
V _{max}	0.0021	0.0021	2.5

NOTE: The applicant defined the normal working voltage of the battery is from V_{min} Vdc to V_{max} Vdc.

FREQUENCY ERROR vs. TEMPERATURE.

TEMP. (°C)	5MHz		LIMIT (ppm)
	FREQUENCY ERROR (ppm)		
	Low Channel	High Channel	
-30	-0.012	-0.0113	2.5
-20	-0.0103	-0.0098	2.5
-10	-0.0084	-0.0084	2.5
0	-0.0075	-0.0074	2.5
10	-0.0052	-0.0051	2.5
20	-0.0042	-0.0042	2.5
30	-0.0032	-0.0042	2.5
40	-0.0023	-0.0018	2.5
50	-0.0006	-0.0005	2.5

FREQUENCY ERROR VS. VOLTAGE

VOLTAGE (Volts)	10MHz		LIMIT (ppm)
	FREQUENCY ERROR (ppm)		
	Low Channel	High Channel	
V _{nor}	0.0025	0.0025	2.5
V _{min}	-0.0031	-0.003	2.5
V _{max}	0.0024	0.0025	2.5

NOTE: The applicant defined the normal working voltage of the battery is from V_{min} Vdc to V_{max} Vdc.

FREQUENCY ERROR vs. TEMPERATURE.

TEMP. (°C)	10MHz		LIMIT (ppm)
	FREQUENCY ERROR (ppm)		
	Low Channel	High Channel	
-30	-0.0123	-0.0118	2.5
-20	-0.0103	-0.0104	2.5
-10	-0.0081	-0.008	2.5
0	-0.0077	-0.0076	2.5
10	-0.0045	-0.005	2.5
20	-0.004	-0.0038	2.5
30	-0.003	-0.003	2.5
40	-0.0023	-0.0017	2.5
50	-0.0005	-0.0004	2.5

FREQUENCY ERROR VS. VOLTAGE

VOLTAGE (Volts)	15MHz		LIMIT (ppm)
	FREQUENCY ERROR (ppm)		
	Low Channel	High Channel	
V _{nor}	0.0025	0.0026	2.5
V _{min}	-0.0031	-0.003	2.5
V _{max}	0.0025	0.0026	2.5

NOTE: The applicant defined the normal working voltage of the battery is from V_{min} Vdc to V_{max} Vdc.

FREQUENCY ERROR vs. TEMPERATURE.

TEMP. (°C)	15MHz		LIMIT (ppm)
	FREQUENCY ERROR (ppm)		
	Low Channel	High Channel	
-30	-0.012	-0.0119	2.5
-20	-0.0098	-0.0099	2.5
-10	-0.0083	-0.0084	2.5
0	-0.0077	-0.0075	2.5
10	-0.005	-0.0053	2.5
20	-0.0043	-0.0041	2.5
30	-0.0036	-0.0028	2.5
40	-0.0019	-0.0022	2.5
50	-0.0006	-0.0003	2.5

FREQUENCY ERROR VS. VOLTAGE

VOLTAGE (Volts)	20MHz		LIMIT (ppm)
	FREQUENCY ERROR (ppm)		
	Low Channel	High Channel	
V _{nor}	0.0025	0.0025	2.5
V _{min}	-0.0031	-0.003	2.5
V _{max}	0.0026	0.0026	2.5

NOTE: The applicant defined the normal working voltage of the battery is from V_{min} Vdc to V_{max} Vdc.

FREQUENCY ERROR vs. TEMPERATURE.

TEMP. (°C)	20MHz		LIMIT (ppm)
	FREQUENCY ERROR (ppm)		
	Low Channel	High Channel	
-30	-0.0115	-0.0116	2.5
-20	-0.0099	-0.01	2.5
-10	-0.0084	-0.0083	2.5
0	-0.0074	-0.0073	2.5
10	-0.0046	-0.0046	2.5
20	-0.0038	-0.0039	2.5
30	-0.0036	-0.0039	2.5
40	-0.0021	-0.0015	2.5
50	-0.0002	-0.0004	2.5



**BUREAU
VERITAS**

Test Report No.: RFA210218W001-5

LTE BAND 38

FREQUENCY ERROR VS. VOLTAGE

VOLTAGE (Volts)	5MHz		LIMIT (ppm)
	FREQUENCY ERROR (ppm)		
	Low Channel	High Channel	
V _{nor}	0.0022	0.0024	2.5
V _{min}	-0.0023	-0.003	2.5
V _{max}	0.0021	0.002	2.5

NOTE: The applicant defined the normal working voltage of the battery is from V_{min} Vdc to V_{max} Vdc.

FREQUENCY ERROR vs. TEMPERATURE.

TEMP. (°C)	5MHz		LIMIT (ppm)
	FREQUENCY ERROR (ppm)		
	Low Channel	High Channel	
-30	-0.0122	-0.0111	2.5
-20	-0.0113	-0.0099	2.5
-10	-0.0084	-0.0079	2.5
0	-0.0074	-0.0072	2.5
10	-0.0054	-0.0047	2.5
20	-0.004	-0.0041	2.5
30	-0.0028	-0.0029	2.5
40	-0.0023	-0.002	2.5
50	-0.0006	-0.0004	2.5

FREQUENCY ERROR VS. VOLTAGE

VOLTAGE (Volts)	10MHz		LIMIT (ppm)
	FREQUENCY ERROR (ppm)		
	Low Channel	High Channel	
V _{nor}	0.0025	0.0024	2.5
V _{min}	-0.0031	-0.0031	2.5
V _{max}	0.0025	0.0024	2.5

NOTE: The applicant defined the normal working voltage of the battery is from V_{min} Vdc to V_{max} Vdc.

FREQUENCY ERROR vs. TEMPERATURE.

TEMP. (°C)	10MHz		LIMIT (ppm)
	FREQUENCY ERROR (ppm)		
	Low Channel	High Channel	
-30	-0.0119	-0.0116	2.5
-20	-0.0104	-0.0111	2.5
-10	-0.0081	-0.0084	2.5
0	-0.0074	-0.0074	2.5
10	-0.0056	-0.0044	2.5
20	-0.0039	-0.0037	2.5
30	-0.0038	-0.0038	2.5
40	-0.0023	-0.0015	2.5
50	-0.0003	-0.0005	2.5

FREQUENCY ERROR VS. VOLTAGE

VOLTAGE (Volts)	15MHz		LIMIT (ppm)
	FREQUENCY ERROR (ppm)		
	Low Channel	High Channel	
V _{nor}	0.0026	0.0026	2.5
V _{min}	-0.003	-0.003	2.5
V _{max}	0.0026	0.0026	2.5

NOTE: The applicant defined the normal working voltage of the battery is from V_{min} Vdc to V_{max} Vdc.

FREQUENCY ERROR vs. TEMPERATURE.

TEMP. (°C)	15MHz		LIMIT (ppm)
	FREQUENCY ERROR (ppm)		
	Low Channel	High Channel	
-30	-0.0123	-0.0112	2.5
-20	-0.0099	-0.0098	2.5
-10	-0.0082	-0.0083	2.5
0	-0.0074	-0.0073	2.5
10	-0.0047	-0.0054	2.5
20	-0.0041	-0.0039	2.5
30	-0.0031	-0.0032	2.5
40	-0.0021	-0.0021	2.5
50	-0.0005	-0.0002	2.5

FREQUENCY ERROR VS. VOLTAGE

VOLTAGE (Volts)	20MHz		LIMIT (ppm)
	FREQUENCY ERROR (ppm)		
	Low Channel	High Channel	
V _{nor}	0.0024	0.0023	2.5
V _{min}	-0.003	-0.003	2.5
V _{max}	0.0024	0.0024	2.5

NOTE: The applicant defined the normal working voltage of the battery is from V_{min} Vdc to V_{max} Vdc.

FREQUENCY ERROR vs. TEMPERATURE.

TEMP. (°C)	20MHz		LIMIT (ppm)
	FREQUENCY ERROR (ppm)		
	Low Channel	High Channel	
-30	-0.0122	-0.0119	2.5
-20	-0.01	-0.0104	2.5
-10	-0.0082	-0.0084	2.5
0	-0.0077	-0.0075	2.5
10	-0.0056	-0.0052	2.5
20	-0.004	-0.0044	2.5
30	-0.0043	-0.003	2.5
40	-0.0022	-0.0016	2.5
50	-0.0004	-0.0006	2.5



BUREAU
VERITAS

Test Report No.: RFA210218W001-5

LTE BAND 41

FREQUENCY ERROR VS. VOLTAGE

VOLTAGE (Volts)	5MHz		LIMIT (ppm)
	FREQUENCY ERROR (ppm)		
	Low Channel	High Channel	
V _{nor}	0.0021	0.0026	2.5
V _{min}	-0.0023	-0.003	2.5
V _{max}	0.0021	0.0021	2.5

NOTE: The applicant defined the normal working voltage of the battery is from V_{min} Vdc to V_{max} Vdc.

FREQUENCY ERROR vs. TEMPERATURE.

TEMP. (°C)	5MHz		LIMIT (ppm)
	FREQUENCY ERROR (ppm)		
	Low Channel	High Channel	
-30	-0.0117	-0.0115	2.5
-20	-0.0109	-0.0105	2.5
-10	-0.0086	-0.0082	2.5
0	-0.0077	-0.0073	2.5
10	-0.0047	-0.0046	2.5
20	-0.0038	-0.0043	2.5
30	-0.0043	-0.0034	2.5
40	-0.0018	-0.0019	2.5
50	-0.0003	-0.0005	2.5

FREQUENCY ERROR VS. VOLTAGE

VOLTAGE (Volts)	10MHz		LIMIT (ppm)
	FREQUENCY ERROR (ppm)		
	Low Channel	High Channel	
V _{nor}	0.0027	0.0026	2.5
V _{min}	-0.0031	-0.003	2.5
V _{max}	0.0024	0.0024	2.5

NOTE: The applicant defined the normal working voltage of the battery is from V_{min} Vdc to V_{max} Vdc.

FREQUENCY ERROR vs. TEMPERATURE.

TEMP. (°C)	10MHz		LIMIT (ppm)
	FREQUENCY ERROR (ppm)		
	Low Channel	High Channel	
-30	-0.012	-0.0117	2.5
-20	-0.01	-0.0106	2.5
-10	-0.0085	-0.0084	2.5
0	-0.0076	-0.0075	2.5
10	-0.0053	-0.0051	2.5
20	-0.0042	-0.0043	2.5
30	-0.0032	-0.0026	2.5
40	-0.0019	-0.002	2.5
50	-0.0005	-0.0004	2.5

FREQUENCY ERROR VS. VOLTAGE

VOLTAGE (Volts)	15MHz		LIMIT (ppm)
	FREQUENCY ERROR (ppm)		
	Low Channel	High Channel	
V _{nor}		0.0025	2.5
V _{min}	-0.003	-0.003	2.5
V _{max}	0.0025	0.0024	2.5

NOTE: The applicant defined the normal working voltage of the battery is from V_{min} Vdc to V_{max} Vdc.

FREQUENCY ERROR vs. TEMPERATURE.

TEMP. (°C)	15MHz		LIMIT (ppm)
	FREQUENCY ERROR (ppm)		
	Low Channel	High Channel	
-30	-0.0116	-0.0111	2.5
-20	-0.0104	-0.0104	2.5
-10	-0.0082	-0.0082	2.5
0	-0.0077	-0.0073	2.5
10	-0.0055	-0.0051	2.5
20	-0.0039	-0.0041	2.5
30	-0.0041	-0.0034	2.5
40	-0.0016	-0.0022	2.5
50	-0.0002	-0.0002	2.5

FREQUENCY ERROR VS. VOLTAGE

VOLTAGE (Volts)	20MHz		LIMIT (ppm)
	FREQUENCY ERROR (ppm)		
	Low Channel	High Channel	
V _{nor}	0.0025	0.0025	2.5
V _{min}	-0.003	-0.003	2.5
V _{max}	0.0024	0.0024	2.5

NOTE: The applicant defined the normal working voltage of the battery is from V_{min} Vdc to V_{max} Vdc.

FREQUENCY ERROR vs. TEMPERATURE.

TEMP. (°C)	20MHz		LIMIT (ppm)
	FREQUENCY ERROR (ppm)		
	Low Channel	High Channel	
-30	-0.0116	-0.0116	2.5
-20	-0.0109	-0.0108	2.5
-10	-0.0085	-0.0084	2.5
0	-0.0076	-0.0074	2.5
10	-0.0051	-0.0055	2.5
20	-0.0039	-0.0038	2.5
30	-0.0034	-0.0037	2.5
40	-0.0022	-0.0017	2.5
50	-0.0004	-0.0002	2.5

3.3 OCCUPIED BANDWIDTH MEASUREMENT

3.3.1 LIMITS OF OCCUPIED BANDWIDTH MEASUREMENT

The width of a frequency band such that, below the lower and above the upper frequency limits, the mean powers emitted are each equal to a specified percentage 0.5 %of the total mean power of a given emission.

3.3.2 TEST SETUP

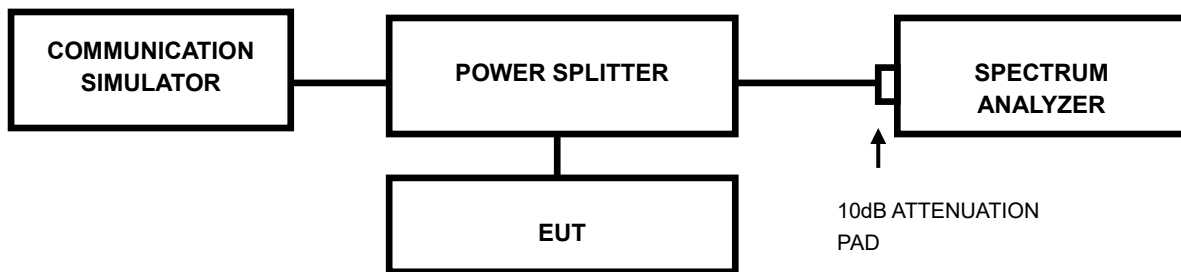

3.3.3 TEST PROCEDURES

- The conducted occupied bandwidth used the power splitter via EUT RF power connector between simulation base station and spectrum analyzer.
- Use OBW measurement function of Spectrum analyzer to measure 99 % occupied bandwidth.

3.3.4 TEST RESULTS

WCDMA BAND IV

Channel	FREQ. (MHz)	99% Occupied Bandwidth (MHz)	Channel	FREQ. (MHz)	26dB Bandwidth (MHz)
		WCDMA			WCDMA
1312	1712.40	4.18	1312	1712.40	4.689
1413	1732.60	4.18	1413	1732.60	4.737
1513	1752.60	4.18	1513	1752.60	4.736

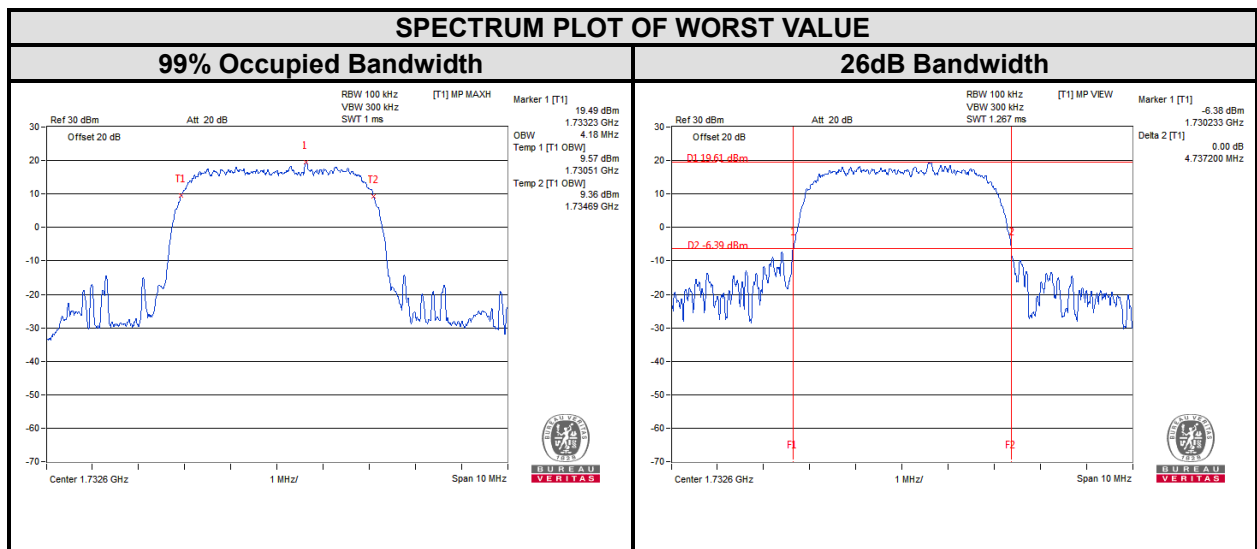

LTE BAND 7							
CHANNEL BANDWIDTH: 5MHz							
CHANNEL	FREQUENCY (MHz)	99% OCCUPIED BANDWIDTH (MHz)			26dB BANDWIDTH (MHz)		
		QPSK	16QAM	64QAM	QPSK	16QAM	64QAM
20775	2502.5	4.49	4.48	/	4.84	4.84	/
21100	2535	4.47	4.47	/	4.80	4.83	/
21425	2567.5	4.48	4.48	/	4.84	4.84	/

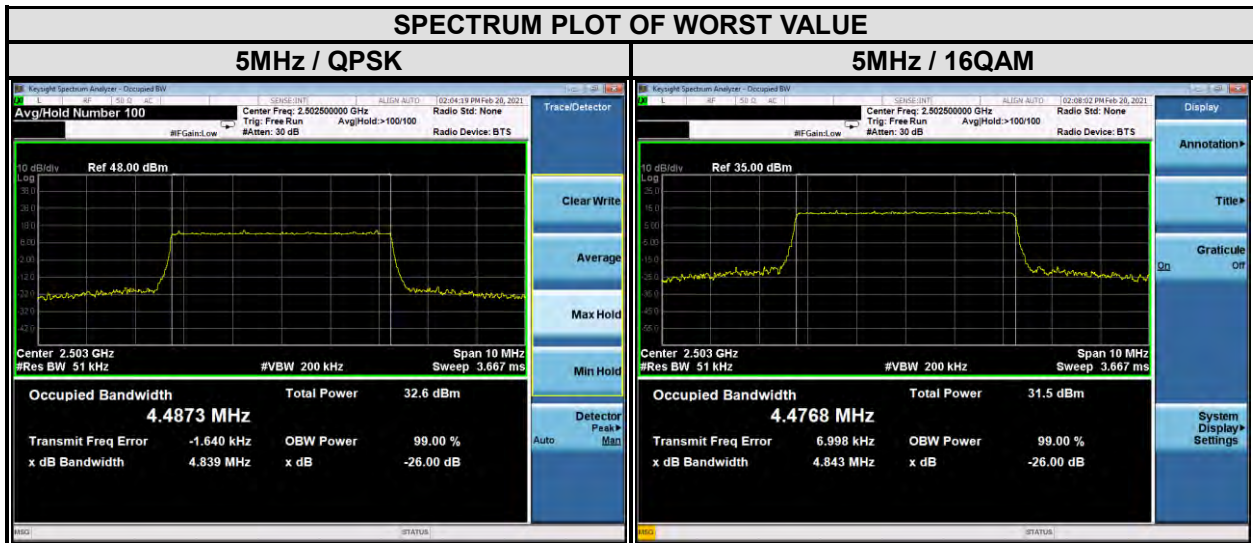

LTE BAND 7							
CHANNEL BANDWIDTH: 10MHz							
CHANNEL	FREQUENCY (MHz)	99% OCCUPIED BANDWIDTH (MHz)			26dB BANDWIDTH (MHz)		
		QPSK	16QAM	64QAM	QPSK	16QAM	64QAM
20800	2505	8.95	8.95	/	9.61	9.52	/
21100	2535	8.95	8.95	/	9.53	9.57	/
21400	2565	8.95	8.94	/	9.52	9.51	/

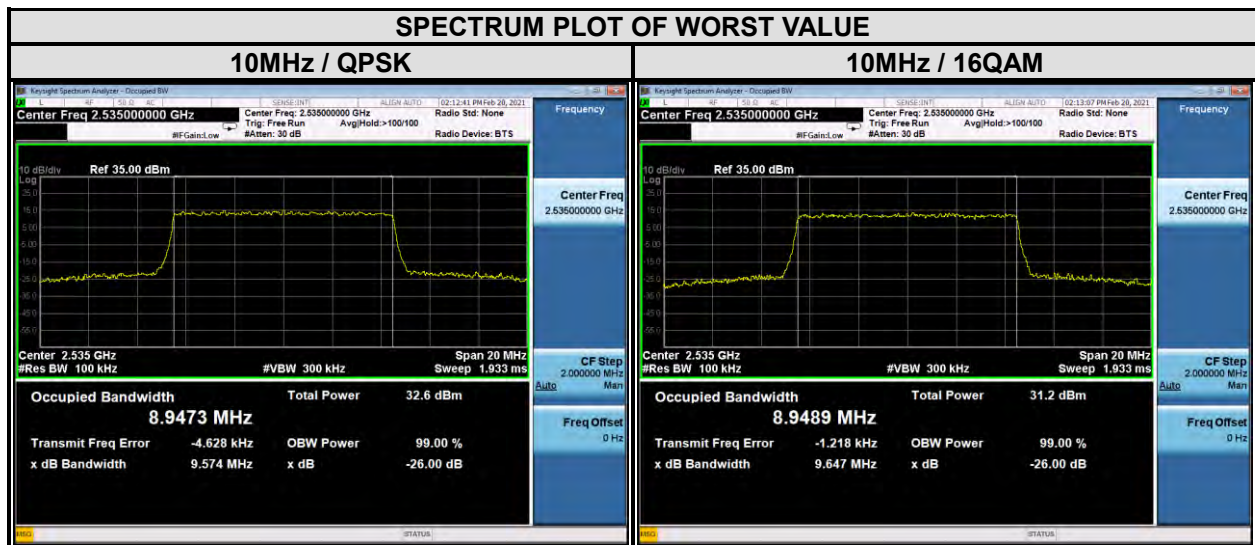



Test Report No.: RFA210218W001-5

LTE BAND 7							
CHANNEL BANDWIDTH: 15MHz							
CHANNEL	FREQUENCY (MHz)	99% OCCUPIED BANDWIDTH (MHz)			26dB BANDWIDTH (MHz)		
		QPSK	16QAM	64QAM	QPSK	16QAM	64QAM
20825	2507.5	13.40	13.42	/	14.35	14.30	/
21100	2535	13.45	13.42	/	14.48	14.36	/
21375	2562.5	13.43	13.44	/	14.40	14.39	/

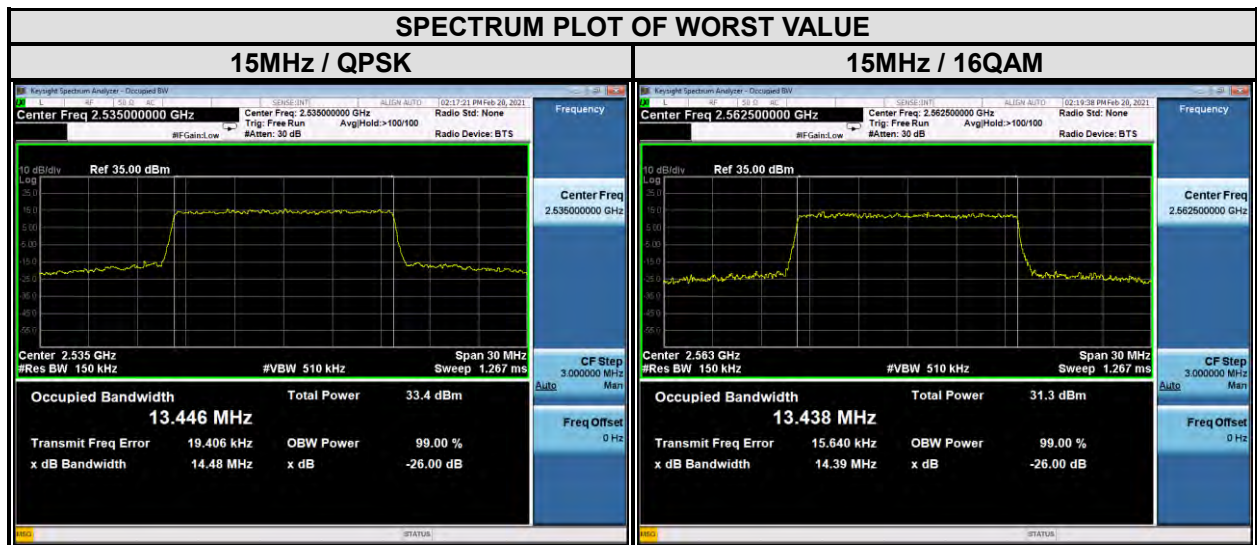

LTE BAND 7							
CHANNEL BANDWIDTH: 20MHz							
CHANNEL	FREQUENCY (MHz)	99% OCCUPIED BANDWIDTH (MHz)			26dB BANDWIDTH (MHz)		
		QPSK	16QAM	64QAM	QPSK	16QAM	64QAM
20850	2510	17.88	17.91	/	19.04	18.95	/
21100	2535	17.90	17.91	/	18.95	19.04	/
21350	2560	17.93	17.88	/	19.29	19.06	/

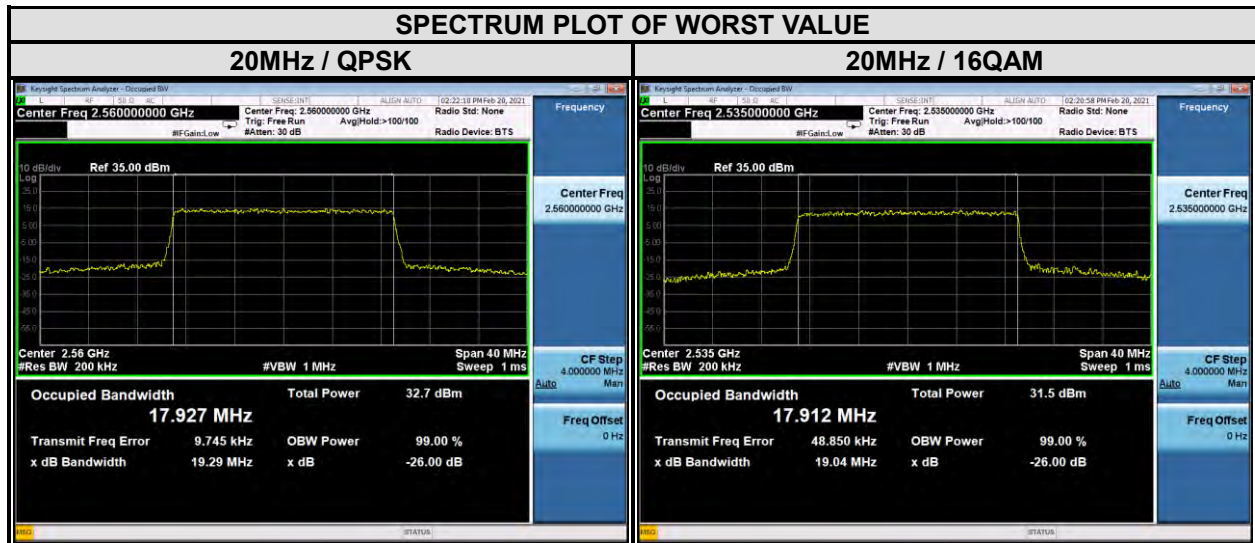

LTE BAND 38							
CHANNEL BANDWIDTH:5MHz							
CHANNEL	FREQUENCY (MHz)	99% OCCUPIED BANDWIDTH (MHz)			26dB BANDWIDTH (MHz)		
		QPSK	16QAM	64QAM	QPSK	16QAM	64QAM
37775	2572.5	4.46	4.46	/	4.82	4.82	/
38000	2595	4.47	4.47	/	4.87	4.82	/
38225	2617.5	4.48	4.46	/	4.74	4.82	/

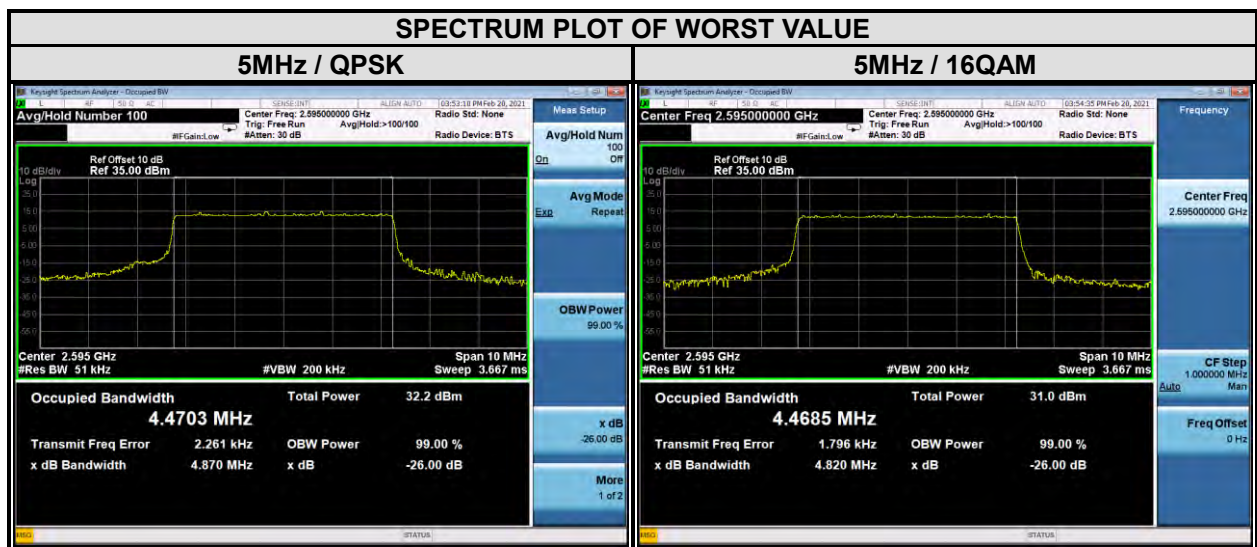



Test Report No.: RFA210218W001-5

LTE BAND 38							
CHANNEL BANDWIDTH: 10MHz							
CHANNEL	FREQUENCY (MHz)	99% OCCUPIED BANDWIDTH (MHz)			26dB BANDWIDTH (MHz)		
		QPSK	16QAM	64QAM	QPSK	16QAM	64QAM
37800	2575	8.94	8.93	/	9.61	9.46	/
38000	2595	8.95	8.95	/	9.72	9.45	/
38200	2615	8.96	8.94	/	9.54	9.92	/

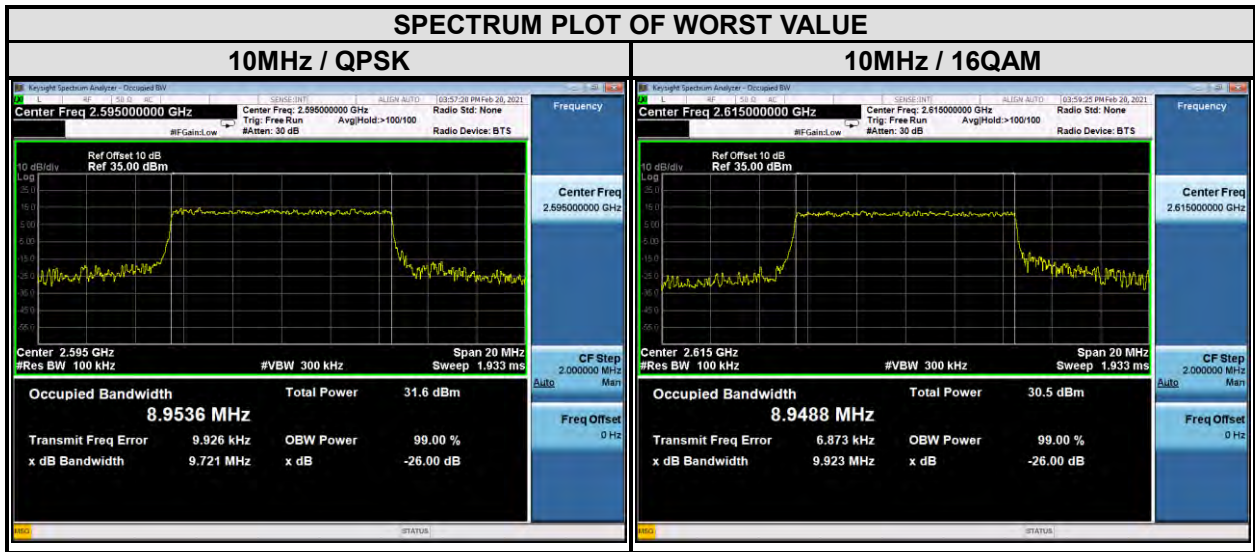

LTE BAND 38							
CHANNEL BANDWIDTH: 15MHz							
CHANNEL	FREQUENCY (MHz)	99% OCCUPIED BANDWIDTH (MHz)			26dB BANDWIDTH (MHz)		
		QPSK	16QAM	64QAM	QPSK	16QAM	64QAM
37825	2577.5	13.39	13.42	/	14.45	14.60	/
38000	2595	13.42	13.42	/	14.85	14.58	/
38175	2612.5	13.42	13.45	/	14.26	14.52	/

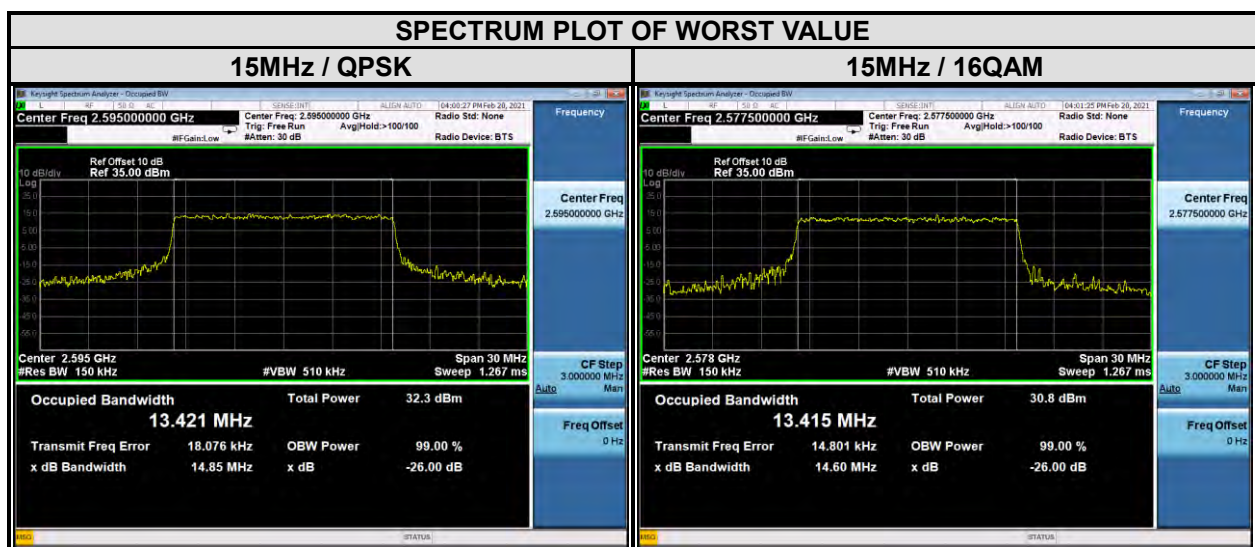

LTE BAND 38							
CHANNEL BANDWIDTH: 20MHz							
CHANNEL	FREQUENCY (MHz)	99% OCCUPIED BANDWIDTH (MHz)			26dB BANDWIDTH (MHz)		
		QPSK	16QAM	64QAM	QPSK	16QAM	64QAM
37850	2580	17.87	17.89	/	19.00	19.90	/
38000	2595	17.92	17.88	/	19.79	18.99	/
38150	2610	17.88	17.85	/	19.04	19.12	/

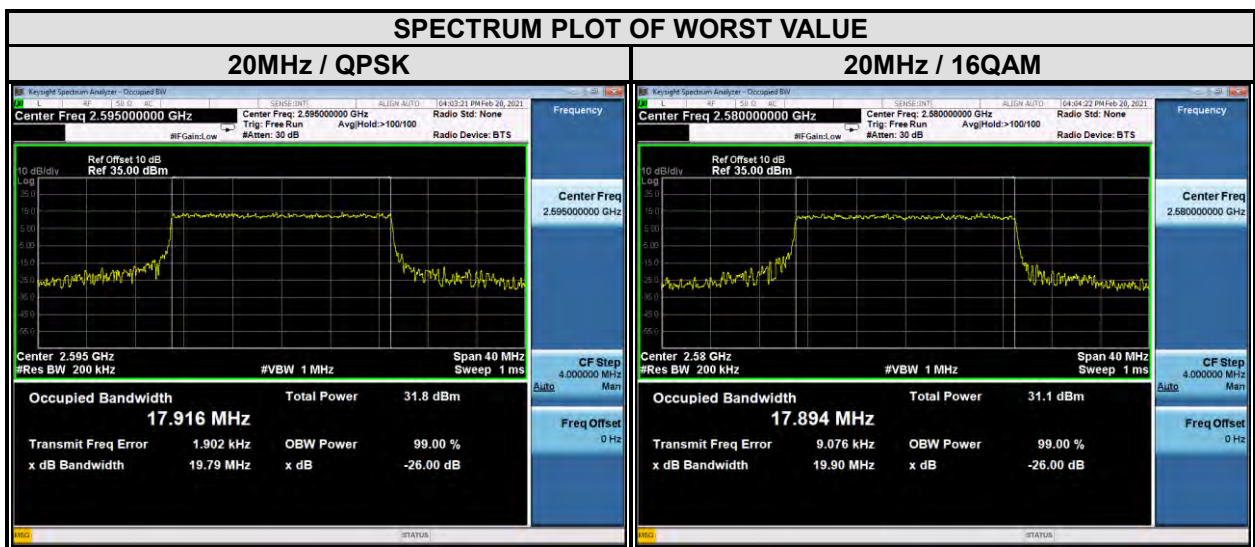

LTE BAND 41							
CHANNEL BANDWIDTH:5MHz							
CHANNEL	FREQUENCY (MHz)	99% OCCUPIED BANDWIDTH (MHz)			26dB BANDWIDTH (MHz)		
		QPSK	16QAM	64QAM	QPSK	16QAM	64QAM
39675	2498.5	4.46	4.47	/	4.66	4.70	/
40620	2593.0	4.46	4.46	/	4.68	4.69	/
41565	2687.5	4.46	4.46	/	4.67	4.70	/

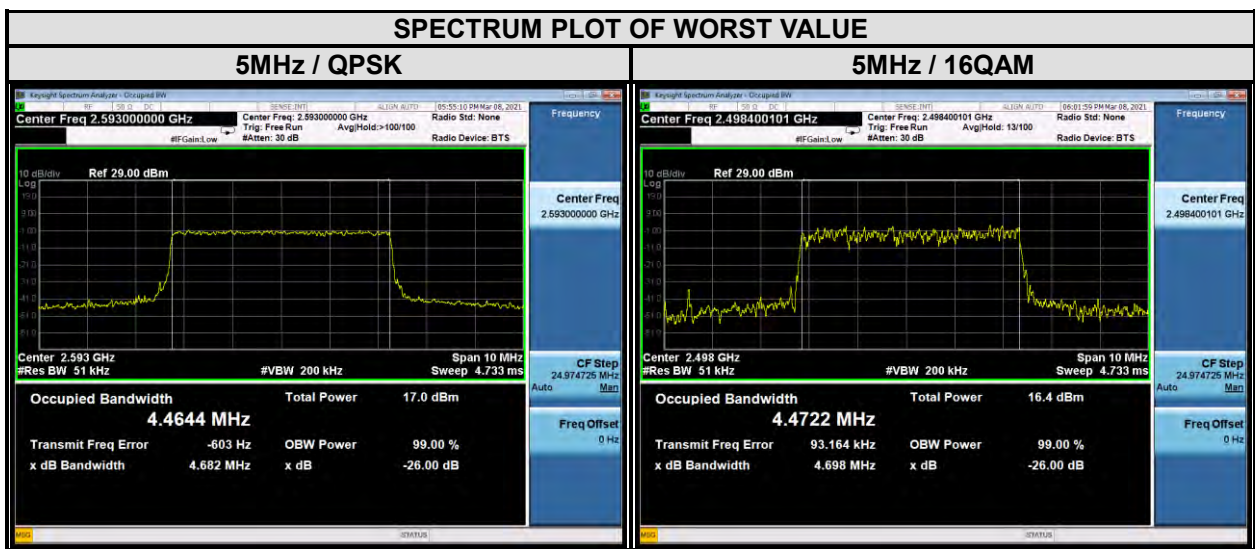

LTE BAND 41							
CHANNEL BANDWIDTH:10MHz							
CHANNEL	FREQUENCY (MHz)	99% OCCUPIED BANDWIDTH (MHz)			26dB BANDWIDTH (MHz)		
		QPSK	16QAM	64QAM	QPSK	16QAM	64QAM
39700	2501.0	8.91	8.92	/	9.29	9.28	/
40620	2593.0	8.91	8.92	/	9.27	9.29	/
41540	2685.0	8.92	8.93	/	9.30	9.27	/

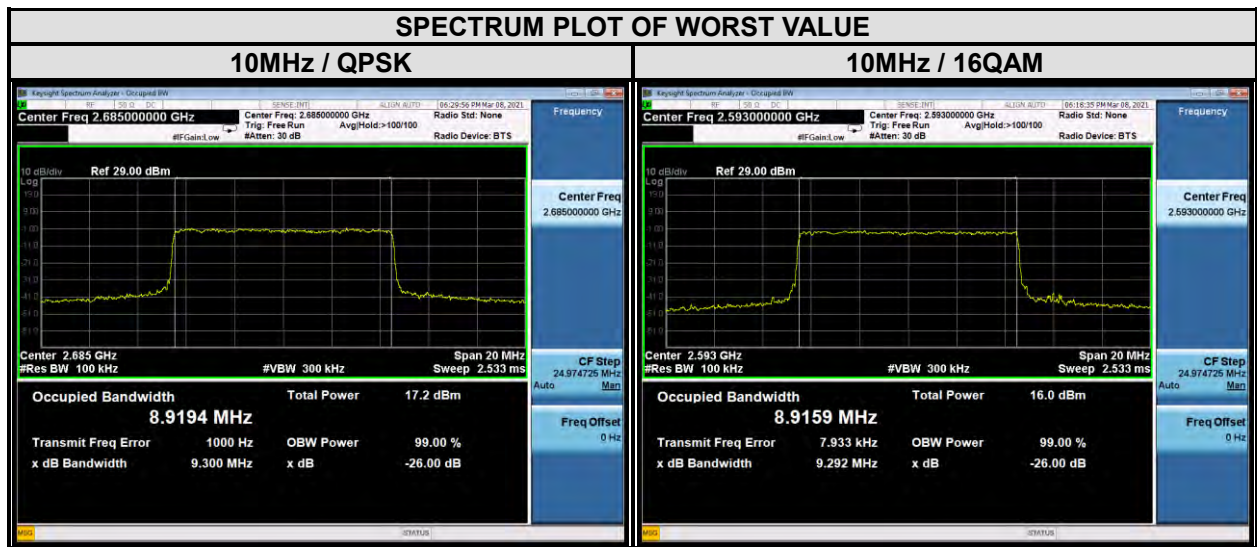

LTE BAND 41							
CHANNEL BANDWIDTH:15MHz							
CHANNEL	FREQUENCY (MHz)	99% OCCUPIED BANDWIDTH (MHz)			26dB BANDWIDTH (MHz)		
		QPSK	16QAM	64QAM	QPSK	16QAM	64QAM
39725	2503.5.0	13.39	13.37	/	13.91	13.95	/
40620	2593.0	13.40	13.38	/	13.91	13.94	/
41515	2682.5.0	13.40	13.40	/	13.91	14.03	/

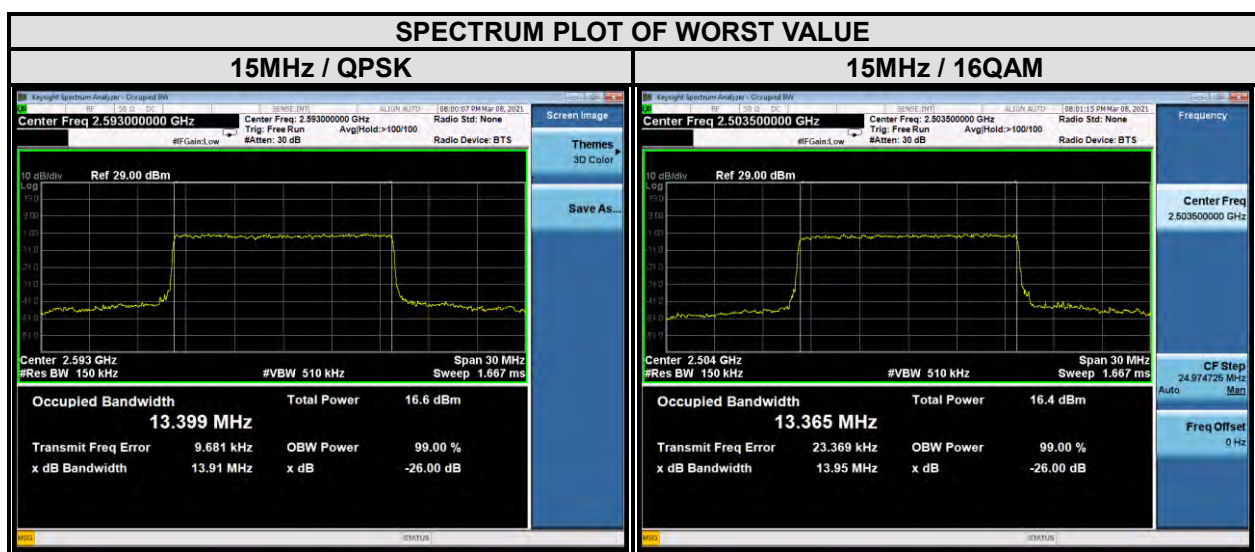

LTE BAND 41							
CHANNEL BANDWIDTH:20MHz							
CHANNEL	FREQUENCY (MHz)	99% OCCUPIED BANDWIDTH (MHz)			26dB BANDWIDTH (MHz)		
		QPSK	16QAM	64QAM	QPSK	16QAM	64QAM
39750	2506.0	17.84	17.81	/	18.52	18.53	/
40620	2593.0	17.85	17.83	/	18.52	18.54	/
41490	2680.0	17.84	17.85	/	18.53	18.56	/

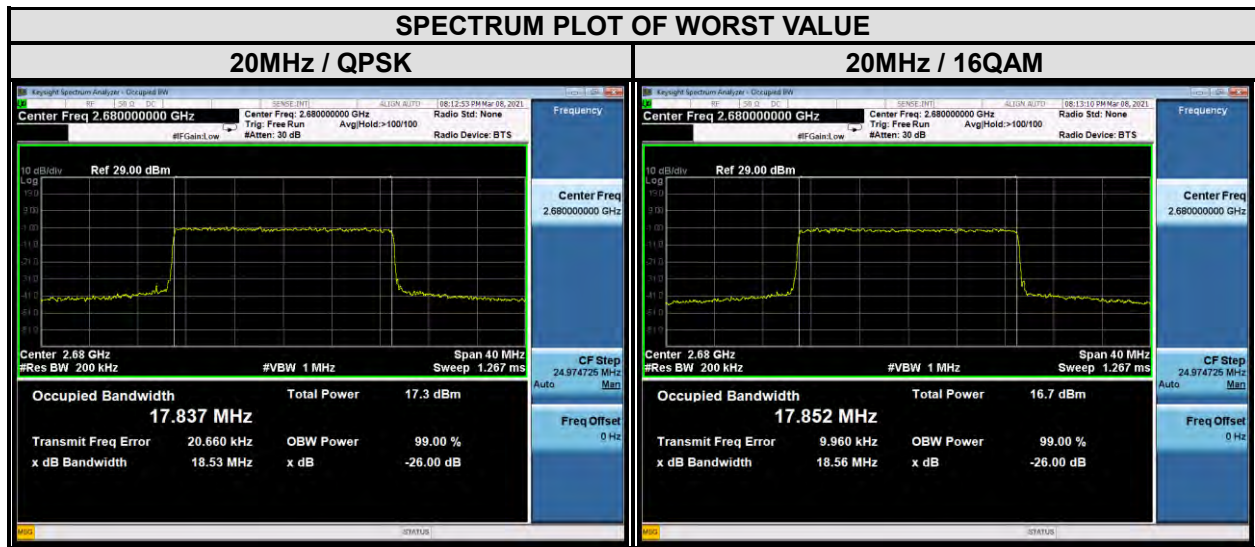

3.4 BAND EDGE MEASUREMENT

3.4.1 LIMITS OF BAND EDGE MEASUREMENT

According to FCC 27.53(m)(4) specified that For mobile digital stations, the attenuation factor shall be not less than $40 + 10 \log (P)$ dB on all frequencies between the channel edge and 5 megahertz from the channel edge, $43 + 10 \log (P)$ dB on all frequencies between 5 megahertz and X megahertz from the channel edge, and $55 + 10 \log (P)$ dB on all frequencies more than X megahertz from the channel edge, where X is the greater of 6 megahertz or the actual emission bandwidth as defined in paragraph (m)(6) of this section. In addition, the attenuation factor shall not be less that $43 + 10 \log (P)$ dB on all frequencies between 2490.5 MHz and 2496 MHz and $55 + 10 \log (P)$ dB at or below 2490.5 MHz. Mobile Satellite Service licensees operating on frequencies below 2495 MHz may also submit a documented interference complaint against BRS licensees operating on channel BRS Channel 1 on the same terms and conditions as adjacent channel BRS or EBS licensees. For mobile digital stations, in the 1 megahertz bands immediately outside and adjacent to the frequency block a resolution bandwidth of at least two percent may be employed.

3.4.2 TEST SETUP

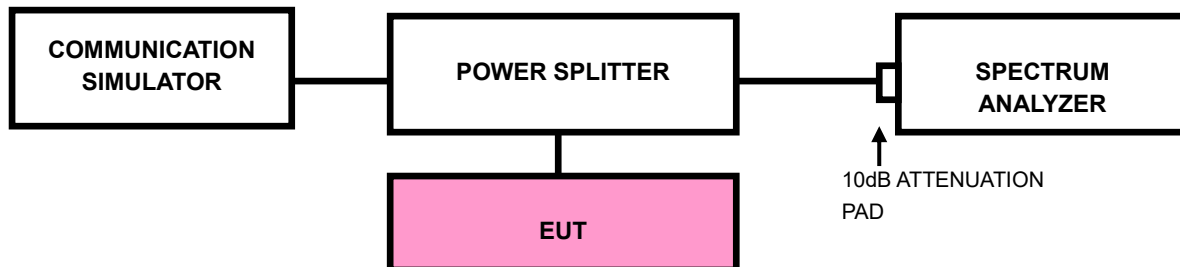



3.4.3 TEST PROCEDURES

- a. The EUT was set up for the maximum peak power with LTE link data modulation. The power was measured with R&S Spectrum Analyzer. All measurements were done at 2 channels (low and high operational frequency range.).
- b. The band edge measurement used the power splitter via EUT RF power connector between simulation base station and spectrum analyzer.
- c. The center frequency of spectrum is the band edge frequency and span is 35MHz. RBW of the spectrum is 100kHz and VBW of the spectrum is 300kHz (Channel bandwidth 5MHz).
- d. The center frequency of spectrum is the band edge frequency and span is 50MHz. RBW of the spectrum is 200kHz and VBW of the spectrum is 1MHz (Channel bandwidth 10MHz).
- e. The center frequency of spectrum is the band edge frequency and span is 60MHz. RBW of the spectrum is 300kHz and VBW of the spectrum is 1MHz (Channel bandwidth 15MHz).
- f. The center frequency of spectrum is the band edge frequency and span is 80MHz. RBW of the spectrum is 500kHz and VBW of the spectrum is 2MHz (Channel bandwidth 20MHz).
- g. Record the max trace plot into the test report.



Test Report No.: RFA210218W001-5

3.4.4 TEST RESULTS

WCDMA BAND 4

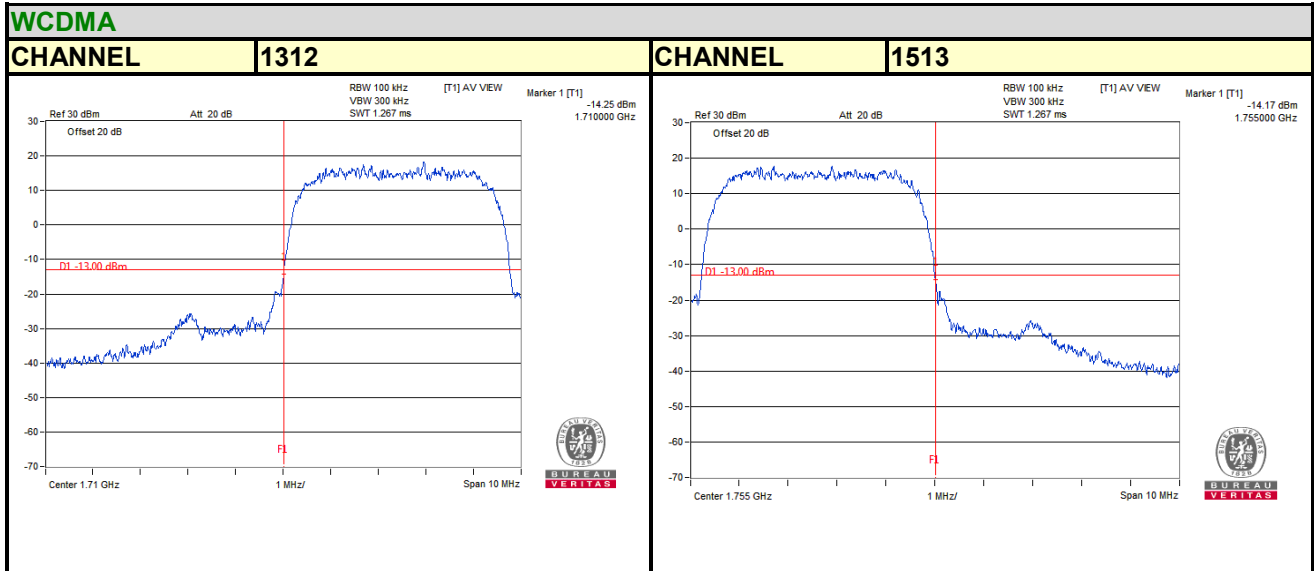



BUREAU VERITAS

Test Report No.: RFA210218W001-5

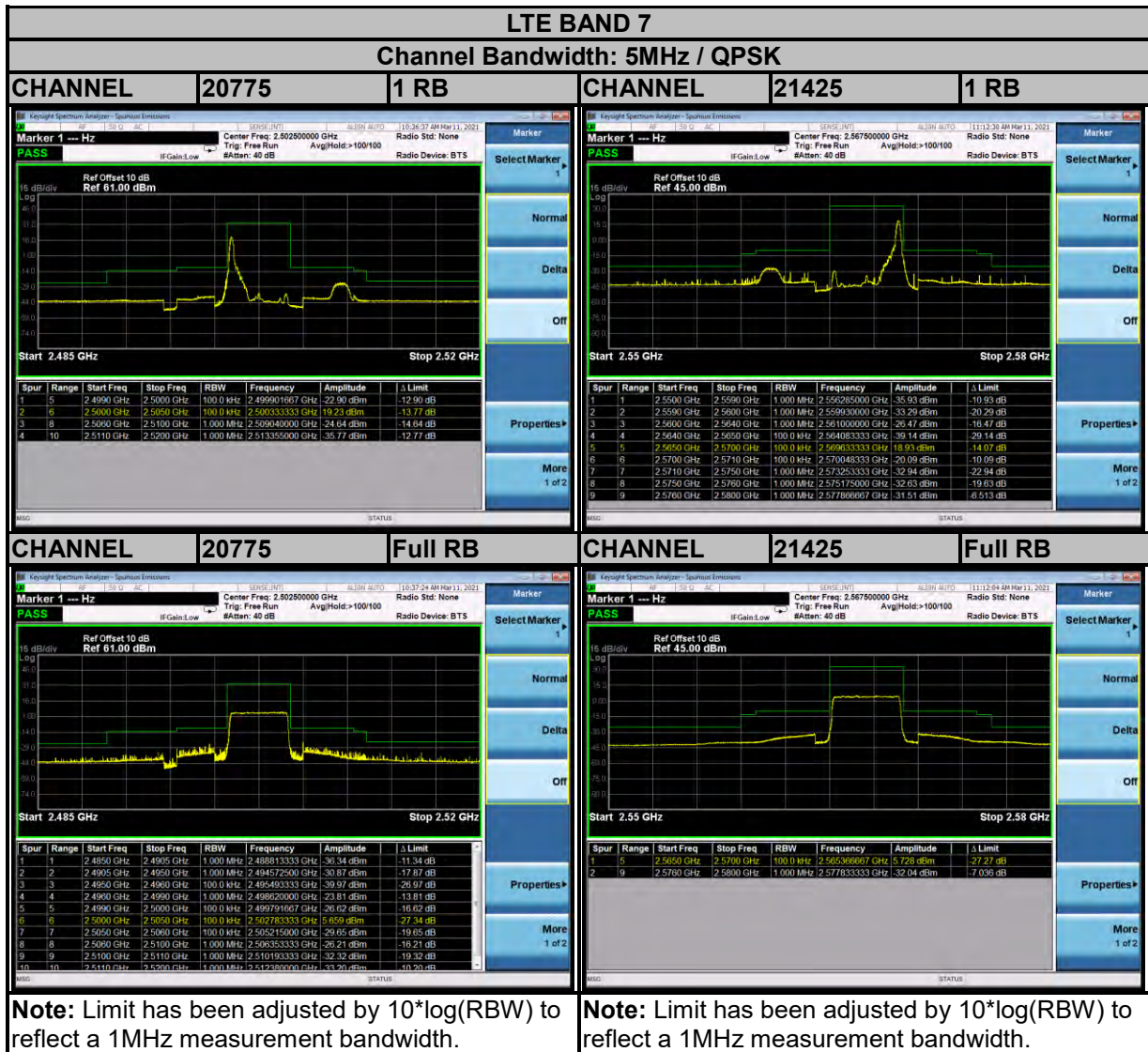



**BUREAU
VERITAS**

Test Report No.: RFA210218W001-5

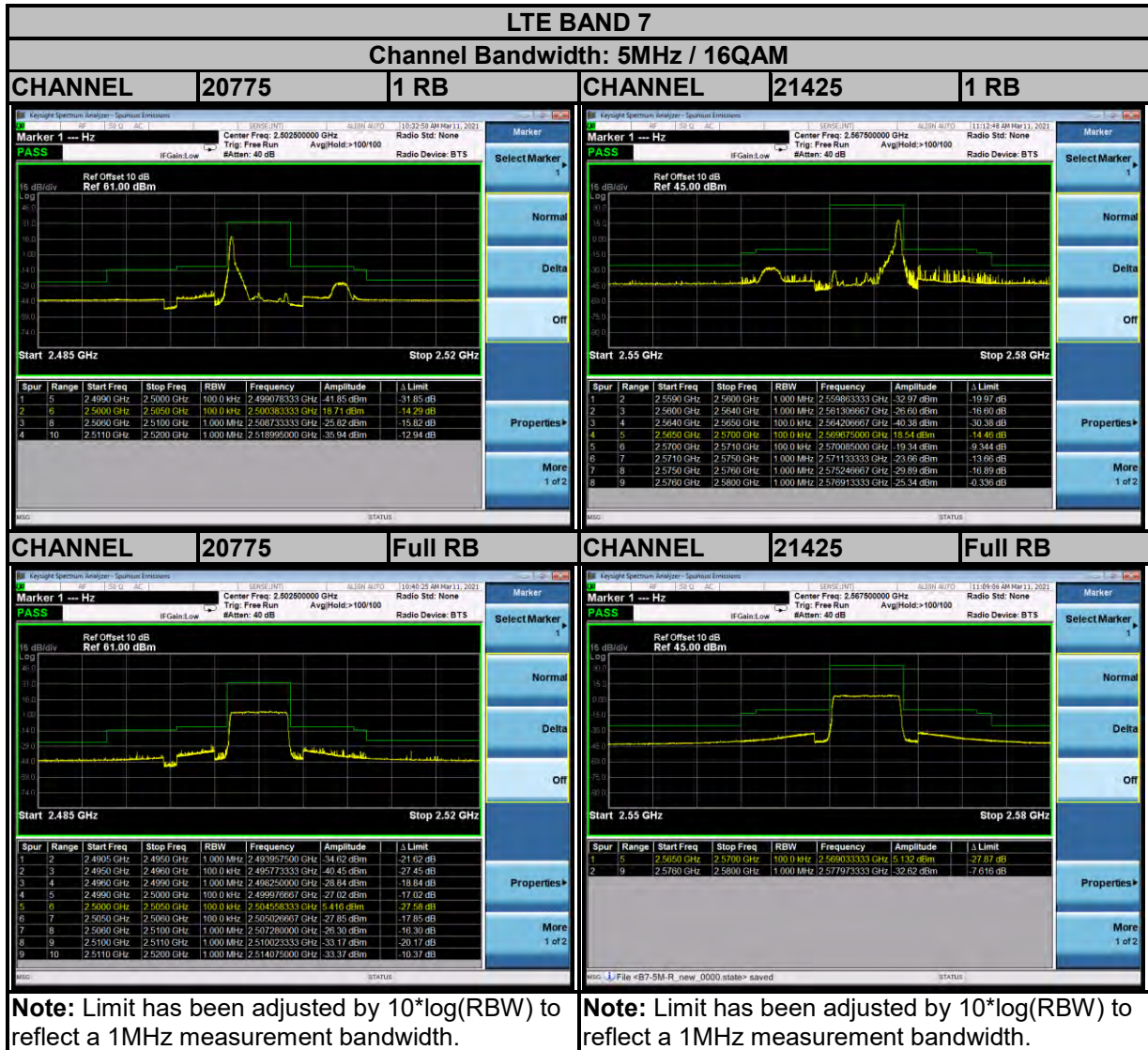



**BUREAU
VERITAS**

Test Report No.: RFA210218W001-5

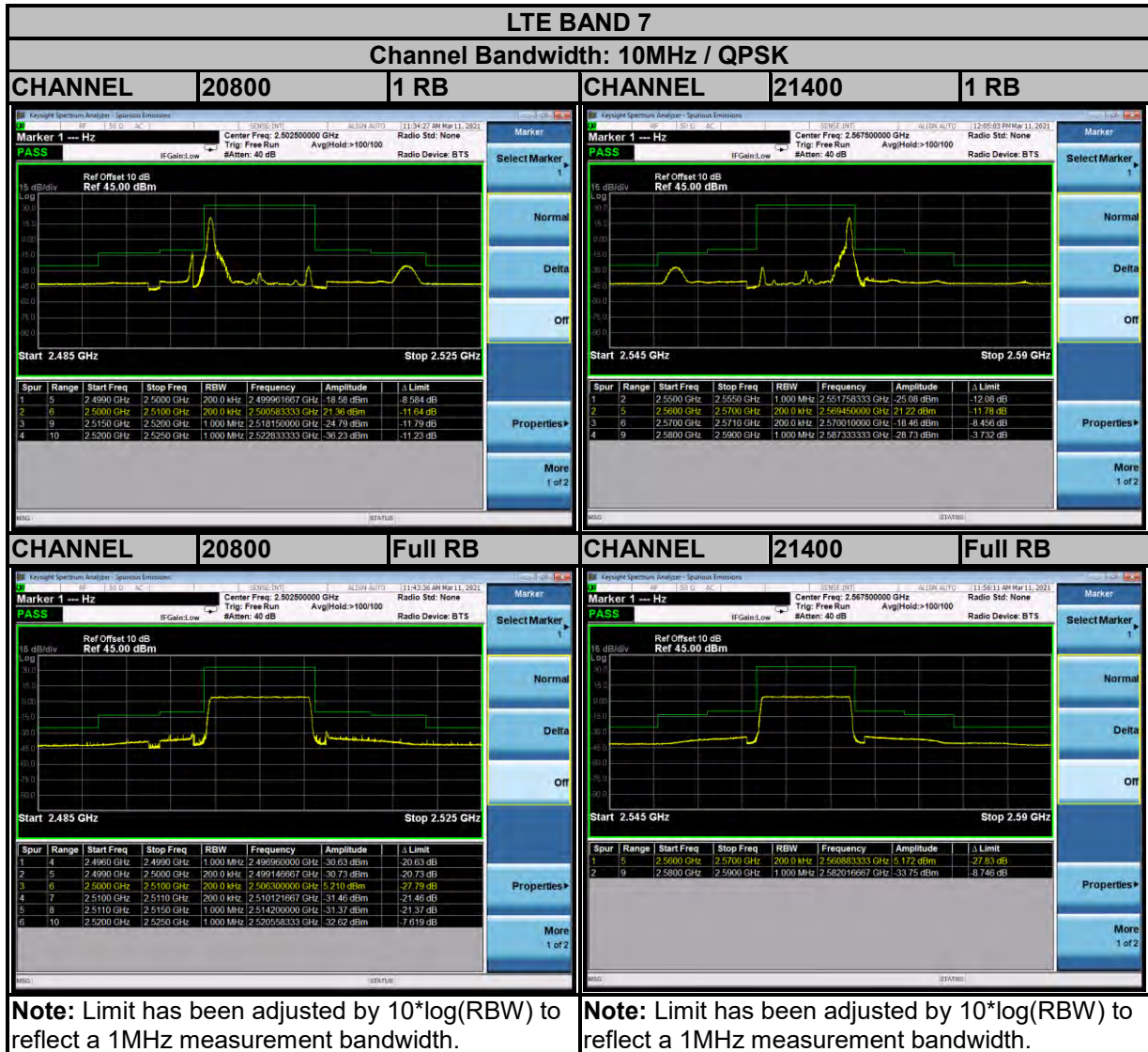



Test Report No.: RFA210218W001-5

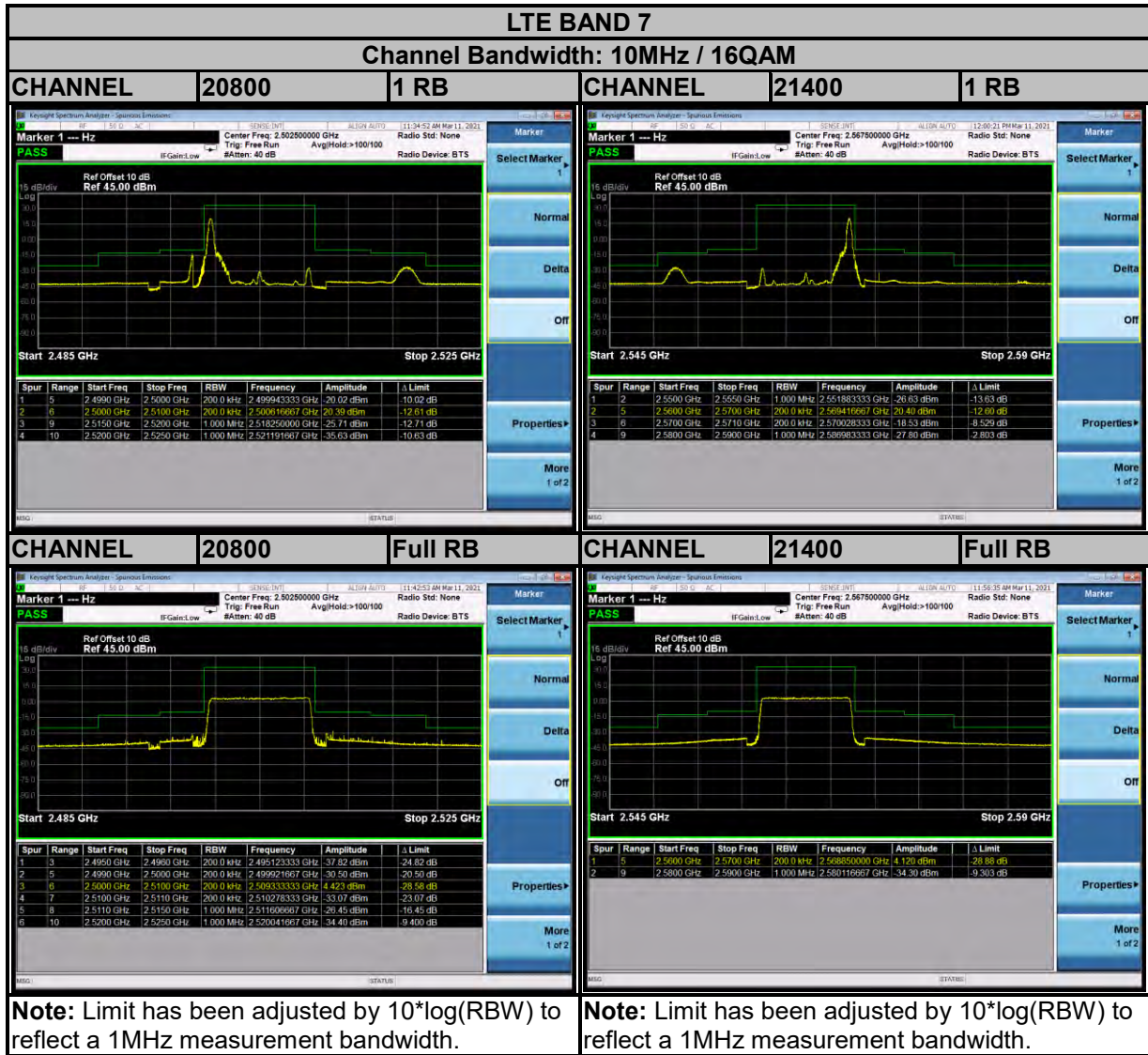

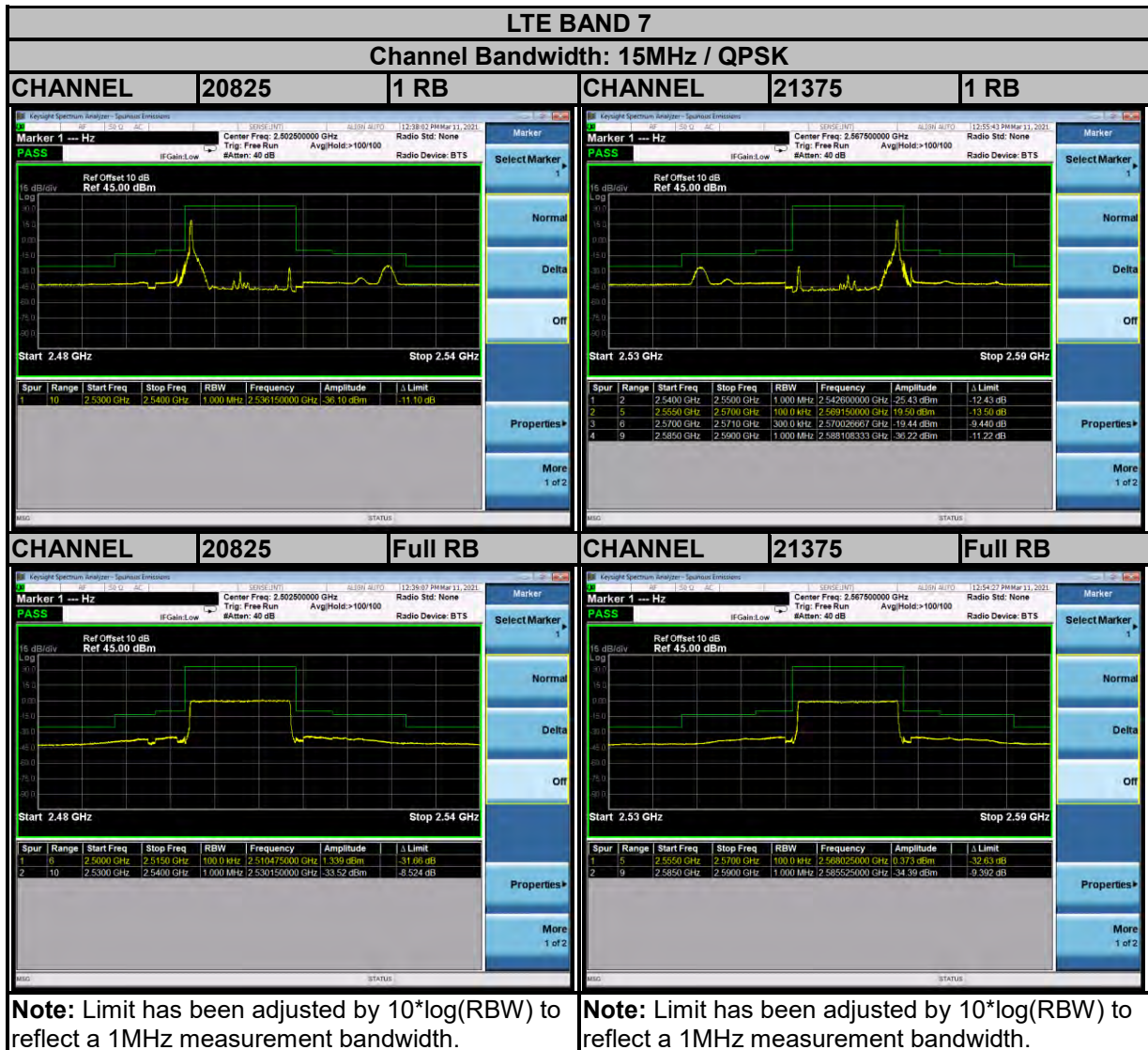



Test Report No.: RFA210218W001-5





Test Report No.: RFA210218W001-5

