

# FCC TEST REPORT

## (Part 15, Subpart E)



Applicant:	Lenovo (Shanghai) Electronics Technology Co., Ltd.
Address:	Section 304-305, Building No. 4, # 222, Meiyue Road, China (Shanghai) Pilot Free Trade Zone

Manufacturer or Supplier:	Lenovo PC HK Limited
Address:	23/F, Lincoln House, Taikoo Place 979 King's Road, Quarry Bay, Hong Kong, China
Product:	Tablet Computer
Brand Name:	Lenovo
Model Name:	Lenovo TB-X6C6NBL
FCC ID:	O57TBX6C6NBL
Date of tests:	Feb. 23, 2021 ~ Jun. 23, 2021

The tests have been carried out according to the requirements of the following standard:

**FCC Part 15, Subpart E, Section 15.407**

**CONCLUSION: The submitted sample was found to COMPLY with the test requirement**

Prepared by Simon Wang Engineer / Mobile Department	Approved by Luke Lu Manager / Mobile Department
 Date: Jun. 24, 2021	 Date: Jun. 24, 2021

This report is governed by, and incorporates by reference, CPS Conditions of Service as posted at the date of issuance of this report at <http://www.bureauveritas.com/home/about-us/our-business/cps/about-us/terms-conditions> and is intended for your exclusive use. Any copying or replication of this report to or for any other person or entity, or use of our name or trademark, is permitted only with our prior written permission. This report sets forth our findings solely with respect to the test samples identified herein. The results set forth in this report are not indicative or representative of the quality or characteristics of the lot from which a test sample was taken or any similar or identical product unless specifically and expressly noted. Our report includes all of the tests requested by you and the results thereof based upon the information that you provided to us. Measurement uncertainty is only provided upon request for accredited tests. You have 60 days from date of issuance of this report to notify us of any material error or omission caused by our negligence or if you require measurement uncertainty; provided, however, that such notice shall be in writing and shall specifically address the issue you wish to raise. A failure to raise such issue within the prescribed time shall constitute your unqualified acceptance of the completeness of this report, the tests conducted and the correctness of the report contents.



## TABLE OF CONTENTS

<b>RELEASE CONTROL RECORD .....</b>	<b>4</b>
1 SUMMARY OF TEST RESULTS .....	5
1.1 MEASUREMENT UNCERTAINTY .....	5
2 GENERAL INFORMATION.....	6
2.1 GENERAL DESCRIPTION OF EUT .....	6
2.2 DESCRIPTION OF TEST MODES .....	8
2.2.1 TEST MODE APPLICABILITY AND TESTED CHANNEL DETAIL.....	10
2.3 DUTY CYCLE OF TEST SIGNAL .....	15
2.4 DESCRIPTION OF SUPPORT UNITS .....	17
2.4.1 CONFIGURATION OF SYSTEM UNDER TEST .....	18
2.5 GENERAL DESCRIPTION OF APPLIED STANDARDS .....	18
<b>3 TEST TYPES AND RESULTS.....</b>	<b>19</b>
3.1 RADIATED EMISSION AND BANDEDGE MEASUREMENT.....	19
3.1.1 LIMITS OF RADIATED EMISSION AND BANDEDGE MEASUREMENT.....	19
3.1.2 LIMITS OF UNWANTED EMISSION.....	19
3.1.3 TEST INSTRUMENTS.....	20
3.1.4 TEST PROCEDURES .....	21
3.1.5 DEVIATION FROM TEST STANDARD .....	21
3.1.6 TEST SETUP .....	22
3.1.7 EUT OPERATING CONDITION .....	23
3.1.8 TEST RESULTS .....	24
3.2 OUT OF BAND EMISSION MEASUREMENT .....	105
3.2.1 LIMITS OF OUT OF BAND EMISSION MEASUREMENT.....	105
3.2.2 TEST INSTRUMENTS.....	106
3.2.3 TEST PROCEDURES .....	106
3.2.4 DEVIATION FROM TEST STANDARD .....	106
3.2.5 TEST SETUP .....	106
3.2.6 EUT OPERATING CONDITION .....	106
3.2.7 TEST RESULTS .....	107
3.3 CONDUCTED EMISSION MEASUREMENT .....	119
3.3.1 LIMITS OF CONDUCTED EMISSION MEASUREMENT .....	119
3.3.2 TEST INSTRUMENTS.....	119
3.3.3 TEST PROCEDURES .....	119



3.3.4	DEVIATION FROM TEST STANDARD .....	120
3.3.5	TEST SETUP .....	120
3.3.6	EUT OPERATING CONDITIONS .....	120
3.3.7	TEST RESULTS .....	121
3.4	MAXIMUM CONDUCTED OUTPUT POWER MEASUREMENT .....	123
3.4.1	LIMITS OF MAXIMUM CONDUCTED OUTPUT POWER MEASUREMENT .....	123
3.4.2	TEST SETUP .....	124
3.4.3	TEST INSTRUMENTS .....	124
3.4.4	TEST PROCEDURE .....	125
3.4.5	DEVIATION FROM TEST STANDARD .....	127
3.4.6	EUT OPERATING CONDITIONS .....	127
3.4.7	TEST RESULTS .....	128
3.5	MAXIMUM POWER SPECTRAL DENSITY MEASUREMENT .....	145
3.5.1	LIMITS OF MAXIMUM POWER SPECTRAL DENSITY MEASUREMENT .....	145
3.5.2	TEST SETUP .....	145
3.5.3	TEST INSTRUMENTS .....	145
3.5.4	TEST PROCEDURES .....	146
3.5.5	DEVIATION FROM TEST STANDARD .....	146
3.5.6	EUT OPERATING CONDITIONS .....	146
3.5.7	TEST RESULTS .....	147
<b>4</b>	<b>PHOTOGRAPHS OF THE TEST CONFIGURATION .....</b>	<b>156</b>
<b>5</b>	<b>APPENDIX A – MODIFICATIONS RECORDERS FOR ENGINEERING CHANGES TO THE EUT BY THE LAB .....</b>	<b>157</b>



**BUREAU**  
**VERITAS**

Test Report No.: RF210603W002-6

## RELEASE CONTROL RECORD

ISSUE NO.	REASON FOR CHANGE	DATE ISSUED
RF210603W002-6	Original release	Jun. 24, 2021



# 1 SUMMARY OF TEST RESULTS

The EUT has been tested according to the following specifications:

APPLIED STANDARD: FCC PART 15, SUBPART E		
STANDARD SECTION	TEST TYPE AND LIMIT	RESULT
15.407(b)(6)	AC Power Conducted Emission	Compliance
15.407(b) (1/2/3/4/5)	Radiated Emission & Band Edge Measurement	Compliance
15.407(a/1/2/3)	Maximum conducted output Power	Compliance
15.407(a/1/2/3)	Peak Power Spectral Density	Compliance
15.403(i)	26 dB Bandwidth	Compliance
15.407(e)	6 dB Bandwidth	Compliance
15.203	Antenna Requirement	Compliance

## 1.1 MEASUREMENT UNCERTAINTY

Where relevant, the following measurement uncertainty levels have been estimated for tests performed on the EUT as specified in CISPR 16-4-2:

MEASUREMENT	UNCERTAINTY
AC Power Conducted emissions	±2.70dB
Radiated emissions (30MHz~1GMHz)	±4.98dB
Radiated emissions (1GMHz ~6GMHz)	±4.70dB
Radiated emissions (6GMHz ~18GMHz)	±4.60dB
Radiated emissions (18GMHz ~40GMHz)	±4.12dB
Conducted emissions	±4.01dB
Occupied Channel Bandwidth	±43.58KHz
Conducted Output power	±2.06dB
Power Spectral Density	±0.85 dB

This uncertainty represents an expanded uncertainty expressed at approximately the 95% confidence level using a coverage factor of k = 2.



## 2 GENERAL INFORMATION

### 2.1 GENERAL DESCRIPTION OF EUT

<b>PRODUCT</b>	Tablet Computer
<b>BRAND NAME</b>	Lenovo
<b>MODEL NAME</b>	Lenovo TB-X6C6NBL
<b>NOMINAL VOLTAGE</b>	DC12V
<b>MODULATION</b>	OFDM
<b>TRANSFER RATE</b>	802.11a: 54.0/ 48.0/ 36.0/ 24.0/ 18.0/ 12.0/ 9.0/ 6.0Mbps 802.11n: up to MCS7 802.11ac: up to 390.0Mbps
<b>OPERATING FREQUENCY</b>	5180 ~ 5240MHz, 5260 ~ 5320MHz, 5500 ~ 5720MHz, 5745 ~ 5825MHz
<b>NUMBER OF CHANNEL</b>	5180 ~ 5240MHz: 4 for 802.11a, 802.11n, 802.11ac (20MHz) 2 for 802.11n, 802.11ac (40MHz) 1 for 802.11ac (80MHz) 5260 ~ 5320MHz: 4 for 802.11a, 802.11n, 802.11ac (20MHz) 2 for 802.11n, 802.11ac (40MHz) 1 for 802.11ac (80MHz) 5500 ~ 5720MHz: 12 for 802.11a, 802.11n, 802.11ac(20MHz) 6 for 802.11n, 802.11ac (40MHz) 3 for 802.11ac (80MHz) 5745 ~ 5825MHz: 5 for 802.11a, 802.11n, 802.11ac (20MHz) 3 for 802.11n, 802.11ac (40MHz) 2 for 802.11ac (80MHz)
<b>AVERAGE POWER</b>	84.72mW for 5180 ~ 5240MHz 82.22mW for 5260 ~ 5320MHz 85.11mW for 5500 ~ 5720MHz 81.28mW for 5745 ~ 5825MHz
<b>ANTENNA TYPE</b>	PIFA Antenna
<b>ANTENNA GAIN</b>	-1.64 dBi for 5180 ~ 5240MHz -1.66 dBi for 5260 ~ 5320MHz -2.12 dBi for 5500 ~ 5720MHz -2.65dBi for 5745 ~ 5825MHz
<b>HW VERSION</b>	Lenovo TB-X6C6NBL
<b>SW VERSION</b>	TB-X6C6NBL_RF01_210930
<b>I/O PORTS</b>	Refer to user's manual
<b>CABLE SUPPLIED</b>	N/A



**NOTE:**

1. For a more detailed features description, please refer to the manufacturer's specifications or the user's manual.
2. The EUT incorporates a SISO function. Physically, the EUT provides one completed transmitter and one receiver.

<b>MODULATION MODE</b>	<b>TX FUNCTION</b>
<b>802.11a</b>	1TX/1RX
<b>802.11n/802.11ac (20MHz)</b>	1TX/1RX
<b>802.11n/802.11ac (40MHz)</b>	1TX/1RX
<b>802.11ac (80MHz)</b>	1TX/1RX

3. For the test results, the EUT had been tested with all conditions. But only the worst case was shown in test report.



## 2.2 DESCRIPTION OF TEST MODES

### FOR 5180 ~ 5240MHz

4 channels are provided for 802.11a, 802.11n, 802.11ac (20MHz):

CHANNEL	FREQUENCY	CHANNEL	FREQUENCY
36	5180 MHz	44	5220 MHz
40	5200 MHz	48	5240 MHz

2 channels are provided for 802.11n, 802.11ac (40MHz):

CHANNEL	FREQUENCY	CHANNEL	FREQUENCY
38	5190 MHz	46	5230 MHz

1 channel is provided for 802.11ac (80MHz):

CHANNEL	FREQUENCY	CHANNEL	FREQUENCY
42	5210 MHz		

### FOR 5260 ~ 5320MHz

4 channels are provided for 802.11a, 802.11n, 802.11ac (20MHz):

CHANNEL	FREQUENCY	CHANNEL	FREQUENCY
52	5260 MHz	60	5300 MHz
56	5280 MHz	64	5320 MHz

2 channels are provided for 802.11n, 802.11ac (40MHz):

CHANNEL	FREQUENCY	CHANNEL	FREQUENCY
54	5270 MHz	62	5310 MHz

1 channel is provided for 802.11ac (80MHz):

CHANNEL	FREQUENCY	CHANNEL	FREQUENCY
58	5290 MHz		





**FOR 5500 ~ 5720MHz**

12 channels are provided for 802.11a, 802.11n, 802.11ac (20MHz):

CHANNEL	FREQUENCY	CHANNEL	FREQUENCY
100	5500 MHz	124	5620MHz
104	5520 MHz	128	5640MHz
108	5540 MHz	132	5660 MHz
112	5560 MHz	136	5680 MHz
116	5580 MHz	140	5700 MHz
120	5600 MHz	144	5720 MHz

6 channels are provided for 802.11n, 802.11ac (40MHz):

CHANNEL	FREQUENCY	CHANNEL	FREQUENCY
102	5510 MHz	126	5630MHz
110	5550 MHz	134	5670 MHz
118	5590 MHz	142	5710 MHz

3 channel is provided for 802.11ac (80MHz):

CHANNEL	FREQUENCY	CHANNEL	FREQUENCY
106	5530 MHz	138	5690 MHz
122	5610 MHz		

**FOR 5745 ~ 5825MHz**

5 channels are provided for 802.11a, 802.11n, 802.11ac (20MHz):

CHANNEL	FREQUENCY	CHANNEL	FREQUENCY
144	5720MHz	157	5785 MHz
149	5745 MHz	165	5825 MHz
153	5765 MHz		

3 channels are provided for 802.11n, 802.11ac (40MHz):

CHANNEL	FREQUENCY	CHANNEL	FREQUENCY
142	5710 MHz	159	5795 MHz
151	5755 MHz		

2 channel is provided for 802.11ac (80MHz):

CHANNEL	FREQUENCY	CHANNEL	FREQUENCY
138	5690MHz	155	5775 MHz



### 2.2.1 TEST MODE APPLICABILITY AND TESTED CHANNEL DETAIL

EUT CONFIGURE MODE	APPLICABLE TO				DESCRIPTION
	RE≥1G	RE<1G	PLC	APCM	
A	√	√	√	-	Powered by Adapter with wifi(5G) link
B	-	-	-	√	Powered by Battery with wifi(5G) link
C	-	-	-	-	Powered by USB with wifi(5G) link

Where **RE≥1G**: Radiated Emission above 1GHz      **RE<1G**: Radiated Emission below 1GHz  
**PLC**: Power Line Conducted Emission      **APCM**: Antenna Port Conducted Measurement

**NOTE:**  
The EUT had been pre-tested on the positioned of each 3 axis. The worst case was found when positioned on **X-plane**.  
**NOTE:** "-" means no effect.

#### RADIATED EMISSION TEST (BELOW 1GHz):

- Pre-Scan has been conducted to determine the worst-case mode from all possible combinations between available modulations, data rates and antenna ports (if EUT with antenna diversity architecture).
- Following channel(s) was (were) selected for the final test as listed below.

EUT CONFIGURE MODE	MODE	FREQ. BAND (MHz)	AVAILABLE CHANNEL	TESTED CHANNEL	MODULATION	DATA RATE (Mbps)
A	802.11n (20MHz)	5180-5240	36 to 48	48	OFDM	MCS0



**RADIATED EMISSION TEST (ABOVE 1GHz):**

- Pre-Scan has been conducted to determine the worst-case mode from all possible combinations between available modulations, data rates and antenna ports (if EUT with antenna diversity architecture).
- Following channel(s) was (were) selected for the final test as listed below.

EUT CONFIGURE MODE	MODE	FREQ. BAND (MHz)	AVAILABLE CHANNEL	TESTED CHANNEL	MODULATION	DATA RATE (Mbps)
A	802.11a	5180-5240	36 to 48	36, 40, 48	OFDM	6.0
A	802.11n (20MHz)		36 to 48	36, 40, 48	OFDM	MCS0
A	802.11n (40MHz)		38 to 46	38, 46	OFDM	MCS0
A	802.11ac (20MHz)		36 to 48	36, 40, 48	OFDM	MCS0
A	802.11ac (40MHz)		38 to 46	38, 46	OFDM	MCS0
A	802.11ac (80MHz)		42	42	OFDM	MCS0
A	802.11a	5260-5320	52 to 64	52, 60, 64	OFDM	6.0
A	802.11n (20MHz)		52 to 64	52, 60, 64	OFDM	MCS0
A	802.11n (40MHz)		54 to 62	54, 62	OFDM	MCS0
A	802.11ac (20MHz)		52 to 64	52, 60, 64	OFDM	MCS0
A	802.11ac (40MHz)		54 to 62	54, 62	OFDM	MCS0
A	802.11ac (80MHz)		58	58	OFDM	MCS0
A	802.11a	5500-5720	100 to 144	100, 116, 140, 144	OFDM	6.0
A	802.11n (20MHz)		100 to 144	100, 116, 140, 144	OFDM	MCS0
A	802.11n (40MHz)		102 to 142	102, 110, 134, 142	OFDM	MCS0
A	802.11ac (20MHz)		100 to 144	100, 116, 140, 144	OFDM	MCS0
A	802.11ac (40MHz)		102 to 142	102, 110, 134, 142	OFDM	MCS0
A	802.11ac (80MHz)		106 to 138	106, 138	OFDM	MCS0
A	802.11a	5745-5825	144 to 165	144, 149, 157,165	OFDM	6.0
A	802.11n (20MHz)		144 to 165	144, 149, 157,165	OFDM	MCS0
A	802.11ac (40MHz)		142 to 159	142, 151, 159	OFDM	MCS0
A	802.11ac (20MHz)		144 to 165	144, 149, 157,165	OFDM	MCS0
A	802.11n (40MHz)		142 to 159	142, 151, 159	OFDM	MCS0
A	802.11ac (80MHz)		138,155	138, 155	OFDM	MCS0



**POWER LINE CONDUCTED EMISSION TEST:**

- Pre-Scan has been conducted to determine the worst-case mode from all possible combinations between available modulations, data rates and antenna ports (if EUT with antenna diversity architecture).
- Following channel(s) was (were) selected for the final test as listed below.

EUT CONFIGURE MODE	MODE	FREQ. BAND (MHz)	AVAILABLE CHANNEL	TESTED CHANNEL	MODULATION	DATA RATE (Mbps)
A	802.11n (40MHz)	5180-5240	36 to 48	48	OFDM	MCS0

**BANDEDGE MEASUREMENT:**

- Pre-Scan has been conducted to determine the worst-case mode from all possible combinations between available modulations, data rates and antenna ports (if EUT with antenna diversity architecture).
- Following channel(s) was (were) selected for the final test as listed below.

EUT CONFIGURE MODE	MODE	FREQ. BAND (MHz)	AVAILABLE CHANNEL	TESTED CHANNEL	MODULATION	DATA RATE (Mbps)
A	802.11a	5180-5240	36 to 48	36, 48	36 to 48	6.0
A	802.11n (20MHz)		36 to 48	36, 48	36 to 48	MCS0
A	802.11n (40MHz)		38 to 46	38, 46	38 to 46	MCS0
A	802.11ac (20MHz)		36 to 48	36, 48	36 to 48	MCS0
A	802.11ac (40MHz)		38 to 46	38, 46	38 to 46	MCS0
A	802.11ac (80MHz)		42	42	42	MCS0
A	802.11a	5260-5320	52 to 64	52, 64	52 to 64	6.0
A	802.11n (20MHz)		52 to 64	52, 64	52 to 64	MCS0
A	802.11n (40MHz)		54 to 62	54, 62	54 to 62	MCS0
A	802.11ac (20MHz)		52 to 64	52, 64	52 to 64	MCS0
A	802.11ac (40MHz)		54 to 62	54, 62	54 to 62	MCS0
A	802.11ac (80MHz)		58	58	58	MCS0
A	802.11a	5500-5720	100 to 144	100, 116, 140, 144	100 to 144	6.0
A	802.11n (20MHz)		100 to 144	100, 116, 140, 144	100 to 144	MCS0
A	802.11n (40MHz)		102 to 142	102, 110, 134, 142	102 to 142	MCS0
A	802.11ac (20MHz)		100 to 144	100, 116, 140, 144	100 to 144	MCS0
A	802.11ac (40MHz)		102 to 142	102, 110, 134, 142	102 to 142	MCS0
A	802.11ac (80MHz)		106 to 138	106, 138	106 to 138	MCS0



EUT CONFIGURE MODE	MODE	FREQ. BAND (MHz)	AVAILABLE CHANNEL	TESTED CHANNEL	MODULATION	DATA RATE (Mbps)
A	802.11a	5745-5825	144 to 165	144, 149, 157,165	OFDM	6.0
A	802.11n (20MHz)		144 to 165	144, 149, 157,165	OFDM	MCS0
A	802.11n (40MHz)		142 to 159	142, 151, 159	OFDM	MCS0
A	802.11ac (20MHz)		144 to 165	144, 149, 157,165	OFDM	MCS0
A	802.11ac (40MHz)		142 to 159	142, 151, 159	OFDM	MCS0
A	802.11ac (80MHz)		138,155	138, 155	OFDM	MCS0

**ANTENNA PORT CONDUCTED MEASUREMENT:**

- This item includes all test value of each mode, but only includes spectrum plot of worst value of each mode.
- Pre-Scan has been conducted to determine the worst-case mode from all possible combinations between available modulations, data rates and antenna ports (if EUT with antenna diversity architecture).
- Following channel(s) was (were) selected for the final test as listed below.

EUT CONFIGURE MODE	MODE	FREQ. BAND (MHz)	AVAILABLE CHANNEL	TESTED CHANNEL	MODULATION	DATA RATE (Mbps)
A	802.11a	5180-5240	36 to 48	36, 40, 48	OFDM	6.0
A	802.11n (20MHz)		36 to 48	36, 40, 48	OFDM	MCS0
A	802.11n (40MHz)		38 to 46	38, 46	OFDM	MCS0
A	802.11ac (20MHz)		36 to 48	36, 40, 48	OFDM	MCS0
A	802.11ac (40MHz)		38 to 46	38, 46	OFDM	MCS0
A	802.11ac (80MHz)		42	42	OFDM	MCS0
A	802.11a	5260-5320	52 to 64	52, 60, 64	OFDM	6.0
A	802.11n (20MHz)		52 to 64	52, 60, 64	OFDM	MCS0
A	802.11n (40MHz)		54 to 62	54, 62	OFDM	MCS0
A	802.11ac (20MHz)		52 to 64	52, 60, 64	OFDM	MCS0
A	802.11ac (40MHz)		54 to 62	54, 62	OFDM	MCS0
A	802.11ac (80MHz)		58	58	OFDM	MCS0



A	802.11a	5500-5720	100 to 144	100, 116, 140, 144	OFDM	6.0
A	802.11n (20MHz)		100 to 144	100, 116, 140, 144	OFDM	MCS0
A	802.11n (40MHz)		102 to 142	102, 110, 134, 142	OFDM	MCS0
A	802.11ac (20MHz)		100 to 144	100, 116, 140, 144	OFDM	MCS0
A	802.11ac (40MHz)		102 to 142	102, 110, 134, 142	OFDM	MCS0
A	802.11ac (80MHz)		106 to 138	106, 138	OFDM	MCS0
A	802.11a	5745-5825	144 to 165	144, 149, 157,165	OFDM	6.0
A	802.11n (20MHz)		144 to 165	144, 149, 157,165	OFDM	MCS0
A	802.11n (40MHz)		142 to 159	142, 151, 159	OFDM	MCS0
A	802.11ac (20MHz)		144 to 165	144, 149, 157,165	OFDM	MCS0
A	802.11ac (40MHz)		142 to 159	142, 151, 159	OFDM	MCS0
A	802.11ac (80MHz)		138,155	138, 155	OFDM	MCS0

**TEST CONDITION:**

APPLICABLE TO	ENVIRONMENTAL CONDITIONS	INPUT POWER	TESTED BY
RE<1G	23deg. C, 70%RH	DC 12V	Star Le
RE≥1G	23deg. C, 70%RH	DC 12V	Star Le
PLC	25deg. C, 52%RH	DC 12V	Jimmy Liu
APCM	25deg. C, 60%RH	DC 12V	Lily Zhao



### 2.3 DUTY CYCLE OF TEST SIGNAL

Duty cycle of test signal is < 98%, duty factor shall be considered.

- 802.11a: Duty cycle = 100%, Duty factor shall not be considered
- 802.11n (20MHz): Duty cycle = 100%, Duty factor shall not be considered.
- 802.11n (40MHz): Duty cycle = 100%, Duty factor shall not be considered.
- 802.11ac (20MHz): Duty cycle = 100%, Duty factor shall not be considered
- 802.11ac (40MHz): Duty cycle = 100%, Duty factor shall not be considered
- 802.11ac (80MHz): Duty cycle = 100%, Duty factor shall not be considered

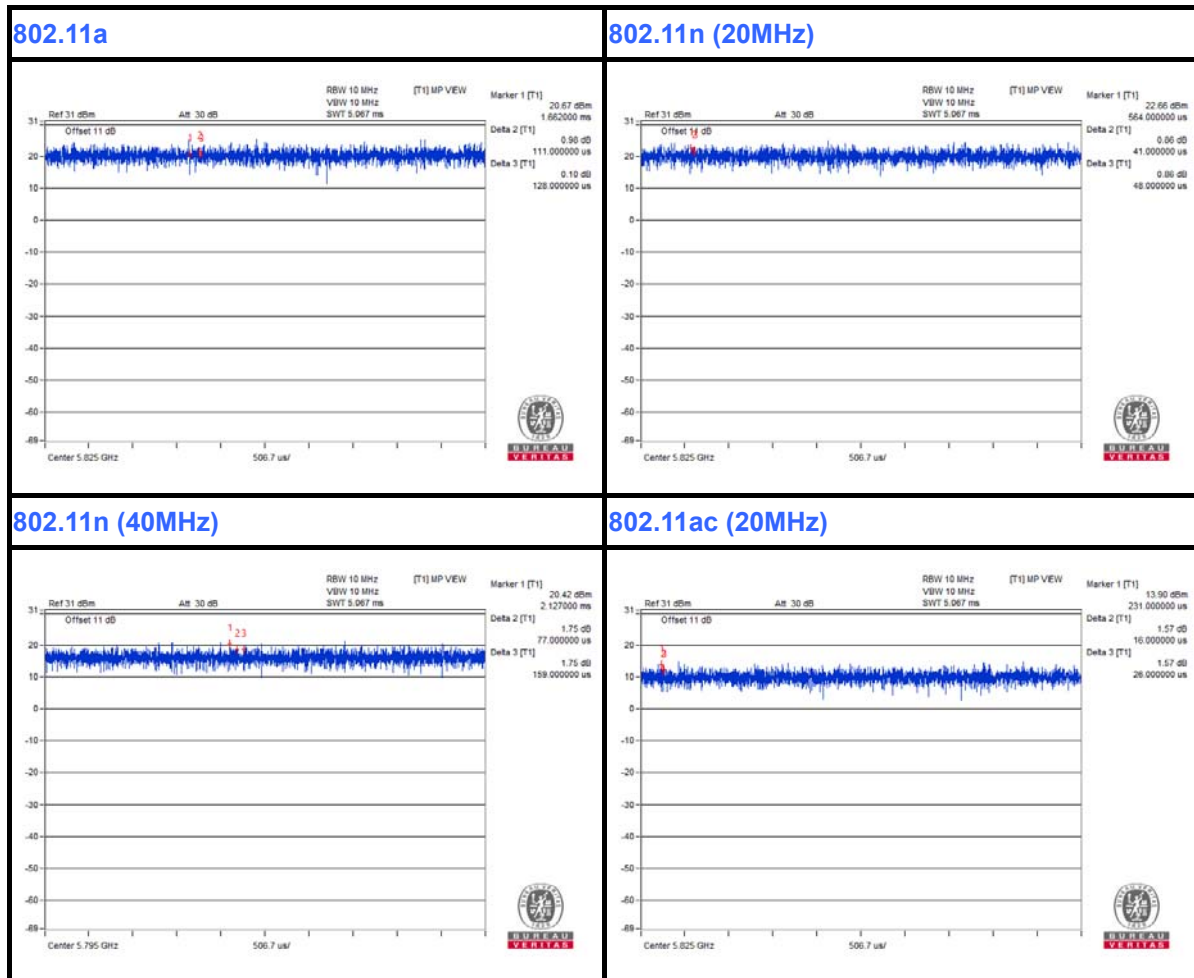



**BUREAU  
VERITAS**

Test Report No.: RF210603W002-6

### 802.11 ac (40MHz)

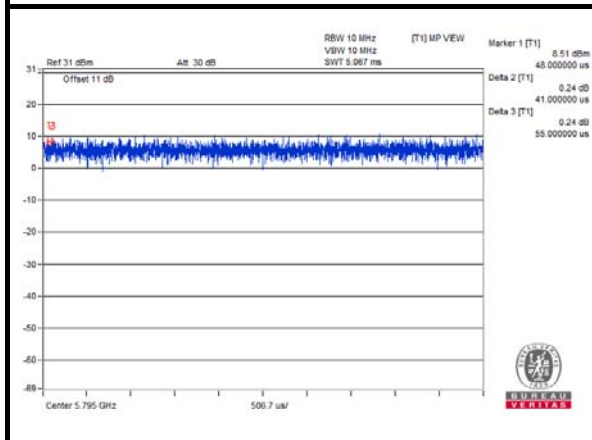

### 802.11ac (80MHz)

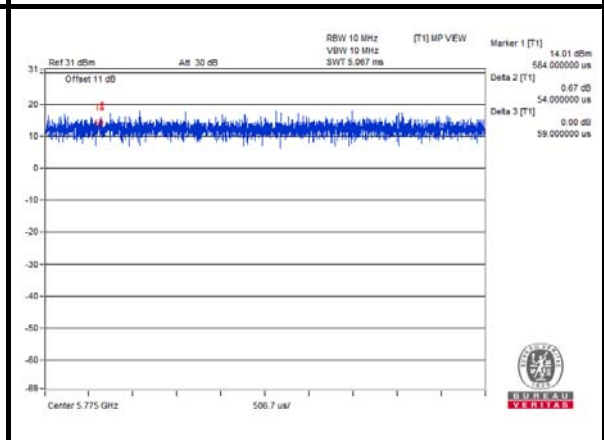





## 2.4 DESCRIPTION OF SUPPORT UNITS

The EUT has been tested as an independent unit together with other necessary accessories or support units. The following support units or accessories were used to form a representative test configuration during the tests.

NO.	PRODUCT	BRAND	MODEL NO.	SERIAL NO.	FCC ID
1	Desktop	Lenovo	M73 SFF	PC04GRQV	N/A
2	Desktop	Lenovo	M73 SFF	PC06CS27	N/A
3	Laptop	Lenovo	Thnikpad L440	R90FTFKN	N/A
4	DC source	Kikusui/JP	PMX18-5A	0000001	N/A

NO.	SIGNAL CABLE DESCRIPTION OF THE ABOVE SUPPORT UNITS
1	AC Line: Unshielded, Detachable 1.5m
2	AC Line: Unshielded, Detachable 1.5m
3	AC Line: Unshielded, Detachable 1.5m
4	DC Line: Unshielded, Detachable 1.0m



## 2.4.1 CONFIGURATION OF SYSTEM UNDER TEST

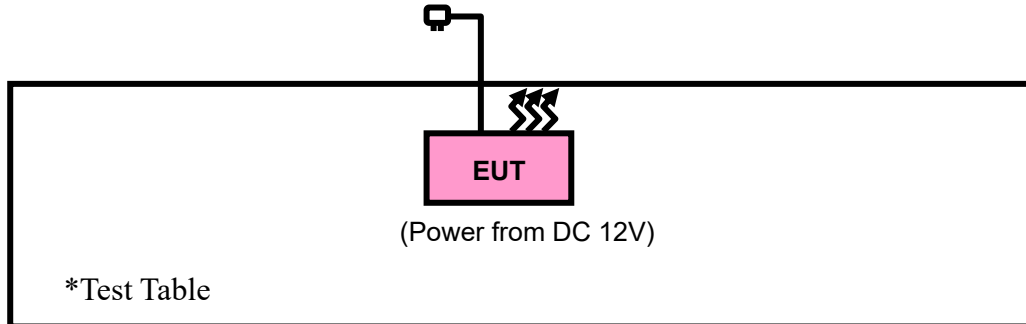

## 2.5 GENERAL DESCRIPTION OF APPLIED STANDARDS

The EUT is a RF Product. According to the specifications of the manufacturer, it must comply with the requirements of the following standards:

**FCC Part 15, Subpart E (15.407)**

**KDB 789033 D02 General U-NII Test Procedures New Rules v02r01**

**ANSI C63.10-2013**

All test items have been performed and recorded as per the above standards.

**NOTE:** The EUT is also considered as a kind of computer peripheral, because the connection to computer is necessary for typical use. It has been verified to comply with the requirements of FCC Part 15, Subpart B, Class B (Certification). The test report has been issued separately.



### 3 TEST TYPES AND RESULTS

#### 3.1 RADIATED EMISSION AND BANDEDGE MEASUREMENT

##### 3.1.1 LIMITS OF RADIATED EMISSION AND BANDEDGE MEASUREMENT

Radiated emissions which fall in the restricted bands must comply with the radiated emission limits specified as below table:

FREQUENCIES (MHz)	FIELD STRENGTH (microvolts/meter)	MEASUREMENT DISTANCE (meters)
0.009 ~ 0.490	2400/F(kHz)	300
0.490 ~ 1.705	24000/F(kHz)	30
1.705 ~ 30.0	30	30
30 ~ 88	100	3
88 ~ 216	150	3
216 ~ 960	200	3
Above 960	500	3

**NOTE:**

1. The lower limit shall apply at the transition frequencies.
2. Emission level (dBuV/m) = 20 log Emission level (uV/m).
3. For frequencies above 1000MHz, the field strength limits are based on average detector, however, the peak field strength of any emission shall not exceed the maximum permitted average limits, specified above by more than 20dB under any condition of modulation.

##### 3.1.2 LIMITS OF UNWANTED EMISSION

RESTRICTED BANDS	APPLICABLE TO	LIMIT	
	789033 D02 General UNII Test Procedures New Rules v02r01	FIELD STRENGTH AT 3m (dBµV/m)	
	PK : 74	AV : 54	
OUT OF THE RESTRICTED BANDS	APPLICABLE TO	EIRP LIMIT (dBm/MHz)	EQUIVALENT FIELD STRENGTH AT 3m (dBµV/m)
	15.407(b)(1)	PK : -27	PK : 68.3
	15.407(b)(2)		
	15.407(b)(3)		
15.407(b)(4)	See note 2 (FCC 16-24)		



**NOTE:** The following formula is used to convert the equipment isotropic radiated power (eirp) to field strength:

$$E = \frac{1000000\sqrt{30P}}{3} \mu\text{V/m, where P is the eirp (Watts).}$$

2. All emissions shall be limited to a level of -27 dBm/MHz at 75 MHz or more above or below the band edge increasing linearly to 10 dBm/MHz at 25 MHz above or below the band edge, and from 25 MHz above or below the band edge increasing linearly to a level of 15.6 dBm/MHz at 5 MHz above or below the band edge, and from 5 MHz above or below the band edge increasing linearly to a level of 27 dBm/MHz at the band edge.

### 3.1.3 TEST INSTRUMENTS

Equipment	Manufacturer	Model No.	Serial No.	Last Cal.	Next Cal.
3m Semi-anechoic Chamber	ETS-LINDGREN	9m*6m*6m	Euroshieldpn-CT0001143-1216	May. 19,20	May. 19,21
3m Semi-anechoic Chamber	ETS-LINDGREN	9m*6m*6m	Euroshieldpn-CT0001143-1216	May. 19,21	May. 19,22
Bilog Antenna	ETS-LINDGREN	3143B	00161965	Mar. 26,21	Mar. 25,22
Bilog Antenna	ETS-LINDGREN	3143B	00161965	Mar. 27,20	Mar. 26,21
Horn Antenna	ETS-LINDGREN	3117	00168728	Nov. 24, 20	Nov. 23, 21
Horn Antenna (18GHz-40GHz)	N/A	QWH-SL-18-40-K-SG/QMS-00361	15433	Nov. 24, 20	Nov. 23, 21
Test Software	E3	V 9.160323	N/A	N/A	N/A
Test Software	ADT	ADT_Radiated_V7.6.15.9.2	N/A	N/A	N/A
10dB Attenuator	JFW/USA	50HF-010-SMA	1505	Jun. 03,20	Jun. 02,21
10dB Attenuator	JFW/USA	50HF-010-SMA	1505	Jun. 03,21	Jun. 02,22
MXE EMI Receiver	KEYSIGHT	N9038A-544	MY54450026	Apr. 27,20	Apr. 26,21
MXE EMI Receiver	KEYSIGHT	N9038A-544	MY54450026	Apr. 27,21	Apr. 26,22
Signal Pre-Amplifier	EMSI	EMC 9135	980249	Jun. 02,20	Jun. 01,21
Signal Pre-Amplifier	EMSI	EMC 9135	980249	Jun. 02,21	Jun. 01,22
Signal Pre-Amplifier	EMSI	EMC 012645B	980257	Jun. 02,20	Jun. 01,21
Signal Pre-Amplifier	EMSI	EMC 012645B	980257	Jun. 02,21	Jun. 01,22
Signal Pre-Amplifier	EMSI	EMC 184045B	980259	Apr. 30,20	Apr. 29,21
Signal Pre-Amplifier	EMSI	EMC 184045B	980259	Apr. 30,21	Apr. 29,22
DC Source	Kikusui/JP	PMX18-5A	0000001	Aug. 26,20	Aug. 25,21

**NOTE:** 1. The calibration interval of the above test instruments is 12 months or 24 months and the calibrations are traceable to CEPREI/CHINA, GRGT/CHINA and NIM/CHINA.

2. The test was performed in 3m Chamber.

3. The FCC Site Registration No. is 525120; The Designation No. is CN1171.



### 3.1.4 TEST PROCEDURES

- a. The EUT was placed on the top of a rotating table 0.8 meters (for below 1GHz) / 1.5 meters (for above 1GHz) above the ground at 3 meter chamber room for test. The table was rotated 360 degrees to determine the position of the highest radiation.
- b. The EUT was set 3 meters away from the interference-receiving antenna, which was mounted on the top of a variable-height antenna tower.
- c. The antenna is a broadband antenna, and its height is varied from one meter to four meters above the ground to determine the maximum value of the field strength. Both horizontal and vertical polarizations of the antenna are set to make the measurement.
- d. For each suspected emission, the EUT was arranged to its worst case and then the antenna was tuned to heights from 1 meter to 4 meters and the rotatable table was turned from 0 degrees to 360 degrees to find the maximum reading.
- e. The test-receiver system was set to Peak Detect Function and Specified Bandwidth with Maximum Hold Mode.
- f. If the emission level of the EUT in peak mode was 10dB lower than the limit specified, then testing could be stopped and the peak values of the EUT would be reported. Otherwise the emissions that did not have 10dB margin would be re-tested one by one using peak, quasi-peak or average method as specified and then reported in a data sheet.

#### **NOTE:**

1. The resolution bandwidth and video bandwidth of test receiver/spectrum analyzer is 120kHz for Peak detection (PK) and Quasi-peak detection (QP) at frequency below 1GHz.
2. The resolution bandwidth of test receiver/spectrum analyzer is 1MHz and video bandwidth is 3MHz for Peak detection at frequency above 1GHz.
3. The resolution bandwidth of test receiver/spectrum analyzer is 1MHz and the video bandwidth is 3MHz for RMS Average (Duty cycle < 98%) for Average detection (AV) at frequency above 1GHz, then the measurement results was added to a correction factor ( $10 \log(1/\text{duty cycle})$ ).
4. The resolution bandwidth of test receiver/spectrum analyzer is 1MHz and the video bandwidth is 10Hz (Duty cycle  $\geq 98\%$ ) for Average detection (AV) at frequency above 1GHz.
5. All modes of operation were investigated and the worst-case emissions are reported.

### 3.1.5 DEVIATION FROM TEST STANDARD

No deviation.



### 3.1.6 TEST SETUP

< Frequency Range 30MHz~1GHz >

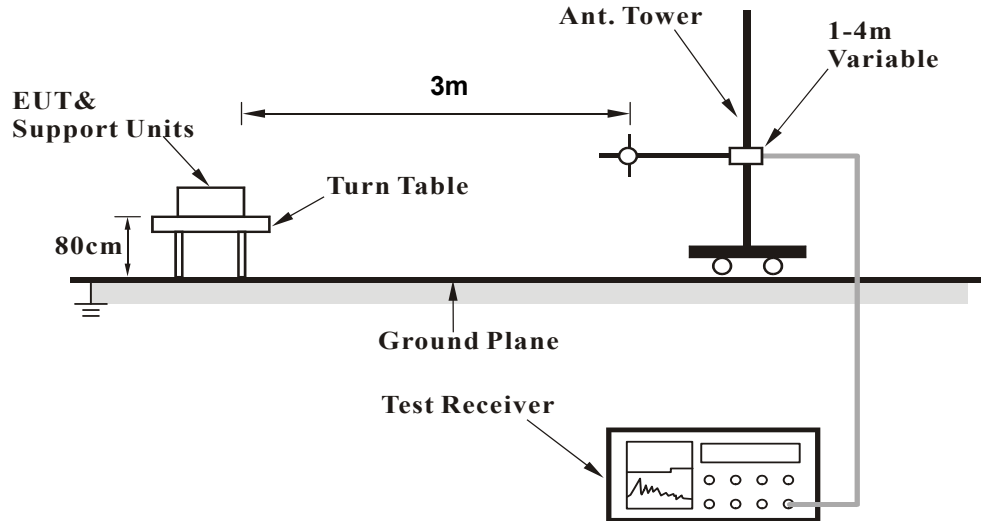

<Frequency Range above 1GHz>

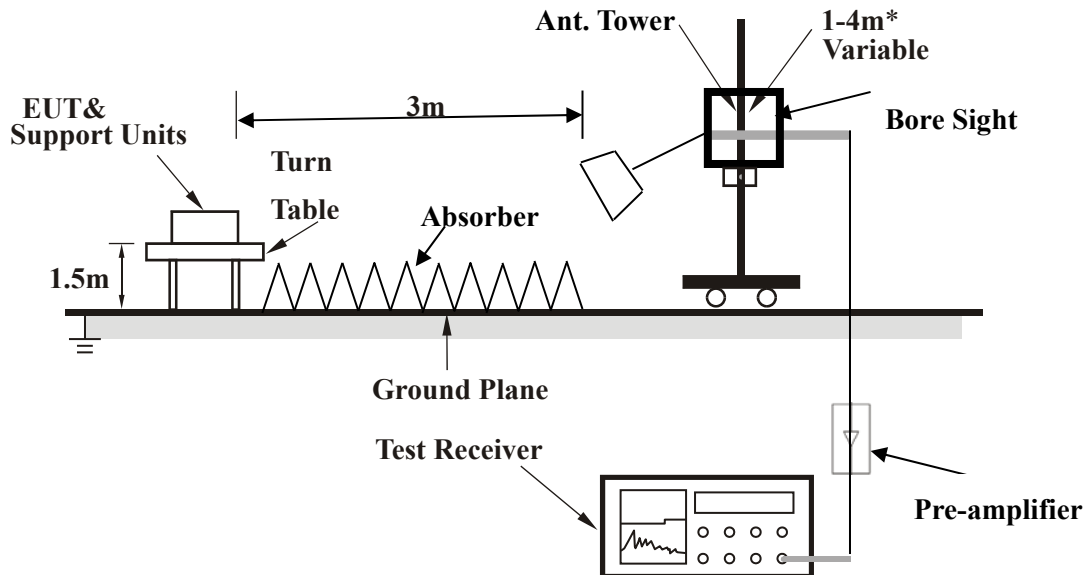

**Note:** Above 1G is a directional antenna

Depends on the EUT height and the antenna 3dB beamwidth both, refer to section 7.3 of CISPR 16-2-3.

For the actual test configuration, please refer to the attached file (Test Setup Photo).



### 3.1.7 EUT OPERATING CONDITION

- a. Set the EUT under full load condition and placed them on a testing table.
- b. Set the transmitter part of EUT under transmission condition continuously at specific channel frequency.
- c. The necessary accessories enable the EUT in full functions.



**3.1.8 TEST RESULTS**

**BELOW 1GHz WORST-CASE DATA:**

**30 MHz – 1GHz data:**

**Band 1**

**802.11ac (80MHz)**

<b>CHANNEL</b>	TX Channel 42	<b>DETECTOR FUNCTION</b>	Quasi-Peak (QP)
<b>FREQUENCY RANGE</b>	30MHz ~ 1GHz		

<b>ANTENNA POLARITY &amp; TEST DISTANCE: HORIZONTAL AT 3 M</b>										
<b>FREQ. (MHz)</b>	<b>EMISSION LEVEL (dBuV/m)</b>	<b>READ LEVEL (dBuV)</b>	<b>LIMIT (dBuV/m)</b>	<b>MARGIN (dB)</b>	<b>ANTENNA FACTOR (dB /m)</b>	<b>CABLE LOSS (dB)</b>	<b>PREAMP FACTOR (dB)</b>	<b>ANTENNA HEIGHT (cm)</b>	<b>TABLE ANGLE (Degree)</b>	<b>REMARK</b>
75.59	34.3	62.71	40	-5.7	7.81	1.12	37.34	100	0	Peak
214.3	27.45	50.54	43.5	-16.05	11.63	1.86	36.58	100	0	Peak
288.99	36.01	56.76	46	-9.99	13.82	2.16	36.73	100	0	Peak
377.26	26.22	44.32	46	-19.78	16.24	2.47	36.81	100	0	Peak
500.45	28.55	43.91	46	-17.45	18.71	2.93	37	100	0	Peak
663.41	28.08	40.15	46	-17.92	21.97	3.43	37.47	100	0	Peak

**REMARKS:**

1. Emission level (dBuV/m) = Read level (dBuV) + Correction Factor (dB/m).
2. Correction Factor (dB/m) = Antenna Factor (dB/m) + Cable Factor (dB).
3. The other emission levels were very low against the limit.
4. Margin value = Emission level – Limit value.

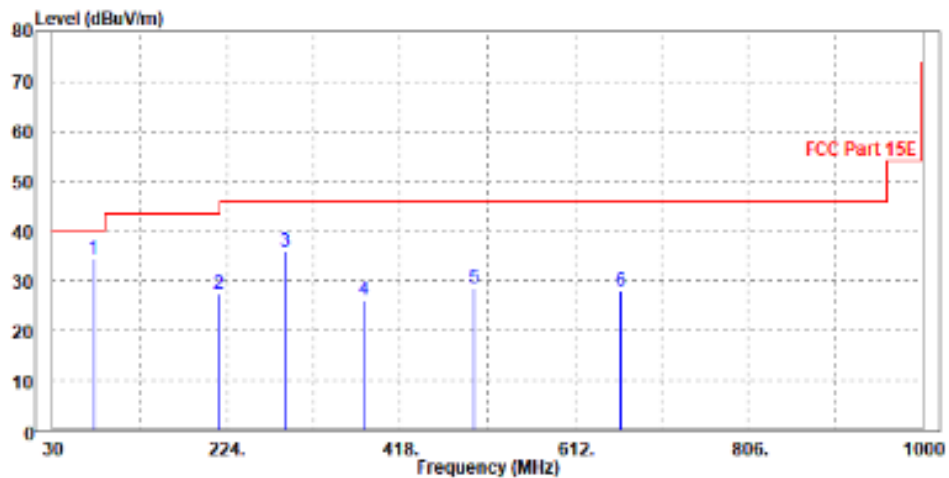





<b>CHANNEL</b>	Channel 42	<b>DETECTOR FUNCTION</b>	Quasi-Peak (QP)
<b>FREQUENCY RANGE</b>	30MHz ~ 1GHz		

ANTENNA POLARITY & TEST DISTANCE: VERTICAL AT 3 M										
FREQ. (MHz)	EMISSION LEVEL (dBuV/m)	READ LEVEL (dBuV)	LIMIT (dBuV/m)	MARGIN (dB)	ANTENNA FACTOR (dB /m)	CABLE LOSS (dB)	PREAMP FACTOR (dB)	ANTENNA HEIGHT (cm)	TABLE ANGLE (Degree)	REMARK
48.43	36.27	63.23	40	-3.73	9.5	0.89	37.35	200	0	Peak
214.3	21.63	44.19	43.5	-21.87	12.16	1.86	36.58	200	0	Peak
314.21	29.81	49.01	46	-16.19	15.31	2.25	36.76	200	0	Peak
452.92	26.82	42.78	46	-19.18	18.21	2.75	36.92	200	0	Peak
552.83	25.96	40.03	46	-20.04	20.05	3.08	37.2	200	0	Peak
662.44	24.56	36.83	46	-21.44	21.77	3.43	37.47	200	0	Peak

**REMARKS:**

1. Emission level (dBuV/m) = Read level (dBuV) + Correction Factor (dB/m).
2. Correction Factor (dB/m) = Antenna Factor (dB/m) + Cable Factor (dB).
3. The other emission levels were very low against the limit.
4. Margin value = Emission level – Limit value.

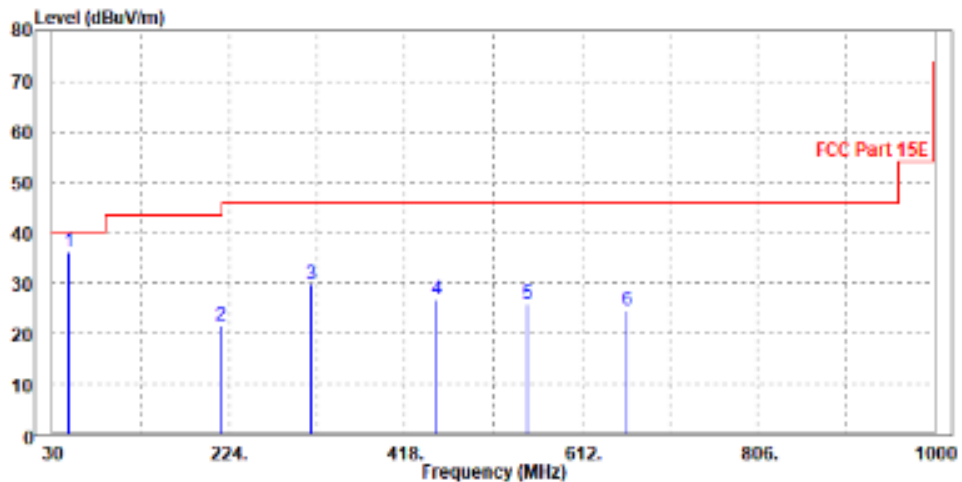



ABOVE 1GHz WORST-CASE DATA:

Note: For higher frequency, the emission is too low to be detected.

Band 1

802.11a

CHANNEL	TX Channel 36	DETECTOR FUNCTION	Peak (PK)
FREQUENCY RANGE	1GHz ~ 40GHz		Average (AV)

ANTENNA POLARITY & TEST DISTANCE: HORIZONTAL AT 3 M

FREQ. (MHz)	EMISSION LEVEL (dBuV/m)	READ LEVEL (dBuV)	LIMIT (dBuV/m)	MARGIN (dB)	ANTENNA FACTOR (dB /m)	CABLE LOSS (dB)	PREAMP FACTOR (dB)	ANTENNA HEIGHT (cm)	TABLE ANGLE (Degree)	REMARK
5150	56.58	59.56	74	-17.42	35.95	7.42	46.35	100	105	Peak
5150	47.44	50.42	54	-6.56	35.95	7.42	46.35	100	105	Average
5180	103.48	106.42			35.98	7.43	46.35	100	105	Peak
5180	95.32	98.26			35.98	7.43	46.35	100	105	Average
5350	53.03	55.71	74	-20.97	36.15	7.47	46.3	100	105	Peak
5350	44.39	47.07	54	-9.61	36.15	7.47	46.3	100	105	Average

ANTENNA POLARITY & TEST DISTANCE: VERTICAL AT 3 M

FREQ. (MHz)	EMISSION LEVEL (dBuV/m)	READ LEVEL (dBuV)	LIMIT (dBuV/m)	MARGIN (dB)	ANTENNA FACTOR (dB /m)	CABLE LOSS (dB)	PREAMP FACTOR (dB)	ANTENNA HEIGHT (cm)	TABLE ANGLE (Degree)	REMARK
5150	58.99	61.63	74	-15.01	36.29	7.42	46.35	100	335	Peak
5150	48.62	51.26	54	-5.38	36.29	7.42	46.35	100	335	Average
5180	106.63	109.24			36.31	7.43	46.35	100	335	Peak
5180	97.56	100.17			36.31	7.43	46.35	100	335	Average
5350	55.44	57.86	74	-18.56	36.41	7.47	46.3	100	335	Peak
5350	46.14	48.56	54	-7.86	36.41	7.47	46.3	100	335	Average

REMARKS:

- Emission Level = Read Level+ Antenna Factor + Cable Loss- Preamp Factor  
Margin value = Emission level – Limit value.
- 5180MHz: Fundamental frequency.



<b>CHANNEL</b>	TX Channel 40	<b>DETECTOR FUNCTION</b>	Peak (PK)
<b>FREQUENCY RANGE</b>	1GHz ~ 40GHz		Average (AV)

**ANTENNA POLARITY & TEST DISTANCE: HORIZONTAL AT 3 M**

FREQ. (MHz)	EMISSION LEVEL (dBuV/m)	READ LEVEL (dBuV)	LIMIT (dBuV/m)	MARGIN (dB)	ANTENNA FACTOR (dB /m)	CABLE LOSS (dB)	PREAMP FACTOR (dB)	ANTENNA HEIGHT (cm)	TABLE ANGLE (Degree)	REMARK
5150	54.98	57.96	74	-19.02	35.95	7.42	46.35	100	108	Peak
5150	45.65	48.63	54	-8.35	35.95	7.42	46.35	100	108	Average
5200	103.68	106.59			36	7.43	46.34	100	108	Peak
5200	94.54	97.45			36	7.43	46.34	100	108	Average
5350	54.8	57.48	74	-19.2	36.15	7.47	46.3	100	108	Peak
5350	44.67	47.35	54	-9.33	36.15	7.47	46.3	100	108	Average

**ANTENNA POLARITY & TEST DISTANCE: VERTICAL AT 3 M**

FREQ. (MHz)	EMISSION LEVEL (dBuV/m)	READ LEVEL (dBuV)	LIMIT (dBuV/m)	MARGIN (dB)	ANTENNA FACTOR (dB /m)	CABLE LOSS (dB)	PREAMP FACTOR (dB)	ANTENNA HEIGHT (cm)	TABLE ANGLE (Degree)	REMARK
5150	56	58.64	74	-18	36.29	7.42	46.35	100	332	Peak
5150	45.91	48.55	54	-8.09	36.29	7.42	46.35	100	332	Average
5200	106.1	108.69			36.32	7.43	46.34	100	332	Peak
5200	97.3	99.89			36.32	7.43	46.34	100	332	Average
5350	55.26	57.68	74	-18.74	36.41	7.47	46.3	100	332	Peak
5350	45.47	47.89	54	-8.53	36.41	7.47	46.3	100	332	Average

**REMARKS:**

- Emission Level = Read Level+ Antenna Factor + Cable Loss- Preamp Factor  
Margin value = Emission level – Limit value.
- 5200MHz: Fundamental frequency.



<b>CHANNEL</b>	TX Channel 48	<b>DETECTOR FUNCTION</b>	Peak (PK)
<b>FREQUENCY RANGE</b>	1GHz ~ 40GHz		Average (AV)

**ANTENNA POLARITY & TEST DISTANCE: HORIZONTAL AT 3 M**

FREQ. (MHz)	EMISSION LEVEL (dBuV/m)	READ LEVEL (dBuV)	LIMIT (dBuV/m)	MARGIN (dB)	ANTENNA FACTOR (dB /m)	CABLE LOSS (dB)	PREAMP FACTOR (dB)	ANTENNA HEIGHT (cm)	TABLE ANGLE (Degree)	REMARK
5150	55.66	58.64	74	-18.34	35.95	7.42	46.35	100	106	Peak
5150	45.17	48.15	54	-8.83	35.95	7.42	46.35	100	106	Average
5240	104.04	106.89			36.04	7.44	46.33	100	106	Peak
5240	94.69	97.54			36.04	7.44	46.33	100	106	Average
5350	54.98	57.66	74	-19.02	36.15	7.47	46.3	100	106	Peak
5350	45.44	48.12	54	-8.56	36.15	7.47	46.3	100	106	Average

**ANTENNA POLARITY & TEST DISTANCE: VERTICAL AT 3 M**

FREQ. (MHz)	EMISSION LEVEL (dBuV/m)	READ LEVEL (dBuV)	LIMIT (dBuV/m)	MARGIN (dB)	ANTENNA FACTOR (dB /m)	CABLE LOSS (dB)	PREAMP FACTOR (dB)	ANTENNA HEIGHT (cm)	TABLE ANGLE (Degree)	REMARK
5150	55.72	58.36	74	-18.28	36.29	7.42	46.35	100	336	Peak
5150	45.61	48.25	54	-8.39	36.29	7.42	46.35	100	336	Average
5240	107.24	109.79			36.34	7.44	46.33	100	336	Peak
5240	97.67	100.22			36.34	7.44	46.33	100	336	Average
5350	55.04	57.46	74	-18.96	36.41	7.47	46.3	100	336	Peak
5350	45.6	48.02	54	-8.4	36.41	7.47	46.3	100	336	Average

**REMARKS:**

- Emission Level = Read Level+ Antenna Factor + Cable Loss- Preamp Factor  
Margin value = Emission level – Limit value.
- 5240MHz: Fundamental frequency.



802.11n (20MHz)

CHANNEL	TX Channel 36	DETECTOR FUNCTION	Peak (PK)
FREQUENCY RANGE	1GHz ~ 40GHz		Average (AV)

ANTENNA POLARITY & TEST DISTANCE: HORIZONTAL AT 3 M

FREQ. (MHz)	EMISSION LEVEL (dBuV/m)	READ LEVEL (dBuV)	LIMIT (dBuV/m)	MARGIN (dB)	ANTENNA FACTOR (dB /m)	CABLE LOSS (dB)	PREAMP FACTOR (dB)	ANTENNA HEIGHT (cm)	TABLE ANGLE (Degree)	REMARK
5150	57.14	60.12	74	-16.86	35.95	7.42	46.35	75	100	Peak
5150	48.27	51.25	54	-5.73	35.95	7.42	46.35	75	100	Average
5180	104.01	106.95			35.98	7.43	46.35	75	100	Peak
5180	95.41	98.35			35.98	7.43	46.35	75	100	Average
5350	55.47	58.15	74	-18.53	36.15	7.47	46.3	75	100	Peak
5350	44.84	47.52	54	-9.16	36.15	7.47	46.3	75	100	Average

ANTENNA POLARITY & TEST DISTANCE: VERTICAL AT 3 M

FREQ. (MHz)	EMISSION LEVEL (dBuV/m)	READ LEVEL (dBuV)	LIMIT (dBuV/m)	MARGIN (dB)	ANTENNA FACTOR (dB /m)	CABLE LOSS (dB)	PREAMP FACTOR (dB)	ANTENNA HEIGHT (cm)	TABLE ANGLE (Degree)	REMARK
5150	59.51	62.15	74	-14.49	36.29	7.42	46.35	100	315	Peak
5150	50.57	53.21	54	-3.43	36.29	7.42	46.35	100	315	Average
5180	106.08	108.69			36.31	7.43	46.35	100	315	Peak
5180	97.08	99.69			36.31	7.43	46.35	100	315	Average
5350	55.06	57.48	74	-18.94	36.41	7.47	46.3	100	315	Peak
5350	45.23	47.65	54	-8.77	36.41	7.47	46.3	100	315	Average

REMARKS:

- Emission Level = Read Level+ Antenna Factor + Cable Loss- Preamp Factor  
Margin value = Emission level – Limit value.
- 5180MHz: Fundamental frequency.



<b>CHANNEL</b>	TX Channel 40	<b>DETECTOR FUNCTION</b>	Peak (PK)
<b>FREQUENCY RANGE</b>	1GHz ~ 40GHz		Average (AV)

**ANTENNA POLARITY & TEST DISTANCE: HORIZONTAL AT 3 M**

FREQ. (MHz)	EMISSION LEVEL (dBuV/m)	READ LEVEL (dBuV)	LIMIT (dBuV/m)	MARGIN (dB)	ANTENNA FACTOR (dB /m)	CABLE LOSS (dB)	PREAMP FACTOR (dB)	ANTENNA HEIGHT (cm)	TABLE ANGLE (Degree)	REMARK
5150	54.51	57.49	74	-19.49	35.95	7.42	46.35	100	79	Peak
5150	45.33	48.31	54	-8.67	35.95	7.42	46.35	100	79	Average
5200	103.61	106.52			36	7.43	46.34	100	79	Peak
5200	94.63	97.54			36	7.43	46.34	100	79	Average
5350	55.18	57.86	74	-18.82	36.15	7.47	46.3	100	79	Peak
5350	44.57	47.25	54	-9.43	36.15	7.47	46.3	100	79	Average

**ANTENNA POLARITY & TEST DISTANCE: VERTICAL AT 3 M**

FREQ. (MHz)	EMISSION LEVEL (dBuV/m)	READ LEVEL (dBuV)	LIMIT (dBuV/m)	MARGIN (dB)	ANTENNA FACTOR (dB /m)	CABLE LOSS (dB)	PREAMP FACTOR (dB)	ANTENNA HEIGHT (cm)	TABLE ANGLE (Degree)	REMARK
5150	55.78	58.42	74	-18.22	36.29	7.42	46.35	100	318	Peak
5150	45.72	48.36	54	-8.28	36.29	7.42	46.35	100	318	Average
5200	106.37	108.96			36.32	7.43	46.34	100	318	Peak
5200	96.99	99.58			36.32	7.43	46.34	100	318	Average
5350	55.54	57.96	74	-18.46	36.41	7.47	46.3	100	318	Peak
5350	45.79	48.21	54	-8.21	36.41	7.47	46.3	100	318	Average

**REMARKS:**

- Emission Level = Read Level+ Antenna Factor + Cable Loss- Preamp Factor  
Margin value = Emission level – Limit value.
- 5200MHz: Fundamental frequency.



<b>CHANNEL</b>	TX Channel 48	<b>DETECTOR FUNCTION</b>	Peak (PK)
<b>FREQUENCY RANGE</b>	1GHz ~ 40GHz		Average (AV)

**ANTENNA POLARITY & TEST DISTANCE: HORIZONTAL AT 3 M**

FREQ. (MHz)	EMISSION LEVEL (dBuV/m)	READ LEVEL (dBuV)	LIMIT (dBuV/m)	MARGIN (dB)	ANTENNA FACTOR (dB /m)	CABLE LOSS (dB)	PREAMP FACTOR (dB)	ANTENNA HEIGHT (cm)	TABLE ANGLE (Degree)	REMARK
5150	54.66	57.64	74	-19.34	35.95	7.42	46.35	100	81	Peak
5150	45.25	48.23	54	-8.75	35.95	7.42	46.35	100	81	Average
5240	105.67	108.52			36.04	7.44	46.33	100	81	Peak
5240	96.51	99.36			36.04	7.44	46.33	100	81	Average
5350	55.17	57.85	74	-18.83	36.15	7.47	46.3	100	81	Peak
5350	45.01	47.69	54	-8.99	36.15	7.47	46.3	100	81	Average

**ANTENNA POLARITY & TEST DISTANCE: VERTICAL AT 3 M**

FREQ. (MHz)	EMISSION LEVEL (dBuV/m)	READ LEVEL (dBuV)	LIMIT (dBuV/m)	MARGIN (dB)	ANTENNA FACTOR (dB /m)	CABLE LOSS (dB)	PREAMP FACTOR (dB)	ANTENNA HEIGHT (cm)	TABLE ANGLE (Degree)	REMARK
5150	55.2	57.84	74	-18.8	36.29	7.42	46.35	100	312	Peak
5150	45.25	47.89	54	-8.75	36.29	7.42	46.35	100	312	Average
5240	107	109.55			36.34	7.44	46.33	100	312	Peak
5240	97.92	100.47			36.34	7.44	46.33	100	312	Average
5350	55.81	58.23	74	-18.19	36.41	7.47	46.3	100	312	Peak
5350	46.09	48.51	54	-7.91	36.41	7.47	46.3	100	312	Average

**REMARKS:**

- Emission Level = Read Level+ Antenna Factor + Cable Loss- Preamp Factor  
Margin value = Emission level – Limit value.
- 5240MHz: Fundamental frequency.



802.11n (40MHz)

<b>CHANNEL</b>	TX Channel 38	<b>DETECTOR FUNCTION</b>	Peak (PK)
<b>FREQUENCY RANGE</b>	1GHz ~ 40GHz		Average (AV)

**ANTENNA POLARITY & TEST DISTANCE: HORIZONTAL AT 3 M**

FREQ. (MHz)	EMISSION LEVEL (dBuV/m)	READ LEVEL (dBuV)	LIMIT (dBuV/m)	MARGIN (dB)	ANTENNA FACTOR (dB /m)	CABLE LOSS (dB)	PREAMP FACTOR (dB)	ANTENNA HEIGHT (cm)	TABLE ANGLE (Degree)	REMARK
5150	61.54	64.52	74	-12.46	35.95	7.42	46.35	100	75	Peak
5150	48.81	51.79	54	-5.19	35.95	7.42	46.35	100	75	Average
5190	98.73	101.65			35.99	7.43	46.34	100	75	Peak
5190	89.56	92.48			35.99	7.43	46.34	100	75	Average
5350	54.8	57.48	74	-19.2	36.15	7.47	46.3	100	75	Peak
5350	45.01	47.69	54	-8.99	36.15	7.47	46.3	100	75	Average

**ANTENNA POLARITY & TEST DISTANCE: VERTICAL AT 3 M**

FREQ. (MHz)	EMISSION LEVEL (dBuV/m)	READ LEVEL (dBuV)	LIMIT (dBuV/m)	MARGIN (dB)	ANTENNA FACTOR (dB /m)	CABLE LOSS (dB)	PREAMP FACTOR (dB)	ANTENNA HEIGHT (cm)	TABLE ANGLE (Degree)	REMARK
5150	63.9	66.54	74	-10.1	36.29	7.42	46.35	100	321	Peak
5150	50.38	53.02	54	-3.62	36.29	7.42	46.35	100	321	Average
5190	100.61	103.21			36.31	7.43	46.34	100	321	Peak
5190	91.91	94.51			36.31	7.43	46.34	100	321	Average
5350	55.44	57.86	74	-18.56	36.41	7.47	46.3	100	321	Peak
5350	45.27	47.69	54	-8.73	36.41	7.47	46.3	100	321	Average

**REMARKS:**

- Emission Level = Read Level+ Antenna Factor + Cable Loss- Preamp Factor  
Margin value = Emission level – Limit value.
- 5190MHz: Fundamental frequency.





<b>CHANNEL</b>	TX Channel 46	<b>DETECTOR FUNCTION</b>	Peak (PK)
<b>FREQUENCY RANGE</b>	1GHz ~ 40GHz		Average (AV)

**ANTENNA POLARITY & TEST DISTANCE: HORIZONTAL AT 3 M**

FREQ. (MHz)	EMISSION LEVEL (dBuV/m)	READ LEVEL (dBuV)	LIMIT (dBuV/m)	MARGIN (dB)	ANTENNA FACTOR (dB /m)	CABLE LOSS (dB)	PREAMP FACTOR (dB)	ANTENNA HEIGHT (cm)	TABLE ANGLE (Degree)	REMARK
5150	54.51	57.49	74	-19.49	35.95	7.42	46.35	100	78	Peak
5150	44.88	47.86	54	-9.12	35.95	7.42	46.35	100	78	Average
5230	99.79	102.65			36.03	7.44	46.33	100	78	Peak
5230	90.56	93.42			36.03	7.44	46.33	100	78	Average
5350	54.73	57.41	74	-19.27	36.15	7.47	46.3	100	78	Peak
5350	45.55	48.23	54	-8.45	36.15	7.47	46.3	100	78	Average

**ANTENNA POLARITY & TEST DISTANCE: VERTICAL AT 3 M**

FREQ. (MHz)	EMISSION LEVEL (dBuV/m)	READ LEVEL (dBuV)	LIMIT (dBuV/m)	MARGIN (dB)	ANTENNA FACTOR (dB /m)	CABLE LOSS (dB)	PREAMP FACTOR (dB)	ANTENNA HEIGHT (cm)	TABLE ANGLE (Degree)	REMARK
5150	55.82	58.46	74	-18.18	36.29	7.42	46.35	100	322	Peak
5150	45.72	48.36	54	-8.28	36.29	7.42	46.35	100	322	Average
5230	102.86	105.41			36.34	7.44	46.33	100	322	Peak
5230	93.8	96.35			36.34	7.44	46.33	100	322	Average
5350	55.56	57.98	74	-18.44	36.41	7.47	46.3	100	322	Peak
5350	45.17	47.59	54	-8.83	36.41	7.47	46.3	100	322	Average

**REMARKS:**

- Emission Level = Read Level+ Antenna Factor + Cable Loss- Preamp Factor  
Margin value = Emission level – Limit value.
- 5230MHz: Fundamental frequency.



802.11ac (20MHz)

<b>CHANNEL</b>	TX Channel 36	<b>DETECTOR FUNCTION</b>	Peak (PK)
<b>FREQUENCY RANGE</b>	1GHz ~ 40GHz		Average (AV)

ANTENNA POLARITY & TEST DISTANCE: HORIZONTAL AT 3 M										
FREQ. (MHz)	EMISSION LEVEL (dBuV/m)	READ LEVEL (dBuV)	LIMIT (dBuV/m)	MARGIN (dB)	ANTENNA FACTOR (dB /m)	CABLE LOSS (dB)	PREAMP FACTOR (dB)	ANTENNA HEIGHT (cm)	TABLE ANGLE (Degree)	REMARK
5150	59.89	62.87	74	-14.11	35.95	7.42	46.35	100	78	Peak
5150	47.71	50.69	54	-6.29	35.95	7.42	46.35	100	78	Average
5180	104.48	107.42			35.98	7.43	46.35	100	78	Peak
5180	95.41	98.35			35.98	7.43	46.35	100	78	Average
5350	54.78	57.46	74	-19.22	36.15	7.47	46.3	100	78	Peak
5350	44.85	47.53	54	-9.15	36.15	7.47	46.3	100	78	Average

ANTENNA POLARITY & TEST DISTANCE: VERTICAL AT 3 M										
FREQ. (MHz)	EMISSION LEVEL (dBuV/m)	READ LEVEL (dBuV)	LIMIT (dBuV/m)	MARGIN (dB)	ANTENNA FACTOR (dB /m)	CABLE LOSS (dB)	PREAMP FACTOR (dB)	ANTENNA HEIGHT (cm)	TABLE ANGLE (Degree)	REMARK
5150	57.61	60.25	74	-16.39	36.29	7.42	46.35	100	321	Peak
5150	49.37	52.01	54	-4.63	36.29	7.42	46.35	100	321	Average
5180	106.04	108.65			36.31	7.43	46.35	100	321	Peak
5180	96.87	99.48			36.31	7.43	46.35	100	321	Average
5350	56.03	58.45	74	-17.97	36.41	7.47	46.3	100	321	Peak
5350	45.73	48.15	54	-8.27	36.41	7.47	46.3	100	321	Average

REMARKS:

- Emission Level = Read Level+ Antenna Factor + Cable Loss- Preamp Factor  
Margin value = Emission level – Limit value.
- 5180MHz: Fundamental frequency.



<b>CHANNEL</b>	TX Channel 40	<b>DETECTOR FUNCTION</b>	Peak (PK)
<b>FREQUENCY RANGE</b>	1GHz ~ 40GHz		Average (AV)

**ANTENNA POLARITY & TEST DISTANCE: HORIZONTAL AT 3 M**

FREQ. (MHz)	EMISSION LEVEL (dBuV/m)	READ LEVEL (dBuV)	LIMIT (dBuV/m)	MARGIN (dB)	ANTENNA FACTOR (dB /m)	CABLE LOSS (dB)	PREAMP FACTOR (dB)	ANTENNA HEIGHT (cm)	TABLE ANGLE (Degree)	REMARK
5150	54.43	57.41	74	-19.57	35.95	7.42	46.35	100	79	Peak
5150	44.65	47.63	54	-9.35	35.95	7.42	46.35	100	79	Average
5200	104.34	107.25			36	7.43	46.34	100	79	Peak
5200	95.63	98.54			36	7.43	46.34	100	79	Average
5350	55.53	58.21	74	-18.47	36.15	7.47	46.3	100	79	Peak
5350	45	47.68	54	-9	36.15	7.47	46.3	100	79	Average

**ANTENNA POLARITY & TEST DISTANCE: VERTICAL AT 3 M**

FREQ. (MHz)	EMISSION LEVEL (dBuV/m)	READ LEVEL (dBuV)	LIMIT (dBuV/m)	MARGIN (dB)	ANTENNA FACTOR (dB /m)	CABLE LOSS (dB)	PREAMP FACTOR (dB)	ANTENNA HEIGHT (cm)	TABLE ANGLE (Degree)	REMARK
5150	55.48	58.12	74	-18.52	36.29	7.42	46.35	100	325	Peak
5150	44.94	47.58	54	-9.06	36.29	7.42	46.35	100	325	Average
5200	106.77	109.36			36.32	7.43	46.34	100	325	Peak
5200	97.65	100.24			36.32	7.43	46.34	100	325	Average
5350	55.52	57.94	74	-18.48	36.41	7.47	46.3	100	325	Peak
5350	45.81	48.23	54	-8.19	36.41	7.47	46.3	100	325	Average

**REMARKS:**

- Emission Level = Read Level+ Antenna Factor + Cable Loss- Preamp Factor  
Margin value = Emission level – Limit value.
- 5200MHz: Fundamental frequency.



<b>CHANNEL</b>	TX Channel 48	<b>DETECTOR FUNCTION</b>	Peak (PK)
<b>FREQUENCY RANGE</b>	1GHz ~ 40GHz		Average (AV)

**ANTENNA POLARITY & TEST DISTANCE: HORIZONTAL AT 3 M**

FREQ. (MHz)	EMISSION LEVEL (dBuV/m)	READ LEVEL (dBuV)	LIMIT (dBuV/m)	MARGIN (dB)	ANTENNA FACTOR (dB /m)	CABLE LOSS (dB)	PREAMP FACTOR (dB)	ANTENNA HEIGHT (cm)	TABLE ANGLE (Degree)	REMARK
5150	55.23	58.21	74	-18.77	35.95	7.42	46.35	100	78	Peak
5150	44.72	47.7	54	-9.28	35.95	7.42	46.35	100	78	Average
5240	105.57	108.42			36.04	7.44	46.33	100	78	Peak
5240	96.93	99.78			36.04	7.44	46.33	100	78	Average
5350	55.16	57.84	74	-18.84	36.15	7.47	46.3	100	78	Peak
5350	44.96	47.64	54	-9.04	36.15	7.47	46.3	100	78	Average

**ANTENNA POLARITY & TEST DISTANCE: VERTICAL AT 3 M**

FREQ. (MHz)	EMISSION LEVEL (dBuV/m)	READ LEVEL (dBuV)	LIMIT (dBuV/m)	MARGIN (dB)	ANTENNA FACTOR (dB /m)	CABLE LOSS (dB)	PREAMP FACTOR (dB)	ANTENNA HEIGHT (cm)	TABLE ANGLE (Degree)	REMARK
5150	55.21	57.85	74	-18.79	36.29	7.42	46.35	100	321	Peak
5150	45.62	48.26	54	-8.38	36.29	7.42	46.35	100	321	Average
5240	107.67	110.22			36.34	7.44	46.33	100	321	Peak
5240	98.7	101.25			36.34	7.44	46.33	100	321	Average
5350	56.06	58.48	74	-17.94	36.41	7.47	46.3	100	321	Peak
5350	46.22	48.64	54	-7.78	36.41	7.47	46.3	100	321	Average

**REMARKS:**

- Emission Level = Read Level+ Antenna Factor + Cable Loss- Preamp Factor  
Margin value = Emission level – Limit value.
- 5240MHz: Fundamental frequency.



802.11ac (40MHz)

<b>CHANNEL</b>	TX Channel 38	<b>DETECTOR FUNCTION</b>	Peak (PK)
<b>FREQUENCY RANGE</b>	1GHz ~ 40GHz		Average (AV)

ANTENNA POLARITY & TEST DISTANCE: HORIZONTAL AT 3 M

FREQ. (MHz)	EMISSION LEVEL (dBuV/m)	READ LEVEL (dBuV)	LIMIT (dBuV/m)	MARGIN (dB)	ANTENNA FACTOR (dB /m)	CABLE LOSS (dB)	PREAMP FACTOR (dB)	ANTENNA HEIGHT (cm)	TABLE ANGLE (Degree)	REMARK
5150	59.6	62.58	74	-14.4	35.95	7.42	46.35	100	76	Peak
5150	47.36	50.34	54	-6.64	35.95	7.42	46.35	100	76	Average
5190	98.44	101.36			35.99	7.43	46.34	100	76	Peak
5190	89.99	92.91			35.99	7.43	46.34	100	76	Average
5350	54.77	57.45	74	-19.23	36.15	7.47	46.3	100	76	Peak
5350	45.44	48.12	54	-8.56	36.15	7.47	46.3	100	76	Average

ANTENNA POLARITY & TEST DISTANCE: VERTICAL AT 3 M

FREQ. (MHz)	EMISSION LEVEL (dBuV/m)	READ LEVEL (dBuV)	LIMIT (dBuV/m)	MARGIN (dB)	ANTENNA FACTOR (dB /m)	CABLE LOSS (dB)	PREAMP FACTOR (dB)	ANTENNA HEIGHT (cm)	TABLE ANGLE (Degree)	REMARK
5150	64.81	67.45	74	-9.19	36.29	7.42	46.35	100	320	Peak
5150	50.34	52.98	54	-3.66	36.29	7.42	46.35	100	320	Average
5190	100.66	103.26			36.31	7.43	46.34	100	320	Peak
5190	91.55	94.15			36.31	7.43	46.34	100	320	Average
5350	55.89	58.31	74	-18.11	36.41	7.47	46.3	100	320	Peak
5350	46.2	48.62	54	-7.8	36.41	7.47	46.3	100	320	Average

REMARKS:

- Emission Level = Read Level+ Antenna Factor + Cable Loss- Preamp Factor  
Margin value = Emission level – Limit value.
- 5190MHz: Fundamental frequency.



<b>CHANNEL</b>	TX Channel 46	<b>DETECTOR FUNCTION</b>	Peak (PK)
<b>FREQUENCY RANGE</b>	1GHz ~ 40GHz		Average (AV)

**ANTENNA POLARITY & TEST DISTANCE: HORIZONTAL AT 3 M**

FREQ. (MHz)	EMISSION LEVEL (dBuV/m)	READ LEVEL (dBuV)	LIMIT (dBuV/m)	MARGIN (dB)	ANTENNA FACTOR (dB /m)	CABLE LOSS (dB)	PREAMP FACTOR (dB)	ANTENNA HEIGHT (cm)	TABLE ANGLE (Degree)	REMARK
5150	55.18	58.16	74	-18.82	35.95	7.42	46.35	100	79	Peak
5150	45.34	48.32	54	-8.66	35.95	7.42	46.35	100	79	Average
5230	100.79	103.65			36.03	7.44	46.33	100	79	Peak
5230	91.78	94.64			36.03	7.44	46.33	100	79	Average
5350	55	57.68	74	-19	36.15	7.47	46.3	100	79	Peak
5350	45.21	47.89	54	-8.79	36.15	7.47	46.3	100	79	Average

**ANTENNA POLARITY & TEST DISTANCE: VERTICAL AT 3 M**

FREQ. (MHz)	EMISSION LEVEL (dBuV/m)	READ LEVEL (dBuV)	LIMIT (dBuV/m)	MARGIN (dB)	ANTENNA FACTOR (dB /m)	CABLE LOSS (dB)	PREAMP FACTOR (dB)	ANTENNA HEIGHT (cm)	TABLE ANGLE (Degree)	REMARK
5150	54.84	57.48	74	-19.16	36.29	7.42	46.35	100	324	Peak
5150	45.62	48.26	54	-8.38	36.29	7.42	46.35	100	324	Average
5230	103.08	105.63			36.34	7.44	46.33	100	324	Peak
5230	93.8	96.35			36.34	7.44	46.33	100	324	Average
5350	55.73	58.15	74	-18.27	36.41	7.47	46.3	100	324	Peak
5350	45.7	48.12	54	-8.3	36.41	7.47	46.3	100	324	Average

**REMARKS:**

- Emission Level = Read Level+ Antenna Factor + Cable Loss- Preamp Factor  
Margin value = Emission level – Limit value.
- 5230MHz: Fundamental frequency.



802.11ac (80MHz)

<b>CHANNEL</b>	TX Channel 42	<b>DETECTOR FUNCTION</b>	Peak (PK)
<b>FREQUENCY RANGE</b>	1GHz ~ 40GHz		Average (AV)

ANTENNA POLARITY & TEST DISTANCE: HORIZONTAL AT 3 M

FREQ. (MHz)	EMISSION LEVEL (dBuV/m)	READ LEVEL (dBuV)	LIMIT (dBuV/m)	MARGIN (dB)	ANTENNA FACTOR (dB /m)	CABLE LOSS (dB)	PREAMP FACTOR (dB)	ANTENNA HEIGHT (cm)	TABLE ANGLE (Degree)	REMARK
5150	54.34	56.65	74	-19.66	34.52	9.52	46.35	100	150	Peak
5150	50.51	52.82	54	-3.49	34.52	9.52	46.35	100	150	Average
5210	88.07	90.2			34.57	9.64	46.34	100	150	Peak
5210	80.94	83.07			34.57	9.64	46.34	100	150	Average
5350	53.91	55.59	74	-20.09	34.68	9.94	46.3	100	150	Peak
5350	48.9	50.58	54	-5.1	34.68	9.94	46.3	100	150	Average

ANTENNA POLARITY & TEST DISTANCE: VERTICAL AT 3 M

FREQ. (MHz)	EMISSION LEVEL (dBuV/m)	READ LEVEL (dBuV)	LIMIT (dBuV/m)	MARGIN (dB)	ANTENNA FACTOR (dB /m)	CABLE LOSS (dB)	PREAMP FACTOR (dB)	ANTENNA HEIGHT (cm)	TABLE ANGLE (Degree)	REMARK
5150	58.1	60.33	74	-15.9	34.6	9.52	46.35	200	0	Peak
5150	50.6	52.83	54	-3.4	34.6	9.52	46.35	200	0	Average
5210	91.25	93.35			34.6	9.64	46.34	200	0	Peak
5210	85.23	87.33			34.6	9.64	46.34	200	0	Average
5350	53.41	55.17	74	-20.59	34.6	9.94	46.3	200	0	Peak
5350	48.77	50.53	54	-5.23	34.6	9.94	46.3	200	0	Average

REMARKS:

- Emission Level = Read Level+ Antenna Factor + Cable Loss- Preamp Factor  
Margin value = Emission level – Limit value.
- 5210MHz: Fundamental frequency.



Band 2  
802.11a

CHANNEL	TX Channel 52	DETECTOR FUNCTION	Peak (PK)
FREQUENCY RANGE	1GHz ~ 40GHz		Average (AV)

ANTENNA POLARITY & TEST DISTANCE: HORIZONTAL AT 3 M

FREQ. (MHz)	EMISSION LEVEL (dBuV/m)	READ LEVEL (dBuV)	LIMIT (dBuV/m)	MARGIN (dB)	ANTENNA FACTOR (dB /m)	CABLE LOSS (dB)	PREAMP FACTOR (dB)	ANTENNA HEIGHT (cm)	TABLE ANGLE (Degree)	REMARK
5150	53.44	58.67	74	-20.56	33.7	7.42	46.35	200	360	Peak
5150	44.81	50.04	54	-9.19	33.7	7.42	46.35	200	360	Average
5260	100.87	106.04			33.7	7.45	46.32	200	360	Peak
5260	94.89	100.06			33.7	7.45	46.32	200	360	Average
5350	50.59	55.72	74	-23.41	33.7	7.47	46.3	200	360	Peak
5350	44.39	49.52	54	-9.61	33.7	7.47	46.3	200	360	Average

ANTENNA POLARITY & TEST DISTANCE: VERTICAL AT 3 M

FREQ. (MHz)	EMISSION LEVEL (dBuV/m)	READ LEVEL (dBuV)	LIMIT (dBuV/m)	MARGIN (dB)	ANTENNA FACTOR (dB /m)	CABLE LOSS (dB)	PREAMP FACTOR (dB)	ANTENNA HEIGHT (cm)	TABLE ANGLE (Degree)	REMARK
5150	56.82	59.46	74	-17.18	36.29	7.42	46.35	105	265	Peak
5150	47.11	49.75	54	-6.89	36.29	7.42	46.35	105	265	Average
5260	101.87	104.38			36.36	7.45	46.32	105	265	Peak
5260	92.84	95.35			36.36	7.45	46.32	105	265	Average
5350	55.54	57.96	74	-18.46	36.41	7.47	46.3	105	265	Peak
5350	46.53	48.95	54	-7.47	36.41	7.47	46.3	105	265	Average

REMARKS:

- Emission Level = Read Level+ Antenna Factor + Cable Loss- Preamp Factor  
Margin value = Emission level – Limit value.
- 5260MHz: Fundamental frequency.





<b>CHANNEL</b>	TX Channel 60	<b>DETECTOR FUNCTION</b>	Peak (PK)
<b>FREQUENCY RANGE</b>	1GHz ~ 40GHz		Average (AV)

**ANTENNA POLARITY & TEST DISTANCE: HORIZONTAL AT 3 M**

FREQ. (MHz)	EMISSION LEVEL (dBuV/m)	READ LEVEL (dBuV)	LIMIT (dBuV/m)	MARGIN (dB)	ANTENNA FACTOR (dB /m)	CABLE LOSS (dB)	PREAMP FACTOR (dB)	ANTENNA HEIGHT (cm)	TABLE ANGLE (Degree)	REMARK
5150	53.73	58.96	74	-20.27	33.7	7.42	46.35	200	360	Peak
5150	45.31	50.54	54	-8.69	33.7	7.42	46.35	200	360	Average
5300	100.31	105.46			33.7	7.46	46.31	200	360	Peak
5300	93.37	98.52			33.7	7.46	46.31	200	360	Average
5350	52.69	57.82	74	-21.31	33.7	7.47	46.3	200	360	Peak
5350	44.37	49.5	54	-9.63	33.7	7.47	46.3	200	360	Average

**ANTENNA POLARITY & TEST DISTANCE: VERTICAL AT 3 M**

FREQ. (MHz)	EMISSION LEVEL (dBuV/m)	READ LEVEL (dBuV)	LIMIT (dBuV/m)	MARGIN (dB)	ANTENNA FACTOR (dB /m)	CABLE LOSS (dB)	PREAMP FACTOR (dB)	ANTENNA HEIGHT (cm)	TABLE ANGLE (Degree)	REMARK
5150	55.78	58.42	74	-18.22	36.29	7.42	46.35	100	260	Peak
5150	47.11	49.75	54	-6.89	36.29	7.42	46.35	100	260	Average
5300	100.38	102.85			36.38	7.46	46.31	100	260	Peak
5300	93.66	96.13			36.38	7.46	46.31	100	260	Average
5350	54.13	56.55	74	-19.87	36.41	7.47	46.3	100	260	Peak
5350	46.77	49.19	54	-7.23	36.41	7.47	46.3	100	260	Average

**REMARKS:**

- Emission Level = Read Level+ Antenna Factor + Cable Loss- Preamp Factor  
Margin value = Emission level – Limit value.
- 5300MHz: Fundamental frequency.



<b>CHANNEL</b>	TX Channel 64	<b>DETECTOR FUNCTION</b>	Peak (PK)
<b>FREQUENCY RANGE</b>	1GHz ~ 40GHz		Average (AV)

**ANTENNA POLARITY & TEST DISTANCE: HORIZONTAL AT 3 M**

FREQ. (MHz)	EMISSION LEVEL (dBuV/m)	READ LEVEL (dBuV)	LIMIT (dBuV/m)	MARGIN (dB)	ANTENNA FACTOR (dB /m)	CABLE LOSS (dB)	PREAMP FACTOR (dB)	ANTENNA HEIGHT (cm)	TABLE ANGLE (Degree)	REMARK
5150	51.03	56.26	74	-22.97	33.7	7.42	46.35	200	350	Peak
5150	44.65	49.88	54	-9.35	33.7	7.42	46.35	200	350	Average
5320	101.58	106.72			33.7	7.46	46.3	200	350	Peak
5320	95.05	100.19			33.7	7.46	46.3	200	350	Average
5350	54.14	59.27	74	-19.86	33.7	7.47	46.3	200	350	Peak
5350	45.51	50.64	54	-8.49	33.7	7.47	46.3	200	350	Average

**ANTENNA POLARITY & TEST DISTANCE: VERTICAL AT 3 M**

FREQ. (MHz)	EMISSION LEVEL (dBuV/m)	READ LEVEL (dBuV)	LIMIT (dBuV/m)	MARGIN (dB)	ANTENNA FACTOR (dB /m)	CABLE LOSS (dB)	PREAMP FACTOR (dB)	ANTENNA HEIGHT (cm)	TABLE ANGLE (Degree)	REMARK
5150	55.52	58.16	74	-18.48	36.29	7.42	46.35	105	270	Peak
5150	47.72	50.36	54	-6.28	36.29	7.42	46.35	105	270	Average
5320	102.34	104.79			36.39	7.46	46.3	105	270	Peak
5320	94.79	97.24			36.39	7.46	46.3	105	270	Average
5350	55.89	58.31	74	-18.11	36.41	7.47	46.3	105	270	Peak
5350	47.91	50.33	54	-6.09	36.41	7.47	46.3	105	270	Average

**REMARKS:**

- Emission Level = Read Level+ Antenna Factor + Cable Loss- Preamp Factor  
Margin value = Emission level – Limit value.
- 5320MHz: Fundamental frequency.



802.11n (20MHz)

CHANNEL	TX Channel 52	DETECTOR FUNCTION	Peak (PK)
FREQUENCY RANGE	1GHz ~ 40GHz		Average (AV)

ANTENNA POLARITY & TEST DISTANCE: HORIZONTAL AT 3 M										
FREQ. (MHz)	EMISSION LEVEL (dBuV/m)	READ LEVEL (dBuV)	LIMIT (dBuV/m)	MARGIN (dB)	ANTENNA FACTOR (dB /m)	CABLE LOSS (dB)	PREAMP FACTOR (dB)	ANTENNA HEIGHT (cm)	TABLE ANGLE (Degree)	REMARK
5150	53.17	58.4	74	-20.83	33.7	7.42	46.35	200	350	Peak
5150	45.53	50.76	54	-8.47	33.7	7.42	46.35	200	350	Average
5260	102.64	107.81			33.7	7.45	46.32	200	350	Peak
5260	96.43	101.6			33.7	7.45	46.32	200	350	Average
5350	51.04	56.17	74	-22.96	33.7	7.47	46.3	200	350	Peak
5350	44.78	49.91	54	-9.22	33.7	7.47	46.3	200	350	Average

ANTENNA POLARITY & TEST DISTANCE: VERTICAL AT 3 M										
FREQ. (MHz)	EMISSION LEVEL (dBuV/m)	READ LEVEL (dBuV)	LIMIT (dBuV/m)	MARGIN (dB)	ANTENNA FACTOR (dB /m)	CABLE LOSS (dB)	PREAMP FACTOR (dB)	ANTENNA HEIGHT (cm)	TABLE ANGLE (Degree)	REMARK
5150	55.82	58.46	74	-18.18	36.29	7.42	46.35	100	260	Peak
5150	47.85	50.49	54	-6.15	36.29	7.42	46.35	100	260	Average
5260	103.77	106.28			36.36	7.45	46.32	100	260	Peak
5260	95.39	97.9			36.36	7.45	46.32	100	260	Average
5350	54.69	57.11	74	-19.31	36.41	7.47	46.3	100	260	Peak
5350	47.17	49.59	54	-6.83	36.41	7.47	46.3	100	260	Average

REMARKS:

- Emission Level = Read Level+ Antenna Factor + Cable Loss- Preamp Factor  
Margin value = Emission level – Limit value.
- 5260MHz: Fundamental frequency.



<b>CHANNEL</b>	TX Channel 60	<b>DETECTOR FUNCTION</b>	Peak (PK)
<b>FREQUENCY RANGE</b>	1GHz ~ 40GHz		Average (AV)

**ANTENNA POLARITY & TEST DISTANCE: HORIZONTAL AT 3 M**

FREQ. (MHz)	EMISSION LEVEL (dBuV/m)	READ LEVEL (dBuV)	LIMIT (dBuV/m)	MARGIN (dB)	ANTENNA FACTOR (dB /m)	CABLE LOSS (dB)	PREAMP FACTOR (dB)	ANTENNA HEIGHT (cm)	TABLE ANGLE (Degree)	REMARK
5150	53.89	59.12	74	-20.11	33.7	7.42	46.35	135	360	Peak
5150	45.15	50.38	54	-8.85	33.7	7.42	46.35	135	360	Average
5300	101.25	106.4			33.7	7.46	46.31	135	360	Peak
5300	93.51	98.66			33.7	7.46	46.31	135	360	Average
5350	55.23	60.36	74	-18.77	33.7	7.47	46.3	135	360	Peak
5350	44.47	49.6	54	-9.53	33.7	7.47	46.3	135	360	Average

**ANTENNA POLARITY & TEST DISTANCE: VERTICAL AT 3 M**

FREQ. (MHz)	EMISSION LEVEL (dBuV/m)	READ LEVEL (dBuV)	LIMIT (dBuV/m)	MARGIN (dB)	ANTENNA FACTOR (dB /m)	CABLE LOSS (dB)	PREAMP FACTOR (dB)	ANTENNA HEIGHT (cm)	TABLE ANGLE (Degree)	REMARK
5150	55.96	58.6	74	-18.04	36.29	7.42	46.35	150	275	Peak
5150	47.87	50.51	54	-6.13	36.29	7.42	46.35	150	275	Average
5300	103.24	105.71			36.38	7.46	46.31	150	275	Peak
5300	96.7	99.17			36.38	7.46	46.31	150	275	Average
5350	53.83	56.25	74	-20.17	36.41	7.47	46.3	150	275	Peak
5350	47.42	49.84	54	-6.58	36.41	7.47	46.3	150	275	Average

**REMARKS:**

- Emission Level = Read Level+ Antenna Factor + Cable Loss- Preamp Factor  
Margin value = Emission level – Limit value.
- 5300MHz: Fundamental frequency.



<b>CHANNEL</b>	TX Channel 64	<b>DETECTOR FUNCTION</b>	Peak (PK)
<b>FREQUENCY RANGE</b>	1GHz ~ 40GHz		Average (AV)

**ANTENNA POLARITY & TEST DISTANCE: HORIZONTAL AT 3 M**

FREQ. (MHz)	EMISSION LEVEL (dBuV/m)	READ LEVEL (dBuV)	LIMIT (dBuV/m)	MARGIN (dB)	ANTENNA FACTOR (dB /m)	CABLE LOSS (dB)	PREAMP FACTOR (dB)	ANTENNA HEIGHT (cm)	TABLE ANGLE (Degree)	REMARK
5150	51.7	56.93	74	-22.3	33.7	7.42	46.35	135	360	Peak
5150	44.69	49.92	54	-9.31	33.7	7.42	46.35	135	360	Average
5320	100.22	105.36			33.7	7.46	46.3	135	360	Peak
5320	94.05	99.19			33.7	7.46	46.3	135	360	Average
5350	56.06	61.19	74	-17.94	33.7	7.47	46.3	135	360	Peak
5350	47.79	52.92	54	-6.21	33.7	7.47	46.3	135	360	Average

**ANTENNA POLARITY & TEST DISTANCE: VERTICAL AT 3 M**

FREQ. (MHz)	EMISSION LEVEL (dBuV/m)	READ LEVEL (dBuV)	LIMIT (dBuV/m)	MARGIN (dB)	ANTENNA FACTOR (dB /m)	CABLE LOSS (dB)	PREAMP FACTOR (dB)	ANTENNA HEIGHT (cm)	TABLE ANGLE (Degree)	REMARK
5150	53.59	56.23	74	-20.41	36.29	7.42	46.35	110	210	Peak
5150	47.21	49.85	54	-6.79	36.29	7.42	46.35	110	210	Average
5320	102.31	104.76			36.39	7.46	46.3	110	210	Peak
5320	94.23	96.68			36.39	7.46	46.3	110	210	Average
5350	56.78	59.2	74	-17.22	36.41	7.47	46.3	110	210	Peak
5350	48.72	51.14	54	-5.28	36.41	7.47	46.3	110	210	Average

**REMARKS:**

- Emission Level = Read Level+ Antenna Factor + Cable Loss- Preamp Factor  
Margin value = Emission level – Limit value.
- 5320MHz: Fundamental frequency.



802.11n (40MHz)

<b>CHANNEL</b>	TX Channel 54	<b>DETECTOR FUNCTION</b>	Peak (PK)
<b>FREQUENCY RANGE</b>	1GHz ~ 40GHz		Average (AV)

**ANTENNA POLARITY & TEST DISTANCE: HORIZONTAL AT 3 M**

FREQ. (MHz)	EMISSION LEVEL (dBuV/m)	READ LEVEL (dBuV)	LIMIT (dBuV/m)	MARGIN (dB)	ANTENNA FACTOR (dB /m)	CABLE LOSS (dB)	PREAMP FACTOR (dB)	ANTENNA HEIGHT (cm)	TABLE ANGLE (Degree)	REMARK
5150	56.66	59.64	74	-17.34	35.95	7.42	46.35	110	180	Peak
5150	48.02	51	54	-5.98	35.95	7.42	46.35	110	180	Average
5270	100.77	103.57			36.07	7.45	46.32	110	180	Peak
5270	94.65	97.45			36.07	7.45	46.32	110	180	Average
5350	55.84	58.52	74	-18.16	36.15	7.47	46.3	110	180	Peak
5350	47.68	50.36	54	-6.32	36.15	7.47	46.3	110	180	Average

**ANTENNA POLARITY & TEST DISTANCE: VERTICAL AT 3 M**

FREQ. (MHz)	EMISSION LEVEL (dBuV/m)	READ LEVEL (dBuV)	LIMIT (dBuV/m)	MARGIN (dB)	ANTENNA FACTOR (dB /m)	CABLE LOSS (dB)	PREAMP FACTOR (dB)	ANTENNA HEIGHT (cm)	TABLE ANGLE (Degree)	REMARK
5150	54.86	57.5	74	-19.14	36.29	7.42	46.35	100	195	Peak
5150	48.95	51.59	54	-5.05	36.29	7.42	46.35	100	195	Average
5270	99.09	101.6			36.36	7.45	46.32	100	195	Peak
5270	93.05	95.56			36.36	7.45	46.32	100	195	Average
5350	53.75	56.17	74	-20.25	36.41	7.47	46.3	100	195	Peak
5350	47.8	50.22	54	-6.2	36.41	7.47	46.3	100	195	Average

**REMARKS:**

- Emission Level = Read Level+ Antenna Factor + Cable Loss- Preamp Factor  
Margin value = Emission level – Limit value.
- 5270MHz: Fundamental frequency.



<b>CHANNEL</b>	TX Channel 62	<b>DETECTOR FUNCTION</b>	Peak (PK)
<b>FREQUENCY RANGE</b>	1GHz ~ 40GHz		Average (AV)

**ANTENNA POLARITY & TEST DISTANCE: HORIZONTAL AT 3 M**

FREQ. (MHz)	EMISSION LEVEL (dBuV/m)	READ LEVEL (dBuV)	LIMIT (dBuV/m)	MARGIN (dB)	ANTENNA FACTOR (dB /m)	CABLE LOSS (dB)	PREAMP FACTOR (dB)	ANTENNA HEIGHT (cm)	TABLE ANGLE (Degree)	REMARK
5150	55.34	58.32	74	-18.66	35.95	7.42	46.35	100	0	Peak
5150	47.87	50.85	54	-6.13	35.95	7.42	46.35	100	0	Average
5310	98.65	101.39			36.11	7.46	46.31	100	0	Peak
5310	92.16	94.9			36.11	7.46	46.31	100	0	Average
5350	61.17	63.85	74	-12.83	36.15	7.47	46.3	100	0	Peak
5350	49.83	52.51	54	-4.17	36.15	7.47	46.3	100	0	Average

**ANTENNA POLARITY & TEST DISTANCE: VERTICAL AT 3 M**

FREQ. (MHz)	EMISSION LEVEL (dBuV/m)	READ LEVEL (dBuV)	LIMIT (dBuV/m)	MARGIN (dB)	ANTENNA FACTOR (dB /m)	CABLE LOSS (dB)	PREAMP FACTOR (dB)	ANTENNA HEIGHT (cm)	TABLE ANGLE (Degree)	REMARK
5150	54.48	57.12	74	-19.52	36.29	7.42	46.35	110	0	Peak
5150	48.17	50.81	54	-5.83	36.29	7.42	46.35	110	0	Average
5310	97.6	100.06			36.39	7.46	46.31	110	0	Peak
5310	92.43	94.89			36.39	7.46	46.31	110	0	Average
5350	57.38	59.8	74	-16.62	36.41	7.47	46.3	110	0	Peak
5350	50.96	53.38	54	-3.04	36.41	7.47	46.3	110	0	Average

**REMARKS:**

- Emission Level = Read Level+ Antenna Factor + Cable Loss- Preamp Factor  
Margin value = Emission level – Limit value.
- 5310MHz: Fundamental frequency.



**802.11ac (20MHz)**

<b>CHANNEL</b>	TX Channel 52	<b>DETECTOR FUNCTION</b>	Peak (PK)
<b>FREQUENCY RANGE</b>	1GHz ~ 40GHz		Average (AV)

<b>ANTENNA POLARITY &amp; TEST DISTANCE: HORIZONTAL AT 3 M</b>										
<b>FREQ. (MHz)</b>	<b>EMISSION LEVEL (dBuV/m)</b>	<b>READ LEVEL (dBuV)</b>	<b>LIMIT (dBuV/m)</b>	<b>MARGIN (dB)</b>	<b>ANTENNA FACTOR (dB /m)</b>	<b>CABLE LOSS (dB)</b>	<b>PREAMP FACTOR (dB)</b>	<b>ANTENNA HEIGHT (cm)</b>	<b>TABLE ANGLE (Degree)</b>	<b>REMARK</b>
5150	57.41	60.39	74	-16.59	35.95	7.42	46.35	200	360	Peak
5150	48.57	51.55	54	-5.43	35.95	7.42	46.35	200	360	Average
5260	104.92	107.73			36.06	7.45	46.32	200	360	Peak
5260	98.52	101.33			36.06	7.45	46.32	200	360	Average
5350	54.92	57.6	74	-19.08	36.15	7.47	46.3	200	360	Peak
5350	48.04	50.72	54	-5.96	36.15	7.47	46.3	200	360	Average

<b>ANTENNA POLARITY &amp; TEST DISTANCE: VERTICAL AT 3 M</b>										
<b>FREQ. (MHz)</b>	<b>EMISSION LEVEL (dBuV/m)</b>	<b>READ LEVEL (dBuV)</b>	<b>LIMIT (dBuV/m)</b>	<b>MARGIN (dB)</b>	<b>ANTENNA FACTOR (dB /m)</b>	<b>CABLE LOSS (dB)</b>	<b>PREAMP FACTOR (dB)</b>	<b>ANTENNA HEIGHT (cm)</b>	<b>TABLE ANGLE (Degree)</b>	<b>REMARK</b>
5150	56.61	59.25	74	-17.39	36.29	7.42	46.35	100	190	Peak
5150	48.83	51.47	54	-5.17	36.29	7.42	46.35	100	190	Average
5260	103.83	106.34			36.36	7.45	46.32	100	190	Peak
5260	97.27	99.78			36.36	7.45	46.32	100	190	Average
5350	55.71	58.13	74	-18.29	36.41	7.47	46.3	100	190	Peak
5350	47.87	50.29	54	-6.13	36.41	7.47	46.3	100	190	Average

**REMARKS:**

- Emission Level = Read Level+ Antenna Factor + Cable Loss- Preamp Factor  
Margin value = Emission level – Limit value.
- 5260MHz: Fundamental frequency.





<b>CHANNEL</b>	TX Channel 60	<b>DETECTOR FUNCTION</b>	Peak (PK)
<b>FREQUENCY RANGE</b>	1GHz ~ 40GHz		Average (AV)

ANTENNA POLARITY & TEST DISTANCE: HORIZONTAL AT 3 M										
FREQ. (MHz)	EMISSION LEVEL (dBuV/m)	READ LEVEL (dBuV)	LIMIT (dBuV/m)	MARGIN (dB)	ANTENNA FACTOR (dB /m)	CABLE LOSS (dB)	PREAMP FACTOR (dB)	ANTENNA HEIGHT (cm)	TABLE ANGLE (Degree)	REMARK
5150	57.46	60.44	74	-16.54	35.95	7.42	46.35	160	210	Peak
5150	48.6	51.58	54	-5.4	35.95	7.42	46.35	160	210	Average
5300	104.29	107.04			36.1	7.46	46.31	160	210	Peak
5300	96.38	99.13			36.1	7.46	46.31	160	210	Average
5350	54.82	57.5	74	-19.18	36.15	7.47	46.3	160	210	Peak
5350	47.85	50.53	54	-6.15	36.15	7.47	46.3	160	210	Average

ANTENNA POLARITY & TEST DISTANCE: VERTICAL AT 3 M										
FREQ. (MHz)	EMISSION LEVEL (dBuV/m)	READ LEVEL (dBuV)	LIMIT (dBuV/m)	MARGIN (dB)	ANTENNA FACTOR (dB /m)	CABLE LOSS (dB)	PREAMP FACTOR (dB)	ANTENNA HEIGHT (cm)	TABLE ANGLE (Degree)	REMARK
5150	56.72	59.36	74	-17.28	36.29	7.42	46.35	100	185	Peak
5150	48.8	51.44	54	-5.2	36.29	7.42	46.35	100	185	Average
5300	103.8	106.27			36.38	7.46	46.31	100	185	Peak
5300	95.45	97.92			36.38	7.46	46.31	100	185	Average
5350	56.24	58.66	74	-17.76	36.41	7.47	46.3	100	185	Peak
5350	47.7	50.12	54	-6.3	36.41	7.47	46.3	100	185	Average

**REMARKS:**

- Emission Level = Read Level+ Antenna Factor + Cable Loss- Preamp Factor  
Margin value = Emission level – Limit value.
- 5300MHz: Fundamental frequency.



<b>CHANNEL</b>	TX Channel 64	<b>DETECTOR FUNCTION</b>	Peak (PK)
<b>FREQUENCY RANGE</b>	1GHz ~ 40GHz		Average (AV)

**ANTENNA POLARITY & TEST DISTANCE: HORIZONTAL AT 3 M**

FREQ. (MHz)	EMISSION LEVEL (dBuV/m)	READ LEVEL (dBuV)	LIMIT (dBuV/m)	MARGIN (dB)	ANTENNA FACTOR (dB /m)	CABLE LOSS (dB)	PREAMP FACTOR (dB)	ANTENNA HEIGHT (cm)	TABLE ANGLE (Degree)	REMARK
5150	57.41	60.39	74	-16.59	35.95	7.42	46.35	160	200	Peak
5150	48.38	51.36	54	-5.62	35.95	7.42	46.35	160	200	Average
5320	103.86	106.58			36.12	7.46	46.3	160	200	Peak
5320	97.22	99.94			36.12	7.46	46.3	160	200	Average
5350	60.42	63.1	74	-13.58	36.15	7.47	46.3	160	200	Peak
5350	49.92	52.6	54	-4.08	36.15	7.47	46.3	160	200	Average

**ANTENNA POLARITY & TEST DISTANCE: VERTICAL AT 3 M**

FREQ. (MHz)	EMISSION LEVEL (dBuV/m)	READ LEVEL (dBuV)	LIMIT (dBuV/m)	MARGIN (dB)	ANTENNA FACTOR (dB /m)	CABLE LOSS (dB)	PREAMP FACTOR (dB)	ANTENNA HEIGHT (cm)	TABLE ANGLE (Degree)	REMARK
5150	56.01	58.65	74	-17.99	36.29	7.42	46.35	165	180	Peak
5150	48.49	51.13	54	-5.51	36.29	7.42	46.35	165	180	Average
5320	103.43	105.88			36.39	7.46	46.3	165	180	Peak
5320	96.85	99.3			36.39	7.46	46.3	165	180	Average
5350	60.24	62.66	74	-13.76	36.41	7.47	46.3	165	180	Peak
5350	50.29	52.71	54	-3.71	36.41	7.47	46.3	165	180	Average

**REMARKS:**

- Emission Level = Read Level+ Antenna Factor + Cable Loss- Preamp Factor  
Margin value = Emission level – Limit value.
- 5320MHz: Fundamental frequency.



802.11ac (40MHz)

<b>CHANNEL</b>	TX Channel 54	<b>DETECTOR FUNCTION</b>	Peak (PK)
<b>FREQUENCY RANGE</b>	1GHz ~ 40GHz		Average (AV)

**ANTENNA POLARITY & TEST DISTANCE: HORIZONTAL AT 3 M**

FREQ. (MHz)	EMISSION LEVEL (dBuV/m)	READ LEVEL (dBuV)	LIMIT (dBuV/m)	MARGIN (dB)	ANTENNA FACTOR (dB /m)	CABLE LOSS (dB)	PREAMP FACTOR (dB)	ANTENNA HEIGHT (cm)	TABLE ANGLE (Degree)	REMARK
5150	55.69	58.67	74	-18.31	35.95	7.42	46.35	110	180	Peak
5150	48.13	51.11	54	-5.87	35.95	7.42	46.35	110	180	Average
5270	99.14	101.94			36.07	7.45	46.32	110	180	Peak
5270	93.81	96.61			36.07	7.45	46.32	110	180	Average
5350	54.97	57.65	74	-19.03	36.15	7.47	46.3	110	180	Peak
5350	47.33	50.01	54	-6.67	36.15	7.47	46.3	110	180	Average

**ANTENNA POLARITY & TEST DISTANCE: VERTICAL AT 3 M**

FREQ. (MHz)	EMISSION LEVEL (dBuV/m)	READ LEVEL (dBuV)	LIMIT (dBuV/m)	MARGIN (dB)	ANTENNA FACTOR (dB /m)	CABLE LOSS (dB)	PREAMP FACTOR (dB)	ANTENNA HEIGHT (cm)	TABLE ANGLE (Degree)	REMARK
5150	54.97	57.61	74	-19.03	36.29	7.42	46.35	160	180	Peak
5150	48.45	51.09	54	-5.55	36.29	7.42	46.35	160	180	Average
5270	96.74	99.25			36.36	7.45	46.32	160	180	Peak
5270	91.44	93.95			36.36	7.45	46.32	160	180	Average
5350	54.12	56.54	74	-19.88	36.41	7.47	46.3	160	180	Peak
5350	47.01	49.43	54	-6.99	36.41	7.47	46.3	160	180	Average

**REMARKS:**

- Emission Level = Read Level+ Antenna Factor + Cable Loss- Preamp Factor  
Margin value = Emission level – Limit value.
- 5270MHz: Fundamental frequency.



<b>CHANNEL</b>	TX Channel 62	<b>DETECTOR FUNCTION</b>	Peak (PK)
<b>FREQUENCY RANGE</b>	1GHz ~ 40GHz		Average (AV)

**ANTENNA POLARITY & TEST DISTANCE: HORIZONTAL AT 3 M**

FREQ. (MHz)	EMISSION LEVEL (dBuV/m)	READ LEVEL (dBuV)	LIMIT (dBuV/m)	MARGIN (dB)	ANTENNA FACTOR (dB /m)	CABLE LOSS (dB)	PREAMP FACTOR (dB)	ANTENNA HEIGHT (cm)	TABLE ANGLE (Degree)	REMARK
5150	53.4	55.71	74	-20.6	34.52	9.52	46.35	200	70	Peak
5150	48.76	51.07	54	-5.24	34.52	9.52	46.35	200	70	Average
5310	101.41	103.22			34.65	9.85	46.31	200	70	Peak
5310	94.58	96.39			34.65	9.85	46.31	200	70	Average
5350	61.45	63.13	74	-12.55	34.68	9.94	46.3	200	70	Peak
5350	50.24	51.92	54	-3.76	34.68	9.94	46.3	200	70	Average

**ANTENNA POLARITY & TEST DISTANCE: VERTICAL AT 3 M**

FREQ. (MHz)	EMISSION LEVEL (dBuV/m)	READ LEVEL (dBuV)	LIMIT (dBuV/m)	MARGIN (dB)	ANTENNA FACTOR (dB /m)	CABLE LOSS (dB)	PREAMP FACTOR (dB)	ANTENNA HEIGHT (cm)	TABLE ANGLE (Degree)	REMARK
5150	54.3	56.53	74	-19.7	34.6	9.52	46.35	200	260	Peak
5150	48.99	51.22	54	-5.01	34.6	9.52	46.35	200	260	Average
5310	100.46	102.32			34.6	9.85	46.31	200	260	Peak
5310	94.87	96.73			34.6	9.85	46.31	200	260	Average
5350	58.08	59.84	74	-15.92	34.6	9.94	46.3	200	260	Peak
5350	50.4	52.16	54	-3.6	34.6	9.94	46.3	200	260	Average

**REMARKS:**

- Emission Level = Read Level+ Antenna Factor + Cable Loss- Preamp Factor  
Margin value = Emission level – Limit value.
- 5310MHz: Fundamental frequency.



**802.11ac (80MHz)**

<b>CHANNEL</b>	TX Channel 58	<b>DETECTOR FUNCTION</b>	Peak (PK)
<b>FREQUENCY RANGE</b>	1GHz ~ 40GHz		Average (AV)

<b>ANTENNA POLARITY &amp; TEST DISTANCE: HORIZONTAL AT 3 M</b>										
<b>FREQ. (MHz)</b>	<b>EMISSION LEVEL (dBuV/m)</b>	<b>READ LEVEL (dBuV)</b>	<b>LIMIT (dBuV/m)</b>	<b>MARGIN (dB)</b>	<b>ANTENNA FACTOR (dB /m)</b>	<b>CABLE LOSS (dB)</b>	<b>PREAMP FACTOR (dB)</b>	<b>ANTENNA HEIGHT (cm)</b>	<b>TABLE ANGLE (Degree)</b>	<b>REMARK</b>
5150	54.66	57.64	74	-19.34	35.95	7.42	46.35	110	10	Peak
5150	48.31	51.29	54	-5.69	35.95	7.42	46.35	110	10	Average
5290	98.42	101.19			36.09	7.45	46.31	110	10	Peak
5290	91.93	94.7			36.09	7.45	46.31	110	10	Average
5350	58.91	61.59	74	-15.09	36.15	7.47	46.3	110	10	Peak
5350	50.89	53.57	54	-3.11	36.15	7.47	46.3	110	10	Average

<b>ANTENNA POLARITY &amp; TEST DISTANCE: VERTICAL AT 3 M</b>										
<b>FREQ. (MHz)</b>	<b>EMISSION LEVEL (dBuV/m)</b>	<b>READ LEVEL (dBuV)</b>	<b>LIMIT (dBuV/m)</b>	<b>MARGIN (dB)</b>	<b>ANTENNA FACTOR (dB /m)</b>	<b>CABLE LOSS (dB)</b>	<b>PREAMP FACTOR (dB)</b>	<b>ANTENNA HEIGHT (cm)</b>	<b>TABLE ANGLE (Degree)</b>	<b>REMARK</b>
5150	55.2	57.84	74	-18.8	36.29	7.42	46.35	145	360	Peak
5150	48.34	50.98	54	-5.66	36.29	7.42	46.35	145	360	Average
5290	94.08	96.57			36.37	7.45	46.31	145	360	Peak
5290	87.48	89.97			36.37	7.45	46.31	145	360	Average
5350	56.88	59.3	74	-17.12	36.41	7.47	46.3	145	360	Peak
5350	50.37	52.79	54	-3.63	36.41	7.47	46.3	145	360	Average

**REMARKS:**

- Emission Level = Read Level+ Antenna Factor + Cable Loss- Preamp Factor  
Margin value = Emission level – Limit value.
- 5290MHz: Fundamental frequency.



Band 3

802.11a

<b>CHANNEL</b>	TX Channel 100	<b>DETECTOR FUNCTION</b>	Peak (PK)
<b>FREQUENCY RANGE</b>	1GHz ~ 40GHz		Average (AV)

**ANTENNA POLARITY & TEST DISTANCE: HORIZONTAL AT 3 M**

FREQ. (MHz)	EMISSION LEVEL (dBuV/m)	READ LEVEL (dBuV)	LIMIT (dBuV/m)	MARGIN (dB)	ANTENNA FACTOR (dB /m)	CABLE LOSS (dB)	PREAMP FACTOR (dB)	ANTENNA HEIGHT (cm)	TABLE ANGLE (Degree)	REMARK
5460	58.73	61.24	74	-15.27	36.26	7.49	46.26	100	30	Peak
5460	48.63	51.14	54	-5.37	36.26	7.49	46.26	100	30	Average
#5470	60.35	62.85	68.3	-7.95	36.27	7.49	46.26	100	30	Peak
5500	104.16	106.61			36.3	7.5	46.25	100	30	Peak
5500	93.39	95.84			36.3	7.5	46.25	100	30	Average

**ANTENNA POLARITY & TEST DISTANCE: VERTICAL AT 3 M**

FREQ. (MHz)	EMISSION LEVEL (dBuV/m)	READ LEVEL (dBuV)	LIMIT (dBuV/m)	MARGIN (dB)	ANTENNA FACTOR (dB /m)	CABLE LOSS (dB)	PREAMP FACTOR (dB)	ANTENNA HEIGHT (cm)	TABLE ANGLE (Degree)	REMARK
5460	58.96	61.25	74	-15.04	36.48	7.49	46.26	100	55	Peak
5460	48.4	50.69	54	-5.6	36.48	7.49	46.26	100	55	Average
#5470	61.17	63.46	68.3	-7.13	36.48	7.49	46.26	100	55	Peak
5500	102.56	104.81			36.5	7.5	46.25	100	55	Peak
5500	93.44	95.69			36.5	7.5	46.25	100	55	Average

**REMARKS:**

1. Emission Level = Read Level+ Antenna Factor + Cable Loss- Preamp Factor  
Margin value = Emission level – Limit value.
2. 5500MHz: Fundamental frequency.
3. #: Out of restricted band.



<b>CHANNEL</b>	TX Channel 116	<b>DETECTOR FUNCTION</b>	Peak (PK)
<b>FREQUENCY RANGE</b>	1GHz ~ 40GHz		Average (AV)

**ANTENNA POLARITY & TEST DISTANCE: HORIZONTAL AT 3 M**

FREQ. (MHz)	EMISSION LEVEL (dBuV/m)	READ LEVEL (dBuV)	LIMIT (dBuV/m)	MARGIN (dB)	ANTENNA FACTOR (dB /m)	CABLE LOSS (dB)	PREAMP FACTOR (dB)	ANTENNA HEIGHT (cm)	TABLE ANGLE (Degree)	REMARK
5460	55.7	58.21	74	-18.3	36.26	7.49	46.26	100	36	Peak
5460	45.81	48.32	54	-8.19	36.26	7.49	46.26	100	36	Average
#5470	56.63	59.13	68.3	-11.67	36.27	7.49	46.26	100	36	Peak
5580	105.54	107.86			36.33	7.58	46.23	100	36	Peak
5580	96.14	98.46			36.33	7.58	46.23	100	36	Average

**ANTENNA POLARITY & TEST DISTANCE: VERTICAL AT 3 M**

FREQ. (MHz)	EMISSION LEVEL (dBuV/m)	READ LEVEL (dBuV)	LIMIT (dBuV/m)	MARGIN (dB)	ANTENNA FACTOR (dB /m)	CABLE LOSS (dB)	PREAMP FACTOR (dB)	ANTENNA HEIGHT (cm)	TABLE ANGLE (Degree)	REMARK
5460	55.57	57.86	74	-18.43	36.48	7.49	46.26	100	58	Peak
5460	45.35	47.64	54	-8.65	36.48	7.49	46.26	100	58	Average
#5470	55.96	58.25	68.3	-12.34	36.48	7.49	46.26	100	58	Peak
5580	104.86	106.96			36.55	7.58	46.23	100	58	Peak
5580	95.53	97.63			36.55	7.58	46.23	100	58	Average

**REMARKS:**

- Emission Level = Read Level+ Antenna Factor + Cable Loss- Preamp Factor  
Margin value = Emission level – Limit value.
- 5580MHz: Fundamental frequency.
- #: Out of restricted band.



<b>CHANNEL</b>	TX Channel 140	<b>DETECTOR FUNCTION</b>	Peak (PK)
<b>FREQUENCY RANGE</b>	1GHz ~ 40GHz		Average (AV)

**ANTENNA POLARITY & TEST DISTANCE: HORIZONTAL AT 3 M**

FREQ. (MHz)	EMISSION LEVEL (dBuV/m)	READ LEVEL (dBuV)	LIMIT (dBuV/m)	MARGIN (dB)	ANTENNA FACTOR (dB /m)	CABLE LOSS (dB)	PREAMP FACTOR (dB)	ANTENNA HEIGHT (cm)	TABLE ANGLE (Degree)	REMARK
5700	105.78	107.89			36.38	7.7	46.19	100	31	Peak
5700	97.47	99.58			36.38	7.7	46.19	100	31	Average
#5725	64.68	66.75	68.3	-3.62	36.39	7.73	46.19	100	31	Peak

**ANTENNA POLARITY & TEST DISTANCE: VERTICAL AT 3 M**

FREQ. (MHz)	EMISSION LEVEL (dBuV/m)	READ LEVEL (dBuV)	LIMIT (dBuV/m)	MARGIN (dB)	ANTENNA FACTOR (dB /m)	CABLE LOSS (dB)	PREAMP FACTOR (dB)	ANTENNA HEIGHT (cm)	TABLE ANGLE (Degree)	REMARK
5700	104.69	106.53			36.63	7.72	46.19	100	52	Peak
5700	95.65	97.49			36.63	7.72	46.19	100	52	Average
#5725	60.59	62.42	68.3	-7.71	36.63	7.73	46.19	100	52	Peak

**REMARKS:**

- Emission Level = Read Level+ Antenna Factor + Cable Loss- Preamp Factor  
Margin value = Emission level – Limit value.
- 5700MHz: Fundamental frequency.
- #: Out of restricted band.





<b>CHANNEL</b>	TX Channel 144	<b>DETECTOR FUNCTION</b>	Peak (PK)
<b>FREQUENCY RANGE</b>	1GHz ~ 40GHz		Average (AV)

**ANTENNA POLARITY & TEST DISTANCE: HORIZONTAL AT 3 M**

FREQ. (MHz)	EMISSION LEVEL (dBuV/m)	READ LEVEL (dBuV)	LIMIT (dBuV/m)	MARGIN (dB)	ANTENNA FACTOR (dB /m)	CABLE LOSS (dB)	PREAMP FACTOR (dB)	ANTENNA HEIGHT (cm)	TABLE ANGLE (Degree)	REMARK
#5470	56.91	59.41	68.3	-11.39	36.27	7.49	46.26	100	200	Peak
5720	106.4	108.48			36.39	7.72	46.19	100	200	Average
5720	97.79	99.87			36.39	7.72	46.19	100	200	Peak
#5850	60.46	62.31	68.3	-7.84	36.44	7.86	46.15	100	200	

**ANTENNA POLARITY & TEST DISTANCE: VERTICAL AT 3 M**

FREQ. (MHz)	EMISSION LEVEL (dBuV/m)	READ LEVEL (dBuV)	LIMIT (dBuV/m)	MARGIN (dB)	ANTENNA FACTOR (dB /m)	CABLE LOSS (dB)	PREAMP FACTOR (dB)	ANTENNA HEIGHT (cm)	TABLE ANGLE (Degree)	REMARK
#5470	56.41	58.7	68.3	-11.89	36.48	7.49	46.26	100	336	Peak
5720	103.81	105.65			36.63	7.72	46.19	100	336	Peak
5720	94.42	96.26			36.63	7.72	46.19	100	336	Average
#5850	59.65	61.23	68.3	-8.65	36.71	7.86	46.15	100	336	Peak

**REMARKS:**

- Emission Level = Read Level+ Antenna Factor + Cable Loss- Preamp Factor  
Margin value = Emission level – Limit value.
- 5720MHz: Fundamental frequency.
- #: Out of restricted band.



802.11n (20MHz)

<b>CHANNEL</b>	TX Channel 100	<b>DETECTOR FUNCTION</b>	Peak (PK)
<b>FREQUENCY RANGE</b>	1GHz ~ 40GHz		Average (AV)

ANTENNA POLARITY & TEST DISTANCE: HORIZONTAL AT 3 M										
FREQ. (MHz)	EMISSION LEVEL (dBuV/m)	READ LEVEL (dBuV)	LIMIT (dBuV/m)	MARGIN (dB)	ANTENNA FACTOR (dB /m)	CABLE LOSS (dB)	PREAMP FACTOR (dB)	ANTENNA HEIGHT (cm)	TABLE ANGLE (Degree)	REMARK
5460	61.74	64.25	74	-12.26	36.26	7.49	46.26	100	32	Peak
5460	49.7	52.21	54	-4.3	36.26	7.49	46.26	100	32	Average
#5470	63.19	65.69	68.3	-5.11	36.27	7.49	46.26	100	32	Peak
5500	104.13	106.58			36.3	7.5	46.25	100	32	Peak
5500	95	97.45			36.3	7.5	46.25	100	32	Average
ANTENNA POLARITY & TEST DISTANCE: VERTICAL AT 3 M										
FREQ. (MHz)	EMISSION LEVEL (dBuV/m)	READ LEVEL (dBuV)	LIMIT (dBuV/m)	MARGIN (dB)	ANTENNA FACTOR (dB /m)	CABLE LOSS (dB)	PREAMP FACTOR (dB)	ANTENNA HEIGHT (cm)	TABLE ANGLE (Degree)	REMARK
5460	59.06	61.35	74	-14.94	36.48	7.49	46.26	100	51	Peak
5460	49.13	51.42	54	-4.87	36.48	7.49	46.26	100	51	Average
#5470	102.31	104.56	68.3	34.01	36.5	7.5	46.25	100	51	Peak
5500	92.99	95.24			36.5	7.5	46.25	100	51	Peak
5500	60.83	62.63			36.64	7.74	46.18	100	51	Average

REMARKS:

- Emission Level = Read Level+ Antenna Factor + Cable Loss- Preamp Factor  
Margin value = Emission level – Limit value.
- 5500MHz: Fundamental frequency.
- #: Out of restricted band.



<b>CHANNEL</b>	TX Channel 116	<b>DETECTOR FUNCTION</b>	Peak (PK)
<b>FREQUENCY RANGE</b>	1GHz ~ 40GHz		Average (AV)

**ANTENNA POLARITY & TEST DISTANCE: HORIZONTAL AT 3 M**

FREQ. (MHz)	EMISSION LEVEL (dBuV/m)	READ LEVEL (dBuV)	LIMIT (dBuV/m)	MARGIN (dB)	ANTENNA FACTOR (dB /m)	CABLE LOSS (dB)	PREAMP FACTOR (dB)	ANTENNA HEIGHT (cm)	TABLE ANGLE (Degree)	REMARK
5460	55.38	57.89	74	-18.62	36.26	7.49	46.26	100	35	Peak
5460	46.24	48.75	54	-7.76	36.26	7.49	46.26	100	35	Average
#5470	56.71	59.21	68.3	-11.59	36.27	7.49	46.26	100	35	Peak
5580	104.28	106.6			36.33	7.58	46.23	100	35	Peak
5580	94	96.32			36.33	7.58	46.23	100	35	Average

**ANTENNA POLARITY & TEST DISTANCE: VERTICAL AT 3 M**

FREQ. (MHz)	EMISSION LEVEL (dBuV/m)	READ LEVEL (dBuV)	LIMIT (dBuV/m)	MARGIN (dB)	ANTENNA FACTOR (dB /m)	CABLE LOSS (dB)	PREAMP FACTOR (dB)	ANTENNA HEIGHT (cm)	TABLE ANGLE (Degree)	REMARK
5460	56.07	58.36	74	-17.93	36.48	7.49	46.26	100	56	Peak
5460	45.86	48.15	54	-8.14	36.48	7.49	46.26	100	56	Average
#5470	58.13	60.42	68.3	-10.17	36.48	7.49	46.26	100	56	Peak
5580	102.15	104.25			36.55	7.58	46.23	100	56	Peak
5580	93.38	95.48			36.55	7.58	46.23	100	56	Average

**REMARKS:**

- Emission Level = Read Level+ Antenna Factor + Cable Loss- Preamp Factor  
Margin value = Emission level – Limit value.
- 5580MHz: Fundamental frequency.
- #: Out of restricted band.



<b>CHANNEL</b>	TX Channel 140	<b>DETECTOR FUNCTION</b>	Peak (PK)
<b>FREQUENCY RANGE</b>	1GHz ~ 40GHz		Average (AV)

ANTENNA POLARITY & TEST DISTANCE: HORIZONTAL AT 3 M										
FREQ. (MHz)	EMISSION LEVEL (dBuV/m)	READ LEVEL (dBuV)	LIMIT (dBuV/m)	MARGIN (dB)	ANTENNA FACTOR (dB /m)	CABLE LOSS (dB)	PREAMP FACTOR (dB)	ANTENNA HEIGHT (cm)	TABLE ANGLE (Degree)	REMARK
5700	105.1	107.21			36.38	7.7	46.19	100	31	Peak
5700	96.46	98.57			36.38	7.7	46.19	100	31	Average
#5725	66.78	68.85	68.3	-1.52	36.39	7.73	46.19	100	31	Peak
ANTENNA POLARITY & TEST DISTANCE: VERTICAL AT 3 M										
FREQ. (MHz)	EMISSION LEVEL (dBuV/m)	READ LEVEL (dBuV)	LIMIT (dBuV/m)	MARGIN (dB)	ANTENNA FACTOR (dB /m)	CABLE LOSS (dB)	PREAMP FACTOR (dB)	ANTENNA HEIGHT (cm)	TABLE ANGLE (Degree)	REMARK
5700	103.77	105.64			36.62	7.7	46.19	100	52	Peak
5700	94.76	96.63			36.62	7.7	46.19	100	52	Average
#5725	61.63	63.46	68.3	-6.67	36.63	7.73	46.19	100	52	Peak

**REMARKS:**

- Emission Level = Read Level+ Antenna Factor + Cable Loss- Preamp Factor  
Margin value = Emission level – Limit value.
- 5700MHz: Fundamental frequency.
- #: Out of restricted band.



<b>CHANNEL</b>	TX Channel 144	<b>DETECTOR FUNCTION</b>	Peak (PK)
<b>FREQUENCY RANGE</b>	1GHz ~ 40GHz		Average (AV)

**ANTENNA POLARITY & TEST DISTANCE: HORIZONTAL AT 3 M**

FREQ. (MHz)	EMISSION LEVEL (dBuV/m)	READ LEVEL (dBuV)	LIMIT (dBuV/m)	MARGIN (dB)	ANTENNA FACTOR (dB /m)	CABLE LOSS (dB)	PREAMP FACTOR (dB)	ANTENNA HEIGHT (cm)	TABLE ANGLE (Degree)	REMARK
#5470	55.62	58.12	68.3	-12.68	36.27	7.49	46.26	100	205	Peak
5720	106.64	108.72			36.39	7.72	46.19	100	205	Peak
5720	97.7	99.78			36.39	7.72	46.19	100	205	Average
#5850	60.78	62.63	68.3	-7.52	36.44	7.86	46.15	100	205	Peak

**ANTENNA POLARITY & TEST DISTANCE: VERTICAL AT 3 M**

FREQ. (MHz)	EMISSION LEVEL (dBuV/m)	READ LEVEL (dBuV)	LIMIT (dBuV/m)	MARGIN (dB)	ANTENNA FACTOR (dB /m)	CABLE LOSS (dB)	PREAMP FACTOR (dB)	ANTENNA HEIGHT (cm)	TABLE ANGLE (Degree)	REMARK
#5470	56.51	58.8	68.3	-11.79	36.48	7.49	46.26	100	321	Peak
5720	104.53	106.37			36.63	7.72	46.19	100	321	Peak
5720	95.62	97.46			36.63	7.72	46.19	100	321	Average
#5850	60.26	61.84	68.3	-8.04	36.71	7.86	46.15	100	321	Peak

**REMARKS:**

- Emission Level = Read Level+ Antenna Factor + Cable Loss- Preamp Factor  
Margin value = Emission level – Limit value.
- 5720MHz: Fundamental frequency.
- #: Out of restricted band.



**802.11n (40MHz)**

<b>CHANNEL</b>	TX Channel 102	<b>DETECTOR FUNCTION</b>	Peak (PK)
<b>FREQUENCY RANGE</b>	1GHz ~ 40GHz		Average (AV)

<b>ANTENNA POLARITY &amp; TEST DISTANCE: HORIZONTAL AT 3 M</b>										
FREQ. (MHz)	EMISSION LEVEL (dBuV/m)	READ LEVEL (dBuV)	LIMIT (dBuV/m)	MARGIN (dB)	ANTENNA FACTOR (dB /m)	CABLE LOSS (dB)	PREAMP FACTOR (dB)	ANTENNA HEIGHT (cm)	TABLE ANGLE (Degree)	REMARK
5460	50.92	52.24	74	-23.08	34.77	10.17	46.26	200	305	Peak
5460	48.06	49.38	54	-5.94	34.77	10.17	46.26	200	305	Average
#5470	52.75	54.04	74	-21.25	34.78	10.19	46.26	200	305	Peak
5510	92.89	94.03			34.81	10.3	46.25	200	305	Peak
5510	89.01	90.15			34.81	10.3	46.25	200	305	Average

<b>ANTENNA POLARITY &amp; TEST DISTANCE: VERTICAL AT 3 M</b>										
FREQ. (MHz)	EMISSION LEVEL (dBuV/m)	READ LEVEL (dBuV)	LIMIT (dBuV/m)	MARGIN (dB)	ANTENNA FACTOR (dB /m)	CABLE LOSS (dB)	PREAMP FACTOR (dB)	ANTENNA HEIGHT (cm)	TABLE ANGLE (Degree)	REMARK
5460	56.05	57.54	74	-17.95	34.6	10.17	46.26	165	265	Peak
5460	50.82	52.31	54	-3.18	34.6	10.17	46.26	165	265	Average
#5470	58.92	60.39	74	-15.08	34.6	10.19	46.26	165	265	Peak
5510	100.24	101.58			34.61	10.3	46.25	165	265	Peak
5510	95.64	96.98			34.61	10.3	46.25	165	265	Average

**REMARKS:**

- Emission Level = Read Level+ Antenna Factor + Cable Loss- Preamp Factor  
Margin value = Emission level – Limit value.
- 5510MHz: Fundamental frequency.
- #: Out of restricted band.



<b>CHANNEL</b>	TX Channel 110	<b>DETECTOR FUNCTION</b>	Peak (PK)
<b>FREQUENCY RANGE</b>	1GHz ~ 40GHz		Average (AV)

**ANTENNA POLARITY & TEST DISTANCE: HORIZONTAL AT 3 M**

FREQ. (MHz)	EMISSION LEVEL (dBuV/m)	READ LEVEL (dBuV)	LIMIT (dBuV/m)	MARGIN (dB)	ANTENNA FACTOR (dB /m)	CABLE LOSS (dB)	PREAMP FACTOR (dB)	ANTENNA HEIGHT (cm)	TABLE ANGLE (Degree)	REMARK
5460	56.45	58.96	74	-17.55	36.26	7.49	46.26	100	248	Peak
5460	46.16	48.67	54	-7.84	36.26	7.49	46.26	100	248	Average
#5470	58.61	61.11	68.3	-9.69	36.27	7.49	46.26	100	248	Peak
5550	98.28	100.65			36.32	7.55	46.24	100	248	Peak
5550	89.11	91.48			36.32	7.55	46.24	100	248	Average

**ANTENNA POLARITY & TEST DISTANCE: VERTICAL AT 3 M**

FREQ. (MHz)	EMISSION LEVEL (dBuV/m)	READ LEVEL (dBuV)	LIMIT (dBuV/m)	MARGIN (dB)	ANTENNA FACTOR (dB /m)	CABLE LOSS (dB)	PREAMP FACTOR (dB)	ANTENNA HEIGHT (cm)	TABLE ANGLE (Degree)	REMARK
5460	56.92	59.21	74	-17.08	36.48	7.49	46.26	100	336	Peak
5460	45.83	48.12	54	-8.17	36.48	7.49	46.26	100	336	Average
#5470	58.26	60.55	68.3	-10.04	36.48	7.49	46.26	100	336	Peak
5550	96.54	98.7			36.53	7.55	46.24	100	336	Peak
5550	88.17	90.33			36.53	7.55	46.24	100	336	Average

**REMARKS:**

- Emission Level = Read Level+ Antenna Factor + Cable Loss- Preamp Factor  
Margin value = Emission level – Limit value.
- 5500MHz: Fundamental frequency.
- #: Out of restricted band.



<b>CHANNEL</b>	TX Channel 134	<b>DETECTOR FUNCTION</b>	Peak (PK)
<b>FREQUENCY RANGE</b>	1GHz ~ 40GHz		Average (AV)

**ANTENNA POLARITY & TEST DISTANCE: HORIZONTAL AT 3 M**

FREQ. (MHz)	EMISSION LEVEL (dBuV/m)	READ LEVEL (dBuV)	LIMIT (dBuV/m)	MARGIN (dB)	ANTENNA FACTOR (dB /m)	CABLE LOSS (dB)	PREAMP FACTOR (dB)	ANTENNA HEIGHT (cm)	TABLE ANGLE (Degree)	REMARK
5670	98.05	100.21			36.37	7.67	46.2	100	31	Peak
5670	89.09	91.25			36.37	7.67	46.2	100	31	Average
#5725	59.28	61.35	68.3	-9.02	36.39	7.73	46.19	100	31	Peak

**ANTENNA POLARITY & test distance: Vertical at 3 m**

FREQ. (MHz)	EMISSION LEVEL (dBuV/m)	READ LEVEL (dBuV)	LIMIT (dBuV/m)	MARGIN (dB)	ANTENNA FACTOR (dB /m)	CABLE LOSS (dB)	PREAMP FACTOR (dB)	ANTENNA HEIGHT (cm)	TABLE ANGLE (Degree)	REMARK
5670	97.39	99.32			36.6	7.67	46.2	100	325	Peak
5670	88.52	90.45			36.6	7.67	46.2	100	325	Average
#5725	60.59	62.42	68.3	-7.71	36.63	7.73	46.19	100	325	Peak

**REMARKS:**

- Emission Level = Read Level+ Antenna Factor + Cable Loss- Preamp Factor  
Margin value = Emission level – Limit value.
- 5670MHz: Fundamental frequency.
- #: Out of restricted band.





<b>CHANNEL</b>	TX Channel 142	<b>DETECTOR FUNCTION</b>	Peak (PK)
<b>FREQUENCY RANGE</b>	1GHz ~ 40GHz		Average (AV)

**ANTENNA POLARITY & TEST DISTANCE: HORIZONTAL AT 3 M**

FREQ. (MHz)	EMISSION LEVEL (dBuV/m)	READ LEVEL (dBuV)	LIMIT (dBuV/m)	MARGIN (dB)	ANTENNA FACTOR (dB /m)	CABLE LOSS (dB)	PREAMP FACTOR (dB)	ANTENNA HEIGHT (cm)	TABLE ANGLE (Degree)	REMARK
#5470	55.46	57.96	68.3	-12.84	36.27	7.49	46.26	100	202	Peak
5710	103.6	105.7			36.38	7.71	46.19	100	202	Peak
5710	94.45	96.55			36.38	7.71	46.19	100	202	Average
#5850	60.49	62.34	68.3	-7.81	36.44	7.86	46.15	100	202	Peak

**ANTENNA POLARITY & test distance: Vertical at 3 m**

FREQ. (MHz)	EMISSION LEVEL (dBuV/m)	READ LEVEL (dBuV)	LIMIT (dBuV/m)	MARGIN (dB)	ANTENNA FACTOR (dB /m)	CABLE LOSS (dB)	PREAMP FACTOR (dB)	ANTENNA HEIGHT (cm)	TABLE ANGLE (Degree)	REMARK
#5470	55.98	58.27	68.3	-12.32	36.48	7.49	46.26	100	326	Peak
5710	101.36	103.21			36.63	7.71	46.19	100	326	Peak
5710	92.71	94.56			36.63	7.71	46.19	100	326	Average
#5850	60.79	62.37	68.3	-7.51	36.71	7.86	46.15	100	326	Peak

**REMARKS:**

- Emission Level = Read Level+ Antenna Factor + Cable Loss- Preamp Factor  
Margin value = Emission level – Limit value.
- 5710MHz: Fundamental frequency.
- #: Out of restricted band.



802.11ac (20MHz)

<b>CHANNEL</b>	TX Channel 100	<b>DETECTOR FUNCTION</b>	Peak (PK)
<b>FREQUENCY RANGE</b>	1GHz ~ 40GHz		Average (AV)

ANTENNA POLARITY & TEST DISTANCE: HORIZONTAL AT 3 M										
FREQ. (MHz)	EMISSION LEVEL (dBuV/m)	READ LEVEL (dBuV)	LIMIT (dBuV/m)	MARGIN (dB)	ANTENNA FACTOR (dB /m)	CABLE LOSS (dB)	PREAMP FACTOR (dB)	ANTENNA HEIGHT (cm)	TABLE ANGLE (Degree)	REMARK
5460	61.07	63.58	74	-12.93	36.26	7.49	46.26	100	32	Peak
5460	49.81	52.32	54	-4.19	36.26	7.49	46.26	100	32	Average
#5470	62.06	64.56	68.3	-6.24	36.27	7.49	46.26	100	32	Peak
5500	105.2	107.65			36.3	7.5	46.25	100	32	Peak
5500	95.79	98.24			36.3	7.5	46.25	100	32	Average
ANTENNA POLARITY & TEST DISTANCE: VERTICAL AT 3 M										
FREQ. (MHz)	EMISSION LEVEL (dBuV/m)	READ LEVEL (dBuV)	LIMIT (dBuV/m)	MARGIN (dB)	ANTENNA FACTOR (dB /m)	CABLE LOSS (dB)	PREAMP FACTOR (dB)	ANTENNA HEIGHT (cm)	TABLE ANGLE (Degree)	REMARK
5460	60.05	62.34	74	-13.95	36.48	7.49	46.26	100	59	Peak
5460	47.99	50.28	54	-6.01	36.48	7.49	46.26	100	59	Average
#5470	60.87	63.16	68.3	-7.43	36.48	7.49	46.26	100	59	Peak
5500	103.44	105.69			36.5	7.5	46.25	100	59	Peak
5500	94.14	96.39			36.5	7.5	46.25	100	59	Average

**REMARKS:**

- Emission Level = Read Level+ Antenna Factor + Cable Loss- Preamp Factor  
Margin value = Emission level – Limit value.
- 5500MHz: Fundamental frequency.
- #: Out of restricted band.



<b>CHANNEL</b>	TX Channel 116	<b>DETECTOR FUNCTION</b>	Peak (PK)
<b>FREQUENCY RANGE</b>	1GHz ~ 40GHz		Average (AV)

**ANTENNA POLARITY & TEST DISTANCE: HORIZONTAL AT 3 M**

FREQ. (MHz)	EMISSION LEVEL (dBuV/m)	READ LEVEL (dBuV)	LIMIT (dBuV/m)	MARGIN (dB)	ANTENNA FACTOR (dB /m)	CABLE LOSS (dB)	PREAMP FACTOR (dB)	ANTENNA HEIGHT (cm)	TABLE ANGLE (Degree)	REMARK
5460	56.24	58.75	74	-17.76	36.26	7.49	46.26	100	29	Peak
5460	46.05	48.56	54	-7.95	36.26	7.49	46.26	100	29	Average
#5470	59.53	62.03	68.3	-8.77	36.27	7.49	46.26	100	29	Peak
5580	105.23	107.55			36.33	7.58	46.23	100	29	Peak
5580	96.32	98.64			36.33	7.58	46.23	100	29	Average

**ANTENNA POLARITY & TEST DISTANCE: VERTICAL AT 3 M**

FREQ. (MHz)	EMISSION LEVEL (dBuV/m)	READ LEVEL (dBuV)	LIMIT (dBuV/m)	MARGIN (dB)	ANTENNA FACTOR (dB /m)	CABLE LOSS (dB)	PREAMP FACTOR (dB)	ANTENNA HEIGHT (cm)	TABLE ANGLE (Degree)	REMARK
5460	56.68	58.97	74	-17.32	36.48	7.49	46.26	100	55	Peak
5460	46.3	48.59	54	-7.7	36.48	7.49	46.26	100	55	Average
#5470	58.77	61.06	68.3	-9.53	36.48	7.49	46.26	100	55	Peak
5580	102.16	104.26			36.55	7.58	46.23	100	55	Peak
5580	93.51	95.61			36.55	7.58	46.23	100	55	Average

**REMARKS:**

- Emission Level = Read Level+ Antenna Factor + Cable Loss- Preamp Factor  
Margin value = Emission level – Limit value.
- 5580MHz: Fundamental frequency.
- #: Out of restricted band.



<b>CHANNEL</b>	TX Channel 140	<b>DETECTOR FUNCTION</b>	Peak (PK)
<b>FREQUENCY RANGE</b>	1GHz ~ 40GHz		Average (AV)

**ANTENNA POLARITY & TEST DISTANCE: HORIZONTAL AT 3 M**

FREQ. (MHz)	EMISSION LEVEL (dBuV/m)	READ LEVEL (dBuV)	LIMIT (dBuV/m)	MARGIN (dB)	ANTENNA FACTOR (dB /m)	CABLE LOSS (dB)	PREAMP FACTOR (dB)	ANTENNA HEIGHT (cm)	TABLE ANGLE (Degree)	REMARK
5700	105.37	107.48			36.38	7.7	46.19	100	32	Peak
5700	95.99	98.1			36.38	7.7	46.19	100	32	Average
#5725	64.79	66.86	68.3	-3.51	36.39	7.73	46.19	100	32	Peak

**ANTENNA POLARITY & TEST DISTANCE: VERTICAL AT 3 M**

FREQ. (MHz)	EMISSION LEVEL (dBuV/m)	READ LEVEL (dBuV)	LIMIT (dBuV/m)	MARGIN (dB)	ANTENNA FACTOR (dB /m)	CABLE LOSS (dB)	PREAMP FACTOR (dB)	ANTENNA HEIGHT (cm)	TABLE ANGLE (Degree)	REMARK
5720	102.38	104.22			36.63	7.72	46.19	100	62	Peak
5720	62.76	64.6			36.63	7.72	46.19	100	62	Average
#5725	93.46	95.29	68.3	25.16	36.63	7.73	46.19	100	62	Peak

**REMARKS:**

- Emission Level = Read Level+ Antenna Factor + Cable Loss- Preamp Factor  
Margin value = Emission level – Limit value.
- 5700MHz: Fundamental frequency.
- #: Out of restricted band.



<b>CHANNEL</b>	TX Channel 144	<b>DETECTOR FUNCTION</b>	Peak (PK)
<b>FREQUENCY RANGE</b>	1GHz ~ 40GHz		Average (AV)

**ANTENNA POLARITY & TEST DISTANCE: HORIZONTAL AT 3 M**

FREQ. (MHz)	EMISSION LEVEL (dBuV/m)	READ LEVEL (dBuV)	LIMIT (dBuV/m)	MARGIN (dB)	ANTENNA FACTOR (dB /m)	CABLE LOSS (dB)	PREAMP FACTOR (dB)	ANTENNA HEIGHT (cm)	TABLE ANGLE (Degree)	REMARK
#5470	55.99	58.49	68.3	-12.31	36.27	7.49	46.26	100	206	Peak
5720	106.71	108.79			36.39	7.72	46.19	100	206	Peak
5720	97.34	99.42			36.39	7.72	46.19	100	206	Average
#5850	59.38	61.23	68.3	-8.92	36.44	7.86	46.15	100	206	Peak

**ANTENNA POLARITY & TEST DISTANCE: VERTICAL AT 3 M**

FREQ. (MHz)	EMISSION LEVEL (dBuV/m)	READ LEVEL (dBuV)	LIMIT (dBuV/m)	MARGIN (dB)	ANTENNA FACTOR (dB /m)	CABLE LOSS (dB)	PREAMP FACTOR (dB)	ANTENNA HEIGHT (cm)	TABLE ANGLE (Degree)	REMARK
#5470	56.71	59	68.3	-11.59	36.48	7.49	46.26	100	325	Peak
5720	104.72	106.56			36.63	7.72	46.19	100	325	Peak
5720	95.73	97.57			36.63	7.72	46.19	100	325	Average
#5850	59.69	61.27	68.3	-8.61	36.71	7.86	46.15	100	325	Peak

**REMARKS:**

- Emission Level = Read Level+ Antenna Factor + Cable Loss- Preamp Factor  
Margin value = Emission level – Limit value.
- 5720MHz: Fundamental frequency.
- #: Out of restricted band.



802.11ac (40MHz)

<b>CHANNEL</b>	TX Channel 102	<b>DETECTOR FUNCTION</b>	Peak (PK)
<b>FREQUENCY RANGE</b>	1GHz ~ 40GHz		Average (AV)

**ANTENNA POLARITY & TEST DISTANCE: HORIZONTAL AT 3 M**

FREQ. (MHz)	EMISSION LEVEL (dBuV/m)	READ LEVEL (dBuV)	LIMIT (dBuV/m)	MARGIN (dB)	ANTENNA FACTOR (dB /m)	CABLE LOSS (dB)	PREAMP FACTOR (dB)	ANTENNA HEIGHT (cm)	TABLE ANGLE (Degree)	REMARK
5460	60.07	62.58	74	-13.93	36.26	7.49	46.26	100	35	Peak
5460	49.85	52.36	54	-4.15	36.26	7.49	46.26	100	35	Average
#5470	61.37	63.87	68.3	-6.93	36.27	7.49	46.26	100	35	Peak
5510	97.13	99.57			36.3	7.51	46.25	100	35	Peak
5510	88.8	91.24			36.3	7.51	46.25	100	35	Average

**ANTENNA POLARITY & TEST DISTANCE: VERTICAL AT 3 M**

FREQ. (MHz)	EMISSION LEVEL (dBuV/m)	READ LEVEL (dBuV)	LIMIT (dBuV/m)	MARGIN (dB)	ANTENNA FACTOR (dB /m)	CABLE LOSS (dB)	PREAMP FACTOR (dB)	ANTENNA HEIGHT (cm)	TABLE ANGLE (Degree)	REMARK
5460	59.72	62.01	74	-14.28	36.48	7.49	46.26	100	332	Peak
5460	48.99	51.28	54	-5.01	36.48	7.49	46.26	100	332	Average
#5470	60.95	63.24	68.3	-7.35	36.48	7.49	46.26	100	332	Peak
5510	96.19	98.42			36.51	7.51	46.25	100	332	Peak
5510	87.92	90.15			36.51	7.51	46.25	100	332	Average

**REMARKS:**

- Emission Level = Read Level+ Antenna Factor + Cable Loss- Preamp Factor  
Margin value = Emission level – Limit value.
- 5510MHz: Fundamental frequency.
- #: Out of restricted band.



<b>CHANNEL</b>	TX Channel 110	<b>DETECTOR FUNCTION</b>	Peak (PK)
<b>FREQUENCY RANGE</b>	1GHz ~ 40GHz		Average (AV)

**ANTENNA POLARITY & TEST DISTANCE: HORIZONTAL AT 3 M**

FREQ. (MHz)	EMISSION LEVEL (dBuV/m)	READ LEVEL (dBuV)	LIMIT (dBuV/m)	MARGIN (dB)	ANTENNA FACTOR (dB /m)	CABLE LOSS (dB)	PREAMP FACTOR (dB)	ANTENNA HEIGHT (cm)	TABLE ANGLE (Degree)	REMARK
5460	56.18	58.69	74	-17.82	36.26	7.49	46.26	100	35	Peak
5460	45.7	48.21	54	-8.3	36.26	7.49	46.26	100	35	Average
#5470	57.63	60.13	68.3	-10.67	36.27	7.49	46.26	100	35	Peak
5500	97.85	100.22			36.32	7.55	46.24	100	35	Peak
5500	89.18	91.55			36.32	7.55	46.24	100	35	Average

**ANTENNA POLARITY & TEST DISTANCE: VERTICAL AT 3 M**

FREQ. (MHz)	EMISSION LEVEL (dBuV/m)	READ LEVEL (dBuV)	LIMIT (dBuV/m)	MARGIN (dB)	ANTENNA FACTOR (dB /m)	CABLE LOSS (dB)	PREAMP FACTOR (dB)	ANTENNA HEIGHT (cm)	TABLE ANGLE (Degree)	REMARK
5460	56.03	58.32	74	-17.97	36.48	7.49	46.26	100	325	Peak
5460	46.22	48.51	54	-7.78	36.48	7.49	46.26	100	325	Average
#5470	57.96	60.25	68.3	-10.34	36.48	7.49	46.26	100	325	Peak
5500	95.74	97.9			36.53	7.55	46.24	100	325	Peak
5500	87.47	89.63			36.53	7.55	46.24	100	325	Average

**REMARKS:**

- Emission Level = Read Level+ Antenna Factor + Cable Loss- Preamp Factor  
Margin value = Emission level – Limit value.
- 5500MHz: Fundamental frequency.
- #: Out of restricted band.



<b>CHANNEL</b>	TX Channel 134	<b>DETECTOR FUNCTION</b>	Peak (PK)
<b>FREQUENCY RANGE</b>	1GHz ~ 40GHz		Average (AV)

**ANTENNA POLARITY & TEST DISTANCE: HORIZONTAL AT 3 M**

FREQ. (MHz)	EMISSION LEVEL (dBuV/m)	READ LEVEL (dBuV)	LIMIT (dBuV/m)	MARGIN (dB)	ANTENNA FACTOR (dB /m)	CABLE LOSS (dB)	PREAMP FACTOR (dB)	ANTENNA HEIGHT (cm)	TABLE ANGLE (Degree)	REMARK
5670	97.47	99.63			36.37	7.67	46.2	100	31	Peak
5670	89.36	91.52			36.37	7.67	46.2	100	31	Average
#5725	61.51	63.58	68.3	-6.79	36.39	7.73	46.19	100	31	Peak

**ANTENNA POLARITY & TEST DISTANCE: VERTICAL AT 3 M**

FREQ. (MHz)	EMISSION LEVEL (dBuV/m)	READ LEVEL (dBuV)	LIMIT (dBuV/m)	MARGIN (dB)	ANTENNA FACTOR (dB /m)	CABLE LOSS (dB)	PREAMP FACTOR (dB)	ANTENNA HEIGHT (cm)	TABLE ANGLE (Degree)	REMARK
5670	96.39	98.32			36.6	7.67	46.2	100	328	Peak
5670	89.19	91.12			36.6	7.67	46.2	100	328	Average
#5725	60.66	62.49	68.3	-7.64	36.63	7.73	46.19	100	328	Peak

**REMARKS:**

- Emission Level = Read Level+ Antenna Factor + Cable Loss- Preamp Factor  
Margin value = Emission level – Limit value.
- 5670MHz: Fundamental frequency.
- #: Out of restricted band.





<b>CHANNEL</b>	TX Channel 142	<b>DETECTOR FUNCTION</b>	Peak (PK)
<b>FREQUENCY RANGE</b>	1GHz ~ 40GHz		Average (AV)

**ANTENNA POLARITY & TEST DISTANCE: HORIZONTAL AT 3 M**

FREQ. (MHz)	EMISSION LEVEL (dBuV/m)	READ LEVEL (dBuV)	LIMIT (dBuV/m)	MARGIN (dB)	ANTENNA FACTOR (dB /m)	CABLE LOSS (dB)	PREAMP FACTOR (dB)	ANTENNA HEIGHT (cm)	TABLE ANGLE (Degree)	REMARK
#5470	55.48	57.98	68.3	-12.82	36.27	7.49	46.26	100	205	Peak
5710	102.12	104.22			36.38	7.71	46.19	100	205	Peak
5710	93.59	95.69			36.38	7.71	46.19	100	205	Average
#5850	60.99	62.84	68.3	-7.31	36.44	7.86	46.15	100	205	Peak

**ANTENNA POLARITY & TEST DISTANCE: VERTICAL AT 3 M**

FREQ. (MHz)	EMISSION LEVEL (dBuV/m)	READ LEVEL (dBuV)	LIMIT (dBuV/m)	MARGIN (dB)	ANTENNA FACTOR (dB /m)	CABLE LOSS (dB)	PREAMP FACTOR (dB)	ANTENNA HEIGHT (cm)	TABLE ANGLE (Degree)	REMARK
#5470	56.18	58.47	68.3	-12.12	36.48	7.49	46.26	100	328	Peak
5710	100.47	102.32			36.63	7.71	46.19	100	328	Peak
5710	91.81	93.66			36.63	7.71	46.19	100	328	Average
#5850	60.81	62.39	68.3	-7.49	36.71	7.86	46.15	100	328	Peak

**REMARKS:**

- Emission Level = Read Level+ Antenna Factor + Cable Loss- Preamp Factor  
Margin value = Emission level – Limit value.
- 5710MHz: Fundamental frequency.
- #: Out of restricted band.



802.11ac (80MHz)

CHANNEL	TX Channel 106	DETECTOR FUNCTION	Peak (PK)
FREQUENCY RANGE	1GHz ~ 40GHz		Average (AV)

ANTENNA POLARITY & TEST DISTANCE: HORIZONTAL AT 3 M

FREQ. (MHz)	EMISSION LEVEL (dBuV/m)	READ LEVEL (dBuV)	LIMIT (dBuV/m)	MARGIN (dB)	ANTENNA FACTOR (dB /m)	CABLE LOSS (dB)	PREAMP FACTOR (dB)	ANTENNA HEIGHT (cm)	TABLE ANGLE (Degree)	REMARK
5460	59.43	61.94	74	-14.57	36.26	7.49	46.26	100	32	Peak
5460	49.12	51.63	54	-4.88	36.26	7.49	46.26	100	32	Average
#5470	60.75	63.25	68.3	-7.55	36.27	7.49	46.26	100	32	Peak
5530	93.85	96.25			36.31	7.53	46.24	100	32	Peak
5530	85.19	87.59			36.31	7.53	46.24	100	32	Average

ANTENNA POLARITY & TEST DISTANCE: VERTICAL AT 3 M

FREQ. (MHz)	EMISSION LEVEL (dBuV/m)	READ LEVEL (dBuV)	LIMIT (dBuV/m)	MARGIN (dB)	ANTENNA FACTOR (dB /m)	CABLE LOSS (dB)	PREAMP FACTOR (dB)	ANTENNA HEIGHT (cm)	TABLE ANGLE (Degree)	REMARK
5460	60.02	62.31	74	-13.98	36.48	7.49	46.26	100	321	Peak
5460	48.56	50.85	54	-5.44	36.48	7.49	46.26	100	321	Average
#5470	60.84	63.13	68.3	-7.46	36.48	7.49	46.26	100	321	Peak
5530	93.02	95.21			36.52	7.53	46.24	100	321	Peak
5530	84.34	86.53			36.52	7.53	46.24	100	321	Average

REMARKS:

- Emission Level = Read Level+ Antenna Factor + Cable Loss- Preamp Factor  
Margin value = Emission level – Limit value.
- 5530MHz: Fundamental frequency.
- #: Out of restricted band.



<b>CHANNEL</b>	TX Channel 122	<b>DETECTOR FUNCTION</b>	Peak (PK)
<b>FREQUENCY RANGE</b>	1GHz ~ 40GHz		Average (AV)

ANTENNA POLARITY & TEST DISTANCE: HORIZONTAL AT 3 M										
FREQ. (MHz)	EMISSION LEVEL (dBuV/m)	READ LEVEL (dBuV)	LIMIT (dBuV/m)	MARGIN (dB)	ANTENNA FACTOR (dB /m)	CABLE LOSS (dB)	PREAMP FACTOR (dB)	ANTENNA HEIGHT (cm)	TABLE ANGLE (Degree)	REMARK
5610	94.32	96.59			36.34	7.61	46.22	100	36	Peak
5610	85.28	87.55			36.34	7.61	46.22	100	36	Average
#5725	61.79	63.86	68.3	-6.51	36.39	7.73	46.19	100	36	Peak
ANTENNA POLARITY & TEST DISTANCE: VERTICAL AT 3 M										
FREQ. (MHz)	EMISSION LEVEL (dBuV/m)	READ LEVEL (dBuV)	LIMIT (dBuV/m)	MARGIN (dB)	ANTENNA FACTOR (dB /m)	CABLE LOSS (dB)	PREAMP FACTOR (dB)	ANTENNA HEIGHT (cm)	TABLE ANGLE (Degree)	REMARK
5610	92.08	94.12			36.57	7.61	46.22	100	326	Peak
5610	83.6	85.64			36.57	7.61	46.22	100	326	Average
#5725	60.73	62.56	68.3	-7.57	36.63	7.73	46.19	100	326	Peak

**REMARKS:**

1. Emission Level = Read Level+ Antenna Factor + Cable Loss- Preamp Factor  
Margin value = Emission level – Limit value.
2. 5610MHz: Fundamental frequency.
3. #: Out of restricted band.



<b>CHANNEL</b>	TX Channel 138	<b>DETECTOR FUNCTION</b>	Peak (PK)
<b>FREQUENCY RANGE</b>	1GHz ~ 40GHz		Average (AV)

**ANTENNA POLARITY & TEST DISTANCE: HORIZONTAL AT 3 M**

FREQ. (MHz)	EMISSION LEVEL (dBuV/m)	READ LEVEL (dBuV)	LIMIT (dBuV/m)	MARGIN (dB)	ANTENNA FACTOR (dB /m)	CABLE LOSS (dB)	PREAMP FACTOR (dB)	ANTENNA HEIGHT (cm)	TABLE ANGLE (Degree)	REMARK
#5470	56.46	58.96	68.3	-11.84	36.27	7.49	46.26	100	201	Peak
5690	101.48	103.61			36.38	7.69	46.2	100	201	Peak
5690	92.45	94.58			36.38	7.69	46.2	100	201	Average
#5850	61.44	63.29	68.3	-6.86	36.44	7.86	46.15	100	201	Peak

**ANTENNA POLARITY & TEST DISTANCE: VERTICAL AT 3 M**

FREQ. (MHz)	EMISSION LEVEL (dBuV/m)	READ LEVEL (dBuV)	LIMIT (dBuV/m)	MARGIN (dB)	ANTENNA FACTOR (dB /m)	CABLE LOSS (dB)	PREAMP FACTOR (dB)	ANTENNA HEIGHT (cm)	TABLE ANGLE (Degree)	REMARK
#5470	55.67	57.96	68.3	-12.63	36.48	7.49	46.26	100	328	Peak
5690	99.36	101.26			36.61	7.69	46.2	100	328	Peak
5690	90.47	92.37			36.61	7.69	46.2	100	328	Average
#5850	60.08	61.66	68.3	-8.22	36.71	7.86	46.15	100	328	Peak

**REMARKS:**

1. Emission Level = Read Level+ Antenna Factor + Cable Loss- Preamp Factor  
Margin value = Emission level – Limit value.
2. 5690MHz: Fundamental frequency.
3. #: Out of restricted band.



**Band 4:**

**802.11a**

<b>CHANNEL</b>	TX Channel 149	<b>DETECTOR FUNCTION</b>	Peak (PK)
<b>FREQUENCY RANGE</b>	1GHz ~ 40GHz		Average (AV)

ANTENNA POLARITY & TEST DISTANCE: HORIZONTAL AT 3 M										
FREQ. (MHz)	EMISSION LEVEL (dBuV/m)	READ LEVEL (dBuV)	LIMIT (dBuV/m)	MARGIN (dB)	ANTENNA FACTOR (dB /m)	CABLE LOSS (dB)	PREAMP FACTOR (dB)	ANTENNA HEIGHT (cm)	TABLE ANGLE (Degree)	REMARK
5745	104.99	107.02			36.4	7.75	46.18	100	25	Peak
5745	100.33	102.36			36.4	7.75	46.18	100	25	Average
ANTENNA POLARITY & TEST DISTANCE: VERTICAL AT 3 M										
FREQ. (MHz)	EMISSION LEVEL (dBuV/m)	READ LEVEL (dBuV)	LIMIT (dBuV/m)	MARGIN (dB)	ANTENNA FACTOR (dB /m)	CABLE LOSS (dB)	PREAMP FACTOR (dB)	ANTENNA HEIGHT (cm)	TABLE ANGLE (Degree)	REMARK
5745	104.76	106.54			36.65	7.75	46.18	120	330	Peak
5745	98.87	100.65			36.65	7.75	46.18	120	330	Average

**REMARKS:**

- Emission Level = Read Level+ Antenna Factor + Cable Loss- Preamp Factor  
Margin value = Emission level – Limit value.
- 5745MHz: Fundamental frequency.



**OOBE DATA**

**802.11a**

ANTENNA POLARITY & TEST DISTANCE: HORIZONTAL AT 3 M										
FREQ. (MHz)	EMISSION LEVEL (dBuV/m)	READ LEVEL (dBuV)	LIMIT (dBuV/m)	MARGIN (dB)	ANTENNA FACTOR (dB /m)	CABLE LOSS (dB)	PREAMP FACTOR (dB)	ANTENNA HEIGHT (cm)	TABLE ANGLE (Degree)	REMARK
5607.475	57.48	59.75	68.2	-10.72	36.34	7.61	46.22	100	0	Peak
6013.125	56.7	58.31	68.2	-11.5	36.51	7.99	46.11	100	0	Peak
ANTENNA POLARITY & TEST DISTANCE: VERTICAL AT 3 M										
FREQ. (MHz)	EMISSION LEVEL (dBuV/m)	READ LEVEL (dBuV)	LIMIT (dBuV/m)	MARGIN (dB)	ANTENNA FACTOR (dB /m)	CABLE LOSS (dB)	PREAMP FACTOR (dB)	ANTENNA HEIGHT (cm)	TABLE ANGLE (Degree)	REMARK
5583.25	56.16	58.26	68.2	-12.04	36.55	7.58	46.23	200	0	Peak
5969.9	57.01	58.37	68.2	-11.19	36.78	7.98	46.12	200	0	Peak

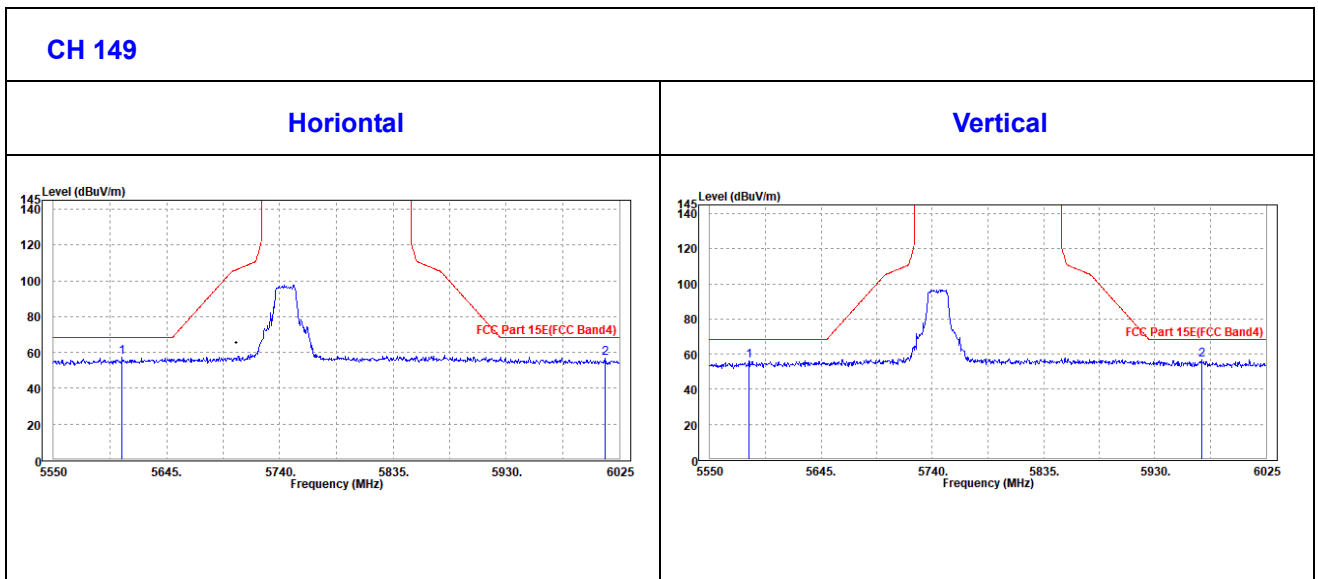



<b>CHANNEL</b>	TX Channel 157	<b>DETECTOR FUNCTION</b>	Peak (PK)
<b>FREQUENCY RANGE</b>	1GHz ~ 40GHz		Average (AV)

**ANTENNA POLARITY & TEST DISTANCE: HORIZONTAL AT 3 M**

FREQ. (MHz)	EMISSION LEVEL (dBuV/m)	READ LEVEL (dBuV)	LIMIT (dBuV/m)	MARGIN (dB)	ANTENNA FACTOR (dB /m)	CABLE LOSS (dB)	PREAMP FACTOR (dB)	ANTENNA HEIGHT (cm)	TABLE ANGLE (Degree)	REMARK
5785	104.02	105.99			36.41	7.79	46.17	105	25	Peak
5785	98.32	100.29			36.41	7.79	46.17	105	25	Average

**ANTENNA POLARITY & TEST DISTANCE: VERTICAL AT 3 M**

FREQ. (MHz)	EMISSION LEVEL (dBuV/m)	READ LEVEL (dBuV)	LIMIT (dBuV/m)	MARGIN (dB)	ANTENNA FACTOR (dB /m)	CABLE LOSS (dB)	PREAMP FACTOR (dB)	ANTENNA HEIGHT (cm)	TABLE ANGLE (Degree)	REMARK
5785	102.68	104.39			36.67	7.79	46.17	100	50	Peak
5785	98.36	100.07			36.67	7.79	46.17	100	50	Average

**REMARKS:**

- Emission Level = Read Level+ Antenna Factor + Cable Loss- Preamp Factor  
Margin value = Emission level – Limit value.
- 5785MHz: Fundamental frequency.



**Oobe Data**

**802.11a**

ANTENNA POLARITY & TEST DISTANCE: HORIZONTAL AT 3 M										
FREQ. (MHz)	EMISSION LEVEL (dBuV/m)	READ LEVEL (dBuV)	LIMIT (dBuV/m)	MARGIN (dB)	ANTENNA FACTOR (dB /m)	CABLE LOSS (dB)	PREAMP FACTOR (dB)	ANTENNA HEIGHT (cm)	TABLE ANGLE (Degree)	REMARK
5629.325	56.31	58.54	68.2	-11.89	36.35	7.63	46.21	200	0	Peak
5969.9	56.42	58.07	68.2	-11.78	36.49	7.98	46.12	200	0	Peak
ANTENNA POLARITY & TEST DISTANCE: VERTICAL AT 3 M										
FREQ. (MHz)	EMISSION LEVEL (dBuV/m)	READ LEVEL (dBuV)	LIMIT (dBuV/m)	MARGIN (dB)	ANTENNA FACTOR (dB /m)	CABLE LOSS (dB)	PREAMP FACTOR (dB)	ANTENNA HEIGHT (cm)	TABLE ANGLE (Degree)	REMARK
5604.15	56.73	58.78	68.2	-11.47	36.56	7.61	46.22	100	0	Peak
6002.2	57.97	59.27	68.2	-10.23	36.8	8.01	46.11	100	0	Peak

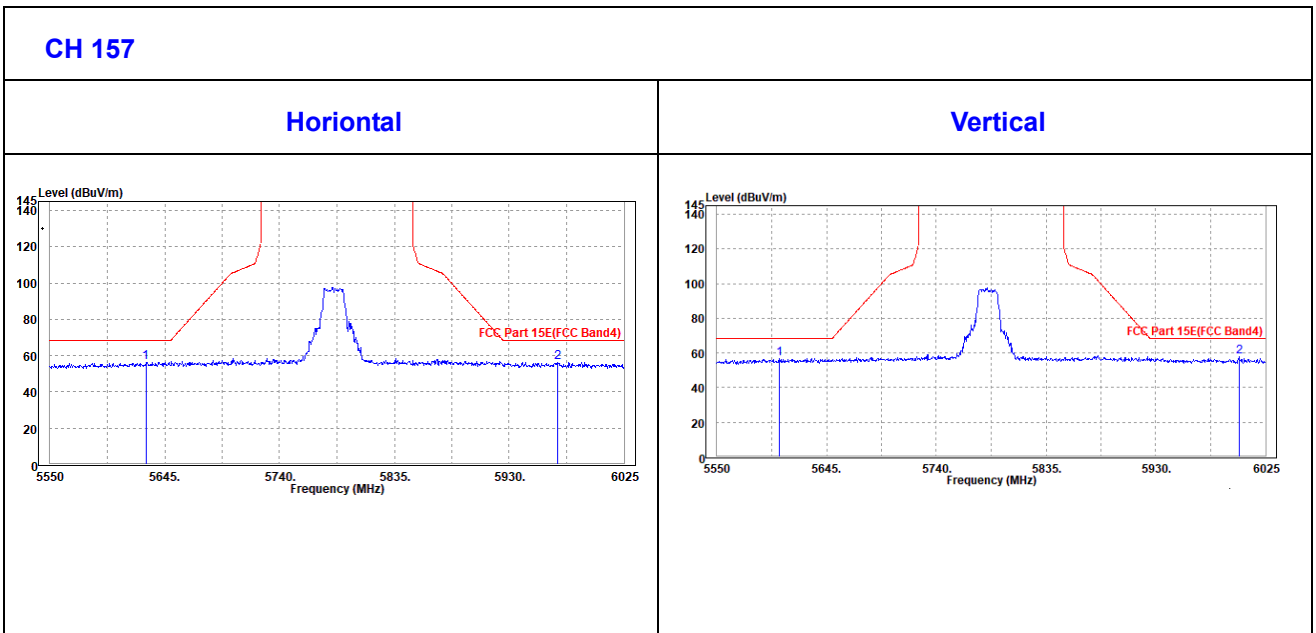





<b>CHANNEL</b>	TX Channel 165	<b>DETECTOR FUNCTION</b>	Peak (PK)
<b>FREQUENCY RANGE</b>	1GHz ~ 40GHz		Average (AV)

**ANTENNA POLARITY & TEST DISTANCE: HORIZONTAL AT 3 M**

FREQ. (MHz)	EMISSION LEVEL (dBuV/m)	READ LEVEL (dBuV)	LIMIT (dBuV/m)	MARGIN (dB)	ANTENNA FACTOR (dB /m)	CABLE LOSS (dB)	PREAMP FACTOR (dB)	ANTENNA HEIGHT (cm)	TABLE ANGLE (Degree)	REMARK
5825	104.17	106.07			36.43	7.83	46.16	105	25	Peak
5825	97.79	99.69			36.43	7.83	46.16	105	25	Average

**ANTENNA POLARITY & TEST DISTANCE: VERTICAL AT 3 M**

FREQ. (MHz)	EMISSION LEVEL (dBuV/m)	READ LEVEL (dBuV)	LIMIT (dBuV/m)	MARGIN (dB)	ANTENNA FACTOR (dB /m)	CABLE LOSS (dB)	PREAMP FACTOR (dB)	ANTENNA HEIGHT (cm)	TABLE ANGLE (Degree)	REMARK
5825	104.1	105.74			36.69	7.83	46.16	100	50	Peak
5825	97.15	98.79			36.69	7.83	46.16	100	50	Average

**REMARKS:**

- Emission Level = Read Level+ Antenna Factor + Cable Loss- Preamp Factor  
Margin value = Emission level – Limit value.
- 5825MHz: Fundamental frequency.



**Oobe Data**

802.11a

ANTENNA POLARITY & TEST DISTANCE: HORIZONTAL AT 3 M										
FREQ. (MHz)	EMISSION LEVEL (dBuV/m)	READ LEVEL (dBuV)	LIMIT (dBuV/m)	MARGIN (dB)	ANTENNA FACTOR (dB /m)	CABLE LOSS (dB)	PREAMP FACTOR (dB)	ANTENNA HEIGHT (cm)	TABLE ANGLE (Degree)	REMARK
5635.975	56.27	58.49	68.2	-11.93	36.35	7.64	46.21	100	0	Peak
6015.975	57.06	58.67	68.2	-11.14	36.51	7.99	46.11	100	0	Peak
ANTENNA POLARITY & TEST DISTANCE: VERTICAL AT 3 M										
FREQ. (MHz)	EMISSION LEVEL (dBuV/m)	READ LEVEL (dBuV)	LIMIT (dBuV/m)	MARGIN (dB)	ANTENNA FACTOR (dB /m)	CABLE LOSS (dB)	PREAMP FACTOR (dB)	ANTENNA HEIGHT (cm)	TABLE ANGLE (Degree)	REMARK
5575.65	57.01	59.11	68.2	-11.19	36.55	7.58	46.23	200	0	Peak
5939.975	57.04	58.46	68.2	-11.16	36.76	7.95	46.13	200	0	Peak

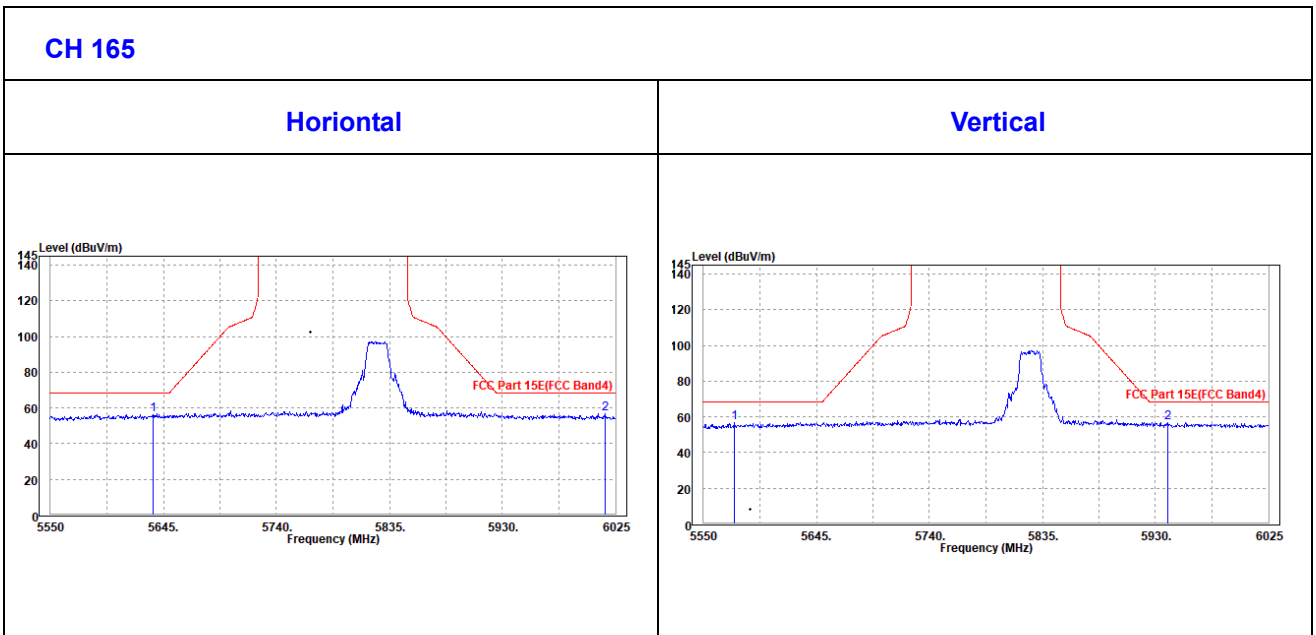



**802.11n (20MHz)**

<b>CHANNEL</b>	TX Channel 149	<b>DETECTOR FUNCTION</b>	Peak (PK)
<b>FREQUENCY RANGE</b>	1GHz ~ 40GHz		Average (AV)

<b>ANTENNA POLARITY &amp; TEST DISTANCE: HORIZONTAL AT 3 M</b>										
<b>FREQ. (MHz)</b>	<b>EMISSION LEVEL (dBuV/m)</b>	<b>READ LEVEL (dBuV)</b>	<b>LIMIT (dBuV/m)</b>	<b>MARGIN (dB)</b>	<b>ANTENNA FACTOR (dB /m)</b>	<b>CABLE LOSS (dB)</b>	<b>PREAMP FACTOR (dB)</b>	<b>ANTENNA HEIGHT (cm)</b>	<b>TABLE ANGLE (Degree)</b>	<b>REMARK</b>
5745	103.58	105.61			36.4	7.75	46.18	100	30	Peak
5745	96.85	98.88			36.4	7.75	46.18	100	30	Average
<b>ANTENNA POLARITY &amp; TEST DISTANCE: VERTICAL AT 3 M</b>										
<b>FREQ. (MHz)</b>	<b>EMISSION LEVEL (dBuV/m)</b>	<b>READ LEVEL (dBuV)</b>	<b>LIMIT (dBuV/m)</b>	<b>MARGIN (dB)</b>	<b>ANTENNA FACTOR (dB /m)</b>	<b>CABLE LOSS (dB)</b>	<b>PREAMP FACTOR (dB)</b>	<b>ANTENNA HEIGHT (cm)</b>	<b>TABLE ANGLE (Degree)</b>	<b>REMARK</b>
5745	105.67	107.45			36.65	7.75	46.18	105	360	Peak
5745	99.12	100.9			36.65	7.75	46.18	105	360	Average

**REMARKS:**

- Emission Level = Read Level+ Antenna Factor + Cable Loss- Preamp Factor  
Margin value = Emission level – Limit value.
- 5745MHz: Fundamental frequency.



**OBE DATA**

**802.11n (20MHZ)**

ANTENNA POLARITY & TEST DISTANCE: HORIZONTAL AT 3 M											
FREQ. (MHz)	EMISSION LEVEL (dBuV/m)	READ LEVEL (dBuV)	LIMIT (dBuV/m)	MARGIN (dB)	ANTENNA FACTOR (dB /m)	CABLE LOSS (dB)	PREAMP FACTOR (dB)	ANTENNA HEIGHT (cm)	TABLE ANGLE (Degree)	REMARK	
5630.75	57.32	59.55	68.2	-10.88	36.35	7.63	46.21	200	0	Peak	
5971.325	56.45	58.1	68.2	-11.75	36.49	7.98	46.12	200	0	Peak	
ANTENNA POLARITY & TEST DISTANCE: VERTICAL AT 3 M											
FREQ. (MHz)	EMISSION LEVEL (dBuV/m)	READ LEVEL (dBuV)	LIMIT (dBuV/m)	MARGIN (dB)	ANTENNA FACTOR (dB /m)	CABLE LOSS (dB)	PREAMP FACTOR (dB)	ANTENNA HEIGHT (cm)	TABLE ANGLE (Degree)	REMARK	
5585.625	56.77	58.86	68.2	-11.43	36.55	7.59	46.23	100	0	Peak	
5965.625	56.97	58.34	68.2	-11.23	36.78	7.97	46.12	100	0	Peak	

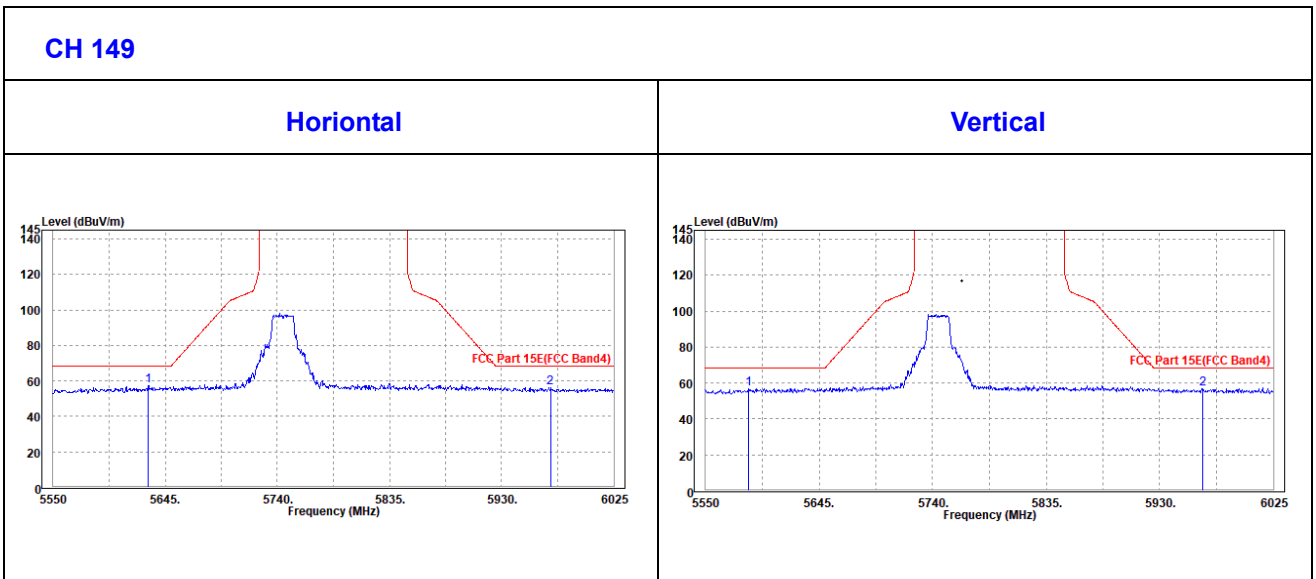



<b>CHANNEL</b>	TX Channel 157	<b>DETECTOR FUNCTION</b>	Peak (PK)
<b>FREQUENCY RANGE</b>	1GHz ~ 40GHz		Average (AV)

**ANTENNA POLARITY & TEST DISTANCE: HORIZONTAL AT 3 M**

FREQ. (MHz)	EMISSION LEVEL (dBuV/m)	READ LEVEL (dBuV)	LIMIT (dBuV/m)	MARGIN (dB)	ANTENNA FACTOR (dB /m)	CABLE LOSS (dB)	PREAMP FACTOR (dB)	ANTENNA HEIGHT (cm)	TABLE ANGLE (Degree)	REMARK
5785	104.61	106.58			36.41	7.79	46.17	100	30	Peak
5785	98.29	100.26			36.41	7.79	46.17	100	30	Average

**ANTENNA POLARITY & TEST DISTANCE: VERTICAL AT 3 M**

FREQ. (MHz)	EMISSION LEVEL (dBuV/m)	READ LEVEL (dBuV)	LIMIT (dBuV/m)	MARGIN (dB)	ANTENNA FACTOR (dB /m)	CABLE LOSS (dB)	PREAMP FACTOR (dB)	ANTENNA HEIGHT (cm)	TABLE ANGLE (Degree)	REMARK
5785	104.61	106.32			36.67	7.79	46.17	105	180	Peak
5785	99.92	101.63			36.67	7.79	46.17	105	180	Average

**REMARKS:**

- Emission Level = Read Level+ Antenna Factor + Cable Loss- Preamp Factor  
Margin value = Emission level – Limit value.
- 5785MHz: Fundamental frequency.



**Oobe Data**

**802.11n (20MHz)**

ANTENNA POLARITY & TEST DISTANCE: HORIZONTAL AT 3 M										
FREQ. (MHz)	EMISSION LEVEL (dBuV/m)	READ LEVEL (dBuV)	LIMIT (dBuV /m)	MARGIN (dB)	ANTENNA FACTOR (dB /m)	CABLE LOSS (dB)	PREAMP FACTOR (dB)	ANTENNA HEIGHT (cm)	TABLE ANGLE (Degree)	REMARK
5626.95	57.3	59.53	68.2	-10.9	36.35	7.63	46.21	100	0	Peak
5969.9	57.52	59.17	68.2	-10.68	36.49	7.98	46.12	100	0	Peak
ANTENNA POLARITY & TEST DISTANCE: VERTICAL AT 3 M										
FREQ. (MHz)	EMISSION LEVEL (dBuV/m)	READ LEVEL (dBuV)	LIMIT (dBuV /m)	MARGIN (dB)	ANTENNA FACTOR (dB /m)	CABLE LOSS (dB)	PREAMP FACTOR (dB)	ANTENNA HEIGHT (cm)	TABLE ANGLE (Degree)	REMARK
5623.15	57.12	59.14	68.2	-11.08	36.57	7.63	46.22	200	0	Peak
5958.975	57.05	58.42	68.2	-11.15	36.78	7.97	46.12	200	0	Peak

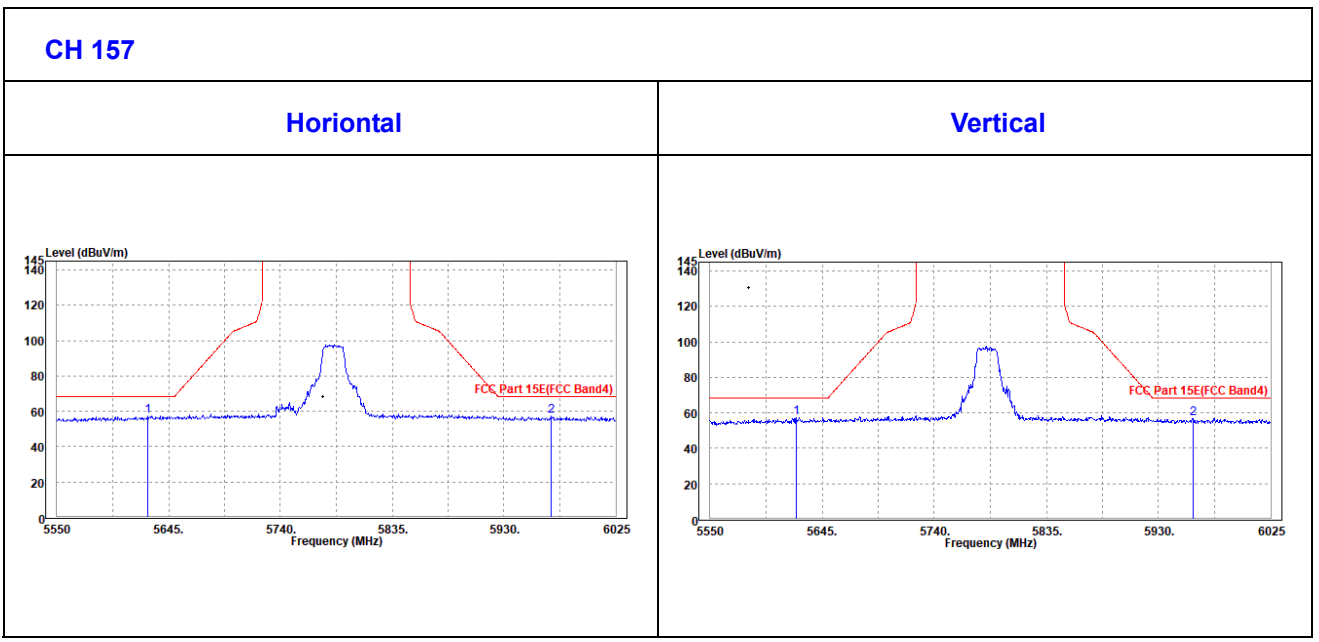



<b>CHANNEL</b>	TX Channel 165	<b>DETECTOR FUNCTION</b>	Peak (PK)
<b>FREQUENCY RANGE</b>	1GHz ~ 40GHz		Average (AV)

**ANTENNA POLARITY & TEST DISTANCE: HORIZONTAL AT 3 M**

FREQ. (MHz)	EMISSION LEVEL (dBuV/m)	READ LEVEL (dBuV)	LIMIT (dBuV/m)	MARGIN (dB)	ANTENNA FACTOR (dB /m)	CABLE LOSS (dB)	PREAMP FACTOR (dB)	ANTENNA HEIGHT (cm)	TABLE ANGLE (Degree)	REMARK
5825	103.54	105.44			36.43	7.83	46.16	100	30	Peak
5825	97.65	99.55			36.43	7.83	46.16	100	30	Average

**ANTENNA POLARITY & TEST DISTANCE: VERTICAL AT 3 M**

FREQ. (MHz)	EMISSION LEVEL (dBuV/m)	READ LEVEL (dBuV)	LIMIT (dBuV/m)	MARGIN (dB)	ANTENNA FACTOR (dB /m)	CABLE LOSS (dB)	PREAMP FACTOR (dB)	ANTENNA HEIGHT (cm)	TABLE ANGLE (Degree)	REMARK
5825	105.13	106.77			36.69	7.83	46.16	100	180	Peak
5825	98.35	99.99			36.69	7.83	46.16	100	180	Average

**REMARKS:**

- Emission Level = Read Level+ Antenna Factor + Cable Loss- Preamp Factor  
Margin value = Emission level – Limit value.
- 5825MHz: Fundamental frequency.



**OOBE DATA**

**802.11n (20MHZ)**

ANTENNA POLARITY & TEST DISTANCE: HORIZONTAL AT 3 M										
FREQ. (MHz)	EMISSION LEVEL (dBuV/m)	READ LEVEL (dBuV)	LIMIT (dBuV/m)	MARGIN (dB)	ANTENNA FACTOR (dB /m)	CABLE LOSS (dB)	PREAMP FACTOR (dB)	ANTENNA HEIGHT (cm)	TABLE ANGLE (Degree)	REMARK
5622.2	56.4	58.65	68.2	-11.8	36.35	7.62	46.22	200	0	Peak
5963.25	56.14	57.8	68.2	-12.06	36.49	7.97	46.12	200	0	Peak
ANTENNA POLARITY & TEST DISTANCE: VERTICAL AT 3 M										
FREQ. (MHz)	EMISSION LEVEL (dBuV/m)	READ LEVEL (dBuV)	LIMIT (dBuV/m)	MARGIN (dB)	ANTENNA FACTOR (dB /m)	CABLE LOSS (dB)	PREAMP FACTOR (dB)	ANTENNA HEIGHT (cm)	TABLE ANGLE (Degree)	REMARK
5591.8	57.08	59.15	68.2	-11.12	36.56	7.59	46.22	100	0	Peak
5956.125	56.44	57.82	68.2	-11.76	36.77	7.97	46.12	100	0	Peak

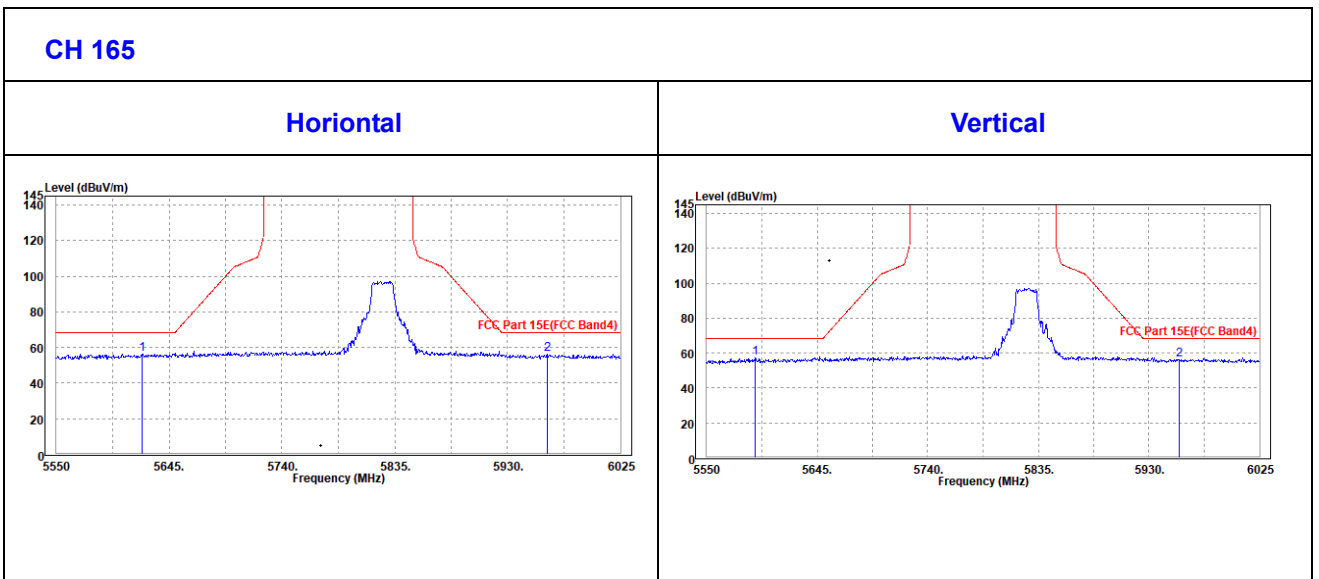





**802.11n (40MHz)**

<b>CHANNEL</b>	TX Channel 151	<b>DETECTOR FUNCTION</b>	Peak (PK)
<b>FREQUENCY RANGE</b>	1GHz ~ 40GHz		Average (AV)

**ANTENNA POLARITY & TEST DISTANCE: HORIZONTAL AT 3 M**

FREQ. (MHz)	EMISSION LEVEL (dBuV/m)	READ LEVEL (dBuV)	LIMIT (dBuV/m)	MARGIN (dB)	ANTENNA FACTOR (dB /m)	CABLE LOSS (dB)	PREAMP FACTOR (dB)	ANTENNA HEIGHT (cm)	TABLE ANGLE (Degree)	REMARK
5755	99.44	99.19			35.11	11.32	46.18	200	110	Peak
5755	95.15	94.9			35.11	11.32	46.18	200	110	Average

**ANTENNA POLARITY & TEST DISTANCE: VERTICAL AT 3 M**

FREQ. (MHz)	EMISSION LEVEL (dBuV/m)	READ LEVEL (dBuV)	LIMIT (dBuV/m)	MARGIN (dB)	ANTENNA FACTOR (dB /m)	CABLE LOSS (dB)	PREAMP FACTOR (dB)	ANTENNA HEIGHT (cm)	TABLE ANGLE (Degree)	REMARK
5755	101.47	101.42			34.91	11.32	46.18	115	285	Peak
5755	96.98	96.93			34.91	11.32	46.18	115	285	Average

**REMARKS:**

- Emission Level = Read Level+ Antenna Factor + Cable Loss- Preamp Factor  
Margin value = Emission level – Limit value.
- 5755MHz: Fundamental frequency.



**OBE DATA**

**802.11n (40MHZ)**

ANTENNA POLARITY & TEST DISTANCE: HORIZONTAL AT 3 M										
FREQ. (MHz)	EMISSION LEVEL (dBuV/m)	READ LEVEL (dBuV)	LIMIT (dBuV/m)	MARGIN (dB)	ANTENNA FACTOR (dB /m)	CABLE LOSS (dB)	PREAMP FACTOR (dB)	ANTENNA HEIGHT (cm)	TABLE ANGLE (Degree)	REMARK
5597.5	57.72	58.36	68.2	-10.48	34.92	10.66	46.22	200	360	Peak
5976.55	59.52	58.02	68.2	-8.68	35.37	12.25	46.12	200	360	Peak
ANTENNA POLARITY & TEST DISTANCE: VERTICAL AT 3 M										
FREQ. (MHz)	EMISSION LEVEL (dBuV/m)	READ LEVEL (dBuV)	LIMIT (dBuV/m)	MARGIN (dB)	ANTENNA FACTOR (dB /m)	CABLE LOSS (dB)	PREAMP FACTOR (dB)	ANTENNA HEIGHT (cm)	TABLE ANGLE (Degree)	REMARK
5591.8	57.32	58.19	68.2	-10.88	34.71	10.64	46.22	100	360	Peak
5976.55	58.75	57.45	68.2	-9.45	35.17	12.25	46.12	100	360	Peak

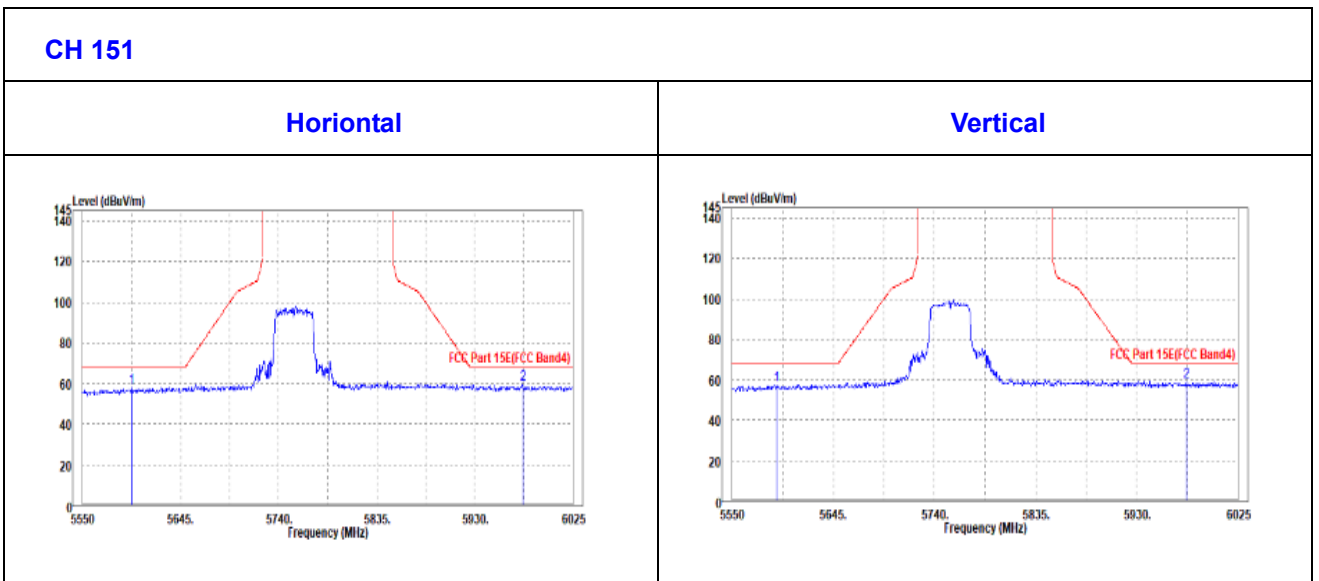



<b>CHANNEL</b>	TX Channel 159	<b>DETECTOR FUNCTION</b>	Peak (PK)
<b>FREQUENCY RANGE</b>	1GHz ~ 40GHz		Average (AV)

**ANTENNA POLARITY & TEST DISTANCE: HORIZONTAL AT 3 M**

FREQ. (MHz)	EMISSION LEVEL (dBuV/m)	READ LEVEL (dBuV)	LIMIT (dBuV/m)	MARGIN (dB)	ANTENNA FACTOR (dB /m)	CABLE LOSS (dB)	PREAMP FACTOR (dB)	ANTENNA HEIGHT (cm)	TABLE ANGLE (Degree)	REMARK
5795	101.96	103.91			36.42	7.8	46.17	200	200	Peak
5795	96.91	98.86			36.42	7.8	46.17	200	200	Average

**ANTENNA POLARITY & TEST DISTANCE: VERTICAL AT 3 M**

FREQ. (MHz)	EMISSION LEVEL (dBuV/m)	READ LEVEL (dBuV)	LIMIT (dBuV/m)	MARGIN (dB)	ANTENNA FACTOR (dB /m)	CABLE LOSS (dB)	PREAMP FACTOR (dB)	ANTENNA HEIGHT (cm)	TABLE ANGLE (Degree)	REMARK
5795	98.72	100.41			36.68	7.8	46.17	135	340	Peak
5795	94.79	96.48			36.68	7.8	46.17	135	340	Average

**REMARKS:**

- Emission Level = Read Level+ Antenna Factor + Cable Loss- Preamp Factor  
Margin value = Emission level – Limit value.
- 5795MHz: Fundamental frequency.



**Oobe Data**

**802.11n (40MHz)**

ANTENNA POLARITY & TEST DISTANCE: HORIZONTAL AT 3 M										
FREQ. (MHz)	EMISSION LEVEL (dBuV/m)	READ LEVEL (dBuV)	LIMIT (dBuV/m)	MARGIN (dB)	ANTENNA FACTOR (dB /m)	CABLE LOSS (dB)	PREAMP FACTOR (dB)	ANTENNA HEIGHT (cm)	TABLE ANGLE (Degree)	REMARK
5591.8	59.92	62.21	68.3	-8.38	36.34	7.59	46.22	100	360	Peak
5945.675	59.83	61.53	68.3	-8.47	36.48	7.95	46.13	100	360	Peak
ANTENNA POLARITY & TEST DISTANCE: VERTICAL AT 3 M										
FREQ. (MHz)	EMISSION LEVEL (dBuV/m)	READ LEVEL (dBuV)	LIMIT (dBuV/m)	MARGIN (dB)	ANTENNA FACTOR (dB /m)	CABLE LOSS (dB)	PREAMP FACTOR (dB)	ANTENNA HEIGHT (cm)	TABLE ANGLE (Degree)	REMARK
5632.175	59.93	61.93	68.2	-8.27	36.58	7.63	46.21	200	360	Peak
5980.35	60.19	61.53	68.2	-8.01	36.79	7.99	46.12	200	360	Peak

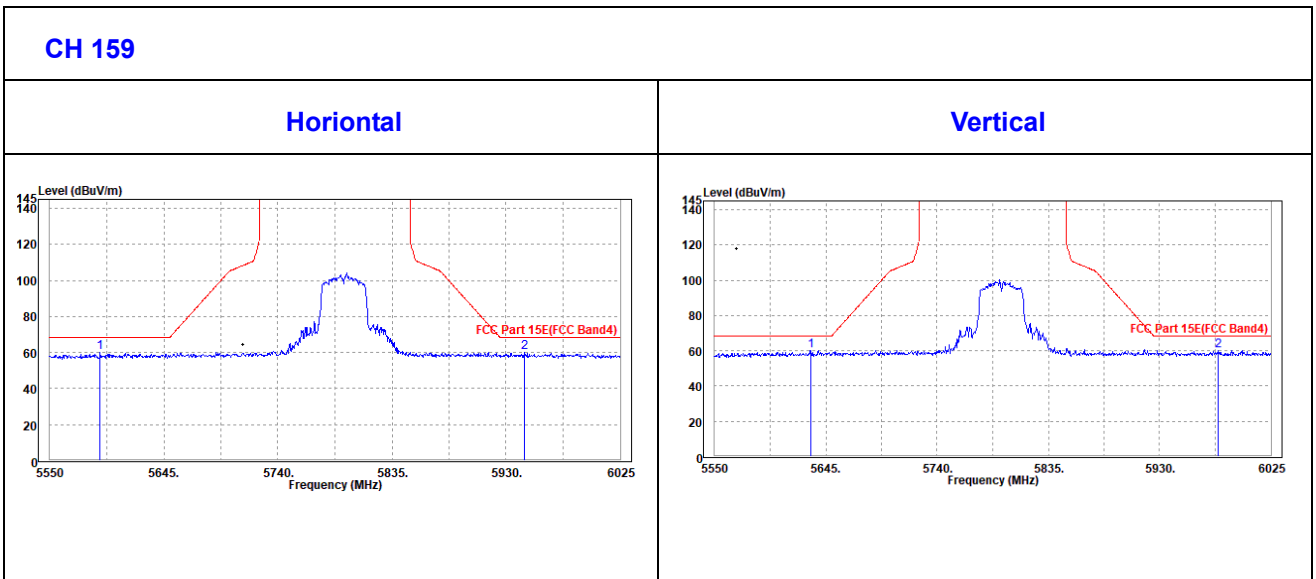



**802.11ac (20MHz)**

<b>CHANNEL</b>	TX Channel 149	<b>DETECTOR FUNCTION</b>	Peak (PK)
<b>FREQUENCY RANGE</b>	1GHz ~ 40GHz		Average (AV)

**ANTENNA POLARITY & TEST DISTANCE: HORIZONTAL AT 3 M**

FREQ. (MHz)	EMISSION LEVEL (dBuV/m)	READ LEVEL (dBuV)	LIMIT (dBuV/m)	MARGIN (dB)	ANTENNA FACTOR (dB /m)	CABLE LOSS (dB)	PREAMP FACTOR (dB)	ANTENNA HEIGHT (cm)	TABLE ANGLE (Degree)	REMARK
5745	105.81	107.84			36.4	7.75	46.18	105	20	Peak
5745	98.82	100.85			36.4	7.75	46.18	105	20	Average

**ANTENNA POLARITY & TEST DISTANCE: VERTICAL AT 3 M**

FREQ. (MHz)	EMISSION LEVEL (dBuV/m)	READ LEVEL (dBuV)	LIMIT (dBuV/m)	MARGIN (dB)	ANTENNA FACTOR (dB /m)	CABLE LOSS (dB)	PREAMP FACTOR (dB)	ANTENNA HEIGHT (cm)	TABLE ANGLE (Degree)	REMARK
5745	104.54	106.32			36.65	7.75	46.18	100	180	Peak
5745	98.25	100.03			36.65	7.75	46.18	100	180	Average

**REMARKS:**

- Emission Level = Read Level+ Antenna Factor + Cable Loss- Preamp Factor  
Margin value = Emission level – Limit value.
- 5745MHz: Fundamental frequency.



**OOBE DATA**

**802.11ac (20MHz)**

ANTENNA POLARITY & TEST DISTANCE: HORIZONTAL AT 3 M										
FREQ. (MHz)	EMISSION LEVEL (dBuV/m)	READ LEVEL (dBuV)	LIMIT (dBuV/m)	MARGIN (dB)	ANTENNA FACTOR (dB /m)	CABLE LOSS (dB)	PREAMP FACTOR (dB)	ANTENNA HEIGHT (cm)	TABLE ANGLE (Degree)	REMARK
5589.9	57.04	59.33	68.2	-11.16	36.34	7.59	46.22	100	0	Peak
5942.825	56.53	58.23	68.2	-11.67	36.48	7.95	46.13	100	0	Peak
ANTENNA POLARITY & TEST DISTANCE: VERTICAL AT 3 M										
FREQ. (MHz)	EMISSION LEVEL (dBuV/m)	READ LEVEL (dBuV)	LIMIT (dBuV/m)	MARGIN (dB)	ANTENNA FACTOR (dB /m)	CABLE LOSS (dB)	PREAMP FACTOR (dB)	ANTENNA HEIGHT (cm)	TABLE ANGLE (Degree)	REMARK
5621.25	56.52	58.55	68.2	-11.68	36.57	7.62	46.22	200	0	Peak
5934.275	57.02	58.45	68.2	-11.18	36.76	7.94	46.13	200	0	Peak

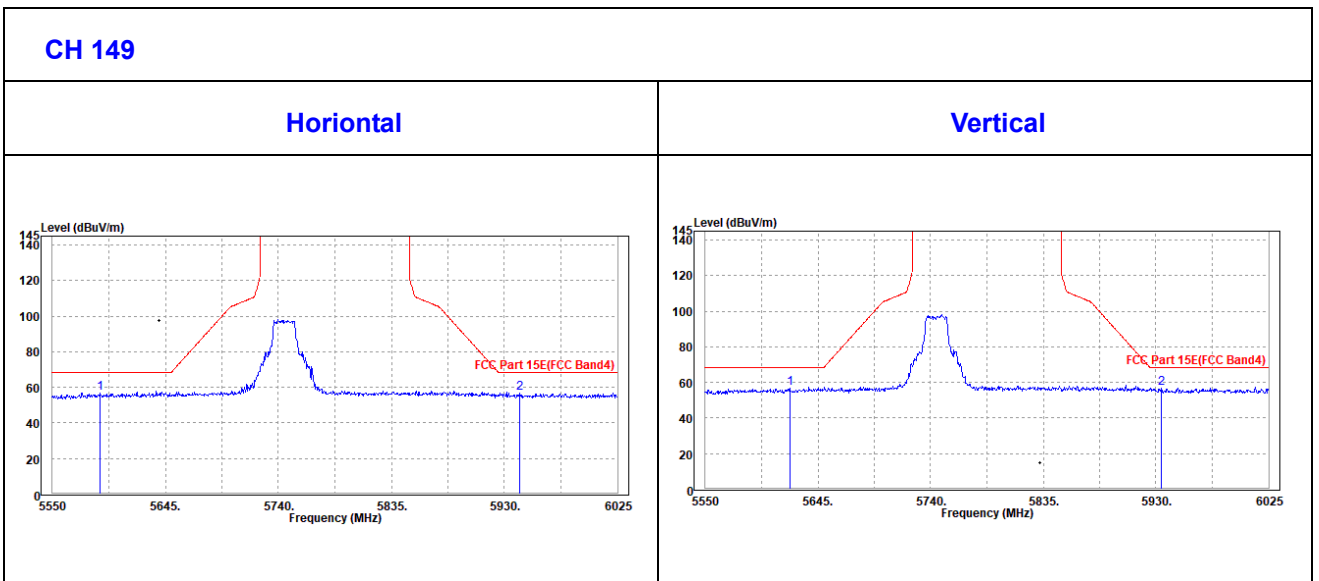



<b>CHANNEL</b>	TX Channel 157	<b>DETECTOR FUNCTION</b>	Peak (PK)
<b>FREQUENCY RANGE</b>	1GHz ~ 40GHz		Average (AV)

ANTENNA POLARITY & TEST DISTANCE: HORIZONTAL AT 3 M										
FREQ. (MHz)	EMISSION LEVEL (dBuV/m)	READ LEVEL (dBuV)	LIMIT (dBuV/m)	MARGIN (dB)	ANTENNA FACTOR (dB /m)	CABLE LOSS (dB)	PREAMP FACTOR (dB)	ANTENNA HEIGHT (cm)	TABLE ANGLE (Degree)	REMARK
5785	103.68	105.65			36.41	7.79	46.17	105	50	Peak
5785	97.58	99.55			36.41	7.79	46.17	105	50	Average
ANTENNA POLARITY & TEST DISTANCE: VERTICAL AT 3 M										
FREQ. (MHz)	EMISSION LEVEL (dBuV/m)	READ LEVEL (dBuV)	LIMIT (dBuV/m)	MARGIN (dB)	ANTENNA FACTOR (dB /m)	CABLE LOSS (dB)	PREAMP FACTOR (dB)	ANTENNA HEIGHT (cm)	TABLE ANGLE (Degree)	REMARK
5785	103.16	104.87			36.67	7.79	46.17	100	180	Peak
5785	96.84	98.55			36.67	7.79	46.17	100	180	Average

**REMARKS:**

- Emission Level = Read Level+ Antenna Factor + Cable Loss- Preamp Factor  
Margin value = Emission level – Limit value.
- 5785MHz: Fundamental frequency.



**Oobe Data**

**802.11ac (20MHz)**

ANTENNA POLARITY & TEST DISTANCE: HORIZONTAL AT 3 M										
FREQ. (MHz)	EMISSION LEVEL (dBuV/m)	READ LEVEL (dBuV)	LIMIT (dBuV /m)	MARGIN (dB)	ANTENNA FACTOR (dB /m)	CABLE LOSS (dB)	PREAMP FACTOR (dB)	ANTENNA HEIGHT (cm)	TABLE ANGLE (Degree)	REMARK
5586.1	56.06	58.37	68.2	-12.14	36.33	7.59	46.23	200	0	Peak
5969.425	56.76	58.41	68.2	-11.44	36.49	7.98	46.12	200	0	Peak
ANTENNA POLARITY & TEST DISTANCE: VERTICAL AT 3 M										
FREQ. (MHz)	EMISSION LEVEL (dBuV/m)	READ LEVEL (dBuV)	LIMIT (dBuV /m)	MARGIN (dB)	ANTENNA FACTOR (dB /m)	CABLE LOSS (dB)	PREAMP FACTOR (dB)	ANTENNA HEIGHT (cm)	TABLE ANGLE (Degree)	REMARK
5590.85	57.96	60.04	68.2	-10.24	36.55	7.59	46.22	100	0	Peak
5968.95	56.38	57.74	68.2	-11.82	36.78	7.98	46.12	100	0	Peak

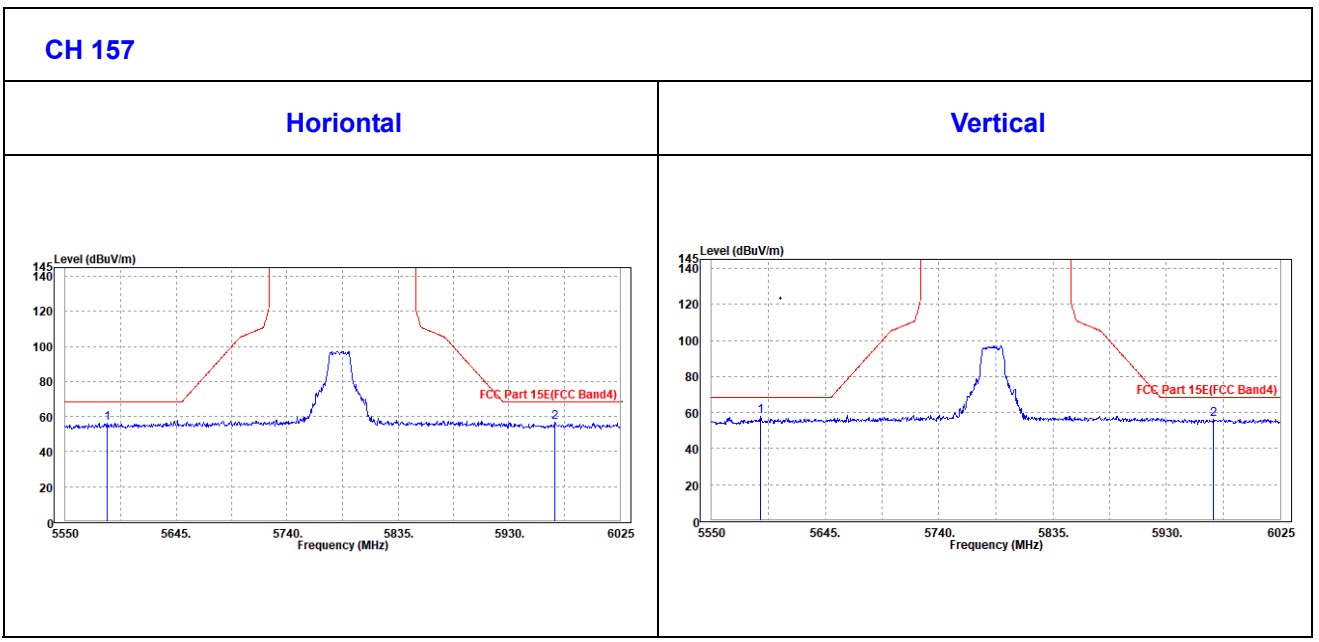





<b>CHANNEL</b>	TX Channel 165	<b>DETECTOR FUNCTION</b>	Peak (PK)
<b>FREQUENCY RANGE</b>	1GHz ~ 40GHz		Average (AV)

<b>ANTENNA POLARITY &amp; TEST DISTANCE: HORIZONTAL AT 3 M</b>										
FREQ. (MHz)	EMISSION LEVEL (dBuV/m)	READ LEVEL (dBuV)	LIMIT (dBuV/m)	MARGIN (dB)	ANTENNA FACTOR (dB /m)	CABLE LOSS (dB)	PREAMP FACTOR (dB)	ANTENNA HEIGHT (cm)	TABLE ANGLE (Degree)	REMARK
5825	104.52	106.42			36.43	7.83	46.16	100	30	Peak
5825	98.37	100.27			36.43	7.83	46.16	100	30	Average
<b>ANTENNA POLARITY &amp; TEST DISTANCE: VERTICAL AT 3 M</b>										
FREQ. (MHz)	EMISSION LEVEL (dBuV/m)	READ LEVEL (dBuV)	LIMIT (dBuV/m)	MARGIN (dB)	ANTENNA FACTOR (dB /m)	CABLE LOSS (dB)	PREAMP FACTOR (dB)	ANTENNA HEIGHT (cm)	TABLE ANGLE (Degree)	REMARK
5825	105.31	106.95			36.69	7.83	46.16	100	180	Peak
5825	98.26	99.9			36.69	7.83	46.16	100	180	Average

**REMARKS:**

- Emission Level = Read Level+ Antenna Factor + Cable Loss- Preamp Factor  
Margin value = Emission level – Limit value.
- 5825MHz: Fundamental frequency.



**OOBE DATA**

**802.11ac (20MHZ)**

ANTENNA POLARITY & TEST DISTANCE: HORIZONTAL AT 3 M										
FREQ. (MHz)	EMISSION LEVEL (dBuV/m)	READ LEVEL (dBuV)	LIMIT (dBuV/m)	MARGIN (dB)	ANTENNA FACTOR (dB /m)	CABLE LOSS (dB)	PREAMP FACTOR (dB)	ANTENNA HEIGHT (cm)	TABLE ANGLE (Degree)	REMARK
5617.925	57.31	59.56	68.2	-10.89	36.35	7.62	46.22	100	0	Peak
5976.075	56.58	58.22	68.2	-11.62	36.49	7.99	46.12	100	0	Peak
ANTENNA POLARITY & TEST DISTANCE: VERTICAL AT 3 M										
FREQ. (MHz)	EMISSION LEVEL (dBuV/m)	READ LEVEL (dBuV)	LIMIT (dBuV/m)	MARGIN (dB)	ANTENNA FACTOR (dB /m)	CABLE LOSS (dB)	PREAMP FACTOR (dB)	ANTENNA HEIGHT (cm)	TABLE ANGLE (Degree)	REMARK
5592.275	56.77	58.84	68.2	-11.43	36.56	7.59	46.22	200	0	Peak
5965.625	56.79	58.16	68.2	-11.41	36.78	7.97	46.12	200	0	Peak

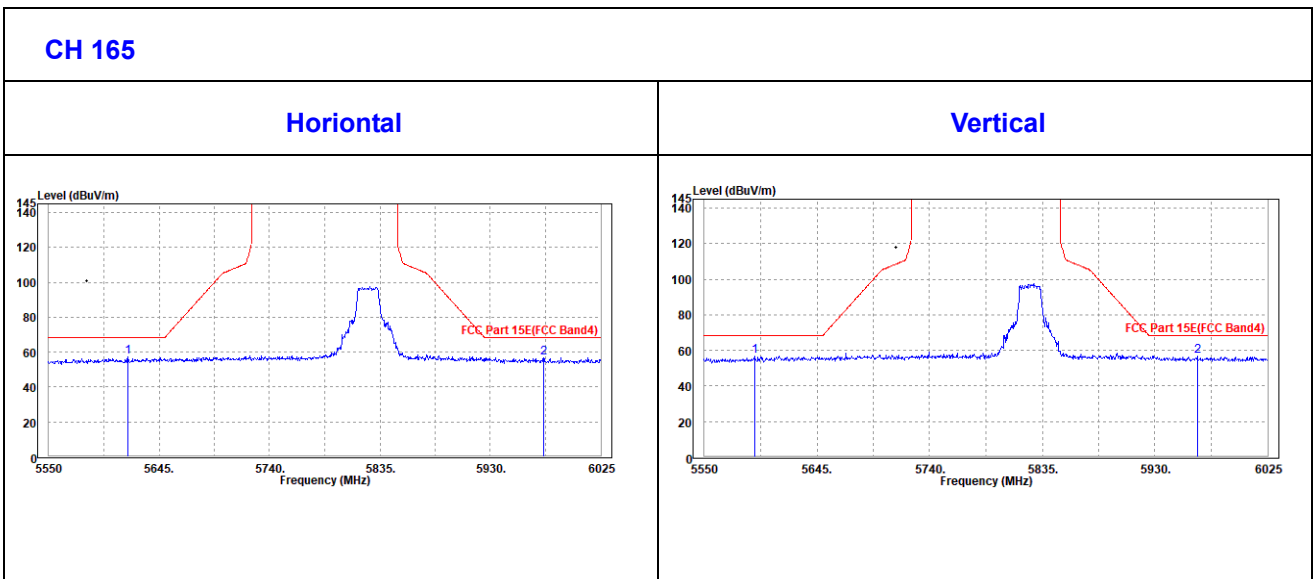



**802.11ac (40MHz)**

<b>CHANNEL</b>	TX Channel 151	<b>DETECTOR FUNCTION</b>	Peak (PK)
<b>FREQUENCY RANGE</b>	1GHz ~ 40GHz		Average (AV)

**ANTENNA POLARITY & TEST DISTANCE: HORIZONTAL AT 3 M**

FREQ. (MHz)	EMISSION LEVEL (dBuV/m)	READ LEVEL (dBuV)	LIMIT (dBuV/m)	MARGIN (dB)	ANTENNA FACTOR (dB /m)	CABLE LOSS (dB)	PREAMP FACTOR (dB)	ANTENNA HEIGHT (cm)	TABLE ANGLE (Degree)	REMARK
5755	102.62	104.64			36.4	7.76	46.18	200	200	Peak
5755	97.41	99.43			36.4	7.76	46.18	200	200	Average

**ANTENNA POLARITY & TEST DISTANCE: VERTICAL AT 3 M**

FREQ. (MHz)	EMISSION LEVEL (dBuV/m)	READ LEVEL (dBuV)	LIMIT (dBuV/m)	MARGIN (dB)	ANTENNA FACTOR (dB /m)	CABLE LOSS (dB)	PREAMP FACTOR (dB)	ANTENNA HEIGHT (cm)	TABLE ANGLE (Degree)	REMARK
5755	99.31	101.08			36.65	7.76	46.18	135	340	Peak
5755	95.1	96.87			36.65	7.76	46.18	135	340	Average

**REMARKS:**

- Emission Level = Read Level+ Antenna Factor + Cable Loss- Preamp Factor  
Margin value = Emission level – Limit value.
- 5755MHz: Fundamental frequency.



**Oobe Data**

**802.11ac (40MHz)**

ANTENNA POLARITY & TEST DISTANCE: HORIZONTAL AT 3 M										
FREQ. (MHz)	EMISSION LEVEL (dBuV/m)	READ LEVEL (dBuV)	LIMIT (dBuV/m)	MARGIN (dB)	ANTENNA FACTOR (dB /m)	CABLE LOSS (dB)	PREAMP FACTOR (dB)	ANTENNA HEIGHT (cm)	TABLE ANGLE (Degree)	REMARK
5586.575	59.77	62.08	68.2	-8.43	36.33	7.59	46.23	200	0	Peak
5937.6	59.81	61.51	68.2	-8.39	36.48	7.95	46.13	200	0	Peak
ANTENNA POLARITY & TEST DISTANCE: VERTICAL AT 3 M										
FREQ. (MHz)	EMISSION LEVEL (dBuV/m)	READ LEVEL (dBuV)	LIMIT (dBuV/m)	MARGIN (dB)	ANTENNA FACTOR (dB /m)	CABLE LOSS (dB)	PREAMP FACTOR (dB)	ANTENNA HEIGHT (cm)	TABLE ANGLE (Degree)	REMARK
5603.675	59.49	61.54	68.2	-8.71	36.56	7.61	46.22	100	0	Peak
5941.4	60.52	61.94	68.2	-7.68	36.76	7.95	46.13	100	0	Peak

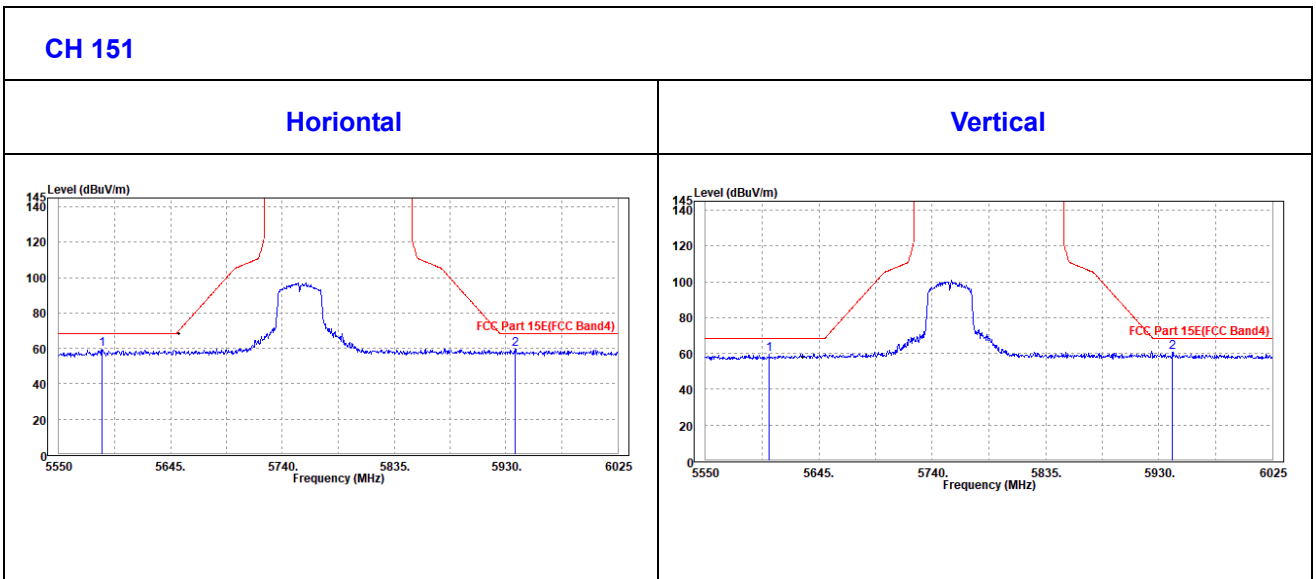



<b>CHANNEL</b>	TX Channel 159	<b>DETECTOR FUNCTION</b>	Peak (PK)
<b>FREQUENCY RANGE</b>	1GHz ~ 40GHz		Average (AV)

**ANTENNA POLARITY & TEST DISTANCE: HORIZONTAL AT 3 M**

FREQ. (MHz)	EMISSION LEVEL (dBuV/m)	READ LEVEL (dBuV)	LIMIT (dBuV/m)	MARGIN (dB)	ANTENNA FACTOR (dB /m)	CABLE LOSS (dB)	PREAMP FACTOR (dB)	ANTENNA HEIGHT (cm)	TABLE ANGLE (Degree)	REMARK
5795	101.22	103.17			36.42	7.8	46.17	200	200	Peak
5795	96.64	98.59			36.42	7.8	46.17	200	200	Average

**ANTENNA POLARITY & TEST DISTANCE: VERTICAL AT 3 M**

FREQ. (MHz)	EMISSION LEVEL (dBuV/m)	READ LEVEL (dBuV)	LIMIT (dBuV/m)	MARGIN (dB)	ANTENNA FACTOR (dB /m)	CABLE LOSS (dB)	PREAMP FACTOR (dB)	ANTENNA HEIGHT (cm)	TABLE ANGLE (Degree)	REMARK
5795	99.39	101.08			36.68	7.8	46.17	135	340	Peak
5795	92.65	94.34			36.68	7.8	46.17	135	340	Average

**REMARKS:**

- Emission Level = Read Level+ Antenna Factor + Cable Loss- Preamp Factor  
Margin value = Emission level – Limit value.
- 5795MHz: Fundamental frequency.



**OOBE DATA**

**802.11ac (40MHZ)**

ANTENNA POLARITY & TEST DISTANCE: HORIZONTAL AT 3 M										
FREQ. (MHz)	EMISSION LEVEL (dBuV/m)	READ LEVEL (dBuV)	LIMIT (dBuV/m)	MARGIN (dB)	ANTENNA FACTOR (dB /m)	CABLE LOSS (dB)	PREAMP FACTOR (dB)	ANTENNA HEIGHT (cm)	TABLE ANGLE (Degree)	REMARK
5578.025	58.81	61.13	68.2	-9.39	36.33	7.58	46.23	100	0	Peak
5938.55	59.36	61.06	68.2	-8.84	36.48	7.95	46.13	100	0	Peak
ANTENNA POLARITY & TEST DISTANCE: VERTICAL AT 3 M										
FREQ. (MHz)	EMISSION LEVEL (dBuV/m)	READ LEVEL (dBuV)	LIMIT (dBuV/m)	MARGIN (dB)	ANTENNA FACTOR (dB /m)	CABLE LOSS (dB)	PREAMP FACTOR (dB)	ANTENNA HEIGHT (cm)	TABLE ANGLE (Degree)	REMARK
5586.575	59.99	62.08	68.2	-8.21	36.55	7.59	46.23	200	0	Peak
6008.85	59.91	61.21	68.2	-8.29	36.81	8	46.11	200	0	Peak

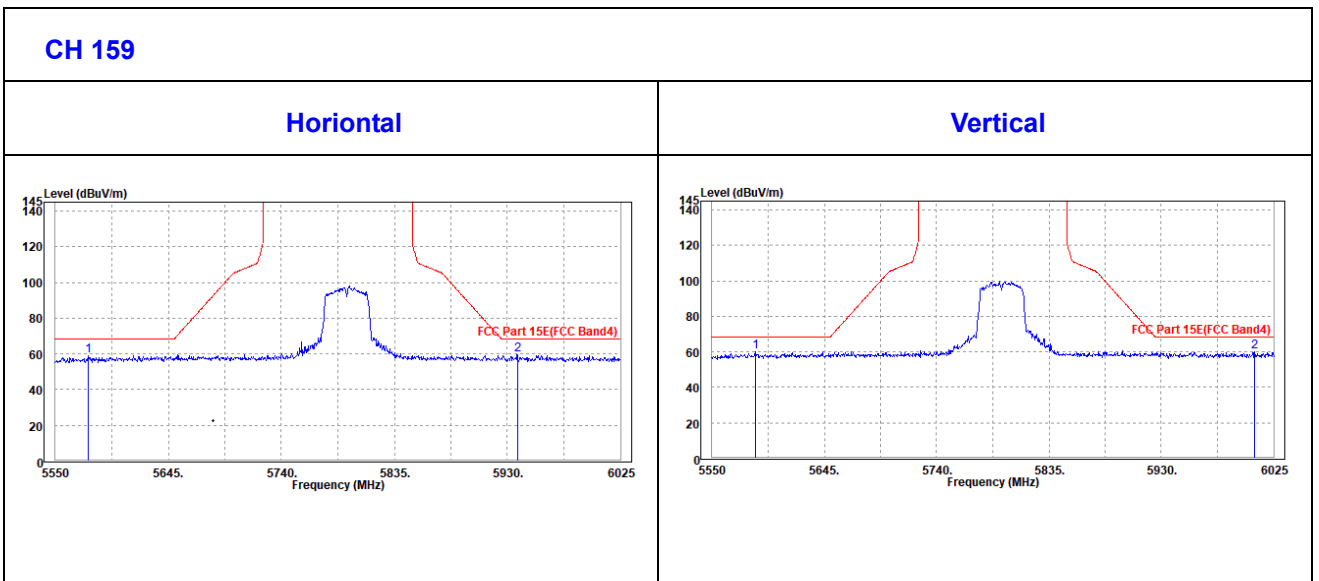



**802.11ac (80MHz)**

<b>CHANNEL</b>	TX Channel 155	<b>DETECTOR FUNCTION</b>	Peak (PK)
<b>FREQUENCY RANGE</b>	1GHz ~ 40GHz		Average (AV)

**ANTENNA POLARITY & TEST DISTANCE: HORIZONTAL AT 3 M**

FREQ. (MHz)	EMISSION LEVEL (dBuV/m)	READ LEVEL (dBuV)	LIMIT (dBuV/m)	MARGIN (dB)	ANTENNA FACTOR (dB /m)	CABLE LOSS (dB)	PREAMP FACTOR (dB)	ANTENNA HEIGHT (cm)	TABLE ANGLE (Degree)	REMARK
5775	96.53	98.51			36.41	7.78	46.17	200	200	Peak
5775	91.99	93.97			36.41	7.78	46.17	200	200	Average

**ANTENNA POLARITY & TEST DISTANCE: VERTICAL AT 3 M**

FREQ. (MHz)	EMISSION LEVEL (dBuV/m)	READ LEVEL (dBuV)	LIMIT (dBuV/m)	MARGIN (dB)	ANTENNA FACTOR (dB /m)	CABLE LOSS (dB)	PREAMP FACTOR (dB)	ANTENNA HEIGHT (cm)	TABLE ANGLE (Degree)	REMARK
5775	96.01	97.73			36.67	7.78	46.17	100	340	Peak
5775	91.49	93.21			36.67	7.78	46.17	100	340	Average

**REMARKS:**

- Emission Level = Read Level+ Antenna Factor + Cable Loss- Preamp Factor  
Margin value = Emission level – Limit value.
- 5775MHz: Fundamental frequency.



**OOBE DATA**

**802.11ac (80MHZ)**

ANTENNA POLARITY & TEST DISTANCE: HORIZONTAL AT 3 M										
FREQ. (MHz)	EMISSION LEVEL (dBuV/m)	READ LEVEL (dBuV)	LIMIT (dBuV/m)	MARGIN (dB)	ANTENNA FACTOR (dB /m)	CABLE LOSS (dB)	PREAMP FACTOR (dB)	ANTENNA HEIGHT (cm)	TABLE ANGLE (Degree)	REMARK
5609.375	59.17	61.44	68.2	-9.03	36.34	7.61	46.22	100	360	Peak
5946.625	59.72	61.4	68.2	-8.48	36.48	7.96	46.12	100	360	Peak
ANTENNA POLARITY & TEST DISTANCE: VERTICAL AT 3 M										
FREQ. (MHz)	EMISSION LEVEL (dBuV/m)	READ LEVEL (dBuV)	LIMIT (dBuV/m)	MARGIN (dB)	ANTENNA FACTOR (dB /m)	CABLE LOSS (dB)	PREAMP FACTOR (dB)	ANTENNA HEIGHT (cm)	TABLE ANGLE (Degree)	REMARK
5574.225	59.54	61.65	68.2	-8.66	36.54	7.58	46.23	200	360	Peak
5946.625	60.43	61.82	68.2	-7.77	36.77	7.96	46.12	200	360	Peak

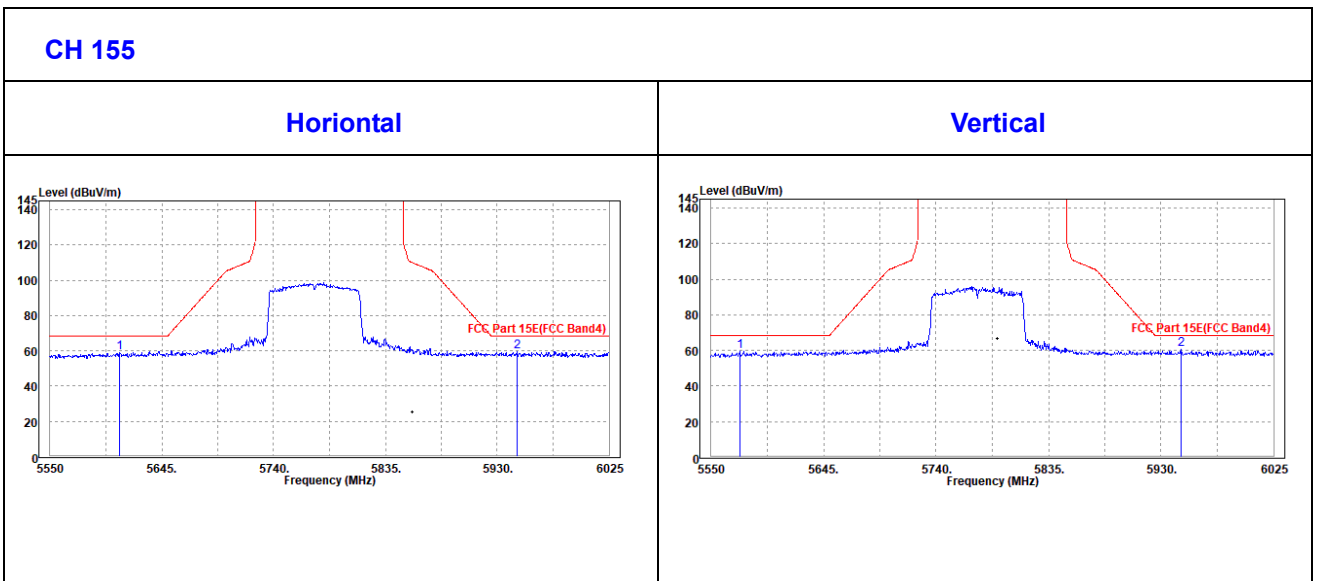





### 3.2 OUT OF BAND EMISSION MEASUREMENT

#### 3.2.1 LIMITS OF OUT OF BAND EMISSION MEASUREMENT

	APPLICABLE TO	EIRP LIMIT (dBm/MHz)
OUT OF THE RESTRICTED BANDS	15.407(b)(1)	-27
	15.407(b)(2)	
	15.407(b)(3)	
	15.407(b)(4)	See note

**NOTE:**

(b) Undesirable emission limits. Except as shown in paragraph (b)(7) of this section, the maximum emissions outside of the frequency bands of operation shall be attenuated in accordance with the following limits:

(1) For transmitters operating in the 5.15-5.25 GHz band: All emissions outside of the 5.15-5.35 GHz band shall not exceed an e.i.r.p. of -27 dBm/MHz.

(2) For transmitters operating in the 5.25-5.35 GHz band: All emissions outside of the 5.15-5.35 GHz band shall not exceed an e.i.r.p. of -27 dBm/MHz.

(3) For transmitters operating in the 5.47-5.725 GHz band: All emissions outside of the 5.47-5.725 GHz band shall not exceed an e.i.r.p. of -27 dBm/MHz.

(4) For transmitters operating in the 5.725-5.85 GHz band:

(i) All emissions shall be limited to a level of -27 dBm/MHz at 75 MHz or more above or below the band edge increasing linearly to 10 dBm/MHz at 25 MHz above or below the band edge, and from 25 MHz above or below the band edge increasing linearly to a level of 15.6 dBm/MHz at 5 MHz above or below the band edge, and from 5 MHz above or below the band edge increasing linearly to a level of 27 dBm/MHz at the band edge.



### 3.2.2 TEST INSTRUMENTS

Equipment	Manufacturer	Model No.	Serial No.	Last Cal.	Next Cal.
10dB Attenuator	JFW/USA	50HF-010-SMA	1505	Jun. 03,20	Jun. 02,21
10dB Attenuator	JFW/USA	50HF-010-SMA	1505	Jun. 03,21	Jun. 02,22
EXA Signal Analyzer	KEYSIGHT	N9010A-544	MY54510355	Jun. 03,20	Jun. 02,21
EXA Signal Analyzer	KEYSIGHT	N9010A-544	MY54510355	Jun. 03,21	Jun. 02,22
DC Source	Kikusui/JP	PMX18-5A	0000001	Aug. 26,20	Aug. 25,21

**NOTE:**

1. The calibration interval of the above test instruments is 12 months and the calibrations are traceable to CEPREI/CHINA, GRGT/CHINA and NIM/CHINA.
2. The test was performed in RF OVEN ROOM.
3. The FCC Site Registration No. is 525120; The Designation No. is CN1171.

### 3.2.3 TEST PROCEDURES

- a. Check the calibration of the measurement instrument using either an internal calibrator or a known signal from an external generator.
- b. The resolution bandwidth is set to 1MHzThe Video bandwidth is set to ≥1MHz, report the peak value out of oprating band.
- c. Repeat above procedures until all frequencies measured wre complete.

**NOTE:** All modes of operation were investigated and the worst-case emissions are reported,antenna gain was added into the test result.

### 3.2.4 DEVIATION FROM TEST STANDARD

No deviation.

### 3.2.5 TEST SETUP

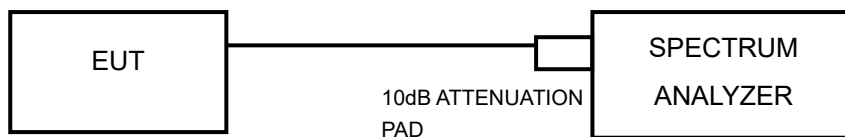

### 3.2.6 EUT OPERATING CONDITION

- a. Set the EUT under full load condition and placed them on a testing table.
- b. Set the transmitter part of EUT under transmission condition continuously at specific channel frequency.
- c. The necessary accessories enable the EUT in full functions.



### 3.2.7 TEST RESULTS

For U-NII-1:

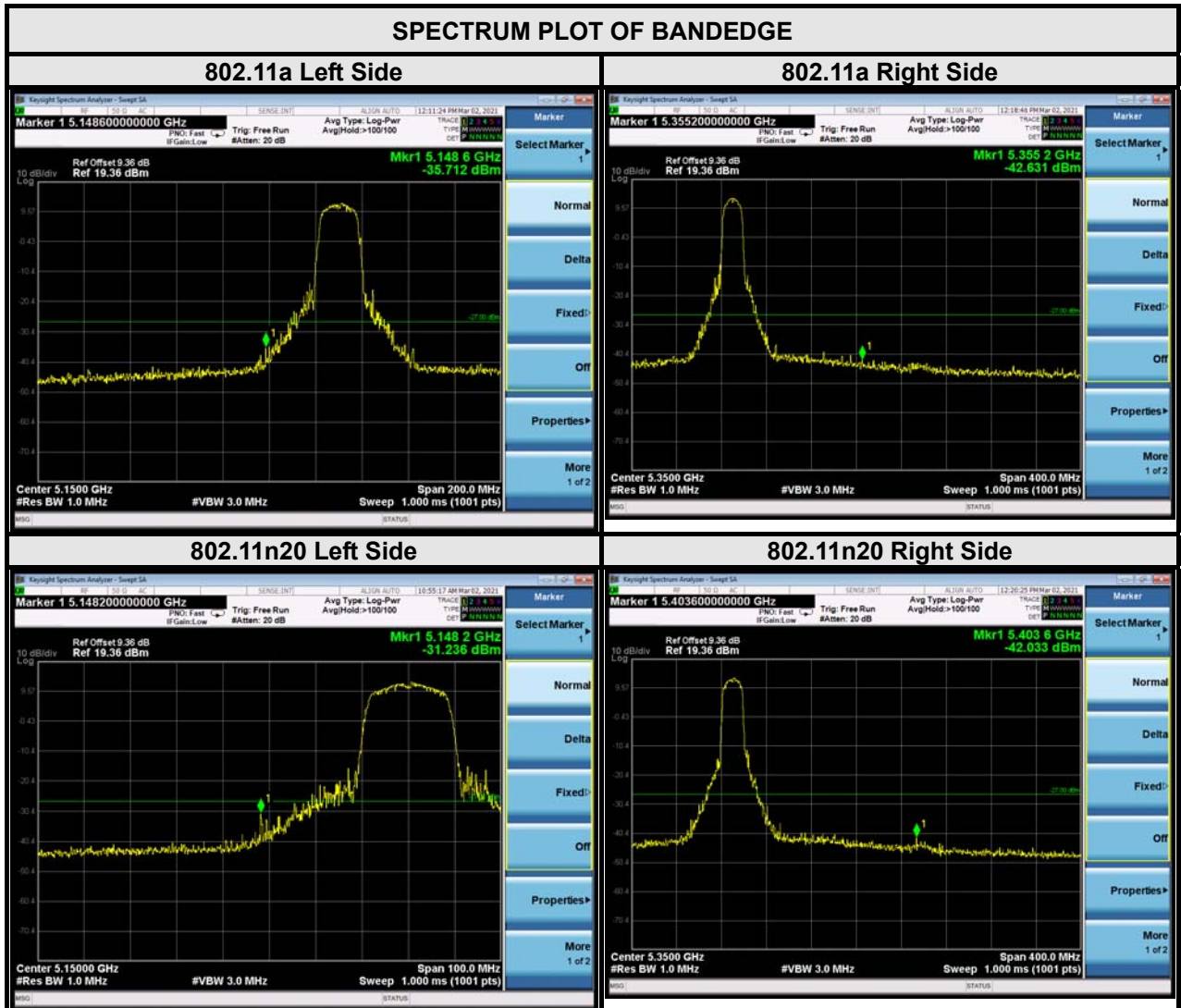

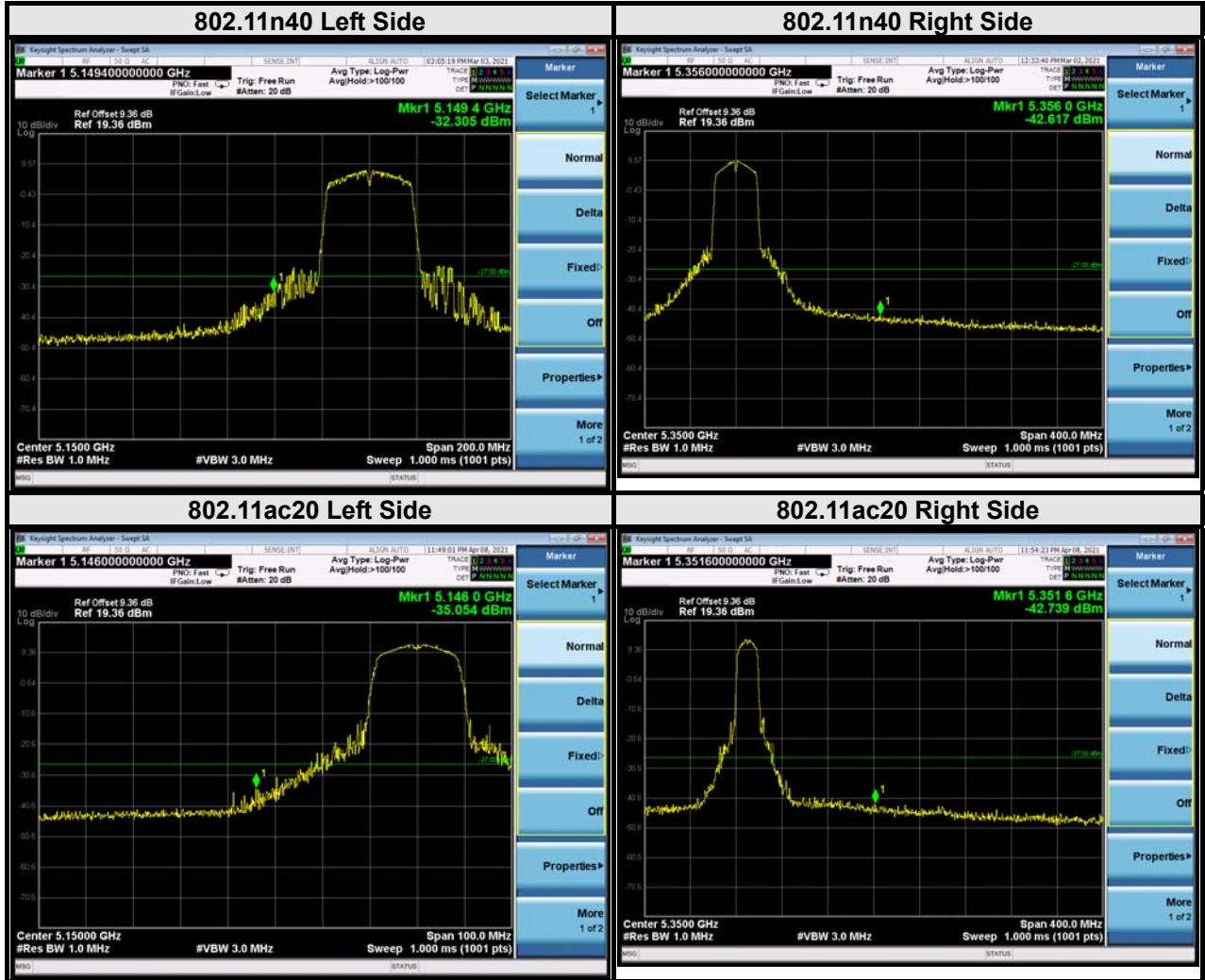

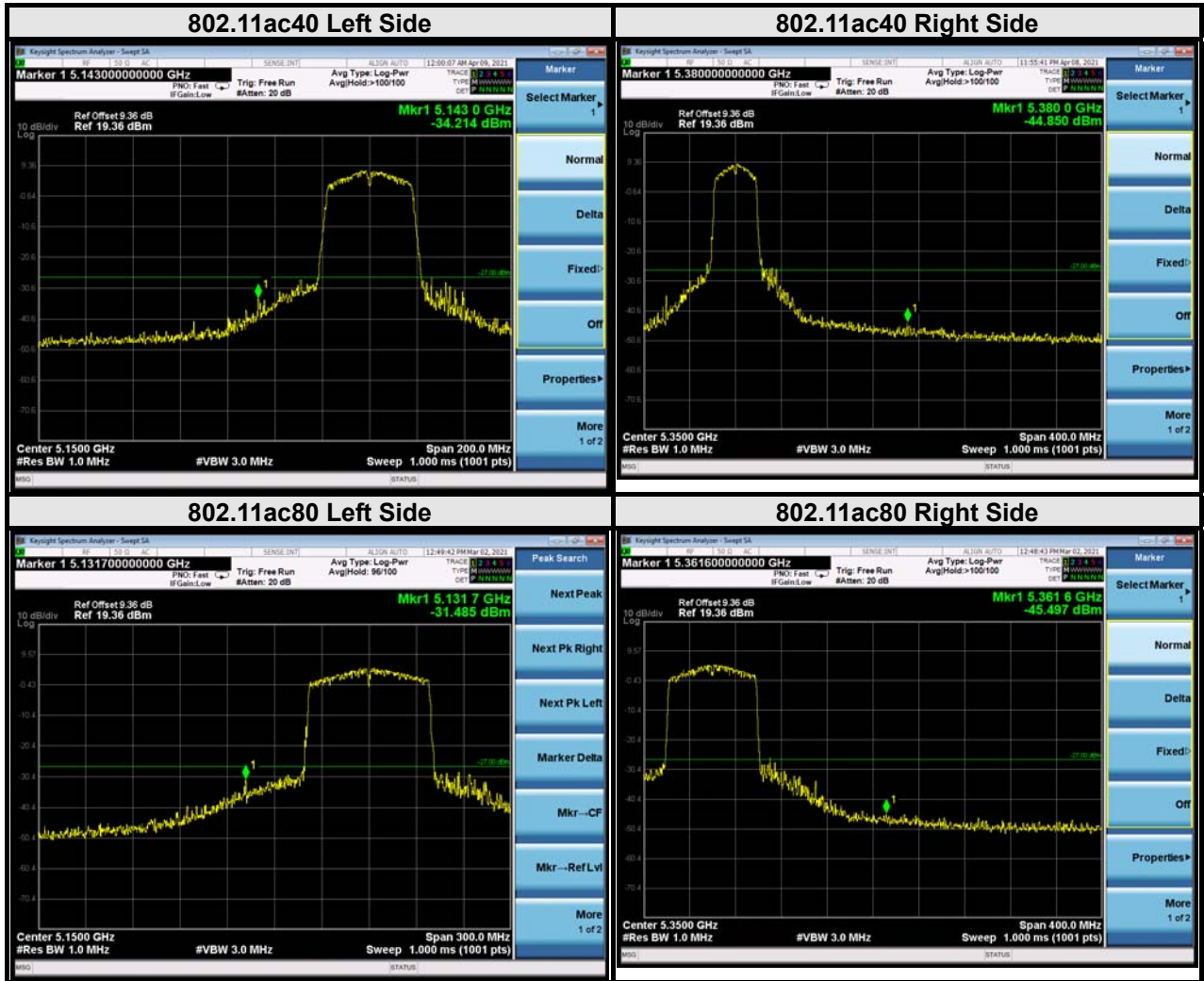



For U-NII-2A:

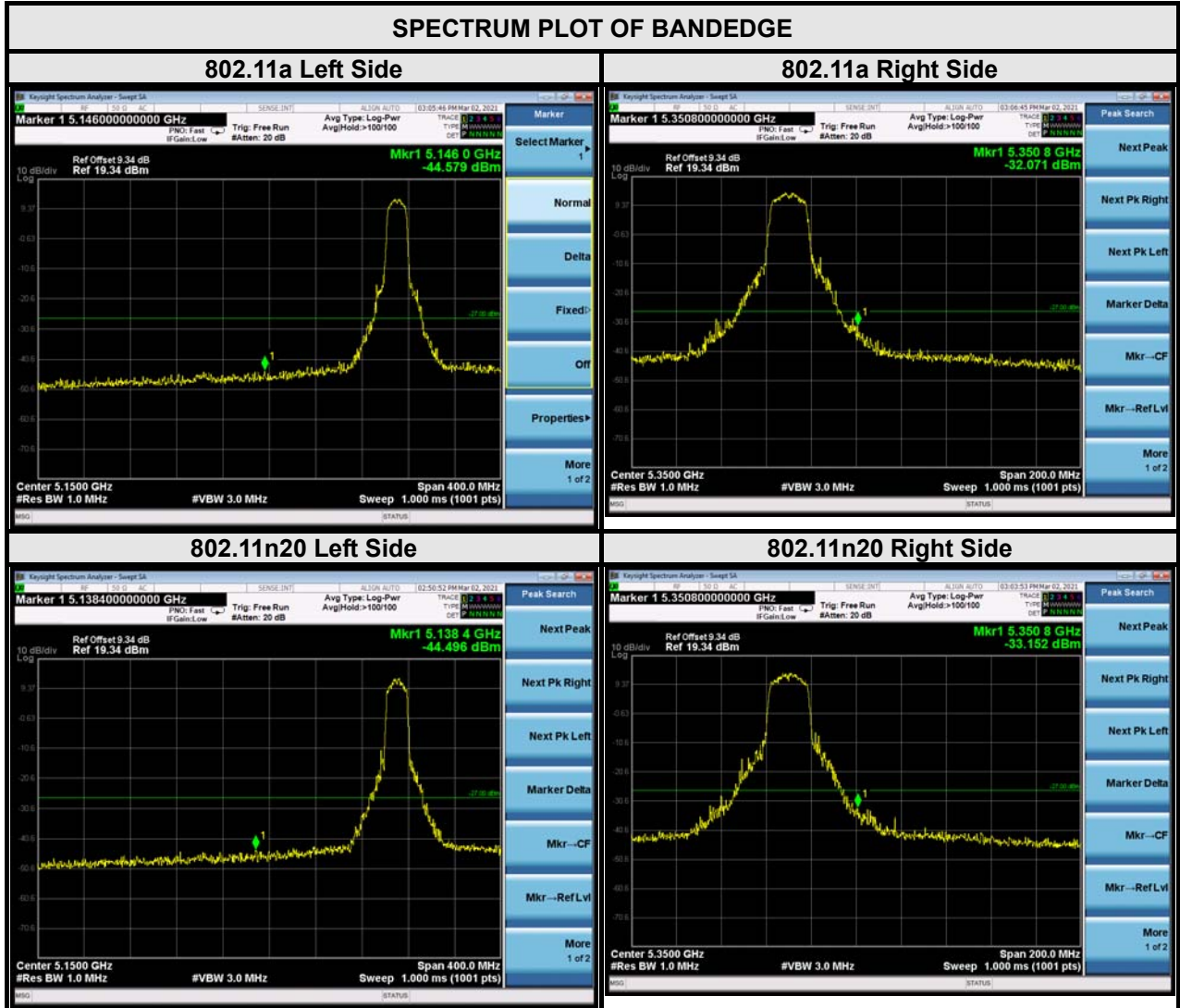

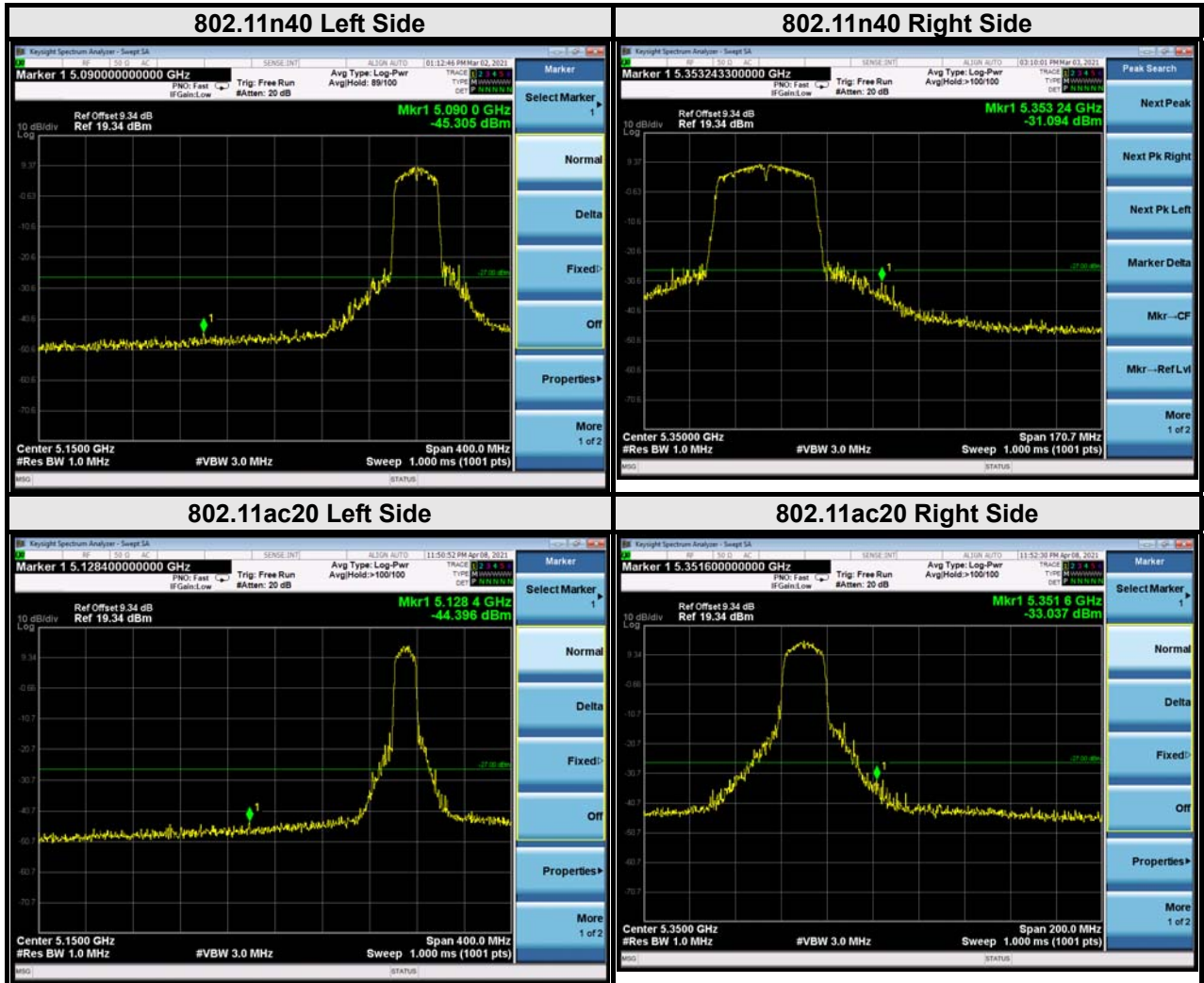

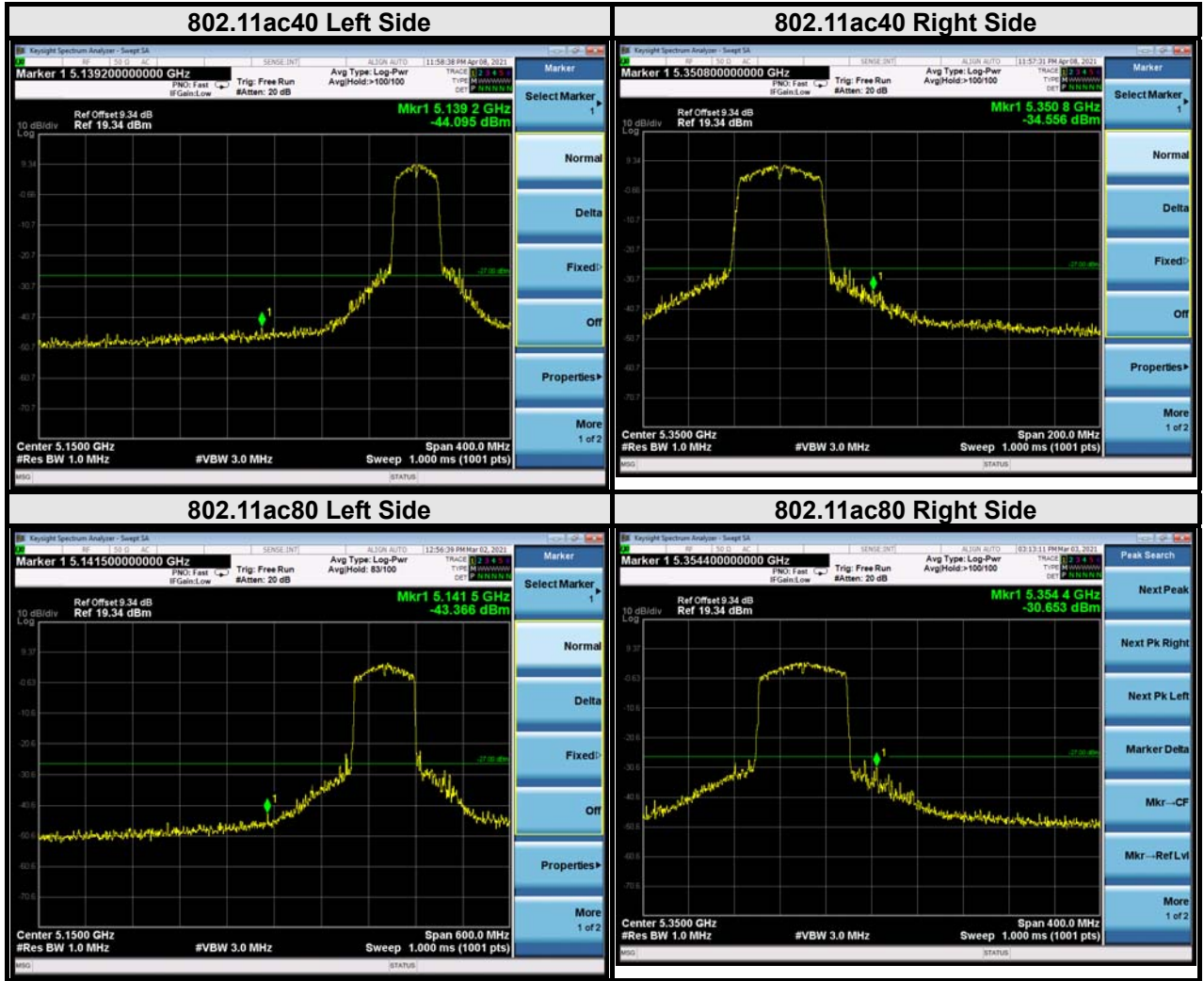





For U-NII-2C:

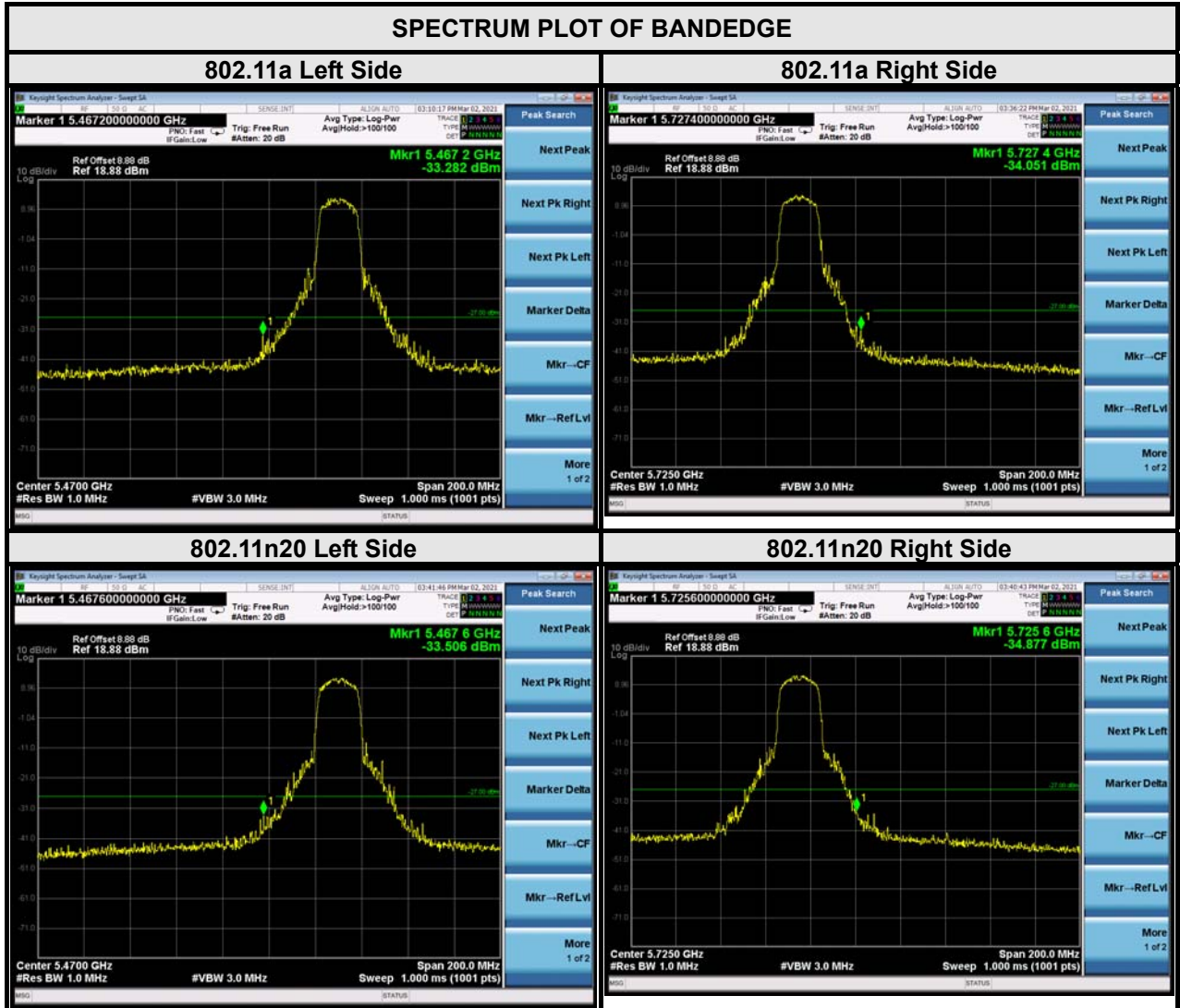

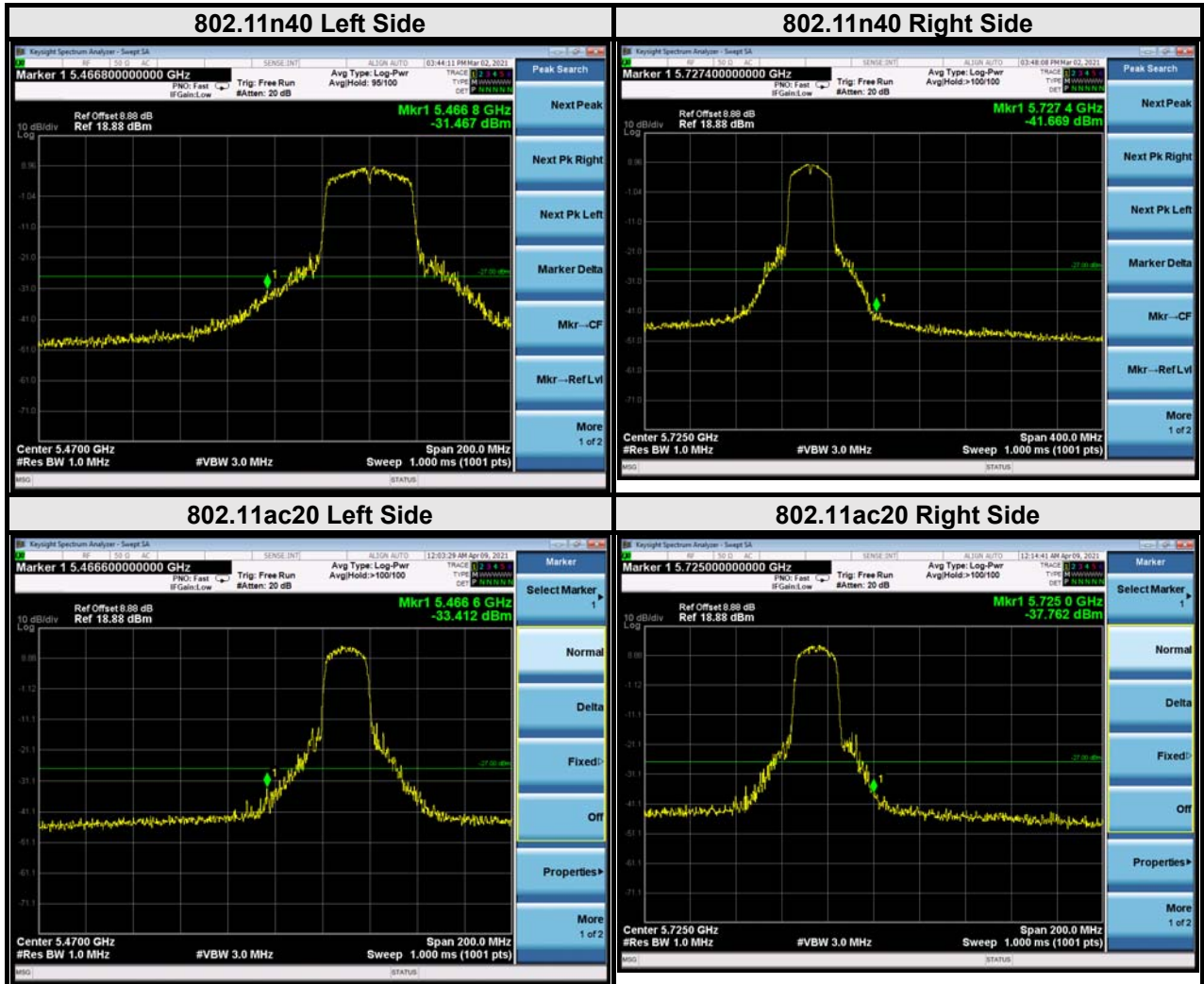

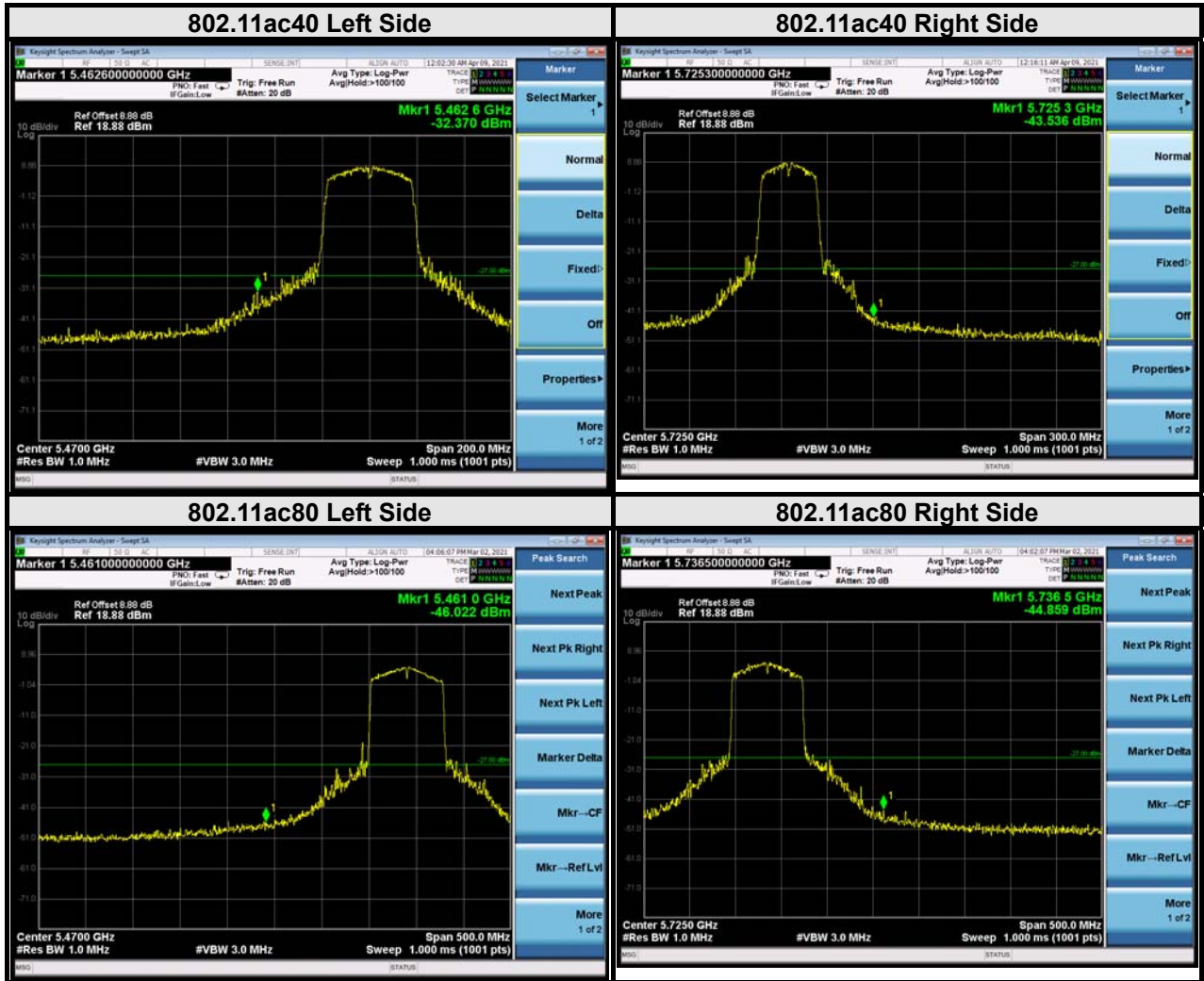



For U-NII-3:

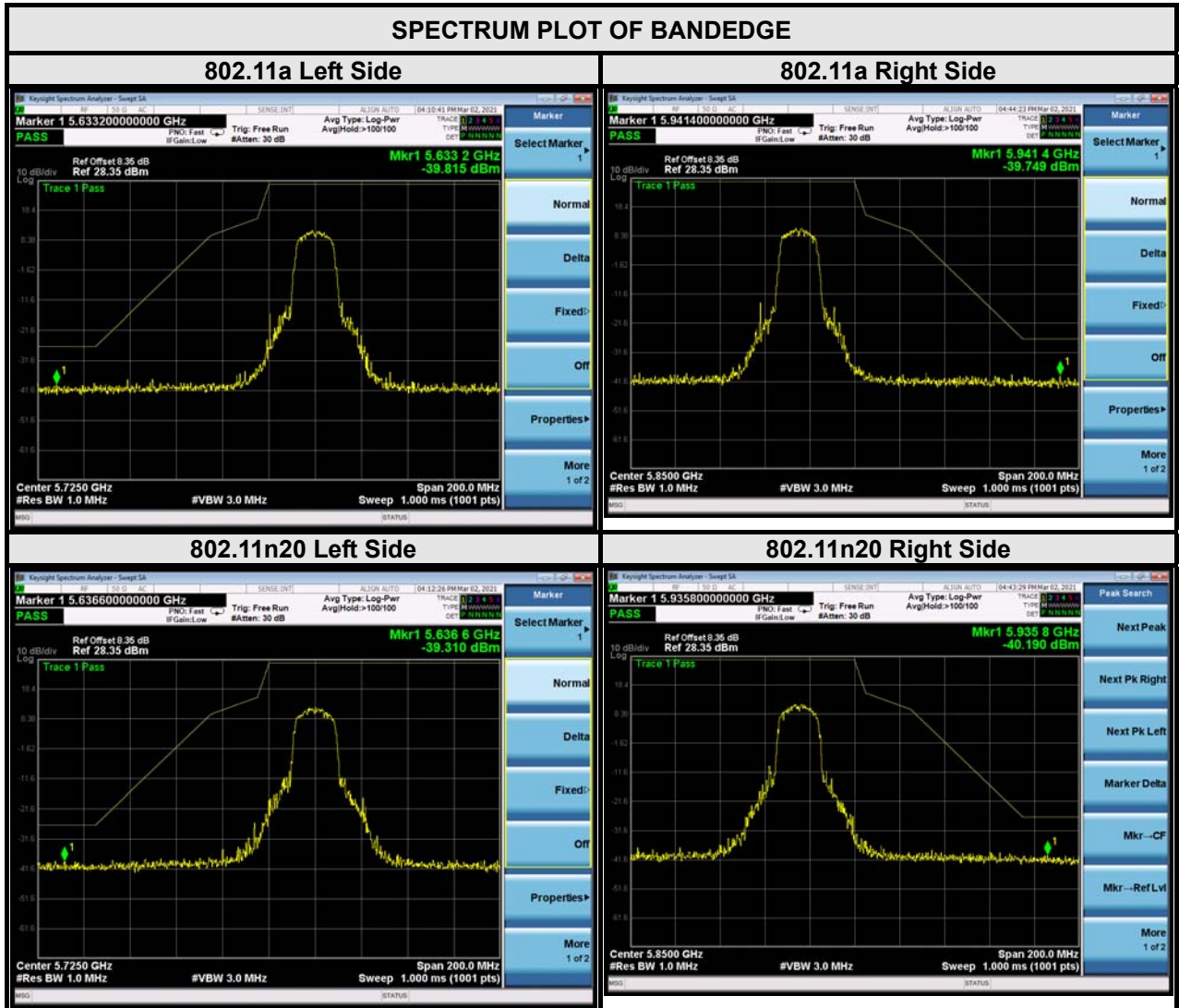

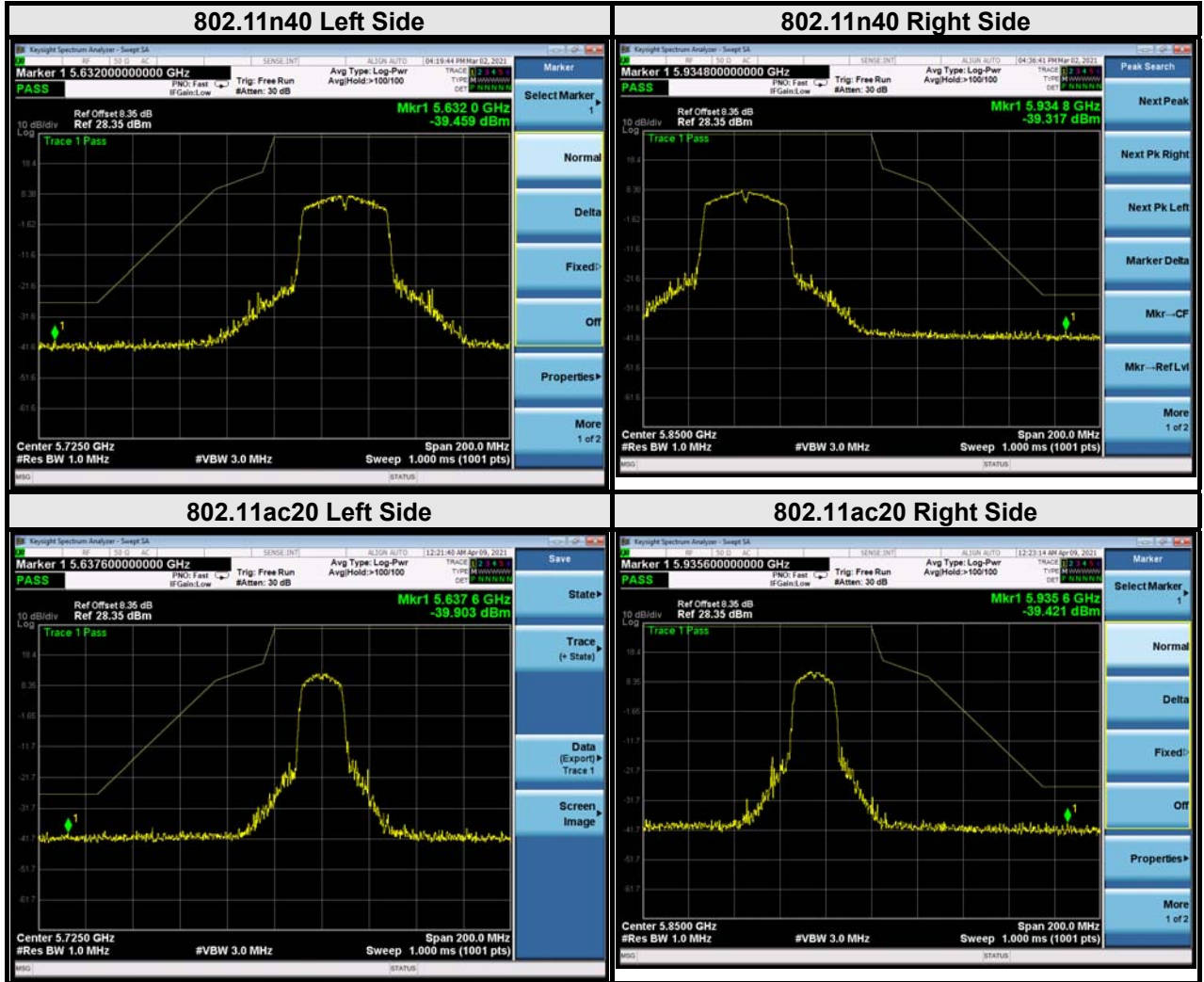

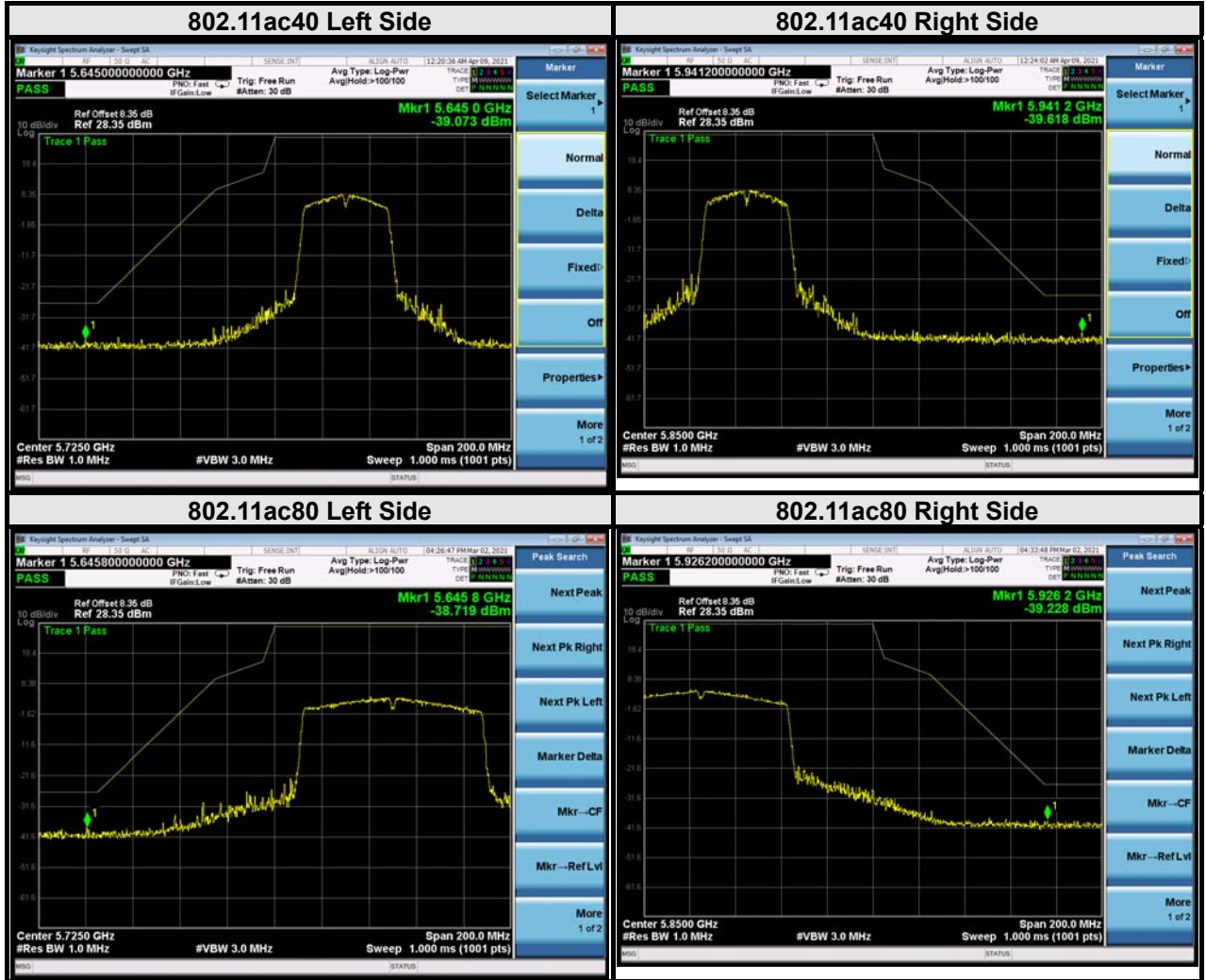



### 3.3 CONDUCTED EMISSION MEASUREMENT

#### 3.3.1 LIMITS OF CONDUCTED EMISSION MEASUREMENT

FREQUENCY OF EMISSION (MHz)	CONDUCTED LIMIT (dBµV)	
	Quasi-peak	Average
0.15 ~ 0.5	66 to 56	56 to 46
0.5 ~ 5	56	46
5 ~ 30	60	50

- NOTE:**
1. The lower limit shall apply at the transition frequencies.
  2. The limit decreases in line with the logarithm of the frequency in the range of 0.15 to 0.50MHz.
  3. All emanations from a class A/B digital device or system, including any network of conductors and apparatus connected thereto, shall not exceed the level of field strengths specified above.

#### 3.3.2 TEST INSTRUMENTS

Equipment	Manufacturer	Model No.	Serial No.	Last Cal.	Next Cal.
EMI Test Receiver	Rohde&Schwarz	ESR3	101900	Mar. 03,21	Mar. 02,22
EMI Test Receiver	Rohde&Schwarz	ESR3	101900	Mar. 04,20	Mar. 03,21
EMC32 test software	Rohde&Schwarz	EMC32	NA	NA	NA
LISN network	Rohde&Schwarz	ENV216	101922	Feb. 22,21	Feb. 21,22
DC Source	Kikusui/JP	PMX18-5A	0000001	Aug. 26,20	Aug. 25,21

- NOTE:**
1. The test was performed in CE shielded room.
  2. The calibration interval of the above test instruments is 12 months. And the calibrations are traceable to CEPREI/CHINA, GRGT/CHINA and NIM/CHINA.

#### 3.3.3 TEST PROCEDURES

- a. The EUT was placed 0.4 meters from the conducting wall of the shielded room with EUT being connected to the power mains through a line impedance stabilization network (LISN). Other support units were connected to the power mains through another LISN. The two LISNs provide 50 ohm/ 50uH of coupling impedance for the measuring instrument.
- b. Both lines of the power mains connected to the EUT were checked for maximum conducted interference.
- c. The frequency range from 150kHz to 30MHz was searched. Emission levels under (Limit - 20dB) was not recorded.

**NOTE:** All modes of operation were investigated and the worst-case emissions are reported.



### 3.3.4 DEVIATION FROM TEST STANDARD

No deviation.

### 3.3.5 TEST SETUP

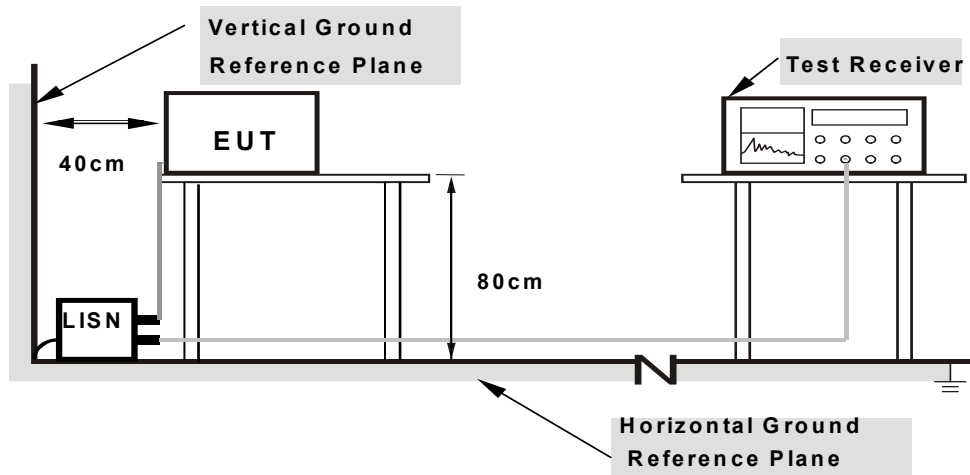

- Note:**
- 1.Support units were connected to second LISN.
  - 2.Both of LISNs (AMN) are 80 cm from EUT and at least 80 cm from other units and other metal planes

For the actual test configuration, please refer to the attached file (Test Setup Photo).

### 3.3.6 EUT OPERATING CONDITIONS

Same as 3.1.6.





### 3.3.7 TEST RESULTS

**CONDUCTED WORST-CASE DATA :**

<b>Frequency Range</b>	150KHz ~ 30MHz	<b>Detector Function &amp; Resolution Bandwidth</b>	Quasi-Peak (QP) / Average (AV), 9 kHz
<b>Input Power</b>	120Vac, 60Hz	<b>Environmental Conditions</b>	24deg. C, 55%RH
<b>Tested By</b>	Carl Xie		

Frequency (MHz)	QuasiPeak (dB $\mu$ V)	CAverage (dB $\mu$ V)	Limit (dB $\mu$ V)	Margin (dB)	Line	Filter	Corr. (dB)
0.150000	---	17.28	56.00	38.72	L	ON	9.7
0.150000	29.58	---	66.00	36.42	L	ON	9.7
0.588000	---	34.30	46.00	11.70	L	ON	9.7
0.588000	40.86	---	56.00	15.14	L	ON	9.7
0.968000	---	21.51	46.00	24.49	L	ON	9.7
0.968000	27.19	---	56.00	28.81	L	ON	9.7
1.544000	---	15.56	46.00	30.44	L	ON	9.8
1.544000	22.67	---	56.00	33.33	L	ON	9.8
2.216000	---	14.48	46.00	31.52	L	ON	9.8
2.216000	20.04	---	56.00	35.96	L	ON	9.8
4.696000	---	15.55	46.00	30.45	L	ON	9.8
4.696000	22.25	---	56.00	33.75	L	ON	9.8

- REMARKS:**
1. Q.P. and AV. are abbreviations of quasi-peak and average individually.
  2. "-": The Quasi-peak reading value also meets average limit and measurement with the average detector is unnecessary.
  3. The emission levels of other frequencies were very low against the limit.
  4. Margin value = Emission level - Limit value
  5. Correction factor = Insertion loss + Cable loss
  6. Emission Level = Correction Factor + Reading Value.

Full Spectrum

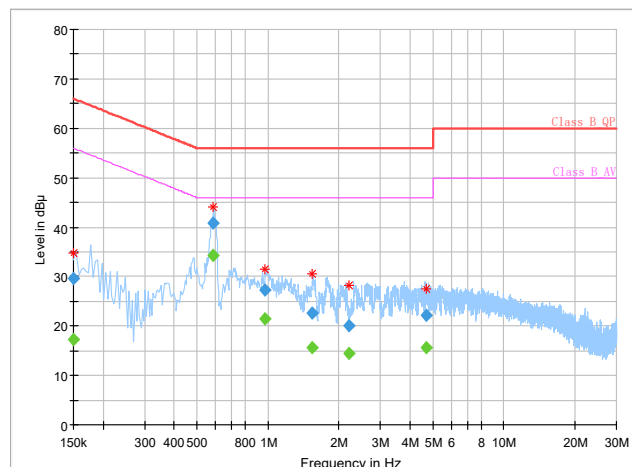



<b>Frequency Range</b>	150KHz ~ 30MHz	<b>Detector Function &amp; Resolution Bandwidth</b>	Quasi-Peak (QP) / Average (AV), 9 kHz
<b>Input Power</b>	120Vac, 60Hz	<b>Environmental Conditions</b>	24deg. C, 55%RH
<b>Tested By</b>	Carl Xie		

Frequency (MHz)	QuasiPeak (dB $\mu$ V)	CAverage (dB $\mu$ V)	Limit (dB $\mu$ V)	Margin (dB)	Line	Filter	Corr. (dB)
0.384000	---	19.67	48.19	28.52	N	ON	9.8
0.384000	27.52	---	58.19	30.67	N	ON	9.8
0.592000	---	32.47	46.00	13.53	N	ON	9.8
0.592000	42.56	---	56.00	13.44	N	ON	9.8
0.728000	---	19.47	46.00	26.53	N	ON	9.8
0.728000	28.65	---	56.00	27.35	N	ON	9.8
1.624000	---	18.98	46.00	27.02	N	ON	9.8
1.624000	28.94	---	56.00	27.06	N	ON	9.8
2.686000	---	13.03	46.00	32.97	N	ON	9.9
2.686000	22.03	---	56.00	33.97	N	ON	9.9
3.768000	---	14.41	46.00	31.59	N	ON	9.9
3.768000	24.52	---	56.00	31.48	N	ON	9.9

- REMARKS:**
1. Q.P. and AV. are abbreviations of quasi-peak and average individually.
  2. "-": The Quasi-peak reading value also meets average limit and measurement with the average detector is unnecessary.
  3. The emission levels of other frequencies were very low against the limit.
  4. Margin value = Emission level - Limit value
  5. Correction factor = Insertion loss + Cable loss
  6. Emission Level = Correction Factor + Reading Value.

Full Spectrum

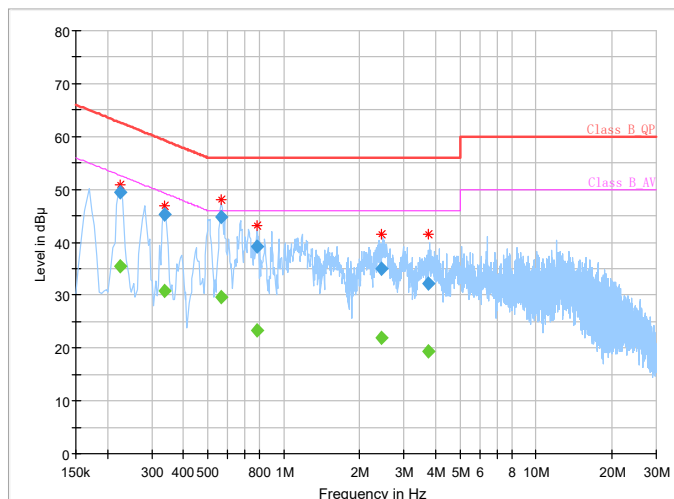



### 3.4 MAXIMUM CONDUCTED OUTPUT POWER MEASUREMENT

#### 3.4.1 LIMITS OF MAXIMUM CONDUCTED OUTPUT POWER MEASUREMENT

Operation Band	EUT Category		LIMIT
U-NII-1		Outdoor Access Point	1 Watt (30 dBm) (Max. e.i.r.p $\leq$ 125mW(21 dBm) at any elevation angle above 30 degrees as measured from the horizon)
		Fixed point-to-point Access Point	1 Watt (30 dBm)
	<b>B</b>	Indoor Access Point	1 Watt (30 dBm)
	√	Client devices	250mW (24 dBm)
U-NII-2A	√		250mW (24 dBm) or 11 dBm+10 log B*
U-NII-2C	√		250mW (24 dBm) or 11 dBm+10 log B*
U-NII-3	√		1 Watt (30 dBm)

**NOTE:** Where B is the 26dB emission bandwidth in MHz.



### 3.4.2 TEST SETUP

#### FOR POWER OUTPUT MEASUREMENT

#### 802.11a, 802.11n (20MHz), 802.11n (40MHz) TEST CONFIGURATION

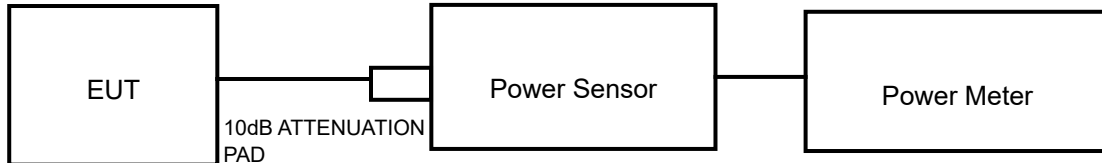

#### 11ac TEST CONFIGURATION

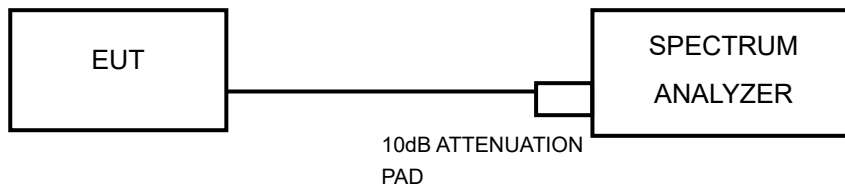

#### FOR 26dB BANDWIDTH

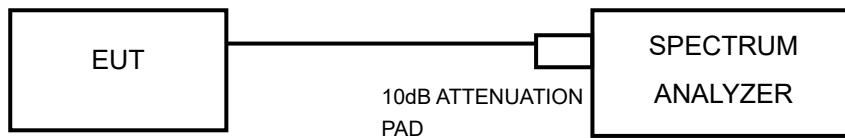

### 3.4.3 TEST INSTRUMENTS

Equipment	Manufacturer	Model No.	Serial No.	Last Cal.	Next Cal.
Power Meter	ANRITSU	ML2495A	1506002	Feb. 22,21	Feb. 21,22
EXA Signal Analyzer	KEYSIGHT	N9010A-526	MY54510322	Apr. 27,20	Apr. 26,21
EXA Signal Analyzer	KEYSIGHT	N9010A-526	MY54510322	Apr. 27,21	Apr. 26,22
EXA Signal Analyzer	KEYSIGHT	N9010A-544	MY54510355	Feb. 22,21	Feb. 21,22
Power Sensor	ANRITSU	MA2411B	1339352	Feb. 22,21	Feb. 21,22
DC Source	Kikusui/JP	PMX18-5A	0000001	Aug. 26,20	Aug. 25,21

**NOTE:**

1. The calibration interval of the above test instruments is 12 months and the calibrations are traceable to CEPREI/CHINA, GRGT/CHINA and NIM/CHINA.
2. The test was performed in RF Oven room.



### 3.4.4 TEST PROCEDURE

#### FOR POWER MEASUREMENT

##### For 802.11a, 802.11n (20MHz), 802.11n (40MHz)

Method PM is used to perform output power measurement, trigger and gating function of wide band power meter is enabled to measure max output power of TX on burst. Duty factor is not added to measured value.

##### For 802.11ac (80MHz)

1. Measure the duty cycle,  $x$ , of the transmitter output signal as described in II.B.
2. Set span to encompass the EBW (or, alternatively, the entire 99% occupied bandwidth) of the signal.
3. Set RBW = 1 MHz.
4. Set VBW  $\geq$  3 MHz.
5. Number of points in sweep  $\geq 2 \times \text{span} / \text{RBW}$ . (This ensures that bin-to-bin spacing is  $\leq \text{RBW}/2$ , so that narrowband signals are not lost between frequency bins.)
6. Sweep time = auto.
7. Detector = power averaging (rms), if available. Otherwise, use sample detector mode.
8. Do not use sweep triggering. Allow the sweep to “free run.”
9. Trace average at least 100 traces in power averaging (rms) mode; however, the number of traces to be averaged shall be increased above 100 as needed to ensure that the average accurately represents the true average over the on and off periods of the transmitter.
10. Add  $10 \log (1/x)$ , where  $x$  is the duty cycle, to the measured power to compute the average power during the actual transmission times (because the measurement represents an average over both the on and off times of the transmission). For example, add  $10 \log (1/0.25) = 6 \text{ dB}$  if the duty cycle is 25%.



#### **FOR 99 PERCENT OCCUPIED BANDWIDTH**

The following procedure shall be used for measuring (99 %) power bandwidth:

1. Set center frequency to the nominal EUT channel center frequency.
2. Set span = 1.5 times to 5.0 times the OBW.
3. Set RBW = 1 % to 5 % of the OBW
4. Set VBW  $\geq 3 \cdot$  RBW
5. Video averaging is not permitted. Where practical, a sample detection and single sweep mode shall be used. Otherwise, peak detection and max hold mode (until the trace stabilizes) shall be used.
6. Use the 99 % power bandwidth function of the instrument (if available).
7. If the instrument does not have a 99 % power bandwidth function, the trace data points are recovered and directly summed in power units. The recovered amplitude data points, beginning at the lowest frequency, are placed in a running sum until 0.5 % of the total is reached; that frequency is recorded as the lower frequency. The process is repeated until 99.5 % of the total is reached; that frequency is recorded as the upper frequency. The 99% occupied bandwidth is the difference between these two frequencies.

#### **FOR 26dB BANDWIDTH**

- 1) Set RBW = approximately 1% of the emission bandwidth.
- 2) Set the VBW > RBW.
- 3) Detector = Peak.
- 4) Trace mode = max hold.
- 5) Measure the maximum width of the emission that is 26 dB down from the peak of the emission. Compare this with the RBW setting of the analyzer. Readjust RBW and repeat measurement as needed until the RBW/EBW ratio is approximately 1%.

#### **FOR 6dB BANDWIDTH**

1. Set RBW = 100 kHz.
2. Set the video bandwidth (VBW)  $\geq 3$  RBW.
3. Detector = Peak.
4. Trace mode = max hold.
5. Sweep = auto couple.
6. Allow the trace to stabilize.
7. Measure the maximum width of the emission that is constrained by the frequencies associated with the two outermost amplitude points (upper and lower frequencies) that are attenuated by 6 dB relative to the maximum level measured in the fundamental emission.



Test Report No.: RF210603W002-6

### 3.4.5 DEVIATION FROM TEST STANDARD

No deviation.

### 3.4.6 EUT OPERATING CONDITIONS

The software provided by client to enable the EUT under transmission condition continuously at specific channel frequencies individually.



### 3.4.7 TEST RESULTS

#### OUTPUT POWER:

#### 802.11a

CHANNEL	CHANNEL FREQUENCY (MHz)	AVERAGE POWER (dBm)	Duty Factor	FINAL AVERAGE POWER (dBm)	FINAL AVERAGE POWER (mW)	POWER LIMIT (dBm)	PASS/FAIL
36	5180	18.28	0	18.28	67.30	24	PASS
40	5200	18.14	0	18.14	65.16	24	PASS
48	5240	19.28	0	19.28	84.72	24	PASS
52	5260	18.30	0	18.30	67.61	24	PASS
60	5300	18.72	0	18.72	74.47	24	PASS
64	5320	19.15	0	19.15	82.22	24	PASS
100	5500	19.30	0	19.30	85.11	24	PASS
116	5580	19.02	0	19.02	79.80	24	PASS
140	5700	19.18	0	19.18	82.79	24	PASS
144	5720	18.50	0	18.50	70.79	24	PASS
144	5720	18.50	0	18.50	70.79	30	PASS
149	5745	18.45	0	18.45	69.98	30	PASS
157	5785	18.32	0	18.32	67.92	30	PASS
165	5825	18.55	0	18.55	71.61	30	PASS





802.11n (20MHz)

CHANNEL	CHANNEL FREQUENCY (MHz)	AVERAGE POWER (dBm)	Duty Factor	FINAL AVERAGE POWER (dBm)	FINAL AVERAGE POWER (mW)	POWER LIMIT (dBm)	PASS/FAIL
36	5180	18.32	0	18.32	67.92	24	PASS
40	5200	18.68	0	18.68	73.79	24	PASS
48	5240	19.06	0	19.06	80.54	24	PASS
52	5260	18.02	0	18.02	63.39	24	PASS
60	5300	18.56	0	18.56	71.78	24	PASS
64	5320	18.80	0	18.80	75.86	24	PASS
100	5500	18.92	0	18.92	77.98	24	PASS
116	5580	19.24	0	19.24	83.95	24	PASS
140	5700	18.54	0	18.54	71.45	24	PASS
144	5720	18.26	0	18.26	66.99	24	PASS
144	5720	18.26	0	18.26	66.99	30	PASS
149	5745	19.10	0	19.10	81.28	30	PASS
157	5785	18.62	0	18.62	72.78	30	PASS
165	5825	18.58	0	18.58	72.11	30	PASS



802.11n (40MHz)

CHANNEL	CHANNEL FREQUENCY (MHz)	AVERAGE POWER (dBm)	Duty Factor	FINAL AVERAGE POWER (dBm)	FINAL AVERAGE POWER (mW)	POWER LIMIT (dBm)	PASS/FAIL
38	5190	16.04	0	16.04	40.18	24	PASS
46	5230	17.82	0	17.82	60.53	24	PASS
54	5270	17.22	0	17.22	52.72	24	PASS
62	5310	16.24	0	16.24	42.07	24	PASS
102	5510	17.88	0	17.88	61.38	24	PASS
110	5550	17.46	0	17.46	55.72	24	PASS
134	5670	17.57	0	17.57	57.15	24	PASS
142	5710	17.35	0	17.35	54.33	24	PASS
142	5710	17.35	0	17.35	54.33	30	PASS
151	5755	17.86	0	17.86	54.33	30	PASS
159	5795	17.42	0	17.42	61.09	30	PASS

802.11ac (20MHz)

CHANNEL	CHANNEL FREQUENCY (MHz)	AVERAGE POWER (dBm)	Duty Factor	FINAL AVERAGE POWER (dBm)	FINAL AVERAGE POWER (mW)	POWER LIMIT (dBm)	PASS/FAIL
36	5180	18.30	0	18.30	67.61	24	PASS
40	5200	18.72	0	18.72	74.47	24	PASS
48	5240	19.18	0	19.18	82.79	24	PASS
52	5260	18.08	0	18.08	64.27	24	PASS
60	5300	18.65	0	18.65	73.28	24	PASS
64	5320	18.78	0	18.78	75.51	24	PASS
100	5500	18.98	0	18.98	79.07	24	PASS
116	5580	19.26	0	19.26	84.33	24	PASS
140	5700	18.58	0	18.58	72.11	24	PASS
144	5720	18.32	0	18.32	67.92	24	PASS
144	5720	18.32	0	18.32	67.92	30	PASS
149	5745	18.96	0	18.96	78.70	30	PASS
157	5785	18.50	0	18.50	70.79	30	PASS
165	5825	18.58	0	18.58	72.11	30	PASS



802.11ac (40MHz)

CHANNEL	CHANNEL FREQUENCY (MHz)	AVERAGE POWER (dBm)	Duty Factor	FINAL AVERAGE POWER (dBm)	FINAL AVERAGE POWER (mW)	POWER LIMIT (dBm)	PASS/FAIL
38	5190	16.52	0	16.52	44.87	24	PASS
46	5230	17.84	0	17.84	60.81	24	PASS
54	5270	17.12	0	17.12	51.52	24	PASS
62	5310	15.58	0	15.58	36.14	24	PASS
102	5510	18.02	0	18.02	63.39	24	PASS
110	5550	17.48	0	17.48	55.98	24	PASS
134	5670	17.50	0	17.50	56.23	24	PASS
142	5710	17.36	0	17.36	54.45	24	PASS
142	5710	17.36	0	17.36	54.45	30	PASS
151	5755	17.65	0	17.65	54.45	30	PASS
159	5795	17.32	0	17.32	58.21	30	PASS

802.11ac (80MHz)

CHANNEL	CHANNEL FREQUENCY (MHz)	AVERAGE POWER (dBm)	Duty Factor	FINAL AVERAGE POWER (dBm)	FINAL AVERAGE POWER (mW)	POWER LIMIT (dBm)	PASS/FAIL
42	5210	16.68	0	16.68	46.56	24	PASS
58	5290	14.50	0	14.50	28.18	24	PASS
106	5530	16.62	0	16.62	45.92	24	PASS
122	5610	14.53	0	14.53	28.38	24	PASS
138	5690	16.20	0	16.20	41.69	24	PASS
138	5690	16.20	0	16.20	41.69	30	PASS
155	5775	16.52	0	16.52	44.87	30	PASS



**99% OCCUPIED BANDWIDTH & 26dB BANDWIDTH/6dB BANDWIDTH DATA FROM:**

**802.11a**

CHANNEL	CHANNEL FREQUENCY (MHz)	99% OCCUPIED BANDWIDTH	26dB BANDWIDTH (MHz)	PASS/FAIL
36	5180	16.62	19.85	PASS
40	5200	16.56	20.14	PASS
48	5240	16.62	19.88	PASS
52	5260	16.68	20.07	PASS
60	5300	16.62	20.34	PASS
64	5320	16.74	21.10	PASS
100	5500	16.62	20.85	PASS
116	5580	16.62	19.99	PASS
140	5700	16.68	20.14	PASS
144	5720	16.62	20.44	PASS
CHANNEL	CHANNEL FREQUENCY	99% OCCUPIED BANDWIDTH	6dB BANDWIDTH	PASS/FAIL
144	5720	16.62	16.33	PASS
149	5745	16.62	16.35	PASS
157	5785	16.62	16.33	PASS
165	5825	16.56	16.33	PASS



802.11n (20MHz)

CHANNEL	CHANNEL FREQUENCY (MHz)	99% OCCUPIED BANDWIDTH	26dB BANDWIDTH (MHz)	PASS/FAIL
36	5180	17.70	20.33	PASS
40	5200	17.70	20.35	PASS
48	5240	17.64	20.29	PASS
52	5260	17.70	20.33	PASS
60	5300	17.70	22.66	PASS
64	5320	17.76	20.50	PASS
100	5500	17.64	20.46	PASS
116	5580	17.70	20.79	PASS
140	5700	17.70	20.13	PASS
142	5720	17.82	23.53	PASS
CHANNEL	CHANNEL FREQUENCY	99% OCCUPIED BANDWIDTH	6dB BANDWIDTH	PASS/FAIL
144	5720	17.82	17.60	PASS
149	5745	17.76	17.59	PASS
157	5785	17.70	17.57	PASS
165	5825	17.64	17.58	PASS



802.11n (40MHz)

CHANNEL	CHANNEL FREQUENCY (MHz)	99% OCCUPIED BANDWIDTH	26dB BANDWIDTH (MHz)	PASS/FAIL
38	5190	36.10	41.25	PASS
46	5230	36.20	41.18	PASS
54	5270	36.10	41.23	PASS
62	5310	36.20	41.21	PASS
102	5510	36.20	41.10	PASS
110	5550	36.10	41.56	PASS
134	5670	36.20	41.31	PASS
142	5710	36.30	41.64	PASS
CHANNEL	CHANNEL FREQUENCY	99% OCCUPIED BANDWIDTH	6dB BANDWIDTH	PASS/FAIL
142	5710	36.30	36.32	PASS
151	5755	36.40	35.87	PASS
159	5795	36.30	36.04	PASS



802.11ac (20MHz)

CHANNEL	CHANNEL FREQUENCY (MHz)	99% OCCUPIED BANDWIDTH	26dB BANDWIDTH (MHz)	PASS/FAIL
36	5180	17.70	20.55	PASS
40	5200	17.70	21.23	PASS
48	5240	17.88	24.49	PASS
52	5260	17.76	26.01	PASS
60	5300	17.88	24.46	PASS
64	5320	17.82	26.72	PASS
100	5500	17.70	24.01	PASS
116	5580	17.76	21.68	PASS
140	5700	17.64	20.36	PASS
144	5720	17.64	20.40	PASS
CHANNEL	CHANNEL FREQUENCY	99% OCCUPIED BANDWIDTH	6dB BANDWIDTH	PASS/FAIL
144	5720	17.64	17.58	PASS
149	5745	17.64	17.58	PASS
157	5785	17.64	17.58	PASS
165	5825	17.64	17.57	PASS



802.11ac (40MHz)

CHANNEL	CHANNEL FREQUENCY (MHz)	99% OCCUPIED BANDWIDTH	26dB BANDWIDTH (MHz)	PASS/FAIL
38	5190	36.30	41.53	PASS
46	5230	36.20	54.27	PASS
54	5270	36.40	43.08	PASS
62	5310	36.30	53.62	PASS
102	5510	36.10	41.64	PASS
110	5550	36.10	41.48	PASS
134	5670	36.30	41.36	PASS
142	5710	36.10	41.51	PASS
CHANNEL	CHANNEL FREQUENCY	99% OCCUPIED BANDWIDTH	6dB BANDWIDTH	PASS/FAIL
142	5710	36.10	36.31	PASS
151	5755	36.30	36.10	PASS
159	5795	36.20	36.04	PASS

802.11ac (80MHz)

CHANNEL	CHANNEL FREQUENCY (MHz)	99% OCCUPIED BANDWIDTH	26dB BANDWIDTH (MHz)	PASS/FAIL
42	5210	75.12	81.18	PASS
58	5290	75.24	80.63	PASS
106	5530	75.12	80.51	PASS
122	5610	75.24	81.22	PASS
138	5690	75.24	80.76	PASS
CHANNEL	CHANNEL FREQUENCY	99% OCCUPIED BANDWIDTH	6dB BANDWIDTH	PASS/FAIL
138	5690	75.24	76.14	PASS
155	5775	75.24	76.34	PASS





For U-NII-1:

SPECTRUM PLOT OF WORST VALUE of 99% OCCUPIED BANDWIDTH

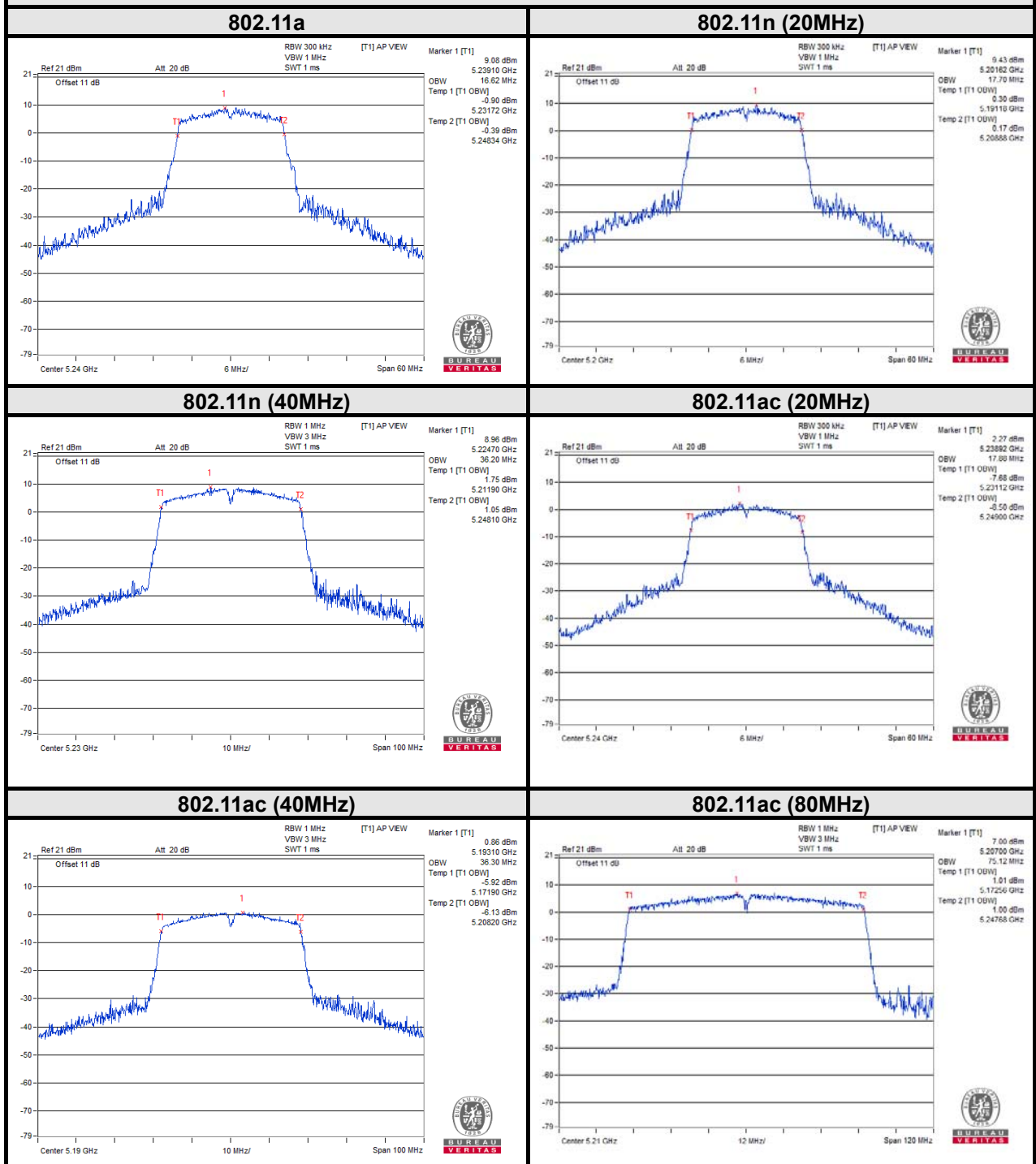



BUREAU VERITAS

Test Report No.: RF210603W002-6

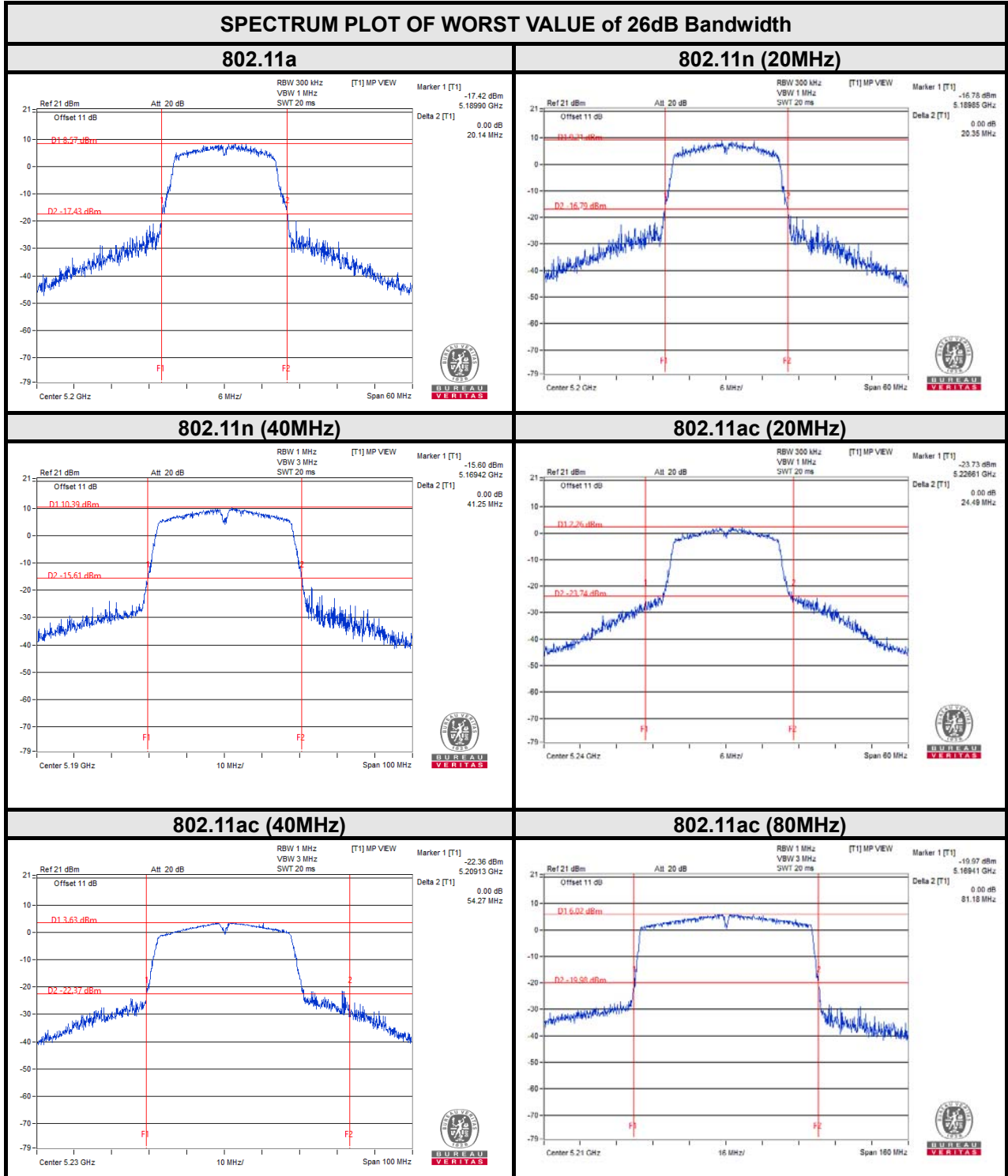



BUREAU VERITAS

Test Report No.: RF210603W002-6

For U-NII-2A:

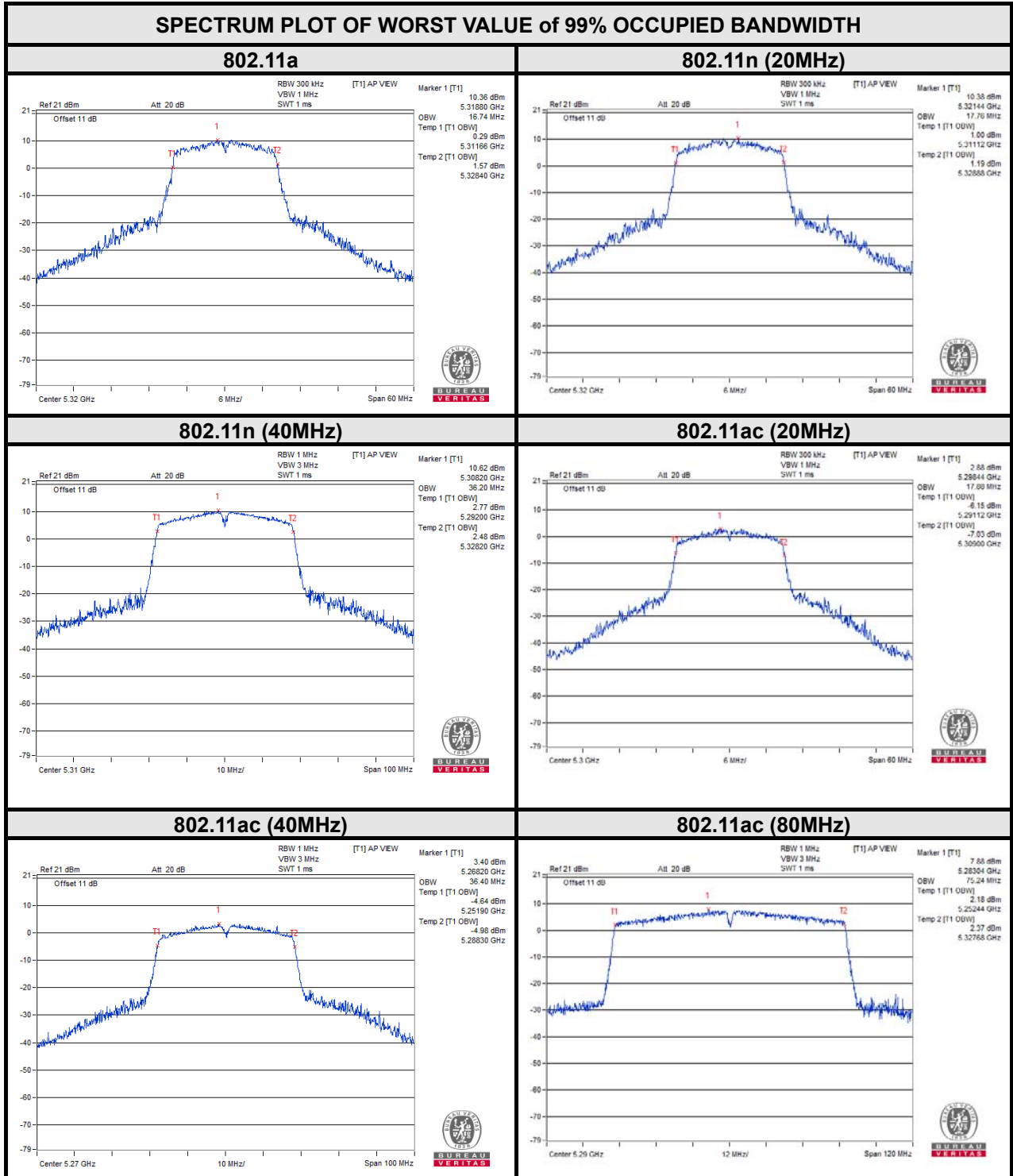



BUREAU VERITAS

Test Report No.: RF210603W002-6

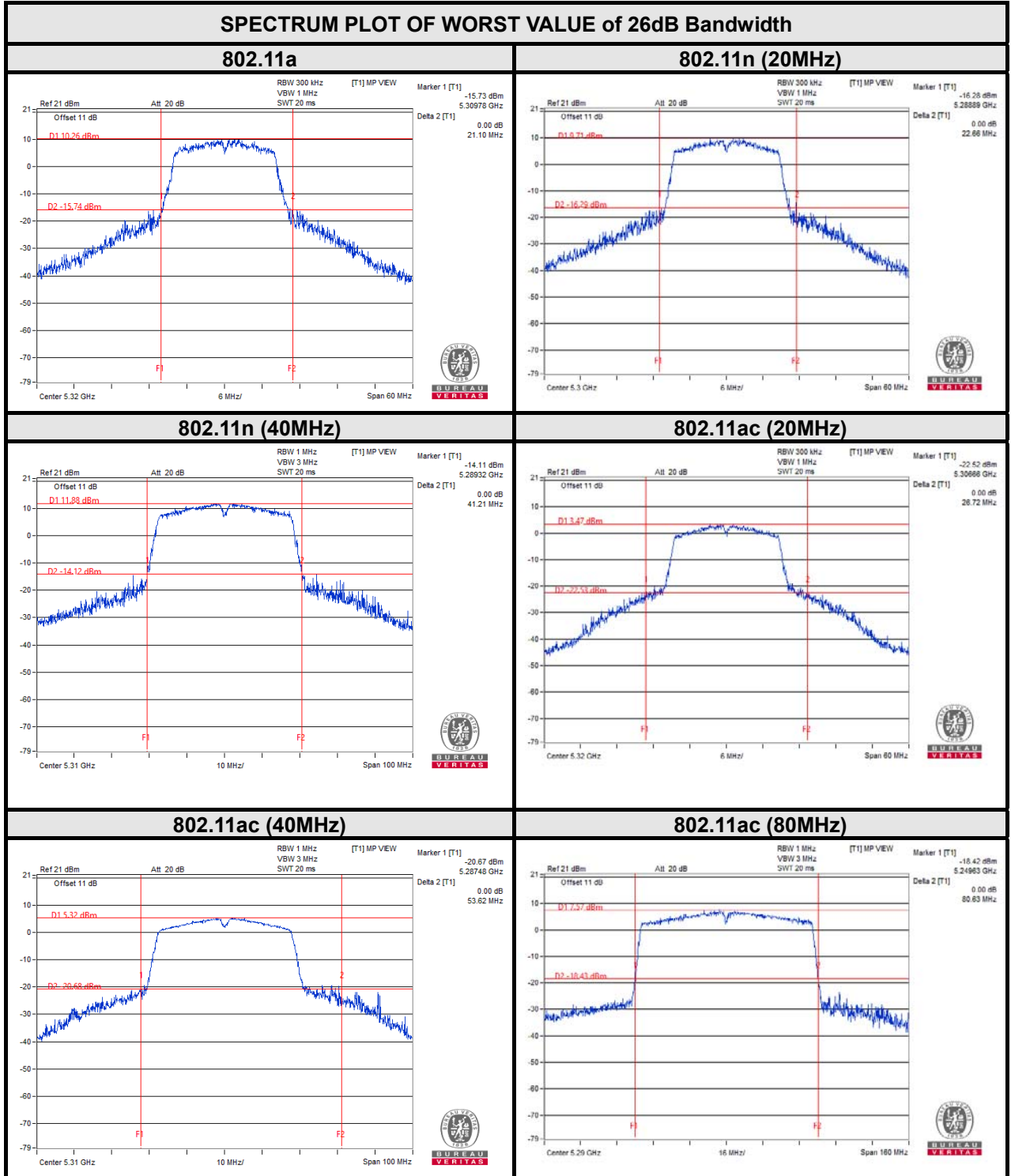



For U-NII-2C:

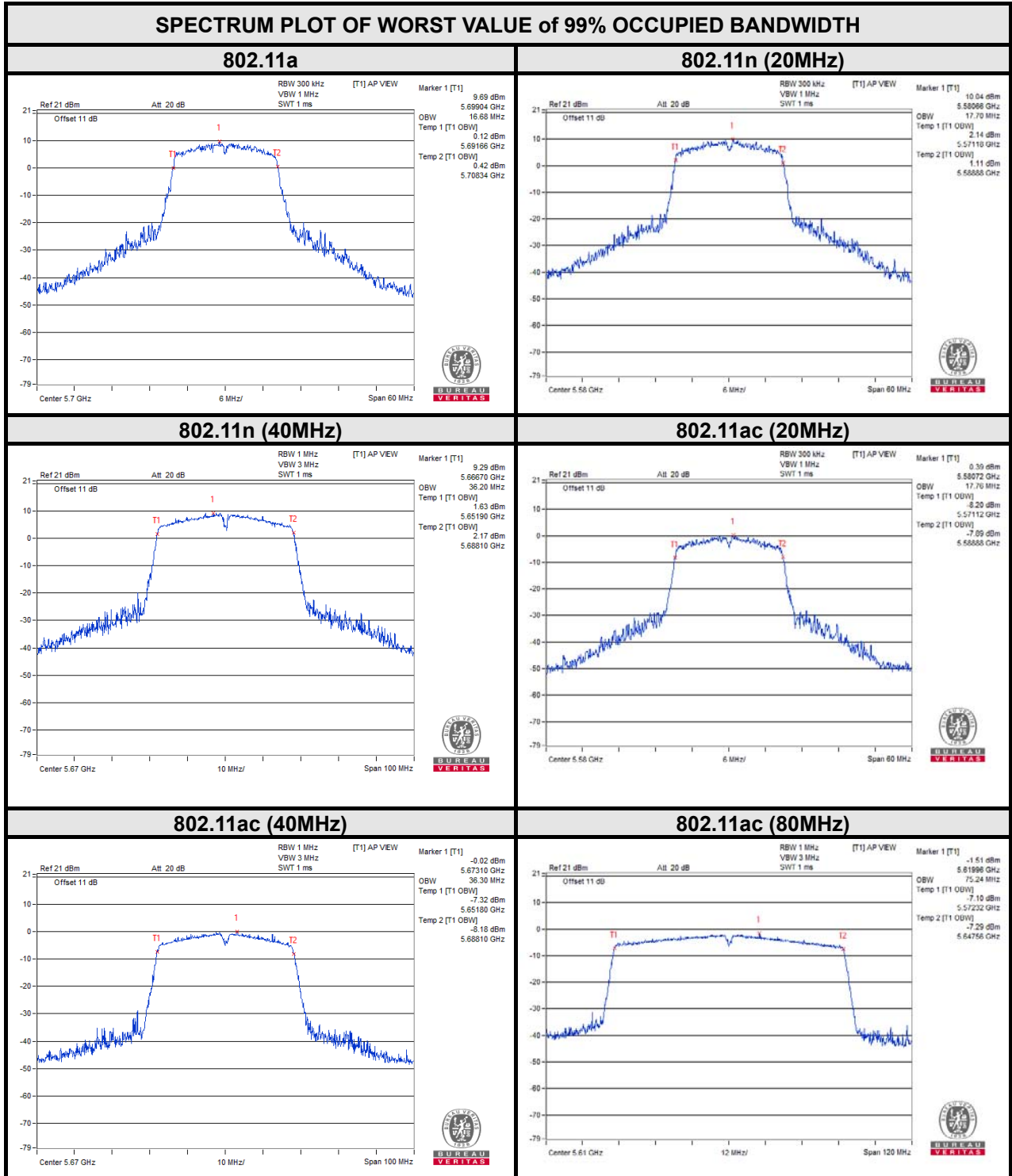



BUREAU VERITAS

Test Report No.: RF210603W002-6

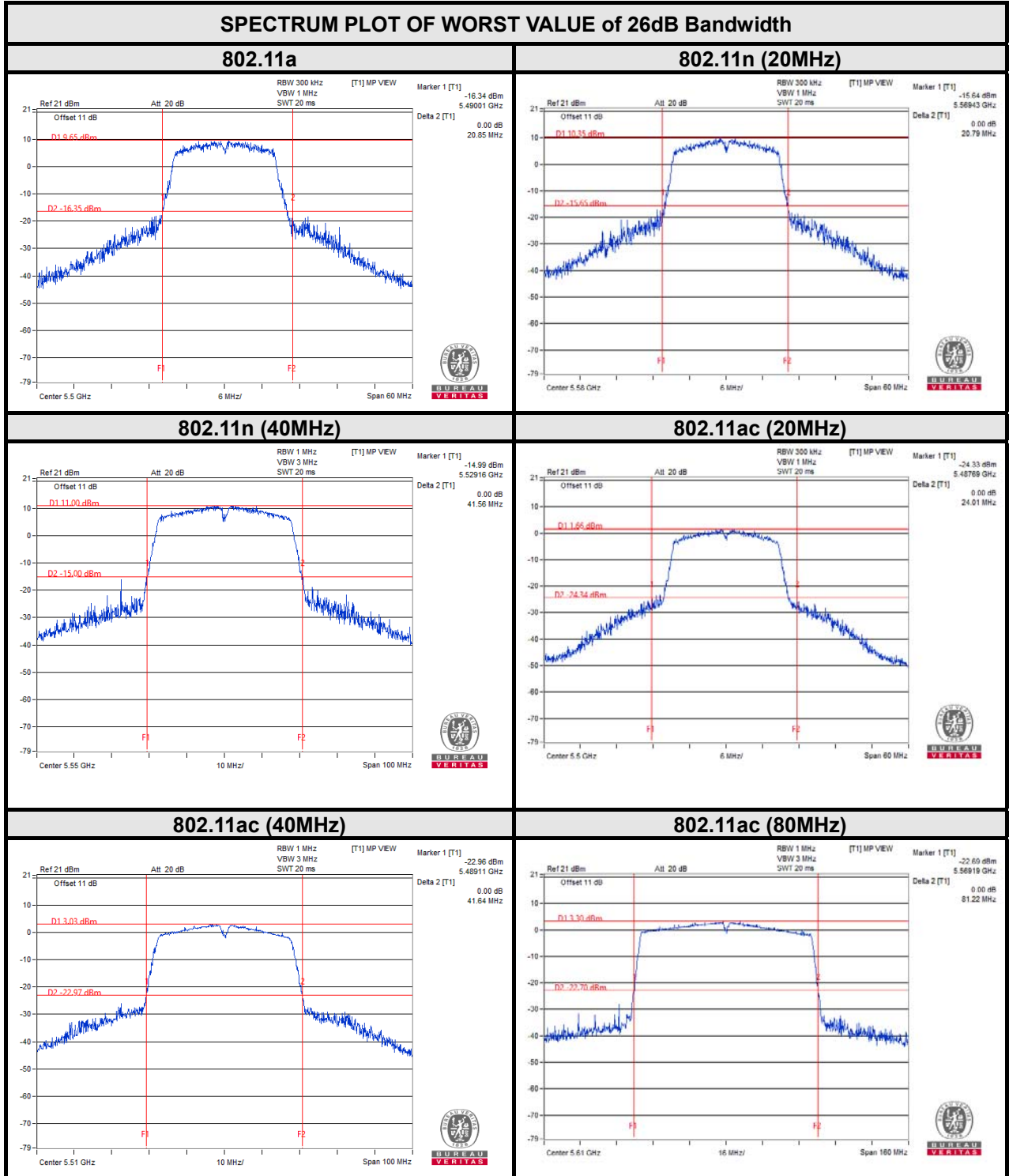



BUREAU VERITAS

Test Report No.: RF210603W002-6

For U-NII-3:

### SPECTRUM PLOT OF WORST VALUE of 99% OCCUPIED BANDWIDTH

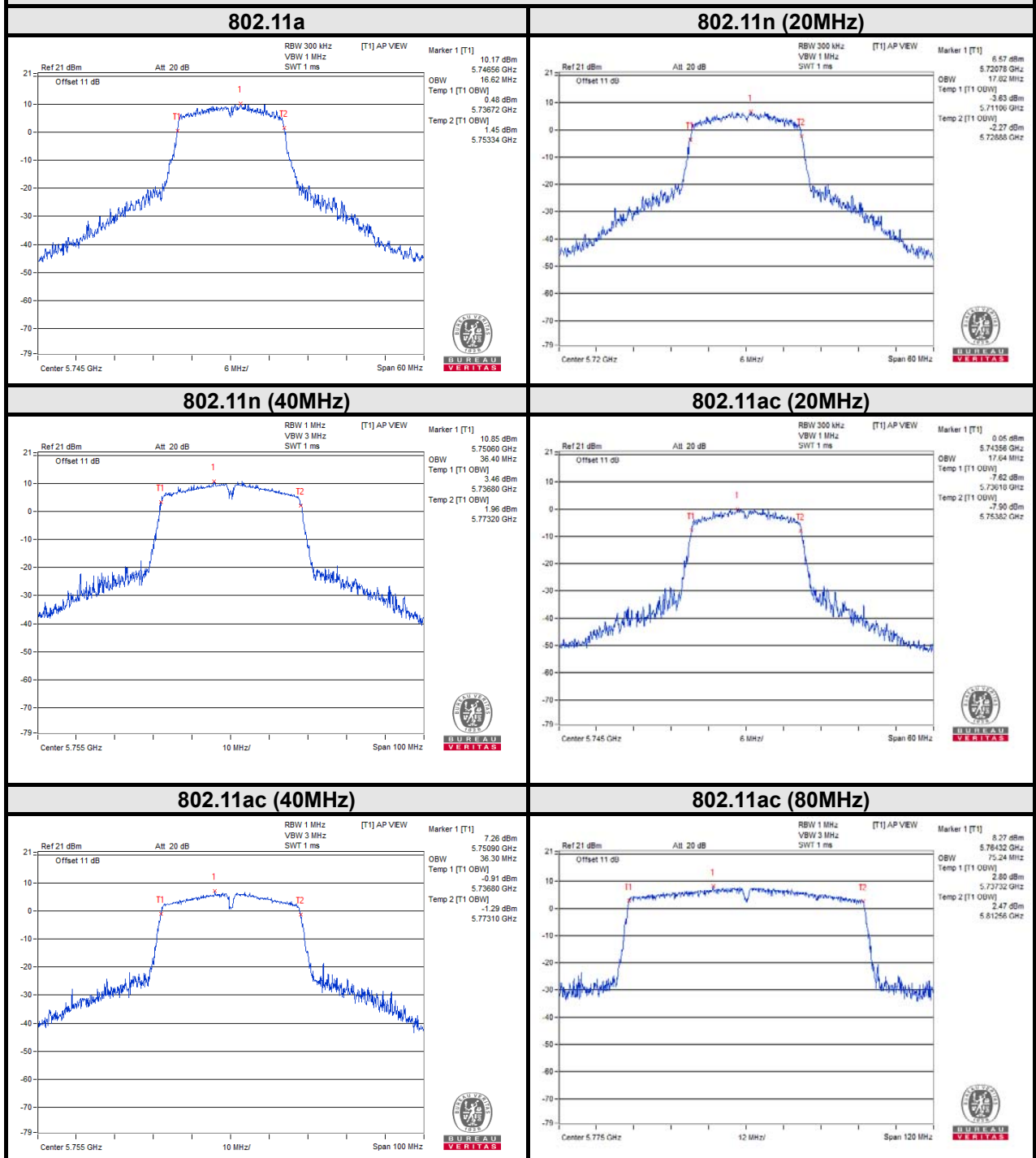

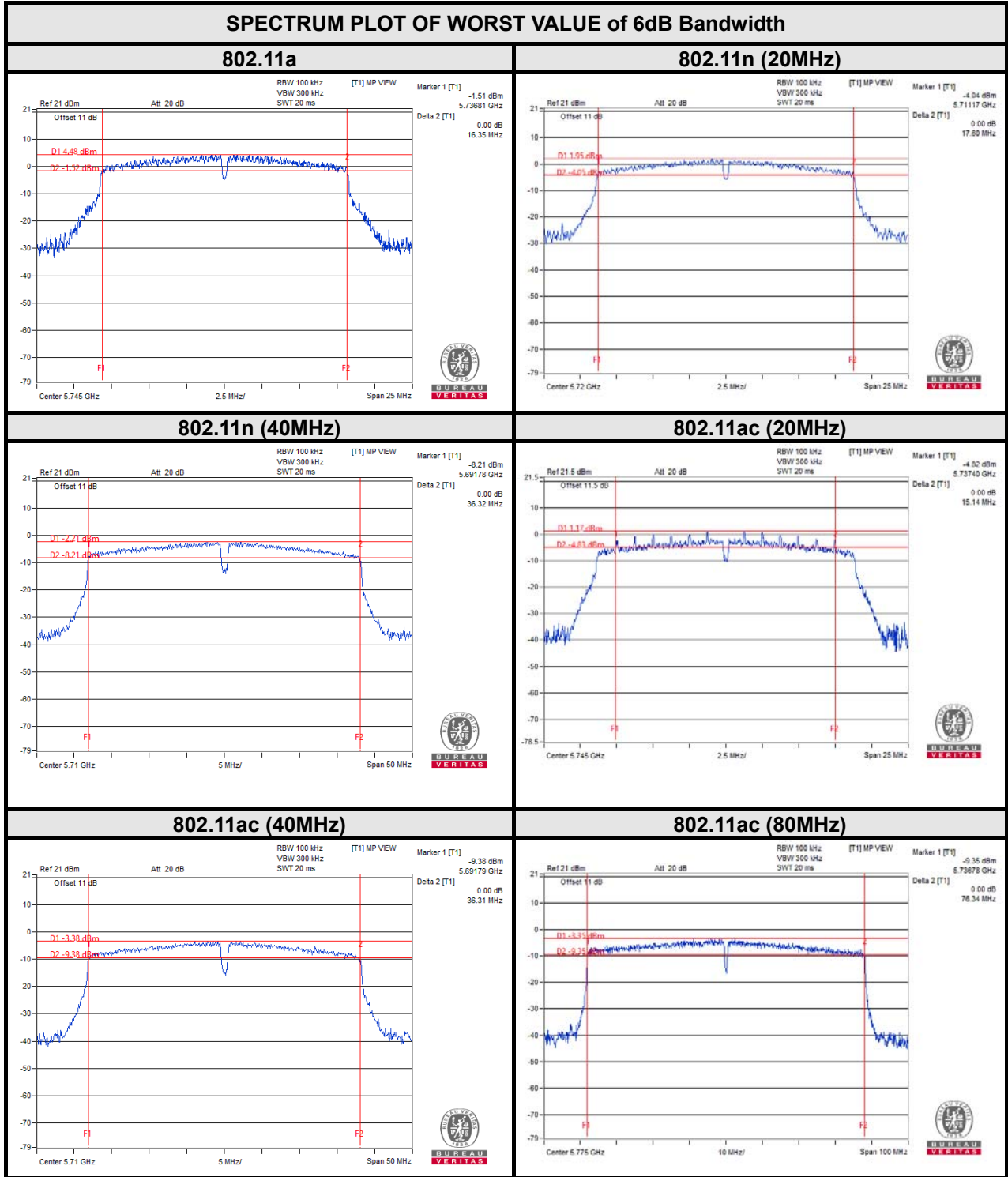





### 3.5 MAXIMUM POWER SPECTRAL DENSITY MEASUREMENT

#### 3.5.1 LIMITS OF MAXIMUM POWER SPECTRAL DENSITY MEASUREMENT

Operation Band	EUT Category		LIMIT
U-NII-1		Outdoor Access Point	17dBm/ MHz
		Fixed point-to-point Access Point	
		Indoor Access Point	
	√	Client devices	11dBm/ MHz
U-NII-2A	√		11dBm/ MHz
U-NII-2C	√		11dBm/ MHz
U-NII-3	√		30dBm/ 500kHz

#### 3.5.2 TEST SETUP

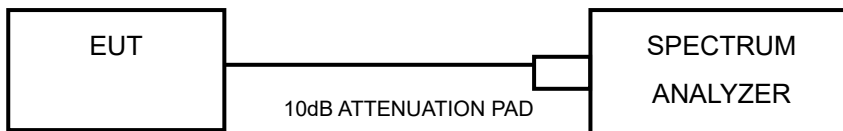

#### 3.5.3 TEST INSTRUMENTS

Refer to section 3.3.3 to get information of above instrument.



### 3.5.4 TEST PROCEDURES

Using method SA-2

- 1) Set span to encompass the entire emission bandwidth (EBW) of the signal.
- 2) Set RBW = 1 MHz, Set VBW  $\geq$  3 MHz, Detector = RMS
- 3) Set Channel power measure = 1MHz
- 4) Sweep time = auto, trigger set to "free run".
- 5) Trace average at least 100 traces in power averaging mode.
- 6) Add  $10 \log(1/x)$ , where x is the duty cycle, to the measured power in order to compute the average power during the actual transmission times (because the measurement represents an average over both the on and off times of the transmission).
- 7) Record the max value

### 3.5.5 DEVIATION FROM TEST STANDARD

No deviation.

### 3.5.6 EUT OPERATING CONDITIONS

Same as 3.1.6.



### 3.5.7 TEST RESULTS

For U-NII-1 & U-NII-2A& U-NII-2C:  
802.11a

CHANNEL	FREQUENCY (MHz)	PSD w/o Duty Factor (dBm/MHz)	Duty Factor	PSD with Duty Factor (dBm/MHz)	MAXIMUM LIMIT (dBm/MHz)	PASS/FAIL
36	5180	5.71	0.00	5.71	11	PASS
40	5200	5.91	0.00	5.91	11	PASS
48	5240	6.29	0.00	6.29	11	PASS
52	5260	6.79	0.00	6.79	11	PASS
60	5300	7.07	0.00	7.07	11	PASS
64	5320	7.40	0.00	7.40	11	PASS
100	5500	6.93	0.00	6.93	11	PASS
116	5580	6.64	0.00	6.64	11	PASS
140	5700	6.28	0.00	6.28	11	PASS
144	5720	3.47	0.00	3.47	11	PASS

802.11n (20MHz)

CHANNEL	FREQUENCY (MHz)	PSD w/o Duty Factor (dBm/MHz)	Duty Factor	PSD with Duty Factor (dBm/MHz)	MAXIMUM LIMIT (dBm/MHz)	PASS/FAIL
36	5180	5.31	0.00	5.31	11	PASS
40	5200	5.83	0.00	5.83	11	PASS
48	5240	5.99	0.00	5.99	11	PASS
52	5260	6.29	0.00	6.29	11	PASS
60	5300	7.22	0.00	7.22	11	PASS
64	5320	7.19	0.00	7.19	11	PASS
100	5500	6.08	0.00	6.08	11	PASS
116	5580	6.86	0.00	6.86	11	PASS
140	5700	6.02	0.00	6.02	11	PASS
144	5720	3.61	0.00	3.61	11	PASS



**802.11n (40MHz)**

CHANNEL	FREQUENCY (MHz)	PSD w/o Duty Factor (dBm/MHz)	Duty Factor	PSD with Duty Factor (dBm/MHz)	MAXIMUM LIMIT (dBm/MHz)	PASS/FAIL
38	5190	1.45	0.00	1.45	11	PASS
46	5230	1.88	0.00	1.88	11	PASS
54	5270	2.87	0.00	2.87	11	PASS
62	5310	3.43	0.00	3.43	11	PASS
102	5510	2.24	0.00	2.24	11	PASS
110	5550	2.22	0.00	2.22	11	PASS
134	5670	1.77	0.00	1.77	11	PASS
142	5710	-0.51	0.00	-0.51	11	PASS

**802.11 ac (20MHz)**

CHANNEL	FREQUENCY (MHz)	PSD w/o Duty Factor (dBm/MHz)	Duty Factor	PSD with Duty Factor (dBm/MHz)	MAXIMUM LIMIT (dBm/MHz)	PASS/FAIL
36	5180	-3.11	0.00	-3.11	11	PASS
40	5200	-1.91	0.00	-1.91	11	PASS
48	5240	-1.18	0.00	-1.18	11	PASS
52	5260	-0.60	0.00	-0.60	11	PASS
60	5300	-0.11	0.00	-0.11	11	PASS
64	5320	0.07	0.00	0.07	11	PASS
100	5500	-1.62	0.00	-1.62	11	PASS
116	5580	-2.78	0.00	-2.78	11	PASS
140	5700	-2.96	0.00	-2.96	11	PASS
144	5720	-3.17	0.00	-3.17	11	PASS



802.11ac (40MHz)

CHANNEL	FREQUENCY (MHz)	PSD w/o Duty Factor (dBm/MHz)	Duty Factor	PSD with Duty Factor (dBm/MHz)	MAXIMUM LIMIT (dBm/MHz)	PASS/FAIL
38	5190	-6.16	0.00	-6.16	11	PASS
46	5230	-5.51	0.00	-5.51	11	PASS
54	5270	-4.16	0.00	-4.16	11	PASS
62	5310	-3.68	0.00	-3.68	11	PASS
102	5510	-6.04	0.00	-6.04	11	PASS
110	5550	-6.95	0.00	-6.95	11	PASS
134	5670	-7.45	0.00	-7.45	11	PASS
142	5710	-6.46	0.00	-6.46	11	PASS

802.11ac (80MHz)

CHANNEL	FREQUENCY (MHz)	PSD w/o Duty Factor (dBm/MHz)	Duty Factor	PSD with Duty Factor (dBm/MHz)	MAXIMUM LIMIT (dBm/MHz)	PASS/FAIL
42	5210	-2.35	0.00	-2.35	11	PASS
58	5290	-1.58	0.00	-1.58	11	PASS
106	5530	-1.71	0.00	-1.71	11	PASS
122	5610	-6.00	0.00	-6.00	11	PASS
138	5690	-5.04	0.00	-5.04	11	PASS



**For U-NII-3:**

Note:  $\text{dBm}/500\text{kHz} = \text{dBm}/300\text{kHz} + 10 \cdot \log(0.5/0.3) = \text{dBm}/300\text{kHz} + 2.22$

**802.11a**

CHANNEL	FREQUENCY (MHz)	PSD w/o Duty Factor (dBm/300kHz)	PSD w/o Duty Factor (dBm/500kHz)	Duty Factor	PSD with Duty Factor (dBm/500kHz)	LIMIT (dBm/500kHz)	PASS /FAIL
144	5720	-2.31	-0.09	0.00	-0.09	30	PASS
149	5745	1.26	3.48	0.00	3.48	30	PASS
157	5785	0.89	3.11	0.00	3.11	30	PASS
165	5825	1.05	3.27	0.00	3.27	30	PASS

**802.11n (20MHz)**

CHANNEL	FREQUENCY (MHz)	PSD w/o Duty Factor (dBm/300kHz)	PSD w/o Duty Factor (dBm/500kHz)	Duty Factor	PSD with Duty Factor (dBm/500kHz)	LIMIT (dBm/500kHz)	PASS /FAIL
144	5720	-2.20	0.02	0.00	0.02	30	PASS
149	5745	1.01	3.23	0.00	3.23	30	PASS
157	5785	0.93	3.15	0.00	3.15	30	PASS
165	5825	0.81	3.03	0.00	3.03	30	PASS

**802.11n (40MHz)**

CHANNEL	FREQUENCY (MHz)	PSD w/o Duty Factor (dBm/300kHz)	PSD w/o Duty Factor (dBm/500kHz)	Duty Factor	PSD with Duty Factor (dBm/500kHz)	LIMIT (dBm/500kHz)	PASS /FAIL
142	5710	-6.42	-4.20	0.00	-4.20	30	PASS
151	5755	-2.68	-0.46	0.00	-0.46	30	PASS
159	5795	-3.21	-0.99	0.00	-0.99	30	PASS



**802.11ac (20MHz)**

CHANNEL	FREQUENCY (MHz)	PSD w/o Duty Factor (dBm/300kHz)	PSD w/o Duty Factor (dBm/500kHz)	Duty Factor	PSD with Duty Factor (dBm/500kHz)	LIMIT (dBm/500kHz)	PASS /FAIL
144	5720	-4.14	-1.92	0.00	-1.92	30	PASS
149	5745	-8.60	-6.38	0.00	-6.38	30	PASS
157	5785	-8.50	-6.28	0.00	-6.28	30	PASS
165	5825	-8.57	-6.35	0.00	-6.35	30	PASS

**802.11ac (40MHz)**

CHANNEL	FREQUENCY (MHz)	PSD w/o Duty Factor (dBm/300kHz)	PSD w/o Duty Factor (dBm/500kHz)	Duty Factor	PSD with Duty Factor (dBm/500kHz)	LIMIT (dBm/500kHz)	PASS /FAIL
142	5710	-7.69	-5.47	0.00	-5.47	30	PASS
151	5755	-12.41	-10.19	0.00	-10.19	30	PASS
159	5795	-13.11	-10.89	0.00	-10.89	30	PASS

**802.11ac (80MHz)**

CHANNEL	FREQUENCY (MHz)	PSD w/o Duty Factor (dBm/300kHz)	PSD w/o Duty Factor (dBm/500kHz)	Duty Factor	PSD with Duty Factor (dBm/500kHz)	LIMIT (dBm/500kHz)	PASS /FAIL
138	5690	-10.80	-8.58	0.00	-8.58	30	PASS
155	5775	-7.13	-4.91	0.00	-4.91	30	PASS



BUREAU VERITAS

Test Report No.: RF210603W002-6

For 5180~5240MHz

PSD w/o Duty Factor

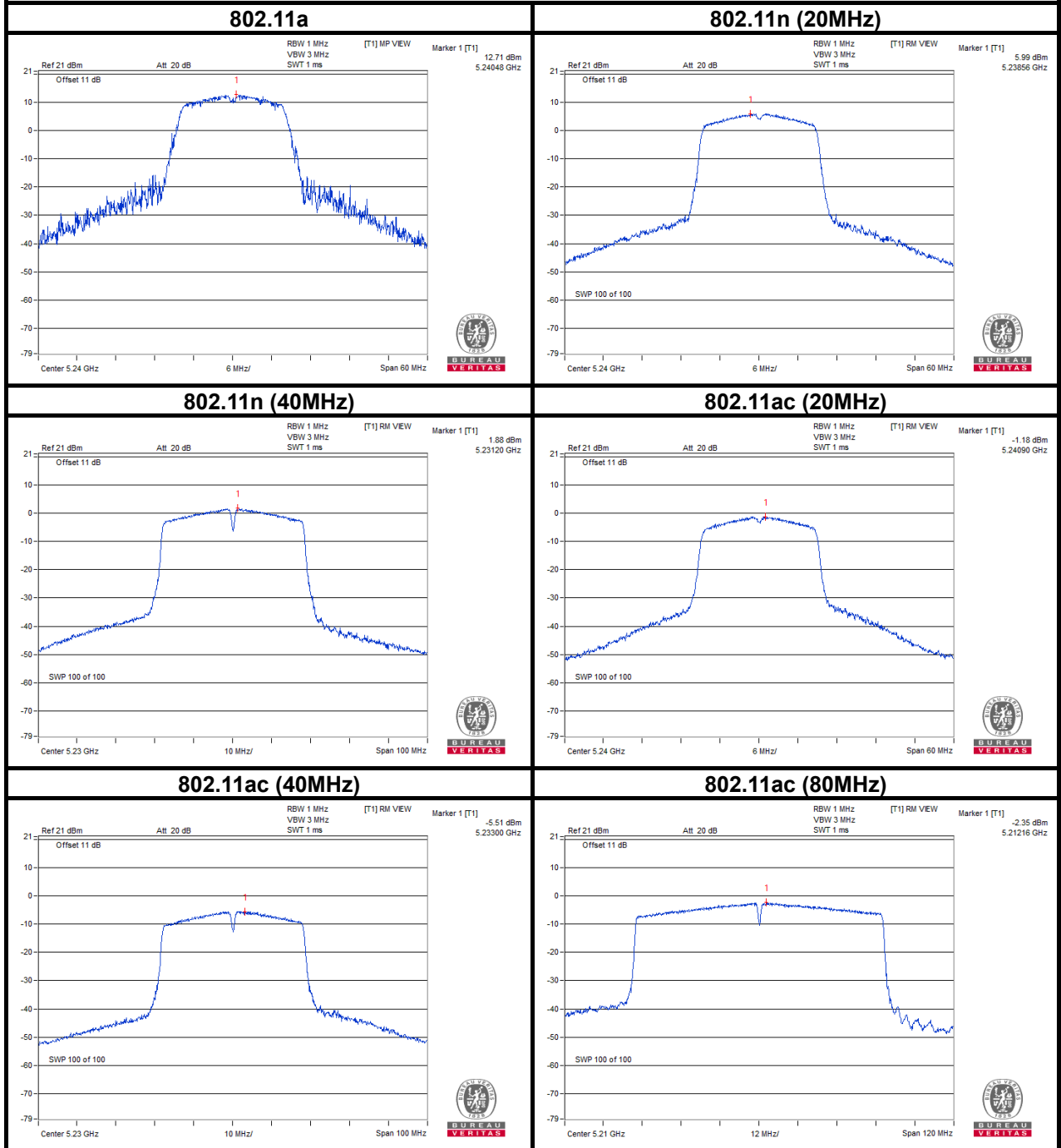





BUREAU VERITAS

Test Report No.: RF210603W002-6

For 5260~5320MHz

PSD w/o Duty Factor

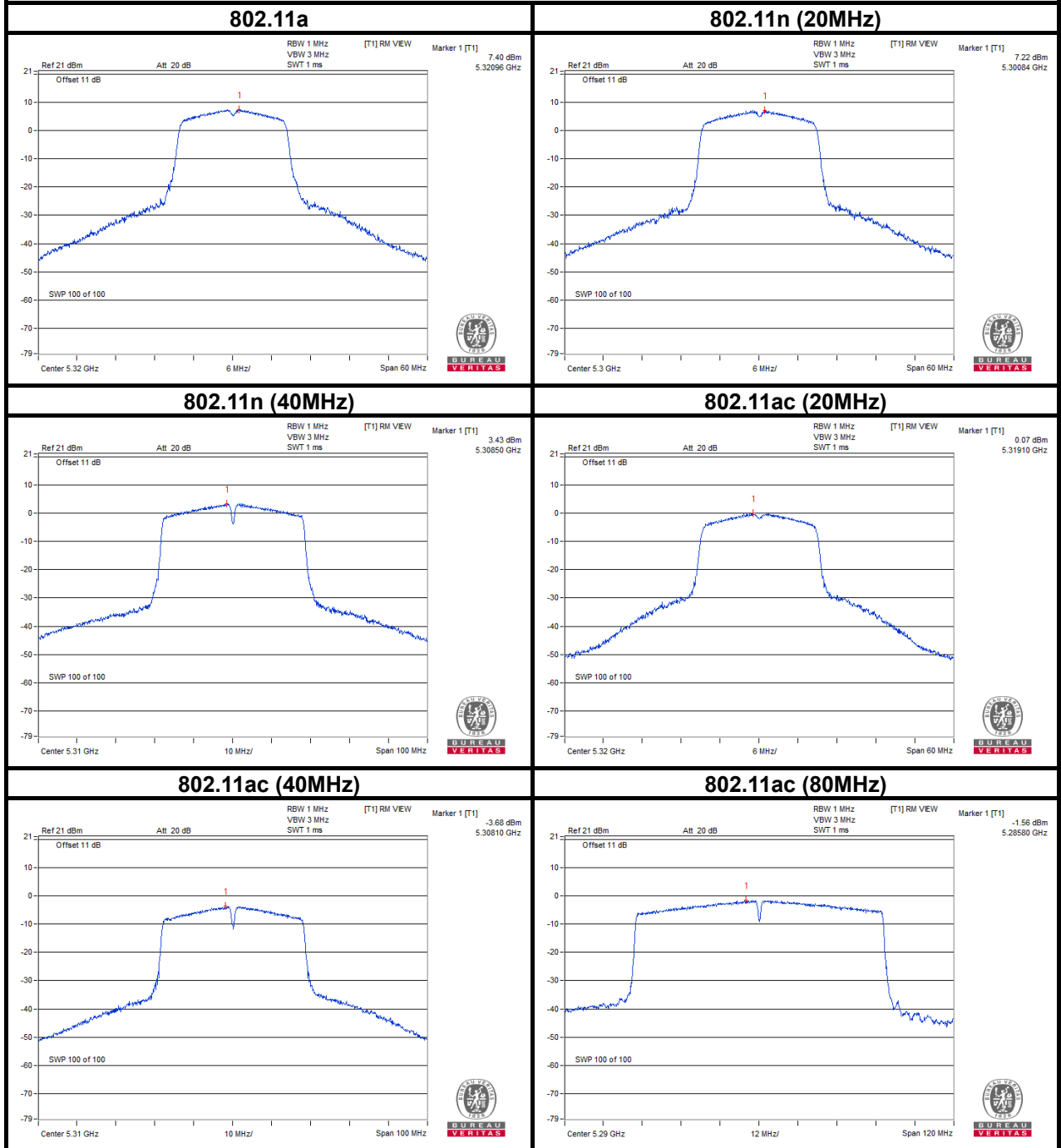



BUREAU VERITAS

Test Report No.: RF210603W002-6

For 5500~5700MHz

PSD w/o Duty Factor

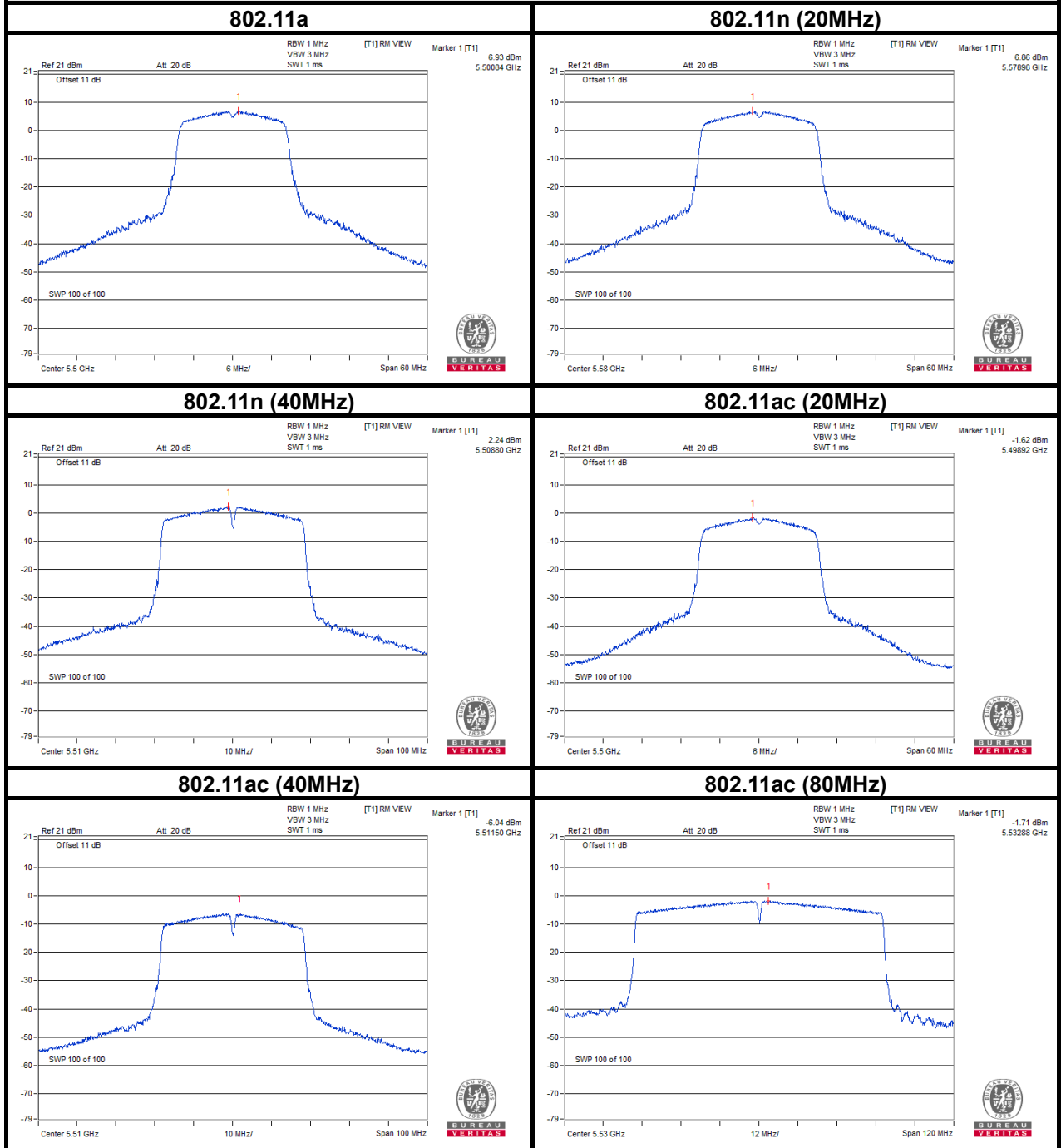



BUREAU VERITAS

Test Report No.: RF210603W002-6

For 5745~5825MHz

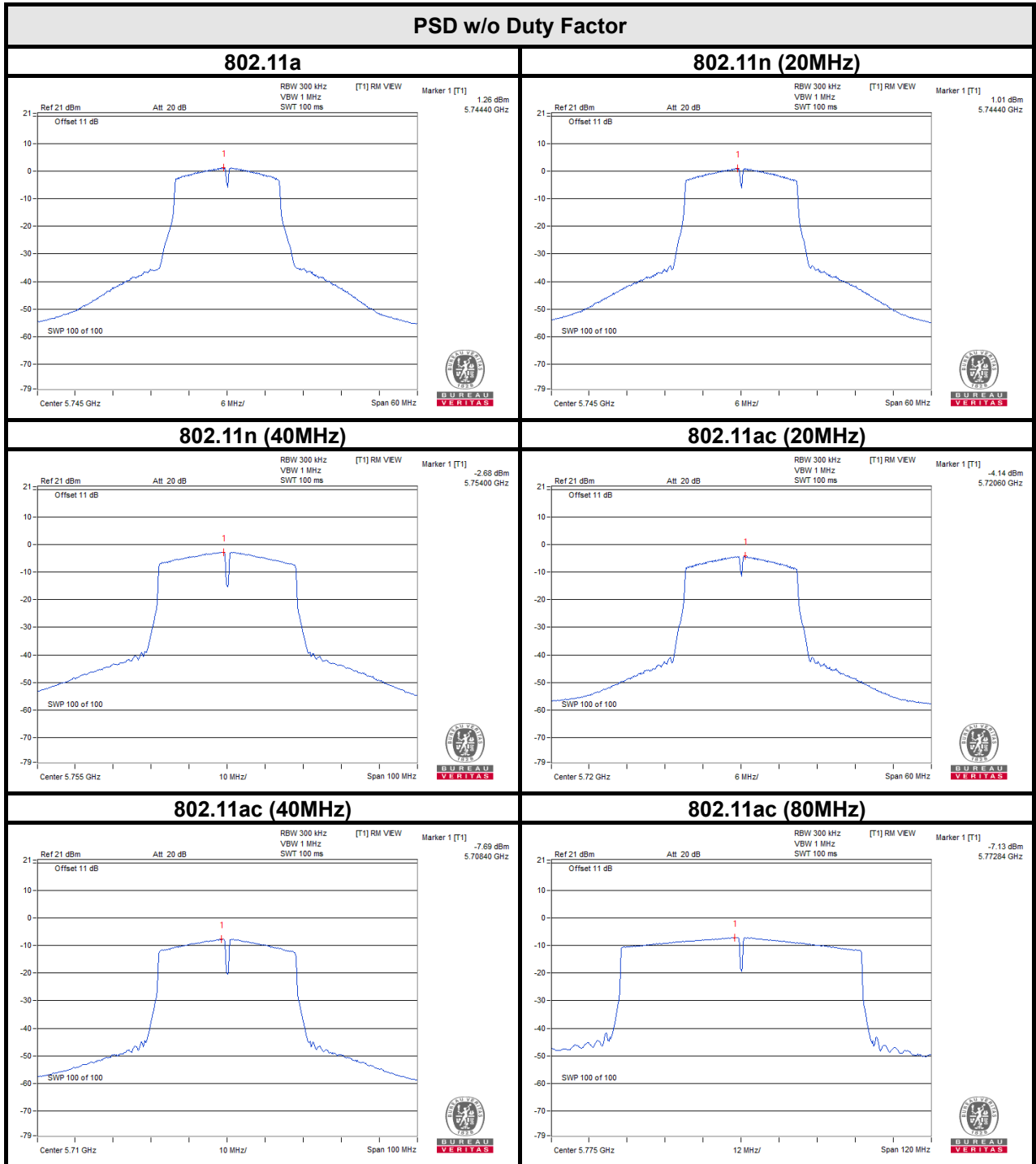



Test Report No.: RF210603W002-6

## 4 PHOTOGRAPHS OF THE TEST CONFIGURATION

Please refer to the attached file (Test Setup Photo).



## 5 APPENDIX A – MODIFICATIONS RECORDERS FOR ENGINEERING CHANGES TO THE EUT BY THE LAB

No modifications were made to the EUT by the lab during the test.

---END---