

# FCC SAR Test Report

Report No. : SA210225W002

Applicant : Lenovo(Shanghai) Electronics Technology Co., Ltd.

Address : Section 304-305, Building No. 4, # 222, Meiyue Road, China (Shanghai) Pilot Free Trade Zone

Product : Portable Tablet Computer

FCC ID : O57TBX6C6F

Brand : Lenovo

Model No. : Lenovo TB-X6C6F

Standards : FCC 47 CFR Part 2 (2.1093) / IEEE C95.1:1992 / IEEE 1528:2013  
KDB 865664 D01 v01r04 / KDB 865664 D02 v01r02  
KDB 248227 D01 v02r02 / KDB 447498 D01 v06  
KDB 616217 D04 v01r02

Sample Received Date : Feb. 25, 2021

Date of Testing : Mar. 08, 2021 ~ Mar. 16, 2021

**CERTIFICATION:** The above equipment have been tested by **BV 7LAYERS COMMUNICATIONS TECHNOLOGY (SHENZHEN) CO. LTD.**, and found compliance with the requirement of the above standards. The test record, data evaluation & Equipment Under Test (EUT) configurations represented herein are true and accurate accounts of the measurements of the sample’s SAR characteristics under the conditions specified in this report. It should not be reproduced except in full, without the written approval of our laboratory. The client should not use it to claim product certification, approval, or endorsement by A2LA or any government agencies.

Prepared By : Jerry Chen  
Jerry Chen / Engineer



Approved By : Luke Lu  
Luke Lu / Manager

This report is governed by, and incorporates by reference, CPS Conditions of Service as posted at the date of issuance of this report at <http://www.bureauveritas.com/home/about-us/our-business/cps/about-us/terms-conditions> and is intended for your exclusive use. Any copying or replication of this report to or for any other person or entity, or use of our name or trademark, is permitted only with our prior written permission. This report sets forth our findings solely with respect to the test samples identified herein. The results set forth in this report are not indicative or representative of the quality or characteristics of the lot from which a test sample was taken or any similar or identical product unless specifically and expressly noted. Our report includes all of the tests requested by you and the results thereof based upon the information that you provided to us. Measurement uncertainty is only provided upon request for accredited tests. You have 60 days from date of issuance of this report to notify us of any material error or omission caused by our negligence or if you require measurement uncertainty; provided, however, that such notice shall be in writing and shall specifically address the issue you wish to raise. A failure to raise such issue within the prescribed time shall constitute your unqualified acceptance of the completeness of this report, the tests conducted and the correctness of the report contents.

## Table of Contents

Release Control Record .....	3
1. Summary of Maximum SAR Value .....	4
2. Description of Equipment Under Test .....	5
3. SAR Measurement System .....	6
3.1 Definition of Specific Absorption Rate (SAR) .....	6
3.2 SPEAG DASY System .....	6
3.2.1 Robot.....	7
3.2.2 Probes.....	8
3.2.3 Data Acquisition Electronics (DAE) .....	8
3.2.4 Phantoms .....	9
3.2.5 Device Holder.....	10
3.2.6 System Validation Dipoles.....	10
3.2.7 Tissue Simulating Liquids.....	11
3.3 SAR System Verification .....	14
3.4 SAR Measurement Procedure .....	15
3.4.1 Area & Zoom Scan Procedure .....	15
3.4.2 Volume Scan Procedure.....	15
3.4.3 Power Drift Monitoring.....	16
3.4.4 Spatial Peak SAR Evaluation .....	16
3.4.5 SAR Averaged Methods .....	16
4. SAR Measurement Evaluation .....	17
4.1 EUT Configuration and Setting.....	17
4.2 EUT Testing Position .....	21
4.2.1 Body Exposure Conditions .....	21
4.2.2 SAR Test Exclusion Evaluations .....	22
4.2.3 Simultaneous Transmission Possibilities.....	23
4.3 Tissue Verification .....	23
4.4 System Verification.....	23
4.5 Maximum Output Power.....	24
4.5.1 Maximum Conducted Power .....	24
4.5.2 Measured Conducted Power Result.....	29
4.6 SAR Testing Results .....	34
4.6.1 SAR Test Reduction Considerations .....	34
4.6.2 SAR Results for Body Exposure Condition (Separation Distance is 0 cm Gap) .....	35
4.6.3 SAR Measurement Variability.....	36
4.6.4 Simultaneous Multi-band Transmission Evaluation .....	37
5. Calibration of Test Equipment.....	38
6. Measurement Uncertainty .....	39
7. Information on the Testing Laboratories.....	41
Appendix A. SAR Plots of System Verification	
Appendix B. SAR Plots of SAR Measurement	
Appendix C. Calibration Certificate for Probe and Dipole	
Appendix D. Photographs of EUT and Setup	



## Release Control Record

Report No.	Reason for Change	Date Issued
SA210225W002	Initial release	Apr. 11, 2021

## 1. Summary of Maximum SAR Value

Equipment Class	Mode	Highest Reported Body SAR <sub>1g</sub> (W/kg)
DTS	2.4G WLAN	1.10
NII	5.2G WLAN	N/A
	5.3G WLAN	1.19
	5.6G WLAN	1.13
	5.8G WLAN	1.19
DSS	Bluetooth	0.43
Highest Simultaneous Transmission SAR		1.38

**Note:**

- The SAR limit (**Head & Body: SAR<sub>1g</sub> 1.6 W/kg, Extremity: SAR<sub>10g</sub> 4.0 W/kg**) for general population / uncontrolled exposure is specified in FCC 47 CFR part 2 (2.1093) and ANSI/IEEE C95.1-1992.

## 2. Description of Equipment Under Test

<b>EUT Type</b>	Portable Tablet Computer
<b>FCC ID</b>	O57TBX6C6F
<b>Brand Name</b>	Lenovo
<b>Model Name</b>	Lenovo TB-X6C6F
<b>HW Version</b>	Lenovo TB-X6C6F
<b>SW Version</b>	TB-X6C6F_RF01_210403
<b>Tx Frequency Bands (Unit: MHz)</b>	WLAN : 2412 ~ 2462, 5180 ~ 5240, 5260 ~ 5320, 5500 ~ 5720, 5745 ~ 5825 Bluetooth : 2402 ~ 2480
<b>Uplink Modulations</b>	802.11b : DSSS 802.11a/g/n/ac : OFDM Bluetooth : GFSK, $\pi/4$ -DQPSK, 8-DPSK
<b>Maximum Tune-up Conducted Power (Unit: dBm)</b>	Please refer to section 4.5.1 of this report.
<b>Antenna Type</b>	WLAN / BT: PIFA Antenna
<b>EUT Stage</b>	Identical Prototype

**Note:**

1. The above EUT information is declared by manufacturer and for more detailed features description please refers to the manufacturer's specifications or User's Manual.
2. According to the product equivalence statement provided by the manufacturer Sample 1/2/3/4 are testing in this report

SAMPLE	EUT CONFIGURATION INFORMATION
1	LCD Panel 2(400nits)+Photo Camera 2+Photo Camera 4+CPU1+EMMC4+DDR4+speaker 1+speaker 2+motor2+Main Broad 2+BT/WLAN Module+ Battery 2
2	LCD Panel 1(400nits)+Photo Camera 1+Photo Camera 3+CPU1+EMMC1+DDR1+speaker 1+speaker 2+motor1+Main Broad 1+BT/WLAN Module+ Battery 1
3	LCD Panel 3(330nits)+Photo Camera 1+Photo Camera 3+CPU1+EMMC5+DDR5+speaker 1+speaker 2+motor1+Main Broad 1+BT/WLAN Module+ Battery 1
4	LCD Panel 4(330nits)+Photo Camera 2+Photo Camera 4+CPU1+EMMC6+DDR6+speaker 1+speaker 2+motor2+Main Broad 2+BT/WLAN Module+ Battery 2
5	LCD Panel 2(400nits)+Photo Camera 2+Photo Camera 4+CPU1+EMMC2+DDR2+speaker 1+speaker 2+motor2+Main Broad 2+BT/WLAN Module+ Battery 2
6	LCD Panel 1(400nits)+Photo Camera 1+Photo Camera 3+CPU1+EMMC3+DDR3+speaker 1+speaker 2+motor1+Main Broad 1+BT/WLAN Module+ Battery 1

### 3. SAR Measurement System

#### 3.1 Definition of Specific Absorption Rate (SAR)

SAR is related to the rate at which energy is absorbed per unit mass in an object exposed to a radio field. The SAR distribution in a biological body is complicated and is usually carried out by experimental techniques or numerical modeling. The standard recommends limits for two tiers of groups, occupational/controlled and general population/uncontrolled, based on a person’s awareness and ability to exercise control over his or her exposure. In general, occupational/controlled exposure limits are higher than the limits for general population/uncontrolled.

The SAR definition is the time derivative (rate) of the incremental energy (dW) absorbed by (dissipated in) an incremental mass (dm) contained in a volume element (dv) of a given density (ρ). The equation description is as below:

$$SAR = \frac{d}{dt} \left( \frac{dW}{dm} \right) = \frac{d}{dt} \left( \frac{dW}{\rho dv} \right)$$

SAR is expressed in units of Watts per kilogram (W/kg)

SAR measurement can be related to the electrical field in the tissue by

$$SAR = \frac{\sigma |E|^2}{\rho}$$

Where: σ is the conductivity of the tissue, ρ is the mass density of the tissue and E is the RMS electrical field strength.

#### 3.2 SPEAG DASY System

DASY system consists of high precision robot, probe alignment sensor, phantom, robot controller, controlled measurement server and near-field probe. The robot includes six axes that can move to the precision position of the DASY5 software defined. The DASY software can define the area that is detected by the probe. The robot is connected to controlled box. Controlled measurement server is connected to the controlled robot box. The DAE includes amplifier, signal multiplexing, AD converter, offset measurement and surface detection. It is connected to the Electro-optical coupler (ECO). The ECO performs the conversion from the optical into digital electric signal of the DAE and transfers data to the PC.

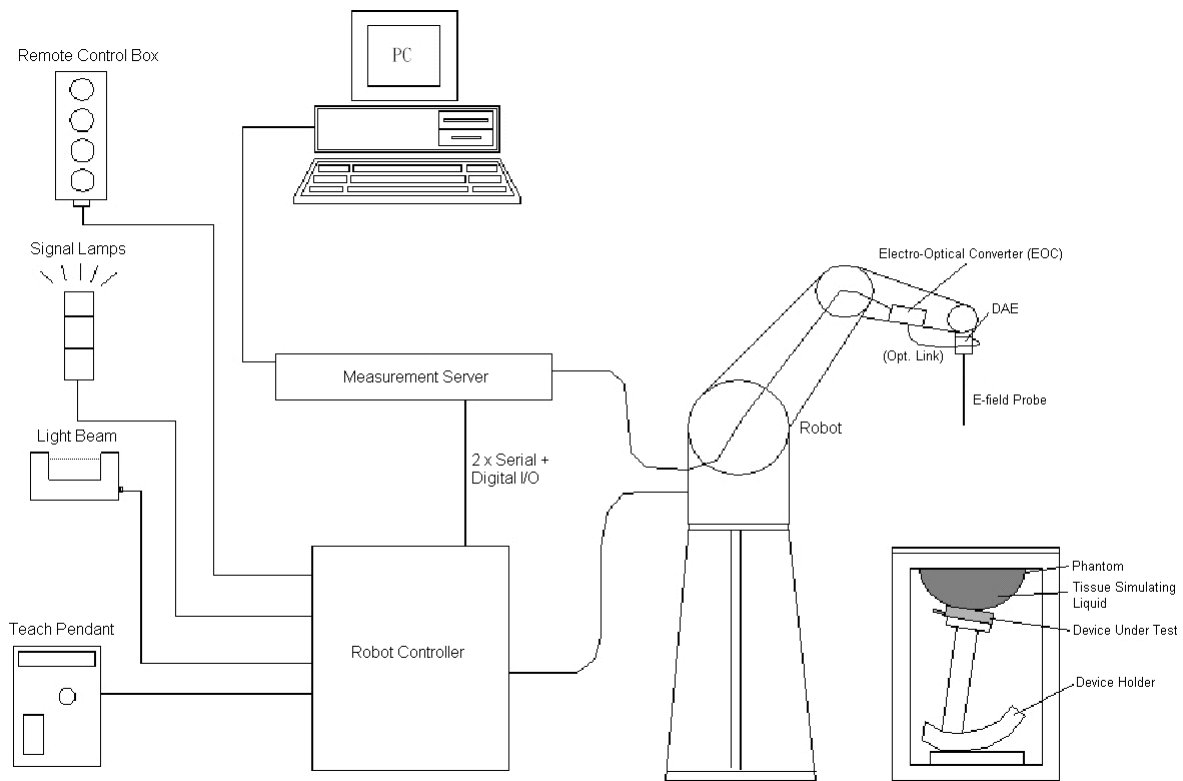

**Fig-3.1 DASY System Setup**

**3.2.1 Robot**

The DASY system uses the high precision robots from Stäubli SA (France). For the 6-axis controller system, the robot controller version (DASY5: CS8c) from Stäubli is used. The Stäubli robot series have many features that are important for our application:

- High precision (repeatability  $\pm 0.035$  mm)
- High reliability (industrial design)
- Jerk-free straight movements
- Low ELF interference (the closed metallic construction shields against motor control fields)





**Fig-3.2 DASY5**

## FCC SAR Test Report

### 3.2.2 Probes

The SAR measurement is conducted with the dosimetric probe. The probe is specially designed and calibrated for use in liquid with high permittivity. The dosimetric probe has special calibration in liquid at different frequency.

<b>Model</b>	EX3DV4	
<b>Construction</b>	Symmetrical design with triangular core. Built-in shielding against static charges. PEEK enclosure material (resistant to organic solvents, e.g., DGBE).	
<b>Frequency</b>	10 MHz to 6 GHz Linearity: $\pm 0.2$ dB	
<b>Directivity</b>	$\pm 0.3$ dB in HSL (rotation around probe axis) $\pm 0.5$ dB in tissue material (rotation normal to probe axis)	
<b>Dynamic Range</b>	10 $\mu$ W/g to 100 mW/g Linearity: $\pm 0.2$ dB (noise: typically $< 1$ $\mu$ W/g)	
<b>Dimensions</b>	Overall length: 337 mm (Tip: 20 mm) Tip diameter: 2.5 mm (Body: 12 mm) Typical distance from probe tip to dipole centers: 1 mm	

<b>Model</b>	ES3DV3	
<b>Construction</b>	Symmetrical design with triangular core. Interleaved sensors. Built-in shielding against static charges. PEEK enclosure material (resistant to organic solvents, e.g., DGBE).	
<b>Frequency</b>	10 MHz to 4 GHz Linearity: $\pm 0.2$ dB	
<b>Directivity</b>	$\pm 0.2$ dB in HSL (rotation around probe axis) $\pm 0.3$ dB in tissue material (rotation normal to probe axis)	
<b>Dynamic Range</b>	5 $\mu$ W/g to 100 mW/g Linearity: $\pm 0.2$ dB	
<b>Dimensions</b>	Overall length: 337 mm (Tip: 20 mm) Tip diameter: 3.9 mm (Body: 12 mm) Distance from probe tip to dipole centers: 2.0 mm	

### 3.2.3 Data Acquisition Electronics (DAE)

<b>Model</b>	DAE3, DAE4	
<b>Construction</b>	Signal amplifier, multiplexer, A/D converter and control logic. Serial optical link for communication with DASY embedded system (fully remote controlled). Two step probe touch detector for mechanical surface detection and emergency robot stop.	
<b>Measurement Range</b>	-100 to +300 mV (16 bit resolution and two range settings: 4mV, 400mV)	
<b>Input Offset Voltage</b>	$< 5$ $\mu$ V (with auto zero)	
<b>Input Bias Current</b>	$< 50$ fA	
<b>Dimensions</b>	60 x 60 x 68 mm	



## 3.2.4 Phantoms

<b>Model</b>	Twin SAM	
<b>Construction</b>	The shell corresponds to the specifications of the Specific Anthropomorphic Mannequin (SAM) phantom defined in IEEE 1528 and IEC 62209-1. It enables the dosimetric evaluation of left and right hand phone usage as well as body mounted usage at the flat phantom region. A cover prevents evaporation of the liquid. Reference markings on the phantom allow the complete setup of all predefined phantom positions and measurement grids by teaching three points with the robot.	
<b>Material</b>	Vinylester, glass fiber reinforced (VE-GF)	
<b>Shell Thickness</b>	$2 \pm 0.2$ mm ( $6 \pm 0.2$ mm at ear point)	
<b>Dimensions</b>	Length: 1000 mm Width: 500 mm Height: adjustable feet	
<b>Filling Volume</b>	approx. 25 liters	

<b>Model</b>	ELI	
<b>Construction</b>	Phantom for compliance testing of handheld and body-mounted wireless devices in the frequency range of 30 MHz to 6 GHz. ELI is fully compatible with the IEC 62209-2 standard and all known tissue simulating liquids. ELI has been optimized regarding its performance and can be integrated into our standard phantom tables. A cover prevents evaporation of the liquid. Reference markings on the phantom allow installation of the complete setup, including all predefined phantom positions and measurement grids, by teaching three points. The phantom is compatible with all SPEAG dosimetric probes and dipoles.	
<b>Material</b>	Vinylester, glass fiber reinforced (VE-GF)	
<b>Shell Thickness</b>	$2.0 \pm 0.2$ mm (bottom plate)	
<b>Dimensions</b>	Major axis: 600 mm Minor axis: 400 mm	
<b>Filling Volume</b>	approx. 30 liters	

# FCC SAR Test Report

## 3.2.5 Device Holder

<b>Model</b>	Mounting Device	
<b>Construction</b>	In combination with the Twin SAM Phantom or ELI4, the Mounting Device enables the rotation of the mounted transmitter device in spherical coordinates. Rotation point is the ear opening point. Transmitter devices can be easily and accurately positioned according to IEC, IEEE, FCC or other specifications. The device holder can be locked for positioning at different phantom sections (left head, right head, flat).	
<b>Material</b>	POM	

<b>Model</b>	Laptop Extensions Kit	
<b>Construction</b>	Simple but effective and easy-to-use extension for Mounting Device that facilitates the testing of larger devices according to IEC 62209-2 (e.g., laptops, cameras, etc.). It is lightweight and fits easily on the upper part of the Mounting Device in place of the phone positioner.	
<b>Material</b>	POM, Acrylic glass, Foam	

## 3.2.6 System Validation Dipoles

<b>Model</b>	D-Serial	
<b>Construction</b>	Symmetrical dipole with 1/4 balun. Enables measurement of feed point impedance with NWA. Matched for use near flat phantoms filled with tissue simulating solutions.	
<b>Frequency</b>	750 MHz to 5800 MHz	
<b>Return Loss</b>	> 20 dB	
<b>Power Capability</b>	> 100 W (f < 1GHz), > 40 W (f > 1GHz)	

### 3.2.7 Tissue Simulating Liquids

For SAR measurement of the field distribution inside the phantom, the phantom must be filled with homogeneous tissue simulating liquid to a depth of at least 15 cm. For head SAR testing, the liquid height from the ear reference point (ERP) of the phantom to the liquid top surface is larger than 15 cm. For body SAR testing, the liquid height from the center of the flat phantom to the liquid top surface is larger than 15 cm. The nominal dielectric values of the tissue simulating liquids in the phantom and the tolerance of 5% are listed in Table-3.1.

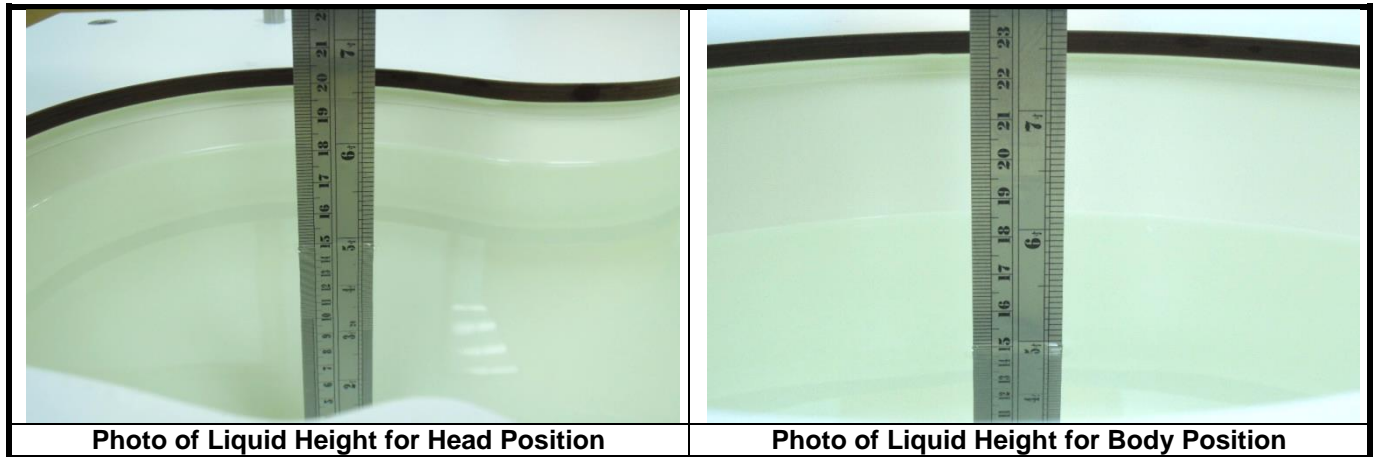

The dielectric properties of the head tissue simulating liquids are defined in IEEE 1528, and KDB 865664 D01 Appendix A. For the body tissue simulating liquids, the dielectric properties are defined in KDB 865664 D01 Appendix A. The dielectric properties of the tissue simulating liquids were verified prior to the SAR evaluation using a dielectric assessment kit and a network analyzer.

**Table-3.1 Targets of Tissue Simulating Liquid**

Frequency (MHz)	Target Permittivity	Range of $\pm 5\%$	Target Conductivity	Range of $\pm 5\%$
<b>For Head</b>				
750	41.9	39.8 ~ 44.0	0.89	0.85 ~ 0.93
835	41.5	39.4 ~ 43.6	0.90	0.86 ~ 0.95
900	41.5	39.4 ~ 43.6	0.97	0.92 ~ 1.02
1450	40.5	38.5 ~ 42.5	1.20	1.14 ~ 1.26
1640	40.3	38.3 ~ 42.3	1.29	1.23 ~ 1.35
1750	40.1	38.1 ~ 42.1	1.37	1.30 ~ 1.44
1800	40.0	38.0 ~ 42.0	1.40	1.33 ~ 1.47
1900	40.0	38.0 ~ 42.0	1.40	1.33 ~ 1.47
2000	40.0	38.0 ~ 42.0	1.40	1.33 ~ 1.47
2300	39.5	37.5 ~ 41.5	1.67	1.59 ~ 1.75
2450	39.2	37.2 ~ 41.2	1.80	1.71 ~ 1.89
2600	39.0	37.1 ~ 41.0	1.96	1.86 ~ 2.06
3500	37.9	36.0 ~ 39.8	2.91	2.76 ~ 3.06
5200	36.0	34.2 ~ 37.8	4.66	4.43 ~ 4.89
5300	35.9	34.1 ~ 37.7	4.76	4.52 ~ 5.00
5500	35.6	33.8 ~ 37.4	4.96	4.71 ~ 5.21
5600	35.5	33.7 ~ 37.3	5.07	4.82 ~ 5.32
5800	35.3	33.5 ~ 37.1	5.27	5.01 ~ 5.53

## FCC SAR Test Report

The following table gives the recipes for tissue simulating liquids.

**Table-3.2 Recipes of Tissue Simulating Liquid**

Tissue Type	Bactericide	DGBE	HEC	NaCl	Sucrose	Triton X-100	Water	Diethylene Glycol Mono-hexylether
H750	0.2	-	0.2	1.5	56.0	-	42.1	-
H835	0.2	-	0.2	1.5	57.0	-	41.1	-
H900	0.2	-	0.2	1.4	58.0	-	40.2	-
H1450	-	43.3	-	0.6	-	-	56.1	-
H1640	-	45.8	-	0.5	-	-	53.7	-
H1750	-	47.0	-	0.4	-	-	52.6	-
H1800	-	44.5	-	0.3	-	-	55.2	-
H1900	-	44.5	-	0.2	-	-	55.3	-
H2000	-	44.5	-	0.1	-	-	55.4	-
H2300	-	44.9	-	0.1	-	-	55.0	-
H2450	-	45.0	-	0.1	-	-	54.9	-
H2600	-	45.1	-	0.1	-	-	54.8	-
H3500	-	8.0	-	0.2	-	20.0	71.8	-
H5G	-	-	-	-	-	17.2	65.5	17.3

### 3.3 SAR System Verification

The system check verifies that the system operates within its specifications. It is performed daily or before every SAR measurement. The system check uses normal SAR measurements in the flat section of the phantom with a matched dipole at a specified distance. The system verification setup is shown as below.

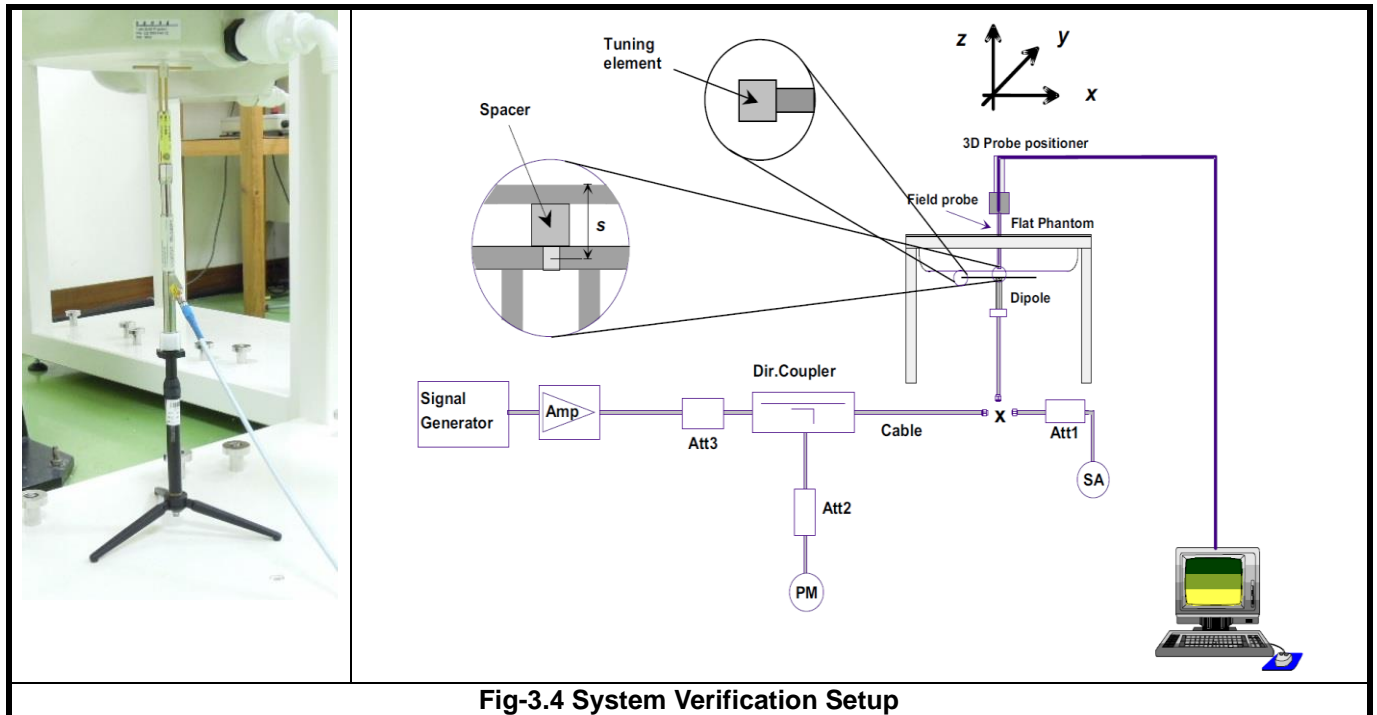

Fig-3.4 System Verification Setup

The validation dipole is placed beneath the flat phantom with the specific spacer in place. The distance spacer is touch the phantom surface with a light pressure at the reference marking and be oriented parallel to the long side of the phantom. The spectrum analyzer measures the forward power at the location of the system check dipole connector. The signal generator is adjusted for the desired forward power (250 mW is used for 700 MHz to 3 GHz, 100 mW is used for 3.5 GHz to 6 GHz) at the dipole connector and the power meter is read at that level. After connecting the cable to the dipole, the signal generator is readjusted for the same reading at power meter.

After system check testing, the SAR result will be normalized to 1W forward input power and compared with the reference SAR value derived from validation dipole certificate report. The deviation of system check should be within 10 %.

### 3.4 SAR Measurement Procedure

According to the SAR test standard, the recommended procedure for assessing the peak spatial-average SAR value consists of the following steps:

- (a) Power reference measurement
- (b) Area scan
- (c) Zoom scan
- (d) Power drift measurement

The SAR measurement procedures for each of test conditions are as follows:

- (a) Make EUT to transmit maximum output power
- (b) Measure conducted output power through RF cable
- (c) Place the EUT in the specific position of phantom
- (d) Perform SAR testing steps on the DASY system
- (e) Record the SAR value

#### 3.4.1 Area & Zoom Scan Procedure

First Area Scan is used to locate the approximate location(s) of the local peak SAR value(s). The measurement grid within an Area Scan is defined by the grid extent, grid step size and grid offset. Next, in order to determine the EM field distribution in a three-dimensional spatial extension, Zoom Scan is required. The Zoom Scan is performed around the highest E-field value to determine the averaged SAR-distribution over 10 g. According to KDB 865664 D01, the resolution for Area and Zoom scan is specified in the table below.

Items	<= 2 GHz	2-3 GHz	3-4 GHz	4-5 GHz	5-6 GHz
Area Scan ( $\Delta x, \Delta y$ )	<= 15 mm	<= 12 mm	<= 12 mm	<= 10 mm	<= 10 mm
Zoom Scan ( $\Delta x, \Delta y$ )	<= 8 mm	<= 5 mm	<= 5 mm	<= 4 mm	<= 4 mm
Zoom Scan ( $\Delta z$ )	<= 5 mm	<= 5 mm	<= 4 mm	<= 3 mm	<= 2 mm
Zoom Scan Volume	>= 30 mm	>= 30 mm	>= 28 mm	>= 25 mm	>= 22 mm

**Note:**

When zoom scan is required and report SAR is <= 1.4 W/kg, the zoom scan resolution of  $\Delta x / \Delta y$  (2-3GHz: <= 8 mm, 3-4GHz: <= 7 mm, 4-6GHz: <= 5 mm) may be applied.

#### 3.4.2 Volume Scan Procedure

The volume scan is used for assess overlapping SAR distributions for antennas transmitting in different frequency bands. It is equivalent to an oversized zoom scan used in standalone measurements. The measurement volume will be used to enclose all the simultaneous transmitting antennas. For antennas transmitting simultaneously in different frequency bands, the volume scan is measured separately in each frequency band. In order to sum correctly to compute the 1g aggregate SAR, the EUT remain in the same test position for all measurements and all volume scan use the same spatial resolution and grid spacing. When all volume scan were completed, the software, SEMCAD postprocessor can combine and subsequently superpose these measurement data to calculating the multiband SAR.

### 3.4.3 Power Drift Monitoring

All SAR testing is under the EUT install full charged battery and transmit maximum output power. In DASYS measurement software, the power reference measurement and power drift measurement procedures are used for monitoring the power drift of EUT during SAR test. Both these procedures measure the field at a specified reference position before and after the SAR testing. The software will calculate the field difference in dB. If the power drift more than 5%, the SAR will be retested.

### 3.4.4 Spatial Peak SAR Evaluation

The procedure for spatial peak SAR evaluation has been implemented according to the test standard. It can be conducted for 1g and 10g, as well as for user-specific masses. The DASYS software includes all numerical procedures necessary to evaluate the spatial peak SAR value.

The base for the evaluation is a "cube" measurement. The measured volume must include the 1g and 10g cubes with the highest averaged SAR values. For that purpose, the center of the measured volume is aligned to the interpolated peak SAR value of a previously performed area scan.

The entire evaluation of the spatial peak values is performed within the post-processing engine (SEMCAD). The system always gives the maximum values for the 1g and 10g cubes. The algorithm to find the cube with highest averaged SAR is divided into the following stages:

- (a) Extraction of the measured data (grid and values) from the Zoom Scan
- (b) Calculation of the SAR value at every measurement point based on all stored data (A/D values and measurement parameters)
- (c) Generation of a high-resolution mesh within the measured volume
- (d) Interpolation of all measured values from the measurement grid to the high-resolution grid
- (e) Extrapolation of the entire 3-D field distribution to the phantom surface over the distance from sensor to surface
- (f) Calculation of the averaged SAR within masses of 1g and 10g

### 3.4.5 SAR Averaged Methods

In DASYS, the interpolation and extrapolation are both based on the modified Quadratic Shepard's method. The interpolation scheme combines a least-square fitted function method and a weighted average method which are the two basic types of computational interpolation and approximation.

Extrapolation routines are used to obtain SAR values between the lowest measurement points and the inner phantom surface. The extrapolation distance is determined by the surface detection distance and the probe sensor offset. The uncertainty increases with the extrapolation distance. To keep the uncertainty within 1% for the 1 g and 10 g cubes, the extrapolation distance should not be larger than 5 mm.



## 4. SAR Measurement Evaluation

### 4.1 EUT Configuration and Setting

#### <Considerations Related to Proximity Sensor>

The device supports WLAN, and Bluetooth capabilities. It is designed with two proximity sensor which can trigger/not trigger power reduction for WLAN on Rear Face Right Side and Top Side of EUT for SAR compliance. Others RF capability (Bluetooth) have no power reduction. The power levels for all wireless technologies and the power reduction please refer to section 4.5 of this report.

#### Proximity Sensor Triggering Distances (KDB 616217 D04 §6.2)

The proximity sensor triggering distance was determined per KDB 616217 for rear face and applicable edge. Summary for power verification per distance was tabulated in the below table.

Output Power Verification in dBm for EUT Rear Face											
Distance (mm)	5	6	7	8	9	10	11	12	13	14	15
WLAN2.4G	13.0	13.0	13.0	13.0	13.0	21.0	21.0	21.0	21.0	21.0	21.0
WLAN5.2G	12.0	12.0	12.0	12.0	12.0	20.0	20.0	20.0	20.0	20.0	20.0
WLAN5.3G	12.0	12.0	12.0	12.0	12.0	20.0	20.0	20.0	20.0	20.0	20.0
WLAN5.6G	11.5	11.5	11.5	11.5	11.5	20.0	20.0	20.0	20.0	20.0	20.0
WLAN5.8G	12.0	12.0	12.0	12.0	12.0	20.0	20.0	20.0	20.0	20.0	20.0

Output Power Verification in dBm for EUT Right Side											
Distance (mm)	0	1	2	3	4	5	6	7	8	9	10
WLAN2.4G	13.0	13.0	13.0	13.0	13.0	21.0	21.0	21.0	21.0	21.0	21.0
WLAN5.2G	12.0	12.0	12.0	12.0	12.0	20.0	20.0	20.0	20.0	20.0	20.0
WLAN5.3G	12.0	12.0	12.0	12.0	12.0	20.0	20.0	20.0	20.0	20.0	20.0
WLAN5.6G	11.5	11.5	11.5	11.5	11.5	20.0	20.0	20.0	20.0	20.0	20.0
WLAN5.8G	12.0	12.0	12.0	12.0	12.0	20.0	20.0	20.0	20.0	20.0	20.0

# FCC SAR Test Report

Output Power Verification in dBm for EUT Top Side											
Distance (mm)	11	12	13	14	15	16	17	18	19	20	21
WLAN2.4G	13.0	13.0	13.0	13.0	13.0	21.0	21.0	21.0	21.0	21.0	21.0
WLAN5.2G	12.0	12.0	12.0	12.0	12.0	20.0	20.0	20.0	20.0	20.0	20.0
WLAN5.3G	12.0	12.0	12.0	12.0	12.0	20.0	20.0	20.0	20.0	20.0	20.0
WLAN5.6G	11.5	11.5	11.5	11.5	11.5	20.0	20.0	20.0	20.0	20.0	20.0
WLAN5.8G	12.0	12.0	12.0	12.0	12.0	20.0	20.0	20.0	20.0	20.0	20.0

### Proximity Sensor Coverage (KDB 616217 D04 §6.3)

Since the proximity sensor is collocated with antenna in one component, the procedure for proximity sensor coverage is not required.

### Proximity Sensor Tilt Angle Influences(KDB 616217 D04 §6.4)

The proximity sensor tilt angle influence was determined per KDB 616217 for applicable edge. Summary for proximity sensor tilt angle influence is shown in below.

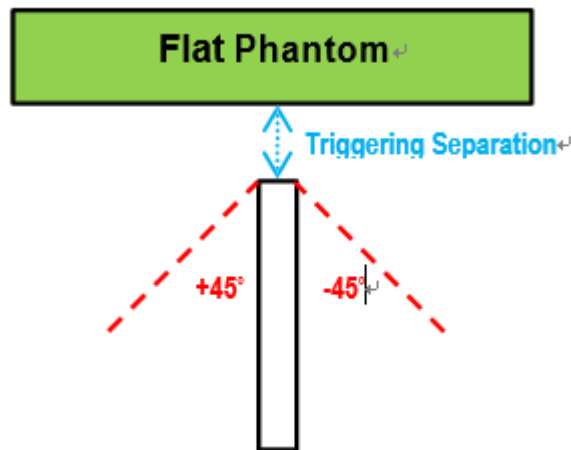

Orientation	Separation Distance (mm)	Tilt Angle										
		-45°	-40°	-30°	-20°	-10°	0°	10°	20°	30°	40°	45°
Top Side	13	On	On	On	On	On	On	On	On	On	On	On
Right Side	4	On	On	On	On	On	On	On	On	On	On	On

## Summary for Proximity Sensor Triggering Test

According to the procedures noticed in KDB 616217 D04, The WLAN for proximity sensor triggering distance is 9 mm for EUT Rear Face, 4 mm for EUT Right Side and 15 mm for Top Side. The separation distance of 13 mm / 4 mm determined by the smallest triggering distance on Top Side Right Side is used to access the tilt angle influence and the sensor does not release during  $\pm 45$  degree. Therefore, the smallest separation distance for tilt angle influence is 13 mm for the Top Side and 4 mm for the Right Side. The conservation triggering distances based on the separation distance for the sensor trigger / not triggered as EUT with power reduction at 0 mm, and EUT without power reduction at 8 mm for EUT Rear Face, 3 mm for EUT Right Side and 12 mm for Top Side were used to test SAR.

The power reduction is depends on the proximity sensor input. For a steady SAR test, the power reduction was enabled or disabled manually by engineering software during SAR testing.

## <Considerations Related to WLAN for Setup and Testing>

In general, various vendor specific external test software and chipset based internal test modes are typically used for SAR measurement. These chipset based test mode utilities are generally hardware and manufacturer dependent, and often include substantial flexibility to reconfigure or reprogram a device. A Wi-Fi device must be configured to transmit continuously at the required data rate, channel bandwidth and signal modulation, using the highest transmission duty factor supported by the test mode tools for SAR measurement. The test frequencies established using test mode must correspond to the actual channel frequencies. When 802.11 frame gaps are accounted for in the transmission, a maximum transmission duty factor of 92 - 96% is typically achievable in most test mode configurations. A minimum transmission duty factor of 85% is required to avoid certain hardware and device implementation issues related to wide range SAR scaling. In addition, a periodic transmission duty factor is required for current generation SAR systems to measure SAR correctly. The reported SAR must be scaled to 100% transmission duty factor to determine compliance at the maximum tune-up tolerance limit.

According to KDB 248227 D01, this device has installed WLAN engineering testing software which can provide continuous transmitting RF signal. During WLAN SAR testing, this device was operated to transmit continuously at the maximum transmission duty with specified transmission mode, operating frequency, lowest data rate, and maximum output power.

## Initial Test Configuration

An initial test configuration is determined for OFDM transmission modes in 2.4 GHz and 5 GHz bands according to the channel bandwidth, modulation and data rate combination(s) with the highest maximum output power specified for production units in each standalone and aggregated frequency band. When the same maximum power is specified for multiple transmission modes in a frequency band, the largest channel bandwidth, lowest order modulation, lowest data rate and lowest order 802.11a/g/n/ac mode is used for SAR measurement, on the highest measured output power channel in the initial test configuration, for each frequency band.

## Subsequent Test Configuration

SAR measurement requirements for the remaining 802.11 transmission mode configurations that have not been tested in the initial test configuration are determined separately for each standalone and aggregated frequency band, in each exposure condition, according to the maximum output power specified for production units. Additional power measurements may be required to determine if SAR measurements are required for subsequent highest output

## FCC SAR Test Report

---

power channels in a subsequent test configuration. When the highest reported SAR for the initial test configuration according to the initial test position or fixed exposure position requirements, is adjusted by the ratio of the subsequent test configuration to initial test configuration specified maximum output power and the adjusted SAR is  $\leq 1.2$  W/kg, SAR is not required for that subsequent test configuration.

### **SAR Test Configuration and Channel Selection**

When multiple channel bandwidth configurations in a frequency band have the same specified maximum output power, the initial test configuration is using largest channel bandwidth, lowest order modulation, lowest data rate, and lowest order 802.11 mode (i.e., 802.11a is chosen over 802.11n then 802.11ac or 802.11g is chosen over 802.11n). After an initial test configuration is determined, if multiple test channels have the same measured maximum output power, the channel chosen for SAR measurement is determined according to the following.

- 1) The channel closest to mid-band frequency is selected for SAR measurement.
- 2) For channels with equal separation from mid-band frequency; for example, high and low channels or two mid-band channels, the higher frequency (number) channel is selected for SAR measurement.

### **Test Reduction for U-NII-1 (5.2 GHz) and U-NII-2A (5.3 GHz) Bands**

For devices that operate in both U-NII bands using the same transmitter and antenna(s), SAR test reduction is determined according to the following.

- 1) When the same maximum output power is specified for both bands, begin SAR measurement in U-NII-2A band by applying the OFDM SAR requirements. If the highest reported SAR for a test configuration is  $\leq 1.2$  W/kg, SAR is not required for U-NII-1 band for that configuration (802.11 mode and exposure condition).
- 2) When different maximum output power is specified for the bands, begin SAR measurement in the band with higher specified maximum output power. The highest reported SAR for the tested configuration is adjusted by the ratio of lower to higher specified maximum output power for the two bands. When the adjusted SAR is  $\leq 1.2$  W/kg, SAR is not required for the band with lower maximum output power in that test configuration.

### **<Considerations Related to Bluetooth for Setup and Testing>**

This device has installed Bluetooth engineering testing software which can provide continuous transmitting RF signal. During Bluetooth SAR testing, this device was operated to transmit continuously at the maximum transmission duty with specified transmission mode, operating frequency, lowest data rate, and maximum output power.

## 4.2 EUT Testing Position

### 4.2.1 Body Exposure Conditions

For full-size tablet, according to KDB 616217 D04, SAR evaluation is required for back surface and edges of the devices. The back surface and edges of the tablet are tested with the tablet touching the phantom. Exposures from antennas through the front surface of the display section of a tablet are generally limited to the user's hands. Exposures to hands for typical consumer transmitters used in tablets are not expected to exceed the extremity SAR limit; therefore, SAR evaluation for the front surface of tablet display screens are generally not necessary. When voice mode is supported on a tablet and it is limited to speaker mode or headset operations only, additional SAR testing for this type of voice use is not required.

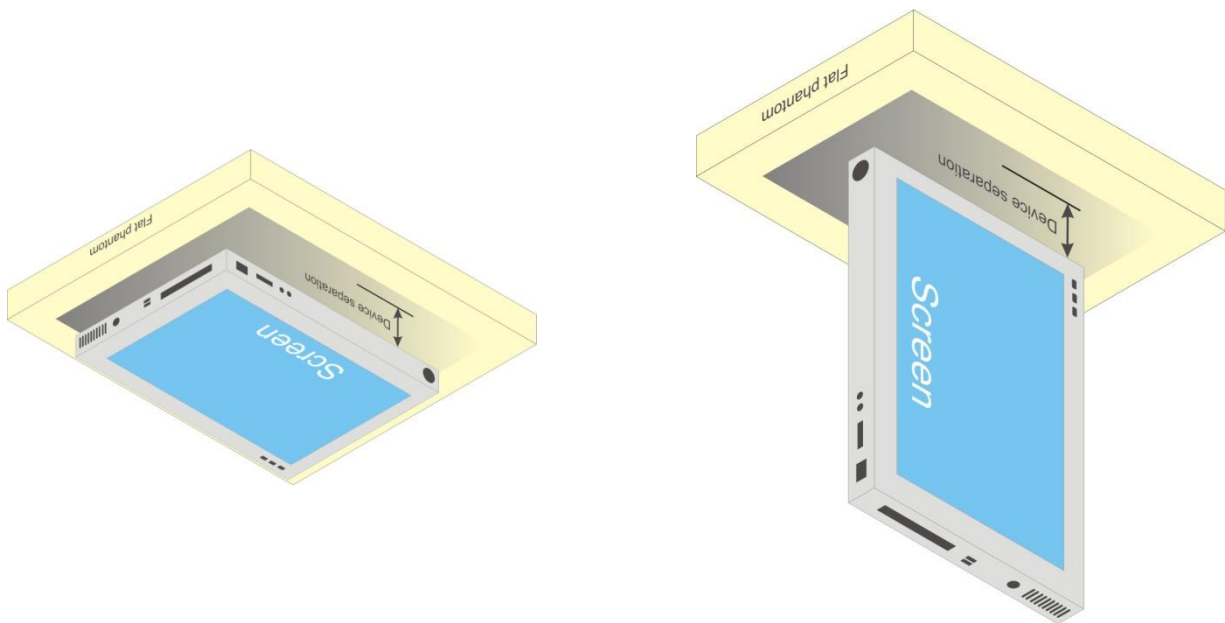

Fig-4.1 Illustration for Tablet Setup

# FCC SAR Test Report

## 4.2.2 SAR Test Exclusion Evaluations

According to KDB 447498 D01, the SAR test exclusion condition is based on source-based time-averaged maximum conducted output power, adjusted for tune-up tolerance, and the minimum test separation distance required for the exposure conditions. The SAR exclusion threshold is determined by the following formula.

1. For the test separation distance  $\leq 50$  mm

$$\frac{\text{Max. Tune up Power}_{(mW)}}{\text{Min. Test Separation Distance}_{(mm)}} \times \sqrt{f_{(GHz)}} \leq 3.0 \text{ for SAR-1g, } \leq 7.5 \text{ for SAR-10g}$$

When the minimum test separation distance is  $< 5$  mm, a distance of 5 mm is applied to determine SAR test exclusion.

2. For the test separation distance  $> 50$  mm, and the frequency at 100 MHz to 1500 MHz

$$\left[ (\text{Threshold at 50 mm in Step 1}) + (\text{Test Separation Distance} - 50 \text{ mm}) \times \left( \frac{f_{(MHz)}}{150} \right) \right]_{(mW)}$$

3. For the test separation distance  $> 50$  mm, and the frequency at  $> 1500$  MHz to 6 GHz

$$[(\text{Threshold at 50 mm in Step 1}) + (\text{Test Separation Distance} - 50 \text{ mm}) \times 10]_{(mW)}$$

Exposure Position	Wireless Interface	BT	2.4GHz WLAN	5GHz WLAN
	Calculated Frequency	2480MHz	2462MHz	5825MHz
	Maximum power (dBm)	11	21	20
	Maximum rated power(mW)	13.0	126.0	100
Rear Face	Separation distance(mm)	0		
	exclusion threshold	4.1	39.5	48.3
	Testing required?	Yes	Yes	Yes
Top Side	Separation distance(mm)	0		
	exclusion threshold	4.1	39.5	48.3
	Testing required?	Yes	Yes	Yes
Right Side	Separation distance(mm)	4.7		
	exclusion threshold	4.1	39.5	48.3
	Testing required?	Yes	Yes	Yes
Bottom Side	Separation distance(mm)	237.4		
	exclusion threshold	1969.0	1970.0	1936.0
	Testing required?	No	No	No
Left Side	Separation distance(mm)	103.3		
	exclusion threshold	628.0	629.0	595.0
	Testing required?	No	No	No

### Note:

- When separation distance  $\leq 50$  mm and the calculated result shown in above table is  $\leq 3.0$  for SAR-1g exposure condition, or  $\leq 7.5$  for SAR-10g exposure condition, the SAR testing exclusion is applied.
- When separation distance  $> 50$  mm and the device output power is less than the calculated result (power threshold, mW) shown in above table, the SAR testing exclusion is applied

# FCC SAR Test Report

## 4.2.3 Simultaneous Transmission Possibilities

The simultaneous transmission possibilities for this device are listed as below.

Simultaneous TX Combination	Capable Transmit Configurations	Body Exposure Condition
1	WLAN5G + BT	Yes

**Note :**

1. The 2.4G WLAN and 5G WLAN cannot transmit simultaneously.
2. The 2.4G WLAN and BT cannot transmit simultaneously.

## 4.3 Tissue Verification

The measuring results for tissue simulating liquid are shown as below.

Test Date	Tissue Type	Frequency (MHz)	Liquid Temp. (°C)	Measured Conductivity (σ)	Measured Permittivity (ε <sub>r</sub> )	Target Conductivity (σ)	Target Permittivity (ε <sub>r</sub> )	Conductivity Deviation (%)	Permittivity Deviation (%)
Mar. 06, 2021	Head	2450	22.5	1.786	40.180	1.80	39.20	-0.78	2.50
Mar. 10, 2021	Head	5250	22.6	4.721	37.228	4.71	35.90	0.23	3.70
Mar. 15, 2021	Head	5600	22.4	5.051	36.822	5.07	35.50	-0.37	3.72
Mar. 20, 2021	Head	5800	22.6	5.210	36.661	5.27	35.30	-1.14	3.86

**Note:**

The dielectric properties of the tissue simulating liquid must be measured within 24 hours before the SAR testing and within ±5% of the target values. Liquid temperature during the SAR testing must be within ±2 °C.

## 4.4 System Verification

The measuring result for system verification is tabulated as below.

Test Date	Mode	Frequency (MHz)	1W Target SAR-1g (W/kg)	Measured SAR-1g (W/kg)	Normalized to 1W SAR-1g (W/kg)	Deviation (%)	Dipole S/N	Probe S/N	DAE S/N
Mar. 06, 2021	Head	2450	53.10	14.30	57.20	7.72	893	3873	1341
Mar. 10, 2021	Head	5250	79.00	8.43	84.30	6.71	1133	3873	1341
Mar. 15, 2021	Head	5600	84.30	8.97	89.70	6.41	1133	3873	1341
Mar. 20, 2021	Head	5800	81.10	8.24	82.40	1.60	1133	3873	1341

**Note:**

Comparing to the reference SAR value provided by SPEAG, the validation data should be within its specification of 10 %. The result indicates the system check can meet the variation criterion and the plots can be referred to Appendix A of this report.

## FCC SAR Test Report

### 4.5 Maximum Output Power

#### 4.5.1 Maximum Conducted Power

The maximum conducted average power (Unit: dBm) including tune-up tolerance is shown as below.

	Mode	Channel	Frequency (MHz)	Tune-Up Limit (without Power Reduction)	Tune-Up Limit (with Power Reduction)
	2.4GHz WLAN	802.11b 1Mbps	1	2412	20.0
6			2437	20.0	13.0
11			2462	21.0	13.0
802.11g 6Mbps		1	2412	19.5	12.0
		6	2437	19.5	12.0
		11	2462	20.0	12.0
802.11n-HT20 MCS0		1	2412	18.5	12.0
		6	2437	18.5	12.0
		11	2462	19.0	12.0
802.11n-HT40 MCS0		3	2422	17.5	12.0
		6	2437	17.5	12.0
		9	2452	17.5	12.0



# FCC SAR Test Report

	Mode	Channel	Frequency (MHz)	Tune-Up Limit (without Power Reduction)	Tune-Up Limit (with Power Reduction)
5.2GHz WLAN	802.11a 6Mbps	36	5180	20.0	12.0
		40	5200	20.0	12.0
		44	5220	20.0	12.0
		48	5240	20.0	12.0
	802.11n-HT20 MCS0	36	5180	19.0	11.5
		40	5200	20.0	11.5
		44	5220	20.0	11.5
		48	5240	20.0	11.5
	802.11n-HT40 MCS0	38	5190	19.0	11.5
		46	5230	19.0	11.5
	802.11ac-VHT20 MCS0	36	5180	19.0	11.5
		40	5200	20.0	11.5
		44	5220	20.0	11.5
		48	5240	20.0	11.5
	802.11ac-VHT40 MCS0	38	5190	19.0	11.5
		46	5230	19.0	11.5
802.11ac-VHT80 MCS0	42	5210	18.0	11.5	

# FCC SAR Test Report

	Mode	Channel	Frequency (MHz)	Tune-Up Limit (without Power Reduction)	Tune-Up Limit (with Power Reduction)
	5.3GHz WLAN	802.11a 6Mbps	52	5260	20.0
56			5280	20.0	12.0
60			5300	20.0	12.0
64			5320	20.0	12.0
802.11n-HT20 MCS0		52	5260	20.0	11.5
		56	5280	20.0	11.5
		60	5300	20.0	11.5
		64	5320	20.0	11.5
802.11n-HT40 MCS0		54	5270	19.0	11.5
		62	5310	19.0	11.5
802.11ac-VHT20 MCS0		52	5260	20.0	11.5
		56	5280	20.0	11.5
		60	5300	20.0	11.5
		64	5320	20.0	11.5
802.11ac-VHT40 MCS0		54	5270	19.0	11.5
		62	5310	19.0	11.5
802.11ac-VHT80 MCS0	58	5290	18.0	11.5	

# FCC SAR Test Report



	Mode	Channel	Frequency (MHz)	Tune-Up Limit	Tune-Up Limit
				(without Power Reduction)	(with Power Reduction)
5.6GHz WLAN	802.11a 6Mbps	100	5500	20.0	11.5
		116	5580	20.0	11.5
		124	5620	20.0	11.5
		132	5660	20.0	11.5
		140	5700	20.0	11.5
		144	5720	20.0	11.5
	802.11n-HT20 MCS0	100	5500	20.0	11.5
		116	5580	20.0	11.5
		124	5620	20.0	11.5
		132	5660	20.0	11.5
		140	5700	20.0	11.5
		144	5720	20.0	11.5
	802.11n-HT40 MCS0	102	5510	19.0	11.0
		110	5550	19.0	11.0
		126	5630	19.0	11.0
		134	5670	19.0	11.0
		142	5710	19.0	11.0
	802.11ac-VHT20 MCS0	100	5500	20.0	11.5
		116	5580	20.0	11.5
		124	5620	20.0	11.5
		132	5660	20.0	11.5
		140	5700	20.0	11.5
		144	5720	20.0	11.5
	802.11ac-VHT40 MCS0	102	5510	19.0	11.0
		110	5550	19.0	11.0
		126	5630	19.0	11.0
		134	5670	19.0	11.0
		142	5710	19.0	11.0
	802.11ac-VHT80 MCS0	106	5530	18.0	11.0
		122	5610	18.0	11.0
138		5690	18.0	11.0	

# FCC SAR Test Report

5.8GHz WLAN	Mode	Channel	Frequency (MHz)	Tune-Up Limit (without Power Reduction)	Tune-Up Limit (with Power Reduction)
	802.11a 6Mbps	149	5745	20.0	12.0
		157	5785	20.0	12.0
		165	5825	20.0	12.0
	802.11n-HT20 MCS0	149	5745	20.0	12.0
		157	5785	20.0	12.0
		165	5825	20.0	12.0
	802.11n-HT40 MCS0	151	5755	19.0	11.5
		159	5795	19.0	11.5
	802.11ac-VHT20 MCS0	149	5745	20.0	12.0
157		5785	20.0	12.0	
165		5825	20.0	12.0	
802.11ac-VHT40 MCS0	151	5755	19.0	11.5	
	159	5795	19.0	11.5	
802.11ac-VHT80 MCS0	155	5775	18.0	11.5	

Mode	2.4G Bluetooth
GFSK	9.5
$\pi/4$ -DQPSK	6.0
8-DPSK	6.0
LE	-2.0

# FCC SAR Test Report

## 4.5.2 Measured Conducted Power Result

The measuring conducted average power (Unit: dBm) is shown as below.

2.4GHz WLAN	Mode	Channel	Frequency (MHz)	Average power (dBm) (without Power Reduction)	Average power (dBm) (with Power Reduction)	Duty Cycle %
	802.11b 1Mbps		1	2412	18.98	11.23
6			2437	18.77	11.76	
11			2462	19.38	12.64	
802.11g 6Mbps		1	2412	17.76	10.28	100
		6	2437	17.65	10.87	
		11	2462	18.36	11.84	
802.11n-HT20 MCS0		1	2412	16.81	10.38	100
		6	2437	16.70	10.88	
		11	2462	17.34	11.77	
802.11n-HT40 MCS0		3	2422	15.97	11.08	100
		6	2437	16.22	11.11	
		9	2452	16.13	11.15	

# FCC SAR Test Report

	Mode	Channel	Frequency (MHz)	Average power (dBm) (without Power Reduction)	Average power (dBm) (with Power Reduction)	Duty Cycle %
5.2GHz WLAN	802.11a 6Mbps	36	5180	18.50	10.72	100
		40	5200	19.02	11.11	
		44	5220	18.95	11.29	
		48	5240	18.96	11.47	
	802.11n-HT20 MCS0	36	5180	18.51	10.44	100
		40	5200	19.02	11.05	
		44	5220	19.18	11.17	
		48	5240	19.32	11.32	
	802.11n-HT40 MCS0	38	5190	18.02	10.54	100
		46	5230	18.32	11.11	
	802.11ac-VHT20 MCS0	36	5180	18.45	10.58	100
		40	5200	18.97	10.92	
		44	5220	19.05	10.97	
		48	5240	19.25	11.31	
802.11ac-VHT40 MCS0	38	5190	17.88	10.44	100	
	46	5230	18.25	10.88		
802.11ac-VHT80 MCS0	42	5210	17.10	10.92	100	

# FCC SAR Test Report

	Mode	Channel	Frequency (MHz)	Average power (dBm) (without Power Reduction)	Average power (dBm) (with Power Reduction)	Duty Cycle %
5.3GHz WLAN	802.11a 6Mbps	52	5260	19.12	10.82	100
		56	5280	19.27	11.25	
		60	5300	19.32	11.46	
		64	5320	19.42	11.58	
	802.11n-HT20 MCS0	52	5260	19.98	10.55	100
		56	5280	19.31	10.82	
		60	5300	19.22	11.12	
		64	5320	19.35	11.27	
	802.11n-HT40 MCS0	54	5270	18.18	10.61	100
		62	5310	18.43	11.15	
	802.11ac-VHT20 MCS0	52	5260	18.52	10.47	100
		56	5280	18.75	10.86	
		60	5300	18.63	11.14	
		64	5320	19.11	11.31	
	802.11ac-VHT40 MCS0	54	5270	17.82	10.61	100
		62	5310	18.18	11.04	
802.11ac-VHT80 MCS0	58	5290	17.52	11.01	100	

# FCC SAR Test Report



	Mode	Channel	Frequency (MHz)	Average power (dBm) (without Power Reduction)	Average power (dBm) (with Power Reduction)	Duty Cycle %
5.6GHz WLAN	802.11a 6Mbps	100	5500	19.34	11.28	100
		116	5580	19.28	11.01	
		124	5620	19.25	11.03	
		132	5660	19.21	11.14	
		140	5700	19.15	10.95	
		144	5720	19.10	11.05	
	802.11n-HT20 MCS0	100	5500	19.40	10.95	100
		116	5580	19.18	10.98	
		124	5620	19.22	10.92	
		132	5660	19.26	11.02	
		140	5700	19.19	11.07	
		144	5720	19.05	11.03	
	802.11n-HT40 MCS0	102	5510	18.35	10.87	100
		110	5550	18.30	10.27	
		126	5630	18.29	10.60	
		134	5670	18.26	10.55	
		142	5710	18.19	10.84	
	802.11ac-VHT20 MCS0	100	5500	18.92	10.77	100
		116	5580	19.03	10.95	
		124	5620	18.99	10.76	
		132	5660	18.95	10.98	
		140	5700	18.82	10.94	
		144	5720	18.98	10.89	
	802.11ac-VHT40 MCS0	102	5510	18.09	10.64	100
		110	5550	17.79	10.37	
		126	5630	18.05	10.68	
		134	5670	18.10	10.77	
142		5710	18.00	10.88		
802.11ac-VHT80 MCS0	106	5530	17.12	10.58	100	
	122	5610	17.18	10.75		
	138	5690	17.30	10.82		



# FCC SAR Test Report



5.8GHz WLAN	Mode	Channel	Frequency (MHz)	Average power (dBm) (without Power Reduction)	Average power (dBm) (with Power Reduction)	Duty Cycle %
	802.11a 6Mbps	149	5745	19.18	11.37	100
		157	5785	19.15	11.36	
		165	5825	19.23	11.54	
	802.11n-HT20 MCS0	149	5745	19.02	11.32	100
		157	5785	18.97	11.27	
		165	5825	18.88	11.24	
	802.11n-HT40 MCS0	151	5755	18.20	11.34	100
		159	5795	17.89	11.07	
	802.11ac-VHT20 MCS0	149	5745	18.68	11.24	100
157		5785	18.52	11.38		
165		5825	18.45	11.33		
802.11ac-VHT40 MCS0	151	5755	17.82	11.31	100	
	159	5795	17.68	11.14		
802.11ac-VHT80 MCS0	155	5775	16.73	11.25	100	

## <Bluetooth>

Mode	Bluetooth GFSK		
Channel / Frequency (MHz)	0 (2402)	39 (2441)	78 (2480)
Average Power	7.82	7.52	7.68
Mode	Bluetooth $\pi/4$ -DQPSK		
Channel / Frequency (MHz)	0 (2402)	39 (2441)	78 (2480)
Average Power	4.91	4.12	5.08
Mode	Bluetooth 8-DPSK		
Channel / Frequency (MHz)	0 (2402)	39 (2441)	78 (2480)
Average Power	4.99	4.23	5.10
Mode	Bluetooth LE		
Channel / Frequency (MHz)	0 (2402)	19 (2440)	39 (2480)
Average Power	-4.25	-2.96	-3.49

### **4.6 SAR Testing Results**

#### **4.6.1 SAR Test Reduction Considerations**

##### **<KDB 447498 D01, General RF Exposure Guidance>**

Testing of other required channels within the operating mode of a frequency band is not required when the reported SAR for the mid-band or highest output power channel is:

- (1)  $\leq 0.8$  W/kg or 2.0 W/kg, for 1-g or 10-g respectively, when the transmission band is  $\leq 100$  MHz
- (2)  $\leq 0.6$  W/kg or 1.5 W/kg, for 1-g or 10-g respectively, when the transmission band is between 100 MHz and 200 MHz
- (3)  $\leq 0.4$  W/kg or 1.0 W/kg, for 1-g or 10-g respectively, when the transmission band is  $\geq 200$  MHz

##### **<KDB 248227 D01, SAR Guidance for Wi-Fi Transmitters>**

- (1) For handsets operating next to ear, hotspot mode or mini-tablet configurations, the initial test position procedures were applied. The test position with the highest extrapolated peak SAR will be used as the initial test position. When the reported SAR of initial test position is  $\leq 0.4$  W/kg, SAR testing for remaining test positions is not required. Otherwise, SAR is evaluated at the subsequent highest peak SAR positions until the reported SAR result is  $\leq 0.8$  W/kg or all test positions are measured.
- (2) For WLAN 2.4 GHz, the highest measured maximum output power channel for DSSS was selected for SAR measurement. When the reported SAR is  $\leq 0.8$  W/kg, no further SAR testing is required. Otherwise, SAR is evaluated at the next highest measured output power channel. When any reported SAR is  $> 1.2$  W/kg, SAR is required for the third channel. For OFDM modes (802.11g/n), SAR is not required when the highest reported SAR for DSSS is adjusted by the ratio of OFDM to DSSS specified maximum output power and it is  $\leq 1.2$  W/kg.
- (3) For WLAN 5 GHz, the initial test configuration was selected according to the transmission mode with the highest maximum output power. When the reported SAR of initial test configuration is  $> 0.8$  W/kg, SAR is required for the subsequent highest measured output power channel until the reported SAR result is  $\leq 1.2$  W/kg or all required channels are measured. For other transmission modes, SAR is not required when the highest reported SAR for initial test configuration is adjusted by the ratio of subsequent test configuration to initial test configuration specified maximum output power and it is  $\leq 1.2$  W/kg.
- (4) For WLAN MIMO mode, the power-based standalone SAR test exclusion or the sum of SAR provision in KDB 447498 to determine simultaneous transmission SAR test exclusion should be applied. Otherwise, SAR for MIMO mode will be measured with all applicable antennas transmitting simultaneously at the specified maximum output power of MIMO operation.

# FCC SAR Test Report

## 4.6.2 SAR Results for Body Exposure Condition (Separation Distance is 0 cm Gap)

Plot No.	Band	Mode	Test Position	Separation Distance (cm)	Ch.	Power Reduction	Sample	Duty Cycle %	Max. Tune-up Power (dBm)	Measured Conducted Power (dBm)	Power Drift (dB)	Measured SAR-1g (W/kg)	Duty Cycle Scaling Factor	Tune-up Scaling Factor	Scaled SAR-1g (W/kg)
	WLAN2.4G	802.11b	Rear Face	0	11	Sensor On	1	100	13.0	12.64	0	0.689	1.00	1.09	0.75
	WLAN2.4G	802.11b	Right Side	0	11	Sensor On	1	100	13.0	12.64	0.03	0.368	1.00	1.09	0.40
	WLAN2.4G	802.11b	Top Side	0	11	Sensor On	1	100	13.0	12.64	0.07	0.258	1.00	1.09	0.28
	WLAN2.4G	802.11b	Rear Face	0.8	11	Sensor Off	1	100	21.0	19.38	0.09	0.643	1.00	1.45	0.93
1	WLAN2.4G	802.11b	Right Side	0.3	11	Sensor Off	1	100	21.0	19.38	-0.02	0.759	1.00	1.45	<b>1.10</b>
	WLAN2.4G	802.11b	Top Side	1.2	11	Sensor Off	1	100	21.0	19.38	0.09	0.220	1.00	1.45	0.32
	WLAN2.4G	802.11b	Rear Face	0.8	1	Sensor Off	1	100	20.0	18.98	0.08	0.557	1.00	1.26	0.70
	WLAN2.4G	802.11b	Right Side	0.3	1	Sensor Off	1	100	20.0	18.98	0.1	0.643	1.00	1.26	0.81
	WLAN2.4G	802.11b	Right Side	0.3	11	Sensor Off	2	100	21.0	19.38	0.02	0.434	1.00	1.45	0.63
	WLAN2.4G	802.11b	Right Side	0.3	11	Sensor Off	3	100	21.0	19.38	0.11	0.511	1.00	1.45	0.74
	WLAN2.4G	802.11b	Right Side	0.3	11	Sensor Off	4	100	21.0	19.38	0.06	0.594	1.00	1.45	0.86
	WLAN5G	802.11a	Rear Face	0	64	Sensor On	1	100	12.0	11.58	0.09	0.427	1.00	1.10	0.47
	WLAN5G	802.11a	Right Side	0	64	Sensor On	1	100	12.0	11.58	0	0.207	1.00	1.10	0.23
2	WLAN5G	802.11a	Top Side	0	64	Sensor On	1	100	12.0	11.58	0	1.080	1.00	1.10	<b>1.19</b>
	WLAN5G	802.11a	Rear Face	0.8	64	Sensor Off	1	100	20.0	19.42	-0.03	0.662	1.00	1.14	0.76
	WLAN5G	802.11a	Right Side	0.3	64	Sensor Off	1	100	20.0	19.42	0.05	0.832	1.00	1.14	0.95
	WLAN5G	802.11a	Top Side	1.2	64	Sensor Off	1	100	20.0	19.42	0.04	0.909	1.00	1.14	1.04
	WLAN5G	802.11a	Top Side	0	60	Sensor On	1	100	12.0	11.46	0.01	1.020	1.00	1.13	1.16
	WLAN5G	802.11a	Right Side	0.3	60	Sensor Off	1	100	20.0	19.32	0.03	0.826	1.00	1.17	0.97
	WLAN5G	802.11a	Top Side	1.2	60	Sensor Off	1	100	20.0	19.32	0.09	1.010	1.00	1.17	1.18
	WLAN5G	802.11a	Top Side	0	64	Sensor On	2	100	12.0	11.58	-0.01	0.721	1.00	1.10	0.79
	WLAN5G	802.11a	Top Side	0	64	Sensor On	3	100	12.0	11.58	0.02	1.070	1.00	1.10	1.18
	WLAN5G	802.11a	Top Side	0	64	Sensor On	4	100	12.0	11.58	0.05	1.040	1.00	1.10	1.15
	WLAN5G	802.11a	Rear Face	0	100	Sensor On	1	100	11.5	11.28	0.01	0.395	1.00	1.05	0.42
	WLAN5G	802.11a	Right Side	0	100	Sensor On	1	100	11.5	11.28	0.07	0.127	1.00	1.05	0.13
	WLAN5G	802.11a	Top Side	0	100	Sensor On	1	100	11.5	11.28	0.06	0.926	1.00	1.05	0.97
	WLAN5G	802.11a	Rear Face	0.8	100	Sensor Off	1	100	20.0	19.34	0.04	0.796	1.00	1.16	0.93
	WLAN5G	802.11a	Right Side	0.3	100	Sensor Off	1	100	20.0	19.34	0.02	0.519	1.00	1.16	0.60
3	WLAN5G	802.11a	Top Side	1.2	100	Sensor Off	1	100	20.0	19.34	0.03	0.970	1.00	1.16	<b>1.13</b>
	WLAN5G	802.11a	Top Side	0	132	Sensor On	1	100	11.5	11.14	0.01	0.729	1.00	1.09	0.79
	WLAN5G	802.11a	Rear Face	0.8	116	Sensor Off	1	100	20.0	19.28	0.05	0.712	1.00	1.18	0.84
	WLAN5G	802.11a	Top Side	1.2	116	Sensor Off	1	100	20.0	19.28	-0.01	0.638	1.00	1.18	0.75
	WLAN5G	802.11a	Top Side	1.2	100	Sensor Off	2	100	20.0	19.34	0.01	0.388	1.00	1.16	0.45
	WLAN5G	802.11a	Top Side	1.2	100	Sensor Off	3	100	20.0	19.34	0.02	0.479	1.00	1.16	0.56
	WLAN5G	802.11a	Top Side	1.2	100	Sensor Off	4	100	20.0	19.34	-0.01	0.497	1.00	1.16	0.58
	WLAN5G	802.11a	Rear Face	0	165	Sensor On	1	100	12.0	11.54	0.02	0.525	1.00	1.11	0.58
	WLAN5G	802.11a	Right Side	0	165	Sensor On	1	100	12.0	11.54	0.09	0.141	1.00	1.11	0.16
	WLAN5G	802.11a	Top Side	0	165	Sensor On	1	100	12.0	11.54	0.03	1.060	1.00	1.11	1.18
	WLAN5G	802.11a	Rear Face	0.8	165	Sensor Off	1	100	20.0	19.23	0.09	0.812	1.00	1.19	0.97
	WLAN5G	802.11a	Right Side	0.3	165	Sensor Off	1	100	20.0	19.23	0.09	0.564	1.00	1.19	0.67
	WLAN5G	802.11a	Top Side	1.2	165	Sensor Off	1	100	20.0	19.23	-0.01	0.904	1.00	1.19	1.08
4	WLAN5G	802.11a	Top Side	0	149	Sensor On	1	100	12.0	11.37	0.01	1.030	1.00	1.16	<b>1.19</b>
	WLAN5G	802.11a	Rear Face	0.8	149	Sensor Off	1	100	20.0	19.18	-0.07	0.706	1.00	1.21	0.85
	WLAN5G	802.11a	Top Side	1.2	149	Sensor Off	1	100	20.0	19.18	0.01	0.966	1.00	1.21	1.17
	WLAN5G	802.11a	Top Side	0	149	Sensor On	2	100	12.0	11.37	0.05	0.564	1.00	1.16	0.65
	WLAN5G	802.11a	Top Side	0	149	Sensor On	3	100	12.0	11.37	0.09	0.616	1.00	1.16	0.71
	WLAN5G	802.11a	Top Side	0	149	Sensor On	4	100	12.0	11.37	0.03	0.511	1.00	1.16	0.59
5	BT	GFSK	Rear Face	0	78	Sensor Off	1	76.9	9.5	7.68	0.01	0.281	1.08	1.52	<b>0.43</b>
	BT	GFSK	Right Side	0	78	Sensor Off	1	76.9	9.5	7.68	0.01	0.085	1.08	1.52	0.13
	BT	GFSK	Top Side	0	78	Sensor Off	1	76.9	9.5	7.68	0.06	0.127	1.08	1.52	0.19
	BT	GFSK	Rear Face	0.8	78	Sensor Off	1	76.9	9.5	7.68	0.03	0.082	1.08	1.52	0.12
	BT	GFSK	Right Side	0.3	78	Sensor Off	1	76.9	9.5	7.68	-0.15	0.096	1.08	1.52	0.15
	BT	GFSK	Top Side	1.2	78	Sensor Off	1	76.9	9.5	7.68	0.07	0.037	1.08	1.52	0.06
	BT	GFSK	Rear Face	0	78	Sensor Off	2	76.9	9.5	7.68	0	0.255	1.08	1.52	0.39
	BT	GFSK	Rear Face	0	78	Sensor Off	3	76.9	9.5	7.68	0	0.238	1.08	1.52	0.36
	BT	GFSK	Rear Face	0	78	Sensor Off	4	76.9	9.5	7.68	0.07	0.267	1.08	1.52	0.41

## FCC SAR Test Report

### 4.6.3 SAR Measurement Variability

According to KDB 865664 D01, SAR measurement variability was assessed for each frequency band, which is determined by the SAR probe calibration point and tissue-equivalent medium used for the device measurements. When both head and body tissue-equivalent media are required for SAR measurements in a frequency band, the variability measurement procedures should be applied to the tissue medium with the highest measured SAR, using the highest measured SAR configuration for that tissue-equivalent medium. Alternatively, if the highest measured SAR for both head and body tissue-equivalent media are  $\leq 1.45$  W/kg and the ratio of these highest SAR values, i.e., largest divided by smallest value, is  $\leq 1.10$ , the highest SAR configuration for either head or body tissue-equivalent medium may be used to perform the repeated measurement. These additional measurements are repeated after the completion of all measurements requiring the same head or body tissue-equivalent medium in a frequency band. The test device should be returned to ambient conditions (normal room temperature) with the battery fully charged before it is re-mounted on the device holder for the repeated measurement(s) to minimize any unexpected variations in the repeated results.

SAR repeated measurement procedure:

1. When the highest measured SAR is  $< 0.80$  W/kg, repeated measurement is not required.
2. When the highest measured SAR is  $\geq 0.80$  W/kg, repeat that measurement once.
3. If the ratio of largest to smallest SAR for the original and first repeated measurements is  $> 1.20$ , or when the original or repeated measurement is  $\geq 1.45$  W/kg, perform a second repeated measurement.
4. If the ratio of largest to smallest SAR for the original, first and second repeated measurements is  $> 1.20$ , and the original, first or second repeated measurement is  $\geq 1.5$  W/kg, perform a third repeated measurement.

Band	Test Position	Ch.	Original Measured SAR-1g (W/kg)	1st Repeated SAR-1g (W/kg)	L/S Ratio	2nd Repeated SAR-1g (W/kg)	L/S Ratio	3rd Repeated SAR-1g (W/kg)	L/S Ratio
WLAN5G	Top Side	60	1.080	1.050	1.03	N/A	N/A	N/A	N/A
WLAN5G	Top Side	100	0.970	0.945	1.03	N/A	N/A	N/A	N/A
WLAN5G	Top Side	149	1.050	1.010	1.04	N/A	N/A	N/A	N/A

**4.6.4 Simultaneous Multi-band Transmission Evaluation**

**<SAR Summation Analysis>**

Simultaneous transmission SAR test exclusion is determined for each operating configuration and exposure condition according to the reported standalone SAR of each applicable simultaneous transmitting antenna. When the sum of SAR<sub>1g</sub> of all simultaneously transmitting antennas in an operating mode and exposure condition combination is within the SAR limit (SAR<sub>1g</sub> 1.6 W/kg), the simultaneous transmission SAR is not required. When the sum of SAR<sub>1g</sub> is greater than the SAR limit (SAR<sub>1g</sub> 1.6 W/kg), SAR test exclusion is determined by the SPLSR.

Exposure Position	2	3	4	3+4 Summed 1g SAR (W/kg)
	2.4GHz WLAN Ant 1	5GHz WLAN Ant 1	Bluetooth Ant 1	
	1g SAR (W/kg)	1g SAR (W/kg)	1g SAR (W/kg)	
Rear Face at 8 mm	0.93	0.97	0.12	<b>1.09</b>
Right Side at 3mm	1.10	0.97	0.05	<b>1.02</b>
Top Side at 12 mm	0.32	1.18	0.06	<b>1.24</b>
Rear Face at 0mm	0.75	0.58	0.43	<b>1.01</b>
Right Side at 0mm	0.40	0.23	0.13	<b>0.36</b>
Top Side at 0 mm	0.28	1.19	0.19	<b>1.38</b>

**Test Engineer** : Yuyu Lu, and Dennis Ye

## 5. Calibration of Test Equipment

Equipment	Manufacturer	Model	SN	Cal. Date	Cal. Interval
System Validation Dipole	SPEAG	D2450V2	893	Aug. 27, 2020	1 Year
System Validation Dipole	SPEAG	D5GHzV2	1133	Aug. 20, 2020	1 Year
Dielectric Probe Kit	SPEAG	DAK-3.5	1076	Aug. 19, 2020	1 Year
Dosimetric E-Field Probe	SPEAG	EX3DV4	3873	Aug. 27, 2020	1 Year
Data Acquisition Electronics	SPEAG	DAE4	1341	Aug. 26, 2020	1 Year
ENA Series Network Analyzer	Agilent	E5071C	MY46214638	Jun. 03, 2020	1 Year
Spectrum Analyzer	KEYSIGHT	N9010A	MY54510355	Jul. 08, 2020	1Year
MXG Analog Signal Generator	KEYSIGHT	N5183A	MY50143024	Mar. 09, 2021	1 Year
Power Sensor	R&S	NRP-Z21	105007	Oct. 14, 2020	1 Year
Power Meter	Agilent	N1914A	MY52180044	Mar. 02, 2021	1 Year
Power Sensor	Agilent	E9304A H18	MY52050011	Feb. 25, 2021	1 Year
Temp. & Humi. Recorder	CLOCK	HTC-1	157248	Jun. 07, 2020	1 Year
Electronic Thermometer	YONGFA	YF-160A	120100323	Jun. 07, 2020	1 Year
Coupler	Woken	0110A056020-10	COM27RW1A3	Jul. 01, 2020	1 Year

## 6. Measurement Uncertainty

DASY5 Uncertainty Budget								
Error Description	Uncertainty Value (±%)	Probability	Divisor	(Ci) 1g	(Ci) 10g	Standard Uncertainty (1g) (±%)	Standard Uncertainty (10g) (±%)	(Vi) Veff
<b>Measurement System</b>								
Probe Calibration	6.0	N	1	1	1	6.0	6.0	∞
Axial Isotropy	4.7	R	1.732	0.7	0.7	1.9	1.9	∞
Hemispherical Isotropy	9.6	R	1.732	0.7	0.7	3.9	3.9	∞
Boundary Effects	1.0	R	1.732	1	1	0.6	0.6	∞
Linearity	4.7	R	1.732	1	1	2.7	2.7	∞
System Detection Limits	1.0	R	1.732	1	1	0.6	0.6	∞
Modulation Response	3.2	R	1.732	1	1	1.8	1.8	∞
Readout Electronics	0.3	N	1	1	1	0.3	0.3	∞
Response Time	0.0	R	1.732	1	1	0.0	0.0	∞
Integration Time	2.6	R	1.732	1	1	1.5	1.5	∞
RF Ambient Noise	3.0	R	1.732	1	1	1.7	1.7	∞
RF Ambient Reflections	3.0	R	1.732	1	1	1.7	1.7	∞
Probe Positioner	0.4	R	1.732	1	1	0.2	0.2	∞
Probe Positioning	2.9	R	1.732	1	1	1.7	1.7	∞
Max. SAR Eval.	2.0	R	1.732	1	1	1.2	1.2	∞
<b>Test Sample Related</b>								
Device Positioning	3.0	N	1	1	1	3.0	3.0	35
Device Holder	3.6	N	1	1	1	3.6	3.6	12
Power Drift	5.0	R	1.732	1	1	2.9	2.9	∞
Power Scaling	0.0	R	1.732	1	1	0.0	0.0	∞
<b>Phantom and Setup</b>								
Phantom Uncertainty	6.1	R	1.732	1	1	3.5	3.5	∞
SAR correction	0.0	R	1.732	1	0.84	0.0	0.0	∞
Liquid Conductivity Repeatability	0.2	N	1	0.78	0.71	0.1	0.1	5
Liquid Conductivity (target)	5.0	R	1.732	0.78	0.71	2.3	2.0	∞
Liquid Conductivity (mea.)	2.5	R	1.732	0.78	0.71	1.1	1.0	∞
Temp. unc. - Conductivity	3.4	R	1.732	0.78	0.71	1.5	1.4	∞
Liquid Permittivity Repeatability	0.15	N	1	0.23	0.26	0.0	0.0	5
Liquid Permittivity (target)	5.0	R	1.732	0.23	0.26	0.7	0.8	∞
Liquid Permittivity (mea.)	2.5	R	1.732	0.23	0.26	0.3	0.4	∞
Temp. unc. - Permittivity	0.83	R	1.732	0.23	0.26	0.1	0.1	∞
<b>Combined Std. Uncertainty</b>						11.4%	11.4%	1013
<b>Coverage Factor for 95 %</b>						K=2	K=2	
<b>Expanded STD Uncertainty</b>						22.9%	22.7%	

Uncertainty budget for frequency range 30 MHz to 3 GHz

# FCC SAR Test Report

DASY5 Uncertainty Budget								
Error Description	Uncertainty Value (±%)	Probability	Divisor	(Ci) 1g	(Ci) 10g	Standard Uncertainty (1g) (±%)	Standard Uncertainty (10g) (±%)	(Vi) Veff
<b>Measurement System</b>								
Probe Calibration	6.55	N	1	1	1	6.5	6.5	∞
Axial Isotropy	4.7	R	1.732	0.7	0.7	1.9	1.9	∞
Hemispherical Isotropy	9.6	R	1.732	0.7	0.7	3.9	3.9	∞
Boundary Effects	2.0	R	1.732	1	1	1.2	1.2	∞
Linearity	4.7	R	1.732	1	1	2.7	2.7	∞
System Detection Limits	1.0	R	1.732	1	1	0.6	0.6	∞
Modulation Response	3.2	R	1.732	1	1	1.8	1.8	∞
Readout Electronics	0.3	N	1	1	1	0.3	0.3	∞
Response Time	0.0	R	1.732	1	1	0.0	0.0	∞
Integration Time	2.6	R	1.732	1	1	1.5	1.5	∞
RF Ambient Noise	3.0	R	1.732	1	1	1.7	1.7	∞
RF Ambient Reflections	3.0	R	1.732	1	1	1.7	1.7	∞
Probe Positioner	0.4	R	1.732	1	1	0.2	0.2	∞
Probe Positioning	6.7	R	1.732	1	1	3.9	3.9	∞
Max. SAR Eval.	4.0	R	1.732	1	1	2.3	2.3	∞
<b>Test Sample Related</b>								
Device Positioning	3.0	N	1	1	1	3.0	3.0	35
Device Holder	3.6	N	1	1	1	3.6	3.6	12
Power Drift	5.0	R	1.732	1	1	2.9	2.9	∞
Power Scaling	0.0	R	1.732	1	1	0.0	0.0	∞
<b>Phantom and Setup</b>								
Phantom Uncertainty	6.6	R	1.732	1	1	3.8	3.8	∞
SAR correction	0.0	R	1.732	1	0.84	0.0	0.0	∞
Liquid Conductivity Repeatability	0.2	N	1	0.78	0.71	0.1	0.1	5
Liquid Conductivity (target)	5.0	R	1.732	0.78	0.71	2.3	2.0	∞
Liquid Conductivity (mea.)	2.5	R	1.732	0.78	0.71	1.1	1.0	∞
Temp. unc. - Conductivity	3.4	R	1.732	0.78	0.71	1.5	1.4	∞
Liquid Permittivity Repeatability	0.15	N	1	0.23	0.26	0.0	0.0	5
Liquid Permittivity (target)	5.0	R	1.732	0.23	0.26	0.7	0.8	∞
Liquid Permittivity (mea.)	2.5	R	1.732	0.23	0.26	0.3	0.4	∞
Temp. unc. - Permittivity	0.83	R	1.732	0.23	0.26	0.1	0.1	∞
<b>Combined Std. Uncertainty</b>						12.5%	12.5%	1458
<b>Coverage Factor for 95 %</b>						K=2	K=2	
<b>Expanded STD Uncertainty</b>						25.0%	24.9%	

## Uncertainty budget for frequency range 3 GHz to 6 GHz



## **7. Information on the Testing Laboratories**

We, BV 7LAYERS COMMUNICATIONS TECHNOLOGY (SHENZHEN) CO. LTD., were founded in 2015 to provide our best service in EMC, Radio, Telecom and Safety consultation. Our laboratories are accredited and approved according to ISO/IEC 17025.

If you have any comments, please feel free to contact us at the following:

Add: No. B102, Dazu Chuangxin Mansion, North of Beihuan Avenue, North Area, Hi-Tech Industry Park, Nanshan District, Shenzhen, Guangdong, China

Tel: 86-755-8869-6566

Fax: 86-755-8869-6577

**Email:** [customerservice.SW@cn.bureauveritas.com](mailto:customerservice.SW@cn.bureauveritas.com)

**Web Site:** [www.bureauveritas.com](http://www.bureauveritas.com)

The road map of all our labs can be found in our web site also.

---END---

## **Appendix A. SAR Plots of System Verification**

The plots for system verification with largest deviation for each SAR system combination are shown as follows.

## System Check\_HSL2450\_210306

**DUT: Dipole:2450 MHz;Type:D2450V2**

Communication System: CW; Frequency: 2450 MHz;Duty Cycle: 1:1

Medium: HSL2450\_0306 Medium parameters used:  $f = 2450$  MHz;  $\sigma = 1.786$  S/m;  $\epsilon_r = 40.18$ ;  $\rho = 1000$  kg/m<sup>3</sup>

Ambient Temperature : 23.4°C; Liquid Temperature : 22.5°C

DASY5 Configuration:

- Probe: EX3DV4 - SN3873; ConvF(7.27, 7.27, 7.27); Calibrated: 2020/08/27;
- Sensor-Surface: 1.4mm (Mechanical Surface Detection)
- Electronics: DAE4 Sn1341; Calibrated: 2020/08/26
- Phantom: ELI v5.0; Type: QDOVA002AA; Serial: TP:1205
- Measurement SW: DASY52, Version 52.8 (8); SEMCAD X Version 14.6.10 (7331)

**Pin=250mW/Area Scan (81x81x1):** Interpolated grid: dx=1.200 mm, dy=1.200 mm  
Maximum value of SAR (interpolated) = 23.5 W/kg

**Pin=250mW/Zoom Scan (7x7x7)/Cube 0:** Measurement grid: dx=5mm, dy=5mm, dz=5mm

Reference Value = 111.6 V/m; Power Drift = 0.07 dB

Peak SAR (extrapolated) = 29.4 W/kg

**SAR(1 g) = 14.3 W/kg; SAR(10 g) = 6.54 W/kg**

Maximum value of SAR (measured) = 23.9 W/kg

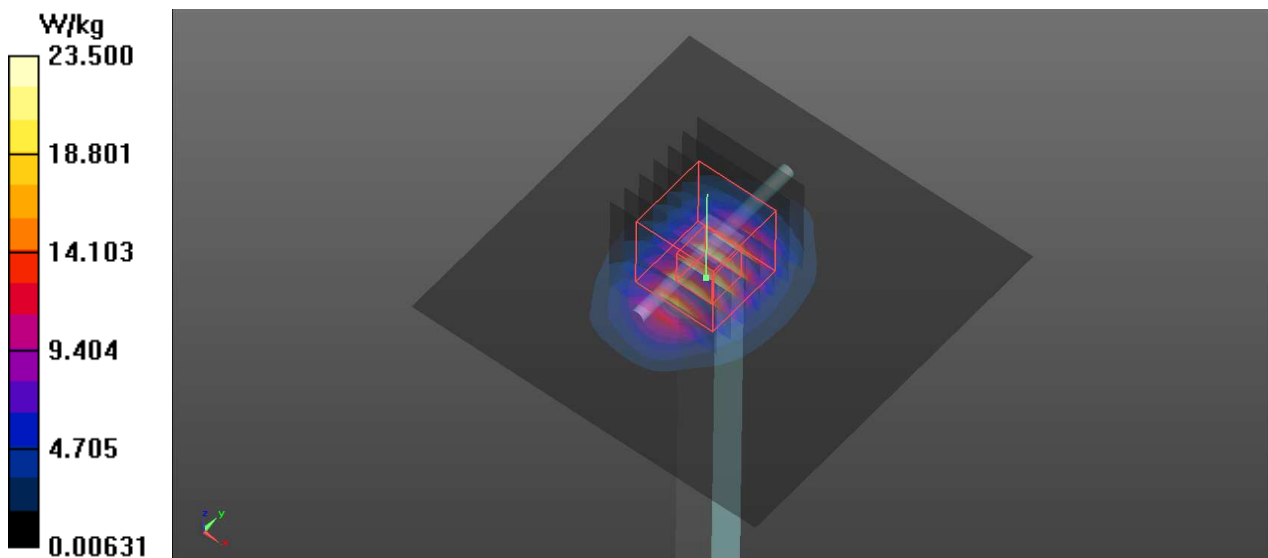

## System Check\_HSL5250\_210310

### DUT: Dipole 5GHzV2;Type:D5GHzV2

Communication System: CW; Frequency: 5250 MHz;Duty Cycle: 1:1

Medium: HSL5G\_0310 Medium parameters used:  $f = 5250$  MHz;  $\sigma = 4.721$  S/m;  $\epsilon_r = 37.228$ ;  $\rho = 1000$  kg/m<sup>3</sup>

Ambient Temperature : 23.6°C; Liquid Temperature : 22.6°C

#### DASY5 Configuration:

- Probe: EX3DV4 - SN3873; ConvF(4.8, 4.8, 4.8); Calibrated: 2020/08/27;
- Sensor-Surface: 1.4mm (Mechanical Surface Detection)
- Electronics: DAE4 Sn1341; Calibrated: 2020/08/26
- Phantom: ELI v5.0; Type: QDOVA002AA; Serial: TP:1205
- Measurement SW: DASY52, Version 52.8 (8); SEMCAD X Version 14.6.10 (7331)

**Pin=100mW/Area Scan (91x91x1):** Interpolated grid: dx=1.000 mm, dy=1.000 mm

Maximum value of SAR (interpolated) = 19.3 W/kg

**Pin=100mW/Zoom Scan (7x7x12)/Cube 0:** Measurement grid: dx=4mm, dy=4mm, dz=2mm

Reference Value = 63.18 V/m; Power Drift = -0.11 dB

Peak SAR (extrapolated) = 32.8 W/kg

**SAR(1 g) = 8.43 W/kg; SAR(10 g) = 2.42 W/kg**

Maximum value of SAR (measured) = 20.9 W/kg

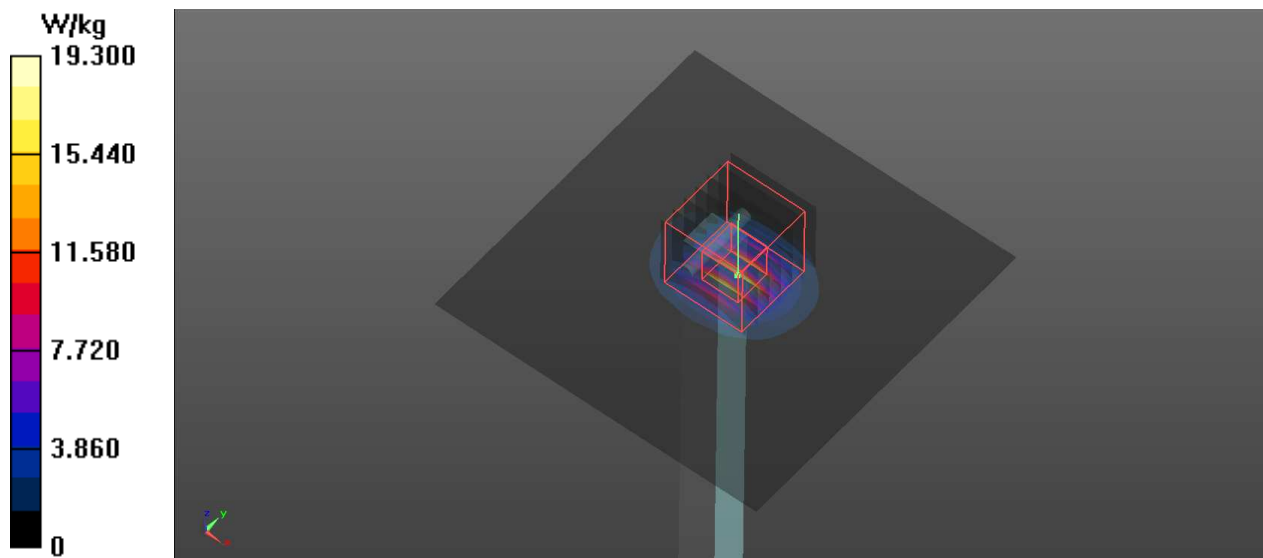

## System Check\_HSL5600\_210315

### DUT: Dipole 5GHzV2;Type:D5GHzV2

Communication System: CW; Frequency: 5600 MHz;Duty Cycle: 1:1

Medium: HSL5G\_0315 Medium parameters used:  $f = 5600$  MHz;  $\sigma = 5.051$  S/m;  $\epsilon_r = 36.822$ ;  $\rho = 1000$  kg/m<sup>3</sup>

Ambient Temperature : 23.6°C; Liquid Temperature : 22.4°C

#### DASY5 Configuration:

- Probe: EX3DV4 - SN3873; ConvF(4.5, 4.5, 4.5); Calibrated: 2020/08/27;
- Sensor-Surface: 1.4mm (Mechanical Surface Detection)
- Electronics: DAE4 Sn1341; Calibrated: 2020/08/26
- Phantom: ELI v5.0; Type: QDOVA002AA; Serial: TP:1205
- Measurement SW: DASY52, Version 52.8 (8); SEMCAD X Version 14.6.10 (7331)

**Pin=100mW/Area Scan (91x91x1):** Interpolated grid: dx=1.000 mm, dy=1.000 mm

Maximum value of SAR (interpolated) = 21.2 W/kg

**Pin=100mW/Zoom Scan (7x7x12)/Cube 0:** Measurement grid: dx=4mm, dy=4mm, dz=2mm

Reference Value = 64.02 V/m; Power Drift = -0.08 dB

Peak SAR (extrapolated) = 38.6 W/kg

**SAR(1 g) = 8.97 W/kg; SAR(10 g) = 2.53 W/kg**

Maximum value of SAR (measured) = 23.1 W/kg

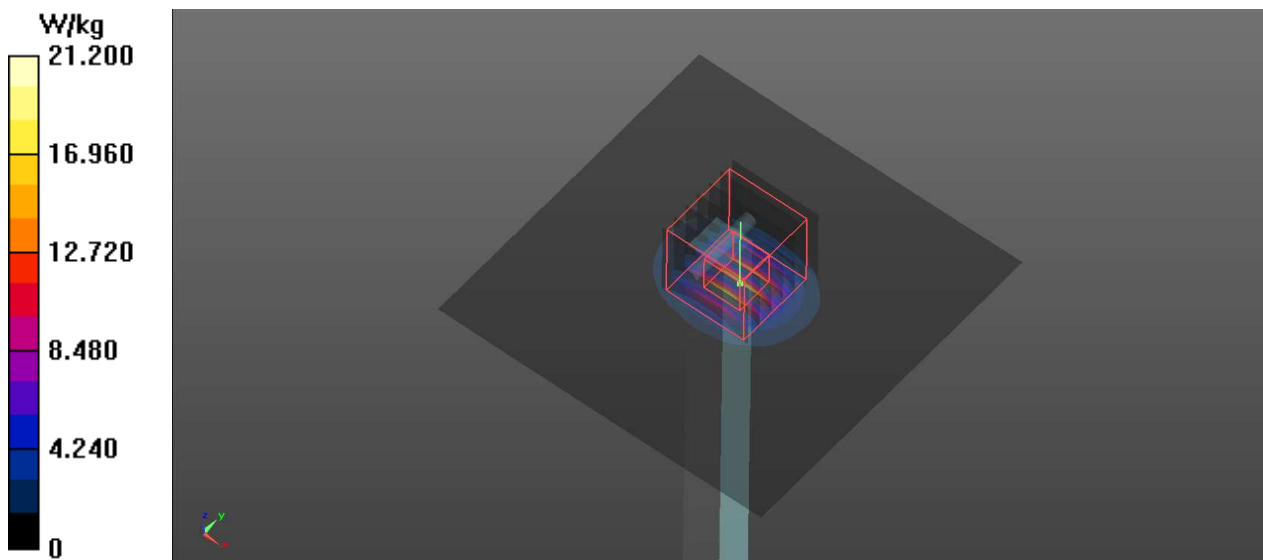

## System Check\_HSL5800\_210320

### DUT: Dipole 5GHzV2;Type:D5GHzV2

Communication System: CW; Frequency: 5800 MHz;Duty Cycle: 1:1

Medium: HSL5G\_0320 Medium parameters used:  $f = 5800$  MHz;  $\sigma = 5.21$  S/m;  $\epsilon_r = 36.661$ ;  $\rho = 1000$  kg/m<sup>3</sup>

Ambient Temperature : 23.3°C; Liquid Temperature : 22.6°C

#### DASY5 Configuration:

- Probe: EX3DV4 - SN3873; ConvF(4.49, 4.49, 4.49); Calibrated: 2020/08/27;
- Sensor-Surface: 1.4mm (Mechanical Surface Detection)
- Electronics: DAE4 Sn1341; Calibrated: 2020/08/26
- Phantom: ELI v5.0; Type: QDOVA002AA; Serial: TP:1205
- Measurement SW: DASY52, Version 52.8 (8); SEMCAD X Version 14.6.10 (7331)

**Pin=100mW/Area Scan (91x91x1):** Interpolated grid: dx=1.000 mm, dy=1.000 mm

Maximum value of SAR (interpolated) = 20.2 W/kg

**Pin=100mW/Zoom Scan (7x7x11)/Cube 0:** Measurement grid: dx=4mm, dy=4mm, dz=2mm

Reference Value = 60.04 V/m; Power Drift = -0.06 dB

Peak SAR (extrapolated) = 37.5 W/kg

**SAR(1 g) = 8.24 W/kg; SAR(10 g) = 2.31 W/kg**

Maximum value of SAR (measured) = 21.7 W/kg

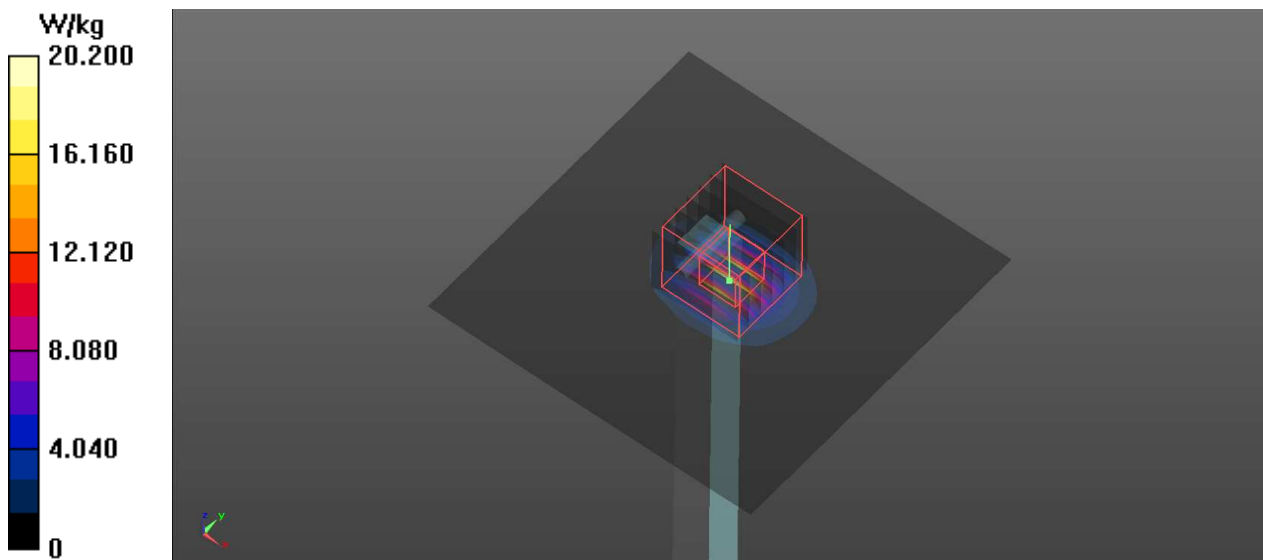

## Appendix B. SAR Plots of SAR Measurement

The SAR plots for highest measured SAR in each exposure configuration, wireless mode and frequency band combination, and measured SAR > 1.5 W/kg are shown as follows.

### P01 WLAN2.4G\_802.11b\_Right Side\_0.3cm\_Ch11

Communication System: 802.11b; Frequency: 2462 MHz; Duty Cycle: 1:1  
Medium: HSL2450\_0306 Medium parameters used:  $f = 2462$  MHz;  $\sigma = 1.798$  S/m;  $\epsilon_r = 40.18$ ;  $\rho = 1000$  kg/m<sup>3</sup>  
Ambient Temperature : 23.4°C; Liquid Temperature : 22.5°C

#### DASY5 Configuration:

- Probe: EX3DV4 - SN3873; ConvF(7.27, 7.27, 7.27); Calibrated: 2020/08/27;
- Sensor-Surface: 1.4mm (Mechanical Surface Detection)
- Electronics: DAE4 Sn1341; Calibrated: 2020/08/26
- Phantom: ELI v5.0; Type: QDOVA002AA; Serial: TP:1205
- Measurement SW: DASY52, Version 52.8 (8); SEMCAD X Version 14.6.10 (7331)

- **Area Scan (41x91x1):** Interpolated grid: dx=1.200 mm, dy=1.200 mm  
Maximum value of SAR (interpolated) = 1.40 W/kg

- **Zoom Scan (7x7x7)/Cube 0:** Measurement grid: dx=5mm, dy=5mm, dz=5mm  
Reference Value = 8.715 V/m; Power Drift = -0.02 dB  
Peak SAR (extrapolated) = 1.71 W/kg  
**SAR(1 g) = 0.759 W/kg; SAR(10 g) = 0.338 W/kg**  
Maximum value of SAR (measured) = 1.32 W/kg

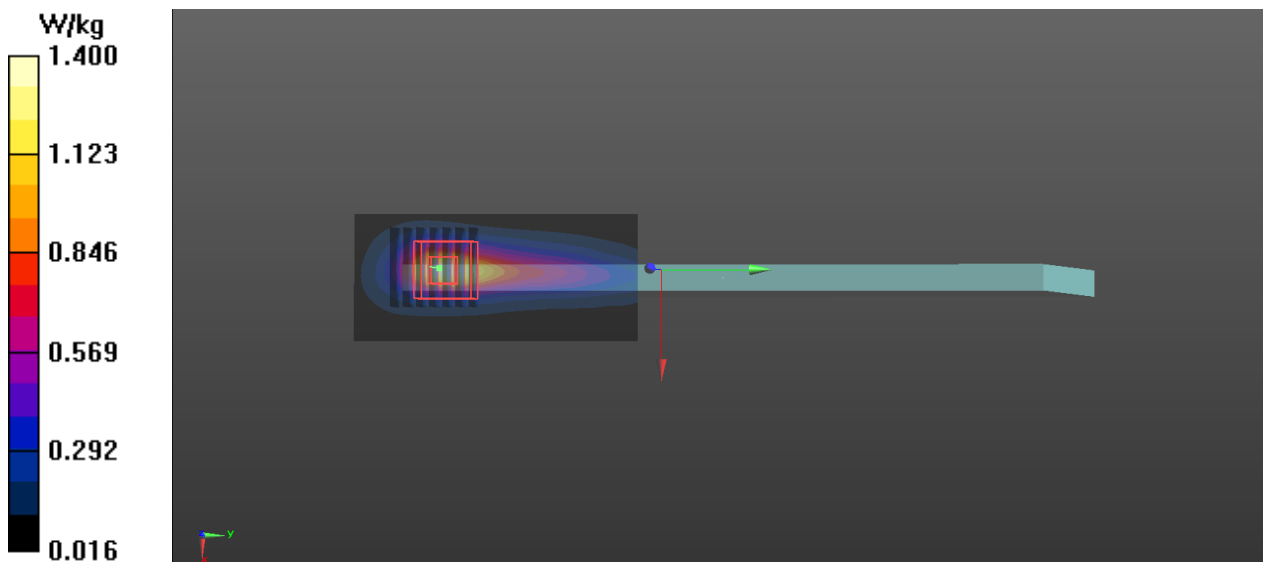



### P02 WLAN5G\_802.11a\_Top Side\_0cm\_Ch64

Communication System: 802.11a; Frequency: 5320 MHz; Duty Cycle: 1:1  
Medium: HSL5G\_0310 Medium parameters used:  $f = 5320$  MHz;  $\sigma = 4.797$  S/m;  $\epsilon_r = 37.226$ ;  $\rho = 1000$  kg/m<sup>3</sup>  
Ambient Temperature : 23.6°C; Liquid Temperature : 22.6°C

#### DASY5 Configuration:

- Probe: EX3DV4 - SN3873; ConvF(4.8, 4.8, 4.8); Calibrated: 2020/08/27;
- Sensor-Surface: 1.4mm (Mechanical Surface Detection)
- Electronics: DAE4 Sn1341; Calibrated: 2020/08/26
- Phantom: ELI v5.0; Type: QDOVA002AA; Serial: TP:1205
- Measurement SW: DASY52, Version 52.8 (8); SEMCAD X Version 14.6.10 (7331)

- **Area Scan (41x91x1):** Interpolated grid: dx=1.000 mm, dy=1.000 mm  
Maximum value of SAR (interpolated) = 2.97 W/kg

- **Zoom Scan (7x7x12)/Cube 0:** Measurement grid: dx=4mm, dy=4mm, dz=2mm  
Reference Value = 1.640 V/m; Power Drift = 0.00 dB  
Peak SAR (extrapolated) = 5.33 W/kg  
**SAR(1 g) = 1.08 W/kg; SAR(10 g) = 0.229 W/kg**  
Maximum value of SAR (measured) = 3.09 W/kg

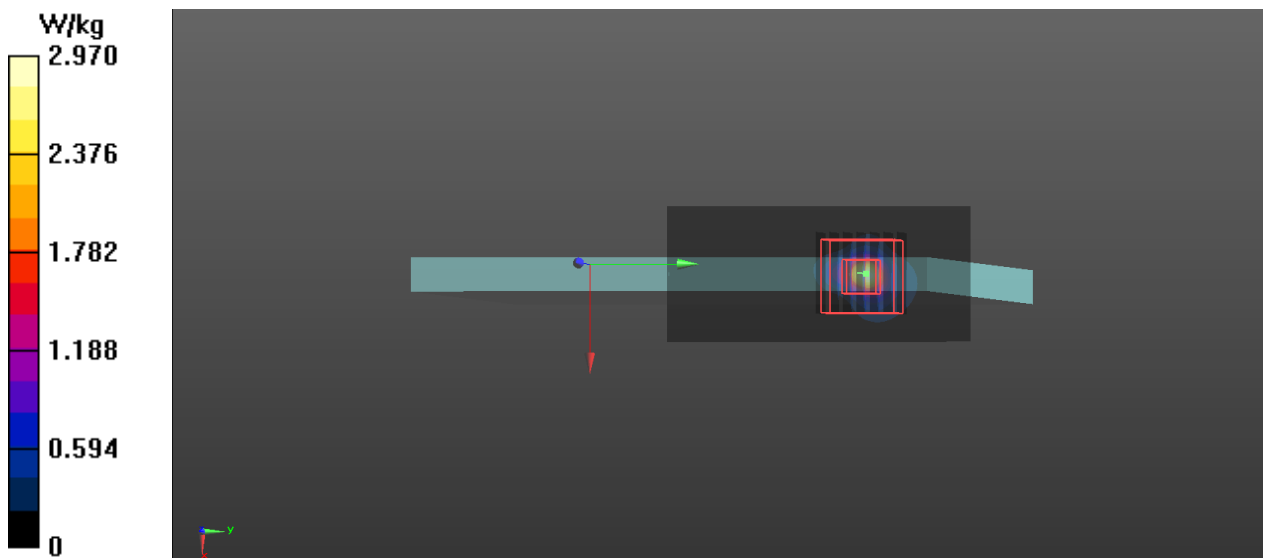

### P03 WLAN5G\_802.11a\_Top Side\_1.2cm\_Ch100

Communication System: 802.11a; Frequency: 5500 MHz; Duty Cycle: 1:1  
Medium: HSL5G\_0315 Medium parameters used:  $f = 5500$  MHz;  $\sigma = 4.961$  S/m;  $\epsilon_r = 36.968$ ;  $\rho = 1000$  kg/m<sup>3</sup>  
Ambient Temperature : 23.6°C; Liquid Temperature : 22.4°C

#### DASY5 Configuration:

- Probe: EX3DV4 - SN3873; ConvF(4.5, 4.5, 4.5); Calibrated: 2020/08/27;
- Sensor-Surface: 1.4mm (Mechanical Surface Detection)
- Electronics: DAE4 Sn1341; Calibrated: 2020/08/26
- Phantom: ELI v5.0; Type: QDOVA002AA; Serial: TP:1205
- Measurement SW: DASY52, Version 52.8 (8); SEMCAD X Version 14.6.10 (7331)

- **Area Scan (41x91x1):** Interpolated grid:  $dx=1.000$  mm,  $dy=1.000$  mm  
Maximum value of SAR (interpolated) = 2.41 W/kg

- **Zoom Scan (7x7x12)/Cube 0:** Measurement grid:  $dx=4$ mm,  $dy=4$ mm,  $dz=2$ mm  
Reference Value = 0.7230 V/m; Power Drift = 0.03 dB  
Peak SAR (extrapolated) = 3.80 W/kg  
**SAR(1 g) = 0.97 W/kg; SAR(10 g) = 0.400 W/kg**  
Maximum value of SAR (measured) = 2.39 W/kg

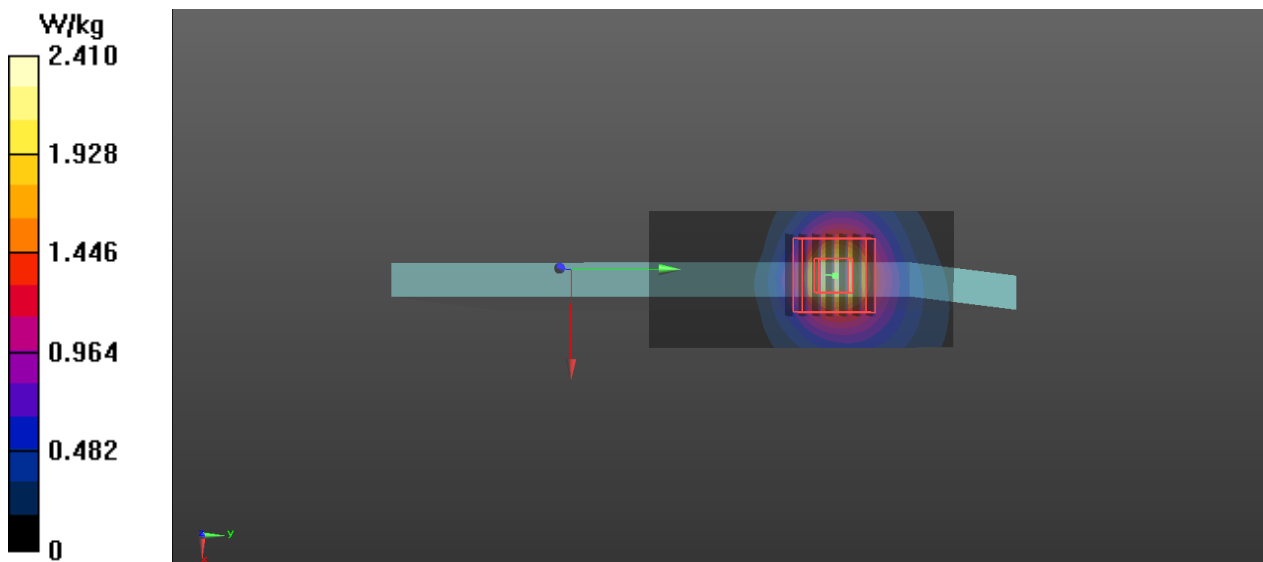

## P04 WLAN5G\_802.11a\_Top Side\_0cm\_Ch149

Communication System: 802.11a ; Frequency: 5745 MHz;Duty Cycle: 1:1

Medium: HSL5G\_0320 Medium parameters used:  $f = 5745$  MHz;  $\sigma = 5.217$  S/m;  $\epsilon_r = 36.632$ ;  $\rho = 1000$  kg/m<sup>3</sup>

Ambient Temperature : 23.3°C; Liquid Temperature : 22.6°C

DASY5 Configuration:

- Probe: EX3DV4 - SN3873; ConvF(4.49, 4.49, 4.49); Calibrated: 2020/08/27;
- Sensor-Surface: 1.4mm (Mechanical Surface Detection)
- Electronics: DAE4 Sn1341; Calibrated: 2020/08/26
- Phantom: ELI v5.0; Type: QDOVA002AA; Serial: TP:1205
- Measurement SW: DASY52, Version 52.8 (8); SEMCAD X Version 14.6.10 (7331)

- **Area Scan (41x91x1)**: Interpolated grid: dx=1.000 mm, dy=1.000 mm

Maximum value of SAR (interpolated) = 2.23 W/kg

- **Zoom Scan (7x7x12)/Cube 0**: Measurement grid: dx=4mm, dy=4mm, dz=2mm

Reference Value = 1.722 V/m; Power Drift = 0.01 dB

Peak SAR (extrapolated) = 5.56 W/kg

**SAR(1 g) = 1.03 W/kg; SAR(10 g) = 0.215 W/kg**

Maximum value of SAR (measured) = 2.86 W/kg

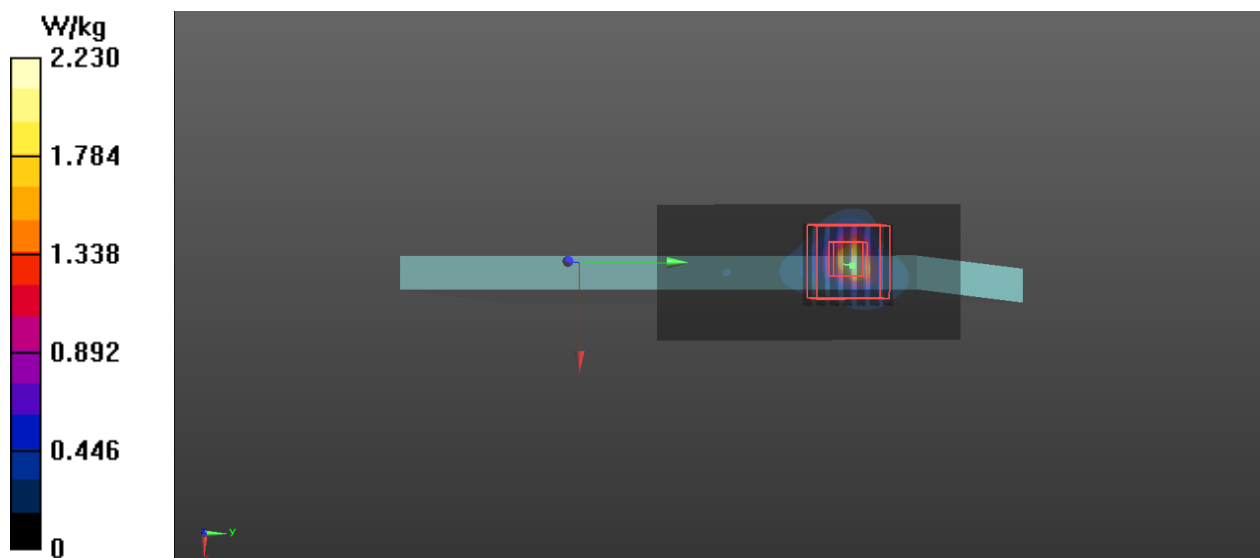

### P05 BT\_GFSK\_Rear Face\_0cm\_Ch78

Communication System: BT; Frequency: 2480 MHz; Duty Cycle: 1:1.08  
Medium: HSL2450\_0306 Medium parameters used:  $f = 2480$  MHz;  $\sigma = 1.818$  S/m;  $\epsilon_r = 40.137$ ;  $\rho = 1000$  kg/m<sup>3</sup>  
Ambient Temperature : 23.4°C; Liquid Temperature : 22.5°C

#### DASY5 Configuration:

- Probe: EX3DV4 - SN3873; ConvF(7.27, 7.27, 7.27); Calibrated: 2020/08/27;
- Sensor-Surface: 1.4mm (Mechanical Surface Detection)
- Electronics: DAE4 Sn1341; Calibrated: 2020/08/26
- Phantom: ELI v5.0; Type: QDOVA002AA; Serial: TP:1205
- Measurement SW: DASY52, Version 52.8 (8); SEMCAD X Version 14.6.10 (7331)

- **Area Scan (81x81x1):** Interpolated grid: dx=1.200 mm, dy=1.200 mm  
Maximum value of SAR (interpolated) = 0.637 W/kg

- **Zoom Scan (7x7x7)/Cube 0:** Measurement grid: dx=5mm, dy=5mm, dz=5mm  
Reference Value = 0 V/m; Power Drift = 0.01 dB  
Peak SAR (extrapolated) = 0.786 W/kg  
**SAR(1 g) = 0.281 W/kg; SAR(10 g) = 0.111 W/kg**  
Maximum value of SAR (measured) = 0.557 W/kg

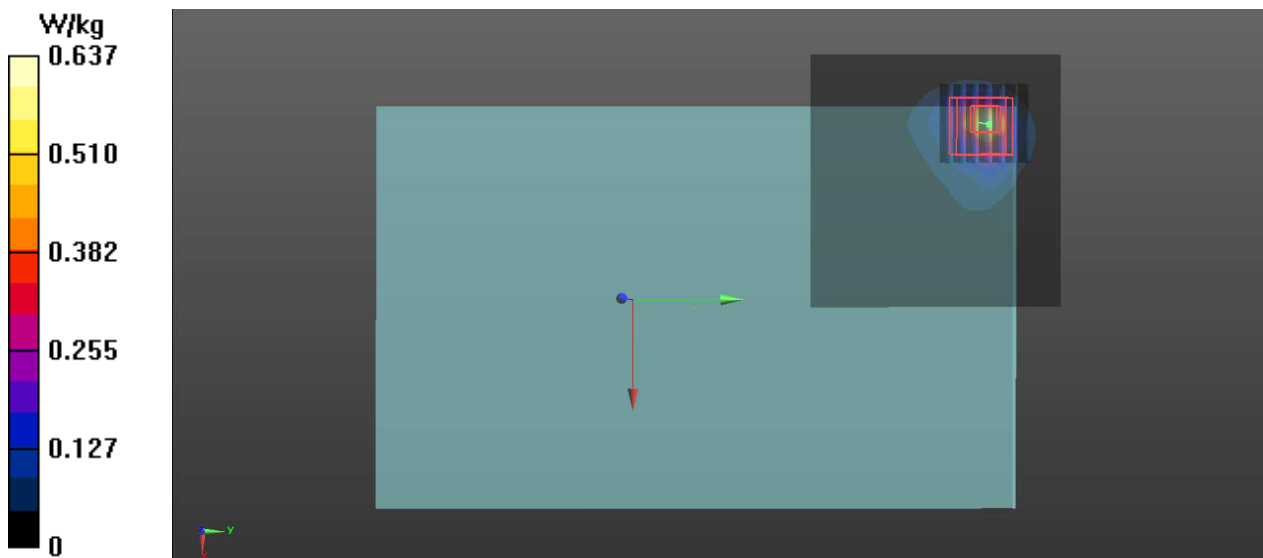

## Appendix C. Calibration Certificate for Probe and Dipole

The SPEAG calibration certificates are shown as follows.



In Collaboration with  
**s p e a g**  
CALIBRATION LABORATORY



中国认可  
国际互认  
校准  
CALIBRATION  
CNAS L0570

Add: No.51 Xueyuan Road, Haidian District, Beijing, 100191, China  
Tel: +86-10-62304633-2079 Fax: +86-10-62304633-2504  
E-mail: cttl@chinattl.com http://www.chinattl.cn

Client **ADT**

Certificate No: **Z20-60321**

## CALIBRATION CERTIFICATE

Object **D2450V2 - SN: 893**

Calibration Procedure(s) **FF-Z11-003-01**  
Calibration Procedures for dipole validation kits

Calibration date: **August 27, 2020**

This calibration Certificate documents the traceability to national standards, which realize the physical units of measurements(SI). The measurements and the uncertainties with confidence probability are given on the following pages and are part of the certificate.

All calibrations have been conducted in the closed laboratory facility: environment temperature(22±3)°C and humidity<70%.

Calibration Equipment used (M&TE critical for calibration)

Primary Standards	ID #	Cal Date(Calibrated by, Certificate No.)	Scheduled Calibration
Power Meter NRP2	106276	12-May-20 (CTTL, No.J20X02965)	May-21
Power sensor NRP6A	101369	12-May-20 (CTTL, No.J20X02965)	May-21
ReferenceProbe EX3DV4	SN 3617	30-Jan-20(SPEAG,No.EX3-3617_Jan20)	Jan-21
DAE4	SN 771	10-Feb-20(CTTL-SPEAG,No.Z20-60017)	Feb-21
Secondary Standards	ID #	Cal Date(Calibrated by, Certificate No.)	Scheduled Calibration
Signal Generator E4438C	MY49071430	25-Feb-20 (CTTL, No.J20X00516)	Feb-21
NetworkAnalyzer E5071C	MY46110673	10-Feb-20 (CTTL, No.J20X00515)	Feb-21

	Name	Function	Signature
Calibrated by:	Zhao Jing	SAR Test Engineer	
Reviewed by:	Lin Hao	SAR Test Engineer	
Approved by:	Qi Dianyuan	SAR Project Leader	

Issued: September 2, 2020

This calibration certificate shall not be reproduced except in full without written approval of the laboratory.



Add: No.51 Xueyuan Road, Haidian District, Beijing, 100191, China  
Tel: +86-10-62304633-2079 Fax: +86-10-62304633-2504  
E-mail: cttl@chinattl.com http://www.chinattl.cn

### Glossary:

TSL	tissue simulating liquid
ConvF	sensitivity in TSL / NORM <sub>x,y,z</sub>
N/A	not applicable or not measured

### Calibration is Performed According to the Following Standards:

- IEEE Std 1528-2013, "IEEE Recommended Practice for Determining the Peak Spatial-Averaged Specific Absorption Rate (SAR) in the Human Head from Wireless Communications Devices: Measurement Techniques", June 2013
- IEC 62209-1, "Measurement procedure for assessment of specific absorption rate of human exposure to radio frequency fields from hand-held and body-mounted wireless communication devices- Part 1: Device used next to the ear (Frequency range of 300MHz to 6GHz)", July 2016
- IEC 62209-2, "Procedure to measure the Specific Absorption Rate (SAR) For wireless communication devices used in close proximity to the human body (frequency range of 30MHz to 6GHz)", March 2010
- KDB865664, SAR Measurement Requirements for 100 MHz to 6 GHz

### Additional Documentation:

- DASY4/5 System Handbook

### Methods Applied and Interpretation of Parameters:

- Measurement Conditions:* Further details are available from the Validation Report at the end of the certificate. All figures stated in the certificate are valid at the frequency indicated.
- Antenna Parameters with TSL:* The dipole is mounted with the spacer to position its feed point exactly below the center marking of the flat phantom section, with the arms oriented parallel to the body axis.
- Feed Point Impedance and Return Loss:* These parameters are measured with the dipole positioned under the liquid filled phantom. The impedance stated is transformed from the measurement at the SMA connector to the feed point. The Return Loss ensures low reflected power. No uncertainty required.
- Electrical Delay:* One-way delay between the SMA connector and the antenna feed point. No uncertainty required.
- SAR measured:* SAR measured at the stated antenna input power.
- SAR normalized:* SAR as measured, normalized to an input power of 1 W at the antenna connector.
- SAR for nominal TSL parameters:* The measured TSL parameters are used to calculate the nominal SAR result.

The reported uncertainty of measurement is stated as the standard uncertainty of Measurement multiplied by the coverage factor  $k=2$ , which for a normal distribution Corresponds to a coverage probability of approximately 95%.