

FCC TEST REPORT (PART 24)



Applicant:	Lenovo(Shanghai) Electronics Technology Co., Ltd.
Address:	Section 304-305, Building No. 4, # 222, Meiyue Road, China (Shanghai) Pilot Free Trade Zone

Manufacturer or Supplier	Lenovo PC HK Limited
Address	23/F, Lincoln House, Taikoo Place 979 King's Road, Quarry Bay, Hong Kong
Product	Portable Tablet Computer
Brand Name	Lenovo
Model Name	Lenovo TB-X605LC
FCC ID	O57TBX605LC
Date of tests	Sep. 19, 2020 ~ Oct. 22, 2020

The tests have been carried out according to the requirements of the following standard:

- FCC PART 24, Subpart E** **FCC PART 2**
 ANSI/TIA/EIA-603-D **ANSI/TIA/EIA-603-E** **ANSI C63.26-2015**

CONCLUSION: The submitted sample was found to COMPLY with the test requirement

Prepared by Alex Chen Engineer / Mobile Department	Approved by Luke Lu Manager / Mobile Department
	
Date: Oct. 23, 2020	Date: Oct. 23, 2020

This report is governed by, and incorporates by reference, CPS Conditions of Service as posted at the date of issuance of this report at <http://www.bureauveritas.com/home/about-us/our-business/cps/about-us/terms-conditions> and is intended for your exclusive use. Any copying or replication of this report to or for any other person or entity, or use of our name or trademark, is permitted only with our prior written permission. This report sets forth our findings solely with respect to the test samples identified herein. The results set forth in this report are not indicative or representative of the quality or characteristics of the lot from which a test sample was taken or any similar or identical product unless specifically and expressly noted. Our report includes all of the tests requested by you and the results thereof based upon the information that you provided to us. Measurement uncertainty is only provided upon request for accredited tests. You have 60 days from date of issuance of this report to notify us of any material error or omission caused by our negligence or if you require measurement uncertainty; provided, however, that such notice shall be in writing and shall specifically address the issue you wish to raise. A failure to raise such issue within the prescribed time shall constitute your unqualified acceptance of the completeness of this report, the tests conducted and the correctness of the report contents.



TABLE OF CONTENTS

RELEASE CONTROL RECORD 4

1 SUMMARY OF TEST RESULTS 5

1.1 MEASUREMENT UNCERTAINTY 5

1.2 TEST SITE AND INSTRUMENTS 6

2 GENERAL INFORMATION 7

2.1 GENERAL DESCRIPTION OF EUT 7

2.2 CONFIGURATION OF SYSTEM UNDER TEST 9

2.3 DESCRIPTION OF SUPPORT UNITS 10

2.4 TEST ITEM AND TEST CONFIGURATION 10

2.5 EUT OPERATING CONDITIONS 11

2.6 GENERAL DESCRIPTION OF APPLIED STANDARDS 11

3 TEST TYPES AND RESULTS 12

3.1 OUTPUT POWER MEASUREMENT 12

3.1.1 LIMITS OF OUTPUT POWER MEASUREMENT 12

3.1.2 TEST PROCEDURES 12

3.1.3 TEST SETUP 13

3.1.4 TEST RESULTS 13

3.2 FREQUENCY STABILITY MEASUREMENT 15

3.2.1 LIMITS OF FREQUENCY STABILITY MEASUREMENT 15

3.2.2 TEST PROCEDURE 15

3.2.3 TEST SETUP 15

3.2.4 TEST RESULTS 16

3.3 OCCUPIED BANDWIDTH MEASUREMENT 17

3.3.1 TEST PROCEDURES 17

3.3.2 TEST SETUP 17

3.3.3 TEST RESULTS 18

3.4 BAND EDGE MEASUREMENT 19

3.4.1 LIMITS OF BAND EDGE MEASUREMENT 19

3.4.2 TEST SETUP 19

3.4.3 TEST PROCEDURES 20

3.4.4 TEST RESULTS 21

3.5 CONDUCTED SPURIOUS EMISSIONS 22

3.5.1 LIMITS OF CONDUCTED SPURIOUS EMISSIONS MEASUREMENT 22

3.5.2 TEST PROCEDURE 22

3.5.3 TEST SETUP 22

3.5.4 TEST RESULTS 23

3.6 RADIATED EMISSION MEASUREMENT 24

3.6.1 LIMITS OF RADIATED EMISSION MEASUREMENT 24

3.6.2 TEST PROCEDURES 24

3.6.3 DEVIATION FROM TEST STANDARD 24

3.6.4 TEST SETUP 25

3.6.5 TEST RESULTS 26

3.7 PEAK TO AVERAGE RATIO 34

3.7.1 LIMITS OF PEAK TO AVERAGE RATIO MEASUREMENT 34

3.7.2 TEST SETUP 34

3.7.3 TEST PROCEDURES 34

3.7.4 TEST RESULTS 35



4 INFORMATION ON THE TESTING LABORATORIES..... 38

5 APPENDIX A – MODIFICATIONS RECORDERS FOR ENGINEERING CHANGES TO THE EUT BY THE LAB 39



BUREAU
VERITAS

Test Report No.: RF200629W001-3

RELEASE CONTROL RECORD

ISSUE NO.	REASON FOR CHANGE	DATE ISSUED
RF200918W001-5	Original release	Oct. 23, 2020



1 SUMMARY OF TEST RESULTS

The EUT has been tested according to the following specifications:

APPLIED STANDARD: FCC Part 24 & Part 2		
STANDARD SECTION	TEST TYPE	RESULT
2.1046 24.232	Equivalent Isotropic Radiated Power	Compliance
2.1055 24.235	Frequency Stability	Compliance
2.1049 24.238(b)	Occupied Bandwidth	Compliance
24.232(d)	Peak to average ratio	Compliance
24.238(b)	Band Edge Measurements	Compliance
2.1051 24.238	Conducted Spurious Emissions	Compliance
2.1053 24.238	Radiated Spurious Emissions	Compliance

1.1 MEASUREMENT UNCERTAINTY

Where relevant, the following measurement uncertainty levels have been estimated for tests performed on the EUT as specified in CISPR 16-4-2:

MEASUREMENT	UNCERTAINTY
Frequency Stability	± 76.97Hz
Radiated emissions & Radiated Power (30MHz~1GMHz)	±4.98dB
Radiated emissions & Radiated Power (1GMHz ~6GMHz)	±4.70dB
Radiated emissions (6GMHz ~18GMHz)	±4.60dB
Radiated emissions (18GMHz ~40GMHz)	±4.12dB
Conducted emissions	±4.01dB
Occupied Channel Bandwidth	±43.58KHz
Conducted Output power	±2.06dB
Band Edge Measurements	±4.70dB
Peak to average ratio	±0.76dB

This uncertainty represents an expanded uncertainty expressed at approximately the 95% confidence level using a coverage factor of k=2.



1.2 TEST SITE AND INSTRUMENTS

Equipment	Manufacturer	Model No.	Serial No.	Last Cal.	Next Cal.
MXE EMI Receiver	KEYSIGHT	N9038A-544	MY54450026	Apr. 27,20	Apr. 26,21
EXA Signal Analyzer	KEYSIGHT	N9010A-526	MY54510322	Feb. 26,20	Feb. 25,21
Bilog Antenna	ETS-LINDGREN	3143B	00161965	Mar. 27,20	Mar. 26,21
Horn Antenna (1GHz-18GHz)	ETS-LINDGREN	3117	00168692	Mar. 27,20	Mar. 26,21
Horn Antenna (18GHz-40GHz)	N/A	QWH-SL-18-40-K-SG/QMS-00361	15433	Nov. 24, 19	Nov. 23, 20
Radio Communication Analyzer	ANRITSU	MT8820C	6201465426	Feb. 27,20	Feb. 26,21
Signal Pre-Amplifier	EMSI	EMC 9135	980249	Jun. 02,20	Jun. 01,21
Signal Pre-Amplifier	EMSI	EMC 012645B	980257	Jun. 02,20	Jun. 01,21
Signal Pre-Amplifier	EMSI	EMC 184045B	980259	Apr. 30,20	Apr. 29,21
3m Semi-anechoic Chamber	ETS-LINDGREN	9m*6m*6m	Euroshieldpn-CT0001143-1216	May. 19,20	May. 18,23
Test Software	E3	V 9.160323	N/A	N/A	N/A
Test Software	ADT	ADT_Radiated_V7.6.15.9.2	N/A	N/A	N/A
10dB Attenuator	JFW/USA	50HF-010-SM A	1505	Jun. 03,20	Jun. 02,21
Power Meter	Anritsu	ML2495A	1506002	Feb. 26,20	Feb. 25,21
Power Sensor	Anritsu	MA2411B	1339352	Feb. 26,20	Feb. 25,21
Humid & Temp Programmable Tester	Juyi	ITH-120-45-CP-AR	IAA1504-001	Jun. 02,20	Jun. 01,21
MXG Analog Microwave Signal Generator	KEYSIGHT	N5183A	MY50143024	Mar. 11,20	Mar. 10,21
Power Divider	MCLI/USA	PS2-15	24880	N/A	N/A

- NOTE:**
1. The calibration interval of the above test instruments is 12 months or 36 months and the calibrations are traceable to CEPREI/CHINA, GRGT/CHINA and NIM/CHINA.
 2. The test was performed in 3m Semi-anechoic Chamber and RF Oven Room.
 3. The horn antenna is used only for the measurement of emission frequency above 1GHz if tested.
 4. The FCC Site Registration No. is 525120; The Designation No. is CN1171.



2 GENERAL INFORMATION

2.1 GENERAL DESCRIPTION OF EUT

PRODUCT	Portable Tablet Computer	
BRAND NAME	Lenovo	
MODEL NAME	Lenovo TB-X605LC	
NOMINAL VOLTAGE	5.0Vdc (adapter or host equipment) 3.85Vdc (Li-ion, battery)	
MODULATION TYPE	WCDMA : BPSK, QPSK	
FREQUENCY RANGE	WCDMA	1852.4MHz ~ 1907.6MHz
MAX. EIRP POWER	WCDMA	269mW
EMISSION DESIGNATOR	WCDMA	4M13F9W
ANTENNA TYPE	Fixed Internal Antenna with 1.26dBi gain for WCDMA B2	
HW VERSION	Lenovo Tablet TB-X605LC	
SW VERSION	TB-X605LC_RF01_20190604	
I/O PORTS	Refer to user's manual	
CABLE SUPPLIED	USB cable: shielded, detachable, 1meter	

NOTE:

- For a more detailed features description, please refer to the manufacturer's specifications or the user's manual.
- There were Sample 1, 2, 3, 4, 5 and 6 for this project, the difference is as below:

SAMPLE	EUT CONFIGURATION INFORMATION
1	LCD Panel 1+Photo Camera 1+Photo Camera 3+CPU1+EMMC1+DDR1+speaker 1+speaker 2+motor1+Main Broad 1+BT/WLAN Module+ Battery 1
2	LCD Panel 2+Photo Camera 2+Photo Camera 4+CPU1+EMMC2+DDR2+speaker 1+speaker 2+motor2+Main Broad 2+BT/WLAN Module+ Battery 2
3	LCD Panel 1+Photo Camera 1+Photo Camera 3+CPU1+EMMC3+DDR3+speaker 1+speaker 2+motor1+Main Broad 1+BT/WLAN Module+ Battery 1
4	LCD Panel 2+Photo Camera 2+Photo Camera 4+CPU1+EMMC4+DDR4+speaker 1+speaker 2+motor2+Main Broad 2+BT/WLAN Module+ Battery 2
5	LCD Panel 1+Photo Camera 1+Photo Camera 3+CPU1+EMMC5+DDR5+speaker 1+speaker 2+motor1+Main Broad 1+BT/WLAN Module+ Battery 1
6	LCD Panel 2+Photo Camera 2+Photo Camera 4+CPU1+EMMC6+DDR6+speaker 1+speaker 2+motor2+Main Broad 2+BT/WLAN Module+ Battery 2

- The EUT incorporates a SISO function. Physically, the EUT provides one completed transmitter and one receiver.

MODULATION MODE	TX FUNCTION
WCDMA	1TX/1RX

- For the test results, the EUT had been tested with all conditions. But only the worst case was shown in test report.

**List of Accessory:**

ACCESSORIES	BRAND	MODEL	SPECIFICATION
AC Adapter 1	Salom	SC-41	I/P:100-240Vac, 0.3A O/P: 5Vdc, 2A
AC Adapter 2	AcBel	SC-41	I/P:100-240Vac, 0.3A O/P: 5Vdc, 2A
Battery 1	SCUD	L16D2P31	Rating: 3.85Vdc, 7000mAh
Battery 2	Celxpert	L16D2P31	Rating: 3.85Vdc, 7000mAh
USB Cable 1	LiQi	L27B-052000100-TCCS	1.0m shielded cable w/o core
USB Cable 2	SaiBao	S27B-052000100-TCCS	1.0m shielded cable w/o core
LCD Panel1	BOE	TV101WUM-LL4	10.1 "
LCD Panel2	BOE	TV101WUM-LL5	10.1 "
Photo Camera 1	O-film	L4H7A00	8M AF
Photo Camera 2	Q-tech	F4H7YAZ	8M AF
Photo Camera 3	Liany	LE5220FM	5M FF
Photo Camera 4	Jinkang	G7B5-QL607XFF	5M FF
CPU	Qualcomm	SDA-450-A-792NSP-TR-01-0-AA	-
EMMC1+DDR1	SAMSUNG	KMRP60014M-B614(4+64)	64G
EMMC2+DDR2	HYNIX	H9TQ52ACLTMCUR-KUM(4+64)	64G
EMMC3+DDR3	SAMSUNG	KMGD6001BM-B421(3+32)	32G
EMMC4+DDR4	HYNIX	H9TQ27ADFTMCUR-KUM(3+32)	32G
EMMC5+DDR5	SAMSUNG	KMQE60013M-B318(2+16)	16G
EMMC6+DDR6	HYNIX	H9TQ17ABJTCCUR-KUM(2+16)	16G
Speaker 1	Xichun	KFSC1712SBC-S-B232-20J-GT	-
Speaker 2	Xichun	KFSC1712SBC-S-B233-20J-W	-
speaker 1	Haosheng	HB171219B08-13-B1F-RH	-
speaker 2	Haosheng	XHB171219B08-14-B1F-RH	-
motor1	Hongzhifa	HZF-Z04BE-RL67B25-90	-
Motor2	Kunwang	CY0408L-021HB-064	-
Main Broad 1	Hongban	Aae_MB_PCB_V3	-
Main Broad 2	Huashen	Aae_MB_PCB_V3	-
BT/WLAN Module	Qualcomm	WCN-3680B-0-79BWLNSP-TR-05-1	-



2.2 CONFIGURATION OF SYSTEM UNDER TEST

FOR RADIATION EMISSION TEST

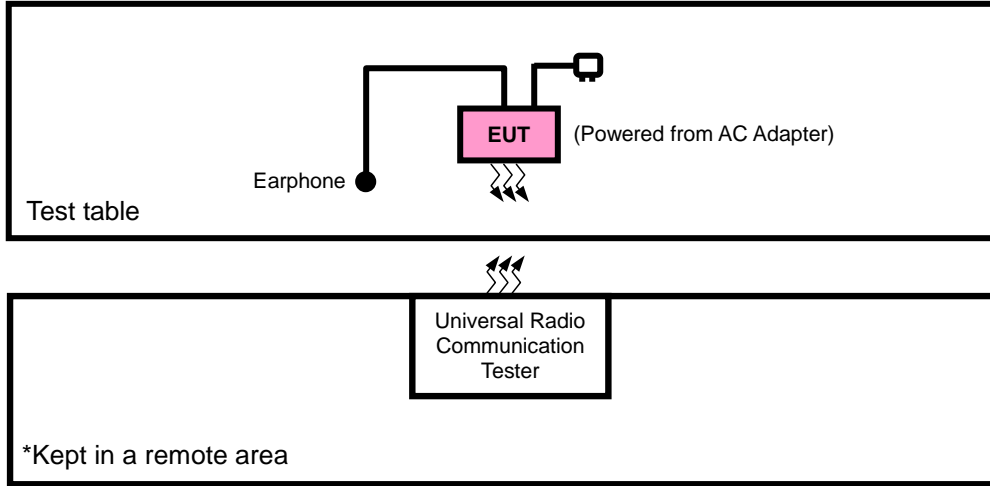



2.3 DESCRIPTION OF SUPPORT UNITS

The EUT has been tested as an independent unit together with other necessary accessories or support units. The following support units or accessories were used to form a representative test configuration during the tests.

NO.	PRODUCT	BRAND	MODEL NO.	SERIAL NO.	FCC ID
1	DC source	LONG WEI	PS-6403D	010934269	N/A

NO.	SIGNAL CABLE DESCRIPTION OF THE ABOVE SUPPORT UNITS
1	DC Line: Unshielded, Detachable 1.8m

2.4 TEST ITEM AND TEST CONFIGURATION

Pre-Scan has been conducted to determine the worst-case mode from all possible combinations between available modulations, data rates, XYZ axis and antenna ports

The worst case in EIRP and radiated emission was found when positioned on X-plane for WCDMA. Following channel(s) was (were) selected for the final test as listed below:

EUT CONFIGURE MODE	DESCRIPTION
A	EUT + Adapter + USB Cable with WCDMA link
B	EUT + Battery with WCDMA link

WCDMA MODE

EUT CONFIGURE MODE	TEST ITEM	AVAILABLE CHANNEL	TESTED CHANNEL	MODE
B	EIRP	9262 to 9538	9262, 9400, 9538	WCDMA
B	FREQUENCY STABILITY	9262 to 9538	9262, 9538	WCDMA
B	OCCUPIED BANDWIDTH	9262 to 9538	9262, 9400, 9538	WCDMA
B	PEAK TO AVERAGE RATIO	9262 to 9538	9262, 9400, 9538	WCDMA
B	BAND EDGE	9262 to 9538	9262, 9538	WCDMA
B	CONDCUDED EMISSION	9262 to 9538	9262, 9400, 9538	WCDMA
A	RADIATED EMISSION	9262 to 9538	9262, 9400, 9538	WCDMA



TEST CONDITION:

TEST ITEM	ENVIRONMENTAL CONDITIONS	INPUT POWER	TESTED BY
ERP	23deg. C, 70%RH	DC 5V By Adapter	Jace Le
FREQUENCY STABILITY	23deg. C, 70%RH	DC 3.5V/3.8V/4.4V	Kevin Zhang
OCCUPIED BANDWIDTH	23deg. C, 70%RH	DC 3.85V By Battery	Kevin Zhang
BAND EDGE	23deg. C, 70%RH	DC 3.85V By Battery	Kevin Zhang
CONDCUDED EMISSION	23deg. C, 70%RH	DC 3.85V By Battery	Kevin Zhang
RADIATED EMISSION	23deg. C, 70%RH	DC 5V By Adapter	Jace Le
PEAK TO AVERAGE RATIO	23deg. C, 70%RH	DC 3.85V By Battery	Kevin Zhang

2.5 EUT OPERATING CONDITIONS

The EUT makes a call to the communication simulator. The communication simulator station system controlled a EUT to export maximum output power under transmission mode and specific channel frequency

2.6 GENERAL DESCRIPTION OF APPLIED STANDARDS

The EUT is a RF product. According to the specifications of the manufacturer, it must comply with the requirements of the following standards:

FCC 47 CFR Part 2

FCC 47 CFR Part 24

KDB 971168 D01 Power Meas License Digital Systems v03r01

ANSI/TIA/EIA-603-D

ANSI/TIA/EIA-603-E

ANSI C63.26-2015

NOTE: All test items have been performed and recorded as per the above standards.



3 TEST TYPES AND RESULTS

3.1 OUTPUT POWER MEASUREMENT

3.1.1 LIMITS OF OUTPUT POWER MEASUREMENT

Mobile and portable stations are limited to 2 watts EIRP.

3.1.2 TEST PROCEDURES

EIRP MEASUREMENT:

Per KDB 971168 D01 Power Meas License Digital Systems v03r01 or subclause 5.2.5.5 of ANSI C63.26-2015, the relevant equation for determining the ERP or EIRP from the conducted RF output power measured using the guidance provided above is:

$$\text{ERP or EIRP} = P_{\text{Meas}} + G_{\text{T}} - L_{\text{C}}$$

Where:

ERP or EIRP = effective radiated power or equivalent isotropically radiated power, respectively

(expressed in the same units as P_{Meas} , typically dBW or dBm);

P_{Meas} = measured transmitter output power or PSD, in dBm or dBW;

G_{T} = gain of the transmitting antenna, in dBd (ERP) or dBi (EIRP);

L_{C} = signal attenuation in the connecting cable between the transmitter and antenna, in dB.

CONDUCTED POWER MEASUREMENT:

The EUT was set up for the maximum power with WCDMA link data modulation and link up with simulator. Set the EUT to transmit under low, middle and high channel and record the power level shown on simulator.



3.1.3 TEST SETUP

EIRP / ERP Measurement:

CONDUCTED POWER MEASUREMENT:



3.1.4 TEST RESULTS

CONDUCTED OUTPUT POWER (dBm)

Band	WCDMA II			Max. Tune-up Power
	Channel	9262	9400	
Rx Channel	9662	9800	9938	
Frequency	1852.4	1880	1907.6	
AMR	-	-	-	-
RMC 12.2K	22.91	23.04	22.96	24.5
HSDPA Subtest-1	21.91	22.06	21.96	23.5
HSDPA Subtest-2	21.91	22.05	21.89	23.5
HSDPA Subtest-3	21.40	21.58	21.47	23.0
HSDPA Subtest-4	21.43	21.56	21.46	23.0
HSUPA Subtest-1	21.89	22.08	21.94	23.5
HSUPA Subtest-2	19.94	20.09	20.00	21.5
HSUPA Subtest-3	21.00	21.14	20.99	22.5
HSUPA Subtest-4	19.94	20.12	20.01	21.5
HSUPA Subtest-5	21.98	22.10	22.00	23.5



EIRP POWER (dBm)

WCDMA

Channel	Frequency (MHz)	Conducted Power (dBm)	G _T -L _c (dB)	EIRP (dBm)	EIRP (mW)	Limit (W)
9262	1852.4	22.91	1.26	24.17	261.22	2
9400	1880.0	23.04	1.26	24.30	269.15	2
9538	1907.6	22.96	1.26	24.22	264.24	2

REMARKS: ERP Output Power (dBm) = EIRP (dBm) -2.15(dB).



3.2 FREQUENCY STABILITY MEASUREMENT

3.2.1 LIMITS OF FREQUENCY STABILITY MEASUREMENT

The frequency stability shall be sufficient to ensure that the fundamental emission stays within the authorized frequency block.

3.2.2 TEST PROCEDURE

- a. Device is placed at the oven room. The oven room could control the temperatures and humidity. Power warm up is at least 15 min and power applied should perform before recording frequency error.
- b. EUT is connected the external power supply to control the DC input power. The test voltage range is from minimum to maximum working voltage. Each step shall be record the frequency error rate.
- c. The temperature range step is 10 degrees in this test items. All temperature levels shall be hold the $\pm 0.5^{\circ}\text{C}$ during the measurement testing. The each temperature step shall be at least 0.5 hours, consider the EUT could be test under the stability condition.

NOTE: The frequency error was recorded frequency error from the communication simulator.

3.2.3 TEST SETUP

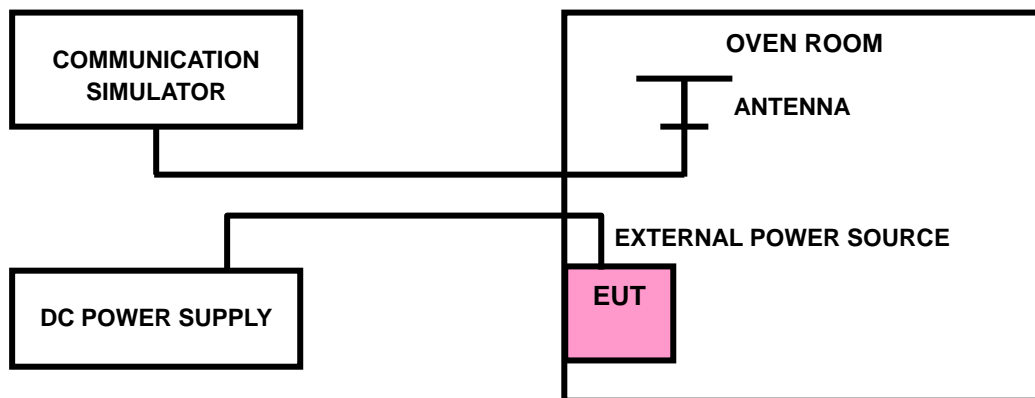



3.2.4 TEST RESULTS

WCDMA BAND II

FREQUENCY ERROR VS. VOLTAGE

VOLTAGE (Volts)	FREQUENCY ERROR (ppm)		LIMIT (ppm)
	Low Channel	High Channel	
V _{nor}	0.0009	0.0011	2.5
V _{min}	-0.0012	-0.0009	2.5
V _{max}	0.0011	0.0011	2.5

NOTE: The applicant defined the normal working voltage of the battery is from V_{min} Vdc to V_{max} Vdc.

FREQUENCY ERROR vs. TEMPERATURE.

TEMP. (°C)	FREQUENCY ERROR (ppm)		LIMIT (ppm)
	Low Channel	High Channel	
-30	-0.0051	-0.0050	2.5
-20	-0.0049	-0.0043	2.5
-10	-0.0036	-0.0036	2.5
0	-0.0033	-0.0033	2.5
10	-0.0021	-0.0023	2.5
20	-0.0020	-0.0017	2.5
30	-0.0016	-0.0016	2.5
40	-0.0008	-0.0009	2.5
50	-0.0001	-0.0002	2.5



3.3 OCCUPIED BANDWIDTH MEASUREMENT

3.3.1 TEST PROCEDURES

The EUT makes a call to the communication simulator. All measurements were done at low, middle and high operational frequency range. The communication simulator station system controlled a EUT to export maximum output power under transmission mode and specific channel frequency. Use OBW measurement function of Spectrum analyzer to measure 99 % occupied bandwidth.

3.3.2 TEST SETUP

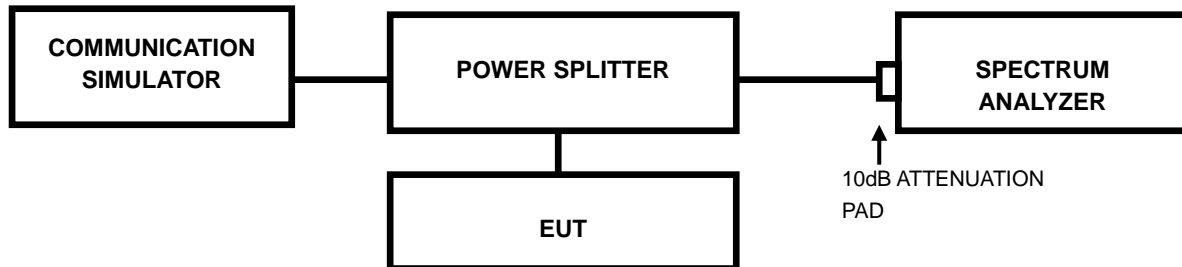



3.3.3 TEST RESULTS

Channel	Frequency (MHz)	99% Occupied bandwidth (MHz)	CHANNEL	FREQUENCY (MHz)	26dB bandwidth (MHz)
		WCDMA			WCDMA
9262	1852.4	4.130	9262	1852.4	4.695
9400	1880.0	4.111	9400	1880.0	4.691
9538	1907.6	4.127	9538	1907.6	4.729

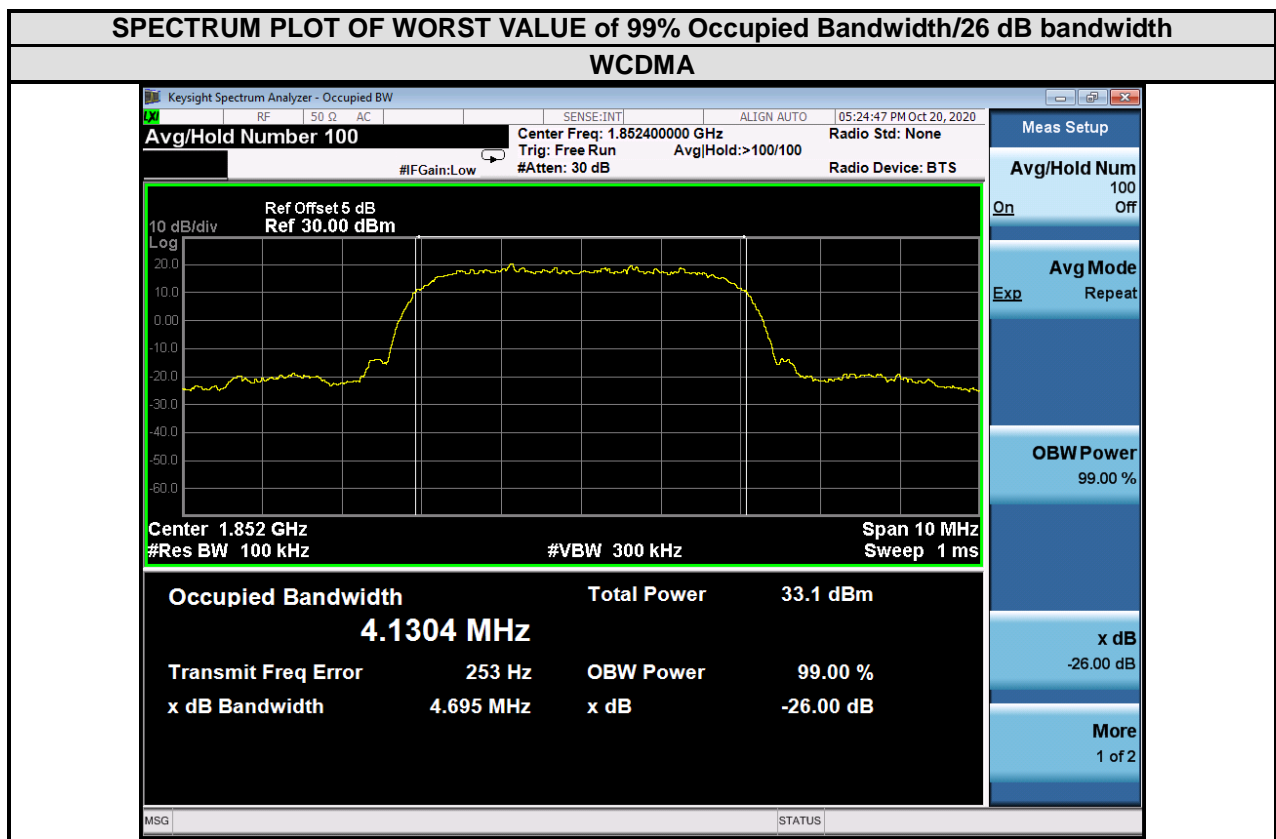



3.4 BAND EDGE MEASUREMENT

3.4.1 LIMITS OF BAND EDGE MEASUREMENT

Power of any emission outside of the authorized operating frequency ranges must be attenuated below the transmitting power (P) by a factor of at least $43 + 10 \log(P)$ dB. In the 1 MHz bands immediately outside and adjacent to the frequency block a resolution bandwidth of at least one percent of the emission bandwidth of the fundamental emission of the transmitter may be employed.

3.4.2 TEST SETUP

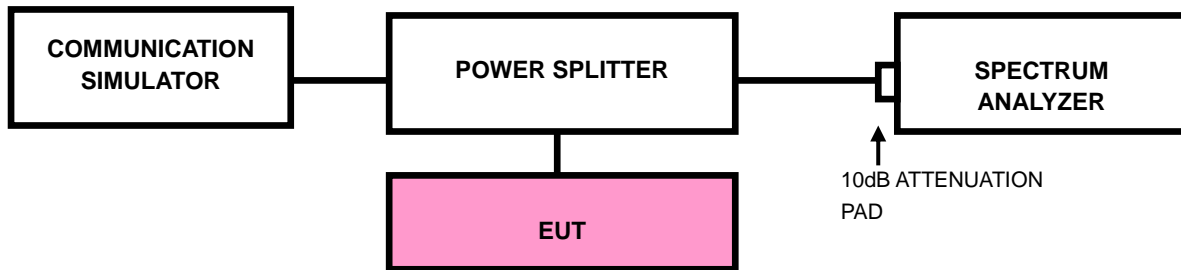



3.4.3 TEST PROCEDURES

- a. All measurements were done at low and high operational frequency range.
- b. The center frequency of spectrum is the band edge frequency and span is 10MHz. RBW of the spectrum is 100kHz and VBW of the spectrum is 300kHz (WCDMA).
- c. Record the max trace plot into the test report.



3.4.4. TEST RESULTS

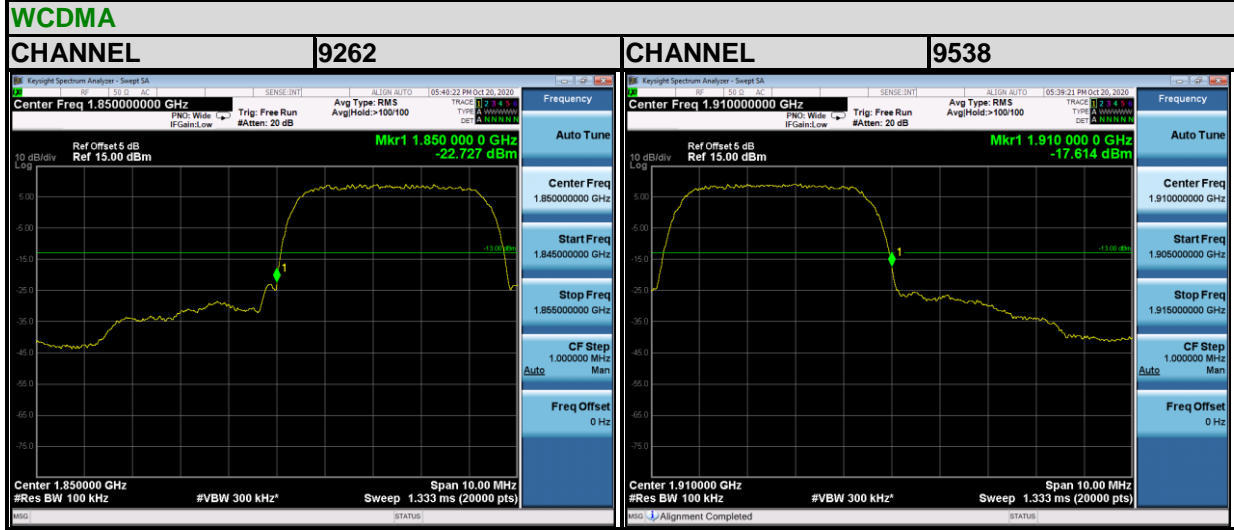



3.5 CONDUCTED SPURIOUS EMISSIONS

3.5.1 LIMITS OF CONDUCTED SPURIOUS EMISSIONS MEASUREMENT

The power of any emission outside of the authorized operating frequency ranges must be attenuated below the transmitting power (P) by a factor of at least $43 + 10 \log(P)$ dB. The emission limit equal to -13dBm .

3.5.2 TEST PROCEDURE

- a. The EUT makes a phone call to the communication simulator. All measurements were done at low, middle and high operational frequency range.
- b. Measuring frequency range is from 30 MHz to 19.0GHz. 10dB attenuation pad is connected with spectrum. RBW=1MHz and VBW=3MHz is used for conducted emission measurement.

3.5.3 TEST SETUP

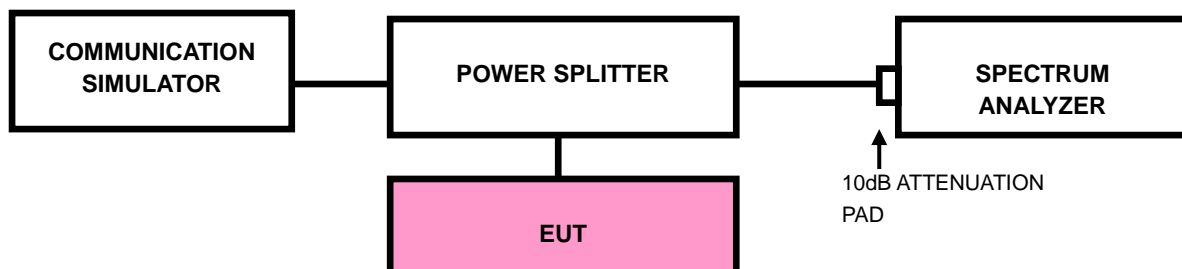



3.5.4 TEST RESULTS

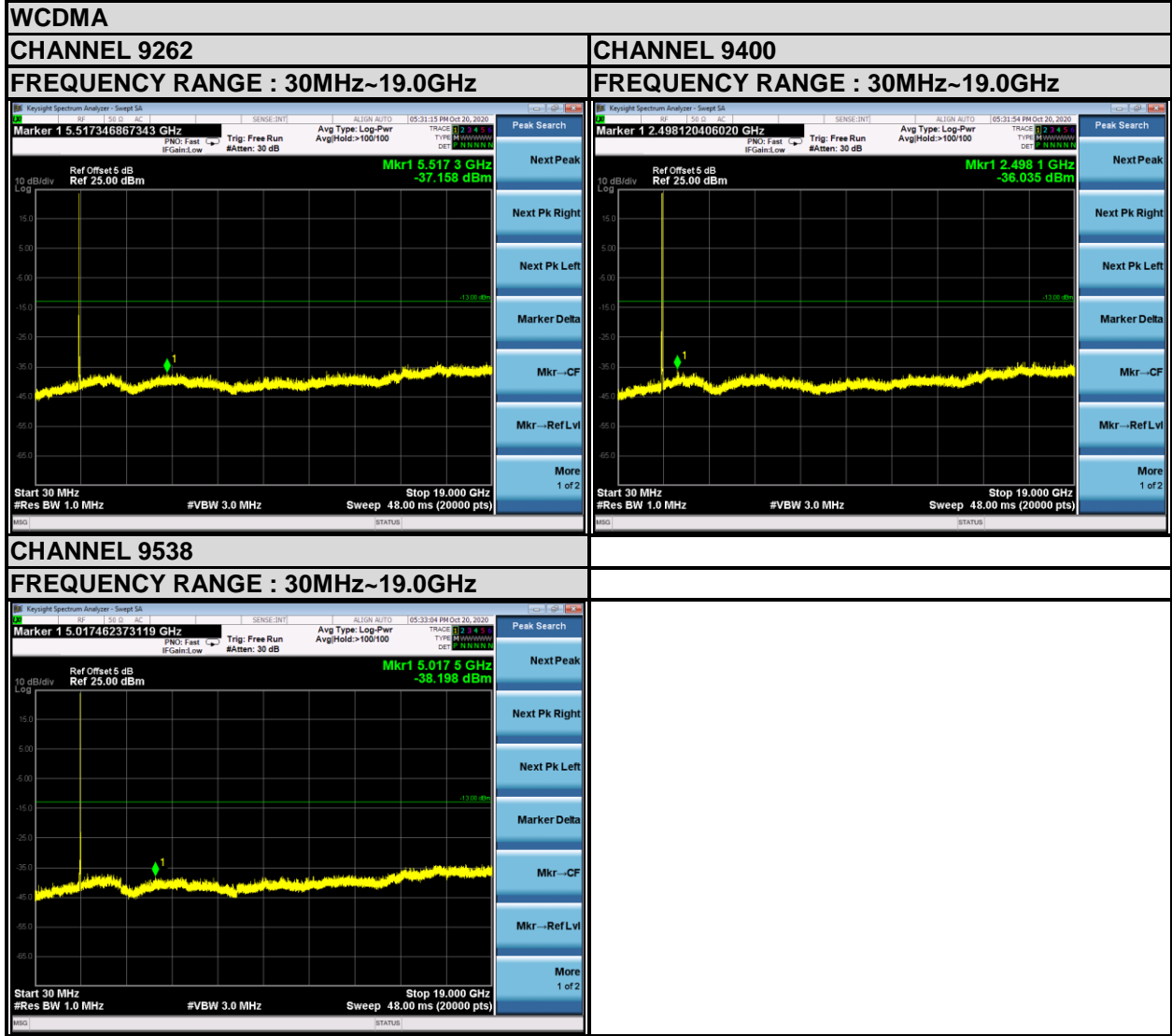



3.6 RADIATED EMISSION MEASUREMENT

3.6.1 LIMITS OF RADIATED EMISSION MEASUREMENT

The power of any emission outside of the authorized operating frequency ranges must be attenuated below the transmitting power (P) by a factor of at least $43 + 10 \log(P)$ dB. The emission limit equal to -13dBm .

3.6.2 TEST PROCEDURES

- a. Substitution method is used for E.I.R.P measurement. In the semi-anechoic chamber, EUT placed on the 0.8m height of Turn Table, rotated the table around 360 degrees to search the maximum radiation power and receiver antenna shall be rotated vertical and horizontal polarization and moved height from 1m to 4m to find the maximum polar radiated power. The “Read Value” is the spectrum reading the maximum power value.
- b. The substitution horn antenna is substituted for EUT at the same position and signals generator export the CW signal to the substitution antenna via a TX cable. Rotated the Turn Table and moved receiving antenna to find the maximum radiation power. Adjust output power level of S.G to get a Value of spectrum reading equal to “Read Value “ of step a. Record the power level of S.G
- c. $\text{EIRP} = \text{Output power level of S.G} - \text{TX cable loss} + \text{Antenna gain of substitution horn}$.

NOTE: The resolution bandwidth and video bandwidth of test receiver/spectrum analyzer is 1MHz/3MHz.

3.6.3 DEVIATION FROM TEST STANDARD

No deviation

3.6.4 TEST SETUP

< Frequency Range 30MHz~1GHz >

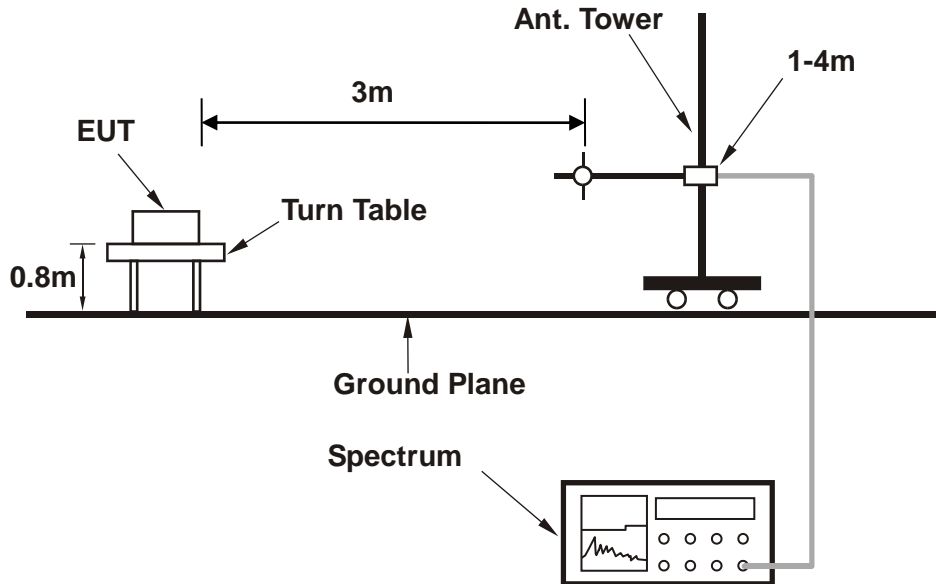

<Frequency Range above 1GHz>

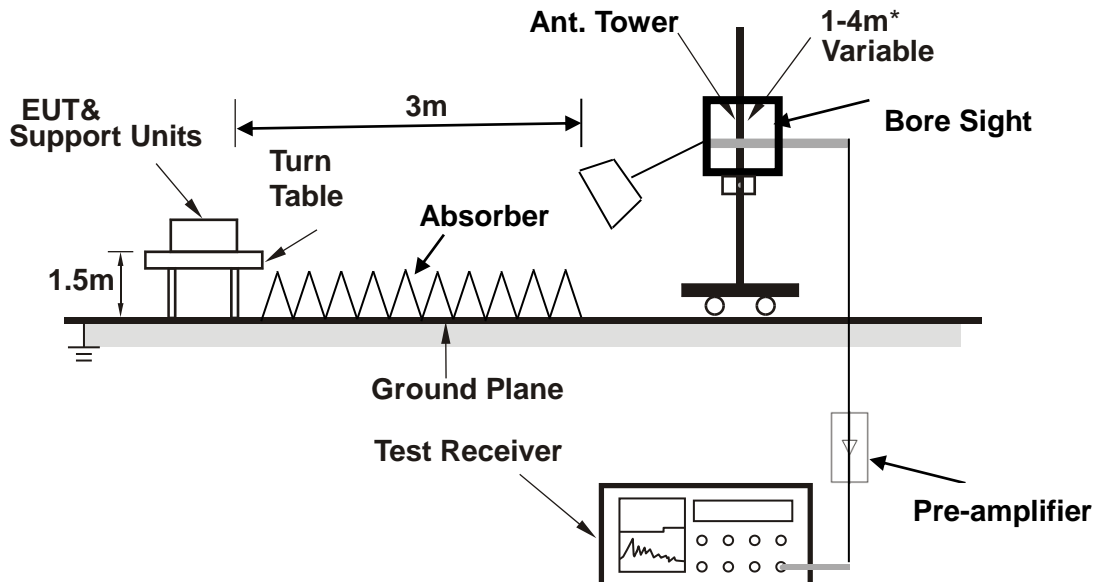

Note: Above 1G is a directional antenna

Depends on the EUT height and the antenna 3dB beamwidth both, refer to section 7.3 of CISPR 16-2-3.

For the actual test configuration, please refer to the attached file (Test Setup Photo).



3.6.5 TEST RESULTS

BELOW 1GHz WORST-CASE DATA

30 MHz – 1GHz data:

WCDMA Band II

MODE	TX channel 9400	FREQUENCY RANGE	Below 1000MHz
ENVIRONMENTAL CONDITIONS	23deg. C, 70%RH	INPUT POWER	DC 5V from adapter
TESTED BY	Jace		
ANTENNA POLARITY & TEST DISTANCE: HORIZONTAL AT 3 M			

	Freq	Level	Read Level	Limit Line	Over Limit	Factor	Remark	Pol/Phase
	MHz	dBm/m	dBm	dBm/m	dB	dB/m		
1	PP	31.940	-32.55	-49.22	-13.00	-19.55	16.67 Peak	Horizontal
2		47.460	-48.12	-53.56	-13.00	-35.12	5.44 Peak	Horizontal
3		77.530	-56.45	-47.65	-13.00	-43.45	-8.80 Peak	Horizontal
4		119.240	-74.85	-59.67	-13.00	-61.85	-15.18 Peak	Horizontal
5		198.780	-67.03	-49.76	-13.00	-54.03	-17.27 Peak	Horizontal
6		278.320	-64.72	-49.84	-13.00	-51.72	-14.88 Peak	Horizontal

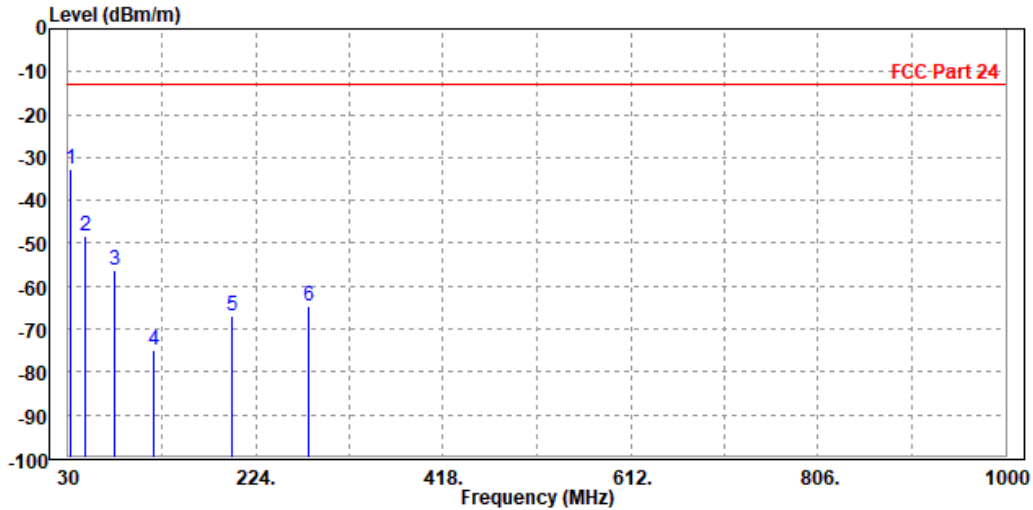



**BUREAU
VERITAS**

Test Report No.: RF200629W001-3

MODE	TX channel 9400	FREQUENCY RANGE	Below 1000MHz
ENVIRONMENTAL CONDITIONS	23deg. C, 70%RH	INPUT POWER	DC 5V from adapter
TESTED BY	Jace		
ANTENNA POLARITY & TEST DISTANCE: VERTICAL AT 3 M			

	Freq	Level	Read Level	Limit Line	Over Limit	Factor	Remark	Pol/Phase	
	MHz	dBm/m	dBm	dBm/m	dB	dB/m			
1	PP	30.000	-48.98	-54.31	-13.00	-35.98	5.33	Peak	Vertical
2		49.400	-53.07	-48.54	-13.00	-40.07	-4.53	Peak	Vertical
3		79.470	-57.93	-47.40	-13.00	-44.93	-10.53	Peak	Vertical
4		125.060	-70.38	-58.17	-13.00	-57.38	-12.21	Peak	Vertical
5		198.780	-62.45	-51.66	-13.00	-49.45	-10.79	Peak	Vertical
6		277.350	-59.86	-48.46	-13.00	-46.86	-11.40	Peak	Vertical

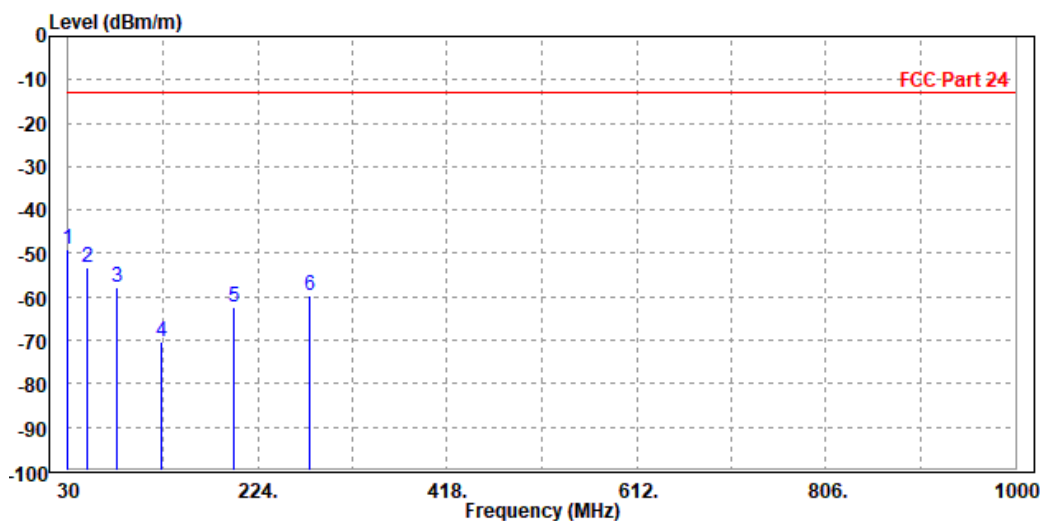



ABOVE 1GHz DATA

Note: For higher frequency, the emission is too low to be detected.

WORST-CASE DATA

WCDMA Band II

CH 9262

MODE	TX channel 9262	FREQUENCY RANGE	Above 1000MHz
ENVIRONMENTAL CONDITIONS	23deg. C, 70%RH	INPUT POWER	DC 5V from adapter
TESTED BY	Jace		
ANTENNA POLARITY & TEST DISTANCE: HORIZONTAL AT 3 M			

	Freq	Level	Read Level	Limit Line	Over Limit	Factor	Remark	Pol/Phase
	MHz	dBm/m	dBm	dBm/m	dB	dB/m		
1	PP 3700.000	-48.15	-56.94	-13.00	-35.15	8.79	Peak	Horizontal
2	5557.200	-48.63	-58.84	-13.00	-35.63	10.21	Peak	Horizontal

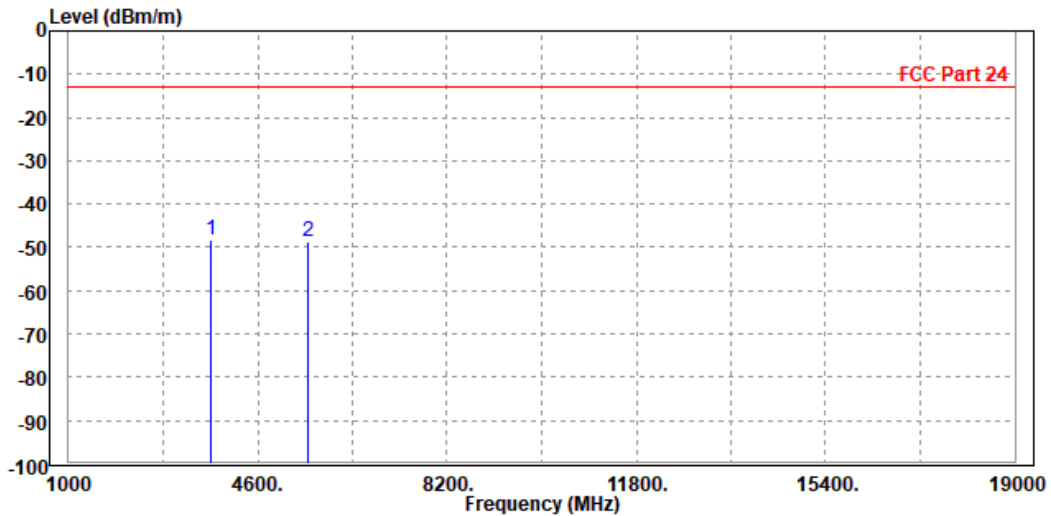



BUREAU VERITAS

Test Report No.: RF200629W001-3

MODE	TX channel 9262	FREQUENCY RANGE	Above 1000MHz
ENVIRONMENTAL CONDITIONS	23deg. C, 70%RH	INPUT POWER	DC 5V from adapter
TESTED BY	Jace		
ANTENNA POLARITY & TEST DISTANCE: VERTICAL AT 3 M			

	Read	Limit	Over				
Freq	Level	Level	Line	Limit	Factor	Remark	Pol/Phase
MHz	dBm/m	dBm	dBm/m	dB	dB/m		
1 PP 3700.000	-47.31	-56.56	-13.00	-34.31	9.25	Peak	Vertical
2 5557.200	-49.55	-59.48	-13.00	-36.55	9.93	Peak	Vertical

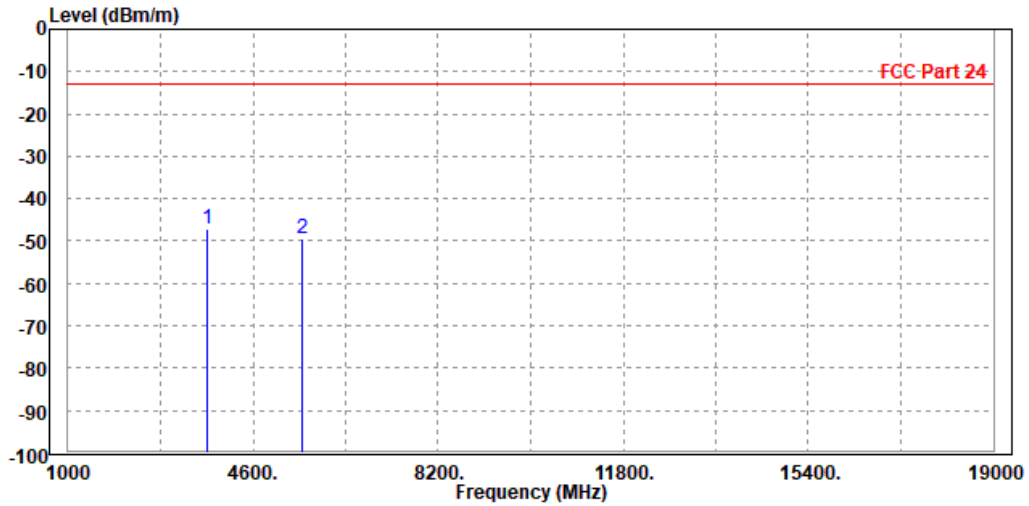



BUREAU VERITAS

Test Report No.: RF200629W001-3

CH 9400

MODE	TX channel 9400	FREQUENCY RANGE	Above 1000MHz
ENVIRONMENTAL CONDITIONS	23deg. C, 70%RH	INPUT POWER	DC 5V from adapter
TESTED BY	Jace		
ANTENNA POLARITY & TEST DISTANCE: HORIZONTAL AT 3 M			

	Freq	Level	Read Level	Limit Line	Over Limit	Factor	Remark	Pol/Phase
	MHz	dBm/m	dBm	dBm/m	dB	dB/m		
1	3754.000	-48.50	-57.34	-13.00	-35.50	8.84	Peak	Horizontal
2 PP	5640.000	-48.22	-58.70	-13.00	-35.22	10.48	Peak	Horizontal

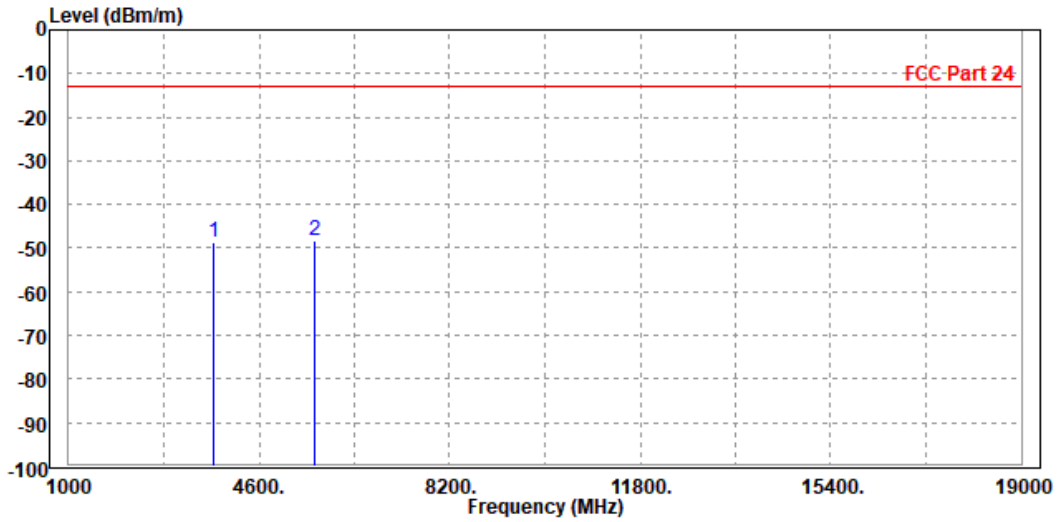



MODE	TX channel 9400	FREQUENCY RANGE	Above 1000MHz
ENVIRONMENTAL CONDITIONS	23deg. C, 70%RH	INPUT POWER	DC 5V from adapter
TESTED BY	Jace		
ANTENNA POLARITY & TEST DISTANCE: VERTICAL AT 3 M			

	Freq	Level	Read Level	Limit Line	Over Limit	Factor	Remark	Pol/Phase
	MHz	dBm/m	dBm	dBm/m	dB	dB/m		
1	PP 3754.000	-47.18	-56.45	-13.00	-34.18	9.27	Peak	Vertical
2	5640.000	-48.52	-58.77	-13.00	-35.52	10.25	Peak	Vertical

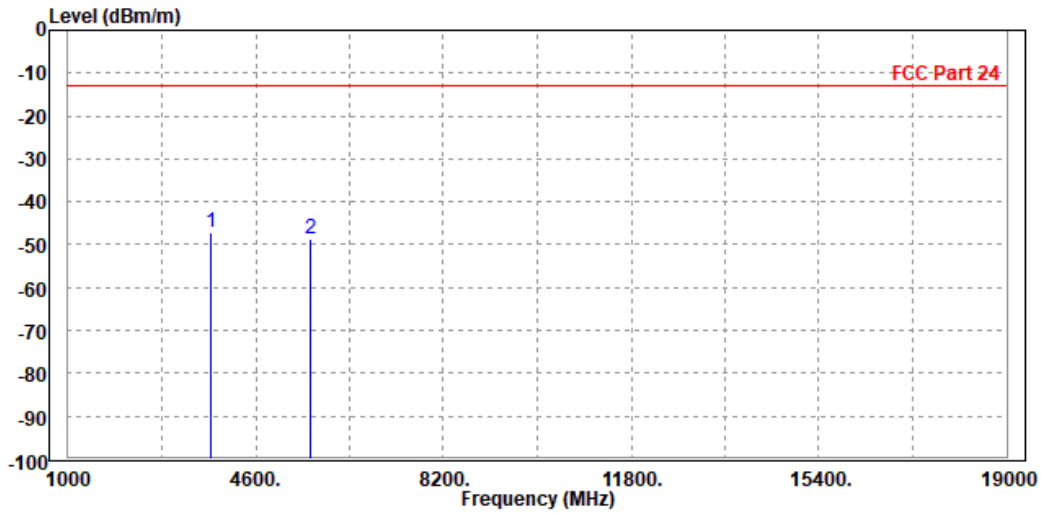



BUREAU VERITAS

Test Report No.: RF200629W001-3

CH 9538

MODE	TX channel 9538	FREQUENCY RANGE	Above 1000MHz
ENVIRONMENTAL CONDITIONS	23deg. C, 70%RH	INPUT POWER	DC 5V from adapter
TESTED BY	Jace		
ANTENNA POLARITY & TEST DISTANCE: HORIZONTAL AT 3 M			

	Freq	Level	Read Level	Limit Line	Over Limit	Factor	Remark	Pol/Phase
	MHz	dBm/m	dBm	dBm/m	dB	dB/m		
1	3808.000	-47.57	-56.47	-13.00	-34.57	8.90	Peak	Horizontal
2 PP	5722.800	-46.21	-56.97	-13.00	-33.21	10.76	Peak	Horizontal

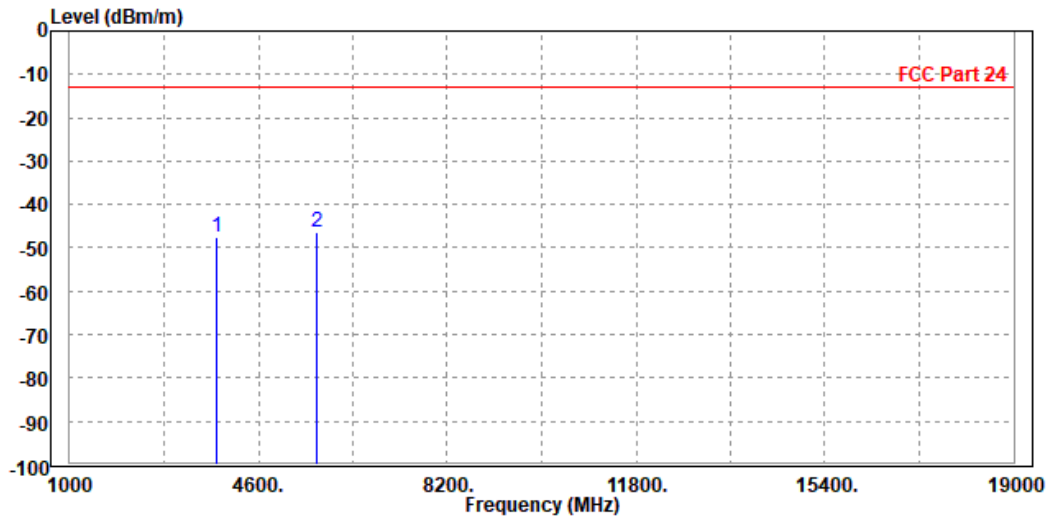



BUREAU VERITAS

Test Report No.: RF200629W001-3

MODE	TX channel 9538	FREQUENCY RANGE	Above 1000MHz
ENVIRONMENTAL CONDITIONS	23deg. C, 70%RH	INPUT POWER	DC 5V from adapter
TESTED BY	Jace		
ANTENNA POLARITY & TEST DISTANCE: VERTICAL AT 3 M			

	Freq	Level	Read Level	Limit Line	Over Limit	Factor	Remark	Pol/Phase
	MHz	dBm/m	dBm	dBm/m	dB	dB/m		
1	3808.000	-47.66	-56.94	-13.00	-34.66	9.28	Peak	Vertical
2 PP	5722.800	-46.61	-57.18	-13.00	-33.61	10.57	Peak	Vertical

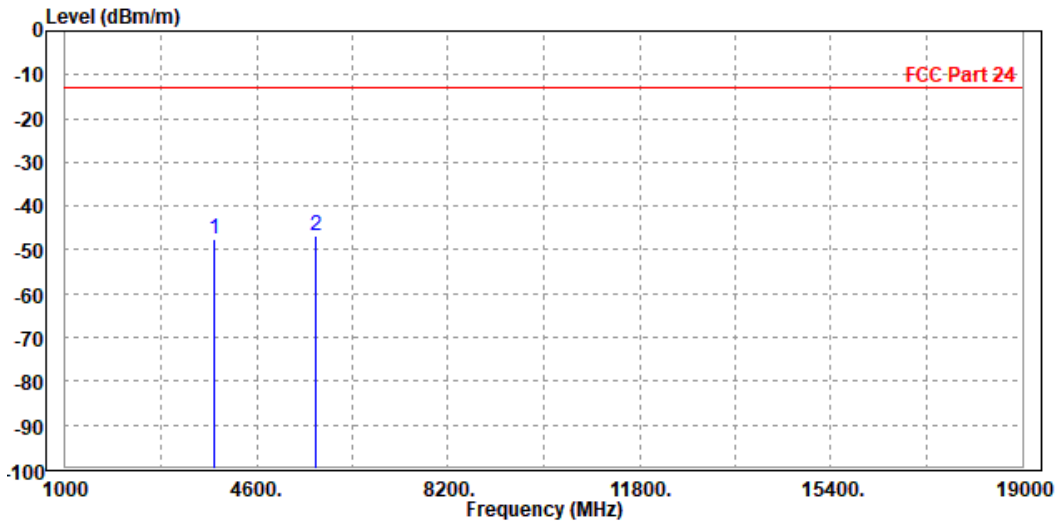



3.7 PEAK TO AVERAGE RATIO

3.7.1 LIMITS OF peak to average ratio MEASUREMENT

In measuring transmissions in this band using an average power technique, the peak to-average ratio (PAR) of the transmission may not exceed 13 dB

3.7.2 TEST SETUP

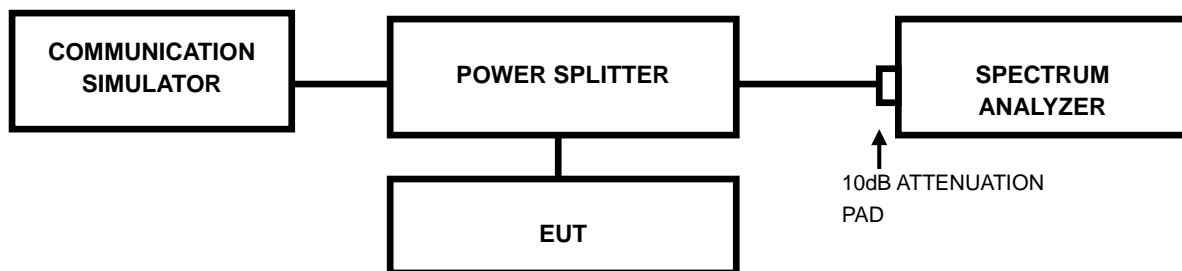

3.7.3 TEST PROCEDURES

1. Set resolution/measurement bandwidth \geq signal's occupied bandwidth;
2. Set the number of counts to a value that stabilizes the measured CCDF curve;
3. Record the maximum PAPR level associated with a probability of 0.1%.



3.7.4 TEST RESULTS

WCDMA

CHANNEL	FREQUENCY (MHz)	PEAK TO AVERAGE RATIO (dB)
9262	1852.4	3.18

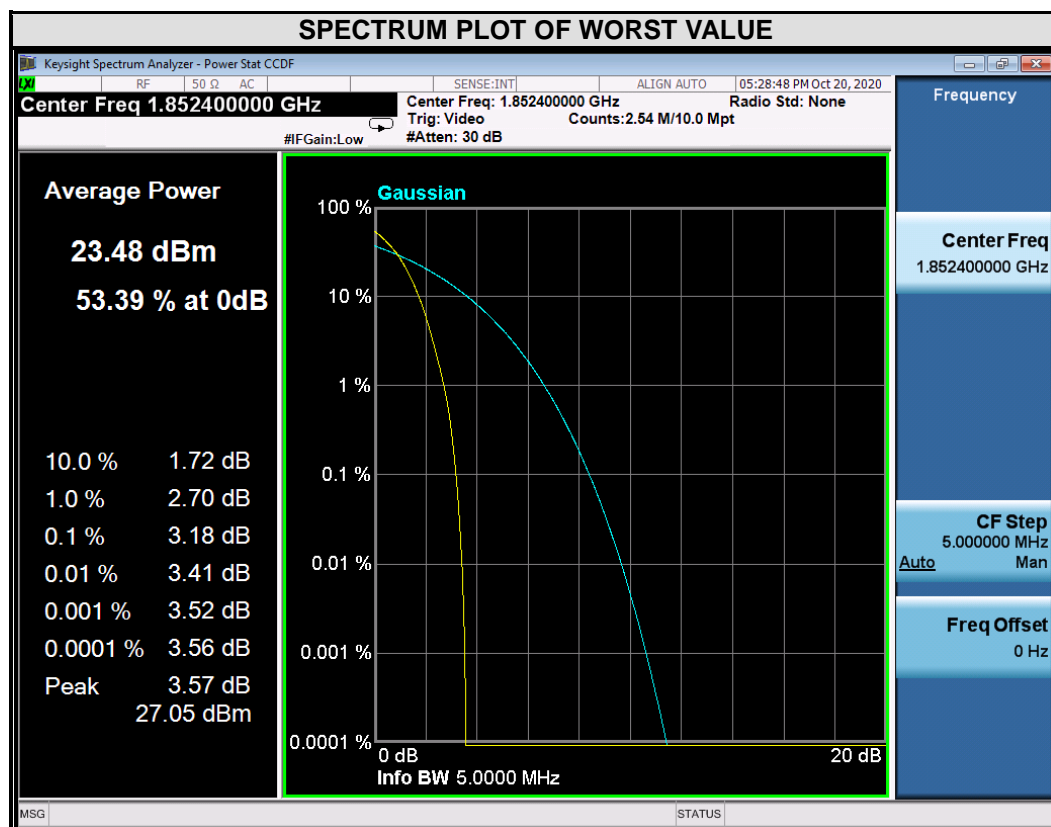



**BUREAU
VERITAS**

Test Report No.: RF200629W001-3

CHANNEL	FREQUENCY (MHz)	PEAK TO AVERAGE RATIO (dB)
9400	1880.0	3.08

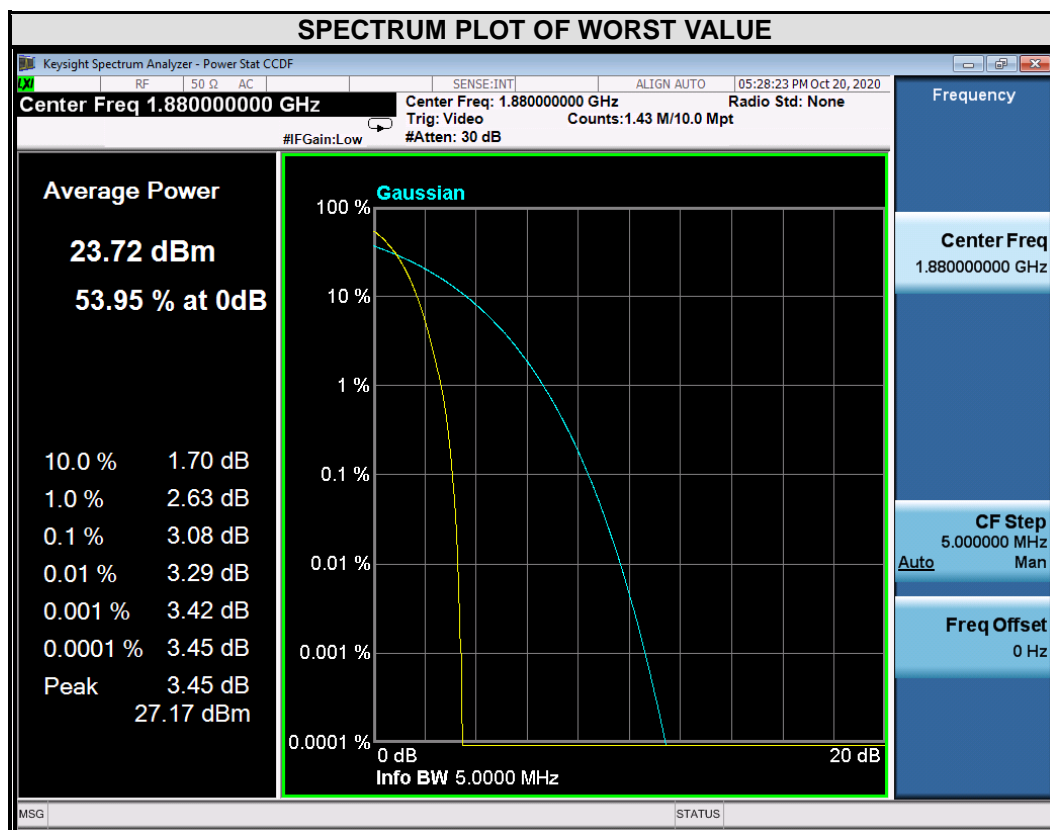



CHANNEL	FREQUENCY (MHz)	PEAK TO AVERAGE RATIO (dB)
9538	1907.6	2.50

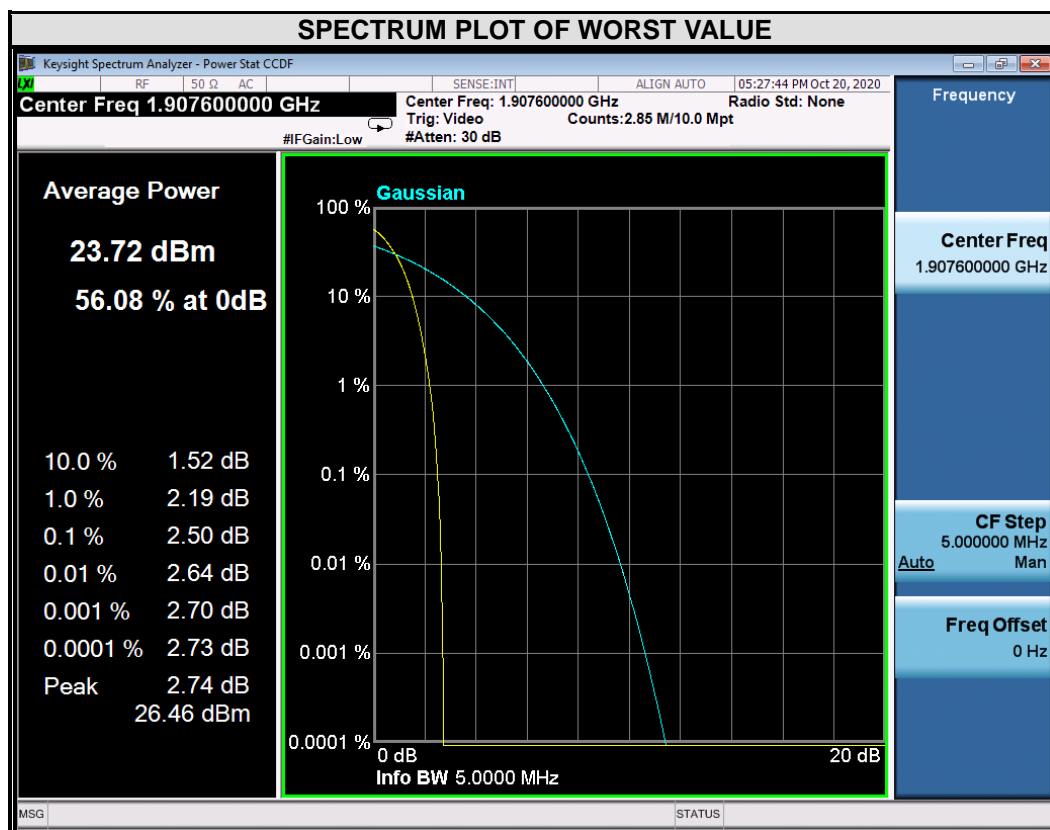



BUREAU VERITAS Test Report No.: RF200629W001-3

4 INFORMATION ON THE TESTING LABORATORIES

We, BV 7LAYERS COMMUNICATIONS TECHNOLOGY (SHENZHEN) CO. LTD., were founded in 2015 to provide our best service in EMC, Radio, Telecom and Safety consultation. Our laboratories are accredited and approved according to ISO/IEC 17025.

If you have any comments, please feel free to contact us at the following:

Shenzhen EMC/RF Lab:

Tel: +86-755-88696566

Fax: +86-755-88696577

Email: customerservice.dg@cn.bureauveritas.com

Web Site: www.adt.com.tw

The address and road map of all our labs can be found in our web site also.



BUREAU VERITAS Test Report No.: RF200629W001-3

5 APPENDIX A – MODIFICATIONS RECORDERS FOR ENGINEERING CHANGES TO THE EUT BY THE LAB

No any modifications are made to the EUT by the lab during the test.

---END---