

FCC TEST REPORT

(Part 15, Subpart E)



Applicant:	Lenovo(Shanghai) Electronics Technology Co., Ltd.
Address:	Section 304-305, Building No. 4, # 222, Meiyue Road, China (Shanghai) Pilot Free Trade Zone

Manufacturer or Supplier:	Lenovo PC HK Limited
Address:	23/F, Lincoln House, Taikoo Place 979 King's Road, Quarry Bay, Hong Kong
Product:	Portable Tablet Computer
Brand Name:	Lenovo
Model Name:	Lenovo TB-X605FC
FCC ID:	O57TBX605FC
Date of tests:	Apr. 10, 2019 ~ Jun. 13, 2019

The tests have been carried out according to the requirements of the following standard:

FCC Part 15, Subpart E, Section 15.407

CONCLUSION: The submitted sample was found to COMPLY with the test requirement

Prepared by Alex Chen Engineer / Mobile Department	Approved by Luke Lu Manager / Mobile Department
 Date: Jun. 14, 2019	 Date: Jun. 14, 2019

This report is governed by, and incorporates by reference, CPS Conditions of Service as posted at the date of issuance of this report at <http://www.bureauveritas.com/home/about-us/our-business/cps/about-us/terms-conditions> and is intended for your exclusive use. Any copying or replication of this report to or for any other person or entity, or use of our name or trademark, is permitted only with our prior written permission. This report sets forth our findings solely with respect to the test samples identified herein. The results set forth in this report are not indicative or representative of the quality or characteristics of the lot from which a test sample was taken or any similar or identical product unless specifically and expressly noted. Our report includes all of the tests requested by you and the results thereof based upon the information that you provided to us. Measurement uncertainty is only provided upon request for accredited tests. You have 60 days from date of issuance of this report to notify us of any material error or omission caused by our negligence or if you require measurement uncertainty; provided, however, that such notice shall be in writing and shall specifically address the issue you wish to raise. A failure to raise such issue within the prescribed time shall constitute your unqualified acceptance of the completeness of this report, the tests conducted and the correctness of the report contents.



TABLE OF CONTENTS

RELEASE CONTROL RECORD 4

1 SUMMARY OF TEST RESULTS..... 5

1.1 MEASUREMENT UNCERTAINTY 5

2 GENERAL INFORMATION 6

2.1 GENERAL DESCRIPTION OF EUT 6

2.2 DESCRIPTION OF TEST MODES 9

2.2.1 TEST MODE APPLICABILITY AND TESTED CHANNEL DETAIL.....11

2.3 DUTY CYCLE OF TEST SIGNAL 14

2.4 DESCRIPTION OF SUPPORT UNITS 15

2.4.1 CONFIGURATION OF SYSTEM UNDER TEST 15

2.5 GENERAL DESCRIPTION OF APPLIED STANDARDS 16

3 TEST TYPES AND RESULTS..... 17

3.1 RADIATED EMISSION AND BANDEDGE MEASUREMENT 17

3.1.1 LIMITS OF RADIATED EMISSION AND BANDEDGE MEASUREMENT..... 17

3.1.2 LIMITS OF UNWANTED EMISSION 17

3.1.3 TEST INSTRUMENTS 18

3.1.4 TEST PROCEDURES 19

3.1.5 DEVIATION FROM TEST STANDARD 19

3.1.6 TEST SETUP 20

3.1.7 EUT OPERATING CONDITION 21

3.1.8 TEST RESULTS 22

3.2 CONDUCTED EMISSION MEASUREMENT 70

3.2.1 LIMITS OF CONDUCTED EMISSION MEASUREMENT 70

3.2.2 TEST INSTRUMENTS 70

3.2.3 TEST PROCEDURES 70

3.2.4 DEVIATION FROM TEST STANDARD 71

3.2.5 TEST SETUP 71

3.2.6 EUT OPERATING CONDITIONS 71

3.2.7 TEST RESULTS 72

3.3 MAXIMUM CONDUCTED OUTPUT POWER MEASUREMENT 74

3.3.1 LIMITS OF MAXIMUM CONDUCTED OUTPUT POWER MEASUREMENT 74

3.3.2 TEST SETUP 75



3.3.3	TEST INSTRUMENTS.....	75
3.3.4	TEST PROCEDURE.....	76
3.3.5	DEVIATION FROM TEST STANDARD	78
3.3.6	EUT OPERATING CONDITIONS	78
3.3.7	TEST RESULTS	79
3.4	MAXIMUM POWER SPECTRAL DENSITY MEASUREMENT.....	92
3.4.1	LIMITS OF MAXIMUM POWER SPECTRAL DENSITY MEASUREMENT	92
3.4.2	TEST SETUP	92
3.4.3	TEST INSTRUMENTS.....	92
3.4.4	TEST PROCEDURES	93
3.4.5	DEVIATION FROM TEST STANDARD	93
3.4.6	EUT OPERATING CONDITIONS	93
3.4.7	TEST RESULTS	94
3.5	FREQUENCY STABILITY	101
3.5.1	LIMITS OF FREQUENCY STABILITY MEASUREMENT	101
3.5.2	TEST SETUP	101
3.5.3	TEST INSTRUMENTS.....	101
3.5.4	TEST PROCEDURE.....	102
3.5.5	DEVIATION FROM TEST STANDARD	102
3.5.6	EUT OPERATING CONDITION	102
3.5.7	TEST RESULTS	103
4	PHOTOGRAPHS OF THE TEST CONFIGURATION	105
5	APPENDIX A – MODIFICATIONS RECORDERS FOR ENGINEERING CHANGES TO THE EUT BY THE LAB	106



Test Report No.: RF190522W010-3

RELEASE CONTROL RECORD

ISSUE NO.	REASON FOR CHANGE	DATE ISSUED
RF190522W010-3	Original release	Jun. 14, 2019



1 SUMMARY OF TEST RESULTS

The EUT has been tested according to the following specifications:

APPLIED STANDARD: FCC PART 15, SUBPART E (SECTION 15.407)			
STANDARD SECTION	TEST TYPE AND LIMIT	RESULT	REMARK
15.407(b)(5)	AC Power Conducted Emission	PASS	Meet the requirement of limit. Minimum passing margin is -10.66dB at 0.572000MHz.
15.407(b) (1/2/3/4/6)	Radiated Emission & Band Edge Measurement	PASS	Meet the requirement of limit. Minimum passing margin is -3.36dB at 5470.00MHz.
15.407(a/1/2/3)	Maximum conducted output Power	PASS	Meet the requirement of limit.
15.407(a/1/2/3)	Peak Power Spectral Density	PASS	Meet the requirement of limit.
15.407(e)	6 dB Bandwidth	PASS	Meet the requirement of limit. (U-NII-3 Band only)
15.407(g)	Frequency Stability	PASS	Meet the requirement of limit.
15.203	Antenna Requirement	PASS	No antenna connector is used.

1.1 MEASUREMENT UNCERTAINTY

Where relevant, the following measurement uncertainty levels have been estimated for tests performed on the EUT as specified in CISPR 16-4-2:

MEASUREMENT	UNCERTAINTY
AC Power Conducted emissions	± 2.70dB
All Radiated emissions	±4.48dB
Conducted emissions	±2 dB
Occupied Channel Bandwidth	±21.7KHz
Conducted Output power	±1.03 dB
Power Spectral Density	±0.95 dB

This uncertainty represents an expanded uncertainty expressed at approximately the 95% confidence level using a coverage factor of k = 2.



2 GENERAL INFORMATION

2.1 GENERAL DESCRIPTION OF EUT

EUT	Portable Tablet Computer
BRAND NAME	Lenovo
MODEL NAME	Lenovo TB-X605FC
POWER SUPPLY	5.0Vdc (adapter or host equipment) 3.85Vdc (Li-ion, battery)
MODULATION TYPE	64QAM, 16QAM, QPSK, BPSK
MODULATION TECHNOLOGY	OFDM
TRANSFER RATE	802.11a: 54.0/ 48.0/ 36.0/ 24.0/ 18.0/ 12.0/ 9.0/ 6.0Mbps 802.11n: up to MCS7 802.11ac: up to 390.0Mbps
OPERATING FREQUENCY	5180 ~ 5240MHz, 5260 ~ 5320MHz, 5500 ~ 5700MHz, 5745 ~ 5805MHz
NUMBER OF CHANNEL	5180 ~ 5240MHz: 4 for 802.11a, 802.11n (20MHz) 2 for 802.11n (40MHz) 1 for 802.11ac (80MHz) 5260 ~ 5320MHz: 4 for 802.11a, 802.11n (20MHz) 2 for 802.11n (40MHz) 1 for 802.11ac (80MHz) 5500 ~ 5700MHz: 8 for 802.11a, 802.11n (20MHz) 3 for 802.11n (40MHz) 1 for 802.11ac (80MHz) 5745 ~ 5805MHz: 4 for 802.11a, 802.11n (20MHz) 2 for 802.11n (40MHz) 1 for 802.11ac (80MHz)
AVERAGE POWER	27.794mW for 5180 ~ 5240MHz 27.416mW for 5260 ~ 5320MHz 27.669mW for 5500 ~ 5700MHz 21.528mW for 5745 ~ 5805MHz
ANTENNA TYPE	5180 ~ 5240MHz: PIFA Antenna with -0.8dBi gain 5260 ~ 5320MHz: PIFA Antenna with -0.6dBi gain 5500 ~ 5700MHz: PIFA Antenna with 1.02dBi gain 5745 ~ 5805MHz: PIFA Antenna with 0.8dBi gain
HW VERSION	Lenovo Tablet TB-X605FC
SW VERSION	TB-X605FC_RF01_20190611
I/O PORTS	Refer to user's manual



CABLE SUPPLIED	USB cable: non-shielded, detachable, 1.0m
-----------------------	---

NOTE:

- For a more detailed features description, please refer to the manufacturer’s specifications or the user’s manual.
- There were Sample 1, 2, 3, 4, 5 and 6 for this project, the difference is as below:

SAMPLE	EUT CONFIGURATION INFORMATION
1	LCD Panel 1+Photo Camera 1+Photo Camera 3+CPU1+EMMC1+DDR1+speaker 1+speaker 2+motor1+Main Broad 1 + BT/WLAN Module+ Battery 1
2	LCD Panel 2+Photo Camera 2+Photo Camera 4+CPU1+EMMC2+DDR2+speaker 1+speaker 2+motor2+Main Broad 2+ BT/WLAN Module+ Battery 2
3	LCD Panel 1+Photo Camera 1+Photo Camera 3+CPU1+EMMC3+DDR3+speaker 1+speaker 2+motor1+Main Broad 1+ BT/WLAN Module+ Battery 1
4	LCD Panel 2+Photo Camera 2+Photo Camera 4+CPU1+EMMC4+DDR4+speaker 1+speaker 2+motor2+Main Broad 2+ BT/WLAN Module+ Battery 2
5	LCD Panel 1+Photo Camera 1+Photo Camera 3+CPU1+EMMC5+DDR5+speaker 1+speaker 2+motor1+Main Broad 1+ BT/WLAN Module+ Battery 1
6	LCD Panel 2+Photo Camera 2+Photo Camera 4+CPU1+EMMC6+DDR6+speaker 1+speaker 2+motor2+Main Broad 2+ BT/WLAN Module+ Battery 2

- The EUT incorporates a SISO function. Physically, the EUT provides one completed transmitter and one receiver.

MODULATION MODE	TX FUNCTION
802.11a	1TX/1RX
802.11n (20MHz)	1TX/1RX
802.11n (40MHz)	1TX/1RX
802.11ac (80MHz)	1TX/1RX

- For the test results, the EUT had been tested with all conditions. But only the worst case was shown in test report.

**List of Accessory:**

ACCESSORIES	BRAND	MODEL	SPECIFICATION
AC Adapter 1	Salom	SC-41	I/P:100-240Vac, 0.3A O/P: 5Vdc, 2A
AC Adapter 2	AcBel	SC-41	I/P:100-240Vac, 0.3A O/P: 5Vdc, 2A
Battery 1	SCUD	L16D2P31	Rating: 3.85Vdc, 7000mAh
Battery 2	Celxpert	L16D2P31	Rating: 3.85Vdc, 7000mAh
USB Cable 1	LiQi	L27B-052000100-TCCS	1.0m shielded cable w/o core
USB Cable 2	SaiBao	S27B-052000100-TCCS	1.0m shielded cable w/o core
LCD Panel1	BOE	TV101WUM-LL4	10.1 "
LCD Panel2	BOE	TV101WUM-LL5	10.1 "
Photo Camera 1	O-film	L4H7A00	8M AF
Photo Camera 2	Q-tech	F4H7YAZ	8M AF
Photo Camera 3	Lianyi	LE5220FM	5M FF
Photo Camera 4	Jinkang	G7B5-QL607XFF	5M FF
CPU	Qualcomm	SDA-450-A-792NSP-TR-01-0-AA	-
EMMC1+DDR1	SAMSUNG	KMRP60014M-B614(4+64)	64G
EMMC2+DDR2	HYNIX	H9TQ52ACLTCUR-KUM(4+64)	64G
EMMC3+DDR3	SAMSUNG	KMGD6001BM-B421(3+32)	32G
EMMC4+DDR4	HYNIX	H9TQ27ADFTMCUR-KUM(3+32)	32G
EMMC5+DDR5	SAMSUNG	KMQE60013M-B318(2+16)	16G
EMMC6+DDR6	HYNIX	H9TQ17ABJTCCUR-KUM(2+16)	16G
Speaker 1	Xichun	KFSC1712SBC-S-B232-20J-GT	-
Speaker 2	Xichun	KFSC1712SBC-S-B233-20J-W	-
speaker 1	Haosheng	HB171219B08-13-B1F-RH	-
speaker 2	Haosheng	XHB171219B08-14-B1F-RH	-
motor1	Hongzhifa	HZF-Z04BE-RL67B25-90	-
Motor2	Kunwang	CY0408L-021HB-064	-
Main Broad 1	Hongban	Aae_MB_PCB_V3	-
Main Broad 2	Huashen	Aae_MB_PCB_V3	-
BT/WLAN Module	Qualcomm	WCN-3680B-0-79BWLNSP-TR-05-1	-



2.2 DESCRIPTION OF TEST MODES

FOR 5150 ~ 5250MHz

4 channels are provided for 802.11a, 802.11n (20MHz):

CHANNEL	FREQUENCY	CHANNEL	FREQUENCY
36	5180 MHz	44	5220 MHz
40	5200 MHz	48	5240 MHz

2 channels are provided for 802.11n (40MHz):

CHANNEL	FREQUENCY	CHANNEL	FREQUENCY
38	5190 MHz	46	5230 MHz

1 channel is provided for 802.11ac (80MHz):

CHANNEL	FREQUENCY	CHANNEL	FREQUENCY
42	5210 MHz		

FOR 5250 ~ 5350MHz

4 channels are provided for 802.11a, 802.11n (20MHz):

CHANNEL	FREQUENCY	CHANNEL	FREQUENCY
52	5260 MHz	60	5300 MHz
56	5280 MHz	64	5320 MHz

2 channels are provided for 802.11n (40MHz):

CHANNEL	FREQUENCY	CHANNEL	FREQUENCY
54	5270 MHz	62	5310 MHz

1 channel is provided for 802.11ac (80MHz):

CHANNEL	FREQUENCY	CHANNEL	FREQUENCY
58	5290 MHz		



FOR 5470 ~ 5725MHz

8 channels are provided for 802.11a, 802.11n (20MHz):

CHANNEL	FREQUENCY	CHANNEL	FREQUENCY
100	5500 MHz	116	5580 MHz
104	5520 MHz	132	5660 MHz
108	5540 MHz	136	5680 MHz
112	5560 MHz	140	5700 MHz

3 channels are provided for 802.11n (40MHz):

CHANNEL	FREQUENCY	CHANNEL	FREQUENCY
102	5510 MHz	134	5670 MHz
110	5550 MHz		

1 channel is provided for 802.11ac (80MHz):

CHANNEL	FREQUENCY	CHANNEL	FREQUENCY
106	5530 MHz		

FOR 5725 ~ 5805MHz

4 channels are provided for 802.11a, 802.11n (20MHz):

CHANNEL	FREQUENCY	CHANNEL	FREQUENCY
149	5745 MHz	157	5785 MHz
153	5765 MHz	161	5805 MHz

2 channels are provided for 802.11n (40MHz):

CHANNEL	FREQUENCY	CHANNEL	FREQUENCY
151	5755 MHz	159	5795 MHz

1 channel is provided for 802.11ac (80MHz):

CHANNEL	FREQUENCY	CHANNEL	FREQUENCY
155	5775 MHz		



2.2.1 TEST MODE APPLICABILITY AND TESTED CHANNEL DETAIL

EUT CONFIGURE MODE	APPLICABLE TO				DESCRIPTION
	RE≥1G	RE<1G	PLC	APCM	
A	√	√	√	-	Powered by Adapter with wifi(5G) link
B	-	-	-	√	Powered by Battery with wifi(5G) link
C	-	-	-	-	Powered by USB with wifi(5G) link

Where **RE≥1G**: Radiated Emission above 1GHz **RE<1G**: Radiated Emission below 1GHz
PLC: Power Line Conducted Emission **APCM**: Antenna Port Conducted Measurement

NOTE:
The EUT had been pre-tested on the positioned of each 3 axis. The worst case was found when positioned on **X-plane**.
NOTE: "-" means no effect.

RADIATED EMISSION TEST (ABOVE 1GHz):

- Pre-Scan has been conducted to determine the worst-case mode from all possible combinations between available modulations, data rates and antenna ports (if EUT with antenna diversity architecture).
- Following channel(s) was (were) selected for the final test as listed below.

EUT CONFIGURE MODE	MODE	FREQ. BAND (MHz)	AVAILABLE CHANNEL	TESTED CHANNEL	MODULATION TECHNOLOGY	MODULATION TYPE	DATA RATE (Mbps)
A	802.11a	5180-5240	36 to 48	36, 40, 48	OFDM	BPSK	6.0
A	802.11n (20MHz)		36 to 48	36, 40, 48	OFDM	BPSK	MCS0
A	802.11n (40MHz)		38 to 46	38, 46	OFDM	BPSK	MCS0
A	802.11ac (80MHz)		42	42	OFDM	BPSK	V0
A	802.11a	5260-5320	52 to 64	52, 60, 64	OFDM	BPSK	6.0
A	802.11n (20MHz)		52 to 64	52, 60, 64	OFDM	BPSK	MCS0
A	802.11n (40MHz)		54 to 62	54, 62	OFDM	BPSK	MCS0
A	802.11ac (80MHz)		58	58	OFDM	BPSK	V0
A	802.11a	5500-5700	100 to 140	100, 116, 140	OFDM	BPSK	6.0
A	802.11n (20MHz)		100 to 140	100, 116, 140	OFDM	BPSK	MCS0
A	802.11n (40MHz)		102 to 134	102, 110, 134	OFDM	BPSK	MCS0
A	802.11ac (80MHz)		106	106	OFDM	BPSK	V0
A	802.11a	5725-5805	149 to 161	149, 157, 161	OFDM	BPSK	6.0
A	802.11n (20MHz)		149 to 161	149, 157, 161	OFDM	BPSK	MCS0
A	802.11n (40MHz)		151 to 159	151, 159	OFDM	BPSK	MCS0
A	802.11ac (80MHz)		155	155	OFDM	BPSK	V0



RADIATED EMISSION TEST (BELOW 1GHz):

- Pre-Scan has been conducted to determine the worst-case mode from all possible combinations between available modulations, data rates and antenna ports (if EUT with antenna diversity architecture).
- Following channel(s) was (were) selected for the final test as listed below.

EUT CONFIGURE MODE	MODE	FREQ. BAND (MHz)	AVAILABLE CHANNEL	TESTED CHANNEL	MODULATION TECHNOLOGY	MODULATION TYPE	DATA RATE (Mbps)
A	802.11n (40MHz)	5500-5700	102 to 134	102	OFDM	BPSK	MCS0

POWER LINE CONDUCTED EMISSION TEST:

- Pre-Scan has been conducted to determine the worst-case mode from all possible combinations between available modulations, data rates and antenna ports (if EUT with antenna diversity architecture).
- Following channel(s) was (were) selected for the final test as listed below.

EUT CONFIGURE MODE	MODE	FREQ. BAND (MHz)	AVAILABLE CHANNEL	TESTED CHANNEL	MODULATION TECHNOLOGY	MODULATION TYPE	DATA RATE (Mbps)
A	802.11n (40MHz)	5500-5700	102 to 134	102	OFDM	BPSK	MCS0

BANDEDGE MEASUREMENT:

- Pre-Scan has been conducted to determine the worst-case mode from all possible combinations between available modulations, data rates and antenna ports (if EUT with antenna diversity architecture).
- Following channel(s) was (were) selected for the final test as listed below.

EUT CONFIGURE MODE	MODE	FREQ. BAND (MHz)	AVAILABLE CHANNEL	TESTED CHANNEL	MODULATION TECHNOLOGY	MODULATION TYPE	DATA RATE (Mbps)
A	802.11a	5180-5240	36 to 48	36, 40, 48	OFDM	BPSK	6.0
A	802.11n (20MHz)		36 to 48	36, 40, 48	OFDM	BPSK	MCS0
A	802.11n (40MHz)		38 to 46	38, 46	OFDM	BPSK	MCS0
A	802.11ac (80MHz)		42	42	OFDM	BPSK	V0
A	802.11a	5260-5320	52 to 64	52, 60, 64	OFDM	BPSK	6.0
A	802.11n (20MHz)		52 to 64	52, 60, 64	OFDM	BPSK	MCS0
A	802.11n (40MHz)		54 to 62	54, 62	OFDM	BPSK	MCS0
A	802.11ac (80MHz)		58	58	OFDM	BPSK	V0
A	802.11a	5500-5700	100 to 140	100, 116, 140	OFDM	BPSK	6.0
A	802.11n (20MHz)		100 to 140	100, 116, 140	OFDM	BPSK	MCS0
A	802.11n (40MHz)		102 to 134	102, 110, 134	OFDM	BPSK	MCS0
A	802.11ac (80MHz)		106	106	OFDM	BPSK	V0
A	802.11a	5725-5805	149 to 161	149, 157, 161	OFDM	BPSK	6.0
A	802.11n (20MHz)		149 to 161	149, 157, 161	OFDM	BPSK	MCS0
A	802.11n (40MHz)		151 to 159	151, 159	OFDM	BPSK	MCS0
A	802.11ac (80MHz)		155	155	OFDM	BPSK	V0



ANTENNA PORT CONDUCTED MEASUREMENT:

- This item includes all test value of each mode, but only includes spectrum plot of worst value of each mode.
- Pre-Scan has been conducted to determine the worst-case mode from all possible combinations between available modulations, data rates and antenna ports (if EUT with antenna diversity architecture).
- Following channel(s) was (were) selected for the final test as listed below.

EUT CONFIGURE MODE	MODE	FREQ. BAND (MHz)	AVAILABLE CHANNEL	TESTED CHANNEL	MODULATION TECHNOLOGY	MODULATION TYPE	DATA RATE (Mbps)
A	802.11a	5180-5240	36 to 48	36, 40, 48	OFDM	BPSK	6.0
A	802.11n (20MHz)		36 to 48	36, 40, 48	OFDM	BPSK	MCS0
A	802.11n (40MHz)		38 to 46	38, 46	OFDM	BPSK	MCS0
A	802.11ac (80MHz)		42	42	OFDM	BPSK	V0
A	802.11a	5260-5320	52 to 64	52, 60, 64	OFDM	BPSK	6.0
A	802.11n (20MHz)		52 to 64	52, 60, 64	OFDM	BPSK	MCS0
A	802.11n (40MHz)		54 to 62	54, 62	OFDM	BPSK	MCS0
A	802.11ac (80MHz)		58	58	OFDM	BPSK	V0
A	802.11a	5500-5700	100 to 140	100, 116, 140	OFDM	BPSK	6.0
A	802.11n (20MHz)		100 to 140	100, 116, 140	OFDM	BPSK	MCS0
A	802.11n (40MHz)		102 to 134	102, 110, 134	OFDM	BPSK	MCS0
A	802.11ac (80MHz)		106	106	OFDM	BPSK	V0
A	802.11a	5725-5805	149 to 161	149, 157, 161	OFDM	BPSK	6.0
A	802.11n (20MHz)		149 to 161	149, 157, 161	OFDM	BPSK	MCS0
A	802.11n (40MHz)		151 to 159	151, 159	OFDM	BPSK	MCS0
A	802.11ac (80MHz)		155	155	OFDM	BPSK	V0

TEST CONDITION:

APPLICABLE TO	ENVIRONMENTAL CONDITIONS	INPUT POWER	TESTED BY
RE<1G	23deg. C, 62%RH	DC 5V By Adapter	Star Le
RE≥1G	23deg. C, 62%RH	DC 5V By Adapter	Star Le
PLC	24deg. C, 61%RH	DC 5V By Adapter	John Wen
APCM	23.5deg. C, 60%RH	DC 3.85V By battery	Rain Wang



2.3 DUTY CYCLE OF TEST SIGNAL

Duty cycle of test signal is < 98%, duty factor shall be considered.

802.11a: Duty cycle = 1.361/1.563 = 0.871, Duty factor = 10 * log(1/0.871) = 0.60

802.11n (20MHz): Duty cycle = 1.273/1.495 = 0.852, Duty factor = 10 * log(1/0.852) = 0.70

802.11n (40MHz): Duty cycle = 0.636/0.848 = 0.750, Duty factor = 10 * log(1/0.750) = 1.25

802.11ac (80MHz): Duty cycle = 0.244/0.450 = 0.542, Duty factor = 10 * log(1/0.542) = 2.66

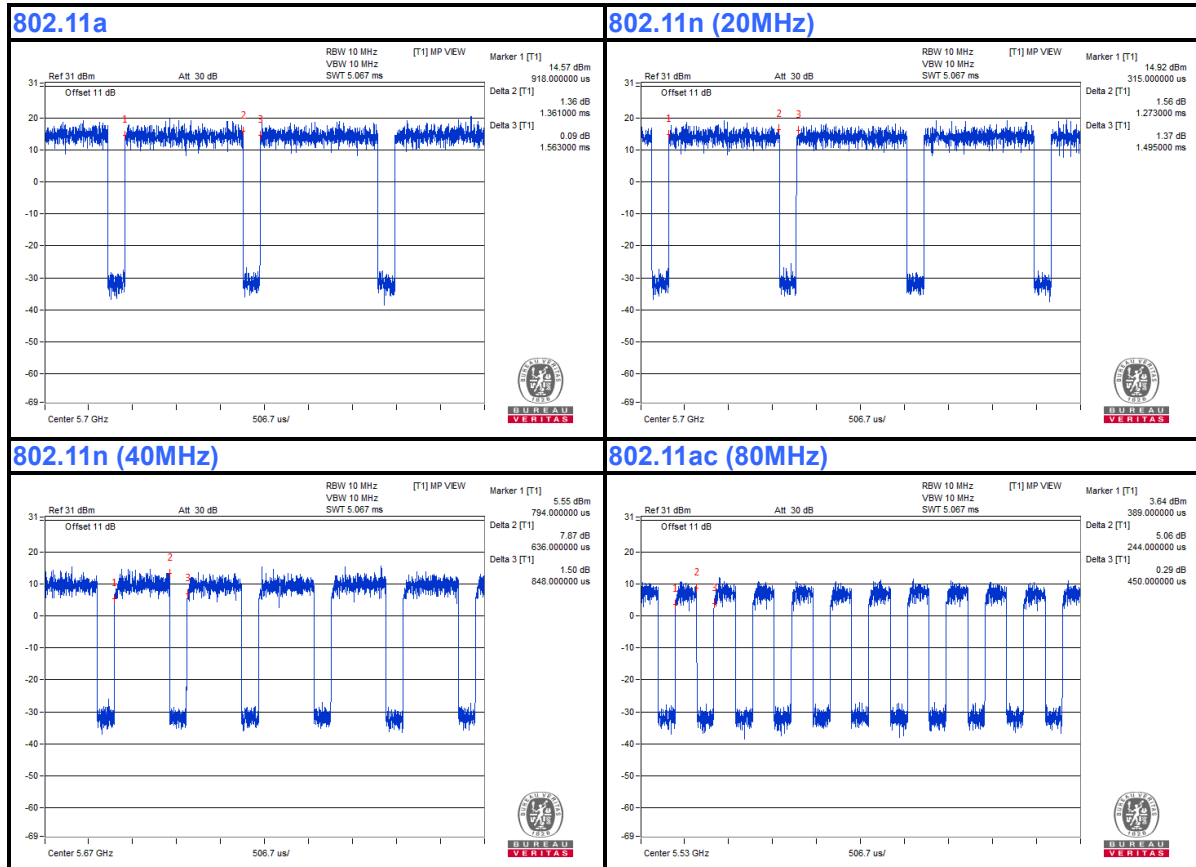



2.4 DESCRIPTION OF SUPPORT UNITS

The EUT has been tested as an independent unit together with other necessary accessories or support units. The following support units or accessories were used to form a representative test configuration during the tests.

NO.	PRODUCT	BRAND	MODEL NO.	SERIAL NO.	FCC ID
1	DC source	LONG WEI	PS-6403D	010934269	N/A
2	PC	HP	A6608CN	3CR83825X3	N/A

NO.	SIGNAL CABLE DESCRIPTION OF THE ABOVE SUPPORT UNITS
1	DC Line: Unshielded, Detachable 1.0m
2	AC Line: Unshielded, Detachable 1.5m

NOTE:

1. All power cords of the above support units are non shielded (1.8m).

2.4.1 CONFIGURATION OF SYSTEM UNDER TEST

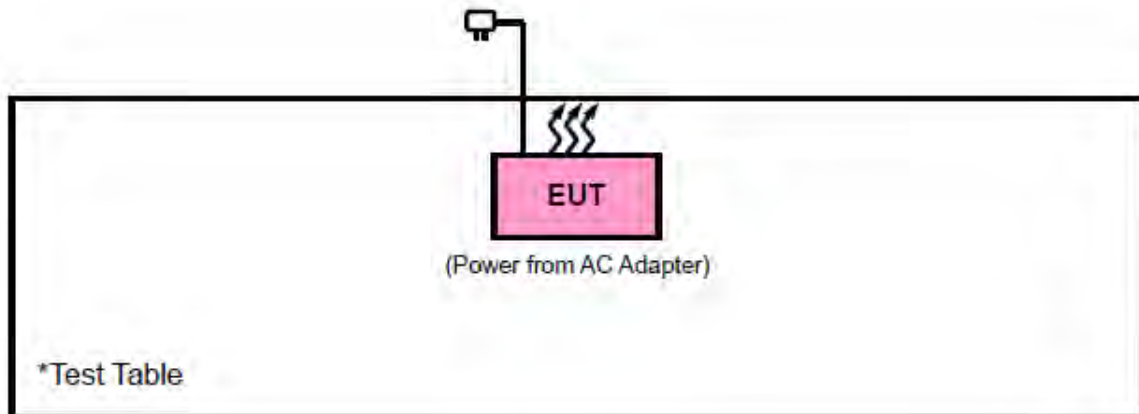



2.5 GENERAL DESCRIPTION OF APPLIED STANDARDS

The EUT is a RF Product. According to the specifications of the manufacturer, it must comply with the requirements of the following standards:

FCC Part 15, Subpart E (15.407)

KDB 789033 D02 General U-NII Test Procedures New Rules v02r01

ANSI C63.10-2013

All test items have been performed and recorded as per the above standards.

NOTE: The EUT is also considered as a kind of computer peripheral, because the connection to computer is necessary for typical use. It has been verified to comply with the requirements of FCC Part 15, Subpart B, Class B (Certification). The test report has been issued separately.



3 TEST TYPES AND RESULTS

3.1 RADIATED EMISSION AND BANDEDGE MEASUREMENT

3.1.1 LIMITS OF RADIATED EMISSION AND BANDEDGE MEASUREMENT

Radiated emissions which fall in the restricted bands must comply with the radiated emission limits specified as below table:

FREQUENCIES (MHz)	FIELD STRENGTH (microvolts/meter)	MEASUREMENT DISTANCE (meters)
0.009 ~ 0.490	2400/F(kHz)	300
0.490 ~ 1.705	24000/F(kHz)	30
1.705 ~ 30.0	30	30
30 ~ 88	100	3
88 ~ 216	150	3
216 ~ 960	200	3
Above 960	500	3

NOTE:

1. The lower limit shall apply at the transition frequencies.
2. Emission level (dBuV/m) = 20 log Emission level (uV/m).
3. For frequencies above 1000MHz, the field strength limits are based on average detector, however, the peak field strength of any emission shall not exceed the maximum permitted average limits, specified above by more than 20dB under any condition of modulation.

3.1.2 LIMITS OF UNWANTED EMISSION

RESTRICTED BANDS	APPLICABLE TO	LIMIT	
	789033 D02 General UNII Test Procedures New Rules v01r02	FIELD STRENGTH AT 3m (dBµV/m)	
	PK : 74	AV : 54	
OUT OF THE RESTRICTED BANDS	APPLICABLE TO	EIRP LIMIT (dBm/MHz)	EQUIVALENT FIELD STRENGTH AT 3m (dBµV/m)
	15.407(b)(1)	PK : -27	PK : 68.3
	15.407(b)(2)		
	15.407(b)(3)		
	15.407(b)(4)	See note 2 (FCC 16-24)	



NOTE: The following formula is used to convert the equipment isotropic radiated power (eirp) to field strength:

$$E = \frac{1000000}{3} \sqrt{30 P} \text{ } \mu\text{V/m, where P is the eirp (Watts).}$$

2. All emissions shall be limited to a level of -27 dBm/MHz at 75 MHz or more above or below the band edge increasing linearly to 10 dBm/MHz at 25 MHz above or below the band edge, and from 25 MHz above or below the band edge increasing linearly to a level of 15.6 dBm/MHz at 5 MHz above or below the band edge, and from 5 MHz above or below the band edge increasing linearly to a level of 27 dBm/MHz at the band edge.

3.1.3 TEST INSTRUMENTS

Equipment	Manufacturer	Model No.	Serial No.	Last Cal.	Next Cal.
3m Semi-anechoic Chamber	ETS-LINDGREN	9m*6m*6m	Euroshieldpn-CT0001143-1216	Feb. 26,19	Feb. 25,20
Bilog Antenna	ETS-LINDGREN	3143B	00161965	Feb. 26,19	Feb. 25,20
Horn Antenna	ETS-LINDGREN	3117	00168728	Feb. 26,19	Feb. 25,20
Loop antenna	Daze	ZN30900A	0708	Oct. 23,18	Oct. 22, 19
Horn Antenna (18GHz-40GHz)	N/A	QWH-SL-18-40-K-SG/QMS-00361	15433	Nov. 21, 18	Nov. 20, 19
Test Software	E3	V 9.160323	N/A	N/A	N/A
Test Software	ADT	ADT_Radiated_V7.6.15.9.2	N/A	N/A	N/A
10dB Attenuator	JFW/USA	50HF-010-SMA	1505	Jul. 09,18	Jul. 08,19
MXE EMI Receiver	KEYSIGHT	N9038A-544	MY54450026	Feb. 26,19	Feb. 25,20
Signal Pre-Amplifier	EMSI	EMC 9135	980249	Jul. 09,18	Jul. 08,19
Signal Pre-Amplifier	EMSI	EMC 012645B	980257	Jul. 09,18	Jul. 08,19
Signal Pre-Amplifier	EMSI	EMC 184045B	980259	Jul. 09,18	Jul. 08,19

NOTE:

1. The calibration interval of the above test instruments is 12 months and the calibrations are traceable to CEPREI/CHINA, GRGT/CHINA and NIM/CHINA.
2. The test was performed in 3m Chamber.
3. The FCC Site Registration No. is 525120; The Designation No. is CN1171.

3.1.4 TEST PROCEDURES

- a. The EUT was placed on the top of a rotating table 0.8 meters (for below 1GHz) / 1.5 meters (for above 1GHz) above the ground at 3 meter chamber room for test. The table was rotated 360 degrees to determine the position of the highest radiation.
- b. The EUT was set 3 meters away from the interference-receiving antenna, which was mounted on the top of a variable-height antenna tower.
- c. The antenna is a broadband antenna, and its height is varied from one meter to four meters above the ground to determine the maximum value of the field strength. Both horizontal and vertical polarizations of the antenna are set to make the measurement.
- d. For each suspected emission, the EUT was arranged to its worst case and then the antenna was tuned to heights from 1 meter to 4 meters and the rotatable table was turned from 0 degrees to 360 degrees to find the maximum reading.
- e. The test-receiver system was set to Peak Detect Function and Specified Bandwidth with Maximum Hold Mode.
- f. If the emission level of the EUT in peak mode was 10dB lower than the limit specified, then testing could be stopped and the peak values of the EUT would be reported. Otherwise the emissions that did not have 10dB margin would be re-tested one by one using peak, quasi-peak or average method as specified and then reported in a data sheet.

NOTE:

1. The resolution bandwidth and video bandwidth of test receiver/spectrum analyzer is 120kHz for Peak detection (PK) and Quasi-peak detection (QP) at frequency below 1GHz.
2. The resolution bandwidth of test receiver/spectrum analyzer is 1MHz and video bandwidth is 3MHz for Peak detection at frequency above 1GHz.
3. The resolution bandwidth of test receiver/spectrum analyzer is 1MHz and the video bandwidth is 10Hz for Average detection (AV) at frequency above 1GHz.
4. All modes of operation were investigated and the worst-case emissions are reported.

3.1.5 DEVIATION FROM TEST STANDARD

No deviation.



3.1.6 TEST SETUP

< Frequency Range below 30MHz >

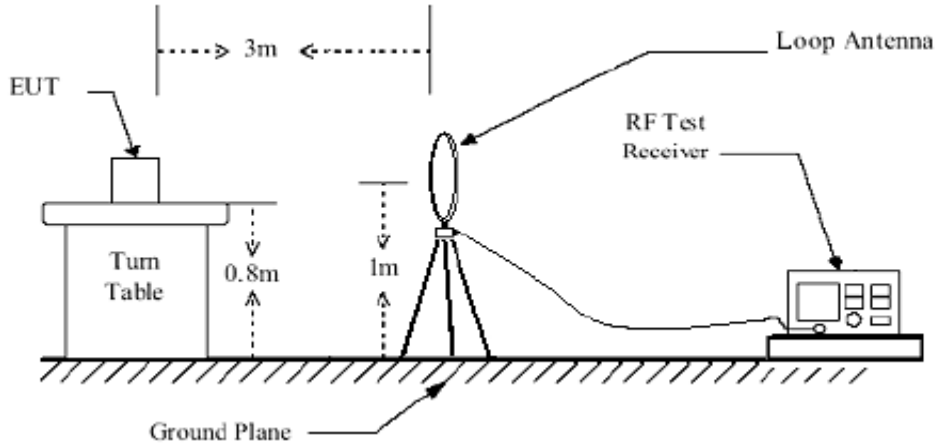

< Frequency Range 30MHz~1GHz >

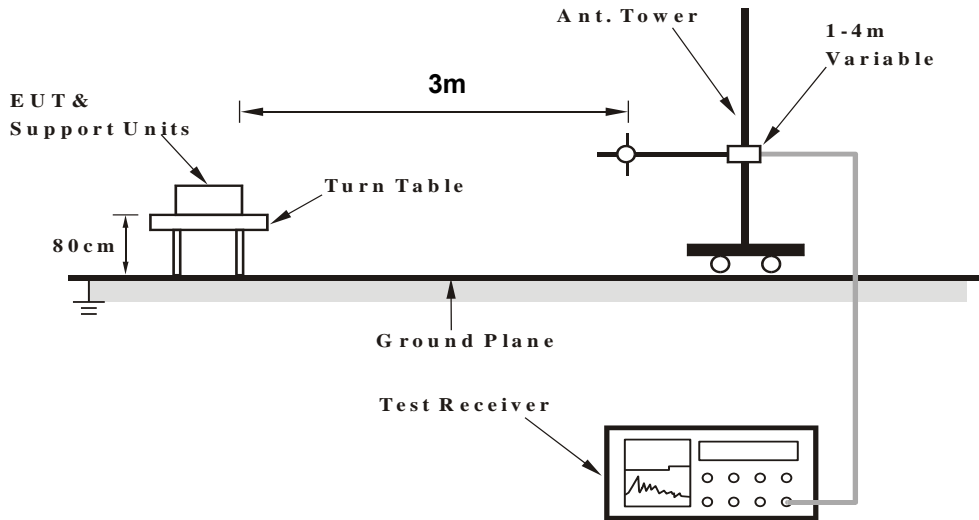



<Frequency Range above 1GHz>

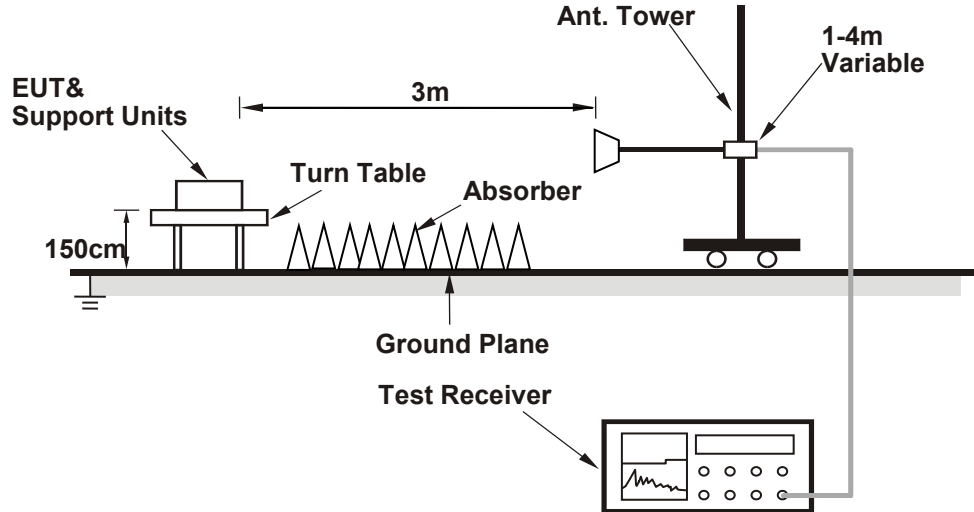

For the actual test configuration, please refer to the attached file (Test Setup Photo).

3.1.7 EUT OPERATING CONDITION

- a. Set the EUT under full load condition and placed them on a testing table.
- b. Set the transmitter part of EUT under transmission condition continuously at specific channel frequency.
- c. The necessary accessories enable the EUT in full functions.



3.1.8 TEST RESULTS

BELOW 1GHz WORST-CASE DATA:

9 KHz – 30 MHz data: the amplitude of spurious emissions attenuated more than 20 dB below the permissible value is not required in the report.

30 MHz – 1GHz data:

802.11n (40MHz)

CHANNEL	TX Channel 102	DETECTOR FUNCTION	Quasi-Peak (QP)
FREQUENCY RANGE	30MHz ~ 1GHz		

ANTENNA POLARITY & TEST DISTANCE: HORIZONTAL AT 3 M										
FREQ. (MHz)	EMISSION LEVEL (dBuV/m)	READ LEVEL (dBuV)	LIMIT (dBuV/m)	MARGIN (dB)	ANTENNA FACTOR (dB /m)	CABLE LOSS (dB)	PREAMP FACTOR (dB)	ANTENNA HEIGHT (cm)	TABLE ANGLE (Degree)	REMARK
30.97	16.24	36.01	40	-23.76	16.8	0.79	37.36	100	0	QP
89.17	12.41	39.93	43.5	-31.09	8.47	1.27	37.26	100	0	QP
183.26	29.48	54.02	43.5	-14.02	10.38	1.71	36.63	100	0	QP
286.08	29.81	50.58	46	-16.19	13.79	2.16	36.72	100	0	QP
369.5	21.21	39.28	46	-24.79	16.25	2.49	36.81	100	0	QP
422.85	26.58	43.25	46	-19.42	17.5	2.7	36.87	100	0	QP

REMARKS:

1. Emission level (dBuV/m) = Raw Value (dBuV) + Correction Factor (dB/m).
2. Correction Factor (dB/m) = Antenna Factor (dB/m) + Cable Factor (dB).
3. The other emission levels were very low against the limit.
4. Margin value = Emission level – Limit value.

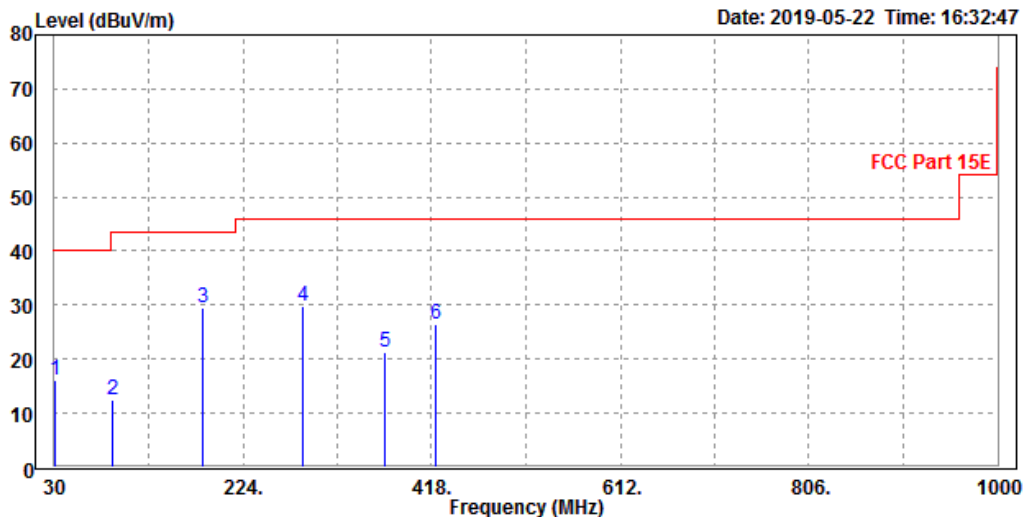



CHANNEL	Channel 102	DETECTOR FUNCTION	Quasi-Peak (QP)
FREQUENCY RANGE	30MHz ~ 1GHz		

ANTENNA POLARITY & TEST DISTANCE: VERTICAL AT 3 M										
FREQ. (MHz)	EMISSION LEVEL (dBuV/m)	READ LEVEL (dBuV)	LIMIT (dBuV/m)	MARGIN (dB)	ANTENNA FACTOR (dB /m)	CABLE LOSS (dB)	PREAMP FACTOR (dB)	ANTENNA HEIGHT (cm)	TABLE ANGLE (Degree)	REMARK
38.73	21.7	44.55	40	-18.3	13.78	0.9	37.53	100	360	QP
86.26	16.65	44.19	40	-23.35	8.49	1.25	37.28	100	360	QP
138.64	15.68	42.26	43.5	-27.82	8.79	1.55	36.92	100	360	QP
190.05	18.78	43.02	43.5	-24.72	10.6	1.75	36.59	100	360	QP
285.11	24.13	44.79	46	-21.87	13.9	2.16	36.72	100	360	QP
486.87	23.32	38.84	46	-22.68	18.52	2.94	36.98	100	360	QP

REMARKS:

1. Emission level (dBuV/m) = Raw Value (dBuV) + Correction Factor (dB/m).
2. Correction Factor (dB/m) = Antenna Factor (dB/m) + Cable Factor (dB).
3. The other emission levels were very low against the limit.
4. Margin value = Emission level – Limit value.

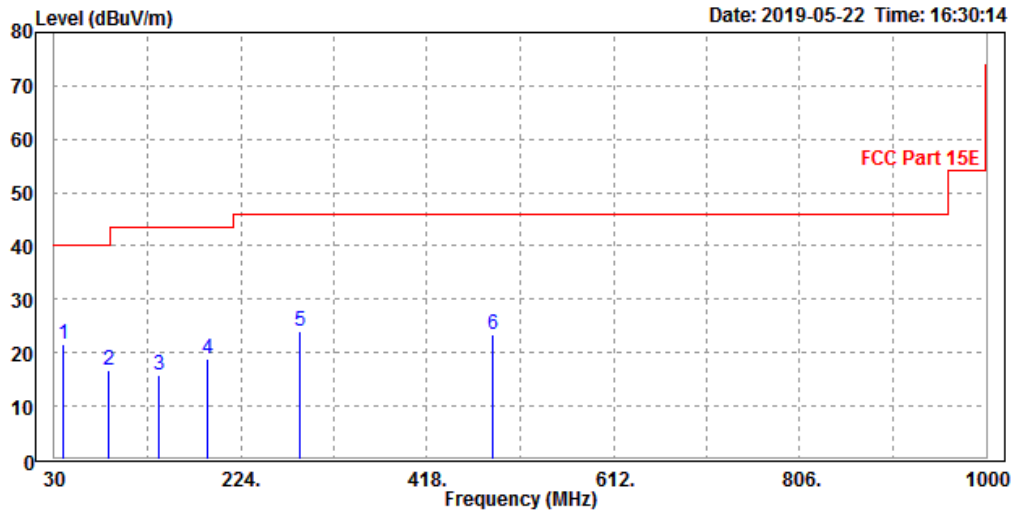



ABOVE 1GHz WORST-CASE DATA:

Note: For higher frequency, the emission is too low to be detected.

Band 1

802.11a

CHANNEL	TX Channel 36	DETECTOR FUNCTION	Peak (PK)
FREQUENCY RANGE	1GHz ~ 40GHz		Average (AV)

ANTENNA POLARITY & TEST DISTANCE: HORIZONTAL AT 3 M										
FREQ. (MHz)	EMISSION LEVEL (dBuV/m)	READ LEVEL (dBuV)	LIMIT (dBuV/m)	MARGIN (dB)	ANTENNA FACTOR (dB /m)	CABLE LOSS (dB)	PREAMP FACTOR (dB)	ANTENNA HEIGHT (cm)	TABLE ANGLE (Degree)	REMARK
5150	46.83	49.81	54	-7.17	35.95	7.42	46.35	100	123	Average
5150	49.91	52.89	74	-24.09	35.95	7.42	46.35	100	123	Peak
5180	95.64	98.58			35.98	7.43	46.35	100	123	Average
5180	106.97	109.91			35.98	7.43	46.35	100	123	Peak
5350	45.45	48.13	54	-8.55	36.15	7.47	46.3	100	123	Average
5350	50.68	53.36	74	-23.32	36.15	7.47	46.3	100	123	Peak

ANTENNA POLARITY & TEST DISTANCE: VERTICAL AT 3 M										
FREQ. (MHz)	EMISSION LEVEL (dBuV/m)	READ LEVEL (dBuV)	LIMIT (dBuV/m)	MARGIN (dB)	ANTENNA FACTOR (dB /m)	CABLE LOSS (dB)	PREAMP FACTOR (dB)	ANTENNA HEIGHT (cm)	TABLE ANGLE (Degree)	REMARK
5150	47.34	49.98	54	-6.66	36.29	7.42	46.35	105	101	Average
5150	53.77	56.41	74	-20.23	36.29	7.42	46.35	105	101	Peak
5180	96.68	99.29			36.31	7.43	46.35	105	101	Average
5180	106.12	108.73			36.31	7.43	46.35	105	101	Peak
5350	45.74	48.16	54	-8.26	36.41	7.47	46.3	105	101	Average
5350	56.17	58.59	74	-17.83	36.41	7.47	46.3	105	101	Peak

REMARKS:

- Emission Level = Read Level+ Antenna Factor + Cable Loss- Preamp Factor
Margin value = Emission level – Limit value.
- 5180MHz: Fundamental frequency.



CHANNEL	TX Channel 40	DETECTOR FUNCTION	Peak (PK)
FREQUENCY RANGE	1GHz ~ 40GHz		Average (AV)

ANTENNA POLARITY & TEST DISTANCE: HORIZONTAL AT 3 M										
FREQ. (MHz)	EMISSION LEVEL (dBuV/m)	READ LEVEL (dBuV)	LIMIT (dBuV/m)	MARGIN (dB)	ANTENNA FACTOR (dB /m)	CABLE LOSS (dB)	PREAMP FACTOR (dB)	ANTENNA HEIGHT (cm)	TABLE ANGLE (Degree)	REMARK
5150	50.56	53.54	54	-3.44	35.95	7.42	46.35	100	128	Average
5150	58.54	61.52	74	-15.46	35.95	7.42	46.35	100	128	Peak
5200	103.32	106.23			36	7.43	46.34	100	128	Average
5200	112.37	115.28			36	7.43	46.34	100	128	Peak
5350	45.47	48.15	54	-8.53	36.15	7.47	46.3	100	128	Average
5350	54.89	57.57	74	-19.11	36.15	7.47	46.3	100	128	Peak
ANTENNA POLARITY & TEST DISTANCE: VERTICAL AT 3 M										
FREQ. (MHz)	EMISSION LEVEL (dBuV/m)	READ LEVEL (dBuV)	LIMIT (dBuV/m)	MARGIN (dB)	ANTENNA FACTOR (dB /m)	CABLE LOSS (dB)	PREAMP FACTOR (dB)	ANTENNA HEIGHT (cm)	TABLE ANGLE (Degree)	REMARK
5150	42.24	44.88	54	-11.76	36.29	7.42	46.35	100	273	Average
5150	48.97	51.61	74	-25.03	36.29	7.42	46.35	100	273	Peak
5200	92.87	95.46			36.32	7.43	46.34	100	273	Average
5200	101.25	103.84			36.32	7.43	46.34	100	273	Peak
5350	38.34	40.76	54	-15.66	36.41	7.47	46.3	100	273	Average
5350	50.13	52.55	74	-23.87	36.41	7.47	46.3	100	273	Peak

REMARKS:

- Emission Level = Read Level+ Antenna Factor + Cable Loss- Preamp Factor
Margin value = Emission level – Limit value.
- 5200MHz: Fundamental frequency.



CHANNEL	TX Channel 48	DETECTOR FUNCTION	Peak (PK)
FREQUENCY RANGE	1GHz ~ 40GHz		Average (AV)

ANTENNA POLARITY & TEST DISTANCE: HORIZONTAL AT 3 M										
FREQ. (MHz)	EMISSION LEVEL (dBuV/m)	READ LEVEL (dBuV)	LIMIT (dBuV/m)	MARGIN (dB)	ANTENNA FACTOR (dB /m)	CABLE LOSS (dB)	PREAMP FACTOR (dB)	ANTENNA HEIGHT (cm)	TABLE ANGLE (Degree)	REMARK
5150	47.41	50.39	54	-6.59	35.95	7.42	46.35	102	131	Average
5150	54.44	57.42	74	-19.56	35.95	7.42	46.35	102	131	Peak
5240	103.9	106.75			36.04	7.44	46.33	102	131	Average
5240	113.36	116.21			36.04	7.44	46.33	102	131	Peak
5350	44.36	47.04	54	-9.64	36.15	7.47	46.3	102	131	Average
5350	54.92	57.6	74	-19.08	36.15	7.47	46.3	102	131	Peak
ANTENNA POLARITY & TEST DISTANCE: VERTICAL AT 3 M										
FREQ. (MHz)	EMISSION LEVEL (dBuV/m)	READ LEVEL (dBuV)	LIMIT (dBuV/m)	MARGIN (dB)	ANTENNA FACTOR (dB /m)	CABLE LOSS (dB)	PREAMP FACTOR (dB)	ANTENNA HEIGHT (cm)	TABLE ANGLE (Degree)	REMARK
5150	40.41	43.05	54	-13.59	36.29	7.42	46.35	100	275	Average
5150	50.21	52.85	74	-23.79	36.29	7.42	46.35	100	275	Peak
5240	93.69	96.24			36.34	7.44	46.33	100	275	Average
5240	102.64	105.19			36.34	7.44	46.33	100	275	Peak
5350	38.42	40.84	54	-15.58	36.41	7.47	46.3	100	275	Average
5350	47.62	50.04	74	-26.38	36.41	7.47	46.3	100	275	Peak

REMARKS:

- Emission Level = Read Level+ Antenna Factor + Cable Loss- Preamp Factor
Margin value = Emission level – Limit value.
- 5240MHz: Fundamental frequency.



802.11n (20MHz)

CHANNEL	TX Channel 36	DETECTOR FUNCTION	Peak (PK)
FREQUENCY RANGE	1GHz ~ 40GHz		Average (AV)

ANTENNA POLARITY & TEST DISTANCE: HORIZONTAL AT 3 M										
FREQ. (MHz)	EMISSION LEVEL (dBuV/m)	READ LEVEL (dBuV)	LIMIT (dBuV/m)	MARGIN (dB)	ANTENNA FACTOR (dB /m)	CABLE LOSS (dB)	PREAMP FACTOR (dB)	ANTENNA HEIGHT (cm)	TABLE ANGLE (Degree)	REMARK
5150	40.2	43.18	54	-13.8	35.95	7.42	46.35	100	322	Average
5150	49.11	52.09	74	-24.89	35.95	7.42	46.35	100	322	Peak
5180	93.24	96.18			35.98	7.43	46.35	100	322	Average
5180	103.47	106.41			35.98	7.43	46.35	100	322	Peak
5350	38.37	41.05	54	-15.63	36.15	7.47	46.3	100	322	Average
5350	46.95	49.63	74	-27.05	36.15	7.47	46.3	100	322	Peak
ANTENNA POLARITY & TEST DISTANCE: VERTICAL AT 3 M										
FREQ. (MHz)	EMISSION LEVEL (dBuV/m)	READ LEVEL (dBuV)	LIMIT (dBuV/m)	MARGIN (dB)	ANTENNA FACTOR (dB /m)	CABLE LOSS (dB)	PREAMP FACTOR (dB)	ANTENNA HEIGHT (cm)	TABLE ANGLE (Degree)	REMARK
5150	39.55	42.19	54	-14.45	36.29	7.42	46.35	100	318	Average
5150	48.48	51.12	74	-25.52	36.29	7.42	46.35	100	318	Peak
5180	94.3	96.91			36.31	7.43	46.35	100	318	Average
5180	103.77	106.38			36.31	7.43	46.35	100	318	Peak
5350	38.64	41.06	54	-15.36	36.41	7.47	46.3	100	318	Average
5350	50.25	52.67	74	-23.75	36.41	7.47	46.3	100	318	Peak

REMARKS:

- Emission Level = Read Level+ Antenna Factor + Cable Loss- Preamp Factor
Margin value = Emission level – Limit value.
- 5180MHz: Fundamental frequency.



CHANNEL	TX Channel 40	DETECTOR FUNCTION	Peak (PK)
FREQUENCY RANGE	1GHz ~ 40GHz		Average (AV)

ANTENNA POLARITY & TEST DISTANCE: HORIZONTAL AT 3 M										
FREQ. (MHz)	EMISSION LEVEL (dBuV/m)	READ LEVEL (dBuV)	LIMIT (dBuV/m)	MARGIN (dB)	ANTENNA FACTOR (dB /m)	CABLE LOSS (dB)	PREAMP FACTOR (dB)	ANTENNA HEIGHT (cm)	TABLE ANGLE (Degree)	REMARK
5150	43.33	46.31	54	-10.67	35.95	7.42	46.35	100	319	Average
5150	50.47	53.45	74	-23.53	35.95	7.42	46.35	100	319	Peak
5200	93.66	96.57			36	7.43	46.34	100	319	Average
5200	102.63	105.54			36	7.43	46.34	100	319	Peak
5350	38.31	40.99	54	-15.69	36.15	7.47	46.3	100	319	Average
5350	46.43	49.11	74	-27.57	36.15	7.47	46.3	100	319	Peak
ANTENNA POLARITY & TEST DISTANCE: VERTICAL AT 3 M										
FREQ. (MHz)	EMISSION LEVEL (dBuV/m)	READ LEVEL (dBuV)	LIMIT (dBuV/m)	MARGIN (dB)	ANTENNA FACTOR (dB /m)	CABLE LOSS (dB)	PREAMP FACTOR (dB)	ANTENNA HEIGHT (cm)	TABLE ANGLE (Degree)	REMARK
5150	43.59	46.23	54	-10.41	36.29	7.42	46.35	100	319	Average
5150	51.04	53.68	74	-22.96	36.29	7.42	46.35	100	319	Peak
5200	94.02	96.61			36.32	7.43	46.34	100	319	Average
5200	103.64	106.23			36.32	7.43	46.34	100	319	Peak
5350	38.69	41.11	54	-15.31	36.41	7.47	46.3	100	319	Average
5350	48.53	50.95	74	-25.47	36.41	7.47	46.3	100	319	Peak

REMARKS:

- Emission Level = Read Level+ Antenna Factor + Cable Loss- Preamp Factor
Margin value = Emission level – Limit value.
- 5200MHz: Fundamental frequency.



CHANNEL	TX Channel 48	DETECTOR FUNCTION	Peak (PK)
FREQUENCY RANGE	1GHz ~ 40GHz		Average (AV)

ANTENNA POLARITY & TEST DISTANCE: HORIZONTAL AT 3 M										
FREQ. (MHz)	EMISSION LEVEL (dBuV/m)	READ LEVEL (dBuV)	LIMIT (dBuV/m)	MARGIN (dB)	ANTENNA FACTOR (dB /m)	CABLE LOSS (dB)	PREAMP FACTOR (dB)	ANTENNA HEIGHT (cm)	TABLE ANGLE (Degree)	REMARK
5150	40.23	43.21	54	-13.77	35.95	7.42	46.35	100	323	Average
5150	50.53	53.51	74	-23.47	35.95	7.42	46.35	100	323	Peak
5240	95.09	97.94			36.04	7.44	46.33	100	323	Average
5240	103.7	106.55			36.04	7.44	46.33	100	323	Peak
5350	38.41	41.09	54	-15.59	36.15	7.47	46.3	100	323	Average
5350	47.74	50.42	74	-26.26	36.15	7.47	46.3	100	323	Peak

ANTENNA POLARITY & TEST DISTANCE: VERTICAL AT 3 M										
FREQ. (MHz)	EMISSION LEVEL (dBuV/m)	READ LEVEL (dBuV)	LIMIT (dBuV/m)	MARGIN (dB)	ANTENNA FACTOR (dB /m)	CABLE LOSS (dB)	PREAMP FACTOR (dB)	ANTENNA HEIGHT (cm)	TABLE ANGLE (Degree)	REMARK
5150	40.74	43.38	54	-13.26	36.29	7.42	46.35	100	320	Average
5150	50.58	53.22	74	-23.42	36.29	7.42	46.35	100	320	Peak
5240	95.35	97.9			36.34	7.44	46.33	100	320	Average
5240	104.68	107.23			36.34	7.44	46.33	100	320	Peak
5350	38.6	41.02	54	-15.4	36.41	7.47	46.3	100	320	Average
5350	47.99	50.41	74	-26.01	36.41	7.47	46.3	100	320	Peak

REMARKS:

- Emission Level = Read Level+ Antenna Factor + Cable Loss- Preamp Factor
Margin value = Emission level – Limit value.
- 5240MHz: Fundamental frequency.



802.11n (40MHz)

CHANNEL	TX Channel 38	DETECTOR FUNCTION	Peak (PK)
FREQUENCY RANGE	1GHz ~ 40GHz		Average (AV)

ANTENNA POLARITY & TEST DISTANCE: HORIZONTAL AT 3 M										
FREQ. (MHz)	EMISSION LEVEL (dBuV/m)	READ LEVEL (dBuV)	LIMIT (dBuV/m)	MARGIN (dB)	ANTENNA FACTOR (dB /m)	CABLE LOSS (dB)	PREAMP FACTOR (dB)	ANTENNA HEIGHT (cm)	TABLE ANGLE (Degree)	REMARK
5150	50.54	53.52	54	-3.46	35.95	7.42	46.35	175	315	Average
5150	62.84	65.82	74	-11.16	35.95	7.42	46.35	175	315	Peak
5190	91.23	94.15			35.99	7.43	46.34	175	315	Average
5190	96.66	99.58			35.99	7.43	46.34	175	315	Peak
5350	38	40.68	54	-16	36.15	7.47	46.3	175	315	Average
5350	47.46	50.14	74	-26.54	36.15	7.47	46.3	175	315	Peak

ANTENNA POLARITY & TEST DISTANCE: VERTICAL AT 3 M										
FREQ. (MHz)	EMISSION LEVEL (dBuV/m)	READ LEVEL (dBuV)	LIMIT (dBuV/m)	MARGIN (dB)	ANTENNA FACTOR (dB /m)	CABLE LOSS (dB)	PREAMP FACTOR (dB)	ANTENNA HEIGHT (cm)	TABLE ANGLE (Degree)	REMARK
5150	43.08	45.72	54	-10.92	36.29	7.42	46.35	100	331	Average
5150	53.37	56.01	74	-20.63	36.29	7.42	46.35	100	331	Peak
5190	87.61	90.21			36.31	7.43	46.34	100	331	Average
5190	97.26	99.86			36.31	7.43	46.34	100	331	Peak
5350	38.49	40.91	54	-15.51	36.41	7.47	46.3	191	331	Average
5350	47.43	49.85	74	-26.57	36.41	7.47	46.3	191	331	Peak

REMARKS:

- Emission Level = Read Level+ Antenna Factor + Cable Loss- Preamp Factor
Margin value = Emission level – Limit value.
- 5190MHz: Fundamental frequency.



CHANNEL	TX Channel 46	DETECTOR FUNCTION	Peak (PK)
FREQUENCY RANGE	1GHz ~ 40GHz		Average (AV)

ANTENNA POLARITY & TEST DISTANCE: HORIZONTAL AT 3 M										
FREQ. (MHz)	EMISSION LEVEL (dBuV/m)	READ LEVEL (dBuV)	LIMIT (dBuV/m)	MARGIN (dB)	ANTENNA FACTOR (dB /m)	CABLE LOSS (dB)	PREAMP FACTOR (dB)	ANTENNA HEIGHT (cm)	TABLE ANGLE (Degree)	REMARK
5150	40.1	43.08	54	-13.9	35.95	7.42	46.35	144	167	Average
5150	49.23	52.21	74	-24.77	35.95	7.42	46.35	144	167	Peak
5230	89.42	92.28			36.03	7.44	46.33	144	167	Average
5230	98.56	101.42			36.03	7.44	46.33	144	167	Peak
5350	38.31	40.99	54	-15.69	36.15	7.47	46.3	144	167	Average
5350	48.61	51.29	74	-25.39	36.15	7.47	46.3	144	167	Peak

ANTENNA POLARITY & TEST DISTANCE: VERTICAL AT 3 M										
FREQ. (MHz)	EMISSION LEVEL (dBuV/m)	READ LEVEL (dBuV)	LIMIT (dBuV/m)	MARGIN (dB)	ANTENNA FACTOR (dB /m)	CABLE LOSS (dB)	PREAMP FACTOR (dB)	ANTENNA HEIGHT (cm)	TABLE ANGLE (Degree)	REMARK
5150	40.19	42.83	54	-13.81	36.29	7.42	46.35	120	280	Average
5150	48.43	51.07	74	-25.57	36.29	7.42	46.35	120	280	Peak
5230	88.04	90.59			36.34	7.44	46.33	120	280	Average
5230	97.34	99.89			36.34	7.44	46.33	120	280	Peak
5350	38.64	41.06	54	-15.36	36.41	7.47	46.3	120	280	Average
5350	47.79	50.21	74	-26.21	36.41	7.47	46.3	120	280	Peak

REMARKS:

- Emission Level = Read Level+ Antenna Factor + Cable Loss- Preamp Factor
Margin value = Emission level – Limit value.
- 5230MHz: Fundamental frequency.



802.11ac (80MHz)

CHANNEL	TX Channel 42	DETECTOR FUNCTION	Peak (PK)
FREQUENCY RANGE	1GHz ~ 40GHz		Average (AV)

ANTENNA POLARITY & TEST DISTANCE: HORIZONTAL AT 3 M										
FREQ. (MHz)	EMISSION LEVEL (dBuV/m)	READ LEVEL (dBuV)	LIMIT (dBuV/m)	MARGIN (dB)	ANTENNA FACTOR (dB /m)	CABLE LOSS (dB)	PREAMP FACTOR (dB)	ANTENNA HEIGHT (cm)	TABLE ANGLE (Degree)	REMARK
5150	41.59	44.57	54	-12.41	35.95	7.42	46.35	178	315	Average
5150	52.43	55.41	74	-21.57	35.95	7.42	46.35	178	315	Peak
5210	93.49	96.38			36.01	7.44	46.34	178	315	Average
5210	102.86	105.75			36.01	7.44	46.34	178	315	Peak
5350	38.34	41.02	54	-15.66	36.15	7.47	46.3	178	315	Average
5350	47.2	49.88	74	-26.8	36.15	7.47	46.3	178	315	Peak

ANTENNA POLARITY & TEST DISTANCE: VERTICAL AT 3 M										
FREQ. (MHz)	EMISSION LEVEL (dBuV/m)	READ LEVEL (dBuV)	LIMIT (dBuV/m)	MARGIN (dB)	ANTENNA FACTOR (dB /m)	CABLE LOSS (dB)	PREAMP FACTOR (dB)	ANTENNA HEIGHT (cm)	TABLE ANGLE (Degree)	REMARK
5150	40.37	43.01	54	-13.63	36.29	7.42	46.35	200	300	Average
5150	50.92	53.56	74	-23.08	36.29	7.42	46.35	200	300	Peak
5210	90.04	92.61			36.33	7.44	46.34	200	300	Average
5210	100.25	102.82			36.33	7.44	46.34	200	300	Peak
5350	38.61	41.03	54	-15.39	36.41	7.47	46.3	200	300	Average
5350	47.81	50.23	74	-26.19	36.41	7.47	46.3	200	300	Peak

REMARKS:

- Emission Level = Read Level+ Antenna Factor + Cable Loss- Preamp Factor
Margin value = Emission level – Limit value.
- 5210MHz: Fundamental frequency.



**Band 2
802.11a**

CHANNEL	TX Channel 52	DETECTOR FUNCTION	Peak (PK)
FREQUENCY RANGE	1GHz ~ 40GHz		Average (AV)

ANTENNA POLARITY & TEST DISTANCE: HORIZONTAL AT 3 M										
FREQ. (MHz)	EMISSION LEVEL (dBuV/m)	READ LEVEL (dBuV)	LIMIT (dBuV/m)	MARGIN (dB)	ANTENNA FACTOR (dB /m)	CABLE LOSS (dB)	PREAMP FACTOR (dB)	ANTENNA HEIGHT (cm)	TABLE ANGLE (Degree)	REMARK
5150	39.63	42.61	54	-14.37	35.95	7.42	46.35	100	152	Average
5150	49.63	52.61	74	-24.37	35.95	7.42	46.35	100	152	Peak
5260	94.1	96.91			36.06	7.45	46.32	100	152	Average
5260	103.38	106.19			36.06	7.45	46.32	100	152	Peak
5350	40.05	42.73	54	-13.95	36.15	7.47	46.3	100	152	Average
5350	49.6	52.28	74	-24.4	36.15	7.47	46.3	100	152	Peak
ANTENNA POLARITY & TEST DISTANCE: VERTICAL AT 3 M										
FREQ. (MHz)	EMISSION LEVEL (dBuV/m)	READ LEVEL (dBuV)	LIMIT (dBuV/m)	MARGIN (dB)	ANTENNA FACTOR (dB /m)	CABLE LOSS (dB)	PREAMP FACTOR (dB)	ANTENNA HEIGHT (cm)	TABLE ANGLE (Degree)	REMARK
5150	46.95	49.59	54	-7.05	36.29	7.42	46.35	100	131	Average
5150	53.95	56.59	74	-20.05	36.29	7.42	46.35	100	131	Peak
5260	103.96	106.47			36.36	7.45	46.32	100	131	Average
5260	113.09	115.6			36.36	7.45	46.32	100	131	Peak
5350	46.07	48.49	54	-7.93	36.41	7.47	46.3	100	131	Average
5350	54.99	57.41	74	-19.01	36.41	7.47	46.3	100	131	Peak

REMARKS:

- Emission Level = Read Level+ Antenna Factor + Cable Loss- Preamp Factor
Margin value = Emission level – Limit value.
- 5260MHz: Fundamental frequency.



CHANNEL	TX Channel 60	DETECTOR FUNCTION	Peak (PK)
FREQUENCY RANGE	1GHz ~ 40GHz		Average (AV)

ANTENNA POLARITY & TEST DISTANCE: HORIZONTAL AT 3 M										
FREQ. (MHz)	EMISSION LEVEL (dBuV/m)	READ LEVEL (dBuV)	LIMIT (dBuV/m)	MARGIN (dB)	ANTENNA FACTOR (dB /m)	CABLE LOSS (dB)	PREAMP FACTOR (dB)	ANTENNA HEIGHT (cm)	TABLE ANGLE (Degree)	REMARK
5150	34.25	37.23	54	-19.75	35.95	7.42	46.35	100	153	Average
5150	41.67	44.65	74	-32.33	35.95	7.42	46.35	100	153	Peak
5300	90.98	93.73			36.1	7.46	46.31	100	153	Average
5300	99.69	102.44			36.1	7.46	46.31	100	153	Peak
5350	38.38	41.06	54	-15.62	36.15	7.47	46.3	100	153	Average
5350	45.14	47.82	74	-28.86	36.15	7.47	46.3	100	153	Peak

ANTENNA POLARITY & TEST DISTANCE: VERTICAL AT 3 M										
FREQ. (MHz)	EMISSION LEVEL (dBuV/m)	READ LEVEL (dBuV)	LIMIT (dBuV/m)	MARGIN (dB)	ANTENNA FACTOR (dB /m)	CABLE LOSS (dB)	PREAMP FACTOR (dB)	ANTENNA HEIGHT (cm)	TABLE ANGLE (Degree)	REMARK
5150	46.99	49.63	54	-7.01	36.29	7.42	46.35	100	129	Average
5150	53.51	56.15	74	-20.49	36.29	7.42	46.35	100	129	Peak
5300	102.59	105.06			36.38	7.46	46.31	100	129	Average
5300	111.57	114.04			36.38	7.46	46.31	100	129	Peak
5350	46.74	49.16	54	-7.26	36.41	7.47	46.3	100	129	Average
5350	54.69	57.11	74	-19.31	36.41	7.47	46.3	100	129	Peak

REMARKS:

- Emission Level = Read Level+ Antenna Factor + Cable Loss- Preamp Factor
Margin value = Emission level – Limit value.
- 5300MHz: Fundamental frequency.



CHANNEL	TX Channel 64	DETECTOR FUNCTION	Peak (PK)
FREQUENCY RANGE	1GHz ~ 40GHz		Average (AV)

ANTENNA POLARITY & TEST DISTANCE: HORIZONTAL AT 3 M										
FREQ. (MHz)	EMISSION LEVEL (dBuV/m)	READ LEVEL (dBuV)	LIMIT (dBuV/m)	MARGIN (dB)	ANTENNA FACTOR (dB /m)	CABLE LOSS (dB)	PREAMP FACTOR (dB)	ANTENNA HEIGHT (cm)	TABLE ANGLE (Degree)	REMARK
5150	34.34	37.32	54	-19.66	35.95	7.42	46.35	100	158	Average
5150	43.15	46.13	74	-30.85	35.95	7.42	46.35	100	158	Peak
5320	90.91	93.63			36.12	7.46	46.3	100	158	Average
5320	99.09	101.81			36.12	7.46	46.3	100	158	Peak
5350	35.45	38.13	54	-18.55	36.15	7.47	46.3	100	158	Average
5350	44.69	47.37	74	-29.31	36.15	7.47	46.3	100	158	Peak

ANTENNA POLARITY & TEST DISTANCE: VERTICAL AT 3 M										
FREQ. (MHz)	EMISSION LEVEL (dBuV/m)	READ LEVEL (dBuV)	LIMIT (dBuV/m)	MARGIN (dB)	ANTENNA FACTOR (dB /m)	CABLE LOSS (dB)	PREAMP FACTOR (dB)	ANTENNA HEIGHT (cm)	TABLE ANGLE (Degree)	REMARK
5150	47	49.64	54	-7	36.29	7.42	46.35	100	125	Average
5150	54.68	57.32	74	-19.32	36.29	7.42	46.35	100	125	Peak
5320	102.62	105.07			36.39	7.46	46.3	100	125	Average
5320	111.14	113.59			36.39	7.46	46.3	100	125	Peak
5350	47.46	49.88	54	-6.54	36.41	7.47	46.3	100	125	Average
5350	55.71	58.13	74	-18.29	36.41	7.47	46.3	100	125	Peak

REMARKS:

- Emission Level = Read Level+ Antenna Factor + Cable Loss- Preamp Factor
Margin value = Emission level – Limit value.
- 5320MHz: Fundamental frequency.



802.11n (20MHz)

CHANNEL	TX Channel 52	DETECTOR FUNCTION	Peak (PK)
FREQUENCY RANGE	1GHz ~ 40GHz		Average (AV)

ANTENNA POLARITY & TEST DISTANCE: HORIZONTAL AT 3 M										
FREQ. (MHz)	EMISSION LEVEL (dBuV/m)	READ LEVEL (dBuV)	LIMIT (dBuV/m)	MARGIN (dB)	ANTENNA FACTOR (dB /m)	CABLE LOSS (dB)	PREAMP FACTOR (dB)	ANTENNA HEIGHT (cm)	TABLE ANGLE (Degree)	REMARK
5150	39.75	42.73	54	-14.25	35.95	7.42	46.35	100	317	Average
5150	47.2	50.18	74	-26.8	35.95	7.42	46.35	100	317	Peak
5260	94.6	97.41			36.06	7.45	46.32	100	317	Average
5260	104.3	107.11			36.06	7.45	46.32	100	317	Peak
5350	39.7	42.38	54	-14.3	36.15	7.47	46.3	100	317	Average
5350	49.23	51.91	74	-24.77	36.15	7.47	46.3	100	317	Peak
ANTENNA POLARITY & TEST DISTANCE: VERTICAL AT 3 M										
FREQ. (MHz)	EMISSION LEVEL (dBuV/m)	READ LEVEL (dBuV)	LIMIT (dBuV/m)	MARGIN (dB)	ANTENNA FACTOR (dB /m)	CABLE LOSS (dB)	PREAMP FACTOR (dB)	ANTENNA HEIGHT (cm)	TABLE ANGLE (Degree)	REMARK
5150	40.27	42.91	54	-13.73	36.29	7.42	46.35	100	278	Average
5150	46.79	49.43	74	-27.21	36.29	7.42	46.35	100	278	Peak
5260	93.02	95.53			36.36	7.45	46.32	100	278	Average
5260	102.89	105.4			36.36	7.45	46.32	100	278	Peak
5350	39.09	41.51	54	-14.91	36.41	7.47	46.3	100	278	Average
5350	49.32	51.74	74	-24.68	36.41	7.47	46.3	100	278	Peak

REMARKS:

- Emission Level = Read Level+ Antenna Factor + Cable Loss- Preamp Factor
Margin value = Emission level – Limit value.
- 5260MHz: Fundamental frequency.



CHANNEL	TX Channel 60	DETECTOR FUNCTION	Peak (PK)
FREQUENCY RANGE	1GHz ~ 40GHz		Average (AV)

ANTENNA POLARITY & TEST DISTANCE: HORIZONTAL AT 3 M										
FREQ. (MHz)	EMISSION LEVEL (dBuV/m)	READ LEVEL (dBuV)	LIMIT (dBuV/m)	MARGIN (dB)	ANTENNA FACTOR (dB /m)	CABLE LOSS (dB)	PREAMP FACTOR (dB)	ANTENNA HEIGHT (cm)	TABLE ANGLE (Degree)	REMARK
5150	39.73	42.71	54	-14.27	35.95	7.42	46.35	100	331	Average
5150	48.69	51.67	74	-25.31	35.95	7.42	46.35	100	331	Peak
5300	93	95.75			36.1	7.46	46.31	100	331	Average
5300	102.39	105.14			36.1	7.46	46.31	100	331	Peak
5350	42.99	45.67	54	-11.01	36.15	7.47	46.3	100	331	Average
5350	52.01	54.69	74	-21.99	36.15	7.47	46.3	100	331	Peak

ANTENNA POLARITY & TEST DISTANCE: VERTICAL AT 3 M										
FREQ. (MHz)	EMISSION LEVEL (dBuV/m)	READ LEVEL (dBuV)	LIMIT (dBuV/m)	MARGIN (dB)	ANTENNA FACTOR (dB /m)	CABLE LOSS (dB)	PREAMP FACTOR (dB)	ANTENNA HEIGHT (cm)	TABLE ANGLE (Degree)	REMARK
5150	40.1	42.74	54	-13.9	36.29	7.42	46.35	100	273	Average
5150	48.57	51.21	74	-25.43	36.29	7.42	46.35	100	273	Peak
5300	91.01	93.48			36.38	7.46	46.31	100	273	Average
5300	101.31	103.78			36.38	7.46	46.31	100	273	Peak
5350	40.81	43.23	54	-13.19	36.41	7.47	46.3	100	273	Average
5350	50.12	52.54	74	-23.88	36.41	7.47	46.3	100	273	Peak

REMARKS:

- Emission Level = Read Level+ Antenna Factor + Cable Loss- Preamp Factor
Margin value = Emission level – Limit value.
- 5300MHz: Fundamental frequency.



CHANNEL	TX Channel 64	DETECTOR FUNCTION	Peak (PK)
FREQUENCY RANGE	1GHz ~ 40GHz		Average (AV)

ANTENNA POLARITY & TEST DISTANCE: HORIZONTAL AT 3 M

FREQ. (MHz)	EMISSION LEVEL (dBuV/m)	READ LEVEL (dBuV)	LIMIT (dBuV/m)	MARGIN (dB)	ANTENNA FACTOR (dB /m)	CABLE LOSS (dB)	PREAMP FACTOR (dB)	ANTENNA HEIGHT (cm)	TABLE ANGLE (Degree)	REMARK
5150	39.77	42.75	54	-14.23	35.95	7.42	46.35	100	152	Average
5150	48.77	51.75	74	-25.23	35.95	7.42	46.35	100	152	Peak
5320	94.36	97.08			36.12	7.46	46.3	100	152	Average
5320	105.19	107.91			36.12	7.46	46.3	100	152	Peak
5350	40.59	43.27	54	-13.41	36.15	7.47	46.3	100	152	Average
5350	51.29	53.97	74	-22.71	36.15	7.47	46.3	100	152	Peak

ANTENNA POLARITY & TEST DISTANCE: VERTICAL AT 3 M

FREQ. (MHz)	EMISSION LEVEL (dBuV/m)	READ LEVEL (dBuV)	LIMIT (dBuV/m)	MARGIN (dB)	ANTENNA FACTOR (dB /m)	CABLE LOSS (dB)	PREAMP FACTOR (dB)	ANTENNA HEIGHT (cm)	TABLE ANGLE (Degree)	REMARK
5150	40.11	42.75	54	-13.89	36.29	7.42	46.35	100	338	Average
5150	48.45	51.09	74	-25.55	36.29	7.42	46.35	100	338	Peak
5320	90.44	92.89			36.39	7.46	46.3	100	338	Average
5320	100.16	102.61			36.39	7.46	46.3	100	338	Peak
5350	39.47	41.89	54	-14.53	36.41	7.47	46.3	100	338	Average
5350	49.34	51.76	74	-24.66	36.41	7.47	46.3	100	338	Peak

REMARKS:

- Emission Level = Read Level+ Antenna Factor + Cable Loss- Preamp Factor
Margin value = Emission level – Limit value.
- 5320MHz: Fundamental frequency.



802.11n (40MHz)

CHANNEL	TX Channel 54	DETECTOR FUNCTION	Peak (PK)
FREQUENCY RANGE	1GHz ~ 40GHz		Average (AV)

ANTENNA POLARITY & TEST DISTANCE: HORIZONTAL AT 3 M										
FREQ. (MHz)	EMISSION LEVEL (dBuV/m)	READ LEVEL (dBuV)	LIMIT (dBuV/m)	MARGIN (dB)	ANTENNA FACTOR (dB /m)	CABLE LOSS (dB)	PREAMP FACTOR (dB)	ANTENNA HEIGHT (cm)	TABLE ANGLE (Degree)	REMARK
5150	39.75	42.73	54	-14.25	35.95	7.42	46.35	100	290	Average
5150	47.86	50.84	74	-26.14	35.95	7.42	46.35	100	290	Peak
5270	82.54	85.34			36.07	7.45	46.32	100	290	Average
5270	93.21	96.01			36.07	7.45	46.32	100	290	Peak
5350	38.2	40.88	54	-15.8	36.15	7.47	46.3	100	290	Average
5350	46.63	49.31	74	-27.37	36.15	7.47	46.3	100	290	Peak

ANTENNA POLARITY & TEST DISTANCE: VERTICAL AT 3 M										
FREQ. (MHz)	EMISSION LEVEL (dBuV/m)	READ LEVEL (dBuV)	LIMIT (dBuV/m)	MARGIN (dB)	ANTENNA FACTOR (dB /m)	CABLE LOSS (dB)	PREAMP FACTOR (dB)	ANTENNA HEIGHT (cm)	TABLE ANGLE (Degree)	REMARK
5150	40.09	42.73	54	-13.91	36.29	7.42	46.35	120	281	Average
5150	50.98	53.62	74	-23.02	36.29	7.42	46.35	120	281	Peak
5270	87.72	90.23			36.36	7.45	46.32	120	281	Average
5270	96.21	98.72			36.36	7.45	46.32	120	281	Peak
5350	38.82	41.24	54	-15.18	36.41	7.47	46.3	120	281	Average
5350	48.26	50.68	74	-25.74	36.41	7.47	46.3	120	281	Peak

REMARKS:

- Emission Level = Read Level+ Antenna Factor + Cable Loss- Preamp Factor
Margin value = Emission level – Limit value.
- 5270MHz: Fundamental frequency.



CHANNEL	TX Channel 62	DETECTOR FUNCTION	Peak (PK)
FREQUENCY RANGE	1GHz ~ 40GHz		Average (AV)

ANTENNA POLARITY & TEST DISTANCE: HORIZONTAL AT 3 M										
FREQ. (MHz)	EMISSION LEVEL (dBuV/m)	READ LEVEL (dBuV)	LIMIT (dBuV/m)	MARGIN (dB)	ANTENNA FACTOR (dB /m)	CABLE LOSS (dB)	PREAMP FACTOR (dB)	ANTENNA HEIGHT (cm)	TABLE ANGLE (Degree)	REMARK
5150	39.78	42.76	54	-14.22	35.95	7.42	46.35	100	332	Average
5150	47.05	50.03	74	-26.95	35.95	7.42	46.35	100	332	Peak
5310	86.87	89.61			36.11	7.46	46.31	100	332	Average
5310	96.7	99.44			36.11	7.46	46.31	100	332	Peak
5350	42.18	44.86	54	-11.82	36.15	7.47	46.3	100	332	Average
5350	53.63	56.31	74	-20.37	36.15	7.47	46.3	100	332	Peak

ANTENNA POLARITY & TEST DISTANCE: VERTICAL AT 3 M										
FREQ. (MHz)	EMISSION LEVEL (dBuV/m)	READ LEVEL (dBuV)	LIMIT (dBuV/m)	MARGIN (dB)	ANTENNA FACTOR (dB /m)	CABLE LOSS (dB)	PREAMP FACTOR (dB)	ANTENNA HEIGHT (cm)	TABLE ANGLE (Degree)	REMARK
5150	40.09	42.73	54	-13.91	36.29	7.42	46.35	200	287	Average
5150	50.01	52.65	74	-23.99	36.29	7.42	46.35	200	287	Peak
5310	88.78	91.24			36.39	7.46	46.31	200	287	Average
5310	97.15	99.61			36.39	7.46	46.31	200	287	Peak
5350	45.61	48.03	54	-8.39	36.41	7.47	46.3	200	287	Average
5350	57.22	59.64	74	-16.78	36.41	7.47	46.3	200	287	Peak

REMARKS:

- Emission Level = Read Level+ Antenna Factor + Cable Loss- Preamp Factor
Margin value = Emission level – Limit value.
- 5310MHz: Fundamental frequency.



802.11ac (80MHz)

CHANNEL	TX Channel 58	DETECTOR FUNCTION	Peak (PK)
FREQUENCY RANGE	1GHz ~ 40GHz		Average (AV)

ANTENNA POLARITY & TEST DISTANCE: HORIZONTAL AT 3 M										
FREQ. (MHz)	EMISSION LEVEL (dBuV/m)	READ LEVEL (dBuV)	LIMIT (dBuV/m)	MARGIN (dB)	ANTENNA FACTOR (dB /m)	CABLE LOSS (dB)	PREAMP FACTOR (dB)	ANTENNA HEIGHT (cm)	TABLE ANGLE (Degree)	REMARK
5150	39.63	42.61	54	-14.37	35.95	7.42	46.35	168	313	Average
5150	49.43	52.41	74	-24.57	35.95	7.42	46.35	168	313	Peak
5290	93.34	96.11			36.09	7.45	46.31	168	313	Average
5290	103.72	106.49			36.09	7.45	46.31	168	313	Peak
5350	42.78	45.46	54	-11.22	36.15	7.47	46.3	168	313	Average
5350	57	59.68	74	-17	36.15	7.47	46.3	168	313	Peak

ANTENNA POLARITY & TEST DISTANCE: VERTICAL AT 3 M										
FREQ. (MHz)	EMISSION LEVEL (dBuV/m)	READ LEVEL (dBuV)	LIMIT (dBuV/m)	MARGIN (dB)	ANTENNA FACTOR (dB /m)	CABLE LOSS (dB)	PREAMP FACTOR (dB)	ANTENNA HEIGHT (cm)	TABLE ANGLE (Degree)	REMARK
5150	40.08	42.72	54	-13.92	36.29	7.42	46.35	171	316	Average
5150	48.98	51.62	74	-25.02	36.29	7.42	46.35	171	316	Peak
5290	89.17	91.66			36.37	7.45	46.31	171	316	Average
5290	98.89	101.38			36.37	7.45	46.31	171	316	Peak
5350	39.29	41.71	54	-14.71	36.41	7.47	46.3	171	316	Average
5350	48.82	51.24	74	-25.18	36.41	7.47	46.3	171	316	Peak

REMARKS:

- Emission Level = Read Level+ Antenna Factor + Cable Loss- Preamp Factor
Margin value = Emission level – Limit value.
- 5290MHz: Fundamental frequency.



Band 3

802.11a

CHANNEL	TX Channel 100	DETECTOR FUNCTION	Peak (PK)
FREQUENCY RANGE	1GHz ~ 40GHz		Average (AV)

ANTENNA POLARITY & TEST DISTANCE: HORIZONTAL AT 3 M										
FREQ. (MHz)	EMISSION LEVEL (dBuV/m)	READ LEVEL (dBuV)	LIMIT (dBuV/m)	MARGIN (dB)	ANTENNA FACTOR (dB /m)	CABLE LOSS (dB)	PREAMP FACTOR (dB)	ANTENNA HEIGHT (cm)	TABLE ANGLE (Degree)	REMARK
5460	39.78	42.29	54	-14.22	36.26	7.49	46.26	190	328	Average
5460	50.78	53.29	74	-23.22	36.26	7.49	46.26	190	328	Peak
#5470	62.66	65.16	68.3	-5.64	36.27	7.49	46.26	190	328	Peak
5500	97.61	100.06			36.3	7.5	46.25	190	328	Average
5500	107.14	109.59			36.3	7.5	46.25	190	328	Peak
ANTENNA POLARITY & TEST DISTANCE: VERTICAL AT 3 M										
FREQ. (MHz)	EMISSION LEVEL (dBuV/m)	READ LEVEL (dBuV)	LIMIT (dBuV/m)	MARGIN (dB)	ANTENNA FACTOR (dB /m)	CABLE LOSS (dB)	PREAMP FACTOR (dB)	ANTENNA HEIGHT (cm)	TABLE ANGLE (Degree)	REMARK
5460	35.7	37.99	54	-18.3	36.48	7.49	46.26	198	278	Average
5460	46.86	49.15	74	-27.14	36.48	7.49	46.26	198	278	Peak
#5470	49.36	51.65	68.3	-18.94	36.48	7.49	46.26	198	278	Peak
5500	93.17	95.42			36.5	7.5	46.25	198	278	Average
5500	99.3	101.55			36.5	7.5	46.25	198	278	Peak

REMARKS:

- Emission Level = Read Level+ Antenna Factor + Cable Loss- Preamp Factor
Margin value = Emission level – Limit value.
- 5500MHz: Fundamental frequency.
- #: Out of restricted band.



CHANNEL	TX Channel 116	DETECTOR FUNCTION	Peak (PK)
FREQUENCY RANGE	1GHz ~ 40GHz		Average (AV)

ANTENNA POLARITY & TEST DISTANCE: HORIZONTAL AT 3 M										
FREQ. (MHz)	EMISSION LEVEL (dBuV/m)	READ LEVEL (dBuV)	LIMIT (dBuV/m)	MARGIN (dB)	ANTENNA FACTOR (dB /m)	CABLE LOSS (dB)	PREAMP FACTOR (dB)	ANTENNA HEIGHT (cm)	TABLE ANGLE (Degree)	REMARK
5460	38.02	40.53	54	-15.98	36.26	7.49	46.26	192	335	Average
5460	48.33	50.84	74	-25.67	36.26	7.49	46.26	192	335	Peak
#5470	47.37	49.87	68.3	-20.93	36.27	7.49	46.26	192	335	Peak
5580	94.91	97.23			36.33	7.58	46.23	192	335	Average
5580	102.75	105.07			36.33	7.58	46.23	192	335	Peak

ANTENNA POLARITY & TEST DISTANCE: VERTICAL AT 3 M										
FREQ. (MHz)	EMISSION LEVEL (dBuV/m)	READ LEVEL (dBuV)	LIMIT (dBuV/m)	MARGIN (dB)	ANTENNA FACTOR (dB /m)	CABLE LOSS (dB)	PREAMP FACTOR (dB)	ANTENNA HEIGHT (cm)	TABLE ANGLE (Degree)	REMARK
5460	38.53	40.82	54	-15.47	36.48	7.49	46.26	200	290	Average
5460	48.1	50.39	74	-25.9	36.48	7.49	46.26	200	290	Peak
#5470	50.66	52.95	68.3	-17.64	36.48	7.49	46.26	200	290	Peak
5580	93.88	95.98			36.55	7.58	46.23	200	290	Average
5580	101.02	103.12			36.55	7.58	46.23	200	290	Peak

REMARKS:

- Emission Level = Read Level+ Antenna Factor + Cable Loss- Preamp Factor
Margin value = Emission level – Limit value.
- 5580MHz: Fundamental frequency.
- #: Out of restricted band.



CHANNEL	TX Channel 140	DETECTOR FUNCTION	Peak (PK)
FREQUENCY RANGE	1GHz ~ 40GHz		Average (AV)

ANTENNA POLARITY & TEST DISTANCE: HORIZONTAL AT 3 M										
FREQ. (MHz)	EMISSION LEVEL (dBuV/m)	READ LEVEL (dBuV)	LIMIT (dBuV/m)	MARGIN (dB)	ANTENNA FACTOR (dB /m)	CABLE LOSS (dB)	PREAMP FACTOR (dB)	ANTENNA HEIGHT (cm)	TABLE ANGLE (Degree)	REMARK
5700	97.81	99.92			36.38	7.7	46.19	192	341	Average
5700	106.42	108.53			36.38	7.7	46.19	192	341	Peak
#5725	60.54	62.61	68.3	-7.76	36.39	7.73	46.19	192	341	Peak
ANTENNA POLARITY & TEST DISTANCE: VERTICAL AT 3 M										
FREQ. (MHz)	EMISSION LEVEL (dBuV/m)	READ LEVEL (dBuV)	LIMIT (dBuV/m)	MARGIN (dB)	ANTENNA FACTOR (dB /m)	CABLE LOSS (dB)	PREAMP FACTOR (dB)	ANTENNA HEIGHT (cm)	TABLE ANGLE (Degree)	REMARK
5700	95.74	97.61			36.62	7.7	46.19	195	341	Average
5700	106	107.87			36.62	7.7	46.19	195	341	Peak
#5725	56.7	58.53	68.3	-11.6	36.63	7.73	46.19	195	341	Peak

REMARKS:

- Emission Level = Read Level+ Antenna Factor + Cable Loss- Preamp Factor
Margin value = Emission level – Limit value.
- 5700MHz: Fundamental frequency.
- #: Out of restricted band.



802.11n (20MHz)

CHANNEL	TX Channel 100	DETECTOR FUNCTION	Peak (PK)
FREQUENCY RANGE	1GHz ~ 40GHz		Average (AV)

ANTENNA POLARITY & TEST DISTANCE: HORIZONTAL AT 3 M										
FREQ. (MHz)	EMISSION LEVEL (dBuV/m)	READ LEVEL (dBuV)	LIMIT (dBuV/m)	MARGIN (dB)	ANTENNA FACTOR (dB /m)	CABLE LOSS (dB)	PREAMP FACTOR (dB)	ANTENNA HEIGHT (cm)	TABLE ANGLE (Degree)	REMARK
5460	39.64	42.15	54	-14.36	36.26	7.49	46.26	194	315	Average
5460	52.61	55.12	74	-21.39	36.26	7.49	46.26	194	315	Peak
#5470	54.82	57.32	68.3	-13.48	36.27	7.49	46.26	194	315	Peak
5500	96.56	99.01			36.3	7.5	46.25	194	315	Average
5500	105.06	107.51			36.3	7.5	46.25	194	315	Peak

ANTENNA POLARITY & TEST DISTANCE: VERTICAL AT 3 M										
FREQ. (MHz)	EMISSION LEVEL (dBuV/m)	READ LEVEL (dBuV)	LIMIT (dBuV/m)	MARGIN (dB)	ANTENNA FACTOR (dB /m)	CABLE LOSS (dB)	PREAMP FACTOR (dB)	ANTENNA HEIGHT (cm)	TABLE ANGLE (Degree)	REMARK
5460	38.66	40.95	54	-15.34	36.48	7.49	46.26	100	0	Average
5460	48.4	50.69	74	-25.6	36.48	7.49	46.26	100	0	Peak
#5470	48.8	51.09	68.3	-19.5	36.48	7.49	46.26	100	0	Peak
5500	89.66	91.91			36.5	7.5	46.25	100	0	Average
5500	99.29	101.54			36.5	7.5	46.25	100	0	Peak

REMARKS:

- Emission Level = Read Level+ Antenna Factor + Cable Loss- Preamp Factor
Margin value = Emission level – Limit value.
- 5500MHz: Fundamental frequency.
- #: Out of restricted band.



CHANNEL	TX Channel 116	DETECTOR FUNCTION	Peak (PK)
FREQUENCY RANGE	1GHz ~ 40GHz		Average (AV)

ANTENNA POLARITY & TEST DISTANCE: HORIZONTAL AT 3 M										
FREQ. (MHz)	EMISSION LEVEL (dBuV/m)	READ LEVEL (dBuV)	LIMIT (dBuV/m)	MARGIN (dB)	ANTENNA FACTOR (dB /m)	CABLE LOSS (dB)	PREAMP FACTOR (dB)	ANTENNA HEIGHT (cm)	TABLE ANGLE (Degree)	REMARK
5460	38.04	40.55	54	-15.96	36.26	7.49	46.26	195	326	Average
5460	49.41	51.92	74	-24.59	36.26	7.49	46.26	195	326	Peak
#5470	50.81	53.31	68.3	-17.49	36.27	7.49	46.26	195	326	Peak
5580	97.81	100.13			36.33	7.58	46.23	195	326	Average
5580	108.42	110.74			36.33	7.58	46.23	195	326	Peak

ANTENNA POLARITY & TEST DISTANCE: VERTICAL AT 3 M										
FREQ. (MHz)	EMISSION LEVEL (dBuV/m)	READ LEVEL (dBuV)	LIMIT (dBuV/m)	MARGIN (dB)	ANTENNA FACTOR (dB /m)	CABLE LOSS (dB)	PREAMP FACTOR (dB)	ANTENNA HEIGHT (cm)	TABLE ANGLE (Degree)	REMARK
5460	38.4	40.69	54	-15.6	36.48	7.49	46.26	172	347	Average
5460	46.28	48.57	74	-27.72	36.48	7.49	46.26	172	347	Peak
#5470	49.17	51.46	68.3	-19.13	36.48	7.49	46.26	172	347	Peak
5580	95.68	97.78			36.55	7.58	46.23	172	347	Average
5580	104.95	107.05			36.55	7.58	46.23	172	347	Peak

REMARKS:

- Emission Level = Read Level+ Antenna Factor + Cable Loss- Preamp Factor
Margin value = Emission level – Limit value.
- 5580MHz: Fundamental frequency.
- #: Out of restricted band.



CHANNEL	TX Channel 140	DETECTOR FUNCTION	Peak (PK)
FREQUENCY RANGE	1GHz ~ 40GHz		Average (AV)

ANTENNA POLARITY & TEST DISTANCE: HORIZONTAL AT 3 M										
FREQ. (MHz)	EMISSION LEVEL (dBuV/m)	READ LEVEL (dBuV)	LIMIT (dBuV/m)	MARGIN (dB)	ANTENNA FACTOR (dB /m)	CABLE LOSS (dB)	PREAMP FACTOR (dB)	ANTENNA HEIGHT (cm)	TABLE ANGLE (Degree)	REMARK
5700	92.57	94.68			36.38	7.7	46.19	100	274	Average
5700	103.11	105.22			36.38	7.7	46.19	100	274	Peak
#5725	55.28	57.35	68.3	-13.02	36.39	7.73	46.19	100	274	Peak
ANTENNA POLARITY & TEST DISTANCE: VERTICAL AT 3 M										
FREQ. (MHz)	EMISSION LEVEL (dBuV/m)	READ LEVEL (dBuV)	LIMIT (dBuV/m)	MARGIN (dB)	ANTENNA FACTOR (dB /m)	CABLE LOSS (dB)	PREAMP FACTOR (dB)	ANTENNA HEIGHT (cm)	TABLE ANGLE (Degree)	REMARK
5700	94.61	96.48			36.62	7.7	46.19	100	350	Average
5700	103.56	105.43			36.62	7.7	46.19	100	350	Peak
#5725	57.7	59.53	68.3	-10.6	36.63	7.73	46.19	100	350	Peak

REMARKS:

- Emission Level = Read Level+ Antenna Factor + Cable Loss- Preamp Factor
Margin value = Emission level – Limit value.
- 5700MHz: Fundamental frequency.
- #: Out of restricted band.



802.11n (40MHz)

CHANNEL	TX Channel 102	DETECTOR FUNCTION	Peak (PK)
FREQUENCY RANGE	1GHz ~ 40GHz		Average (AV)

ANTENNA POLARITY & TEST DISTANCE: HORIZONTAL AT 3 M										
FREQ. (MHz)	EMISSION LEVEL (dBuV/m)	READ LEVEL (dBuV)	LIMIT (dBuV/m)	MARGIN (dB)	ANTENNA FACTOR (dB /m)	CABLE LOSS (dB)	PREAMP FACTOR (dB)	ANTENNA HEIGHT (cm)	TABLE ANGLE (Degree)	REMARK
5460	43.7	46.21	54	-10.3	36.26	7.49	46.26	165	315	Average
5460	58.79	61.3	74	-15.21	36.26	7.49	46.26	165	315	Peak
#5470	64.94	70.44	68.3	-3.36	36.27	7.49	46.26	165	315	Peak
5510	90.78	93.22			36.3	7.51	46.25	165	315	Average
5510	100.03	102.47			36.3	7.51	46.25	165	315	Peak

ANTENNA POLARITY & TEST DISTANCE: VERTICAL AT 3 M										
FREQ. (MHz)	EMISSION LEVEL (dBuV/m)	READ LEVEL (dBuV)	LIMIT (dBuV/m)	MARGIN (dB)	ANTENNA FACTOR (dB /m)	CABLE LOSS (dB)	PREAMP FACTOR (dB)	ANTENNA HEIGHT (cm)	TABLE ANGLE (Degree)	REMARK
5460	40.42	42.71	54	-13.58	36.48	7.49	46.26	200	288	Average
5460	51.82	54.11	74	-22.18	36.48	7.49	46.26	200	288	Peak
#5470	62.84	65.13	68.3	-5.46	36.48	7.49	46.26	200	288	Peak
5510	88.25	90.48			36.51	7.51	46.25	200	288	Average
5510	96.42	98.65			36.51	7.51	46.25	200	288	Peak

REMARKS:

- Emission Level = Read Level+ Antenna Factor + Cable Loss- Preamp Factor
Margin value = Emission level – Limit value.
- 5510MHz: Fundamental frequency.
- #: Out of restricted band.



CHANNEL	TX Channel 110	DETECTOR FUNCTION	Peak (PK)
FREQUENCY RANGE	1GHz ~ 40GHz		Average (AV)

ANTENNA POLARITY & TEST DISTANCE: HORIZONTAL AT 3 M										
FREQ. (MHz)	EMISSION LEVEL (dBuV/m)	READ LEVEL (dBuV)	LIMIT (dBuV/m)	MARGIN (dB)	ANTENNA FACTOR (dB /m)	CABLE LOSS (dB)	PREAMP FACTOR (dB)	ANTENNA HEIGHT (cm)	TABLE ANGLE (Degree)	REMARK
5460	38.46	40.97	54	-15.54	36.26	7.49	46.26	165	342	Average
5460	48.26	50.77	74	-25.74	36.26	7.49	46.26	165	342	Peak
#5470	48.28	50.78	68.3	-20.02	36.27	7.49	46.26	165	342	Peak
5550	90.21	92.58			36.32	7.55	46.24	165	342	Average
5550	99.81	102.18			36.32	7.55	46.24	165	342	Peak

ANTENNA POLARITY & TEST DISTANCE: VERTICAL AT 3 M										
FREQ. (MHz)	EMISSION LEVEL (dBuV/m)	READ LEVEL (dBuV)	LIMIT (dBuV/m)	MARGIN (dB)	ANTENNA FACTOR (dB /m)	CABLE LOSS (dB)	PREAMP FACTOR (dB)	ANTENNA HEIGHT (cm)	TABLE ANGLE (Degree)	REMARK
5460	38.63	40.92	54	-15.37	36.48	7.49	46.26	100	348	Average
5460	48.7	50.99	74	-25.3	36.48	7.49	46.26	100	348	Peak
#5470	49.45	51.74	68.3	-18.85	36.48	7.49	46.26	100	348	Peak
5550	87.17	89.33			36.53	7.55	46.24	100	348	Average
5550	95.53	97.69			36.53	7.55	46.24	100	348	Peak

REMARKS:

- Emission Level = Read Level+ Antenna Factor + Cable Loss- Preamp Factor
Margin value = Emission level – Limit value.
- 5550MHz: Fundamental frequency.
- #: Out of restricted band.



CHANNEL	TX Channel 134	DETECTOR FUNCTION	Peak (PK)
FREQUENCY RANGE	1GHz ~ 40GHz		Average (AV)

ANTENNA POLARITY & TEST DISTANCE: HORIZONTAL AT 3 M										
FREQ. (MHz)	EMISSION LEVEL (dBuV/m)	READ LEVEL (dBuV)	LIMIT (dBuV/m)	MARGIN (dB)	ANTENNA FACTOR (dB /m)	CABLE LOSS (dB)	PREAMP FACTOR (dB)	ANTENNA HEIGHT (cm)	TABLE ANGLE (Degree)	REMARK
5670	92.61	94.77			36.37	7.67	46.2	200	340	Average
5670	100.08	102.24			36.37	7.67	46.2	200	340	Peak
#5725	49.09	51.16	68.3	-19.21	36.39	7.73	46.19	200	340	Peak
ANTENNA POLARITY & TEST DISTANCE: VERTICAL AT 3 M										
FREQ. (MHz)	EMISSION LEVEL (dBuV/m)	READ LEVEL (dBuV)	LIMIT (dBuV/m)	MARGIN (dB)	ANTENNA FACTOR (dB /m)	CABLE LOSS (dB)	PREAMP FACTOR (dB)	ANTENNA HEIGHT (cm)	TABLE ANGLE (Degree)	REMARK
5670	90.48	92.41			36.6	7.67	46.2	160	341	Average
5670	98.18	100.11			36.6	7.67	46.2	160	341	Peak
#5725	47.35	49.18	68.3	-20.95	36.63	7.73	46.19	160	341	Peak

REMARKS:

- Emission Level = Read Level+ Antenna Factor + Cable Loss- Preamp Factor
Margin value = Emission level – Limit value.
- 5670MHz: Fundamental frequency.
- #: Out of restricted band.



802.11ac (80MHz)

CHANNEL	TX Channel 106	DETECTOR FUNCTION	Peak (PK)
FREQUENCY RANGE	1GHz ~ 40GHz		Average (AV)

ANTENNA POLARITY & TEST DISTANCE: HORIZONTAL AT 3 M										
FREQ. (MHz)	EMISSION LEVEL (dBuV/m)	READ LEVEL (dBuV)	LIMIT (dBuV/m)	MARGIN (dB)	ANTENNA FACTOR (dB /m)	CABLE LOSS (dB)	PREAMP FACTOR (dB)	ANTENNA HEIGHT (cm)	TABLE ANGLE (Degree)	REMARK
5460	39.47	41.98	54	-14.53	36.26	7.49	46.26	172	328	Average
5460	49.57	52.08	74	-24.43	36.26	7.49	46.26	172	328	Peak
#5470	53.97	56.47	68.3	-14.33	36.27	7.49	46.26	172	328	Peak
5530	91.93	94.33			36.31	7.53	46.24	172	328	Average
5530	101.48	103.88			36.31	7.53	46.24	172	328	Peak

ANTENNA POLARITY & TEST DISTANCE: VERTICAL AT 3 M										
FREQ. (MHz)	EMISSION LEVEL (dBuV/m)	READ LEVEL (dBuV)	LIMIT (dBuV/m)	MARGIN (dB)	ANTENNA FACTOR (dB /m)	CABLE LOSS (dB)	PREAMP FACTOR (dB)	ANTENNA HEIGHT (cm)	TABLE ANGLE (Degree)	REMARK
5460	41.85	44.14	54	-12.15	36.48	7.49	46.26	167	343	Average
5460	48.92	51.21	74	-25.08	36.48	7.49	46.26	167	343	Peak
#5470	50.6	52.89	68.3	-17.7	36.48	7.49	46.26	167	343	Peak
5530	90.19	92.38			36.52	7.53	46.24	167	343	Average
5530	100.19	102.38			36.52	7.53	46.24	167	343	Peak

REMARKS:

- Emission Level = Read Level+ Antenna Factor + Cable Loss- Preamp Factor
Margin value = Emission level – Limit value.
- 5530MHz: Fundamental frequency.
- #: Out of restricted band.



Band 4

802.11a

CHANNEL	TX Channel 149	DETECTOR FUNCTION	Peak (PK)
FREQUENCY RANGE	1GHz ~ 40GHz		Average (AV)

ANTENNA POLARITY & TEST DISTANCE: HORIZONTAL AT 3 M										
FREQ. (MHz)	EMISSION LEVEL (dBuV/m)	READ LEVEL (dBuV)	LIMIT (dBuV/m)	MARGIN (dB)	ANTENNA FACTOR (dB /m)	CABLE LOSS (dB)	PREAMP FACTOR (dB)	ANTENNA HEIGHT (cm)	TABLE ANGLE (Degree)	REMARK
5745	100.57	101.45			37.55	7.75	46.18	100	32	Peak
5745	89.33	90.21			37.55	7.75	46.18	100	32	Average
ANTENNA POLARITY & TEST DISTANCE: VERTICAL AT 3 M										
FREQ. (MHz)	EMISSION LEVEL (dBuV/m)	READ LEVEL (dBuV)	LIMIT (dBuV/m)	MARGIN (dB)	ANTENNA FACTOR (dB /m)	CABLE LOSS (dB)	PREAMP FACTOR (dB)	ANTENNA HEIGHT (cm)	TABLE ANGLE (Degree)	REMARK
5745	100.48	101.36			37.55	7.75	46.18	100	25	Peak
5745	89.44	90.32			37.55	7.75	46.18	100	25	Average

REMARKS:

1. Emission Level = Read Level+ Antenna Factor + Cable Loss- Preamp Factor
Margin value = Emission level – Limit value.
2. 5745MHz: Fundamental frequency.



OOBE DATA

802.11a

ANTENNA POLARITY & TEST DISTANCE: HORIZONTAL AT 3 M											
FREQ. (MHz)	EMISSION LEVEL (dBuV/m)	READ LEVEL (dBuV)	LIMIT (dBuV/m)	MARGIN (dB)	ANTENNA FACTOR (dB /m)	CABLE LOSS (dB)	PREAMP FACTOR (dB)	ANTENNA HEIGHT (cm)	TABLE ANGLE (Degree)	REMARK	
5580.88	59.97	61.17	68.3	-8.33	37.45	7.58	46.23	200	360	Peak	
5988.43	59.86	60.28	68.3	-8.44	37.69	8	46.11	200	360	Peak	
ANTENNA POLARITY & TEST DISTANCE: VERTICAL AT 3 M											
FREQ. (MHz)	EMISSION LEVEL (dBuV/m)	READ LEVEL (dBuV)	LIMIT (dBuV/m)	MARGIN (dB)	ANTENNA FACTOR (dB /m)	CABLE LOSS (dB)	PREAMP FACTOR (dB)	ANTENNA HEIGHT (cm)	TABLE ANGLE (Degree)	REMARK	
5568.05	59.21	60.43	68.3	-9.09	37.44	7.57	46.23	100	360	Peak	
5990.33	58.85	59.27	68.3	-9.45	37.69	8	46.11	100	360	Peak	

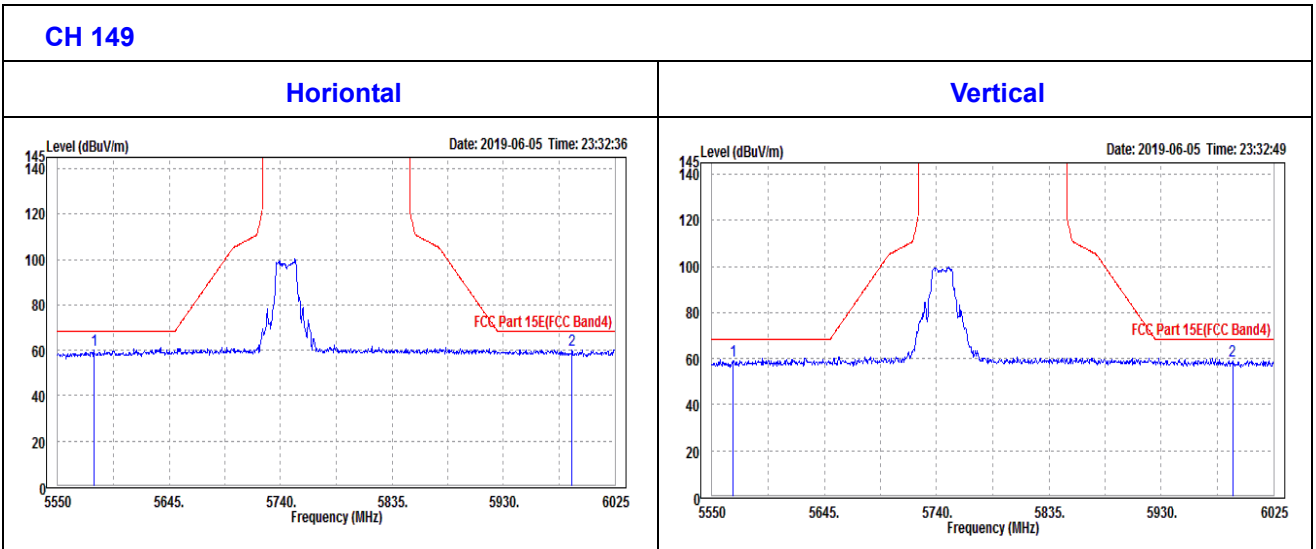



CHANNEL	TX Channel 157	DETECTOR FUNCTION	Peak (PK)
FREQUENCY RANGE	1GHz ~ 40GHz		Average (AV)

ANTENNA POLARITY & TEST DISTANCE: HORIZONTAL AT 3 M										
FREQ. (MHz)	EMISSION LEVEL (dBuV/m)	READ LEVEL (dBuV)	LIMIT (dBuV/m)	MARGIN (dB)	ANTENNA FACTOR (dB /m)	CABLE LOSS (dB)	PREAMP FACTOR (dB)	ANTENNA HEIGHT (cm)	TABLE ANGLE (Degree)	REMARK
5785	99.43	100.24			37.57	7.79	46.17	100	78	Peak
5785	89.05	89.86			37.57	7.79	46.17	100	78	Average

ANTENNA POLARITY & TEST DISTANCE: VERTICAL AT 3 M										
FREQ. (MHz)	EMISSION LEVEL (dBuV/m)	READ LEVEL (dBuV)	LIMIT (dBuV/m)	MARGIN (dB)	ANTENNA FACTOR (dB /m)	CABLE LOSS (dB)	PREAMP FACTOR (dB)	ANTENNA HEIGHT (cm)	TABLE ANGLE (Degree)	REMARK
5785	98.74	100.45			36.67	7.79	46.17	100	45	Peak
5785	88.93	90.64			36.67	7.79	46.17	100	45	Average

REMARKS:

1. Emission Level = Read Level+ Antenna Factor + Cable Loss- Preamp Factor
Margin value = Emission level – Limit value.
2. 5785MHz: Fundamental frequency.



Oobe Data

802.11a

ANTENNA POLARITY & TEST DISTANCE: HORIZONTAL AT 3 M										
FREQ. (MHz)	EMISSION LEVEL (dBuV/m)	READ LEVEL (dBuV)	LIMIT (dBuV/m)	MARGIN (dB)	ANTENNA FACTOR (dB /m)	CABLE LOSS (dB)	PREAMP FACTOR (dB)	ANTENNA HEIGHT (cm)	TABLE ANGLE (Degree)	REMARK
5583.25	58.15	59.35	68.3	-10.15	37.45	7.58	46.23	100	360	Peak
5978.45	59.21	59.65	68.3	-9.09	37.69	7.99	46.12	100	360	Peak
ANTENNA POLARITY & TEST DISTANCE: VERTICAL AT 3 M										
FREQ. (MHz)	EMISSION LEVEL (dBuV/m)	READ LEVEL (dBuV)	LIMIT (dBuV/m)	MARGIN (dB)	ANTENNA FACTOR (dB /m)	CABLE LOSS (dB)	PREAMP FACTOR (dB)	ANTENNA HEIGHT (cm)	TABLE ANGLE (Degree)	REMARK
5559.03	58.9	60.13	68.3	-9.4	37.44	7.56	46.23	100	0	Peak
6002.2	59.53	59.93	68.3	-8.77	37.7	8.01	46.11	100	0	Peak

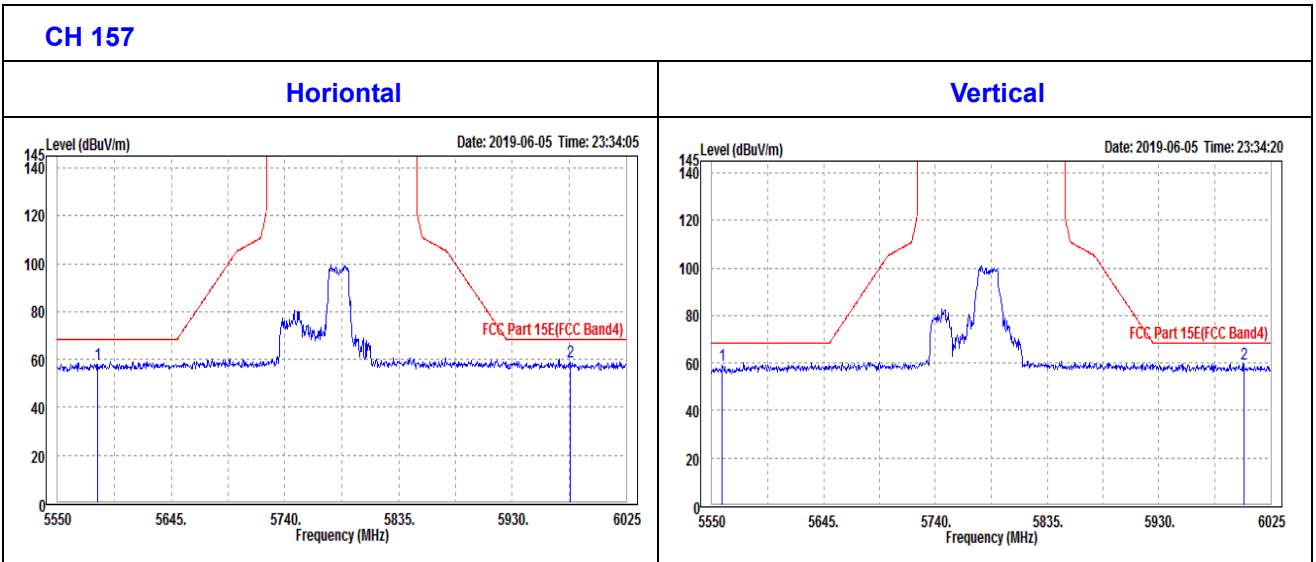



CHANNEL	TX Channel 161	DETECTOR FUNCTION	Peak (PK)
FREQUENCY RANGE	1GHz ~ 40GHz		Average (AV)

ANTENNA POLARITY & TEST DISTANCE: HORIZONTAL AT 3 M										
FREQ. (MHz)	EMISSION LEVEL (dBuV/m)	READ LEVEL (dBuV)	LIMIT (dBuV/m)	MARGIN (dB)	ANTENNA FACTOR (dB /m)	CABLE LOSS (dB)	PREAMP FACTOR (dB)	ANTENNA HEIGHT (cm)	TABLE ANGLE (Degree)	REMARK
5805	100.46	101.23			37.58	7.81	46.16	100	312	Peak
5805	88.68	89.45			37.58	7.81	46.16	100	312	Average

ANTENNA POLARITY & TEST DISTANCE: VERTICAL AT 3 M										
FREQ. (MHz)	EMISSION LEVEL (dBuV/m)	READ LEVEL (dBuV)	LIMIT (dBuV/m)	MARGIN (dB)	ANTENNA FACTOR (dB /m)	CABLE LOSS (dB)	PREAMP FACTOR (dB)	ANTENNA HEIGHT (cm)	TABLE ANGLE (Degree)	REMARK
5805	99.61	100.38			37.58	7.81	46.16	100	0	Peak
5805	89.87	90.64			37.58	7.81	46.16	100	0	Average

REMARKS:

1. Emission Level = Read Level+ Antenna Factor + Cable Loss- Preamp Factor
Margin value = Emission level – Limit value.
2. 5805MHz: Fundamental frequency.



**BUREAU
VERITAS**

Test Report No.: RF190522W010-3

Oobe Data

802.11a

ANTENNA POLARITY & TEST DISTANCE: HORIZONTAL AT 3 M										
FREQ. (MHz)	EMISSION LEVEL (dBuV/m)	READ LEVEL (dBuV)	LIMIT (dBuV/m)	MARGIN (dB)	ANTENNA FACTOR (dB /m)	CABLE LOSS (dB)	PREAMP FACTOR (dB)	ANTENNA HEIGHT (cm)	TABLE ANGLE (Degree)	REMARK
5593.23	60.75	58.75	68.3	-7.55	36.34	7.6	41.94	100	17	Peak
5967.05	61.63	59.34	68.3	-6.67	36.49	7.98	42.18	100	17	Peak
ANTENNA POLARITY & TEST DISTANCE: VERTICAL AT 3 M										
FREQ. (MHz)	EMISSION LEVEL (dBuV/m)	READ LEVEL (dBuV)	LIMIT (dBuV/m)	MARGIN (dB)	ANTENNA FACTOR (dB /m)	CABLE LOSS (dB)	PREAMP FACTOR (dB)	ANTENNA HEIGHT (cm)	TABLE ANGLE (Degree)	REMARK
5604.15	59.71	57.49	68.3	-8.59	36.56	7.61	41.95	100	17	Peak
5955.18	59.88	57.32	68.3	-8.42	36.77	7.96	42.17	100	17	Peak

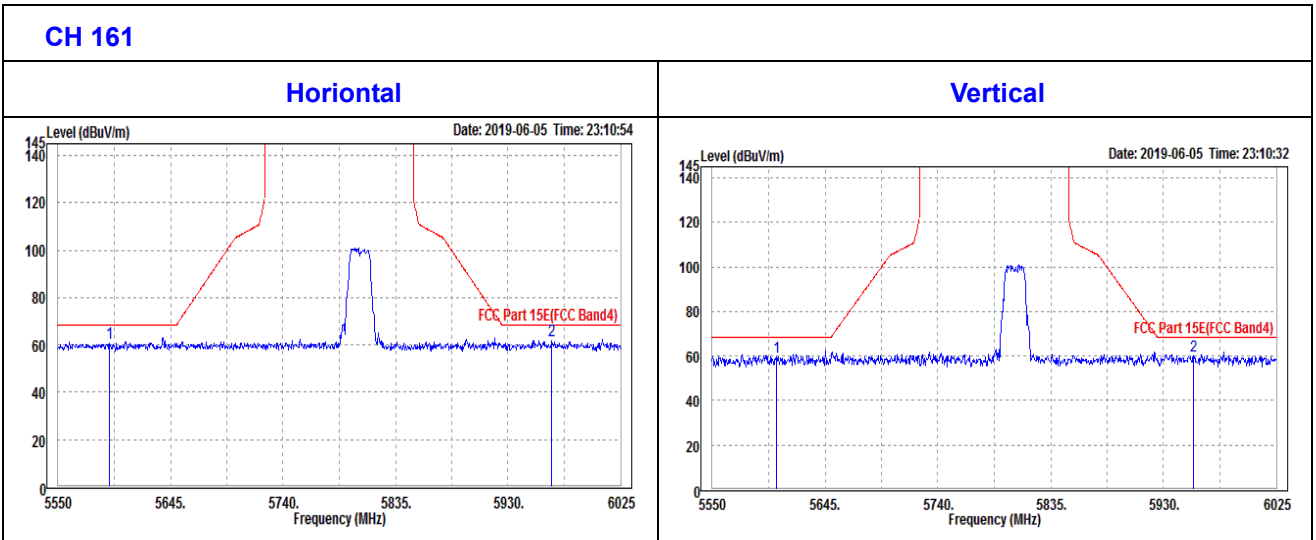



802.11n (20MHz)

CHANNEL	TX Channel 149	DETECTOR FUNCTION	Peak (PK)
FREQUENCY RANGE	1GHz ~ 40GHz		Average (AV)

ANTENNA POLARITY & TEST DISTANCE: HORIZONTAL AT 3 M										
FREQ. (MHz)	EMISSION LEVEL (dBuV/m)	READ LEVEL (dBuV)	LIMIT (dBuV/m)	MARGIN (dB)	ANTENNA FACTOR (dB /m)	CABLE LOSS (dB)	PREAMP FACTOR (dB)	ANTENNA HEIGHT (cm)	TABLE ANGLE (Degree)	REMARK
5745	101.53	102.41			37.55	7.75	46.18	100	215	Peak
5745	90.24	91.12			37.55	7.75	46.18	100	215	Average
ANTENNA POLARITY & TEST DISTANCE: VERTICAL AT 3 M										
FREQ. (MHz)	EMISSION LEVEL (dBuV/m)	READ LEVEL (dBuV)	LIMIT (dBuV/m)	MARGIN (dB)	ANTENNA FACTOR (dB /m)	CABLE LOSS (dB)	PREAMP FACTOR (dB)	ANTENNA HEIGHT (cm)	TABLE ANGLE (Degree)	REMARK
5745	100.74	101.62			37.55	7.75	46.18	100	69	Peak
5745	90.33	91.21			37.55	7.75	46.18	100	69	Average

REMARKS:

1. Emission Level = Read Level+ Antenna Factor + Cable Loss- Preamp Factor
Margin value = Emission level – Limit value.
2. 5745MHz: Fundamental frequency.



OOBE DATA

802.11n (20MHZ)

ANTENNA POLARITY & TEST DISTANCE: HORIZONTAL AT 3 M										
FREQ. (MHz)	EMISSION LEVEL (dBuV/m)	READ LEVEL (dBuV)	LIMIT (dBuV/m)	MARGIN (dB)	ANTENNA FACTOR (dB /m)	CABLE LOSS (dB)	PREAMP FACTOR (dB)	ANTENNA HEIGHT (cm)	TABLE ANGLE (Degree)	REMARK
5567.58	58.81	60.03	68.3	-9.49	37.44	7.57	46.23	100	0	Peak
5981.3	58.46	58.9	68.3	-9.84	37.69	7.99	46.12	100	0	Peak
ANTENNA POLARITY & TEST DISTANCE: VERTICAL AT 3 M										
FREQ. (MHz)	EMISSION LEVEL (dBuV/m)	READ LEVEL (dBuV)	LIMIT (dBuV/m)	MARGIN (dB)	ANTENNA FACTOR (dB /m)	CABLE LOSS (dB)	PREAMP FACTOR (dB)	ANTENNA HEIGHT (cm)	TABLE ANGLE (Degree)	REMARK
5619.83	57.87	59.9	68.3	-10.43	36.57	7.62	46.22	100	360	Peak
5943.78	57.38	58.79	68.3	-10.92	36.77	7.95	46.13	100	360	Peak

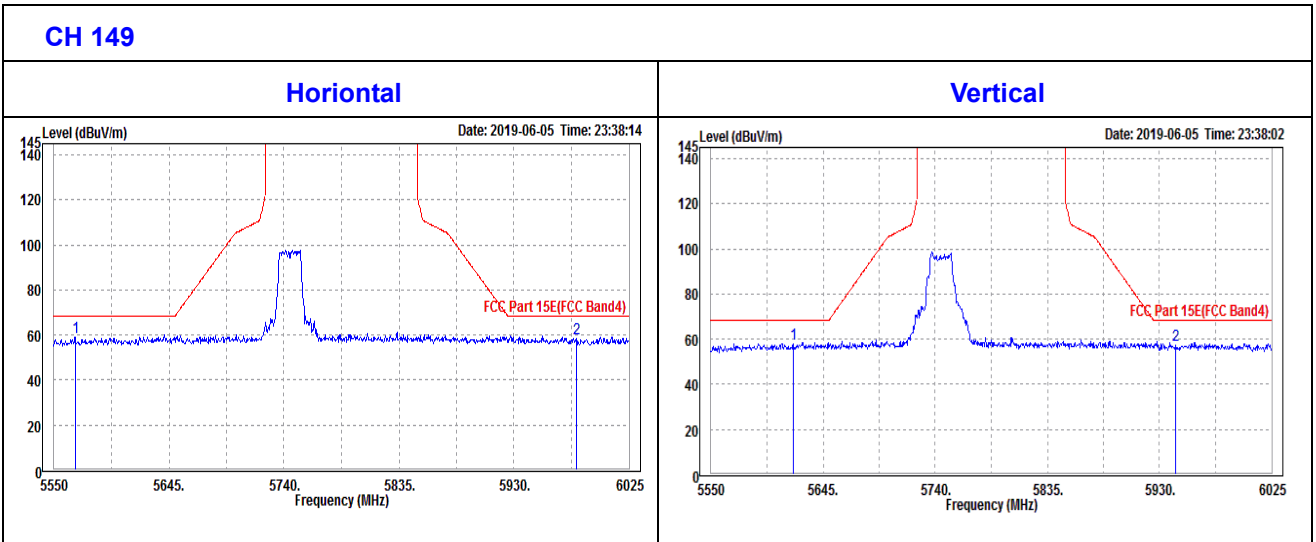



CHANNEL	TX Channel 157	DETECTOR FUNCTION	Peak (PK)
FREQUENCY RANGE	1GHz ~ 40GHz		Average (AV)

ANTENNA POLARITY & TEST DISTANCE: HORIZONTAL AT 3 M										
FREQ. (MHz)	EMISSION LEVEL (dBuV/m)	READ LEVEL (dBuV)	LIMIT (dBuV/m)	MARGIN (dB)	ANTENNA FACTOR (dB /m)	CABLE LOSS (dB)	PREAMP FACTOR (dB)	ANTENNA HEIGHT (cm)	TABLE ANGLE (Degree)	REMARK
5785	101.5	102.31			37.57	7.79	46.17	100	258	Peak
5785	91.8	92.61			37.57	7.79	46.17	100	258	Average

ANTENNA POLARITY & TEST DISTANCE: VERTICAL AT 3 M										
FREQ. (MHz)	EMISSION LEVEL (dBuV/m)	READ LEVEL (dBuV)	LIMIT (dBuV/m)	MARGIN (dB)	ANTENNA FACTOR (dB /m)	CABLE LOSS (dB)	PREAMP FACTOR (dB)	ANTENNA HEIGHT (cm)	TABLE ANGLE (Degree)	REMARK
5785	99.74	101.45			36.67	7.79	46.17	100	24	Peak
5785	88.52	90.23			36.67	7.79	46.17	100	24	Average

REMARKS:

1. Emission Level = Read Level+ Antenna Factor + Cable Loss- Preamp Factor
Margin value = Emission level – Limit value.
2. 5785MHz: Fundamental frequency.



**BUREAU
VERITAS**

Test Report No.: RF190522W010-3

Oobe Data

802.11n (20MHz)

ANTENNA POLARITY & TEST DISTANCE: HORIZONTAL AT 3 M										
FREQ. (MHz)	EMISSION LEVEL (dBuV/m)	READ LEVEL (dBuV)	LIMIT (dBuV/m)	MARGIN (dB)	ANTENNA FACTOR (dB /m)	CABLE LOSS (dB)	PREAMP FACTOR (dB)	ANTENNA HEIGHT (cm)	TABLE ANGLE (Degree)	REMARK
5567.58	57.58	58.8	68.3	-10.72	37.44	7.57	46.23	100	0	Peak
6021.2	59.09	59.49	68.3	-9.21	37.72	7.98	46.1	100	0	Peak
ANTENNA POLARITY & TEST DISTANCE: VERTICAL AT 3 M										
FREQ. (MHz)	EMISSION LEVEL (dBuV/m)	READ LEVEL (dBuV)	LIMIT (dBuV/m)	MARGIN (dB)	ANTENNA FACTOR (dB /m)	CABLE LOSS (dB)	PREAMP FACTOR (dB)	ANTENNA HEIGHT (cm)	TABLE ANGLE (Degree)	REMARK
5558.55	58.94	60.17	68.3	-9.36	37.44	7.56	46.23	100	360	Peak
5972.75	59.64	60.1	68.3	-8.66	37.68	7.98	46.12	100	360	Peak

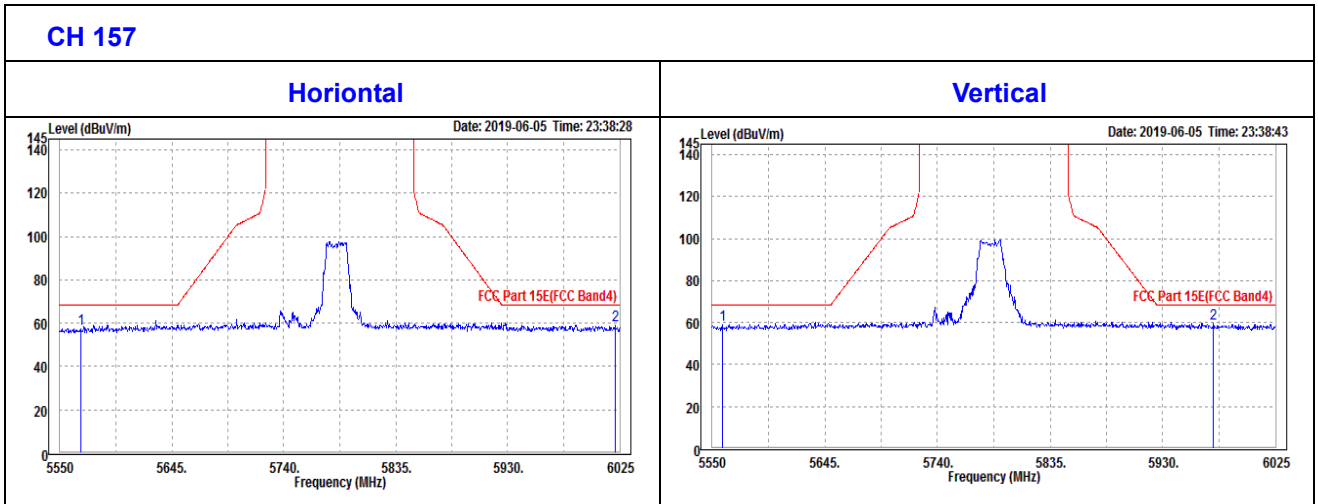



CHANNEL	TX Channel 161	DETECTOR FUNCTION	Peak (PK)
FREQUENCY RANGE	1GHz ~ 40GHz		Average (AV)

ANTENNA POLARITY & TEST DISTANCE: HORIZONTAL AT 3 M										
FREQ. (MHz)	EMISSION LEVEL (dBuV/m)	READ LEVEL (dBuV)	LIMIT (dBuV/m)	MARGIN (dB)	ANTENNA FACTOR (dB /m)	CABLE LOSS (dB)	PREAMP FACTOR (dB)	ANTENNA HEIGHT (cm)	TABLE ANGLE (Degree)	REMARK
5805	100.59	101.36			37.58	7.81	46.16	100	0	Peak
5805	88.99	89.76			37.58	7.81	46.16	100	0	Average

ANTENNA POLARITY & TEST DISTANCE: VERTICAL AT 3 M										
FREQ. (MHz)	EMISSION LEVEL (dBuV/m)	READ LEVEL (dBuV)	LIMIT (dBuV/m)	MARGIN (dB)	ANTENNA FACTOR (dB /m)	CABLE LOSS (dB)	PREAMP FACTOR (dB)	ANTENNA HEIGHT (cm)	TABLE ANGLE (Degree)	REMARK
5805	101.54	102.31			37.58	7.81	46.16	100	23	Peak
5805	89.48	90.25			37.58	7.81	46.16	100	23	Average

REMARKS:

1. Emission Level = Read Level+ Antenna Factor + Cable Loss- Preamp Factor
Margin value = Emission level – Limit value.
2. 5805MHz: Fundamental frequency.



OOBE DATA

802.11n (20MHZ)

ANTENNA POLARITY & TEST DISTANCE: HORIZONTAL AT 3 M										
FREQ. (MHz)	EMISSION LEVEL (dBuV/m)	READ LEVEL (dBuV)	LIMIT (dBuV/m)	MARGIN (dB)	ANTENNA FACTOR (dB /m)	CABLE LOSS (dB)	PREAMP FACTOR (dB)	ANTENNA HEIGHT (cm)	TABLE ANGLE (Degree)	REMARK
5585.15	60.26	58.27	68.3	-8.04	36.33	7.59	41.93	100	17	Peak
5969.43	60.22	57.93	68.3	-8.08	36.49	7.98	42.18	100	17	Peak
ANTENNA POLARITY & TEST DISTANCE: VERTICAL AT 3 M										
FREQ. (MHz)	EMISSION LEVEL (dBuV/m)	READ LEVEL (dBuV)	LIMIT (dBuV/m)	MARGIN (dB)	ANTENNA FACTOR (dB /m)	CABLE LOSS (dB)	PREAMP FACTOR (dB)	ANTENNA HEIGHT (cm)	TABLE ANGLE (Degree)	REMARK
5593.7	59.32	57.1	68.3	-8.98	36.56	7.6	41.94	100	17	Peak
5952.8	59.93	57.37	68.3	-8.37	36.77	7.96	42.17	100	17	Peak

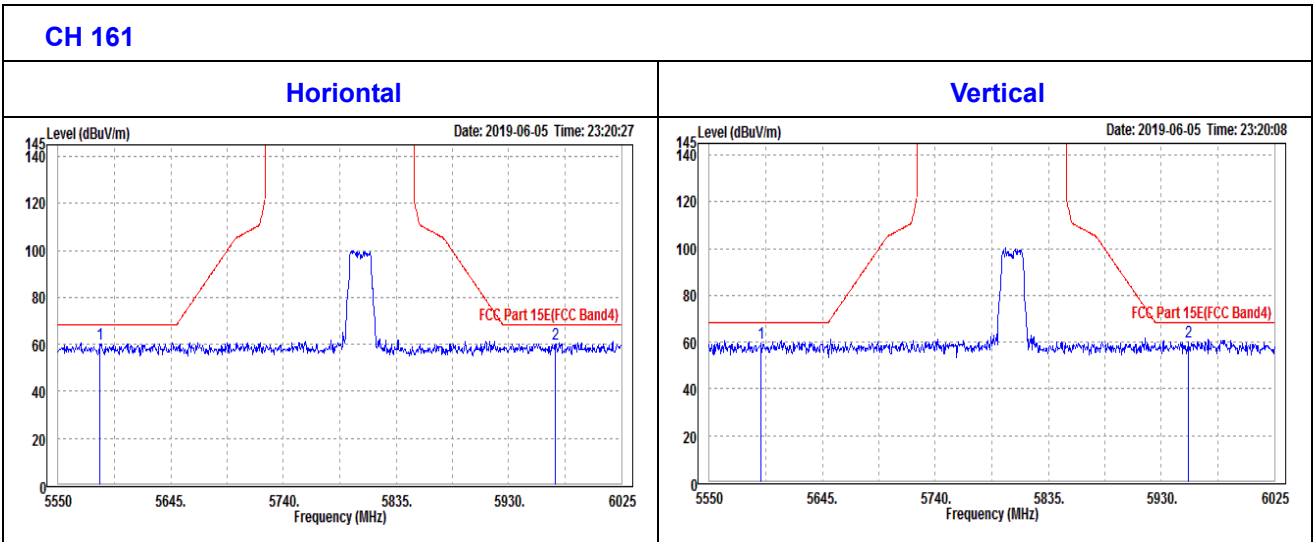



802.11n (40MHz)

CHANNEL	TX Channel 151	DETECTOR FUNCTION	Peak (PK)
FREQUENCY RANGE	1GHz ~ 40GHz		Average (AV)

ANTENNA POLARITY & TEST DISTANCE: HORIZONTAL AT 3 M										
FREQ. (MHz)	EMISSION LEVEL (dBuV/m)	READ LEVEL (dBuV)	LIMIT (dBuV/m)	MARGIN (dB)	ANTENNA FACTOR (dB /m)	CABLE LOSS (dB)	PREAMP FACTOR (dB)	ANTENNA HEIGHT (cm)	TABLE ANGLE (Degree)	REMARK
5755	100.47	101.34			37.55	7.76	46.18	100	213	Peak
5755	90.36	91.23			37.55	7.76	46.18	100	213	Average
ANTENNA POLARITY & TEST DISTANCE: VERTICAL AT 3 M										
FREQ. (MHz)	EMISSION LEVEL (dBuV/m)	READ LEVEL (dBuV)	LIMIT (dBuV/m)	MARGIN (dB)	ANTENNA FACTOR (dB /m)	CABLE LOSS (dB)	PREAMP FACTOR (dB)	ANTENNA HEIGHT (cm)	TABLE ANGLE (Degree)	REMARK
5755	100.58	102.35			36.65	7.76	46.18	100	245	Peak
5755	90.36	92.13			36.65	7.76	46.18	100	245	Average

REMARKS:

1. Emission Level = Read Level+ Antenna Factor + Cable Loss- Preamp Factor
Margin value = Emission level – Limit value.
2. 5755MHz: Fundamental frequency.



Oobe Data

802.11n (40MHz)

ANTENNA POLARITY & TEST DISTANCE: HORIZONTAL AT 3 M										
FREQ. (MHz)	EMISSION LEVEL (dBuV/m)	READ LEVEL (dBuV)	LIMIT (dBuV/m)	MARGIN (dB)	ANTENNA FACTOR (dB /m)	CABLE LOSS (dB)	PREAMP FACTOR (dB)	ANTENNA HEIGHT (cm)	TABLE ANGLE (Degree)	REMARK
5594.18	60.36	61.52	68.3	-7.94	37.46	7.6	46.22	100	0	Peak
5975.13	60.1	60.55	68.3	-8.2	37.69	7.98	46.12	100	0	Peak
ANTENNA POLARITY & TEST DISTANCE: VERTICAL AT 3 M										
FREQ. (MHz)	EMISSION LEVEL (dBuV/m)	READ LEVEL (dBuV)	LIMIT (dBuV/m)	MARGIN (dB)	ANTENNA FACTOR (dB /m)	CABLE LOSS (dB)	PREAMP FACTOR (dB)	ANTENNA HEIGHT (cm)	TABLE ANGLE (Degree)	REMARK
5572.8	60.5	61.72	68.3	-7.8	37.44	7.57	46.23	100	360	Peak
5968	58.43	58.89	68.3	-9.87	37.68	7.98	46.12	100	360	Peak

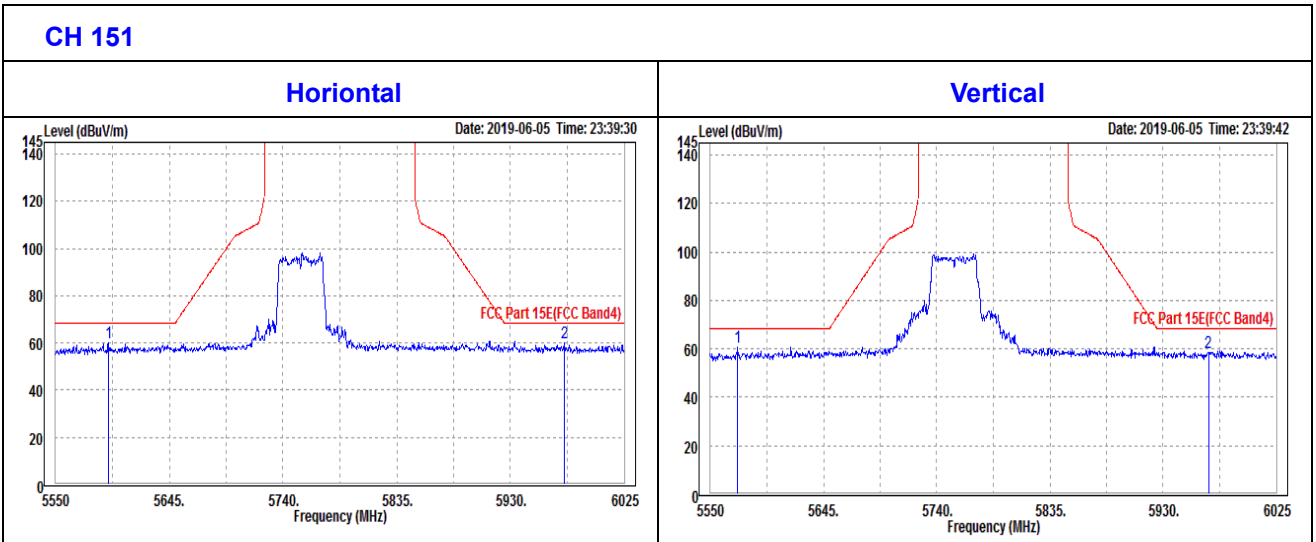



CHANNEL	TX Channel 159	DETECTOR FUNCTION	Peak (PK)
FREQUENCY RANGE	1GHz ~ 40GHz		Average (AV)

ANTENNA POLARITY & TEST DISTANCE: HORIZONTAL AT 3 M										
FREQ. (MHz)	EMISSION LEVEL (dBuV/m)	READ LEVEL (dBuV)	LIMIT (dBuV/m)	MARGIN (dB)	ANTENNA FACTOR (dB /m)	CABLE LOSS (dB)	PREAMP FACTOR (dB)	ANTENNA HEIGHT (cm)	TABLE ANGLE (Degree)	REMARK
5795	100.45	101.24			37.58	7.8	46.17	100	256	Peak
5795	88.88	89.67			37.58	7.8	46.17	100	256	Average

ANTENNA POLARITY & TEST DISTANCE: VERTICAL AT 3 M										
FREQ. (MHz)	EMISSION LEVEL (dBuV/m)	READ LEVEL (dBuV)	LIMIT (dBuV/m)	MARGIN (dB)	ANTENNA FACTOR (dB /m)	CABLE LOSS (dB)	PREAMP FACTOR (dB)	ANTENNA HEIGHT (cm)	TABLE ANGLE (Degree)	REMARK
5795	101.57	102.36			37.58	7.8	46.17	100	325	Peak
5795	90.9	91.69			37.58	7.8	46.17	100	325	Average

REMARKS:

1. Emission Level = Read Level+ Antenna Factor + Cable Loss- Preamp Factor
Margin value = Emission level – Limit value.
2. 5795MHz: Fundamental frequency.



OOBE DATA

802.11n (40MHZ)

ANTENNA POLARITY & TEST DISTANCE: HORIZONTAL AT 3 M										
FREQ. (MHz)	EMISSION LEVEL (dBuV/m)	READ LEVEL (dBuV)	LIMIT (dBuV/m)	MARGIN (dB)	ANTENNA FACTOR (dB /m)	CABLE LOSS (dB)	PREAMP FACTOR (dB)	ANTENNA HEIGHT (cm)	TABLE ANGLE (Degree)	REMARK
5598.93	58.23	59.39	68.3	-10.07	37.46	7.6	46.22	100	360	Peak
5983.68	59.11	59.54	68.3	-9.19	37.69	7.99	46.11	100	360	Peak
ANTENNA POLARITY & TEST DISTANCE: VERTICAL AT 3 M										
FREQ. (MHz)	EMISSION LEVEL (dBuV/m)	READ LEVEL (dBuV)	LIMIT (dBuV/m)	MARGIN (dB)	ANTENNA FACTOR (dB /m)	CABLE LOSS (dB)	PREAMP FACTOR (dB)	ANTENNA HEIGHT (cm)	TABLE ANGLE (Degree)	REMARK
5578.98	57.6	59.7	68.3	-10.7	36.55	7.58	46.23	100	0	Peak
5973.23	57.26	58.62	68.3	-11.04	36.78	7.98	46.12	100	0	Peak

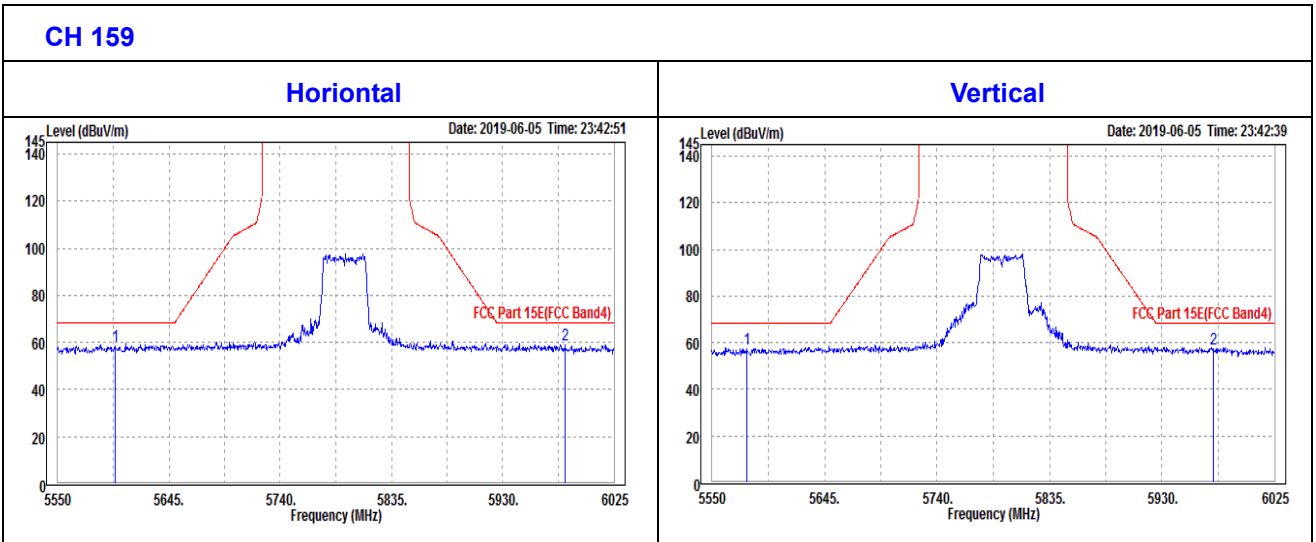



802.11ac (80MHz)

CHANNEL	TX Channel 155	DETECTOR FUNCTION	Peak (PK)
FREQUENCY RANGE	1GHz ~ 40GHz		Average (AV)

ANTENNA POLARITY & TEST DISTANCE: HORIZONTAL AT 3 M										
FREQ. (MHz)	EMISSION LEVEL (dBuV/m)	READ LEVEL (dBuV)	LIMIT (dBuV/m)	MARGIN (dB)	ANTENNA FACTOR (dB /m)	CABLE LOSS (dB)	PREAMP FACTOR (dB)	ANTENNA HEIGHT (cm)	TABLE ANGLE (Degree)	REMARK
5775	100.75	101.57			37.57	7.78	46.17	100	326	Peak
5775	90.62	91.44			37.57	7.78	46.17	100	326	Average
ANTENNA POLARITY & TEST DISTANCE: VERTICAL AT 3 M										
FREQ. (MHz)	EMISSION LEVEL (dBuV/m)	READ LEVEL (dBuV)	LIMIT (dBuV/m)	MARGIN (dB)	ANTENNA FACTOR (dB /m)	CABLE LOSS (dB)	PREAMP FACTOR (dB)	ANTENNA HEIGHT (cm)	TABLE ANGLE (Degree)	REMARK
5775	98.62	100.34			36.67	7.78	46.17	100	155	Peak
5775	88.48	90.2			36.67	7.78	46.17	100	155	Average

REMARKS:

1. Emission Level = Read Level+ Antenna Factor + Cable Loss- Preamp Factor
Margin value = Emission level – Limit value.
2. 5775MHz: Fundamental frequency.



**BUREAU
VERITAS**

Test Report No.: RF190522W010-3

OOBE DATA

802.11ac (80MHZ)

ANTENNA POLARITY & TEST DISTANCE: HORIZONTAL AT 3 M										
FREQ. (MHz)	EMISSION LEVEL (dBuV/m)	READ LEVEL (dBuV)	LIMIT (dBuV/m)	MARGIN (dB)	ANTENNA FACTOR (dB /m)	CABLE LOSS (dB)	PREAMP FACTOR (dB)	ANTENNA HEIGHT (cm)	TABLE ANGLE (Degree)	REMARK
5559.03	58.17	59.4	68.3	-10.13	37.44	7.56	46.23	100	0	Peak
5968.48	57.99	58.45	68.3	-10.31	37.68	7.98	46.12	100	0	Peak
ANTENNA POLARITY & TEST DISTANCE: VERTICAL AT 3 M										
FREQ. (MHz)	EMISSION LEVEL (dBuV/m)	READ LEVEL (dBuV)	LIMIT (dBuV/m)	MARGIN (dB)	ANTENNA FACTOR (dB /m)	CABLE LOSS (dB)	PREAMP FACTOR (dB)	ANTENNA HEIGHT (cm)	TABLE ANGLE (Degree)	REMARK
5566.63	58.19	59.41	68.3	-10.11	37.44	7.57	46.23	100	360	Peak
6005.05	58.39	58.8	68.3	-9.91	37.7	8	46.11	100	360	Peak

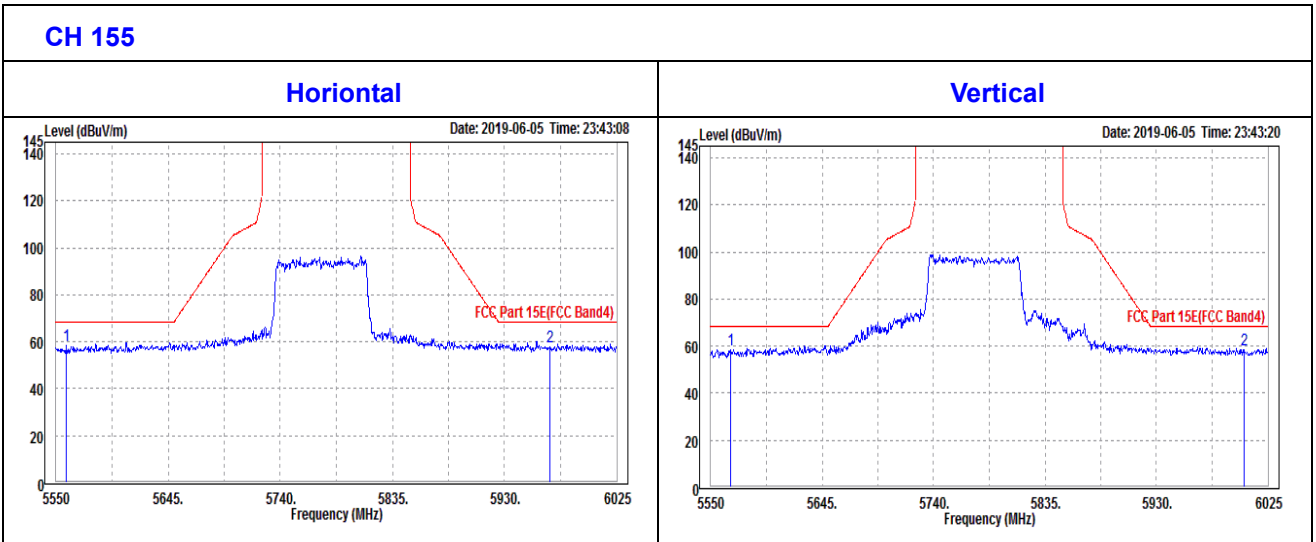



3.2 CONDUCTED EMISSION MEASUREMENT

3.2.1 LIMITS OF CONDUCTED EMISSION MEASUREMENT

FREQUENCY OF EMISSION (MHz)	CONDUCTED LIMIT (dBµV)	
	Quasi-peak	Average
0.15 ~ 0.5	66 to 56	56 to 46
0.5 ~ 5	56	46
5 ~ 30	60	50

- NOTE:**
1. The lower limit shall apply at the transition frequencies.
 2. The limit decreases in line with the logarithm of the frequency in the range of 0.15 to 0.50MHz.
 3. All emanations from a class A/B digital device or system, including any network of conductors and apparatus connected thereto, shall not exceed the level of field strengths specified above.

3.2.2 TEST INSTRUMENTS

Equipment	Manufacturer	Model No.	Serial No.	Last Cal.	Next Cal.
EMI Test Receiver	Rohde&Schwarz	ESR3	101900	Feb. 26,19	Feb. 25,20
EMC32 test software	Rohde&Schwarz	EMC32	NA	NA	NA
LISN network	Rohde&Schwarz	ENV216	101922	Feb. 26,19	Feb. 25,20

- NOTE:**
1. The test was performed in CE shielded room.
 2. The calibration interval of the above test instruments is 12 months. And the calibrations are traceable to CEPREI/CHINA, GRGT/CHINA and NIM/CHINA.

3.2.3 TEST PROCEDURES

- a. The EUT was placed 0.4 meters from the conducting wall of the shielded room with EUT being connected to the power mains through a line impedance stabilization network (LISN). Other support units were connected to the power mains through another LISN. The two LISNs provide 50 ohm/ 50uH of coupling impedance for the measuring instrument.
- b. Both lines of the power mains connected to the EUT were checked for maximum conducted interference.
- c. The frequency range from 150kHz to 30MHz was searched. Emission levels under (Limit - 20dB) was not recorded.

NOTE: All modes of operation were investigated and the worst-case emissions are reported.



3.2.4 DEVIATION FROM TEST STANDARD

No deviation.

3.2.5 TEST SETUP

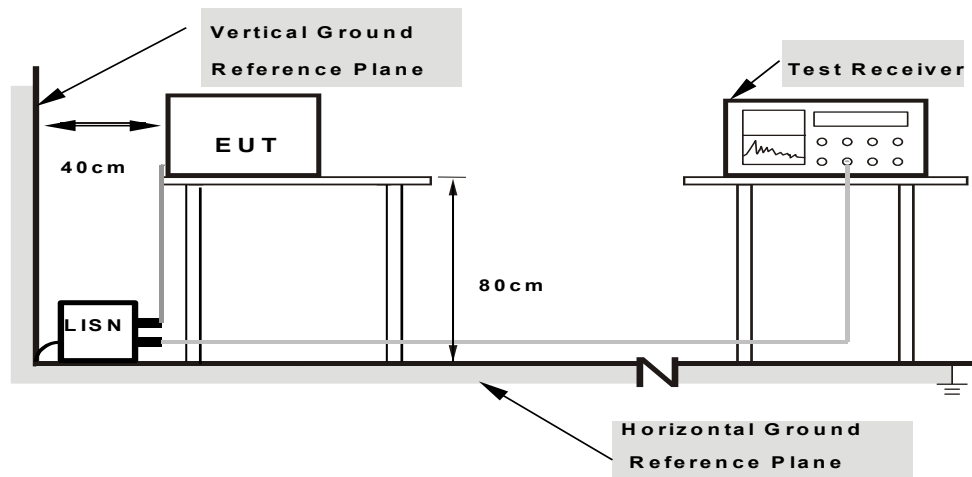

Note: 1.Support units were connected to second LISN.

2.Both of LISNs (AMN) are 80 cm from EUT and at least 80 cm from other units and other metal planes

For the actual test configuration, please refer to the attached file (Test Setup Photo).

3.2.6 EUT OPERATING CONDITIONS

Same as 3.1.6.



3.2.7 TEST RESULTS

CONDUCTED WORST-CASE DATA :

Frequency Range	150KHz ~ 30MHz	Detector Function & Resolution Bandwidth	Quasi-Peak (QP) / Average (AV), 9 kHz
Input Power	120Vac, 60Hz	Environmental Conditions	25deg. C, 52RH
Tested By	John Wen	TEST DATE	2019/04/12
Test Voltage	DC 5V From Adapter		

Frequency (MHz)	QuasiPeak (dBuV)	CAverage (dBuV)	Limit (dBuV)	Margin (dB)	Line	Filter	Corr. (dB)
0.348000	---	31.52	49.01	-17.49	L	ON	10.0
0.348000	41.90	---	59.01	-17.11	L	ON	10.0
0.572000	---	35.29	46.00	-10.71	L	ON	10.0
0.572000	45.34	---	56.00	-10.66	L	ON	10.0
1.132000	---	27.09	46.00	-18.91	L	ON	10.1
1.132000	39.74	---	56.00	-16.26	L	ON	10.1
2.684000	---	25.89	46.00	-20.11	L	ON	10.2
2.684000	37.74	---	56.00	-18.26	L	ON	10.2
4.044000	---	25.95	46.00	-20.05	L	ON	10.2
4.044000	37.56	---	56.00	-18.44	L	ON	10.2
11.884000	---	28.45	50.00	-21.55	L	ON	10.5
11.884000	41.25	---	60.00	-18.75	L	ON	10.5

- REMARKS:**
1. Q.P. and AV. are abbreviations of quasi-peak and average individually.
 2. "-": The Quasi-peak reading value also meets average limit and measurement with the average detector is unnecessary.
 3. The emission levels of other frequencies were very low against the limit.
 4. Margin value = Emission level - Limit value
 5. Correction factor = Insertion loss + Cable loss
 6. Emission Level = Correction Factor + Reading Value.

Full Spectrum

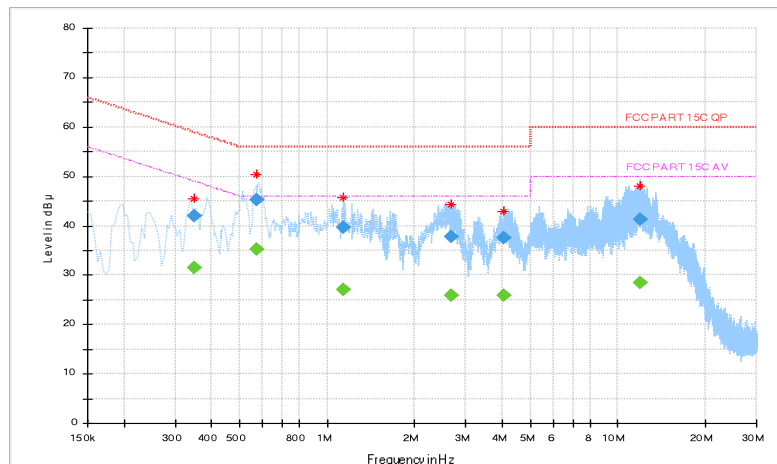



**BUREAU
VERITAS**

Test Report No.: RF190522W010-3

Frequency Range	150KHz ~ 30MHz	Detector Function & Resolution Bandwidth	Quasi-Peak (QP) / Average (AV), 9 kHz
Input Power	120Vac, 60Hz	Environmental Conditions	25deg. C, 52RH
Tested By	John Wen	TEST DATE	2019/04/12
Test Voltage	DC 5V From Adapter		

Frequency (MHz)	QuasiPeak (dBuV)	CAverage (dBuV)	Limit (dBuV)	Margin (dB)	Line	Filter	Corr. (dB)
0.590000	---	28.93	46.00	-17.07	N	ON	9.9
0.590000	38.11	---	56.00	-17.89	N	ON	9.9
1.156000	---	29.91	46.00	-16.09	N	ON	10.0
1.156000	41.00	---	56.00	-15.00	N	ON	10.0
1.584000	---	28.81	46.00	-17.19	N	ON	10.0
1.584000	40.05	---	56.00	-15.95	N	ON	10.0
2.824000	---	32.07	46.00	-13.93	N	ON	10.1
2.824000	42.95	---	56.00	-13.05	N	ON	10.1
4.354000	---	28.66	46.00	-17.34	N	ON	10.1
4.354000	39.92	---	56.00	-16.08	N	ON	10.1
16.880000	---	25.95	50.00	-24.05	N	ON	10.4
16.880000	39.58	---	60.00	-20.42	N	ON	10.4

- REMARKS:**
1. Q.P. and AV. are abbreviations of quasi-peak and average individually.
 2. "-": The Quasi-peak reading value also meets average limit and measurement with the average detector is unnecessary.
 3. The emission levels of other frequencies were very low against the limit.
 4. Margin value = Emission level - Limit value
 5. Correction factor = Insertion loss + Cable loss
 6. Emission Level = Correction Factor + Reading Value.

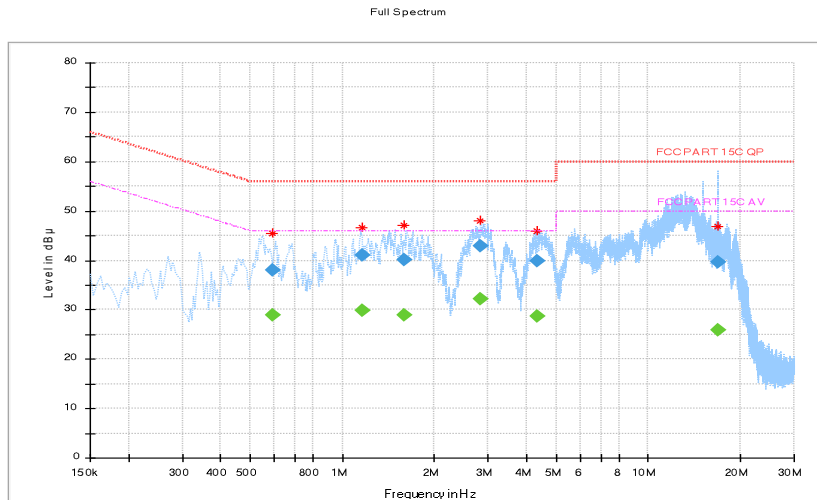



3.3 MAXIMUM CONDUCTED OUTPUT POWER MEASUREMENT

3.3.1 LIMITS OF MAXIMUM CONDUCTED OUTPUT POWER MEASUREMENT

Operation Band	EUT Category		LIMIT
U-NII-1		Outdoor Access Point	1 Watt (30 dBm) (Max. e.i.r.p ≤ 125mW(21 dBm) at any elevation angle above 30 degrees as measured from the horizon)
		Fixed point-to-point Access Point	1 Watt (30 dBm)
		Indoor Access Point	1 Watt (30 dBm)
	√	Client devices	250mW (24 dBm)
U-NII-2A	√		250mW (24 dBm) or 11 dBm+10 log B*
U-NII-2C	√		250mW (24 dBm) or 11 dBm+10 log B*
U-NII-3	√		1 Watt (30 dBm)

NOTE: Where B is the 26dB emission bandwidth in MHz.



3.3.2 TEST SETUP

FOR POWER OUTPUT MEASUREMENT

802.11a, 802.11n (20MHz), 802.11n (40MHz) TEST CONFIGURATION

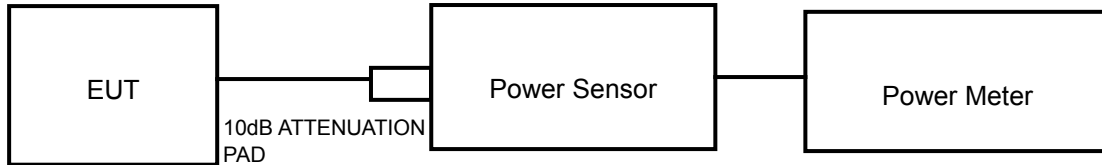

11ac TEST CONFIGURATION

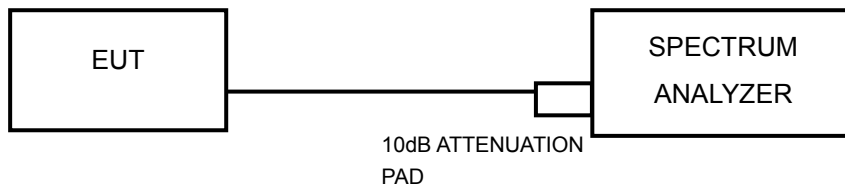

FOR 26dB BANDWIDTH

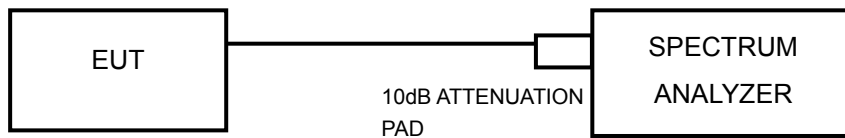

3.3.3 TEST INSTRUMENTS

Equipment	Manufacturer	Model No.	Serial No.	Last Cal.	Next Cal.
Power Meter	ANRITSU	ML2495A	1506002	Feb. 26,19	Feb. 25,20
EXA Signal Analyzer	KEYSIGHT	N9010A-526	MY54510322	Feb. 26,19	Feb. 25,20
EXA Signal Analyzer	KEYSIGHT	N9010A-544	MY54510355	Feb. 26,19	Feb. 25,20
Power Sensor	ANRITSU	MA2411B	1339352	Feb. 26,19	Feb. 25,20

NOTE:

1. The calibration interval of the above test instruments is 12 months and the calibrations are traceable to CEPREI/CHINA, GRGT/CHINA and NIM/CHINA.
2. The test was performed in RF Oven room.

3.3.4 TEST PROCEDURE

FOR POWER MEASUREMENT

For 802.11a, 802.11n (20MHz), 802.11n (40MHz)

Method PM is used to perform output power measurement, trigger and gating function of wide band power meter is enabled to measure max output power of TX on burst. Duty factor is not added to measured value.

For 802.11ac (80MHz)

1. Measure the duty cycle, x , of the transmitter output signal as described in II.B.
2. Set span to encompass the EBW (or, alternatively, the entire 99% occupied bandwidth) of the signal.
3. Set RBW = 1 MHz.
4. Set VBW \geq 3 MHz.
5. Number of points in sweep $\geq 2 \times \text{span} / \text{RBW}$. (This ensures that bin-to-bin spacing is $\leq \text{RBW}/2$, so that narrowband signals are not lost between frequency bins.)
6. Sweep time = auto.
7. Detector = power averaging (rms), if available. Otherwise, use sample detector mode.
8. Do not use sweep triggering. Allow the sweep to “free run.”
9. Trace average at least 100 traces in power averaging (rms) mode; however, the number of traces to be averaged shall be increased above 100 as needed to ensure that the average accurately represents the true average over the on and off periods of the transmitter.
10. Add $10 \log (1/x)$, where x is the duty cycle, to the measured power to compute the average power during the actual transmission times (because the measurement represents an average over both the on and off times of the transmission). For example, add $10 \log (1/0.25) = 6 \text{ dB}$ if the duty cycle is 25%.



FOR 99 PERCENT OCCUPIED BANDWIDTH

The following procedure shall be used for measuring (99 %) power bandwidth:

1. Set center frequency to the nominal EUT channel center frequency.
2. Set span = 1.5 times to 5.0 times the OBW.
3. Set RBW = 1 % to 5 % of the OBW
4. Set VBW $\geq 3 \cdot$ RBW
5. Video averaging is not permitted. Where practical, a sample detection and single sweep mode shall be used. Otherwise, peak detection and max hold mode (until the trace stabilizes) shall be used.
6. Use the 99 % power bandwidth function of the instrument (if available).
7. If the instrument does not have a 99 % power bandwidth function, the trace data points are recovered and directly summed in power units. The recovered amplitude data points, beginning at the lowest frequency, are placed in a running sum until 0.5 % of the total is reached; that frequency is recorded as the lower frequency. The process is repeated until 99.5 % of the total is reached; that frequency is recorded as the upper frequency. The 99% occupied bandwidth is the difference between these two frequencies.

FOR 26dB BANDWIDTH

- 1) Set RBW = approximately 1% of the emission bandwidth.
- 2) Set the VBW > RBW.
- 3) Detector = Peak.
- 4) Trace mode = max hold.
- 5) Measure the maximum width of the emission that is 26 dB down from the peak of the emission. Compare this with the RBW setting of the analyzer. Readjust RBW and repeat measurement as needed until the RBW/EBW ratio is approximately 1%.

FOR 6dB BANDWIDTH

1. Set RBW = 100 kHz.
2. Set the video bandwidth (VBW) ≥ 3 RBW.
3. Detector = Peak.
4. Trace mode = max hold.
5. Sweep = auto couple.
6. Allow the trace to stabilize.
7. Measure the maximum width of the emission that is constrained by the frequencies associated with the two outermost amplitude points (upper and lower frequencies) that are attenuated by 6 dB relative to the maximum level measured in the fundamental emission.



Test Report No.: RF190522W010-3

3.3.5 DEVIATION FROM TEST STANDARD

No deviation.

3.3.6 EUT OPERATING CONDITIONS

The software provided by client to enable the EUT under transmission condition continuously at specific channel frequencies individually.



3.3.7 TEST RESULTS

OUTPUT POWER:

802.11a

CHANNEL	CHANNEL FREQUENCY (MHz)	AVERAGE POWER (dBm)	AVERAGE POWER (mW)	POWER LIMIT (dBm)	PASS/FAIL
36	5180	14.34	27.164	24	PASS
40	5200	14.10	25.704	24	PASS
48	5240	14.11	25.763	24	PASS
52	5260	14.16	26.062	24	PASS
60	5300	14.06	25.468	24	PASS
64	5320	14.38	27.416	24	PASS
100	5500	14.13	25.882	24	PASS
116	5580	14.42	27.669	24	PASS
140	5700	14.15	26.002	24	PASS
149	5745	13.33	21.528	30	PASS
157	5785	13.11	20.464	30	PASS
161	5805	13.14	20.606	30	PASS

802.11n (20MHz)

CHANNEL	CHANNEL FREQUENCY (MHz)	AVERAGE POWER (dBm)	AVERAGE POWER (mW)	POWER LIMIT (dBm)	PASS/FAIL
36	5180	14.44	27.797	24	PASS
40	5200	14.17	26.122	24	PASS
48	5240	14.39	27.479	24	PASS
52	5260	14.02	25.235	24	PASS
60	5300	14.12	25.823	24	PASS
64	5320	14.27	26.730	24	PASS
100	5500	14.36	27.290	24	PASS
116	5580	14.19	26.242	24	PASS
140	5700	14.28	26.792	24	PASS
149	5745	13.28	21.281	30	PASS
157	5785	13.05	20.184	30	PASS
161	5805	13.23	21.038	30	PASS



802.11n (40MHz)

CHANNEL	CHANNEL FREQUENCY (MHz)	AVERAGE POWER (dBm)	AVERAGE POWER (mW)	POWER LIMIT (dBm)	PASS/FAIL
38	5190	12.03	15.959	24	PASS
46	5230	12.37	17.258	24	PASS
54	5270	12.60	18.197	24	PASS
62	5310	12.46	17.620	24	PASS
102	5510	12.22	16.672	24	PASS
110	5550	12.67	18.493	24	PASS
134	5670	12.42	17.458	24	PASS
151	5755	12.22	16.672	30	PASS
151	5755	12.12	16.293	30	PASS

802.11ac (80MHz)

CHANNEL	CHANNEL FREQUENCY (MHz)	AVERAGE POWER (dBm)	AVERAGE POWER (mW)	POWER LIMIT (dBm)	PASS/FAIL
42	5210	12.74	18.793	24	PASS
58	5290	12.73	18.750	24	PASS
106	5530	12.92	19.588	24	PASS
155	5775	11.38	13.740	30	PASS



99% OCCUPIED BANDWIDTH & 26dB BANDWIDTH/6dB BANDWIDTH:

802.11a

CHANNEL	CHANNEL FREQUENCY (MHz)	99% OCCUPIED BANDWIDTH	26dB BANDWIDTH (MHz)	PASS/FAIL
36	5180	16.98	21.94	PASS
40	5200	16.98	22.01	PASS
48	5240	17.04	22.03	PASS
52	5260	16.98	21.92	PASS
60	5300	16.98	22.20	PASS
64	5320	17.04	22.12	PASS
100	5500	16.98	22.07	PASS
116	5580	16.98	22.27	PASS
140	5700	16.98	21.98	PASS
CHANNEL	CHANNEL FREQUENCY (MHz)	99% OCCUPIED BANDWIDTH	6dB BANDWIDTH (MHz)	PASS/FAIL
149	5745	16.98	16.36	PASS
157	5785	16.92	16.36	PASS
161	5805	16.92	16.36	PASS



802.11n (20MHz)

CHANNEL	CHANNEL FREQUENCY (MHz)	99% OCCUPIED BANDWIDTH	26dB BANDWIDTH (MHz)	PASS/FAIL
36	5180	17.94	22.46	PASS
40	5200	18.06	22.66	PASS
48	5240	17.94	22.47	PASS
52	5260	18.00	22.40	PASS
60	5300	18.06	22.22	PASS
64	5320	18.06	22.64	PASS
100	5500	18.00	22.58	PASS
116	5580	18.00	22.63	PASS
140	5700	18.06	22.50	PASS
CHANNEL	CHANNEL FREQUENCY (MHz)	99% OCCUPIED BANDWIDTH	6dB BANDWIDTH (MHz)	PASS/FAIL
149	5745	18.06	17.62	PASS
157	5785	18.06	17.58	PASS
161	5805	18.00	17.56	PASS



802.11n (40MHz)

CHANNEL	CHANNEL FREQUENCY (MHz)	99% OCCUPIED BANDWIDTH	26dB BANDWIDTH (MHz)	PASS/FAIL
38	5190	36.42	44.75	PASS
46	5230	36.48	44.89	PASS
54	5270	36.42	45.48	PASS
62	5310	36.54	44.31	PASS
102	5510	36.42	45.27	PASS
110	5550	36.48	45.47	PASS
134	5670	36.42	44.99	PASS
CHANNEL	CHANNEL FREQUENCY (MHz)	99% OCCUPIED BANDWIDTH	6dB BANDWIDTH (MHz)	PASS/FAIL
151	5755	36.48	35.12	PASS
159	5795	36.42	35.15	PASS

802.11ac (80MHz)

CHANNEL	CHANNEL FREQUENCY (MHz)	99% OCCUPIED BANDWIDTH	26dB BANDWIDTH (MHz)	PASS/FAIL
42	5210	74.76	84.49	PASS
58	5290	74.64	84.16	PASS
106	5530	74.76	83.94	PASS
CHANNEL	CHANNEL FREQUENCY (MHz)	99% OCCUPIED BANDWIDTH	6dB BANDWIDTH (MHz)	PASS/FAIL
155	5775	74.76	71.36	PASS



BUREAU VERITAS

Test Report No.: RF190522W010-3

For U-NII-1:

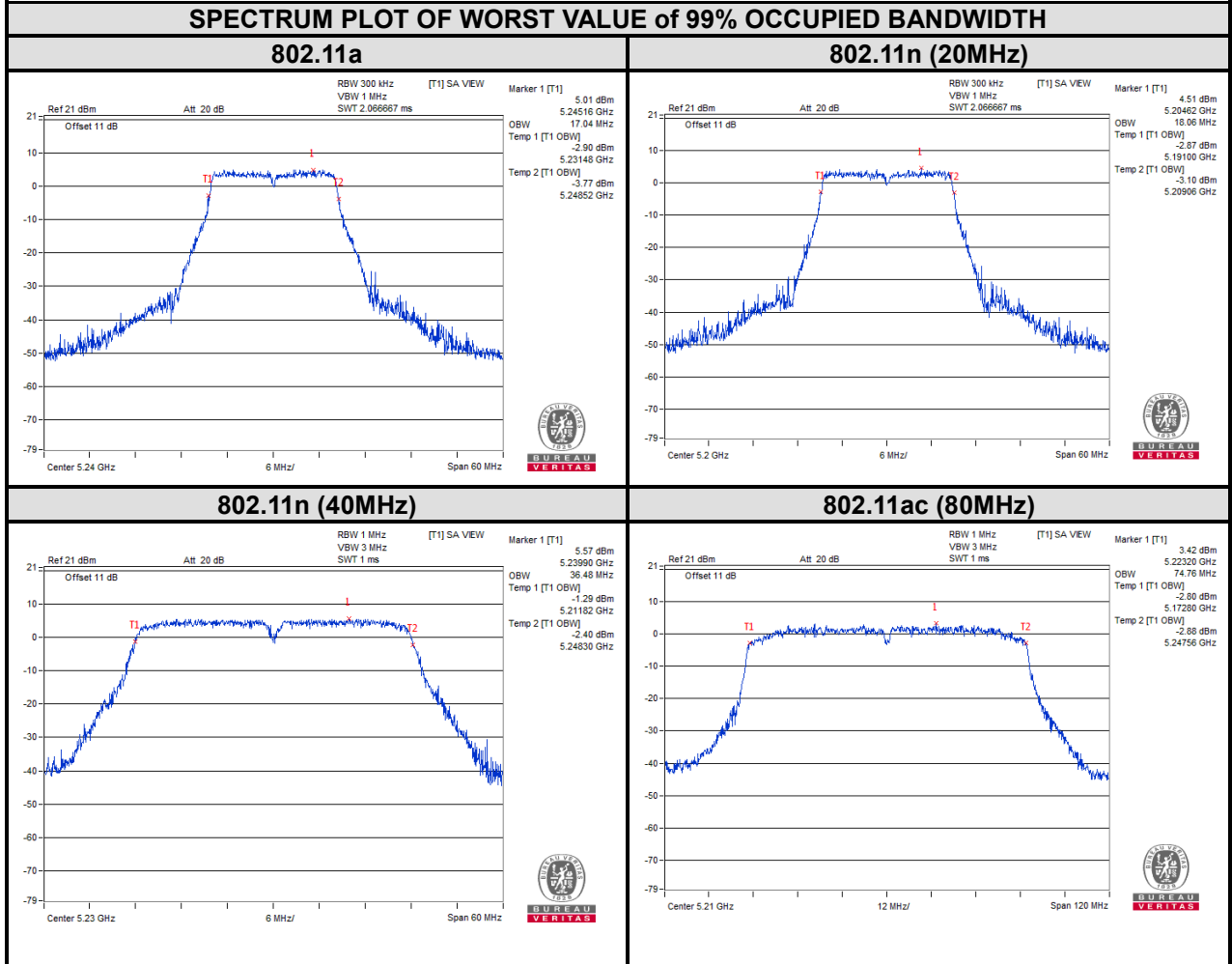

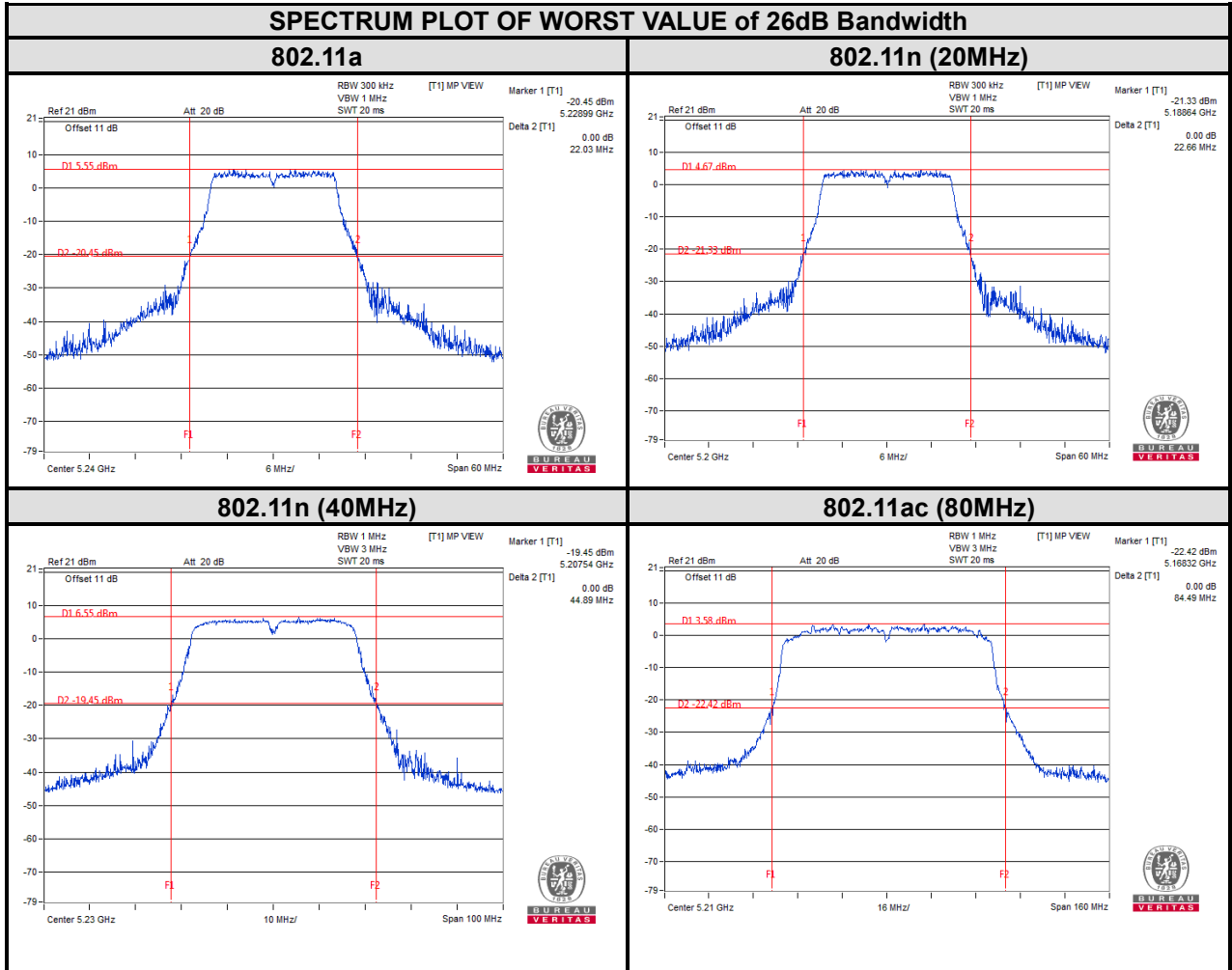



BUREAU VERITAS

Test Report No.: RF190522W010-3

For U-NII-2A:

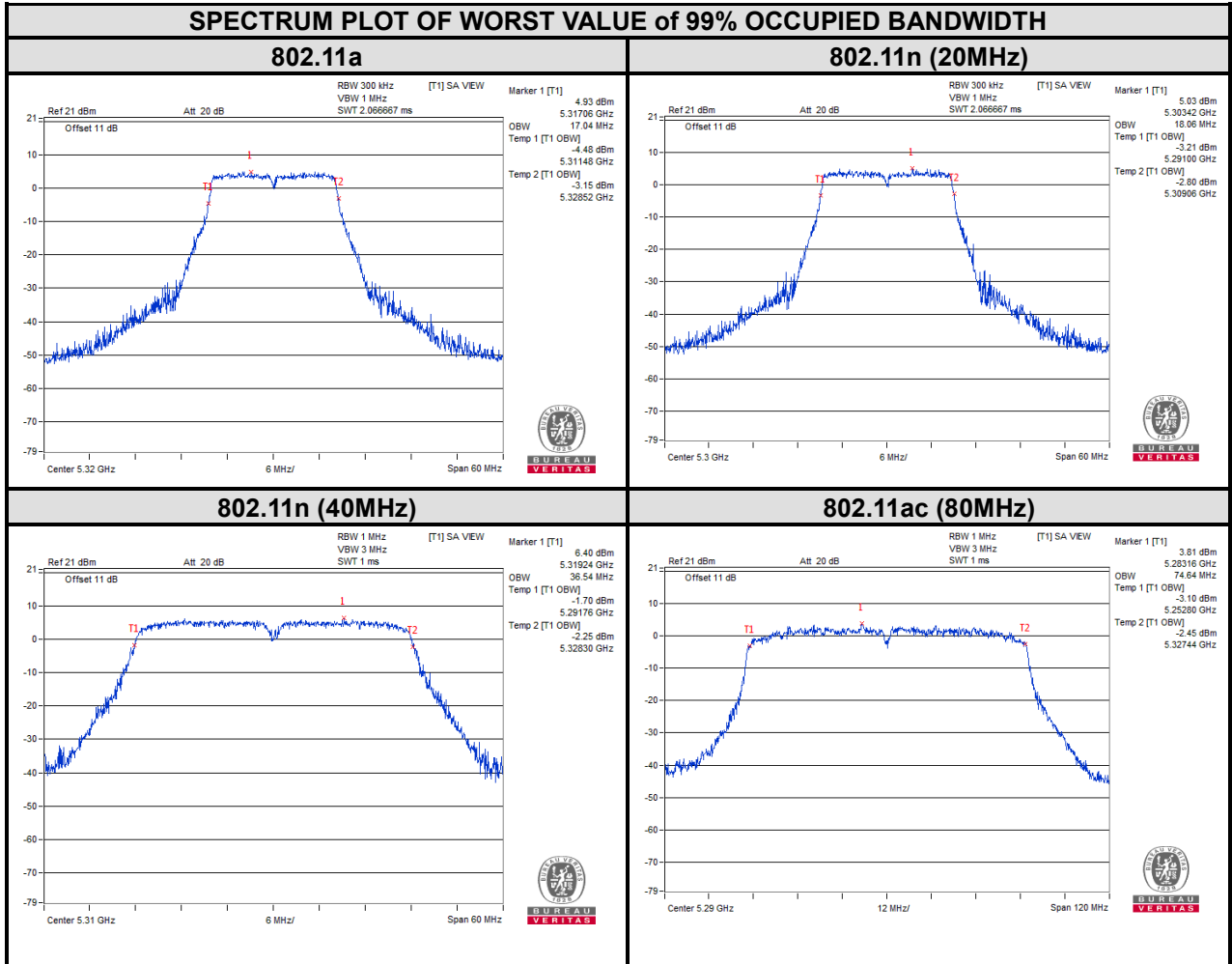

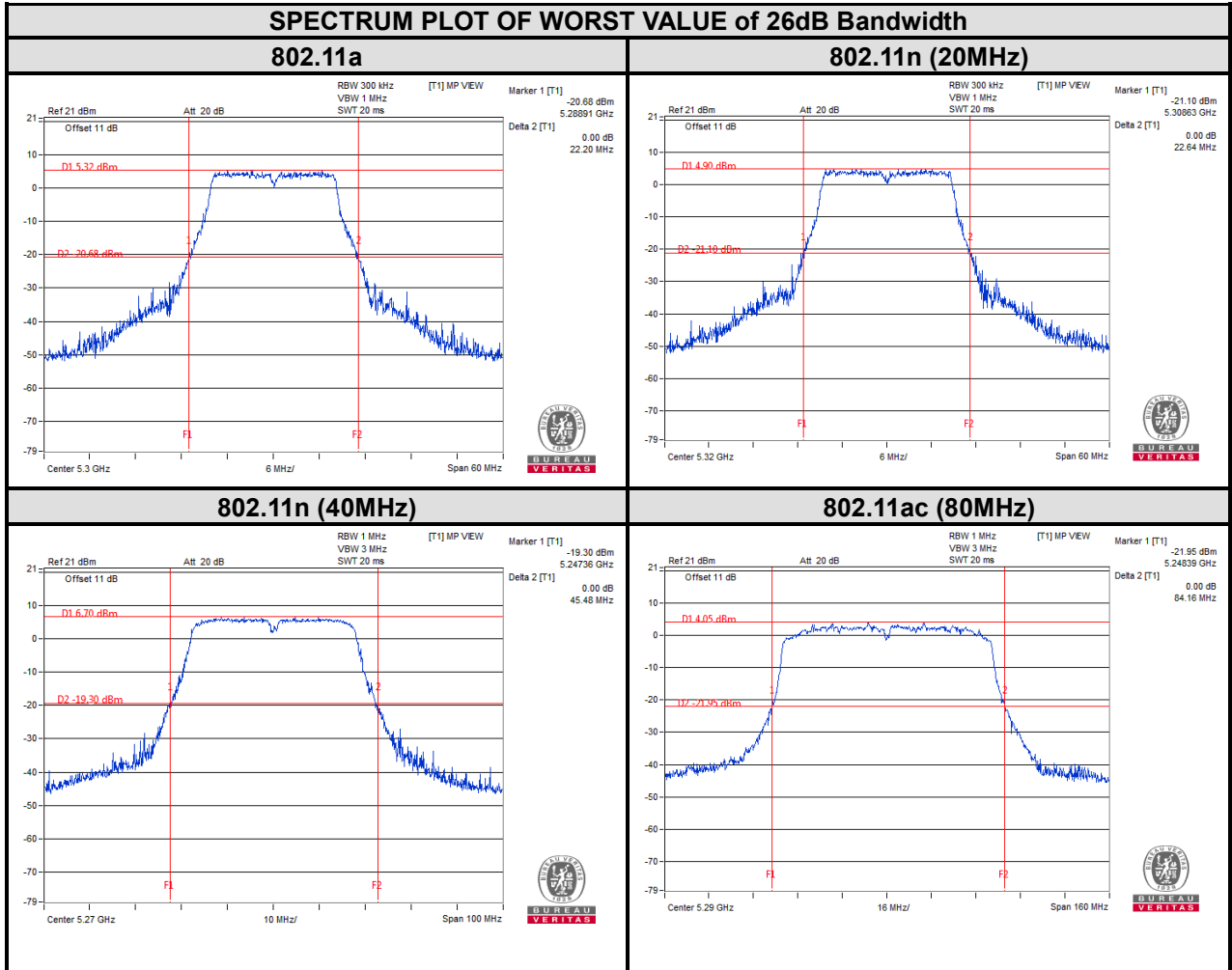



BUREAU VERITAS

Test Report No.: RF190522W010-3

For U-NII-2C:

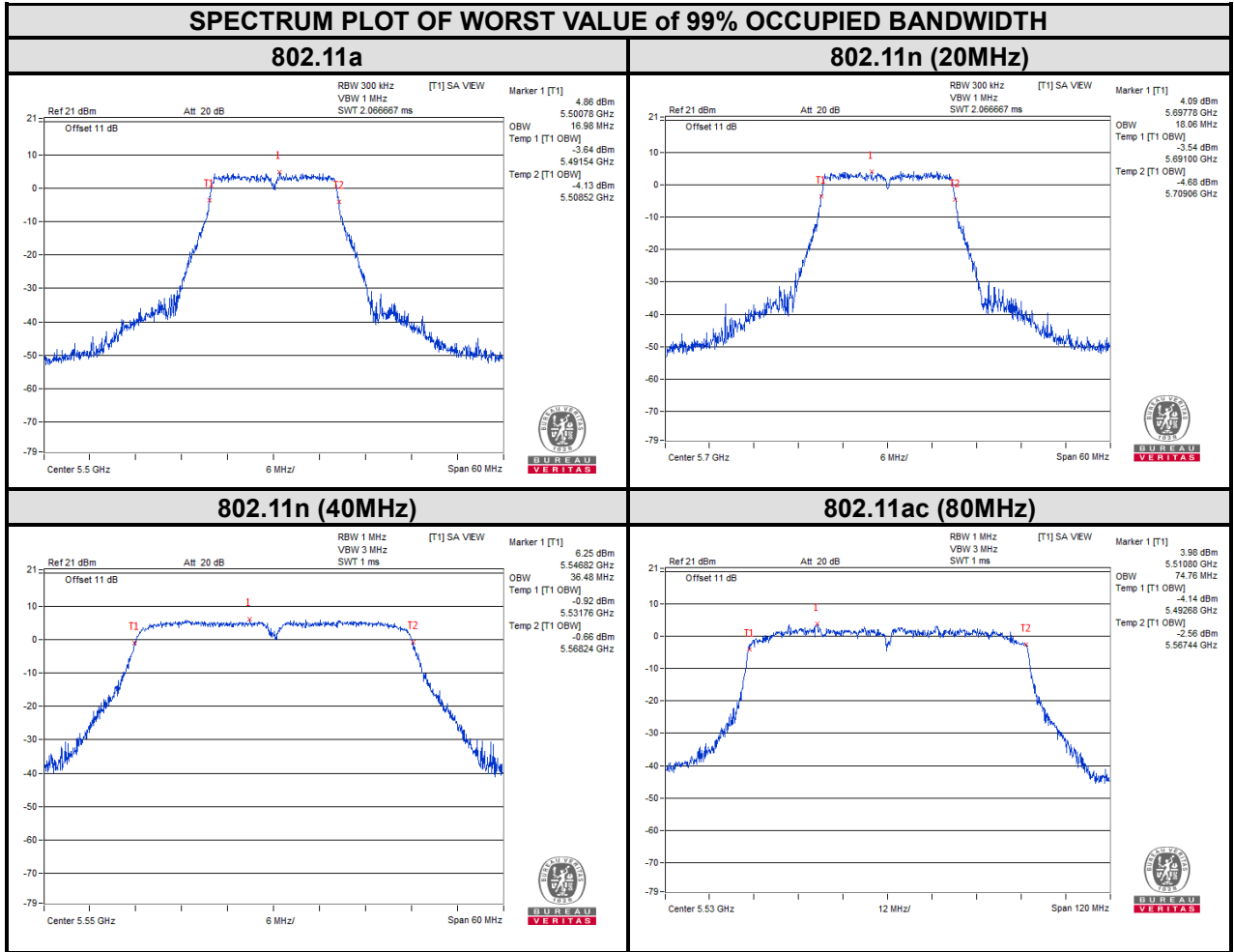



BUREAU VERITAS

Test Report No.: RF190522W010-3

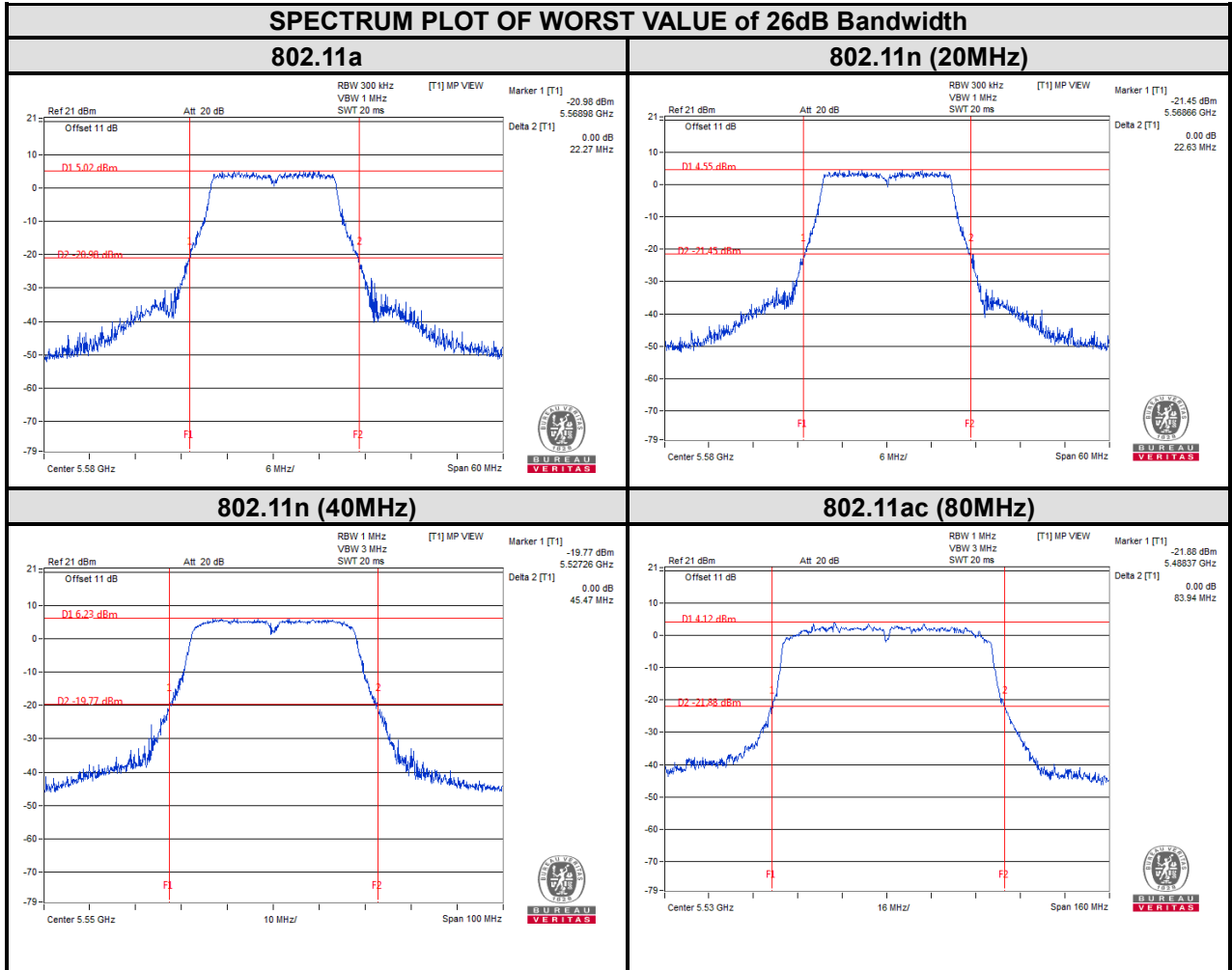



BUREAU VERITAS

Test Report No.: RF190522W010-3

For U-NII-3:

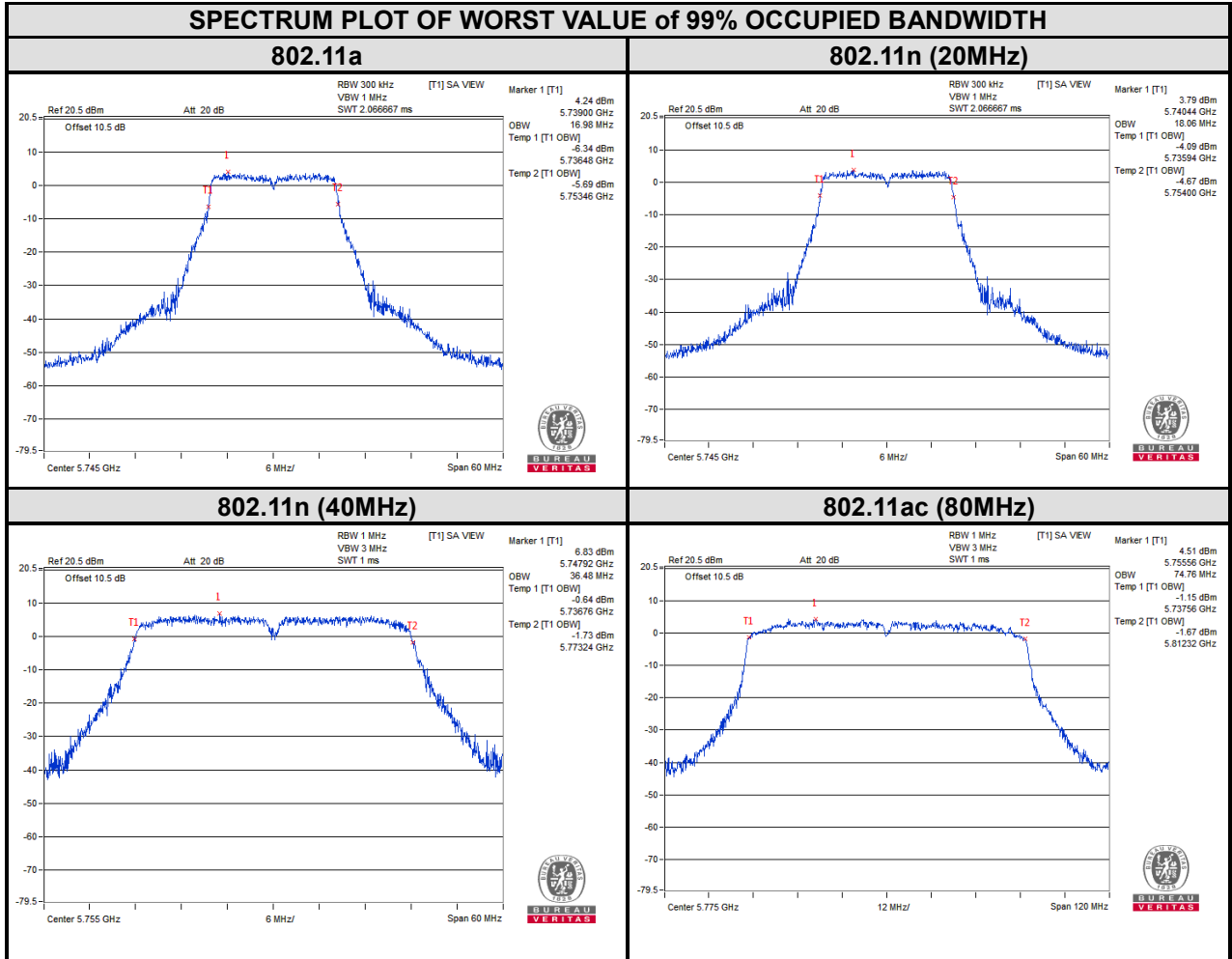



BUREAU VERITAS

Test Report No.: RF190522W010-3

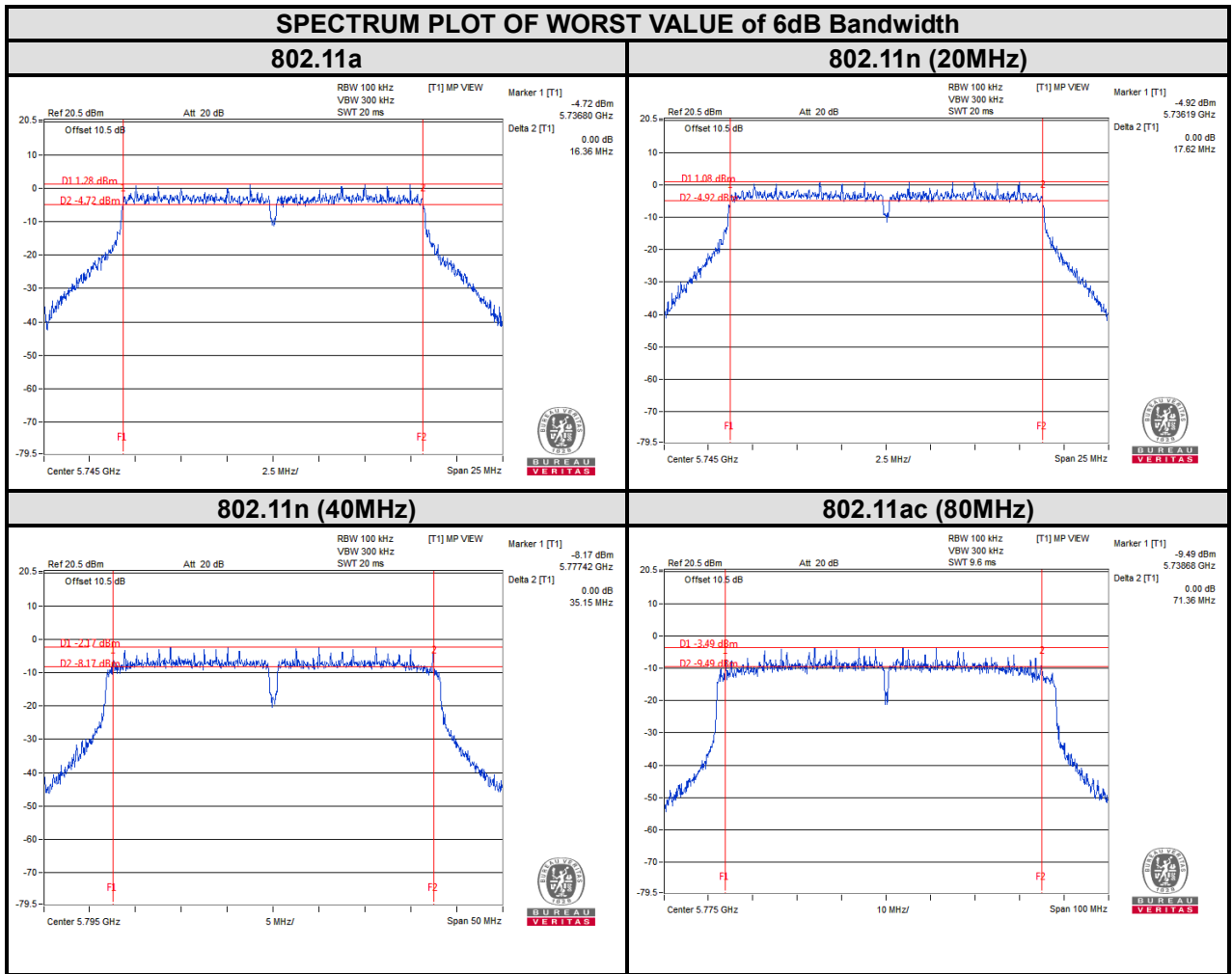

3.4 MAXIMUM POWER SPECTRAL DENSITY MEASUREMENT

3.4.1 LIMITS OF MAXIMUM POWER SPECTRAL DENSITY MEASUREMENT

Operation Band	EUT Category		LIMIT
U-NII-1		Outdoor Access Point	17dBm/ MHz
		Fixed point-to-point Access Point	
		Indoor Access Point	
	√	Client devices	11dBm/ MHz
U-NII-2A	√		11dBm/ MHz
U-NII-2C	√		11dBm/ MHz
U-NII-3	√		30dBm/ 500kHz

3.4.2 TEST SETUP

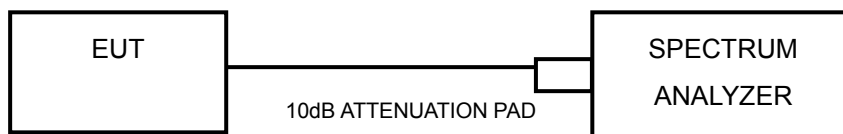

3.4.3 TEST INSTRUMENTS

Refer to section 3.3.3 to get information of above instrument.



3.4.4 TEST PROCEDURES

Using method SA-2

- 1) Set span to encompass the entire emission bandwidth (EBW) of the signal.
- 2) Set RBW = 1 MHz, Set VBW \geq 3 MHz, Detector = RMS
- 3) Set Channel power measure = 1MHz
- 4) Sweep time = auto, trigger set to "free run".
- 5) Trace average at least 100 traces in power averaging mode.
- 6) Add $10 \log(1/x)$, where x is the duty cycle, to the measured power in order to compute the average power during the actual transmission times (because the measurement represents an average over both the on and off times of the transmission).
- 7) Record the max value

3.4.5 DEVIATION FROM TEST STANDARD

No deviation.

3.4.6 EUT OPERATING CONDITIONS

Same as 3.1.6.



3.4.7 TEST RESULTS

For U-NII-1 & U-NII-2A & U-NII-2C:

802.11a

CHANNEL	FREQUENCY (MHz)	PSD w/o Duty Factor (dBm/MHz)	Duty Factor	PSD with Duty Factor (dBm/MHz)	MAXIMUM LIMIT (dBm/MHz)	PASS/FAIL
36	5180	7.73	0.60	8.33	11	PASS
40	5200	7.76	0.60	8.36	11	PASS
48	5240	7.86	0.60	8.46	11	PASS
52	5260	7.88	0.60	8.48	11	PASS
60	5300	7.95	0.60	8.55	11	PASS
64	5320	7.91	0.60	8.51	11	PASS
100	5500	8.61	0.60	9.21	11	PASS
116	5580	7.17	0.60	7.77	11	PASS
140	5700	7.06	0.60	7.66	11	PASS

802.11n (20MHz)

CHANNEL	FREQUENCY (MHz)	PSD w/o Duty Factor (dBm/MHz)	Duty Factor	PSD with Duty Factor (dBm/MHz)	MAXIMUM LIMIT (dBm/MHz)	PASS/FAIL
36	5180	7.89	0.70	8.59	11	PASS
40	5200	7.63	0.70	8.33	11	PASS
48	5240	8.67	0.70	9.37	11	PASS
52	5260	7.65	0.70	8.35	11	PASS
60	5300	8.04	0.70	8.74	11	PASS
64	5320	8.14	0.70	8.84	11	PASS
100	5500	8.15	0.70	8.85	11	PASS
116	5580	7.09	0.70	7.79	11	PASS
140	5700	7.28	0.70	7.98	11	PASS



802.11n (40MHz)

CHANNEL	FREQUENCY (MHz)	PSD w/o Duty Factor (dBm/MHz)	Duty Factor	PSD with Duty Factor (dBm/MHz)	MAXIMUM LIMIT (dBm/MHz)	PASS/FAIL
38	5190	3.36	1.25	4.61	11	PASS
46	5230	3.67	1.25	4.92	11	PASS
54	5270	3.63	1.25	4.88	11	PASS
62	5310	3.31	1.25	4.56	11	PASS
102	5510	2.88	1.25	4.13	11	PASS
110	5550	3.05	1.25	4.3	11	PASS
134	5670	2.59	1.25	3.84	11	PASS

802.11ac (80MHz)

CHANNEL	FREQUENCY (MHz)	PSD w/o Duty Factor (dBm/MHz)	Duty Factor	PSD with Duty Factor (dBm/MHz)	MAXIMUM LIMIT (dBm/MHz)	PASS/FAIL
42	5210	2.31	2.66	4.97	11	PASS
58	5290	2.57	2.66	5.23	11	PASS
106	5530	2.46	2.66	5.12	11	PASS



For U-NII-3:

802.11a

CHANNEL	FREQUENCY (MHz)	PSD w/o Duty Factor (dBm/MHz)	PSD w/o Duty Factor (dBm/500kHz)	Duty Factor	PSD with Duty Factor (dBm/500kHz)	LIMIT (dBm/500kHz)	PASS /FAIL
149	5745	2.07	-0.94	0.60	-0.34	30	PASS
157	5785	1.73	-1.28	0.60	-0.68	30	PASS
161	5805	1.62	-1.39	0.60	-0.79	30	PASS

802.11n (20MHz)

CHANNEL	FREQUENCY (MHz)	PSD w/o Duty Factor (dBm/MHz)	PSD w/o Duty Factor (dBm/500kHz)	Duty Factor	PSD with Duty Factor (dBm/500kHz)	LIMIT (dBm/500kHz)	PASS /FAIL
149	5745	1.83	-1.18	0.70	-0.48	30	PASS
157	5785	1.46	-1.55	0.70	-0.85	30	PASS
161	5805	1.55	-1.46	0.70	-0.76	30	PASS

802.11n (40MHz)

CHANNEL	FREQUENCY (MHz)	PSD w/o Duty Factor (dBm/MHz)	PSD w/o Duty Factor (dBm/500kHz)	Duty Factor	PSD with Duty Factor (dBm/500kHz)	LIMIT (dBm/500kHz)	PASS /FAIL
151	5755	-1.48	-4.49	1.25	-3.24	30	PASS
159	5795	-2.03	-5.04	1.25	-3.79	30	PASS

802.11ac (80MHz)

CHANNEL	FREQUENCY (MHz)	PSD w/o Duty Factor (dBm/MHz)	PSD w/o Duty Factor (dBm/500kHz)	Duty Factor	PSD with Duty Factor (dBm/500kHz)	LIMIT (dBm/500kHz)	PASS /FAIL
155	5775	-4.19	-7.20	2.66	-4.54	30	PASS



BUREAU VERITAS

Test Report No.: RF190522W010-3

For 5180~5240MHz

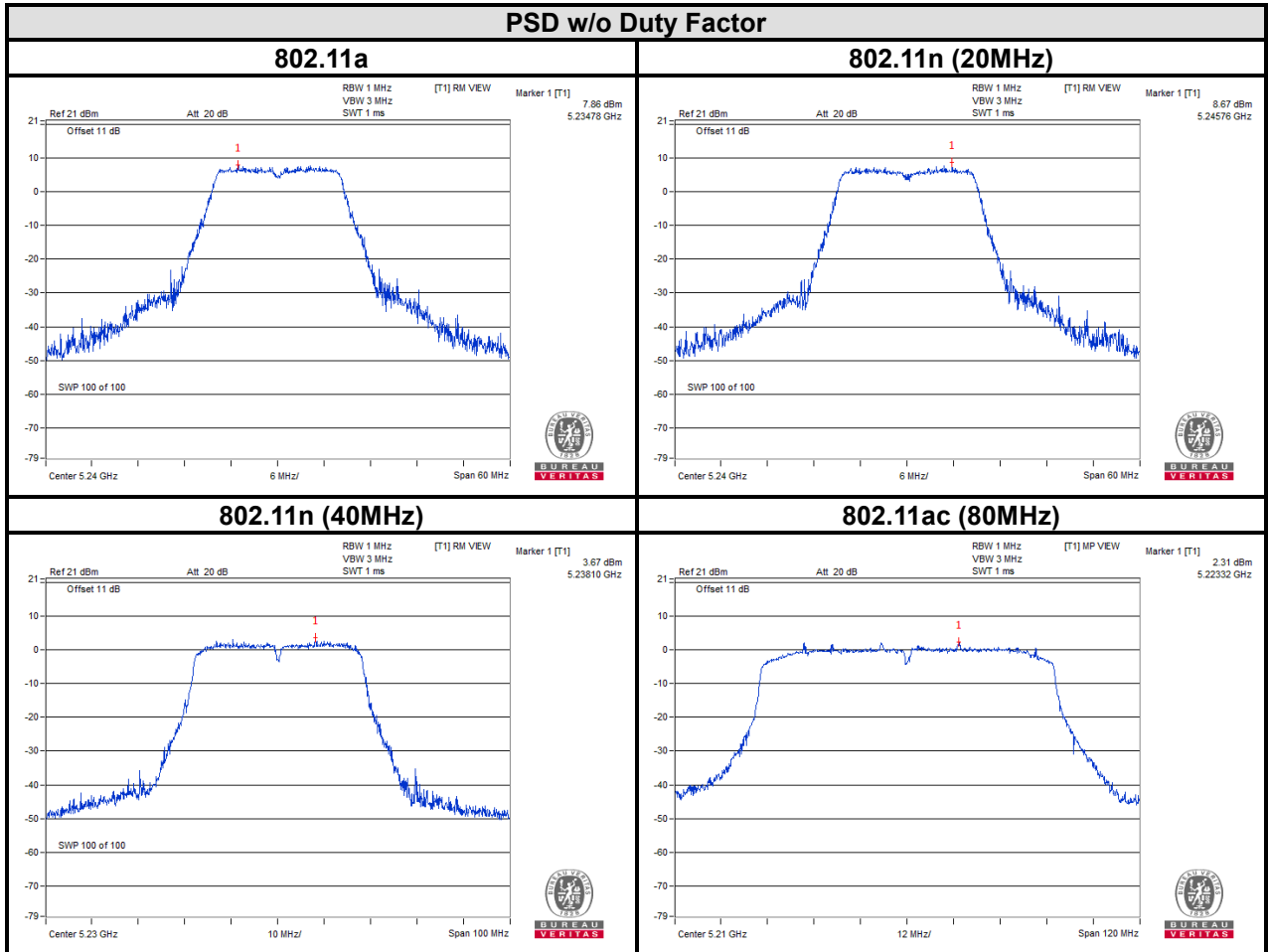



BUREAU VERITAS

Test Report No.: RF190522W010-3

For 5260~5320MHz

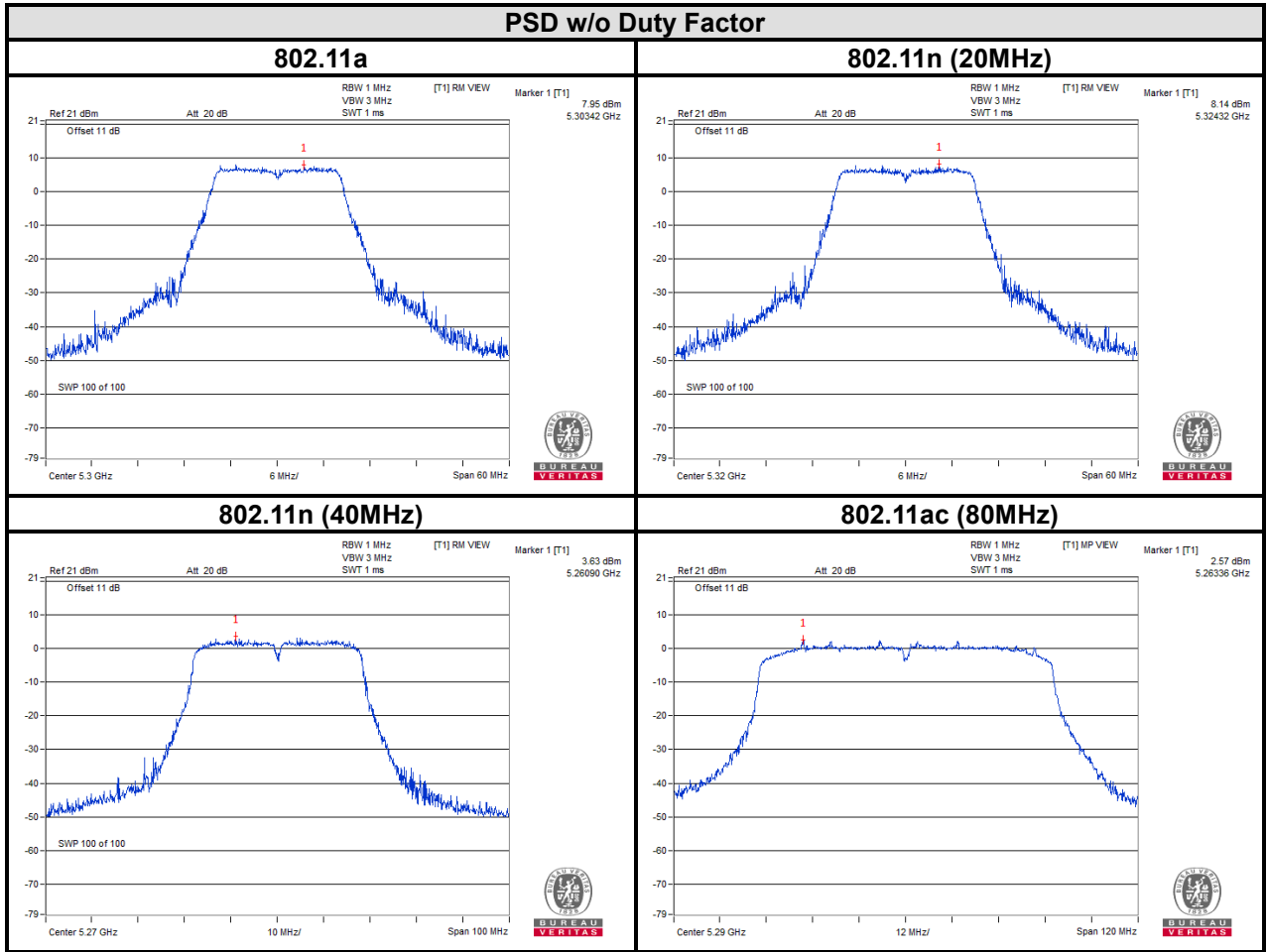



BUREAU VERITAS

Test Report No.: RF190522W010-3

For 5500~5700MHz

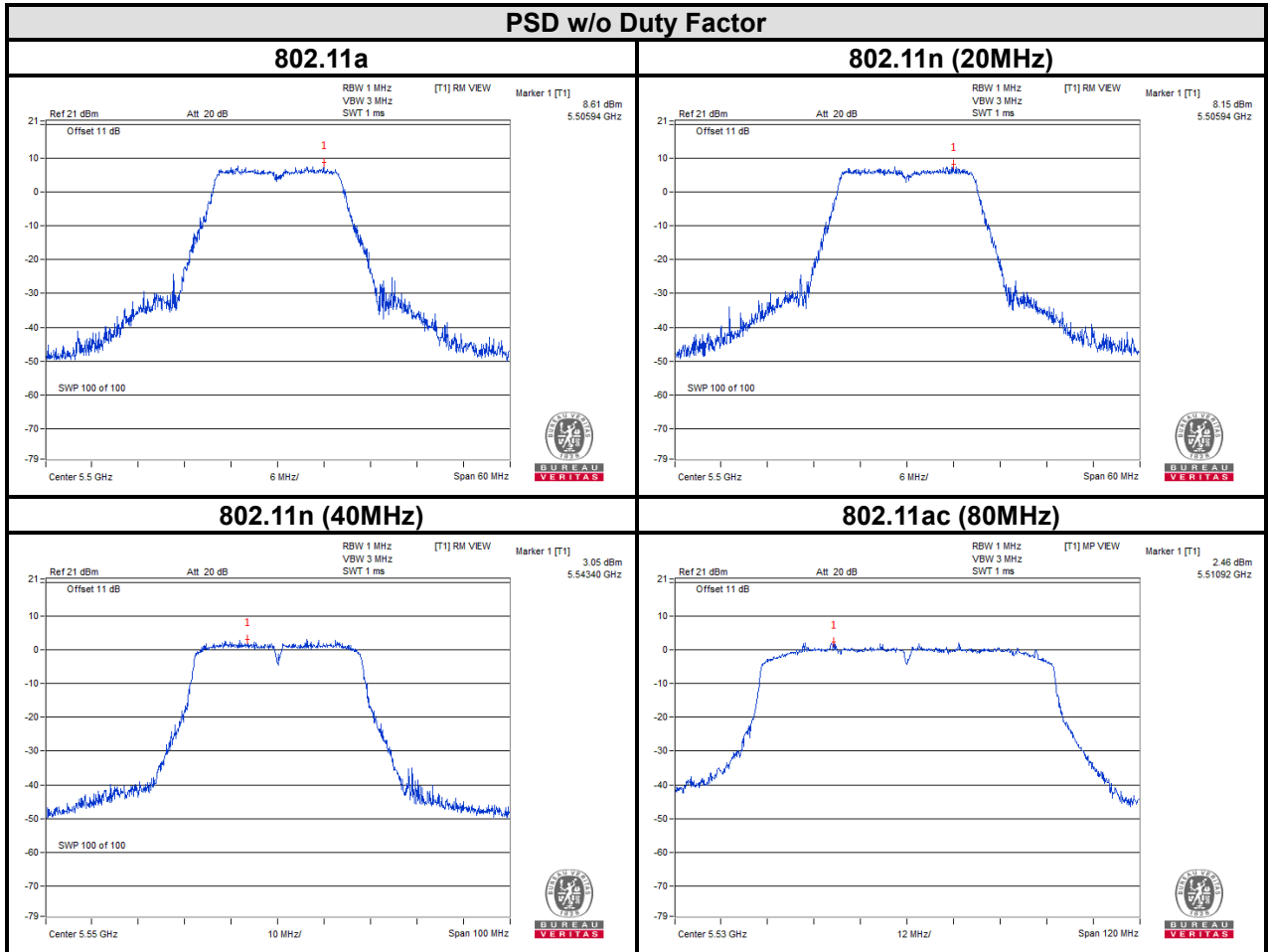



BUREAU VERITAS

Test Report No.: RF190522W010-3

For 5745~5805MHz

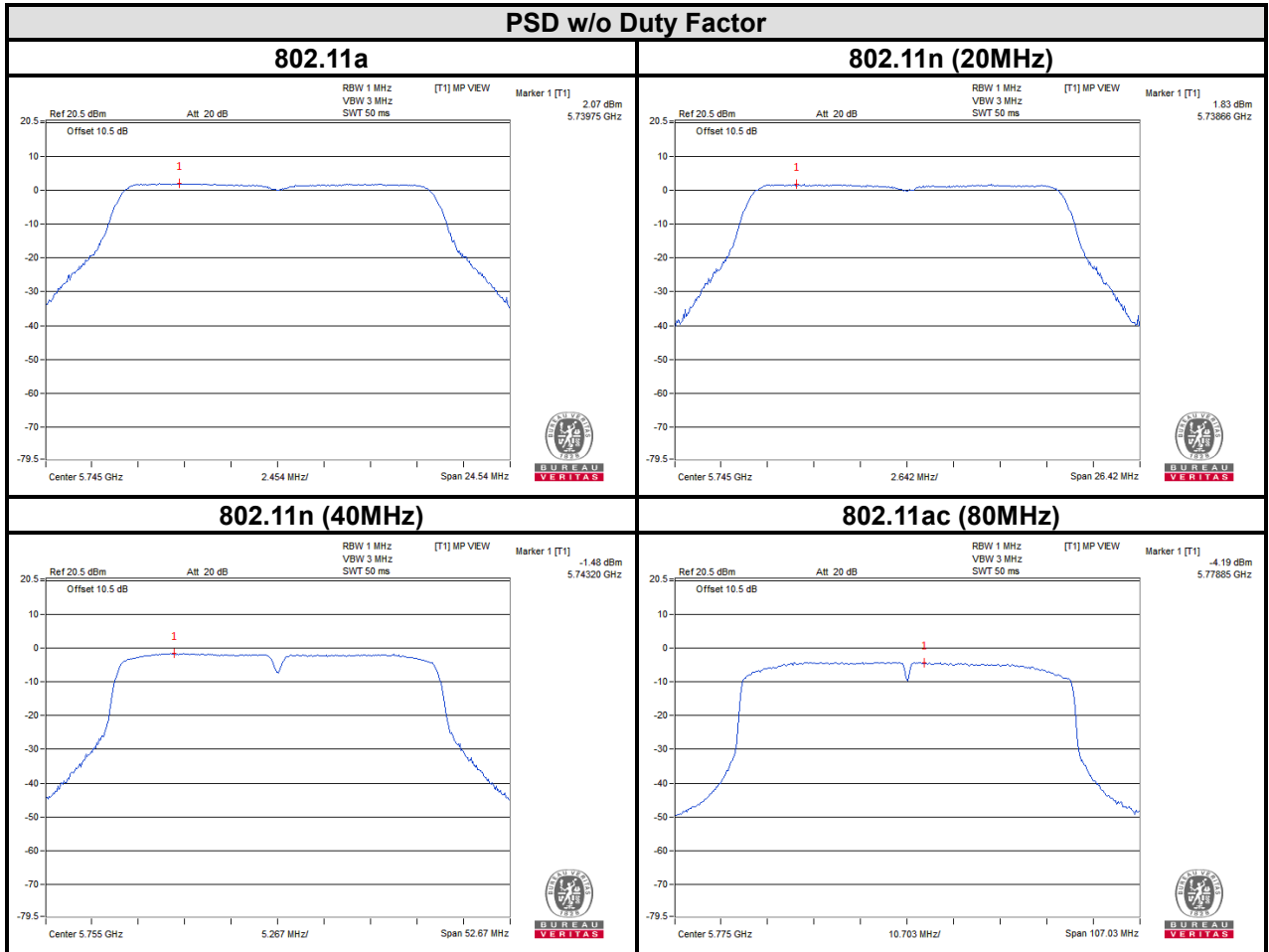



3.5 FREQUENCY STABILITY

3.5.1 LIMITS OF FREQUENCY STABILITY MEASUREMENT

The frequency of the carrier signal shall be maintained within band of operation

3.5.2 TEST SETUP

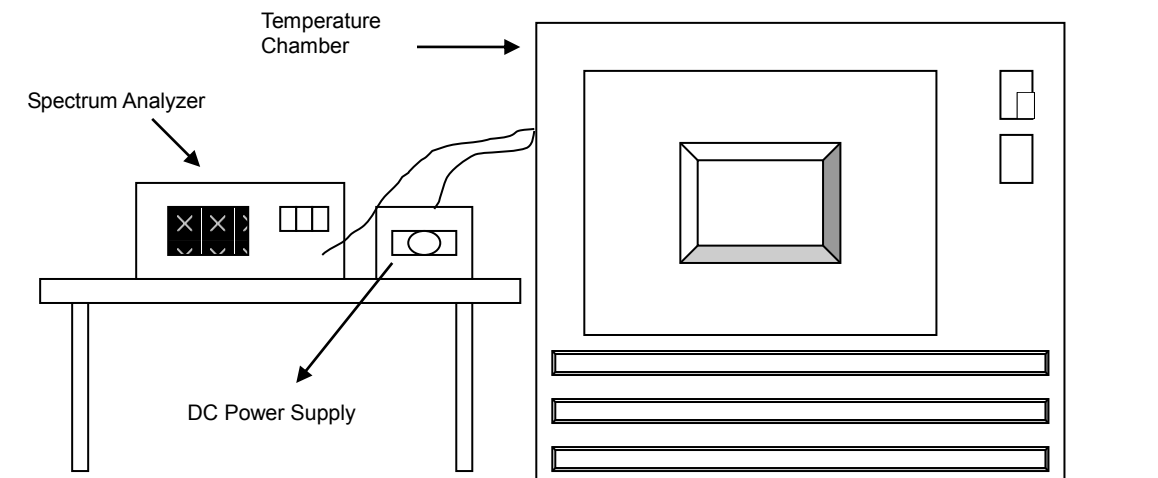

3.5.3 TEST INSTRUMENTS

Refer to section 3.3.3 to get information of above instrument.



3.5.4 TEST PROCEDURE

- a. The EUT was placed inside the environmental test chamber and powered by nominal DC voltage.
- b. Turn the EUT on and couple its output to a spectrum analyzer.
- c. Turn the EUT off and set the chamber to the highest temperature specified.
- d. Allow sufficient time (approximately 30 min) for the temperature of the chamber to stabilize, turn the EUT on and measure the operating frequency after 2, 5, and 10 minutes.
- e. Repeat step 2 and 3 with the temperature chamber set to the lowest temperature.
- f. The test chamber was allowed to stabilize at +20 degree C for a minimum of 30 minutes. The supply voltage was then adjusted on the EUT from 85% to 115% and the frequency record.

3.5.5 DEVIATION FROM TEST STANDARD

No deviation.

3.5.6 EUT OPERATING CONDITION

Set the EUT transmit at un-modulation mode to test frequency stability.



3.5.7 TEST RESULTS

FREQUENCY STABILITY VERSUS TEMP.										
OPERATING FREQUENCY: 5180MHz										
TEMP. (°C)	Power Supply (Vdc)	0 MINUTE		2 MINUTES		5 MINUTES		10 MINUTE		RESULT
		Measured Frequency (MHz)	Frequency Drift (ppm)	Measured Frequency (MHz)	Frequency Drift (ppm)	Measured Frequency (MHz)	Frequency Drift (ppm)	Measured Frequency (MHz)	Frequency Drift (ppm)	
50	120	5179.9798	-3.900	5179.98	-3.861	5179.9854	-2.819	5179.9871	-2.490	PASS
40	120	5179.9967	-0.637	5179.9925	-1.448	5179.9879	-2.336	5179.9958	-0.811	PASS
30	120	5179.9873	-2.452	5179.9918	-1.583	5179.9851	-2.876	5179.9928	-1.390	PASS
20	120	5179.9948	-1.004	5179.9957	-0.830	5179.9968	-0.618	5179.9949	-0.985	PASS
10	120	5179.9732	-5.174	5179.9759	-4.653	5179.9724	-5.328	5179.9802	-3.822	PASS
0	120	5180.0138	2.664	5180.0143	2.761	5180.0154	2.973	5180.0117	2.259	PASS
-10	120	5179.98	-3.861	5179.977	-4.440	5179.9828	-3.320	5179.9793	-3.996	PASS
-20	120	5179.9922	-1.506	5179.9896	-2.008	5179.9871	-2.490	5179.998	-0.386	PASS
-30	120	5180.0104	2.008	5180.0107	2.066	5180.0102	1.969	5180.0151	2.915	PASS

FREQUENCY STABILITY VERSUS VOLTAGE										
OPERATING FREQUENCY: 5180MHz										
TEMP. (°C)	Power Supply (Vdc)	0 MINUTE		2 MINUTE		5 MINUTE		10 MINUTE		RESULT
		Measured Frequency (MHz)	Frequency Drift (ppm)	Measured Frequency (MHz)	Frequency Drift (ppm)	Measured Frequency (MHz)	Frequency Drift (ppm)	Measured Frequency (MHz)	Frequency Drift (ppm)	
20	138	5179.9948	-1.004	5179.9958	-0.811	5179.9959	-0.792	5179.9933	-1.293	PASS
	120	5179.9948	-1.004	5179.9957	-0.830	5179.9968	-0.618	5179.9949	-0.985	PASS
	102	5179.9954	-0.888	5179.9964	-0.695	5179.9954	-0.888	5179.9945	-1.062	PASS



FREQUENCY STABILITY VERSUS TEMP.										
OPERATING FREQUENCY: 5805MHz										
TEMP. (°C)	Power Supply (Vdc)	0 MINUTE		2 MINUTES		5 MINUTES		10 MINUTE		RESULT
		Measured Frequency (MHz)	Frequency Drift (ppm)	Measured Frequency (MHz)	Frequency Drift (ppm)	Measured Frequency (MHz)	Frequency Drift (ppm)	Measured Frequency (MHz)	Frequency Drift (ppm)	
50	120	5805.0205	3.531	5805.0215	3.704	5805.024	4.134	5805.0175	3.015	PASS
40	120	5805.007	1.206	5805.0151	2.601	5805.0168	2.894	5805.0169	2.911	PASS
30	120	5804.9973	-0.465	5805.0005	0.086	5804.9937	-1.085	5804.9997	-0.052	PASS
20	120	5804.996	-0.689	5804.9866	-2.308	5804.9864	-2.343	5804.9857	-2.463	PASS
10	120	5805.0009	0.155	5805.0066	1.137	5805.0047	0.810	5805.0018	0.310	PASS
0	120	5804.996	-0.689	5804.999	-0.172	5804.9987	-0.224	5804.9926	-1.275	PASS
-10	120	5805.0129	2.222	5805.0094	1.619	5805.0131	2.257	5805.0104	1.792	PASS
-20	120	5805.024	4.134	5805.0243	4.186	5805.0226	3.893	5805.0214	3.686	PASS
-30	120	5805.0089	1.533	5805.0074	1.275	5805.0011	0.189	5805.0052	0.896	PASS

FREQUENCY STABILITY VERSUS VOLTAGE										
OPERATING FREQUENCY: 5805MHz										
TEMP. (°C)	Power Supply (Vdc)	0 MINUTE		2 MINUTE		5 MINUTE		10 MINUTE		RESULT
		Measured Frequency (MHz)	Frequency Drift (ppm)	Measured Frequency (MHz)	Frequency Drift (ppm)	Measured Frequency (MHz)	Frequency Drift (ppm)	Measured Frequency (MHz)	Frequency Drift (ppm)	
20	138	5804.9955	-0.775	5804.9871	-2.222	5804.9861	-2.394	5804.985	-2.584	PASS
	120	5804.996	-0.689	5804.9866	-2.308	5804.9864	-2.343	5804.9857	-2.463	PASS
	102	5804.9974	-0.448	5804.9863	-2.360	5804.9861	-2.394	5804.9861	-2.394	PASS



Test Report No.: RF190522W010-3

4 PHOTOGRAPHS OF THE TEST CONFIGURATION

Please refer to the attached file (Test Setup Photo).



Test Report No.: RF190522W010-3

5 APPENDIX A – MODIFICATIONS RECORDERS FOR ENGINEERING CHANGES TO THE EUT BY THE LAB

No modifications were made to the EUT by the lab during the test.

---END---