

FCC TEST REPORT

(Part 15, Subpart E)



Applicant:	Lenovo(Shanghai) Electronics Technology Co., Ltd.
Address:	NO.68 BUILDING, 199 FENJU RD, China (Shanghai) Pilot Free Trade Zone, 200131, CHINA

Manufacturer or Supplier:	Lenovo PC HK Limited
Address:	23/F, Lincoln House, Taikoo Place 979 King's Road, Quarry Bay, Hong Kong
Product:	Portable Tablet Computer
Brand Name:	Lenovo
Model Name:	Lenovo TB-X605F
FCC ID:	O57TBX605F
Date of tests:	Oct. 23, 2018 ~ Nov. 03, 2018

The tests have been carried out according to the requirements of the following standard:

FCC Part 15, Subpart E, Section 15.407

CONCLUSION: The submitted sample was found to COMPLY with the test requirement

Prepared by Roger Li Engineer / Mobile Department	Approved by Sam Tung Manager / Mobile Department
	
Date: Nov. 05, 2018	Date: Nov. 05, 2018

This report is governed by, and incorporates by reference, CPS Conditions of Service as posted at the date of issuance of this report at <http://www.bureauveritas.com/home/about-us/our-business/cps/about-us/terms-conditions> and is intended for your exclusive use. Any copying or replication of this report to or for any other person or entity, or use of our name or trademark, is permitted only with our prior written permission. This report sets forth our findings solely with respect to the test samples identified herein. The results set forth in this report are not indicative or representative of the quality or characteristics of the lot from which a test sample was taken or any similar or identical product unless specifically and expressly noted. Our report includes all of the tests requested by you and the results thereof based upon the information that you provided to us. Measurement uncertainty is only provided upon request for accredited tests. You have 60 days from date of issuance of this report to notify us of any material error or omission caused by our negligence or if you require measurement uncertainty; provided, however, that such notice shall be in writing and shall specifically address the issue you wish to raise. A failure to raise such issue within the prescribed time shall constitute your unqualified acceptance of the completeness of this report, the tests conducted and the correctness of the report contents.



TABLE OF CONTENTS

RELEASE CONTROL RECORD 4

1 SUMMARY OF TEST RESULTS 5

1.1 MEASUREMENT UNCERTAINTY 5

2 GENERAL INFORMATION 6

2.1 GENERAL DESCRIPTION OF EUT 6

2.2 DESCRIPTION OF TEST MODES 9

 2.2.1 TEST MODE APPLICABILITY AND TESTED CHANNEL DETAIL 11

2.3 DUTY CYCLE OF TEST SIGNAL 14

2.4 DESCRIPTION OF SUPPORT UNITS 14

 2.4.1 CONFIGURATION OF SYSTEM UNDER TEST 14

2.5 GENERAL DESCRIPTION OF APPLIED STANDARDS 15

3 TEST TYPES AND RESULTS 16

3.1 RADIATED EMISSION AND BANDEDGE MEASUREMENT 16

 3.1.1 LIMITS OF RADIATED EMISSION AND BANDEDGE MEASUREMENT 16

 3.1.2 LIMITS OF UNWANTED EMISSION 17

 3.1.3 TEST INSTRUMENTS 18

 3.1.4 TEST PROCEDURES 19

 3.1.5 DEVIATION FROM TEST STANDARD 19

 3.1.6 TEST SETUP 20

 3.1.7 EUT OPERATING CONDITION 21

 3.1.8 TEST RESULTS 22

3.2 CONDUCTED EMISSION MEASUREMENT 26

 3.2.1 LIMITS OF CONDUCTED EMISSION MEASUREMENT 26

 3.2.2 TEST INSTRUMENTS 26

 3.2.3 TEST PROCEDURES 26

 3.2.4 DEVIATION FROM TEST STANDARD 27

 3.2.5 TEST SETUP 27

 3.2.6 EUT OPERATING CONDITIONS 27

 3.2.7 TEST RESULTS 28

3.3 MAXIMUM CONDUCTED OUTPUT POWER MEASUREMENT 30

 3.3.1 LIMITS OF MAXIMUM CONDUCTED OUTPUT POWER MEASUREMENT 30

 3.3.2 TEST SETUP 31

 3.3.3 TEST INSTRUMENTS 31



3.3.4	TEST PROCEDURE	32
3.3.5	DEVIATION FROM TEST STANDARD	33
3.3.6	EUT OPERATING CONDITIONS	33
3.3.7	TEST RESULTS	33
3.4	MAXIMUM POWER SPECTRAL DENSITY MEASUREMENT	34
3.4.1	LIMITS OF MAXIMUM POWER SPECTRAL DENSITY MEASUREMENT	34
3.4.2	TEST SETUP	34
3.4.3	TEST INSTRUMENTS	34
3.4.4	TEST PROCEDURES	35
3.4.5	DEVIATION FROM TEST STANDARD	35
3.4.6	EUT OPERATING CONDITIONS	35
3.4.7	TEST RESULTS	35
3.5	FREQUENCY STABILITY	36
3.5.1	LIMITS OF FREQUENCY STABILITY MEASUREMENT	36
3.5.2	TEST SETUP	36
3.5.3	TEST INSTRUMENTS	36
3.5.4	TEST PROCEDURE	37
3.5.5	DEVIATION FROM TEST STANDARD	37
3.5.6	EUT OPERATING CONDITION	37
3.5.7	TEST RESULTS	37
4	PHOTOGRAPHS OF THE TEST CONFIGURATION	38
5	APPENDIX A – MODIFICATIONS RECORDERS FOR ENGINEERING CHANGES TO THE EUT BY THE LAB	39



**BUREAU
VERITAS**

Test Report No.: RF181022W002-3

RELEASE CONTROL RECORD

ISSUE NO.	REASON FOR CHANGE	DATE ISSUED
RF180626C04-4	Original release	Aug. 01, 2018
RF181022W002-3	Based on the original reports RF180626C04-4 add a battery / two speakers & Lenovo Smart Dock and its adapter.	Nov. 05, 2018



1 SUMMARY OF TEST RESULTS

The EUT has been tested according to the following specifications:

APPLIED STANDARD: FCC PART 15, SUBPART E (SECTION 15.407)			
STANDARD SECTION	TEST TYPE AND LIMIT	RESULT	REMARK
15.407(b)(5)	AC Power Conducted Emission	PASS	Meet the requirement of limit. Minimum passing margin is -27.64dB at 0.356000MHz.
15.407(b) (1/2/3/4/6)	Radiated Emission & Band Edge Measurement	PASS	Meet the requirement of limit. Minimum passing margin is -4.58dB at 789.33MHz.
15.407(a/1/2/3)	Maximum conducted output Power	N/A(see note)	Meet the requirement of limit.
15.407(a/1/2/3)	Peak Power Spectral Density	N/A(see note)	Meet the requirement of limit.
15.407(e)	6 dB Bandwidth	N/A(see note)	Meet the requirement of limit. (U-NII-3 Band only)
15.407(g)	Frequency Stability	N/A(see note)	Meet the requirement of limit.
15.203	Antenna Requirement	PASS	No antenna connector is used.

NOTE: Reports RF180626C04-4 was test in Bureau Veritas Consumer Products Services (H.K.) Ltd., Taoyuan Branch.

1.1 MEASUREMENT UNCERTAINTY

Where relevant, the following measurement uncertainty levels have been estimated for tests performed on the EUT as specified in CISPR 16-4-2:

MEASUREMENT	FREQUENCY	UNCERTAINTY
Conducted emissions	9kHz~30MHz	2.66dB
Radiated emissions	9KHz ~ 30MHz	2.68dB
	30MHz ~ 1GMHz	3.26dB
	1GHz ~ 18GHz	4.48dB
	18GHz ~ 40GHz	4.12dB

This uncertainty represents an expanded uncertainty expressed at approximately the 95% confidence level using a coverage factor of k = 2.



2 GENERAL INFORMATION

2.1 GENERAL DESCRIPTION OF EUT

EUT	Portable Tablet Computer
MODEL NO.	Lenovo TB-X605F
POWER SUPPLY	5.0Vdc (adapter or host equipment) 3.85Vdc (Li-ion) DC 5V (HA200)
MODULATION TYPE	64QAM, 16QAM, QPSK, BPSK
MODULATION TECHNOLOGY	OFDM
TRANSFER RATE	802.11a: 54.0/ 48.0/ 36.0/ 24.0/ 18.0/ 12.0/ 9.0/ 6.0Mbps 802.11n: up to MCS7 802.11ac: up to 390.0Mbps
OPERATING FREQUENCY	5180 ~ 5240MHz, 5260 ~ 5320MHz, 5500 ~ 5700MHz, 5745 ~ 5825MHz
NUMBER OF CHANNEL	5180 ~ 5240MHz: 4 for 802.11a, 802.11n (20MHz) 2 for 802.11n (40MHz) 1 for 802.11ac (80MHz) 5260 ~ 5320MHz: 4 for 802.11a, 802.11n (20MHz) 2 for 802.11n (40MHz) 1 for 802.11ac (80MHz) 5500 ~ 5700MHz: 8 for 802.11a, 802.11n (20MHz) 3 for 802.11n (40MHz) 1 for 802.11ac (80MHz) 5745 ~ 5825MHz: 5 for 802.11a, 802.11n (20MHz) 2 for 802.11n (40MHz) 1 for 802.11ac (80MHz)
AVERAGE POWER	54.325mW for 5180 ~ 5240MHz 58.749mW for 5260 ~ 5320MHz 57.148mW for 5500 ~ 5700MHz 48.641mW for 5745 ~ 5825MHz
ANTENNA TYPE	Monopole Antenna with -4dBi gain
HW VERSION	Lenovo Tablet TB-X605F
SW VERSION	TB-X605F_RF01_20180615
I/O PORTS	Refer to user's manual
CABLE SUPPLIED	USB cable: non-shielded, detachable, 1.0meter

NOTE:

- For a more detailed features description, please refer to the manufacturer's specifications or the user's manual.



2. There were Sample A, B, C, D, E and F for this project, the difference is as below:

SAMPLE	EUT CONFIGURATION INFORMATION
A	LCD Panel 2+Photo Camera 1+Photo Camera 3+CPU 1+EMMC1+DDR1+speaker 1+speaker 2+ motor2 + Main Broad 1+BT/WLAN Module+ Battery
B	LCD Panel 2+Photo Camera 2+Photo Camera 4+CPU 1+EMMC2+DDR2+speaker 1+speaker 2+motor1 + Main Broad 2 +BT/WLAN Module+ Battery
C	LCD Panel 2+Photo Camera 1+Photo Camera 3+CPU 1+EMMC3+DDR3+speaker 1+speaker 2 +motor2 + Main Broad 1+BT/WLAN Module+ Battery
D	LCD Panel 2+Photo Camera 2+Photo Camera 4+CPU 1+EMMC4+DDR4+speaker 1+speaker 2+motor1 + Main Broad 2+BT/WLAN Module+ Battery
E	LCD Panel 2+Photo Camera 1+Photo Camera 3+CPU 1+EMMC5+DDR5+speaker 1+speaker 2+motor2 + Main Broad 1+BT/WLAN Module+ Battery
F	LCD Panel 2+Photo Camera 2+Photo Camera 4+CPU 1+EMMC6+DDR6+speaker 1+speaker 2+motor1 + Main Broad 2+BT/WLAN Module+ Battery

3. The EUT incorporates a SISO function. Physically, the EUT provides one completed transmitter and one receiver.

MODULATION MODE	TX FUNCTION
802.11a	1TX/1RX
802.11n (20MHz)	1TX/1RX
802.11n (40MHz)	1TX/1RX
802.11ac (80MHz)	1TX/1RX

4. For the test results, the EUT had been tested with all conditions. But only the worst case was shown in test report.



List of Accessories:

ACCESSORIES	BRAND	MODEL	SPECIFICATION	Manufacturer
AC Adapter 1	Salom	SC-42, SC-43	I/P:100-240Vac, 300mA O/P: 5Vdc, 2000mA	-
AC Adapter 2	AcBel	SC-42, SC-43	I/P:100-240Vac, 300mA O/P: 5Vdc, 2000mA	-
AC Adapter 1 (For Dock)	XinSPower	A241-1202000U	I/P:100-240Vac, 800mA O/P: 12Vdc, 2000mA	-
AC Adapter 2 (For Dock)	N/A	CYSE20-120200U	I/P:100-240Vac, 600mA O/P: 12Vdc, 2000mA	-
Lenovo Smart Dock	Lenovo	Lenovo HA-200	I/P: 12Vdc, 2000mA O/P: 5Vdc, 1500mA	
Battery 1	Lenovo	L18D1P32	Rating: 3.85Vdc, 4850mAh	Amperex
Battery 2	Lenovo	L18D1P32	Rating: 3.85Vdc, 4850mAh	Sunwoda
USB Cable 1(White)	LiQi	LQ-02300039	1.0m shielded cable w/o core	-
USB Cable 2(Black)	LiQi	LQ-02300040	1.0m shielded cable w/o core	-
LCD Panel1 (Black)	BOE	TV101WUM-LL2	10.1 "	-
LCD Panel2(White)	BOE	TV101WUM-LL3	10.1 "	-
EMMC1+DDR1	SAMSUNG	KMQE60013M-B318(2+16)	16G	-
EMMC2+DDR2	HYNIX	H9TQ17ABJTCCUR-KUM(2+16)	16G	-
EMMC3+DDR3	SAMSUNG	KMGD6001BM-B421(3+32)	32G	-
EMMC4+DDR4	HYNIX	H9TQ27ADFTMCUR-KUM(3+32)	32G	-
EMMC5+DDR5	SAMSUNG	KMRH60014A-B614(4+64)	64G	-
EMMC6+DDR6	HYNIX	H9TQ52ACLTMCUR-KUM(4+64)	64G	-
Speaker 1	Keysound	QM171219AW84	-	-
Speaker 2	Keysound	QM171219AW85	-	-
Speaker 3	Honghua	SB9655B	-	-
Speaker 4	Honghua	SB9655A	-	-
motor1	AWA	YK2455R	-	-
Motor2	Baolong	BLX-431320S	-	-
Photo Camera 1	Lcetron	LE5143AM	5M AF	-
Photo Camera 2	Holitek	MF81Q	5M AF	-
Photo Camera 3	Lcetron	ZRT2509V-P102F	2M FF	-
Photo Camera 4	Holitech	HSU1005	2M FF	-
CPU	Qualcomm	SDA450	792nsp	-
Main Broad 1	huashen	W93M71B2-3-03	-	-
Main Broad 2	yilianda	W93M71B2-3-05	-	-
BT/WLAN Module	Qualcomm	WCN3680B	-	-

Remark:

1. USB cabel 1 and USB cable 2 is identical, difference models are for color distinguished. Therefore, only USB cable 1 is as a representative for final test.
2. LCD Panel 1 and LCD Panel 2 is identical, difference models are for color distinguished. Therefore, only LCD Panel 2 is as a representative for final test.



2.2 DESCRIPTION OF TEST MODES

FOR 5150 ~ 5250MHz

4 channels are provided for 802.11a, 802.11n (20MHz):

CHANNEL	FREQUENCY	CHANNEL	FREQUENCY
36	5180 MHz	44	5220 MHz
40	5200 MHz	48	5240 MHz

2 channels are provided for 802.11n (40MHz):

CHANNEL	FREQUENCY	CHANNEL	FREQUENCY
38	5190 MHz	46	5230 MHz

1 channel is provided for 802.11ac (80MHz):

CHANNEL	FREQUENCY	CHANNEL	FREQUENCY
42	5210 MHz		

FOR 5250 ~ 5350MHz

4 channels are provided for 802.11a, 802.11n (20MHz):

CHANNEL	FREQUENCY	CHANNEL	FREQUENCY
52	5260 MHz	60	5300 MHz
56	5280 MHz	64	5320 MHz

2 channels are provided for 802.11n (40MHz):

CHANNEL	FREQUENCY	CHANNEL	FREQUENCY
54	5270 MHz	62	5310 MHz

1 channel is provided for 802.11ac (80MHz):

CHANNEL	FREQUENCY	CHANNEL	FREQUENCY
58	5290 MHz		



FOR 5470 ~ 5725MHz

8 channels are provided for 802.11a, 802.11n (20MHz):

CHANNEL	FREQUENCY	CHANNEL	FREQUENCY
100	5500 MHz	116	5580 MHz
104	5520 MHz	132	5660 MHz
108	5540 MHz	136	5680 MHz
112	5560 MHz	140	5700 MHz

3 channels are provided for 802.11n (40MHz):

CHANNEL	FREQUENCY	CHANNEL	FREQUENCY
102	5510 MHz	134	5670 MHz
110	5550 MHz		

1 channel is provided for 802.11ac (80MHz):

CHANNEL	FREQUENCY	CHANNEL	FREQUENCY
106	5530 MHz		

FOR 5725 ~ 5825MHz

5 channels are provided for 802.11a, 802.11n (20MHz):

CHANNEL	FREQUENCY	CHANNEL	FREQUENCY
149	5745 MHz	161	5805 MHz
153	5765 MHz	165	5825 MHz
157	5785 MHz		

2 channels are provided for 802.11n (40MHz):

CHANNEL	FREQUENCY	CHANNEL	FREQUENCY
151	5755 MHz	159	5795 MHz

1 channel is provided for 802.11ac (80MHz):

CHANNEL	FREQUENCY	CHANNEL	FREQUENCY
155	5775 MHz		



2.2.1 TEST MODE APPLICABILITY AND TESTED CHANNEL DETAIL

EUT CONFIGURE MODE	APPLICABLE TO				DESCRIPTION
	RE≥1G	RE<1G	PLC	APCM	
A	√	√	√	-	Powered by Adapter with wifi(5G) link
B	-	-	-	√	Powered by Battery with wifi(5G) link
C	-	-	-	-	Powered by USB with wifi(5G) link

Where **RE≥1G**: Radiated Emission above 1GHz **RE<1G**: Radiated Emission below 1GHz
PLC: Power Line Conducted Emission **APCM**: Antenna Port Conducted Measurement

NOTE:
The EUT had been pre-tested on the positioned of each 3 axis. The worst case was found when positioned on **X-plane**.
NOTE: “-” means no effect.

RADIATED EMISSION TEST (ABOVE 1GHz):

- Pre-Scan has been conducted to determine the worst-case mode from all possible combinations between available modulations, data rates and antenna ports (if EUT with antenna diversity architecture).
- Following channel(s) was (were) selected for the final test as listed below.

EUT CONFIGURE MODE	MODE	FREQ. BAND (MHz)	AVAILABLE CHANNEL	TESTED CHANNEL	MODULATION TECHNOLOGY	MODULATION TYPE	DATA RATE (Mbps)
A	802.11a	5180-5240	36 to 48	36, 40, 48	OFDM	BPSK	6.0
A	802.11n (20MHz)		36 to 48	36, 40, 48	OFDM	BPSK	MCS0
A	802.11n (40MHz)		38 to 46	38, 46	OFDM	BPSK	MCS0
A	802.11ac (80MHz)		42	42	OFDM	BPSK	V0
A	802.11a	5260-5320	52 to 64	52, 60, 64	OFDM	BPSK	6.0
A	802.11n (20MHz)		52 to 64	52, 60, 64	OFDM	BPSK	MCS0
A	802.11n (40MHz)		54 to 62	54, 62	OFDM	BPSK	MCS0
A	802.11ac (80MHz)		58	58	OFDM	BPSK	V0
A	802.11a	5500-5700	100 to 140	100, 116, 140	OFDM	BPSK	6.0
A	802.11n (20MHz)		100 to 140	100, 116, 140	OFDM	BPSK	MCS0
A	802.11n (40MHz)		102 to 134	102, 110, 134	OFDM	BPSK	MCS0
A	802.11ac (80MHz)		106	106	OFDM	BPSK	V0
A	802.11a	5725-5825	149 to 165	149, 157, 165	OFDM	BPSK	6.0
A	802.11n (20MHz)		149 to 165	149, 157, 165	OFDM	BPSK	MCS0
A	802.11n (40MHz)		151 to 159	151, 159	OFDM	BPSK	MCS0
A	802.11ac (80MHz)		155	155	OFDM	BPSK	V0



RADIATED EMISSION TEST (BELOW 1GHz):

- Pre-Scan has been conducted to determine the worst-case mode from all possible combinations between available modulations, data rates and antenna ports (if EUT with antenna diversity architecture).
- Following channel(s) was (were) selected for the final test as listed below.

EUT CONFIGURE MODE	MODE	FREQ. BAND (MHz)	AVAILABLE CHANNEL	TESTED CHANNEL	MODULATION TECHNOLOGY	MODULATION TYPE	DATA RATE (Mbps)
A	802.11n (20MHz)	5725-5825	149 to 165	157	OFDM	BPSK	MCS0

POWER LINE CONDUCTED EMISSION TEST:

- Pre-Scan has been conducted to determine the worst-case mode from all possible combinations between available modulations, data rates and antenna ports (if EUT with antenna diversity architecture).
- Following channel(s) was (were) selected for the final test as listed below.

EUT CONFIGURE MODE	MODE	FREQ. BAND (MHz)	AVAILABLE CHANNEL	TESTED CHANNEL	MODULATION TECHNOLOGY	MODULATION TYPE	DATA RATE (Mbps)
A	802.11n (20MHz)	5725-5825	149 to 165	157	OFDM	BPSK	MCS0

BANDEDGE MEASUREMENT:

- Pre-Scan has been conducted to determine the worst-case mode from all possible combinations between available modulations, data rates and antenna ports (if EUT with antenna diversity architecture).
- Following channel(s) was (were) selected for the final test as listed below.

EUT CONFIGURE MODE	MODE	FREQ. BAND (MHz)	AVAILABLE CHANNEL	TESTED CHANNEL	MODULATION TECHNOLOGY	MODULATION TYPE	DATA RATE (Mbps)
A	802.11a	5180-5240	36 to 48	36, 48	OFDM	BPSK	6.0
A	802.11n (20MHz)		36 to 48	36, 48	OFDM	BPSK	MCS0
A	802.11n (40MHz)		38 to 46	38, 46	OFDM	BPSK	MCS0
A	802.11ac (80MHz)		42	42	OFDM	BPSK	V0
A	802.11a	5260-5320	52 to 64	52, 64	OFDM	BPSK	6.0
A	802.11n (20MHz)		52 to 64	52, 64	OFDM	BPSK	MCS0
A	802.11n (40MHz)		54 to 62	54, 62	OFDM	BPSK	MCS0
A	802.11ac (80MHz)		58	58	OFDM	BPSK	V0
A	802.11a	5500-5700	100 to 140	100, 140	OFDM	BPSK	6.0
A	802.11n (20MHz)		100 to 140	100, 140	OFDM	BPSK	MCS0
A	802.11n (40MHz)		102 to 134	102, 134	OFDM	BPSK	MCS0
A	802.11ac (80MHz)		106	106	OFDM	BPSK	V0
A	802.11a	5725-5825	149 to 165	149, 165	OFDM	BPSK	6.0
A	802.11n (20MHz)		149 to 165	149, 165	OFDM	BPSK	MCS0
A	802.11n (40MHz)		151 to 159	151, 159	OFDM	BPSK	MCS0
A	802.11ac (80MHz)		155	155	OFDM	BPSK	V0



ANTENNA PORT CONDUCTED MEASUREMENT:

- This item includes all test value of each mode, but only includes spectrum plot of worst value of each mode.
- Pre-Scan has been conducted to determine the worst-case mode from all possible combinations between available modulations, data rates and antenna ports (if EUT with antenna diversity architecture).
- Following channel(s) was (were) selected for the final test as listed below.

EUT CONFIGURE MODE	MODE	FREQ. BAND (MHz)	AVAILABLE CHANNEL	TESTED CHANNEL	MODULATION TECHNOLOGY	MODULATION TYPE	DATA RATE (Mbps)
B	802.11a	5180-5240	36 to 48	36, 40, 48	OFDM	BPSK	6.0
B	802.11n (20MHz)		36 to 48	36, 40, 48	OFDM	BPSK	MCS0
B	802.11n (40MHz)		38 to 46	38, 46	OFDM	BPSK	MCS0
B	802.11ac (80MHz)		42	42	OFDM	BPSK	V0
B	802.11a	5260-5320	52 to 64	52, 60, 64	OFDM	BPSK	6.0
B	802.11n (20MHz)		52 to 64	52, 60, 64	OFDM	BPSK	MCS0
B	802.11n (40MHz)		54 to 62	54, 62	OFDM	BPSK	MCS0
B	802.11ac (80MHz)		58	58	OFDM	BPSK	V0
B	802.11a	5500-5700	100 to 140	100, 116, 140	OFDM	BPSK	6.0
B	802.11n (20MHz)		100 to 140	100, 116, 140	OFDM	BPSK	MCS0
B	802.11n (40MHz)		102 to 134	102, 110, 134	OFDM	BPSK	MCS0
B	802.11ac (80MHz)		106	106	OFDM	BPSK	V0
B	802.11a	5725-5825	149 to 165	149, 165	OFDM	BPSK	6.0
B	802.11n (20MHz)		149 to 165	149, 165	OFDM	BPSK	MCS0
B	802.11n (40MHz)		151 to 159	151, 159	OFDM	BPSK	MCS0
B	802.11ac (80MHz)		155	155	OFDM	BPSK	V0

TEST CONDITION:

TB-X605F

APPLICABLE TO	ENVIRONMENTAL CONDITIONS	INPUT POWER	TESTED BY
RE<1G	23deg. C, 62%RH	DC 5V By Adapter	Rose Ma
RE≥1G	23deg. C, 62%RH	DC 5V By Adapter	Rose Ma
PLC	24deg. C, 61%RH	DC 5V By Adapter	John Wen
APCM	23.5deg. C, 60%RH	DC 3.85V from battery	Rain Wang

HA200

APPLICABLE TO	Environmental conditions	TEST VOLTAGE (SYSTEM)	Tested by
RE<1G	22deg. C, 54%RH	DC 12V	Vincent
RE≥1G	22deg. C, 54%RH	DC 12V	Vincent
PLC	24deg. C, 55%RH	DC 12V	John Wen
APCM	25deg. C, 60%RH	DC 12V	Bert Ma



2.3 DUTY CYCLE OF TEST SIGNAL

Duty cycle of test signal is < 98%, duty factor shall be considered.

The test results was recorded in Reports No.: RF180626C04-2.

2.4 DESCRIPTION OF SUPPORT UNITS

The EUT has been tested as an independent unit together with other necessary accessories or support units. The following support units or accessories were used to form a representative test configuration during the tests.

NO.	PRODUCT	BRAND	MODEL NO.	SERIAL NO.	FCC ID
1	PC	HP	A6608CN	3CR83825X3	N/A

NO.	SIGNAL CABLE DESCRIPTION OF THE ABOVE SUPPORT UNITS
1	AC Line: Unshielded, Detachable 1.5m

NOTE:

1. All power cords of the above support units are non shielded (1.8m).

2.4.1 CONFIGURATION OF SYSTEM UNDER TEST

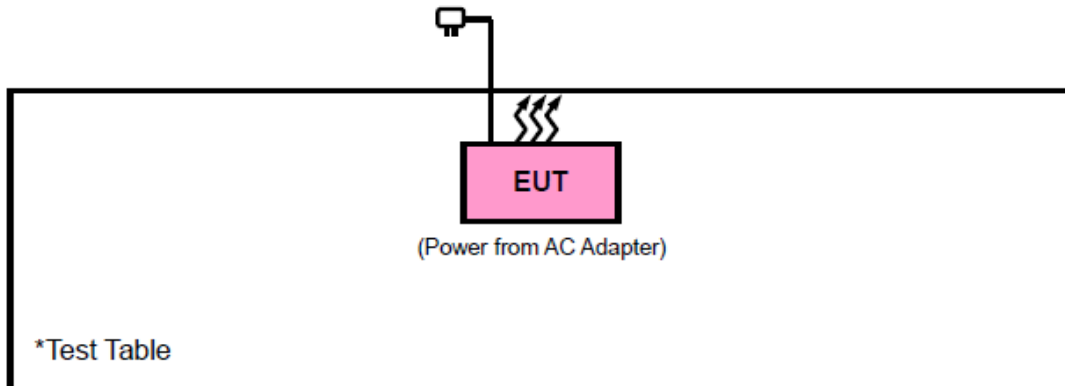



2.5 GENERAL DESCRIPTION OF APPLIED STANDARDS

The EUT is a RF Product. According to the specifications of the manufacturer, it must comply with the requirements of the following standards:

FCC Part 15, Subpart E (15.407)

KDB 789033 D02 General U-NII Test Procedures New Rules v02r01

ANSI C63.10-2013

All test items have been performed and recorded as per the above standards.

NOTE: The EUT is also considered as a kind of computer peripheral, because the connection to computer is necessary for typical use. It has been verified to comply with the requirements of FCC Part 15, Subpart B, Class B (Certification). The test report has been issued separately.



3 TEST TYPES AND RESULTS

3.1 RADIATED EMISSION AND BANDEDGE MEASUREMENT

3.1.1 LIMITS OF RADIATED EMISSION AND BANDEDGE MEASUREMENT

Radiated emissions which fall in the restricted bands must comply with the radiated emission limits specified as below table:

FREQUENCIES (MHz)	FIELD STRENGTH (microvolts/meter)	MEASUREMENT DISTANCE (meters)
0.009 ~ 0.490	2400/F(kHz)	300
0.490 ~ 1.705	24000/F(kHz)	30
1.705 ~ 30.0	30	30
30 ~ 88	100	3
88 ~ 216	150	3
216 ~ 960	200	3
Above 960	500	3

NOTE:

1. The lower limit shall apply at the transition frequencies.
2. Emission level (dBuV/m) = 20 log Emission level (uV/m).
3. For frequencies above 1000MHz, the field strength limits are based on average detector, however, the peak field strength of any emission shall not exceed the maximum permitted average limits, specified above by more than 20dB under any condition of modulation.



3.1.2 LIMITS OF UNWANTED EMISSION

RESTRICTED BANDS	APPLICABLE TO	LIMIT	
	789033 D02 General UNII Test Procedures New Rules v01r04	FIELD STRENGTH AT 3m (dBµV/m)	
		PK : 74	AV : 54
OUT OF THE RESTRICTED BANDS	APPLICABLE TO	EIRP LIMIT (dBm/MHz)	EQUIVALENT FIELD STRENGTH AT 3m (dBµV/m)
	15.407(b)(1)	PK : -27	PK : 68.3
	15.407(b)(2)		
	15.407(b)(3)		
15.407(b)(4)	See note 2 (FCC 16-24)		

NOTE: The following formula is used to convert the equipment isotropic radiated power (eirp) to field strength:

$$E = \frac{1000000\sqrt{30P}}{3} \mu\text{V/m, where P is the eirp (Watts).}$$

2. All emissions shall be limited to a level of -27 dBm/MHz at 75 MHz or more above or below the band edge increasing linearly to 10 dBm/MHz at 25 MHz above or below the band edge, and from 25 MHz above or below the band edge increasing linearly to a level of 15.6 dBm/MHz at 5 MHz above or below the band edge, and from 5 MHz above or below the band edge increasing linearly to a level of 27 dBm/MHz at the band edge.



3.1.3 TEST INSTRUMENTS

Equipment	Manufacturer	Model No.	Serial No.	Last Cal.	Next Cal.
3m Semi-anechoic Chamber	ETS-LINDGREN	9m*6m*6m	Euroshieldpn-CT0001143-1216	Apr. 21,18	Apr. 20,19
Bilog Antenna	ETS-LINDGREN	3143B	00161965	Nov. 26,16	Nov. 25,18
Horn Antenna	ETS-LINDGREN	3117	00168728	Nov. 26,16	Nov. 25,18
Loop antenna	Daze	ZN30900A	0708	Nov. 20,17	Nov. 19,18
Horn Antenna (18GHz-40GHz)	N/A	QWH-SL-18-40-K-SG/QMS-00361	15433	Dec. 16,16	Dec. 15,18
Test Software	E3	V 9.160323	N/A	N/A	N/A
Test Software	ADT	ADT_Radiated_V7.6.15.9.2	N/A	N/A	N/A
10dB Attenuator	JFW/USA	50HF-010-SMA	1505	Jul. 09,18	Jul. 08,19
MXE EMI Receiver	KEYSIGHT	N9038A-544	MY54450026	Mar. 16,18	Mar. 15,19
Signal Pre-Amplifier	EMSI	EMC 9135	980249	Jul. 09,18	Jul. 08,19
Signal Pre-Amplifier	EMSI	EMC 012645B	980257	Jul. 09,18	Jul. 08,19
Signal Pre-Amplifier	EMSI	EMC 184045B	980259	Jul. 09,18	Jul. 08,19

NOTE:

1. The calibration interval of the above test instruments is 12 months and the calibrations are traceable to CEPREI/CHINA, GRGT/CHINA and NIM/CHINA.
2. The test was performed in 3m Chamber.
3. The FCC Site Registration No. is 525120.



3.1.4 TEST PROCEDURES

- a. The EUT was placed on the top of a rotating table 0.8 meters (for below 1GHz) / 1.5 meters (for above 1GHz) above the ground at 3 meter chamber room for test. The table was rotated 360 degrees to determine the position of the highest radiation.
- b. The EUT was set 3 meters away from the interference-receiving antenna, which was mounted on the top of a variable-height antenna tower.
- c. The antenna is a broadband antenna, and its height is varied from one meter to four meters above the ground to determine the maximum value of the field strength. Both horizontal and vertical polarizations of the antenna are set to make the measurement.
- d. For each suspected emission, the EUT was arranged to its worst case and then the antenna was tuned to heights from 1 meter to 4 meters and the rotatable table was turned from 0 degrees to 360 degrees to find the maximum reading.
- e. The test-receiver system was set to Peak Detect Function and Specified Bandwidth with Maximum Hold Mode.
- f. If the emission level of the EUT in peak mode was 10dB lower than the limit specified, then testing could be stopped and the peak values of the EUT would be reported. Otherwise the emissions that did not have 10dB margin would be re-tested one by one using peak, quasi-peak or average method as specified and then reported in a data sheet.

NOTE:

1. The resolution bandwidth and video bandwidth of test receiver/spectrum analyzer is 120kHz for Peak detection (PK) and Quasi-peak detection (QP) at frequency below 1GHz.
2. The resolution bandwidth of test receiver/spectrum analyzer is 1MHz and video bandwidth is 3MHz for Peak detection at frequency above 1GHz.
3. The resolution bandwidth of test receiver/spectrum analyzer is 1MHz and the video bandwidth is 10Hz for Average detection (AV) at frequency above 1GHz.
4. All modes of operation were investigated and the worst-case emissions are reported.

3.1.5 DEVIATION FROM TEST STANDARD

No deviation.



3.1.6 TEST SETUP

< Frequency Range below 30MHz >

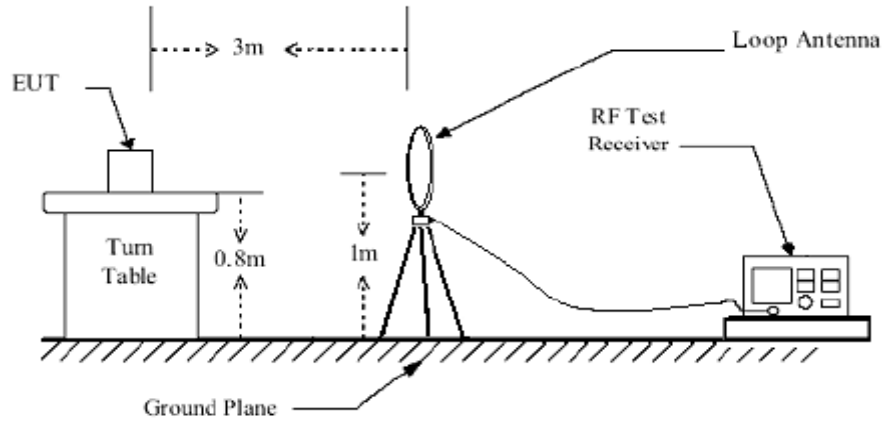

< Frequency Range 30MHz~1GHz >

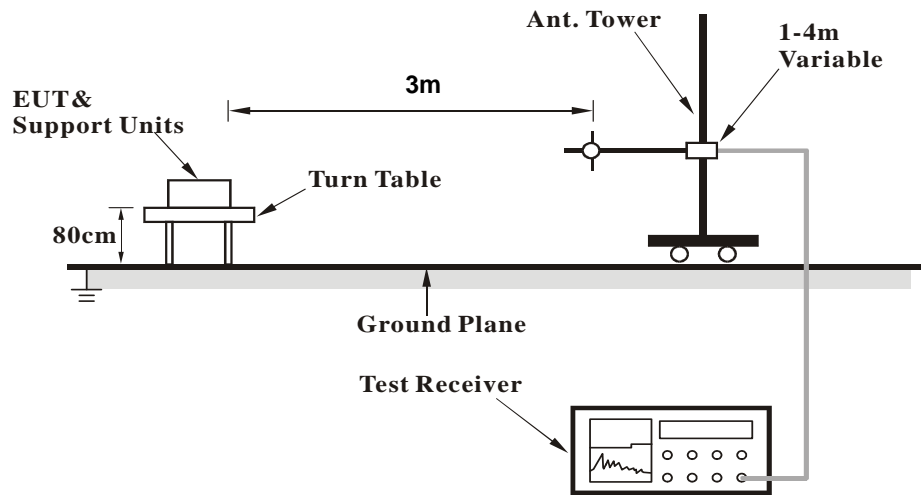



<Frequency Range above 1GHz>

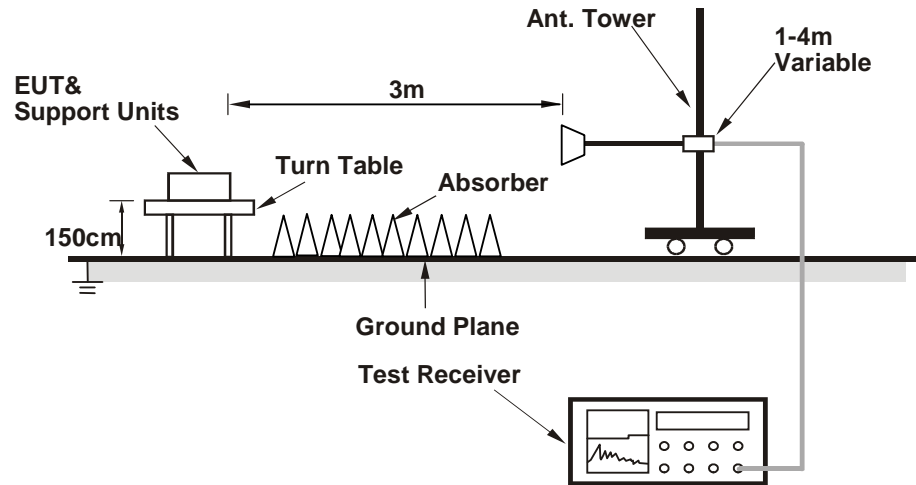

For the actual test configuration, please refer to the attached file (Test Setup Photo).

3.1.7 EUT OPERATING CONDITION

- Set the EUT under full load condition and placed them on a testing table.
- Set the transmitter part of EUT under transmission condition continuously at specific channel frequency.
- The necessary accessories enable the EUT in full functions.



3.1.8 TEST RESULTS

BELOW 1GHz WORST-CASE DATA:

9 KHz – 30 MHz data: the amplitude of spurious emissions attenuated more than 20 dB below the permissible value is not required in the report.

30 MHz – 1GHz data:

802.11n (20MHz)

CHANNEL	TX Channel 157	DETECTOR FUNCTION	Quasi-Peak (QP)
FREQUENCY RANGE	30MHz ~ 1GHz		

ANTENNA POLARITY & TEST DISTANCE: HORIZONTAL AT 3 M										
FREQ. (MHz)	EMISSION LEVEL (dBuV/m)	READ LEVEL (dBuV)	LIMIT (dBuV/m)	MARGIN (dB)	ANTENNA FACTOR (dB /m)	CABLE LOSS (dB)	PREAMP FACTOR (dB)	ANTENNA HEIGHT (cm)	TABLE ANGLE (Degree)	REMARK
72.93	22.31	50.62	40	-17.69	7.72	1.2	37.23	100	0	QP
134.55	28.1	54.76	43.5	-15.4	8.69	1.52	36.87	100	56	QP
210.58	27.58	51.24	43.5	-15.92	11.04	1.84	36.54	100	176	QP
300.45	29.65	50.13	46	-16.35	13.81	2.21	36.5	100	178	QP
402.39	27.64	44.62	46	-18.36	17.12	2.63	36.73	100	156	QP
630	33.65	46.85	46	-12.35	20.81	3.27	37.28	100	0	QP

REMARKS:

1. Emission level (dBuV/m) = Raw Value (dBuV) + Correction Factor (dB/m).
2. Correction Factor (dB/m) = Antenna Factor (dB/m) + Cable Factor (dB).
3. The other emission levels were very low against the limit.
4. Margin value = Emission level – Limit value.

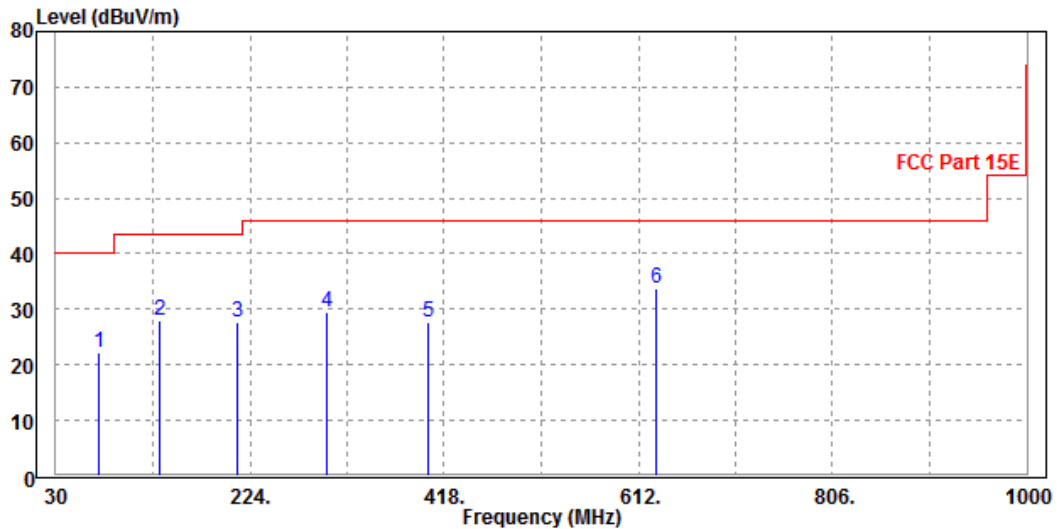



CHANNEL	Channel 157	DETECTOR FUNCTION	Quasi-Peak (QP)
FREQUENCY RANGE	30MHz ~ 1GHz		

ANTENNA POLARITY & TEST DISTANCE: VERTICAL AT 3 M										
FREQ. (MHz)	EMISSION LEVEL (dBuV/m)	READ LEVEL (dBuV)	LIMIT (dBuV/m)	MARGIN (dB)	ANTENNA FACTOR (dB /m)	CABLE LOSS (dB)	PREAMP FACTOR (dB)	ANTENNA HEIGHT (cm)	TABLE ANGLE (Degree)	REMARK
80.52	29.76	57.68	40	-10.24	8.02	1.2	37.14	100	360	QP
184.73	22.07	46.78	43.5	-21.43	10.22	1.72	36.65	145	152	QP
212.34	19.99	43.56	43.5	-23.51	11.12	1.85	36.54	156	289	QP
430.22	30.14	46.83	46	-15.86	17.37	2.73	36.79	150	300	QP
601.54	40.35	54.39	46	-5.65	20.04	3.17	37.25	108	110	QP
789.33	41.42	52.19	46	-4.58	22.97	3.85	37.59	100	80	QP

REMARKS:

1. Emission level (dBuV/m) = Raw Value (dBuV) + Correction Factor (dB/m).
2. Correction Factor (dB/m) = Antenna Factor (dB/m) + Cable Factor (dB).
3. The other emission levels were very low against the limit.
4. Margin value = Emission level – Limit value.

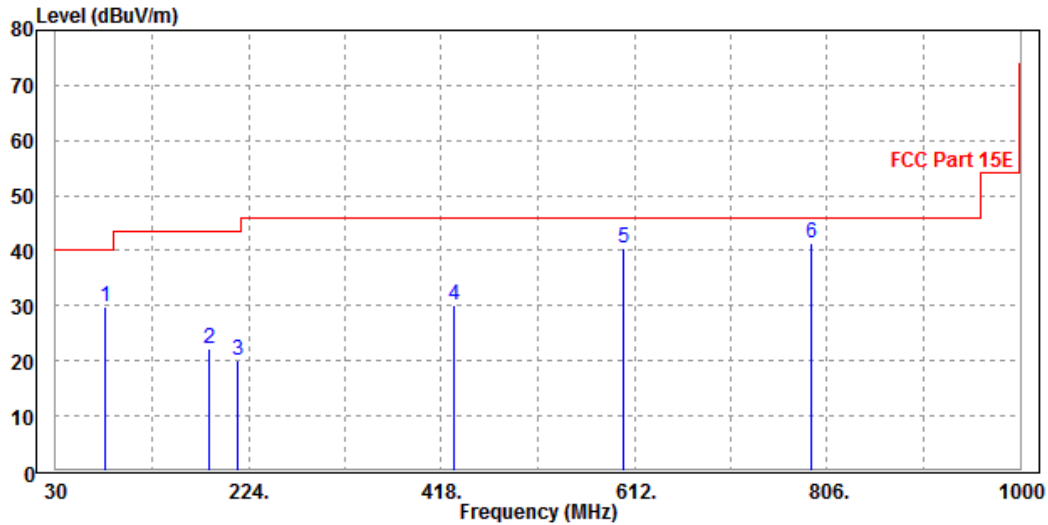



ABOVE 1GHz WORST-CASE DATA:

Note: For higher frequency, the emission is too low to be detected.

Band 4

CHANNEL	TX Channel 157	DETECTOR FUNCTION	Peak (PK)
FREQUENCY RANGE	1GHz ~ 40GHz		Average (AV)

ANTENNA POLARITY & TEST DISTANCE: HORIZONTAL AT 3 M										
FREQ. (MHz)	EMISSION LEVEL (dBuV/m)	READ LEVEL (dBuV)	LIMIT (dBuV/m)	MARGIN (dB)	ANTENNA FACTOR (dB /m)	CABLE LOSS (dB)	PREAMP FACTOR (dB)	ANTENNA HEIGHT (cm)	TABLE ANGLE (Degree)	REMARK
5785	99.33	100.14			37.57	7.79	46.17	100	250	Average
5785	107.6	108.41			37.57	7.79	46.17	100	250	Peak
ANTENNA POLARITY & TEST DISTANCE: VERTICAL AT 3 M										
FREQ. (MHz)	EMISSION LEVEL (dBuV/m)	READ LEVEL (dBuV)	LIMIT (dBuV/m)	MARGIN (dB)	ANTENNA FACTOR (dB /m)	CABLE LOSS (dB)	PREAMP FACTOR (dB)	ANTENNA HEIGHT (cm)	TABLE ANGLE (Degree)	REMARK
5785	91.45	92.26			37.57	7.79	46.17	100	250	Average
5785	100.88	101.69			37.57	7.79	46.17	100	250	Peak

REMARKS:

1. Emission Level = Read Level+ Antenna Factor + Cable Loss- Preamp Factor
Margin value = Emission level – Limit value.
2. 5785MHz: Fundamental frequency.



OOBE DATA

802.11a

ANTENNA POLARITY & TEST DISTANCE: HORIZONTAL AT 3 M										
FREQ. (MHz)	EMISSION LEVEL (dBuV/m)	READ LEVEL (dBuV)	LIMIT (dBuV/m)	MARGIN (dB)	ANTENNA FACTOR (dB /m)	CABLE LOSS (dB)	PREAMP FACTOR (dB)	ANTENNA HEIGHT (cm)	TABLE ANGLE (Degree)	REMARK
5634.08	58.78	59.87	68.3	-9.52	37.48	7.64	46.21	100	0	Peak
5940.45	58.65	59.17	68.3	-9.65	37.66	7.95	46.13	100	0	Peak
ANTENNA POLARITY & TEST DISTANCE: VERTICAL AT 3 M										
FREQ. (MHz)	EMISSION LEVEL (dBuV/m)	READ LEVEL (dBuV)	LIMIT (dBuV/m)	MARGIN (dB)	ANTENNA FACTOR (dB /m)	CABLE LOSS (dB)	PREAMP FACTOR (dB)	ANTENNA HEIGHT (cm)	TABLE ANGLE (Degree)	REMARK
5626.48	58.59	59.69	68.3	-9.71	37.48	7.63	46.21	100	360	Peak
5940.45	58.46	58.98	68.3	-9.84	37.66	7.95	46.13	100	360	Peak

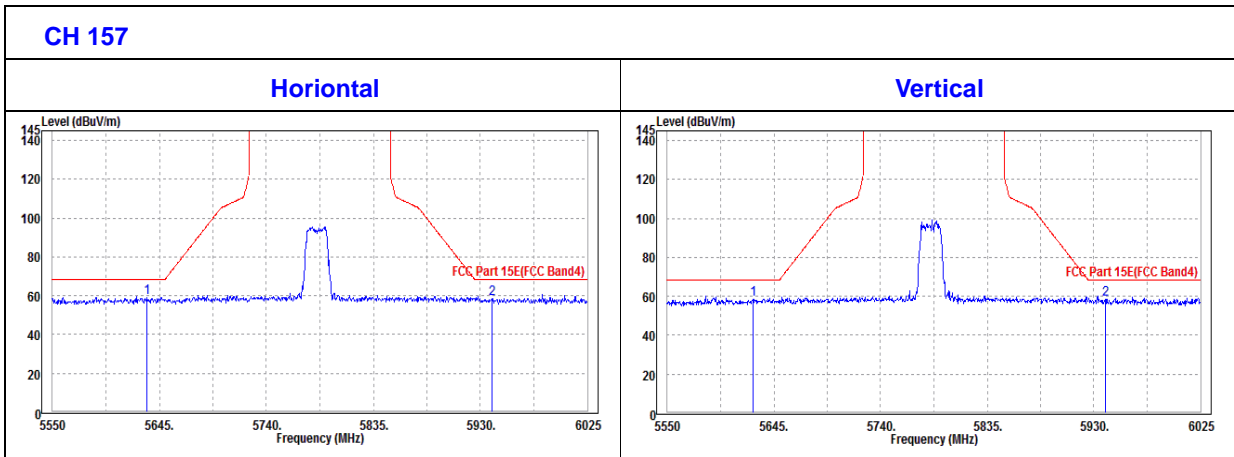

The test results was recorded in Reports No.: RF180626C04-2.



3.2 CONDUCTED EMISSION MEASUREMENT

3.2.1 LIMITS OF CONDUCTED EMISSION MEASUREMENT

FREQUENCY OF EMISSION (MHz)	CONDUCTED LIMIT (dBµV)	
	Quasi-peak	Average
0.15 ~ 0.5	66 to 56	56 to 46
0.5 ~ 5	56	46
5 ~ 30	60	50

- NOTE:**
1. The lower limit shall apply at the transition frequencies.
 2. The limit decreases in line with the logarithm of the frequency in the range of 0.15 to 0.50MHz.
 3. All emanations from a class A/B digital device or system, including any network of conductors and apparatus connected thereto, shall not exceed the level of field strengths specified above.

3.2.2 TEST INSTRUMENTS

Equipment	Manufacturer	Model No.	Serial No.	Last Cal.	Next Cal.
EMI Test Receiver	Rohde&Schwarz	ESR3	101900	Mar. 15,18	Mar. 14,19
EMC32 test software	Rohde&Schwarz	EMC32	NA	NA	NA
LISN network	Rohde&Schwarz	ENV216	101922	Mar. 15,18	Mar. 14,19

- NOTE:**
1. The test was performed in CE shielded room.
 2. The calibration interval of the above test instruments is 12 months. And the calibrations are traceable to CEPREI/CHINA, GRGT/CHINA and NIM/CHINA.

3.2.3 TEST PROCEDURES

- a. The EUT was placed 0.4 meters from the conducting wall of the shielded room with EUT being connected to the power mains through a line impedance stabilization network (LISN). Other support units were connected to the power mains through another LISN. The two LISNs provide 50 ohm/ 50uH of coupling impedance for the measuring instrument.
- b. Both lines of the power mains connected to the EUT were checked for maximum conducted interference.
- c. The frequency range from 150kHz to 30MHz was searched. Emission levels under (Limit - 20dB) was not recorded.

NOTE: All modes of operation were investigated and the worst-case emissions are reported.



3.2.4 DEVIATION FROM TEST STANDARD

No deviation.

3.2.5 TEST SETUP

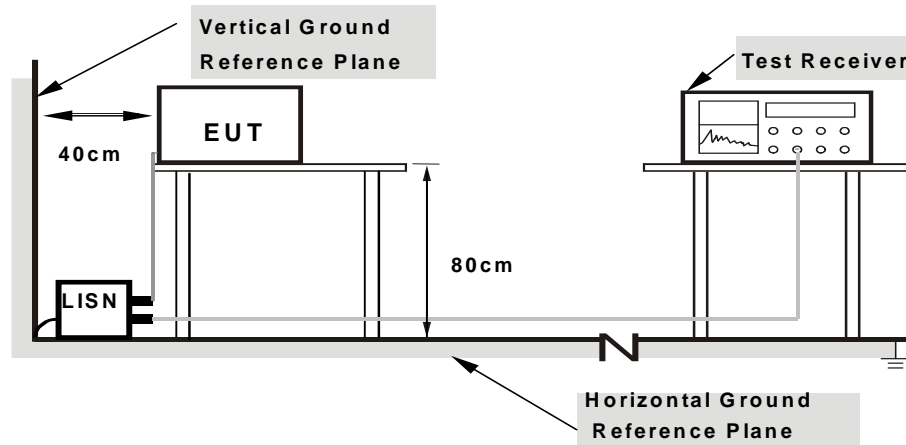

- Note:**
- 1.Support units were connected to second LISN.
 - 2.Both of LISNs (AMN) are 80 cm from EUT and at least 80 from other units and other metal planes

For the actual test configuration, please refer to the attached file (Test Setup Photo).

3.2.6 EUT OPERATING CONDITIONS

Same as 3.1.6.



3.2.7 TEST RESULTS

CONDUCTED WORST-CASE DATA:

TEST VOLTAGE	Input 120 Vac, 60 Hz	Detector Function & Resolution Bandwidth	Quasi-Peak (QP) / Average (AV), 9 kHz
ENVIRONMENTAL CONDITIONS	24deg. C, 43RH	TESTED BY	John Wen

Frequency (MHz)	QuasiPeak (dBuV)	CAverage (dBuV)	Limit (dBuV)	Margin (dB)	Line	Filter	Corr. (dB)
0.158000	---	19.27	55.57	-36.30	L1	ON	9.6
0.158000	36.37	---	65.57	-29.20	L1	ON	9.6
0.356000	---	21.54	48.82	-27.28	L1	ON	9.7
0.356000	31.36	---	58.82	-27.46	L1	ON	9.7
0.428000	---	8.71	47.29	-38.58	L1	ON	9.7
0.428000	17.82	---	57.29	-39.47	L1	ON	9.7
0.740000	---	7.05	46.00	-38.95	L1	ON	9.7
0.740000	14.36	---	56.00	-41.64	L1	ON	9.7
4.952000	---	14.92	46.00	-31.08	L1	ON	9.7
4.952000	20.37	---	56.00	-35.63	L1	ON	9.7
6.412000	---	18.14	50.00	-31.86	L1	ON	9.8
6.412000	23.96	---	60.00	-36.04	L1	ON	9.8

- REMARKS:**
1. Q.P. and AV. are abbreviations of quasi-peak and average individually.
 2. "-": The Quasi-peak reading value also meets average limit and measurement with the average detector is unnecessary.
 3. The emission levels of other frequencies were very low against the limit.
 4. Margin value = Emission level - Limit value
 5. Correction factor = Insertion loss + Cable loss
 6. Emission Level = Correction Factor + Reading Value.

Full Spectrum

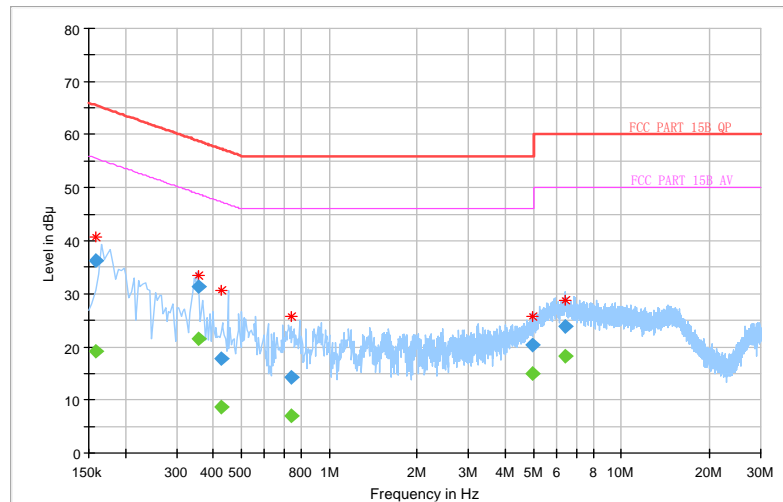



TEST VOLTAGE	Input 120 Vac, 60 Hz	Detector Function & Resolution Bandwidth	Quasi-Peak (QP) / Average (AV), 9 kHz
ENVIRONMENTAL CONDITIONS	24deg. C, 43RH	TESTED BY	John Wen

Frequency (MHz)	QuasiPeak (dBuV)	CAverage (dBuV)	Limit (dBuV)	Margin (dB)	Line	Filter	Corr. (dB)
0.174000	---	12.63	54.77	-42.14	N	ON	10.2
0.174000	29.39	---	64.77	-35.37	N	ON	10.2
0.356000	---	15.62	48.82	-33.20	N	ON	10.0
0.356000	33.23	---	58.82	-25.60	N	ON	10.0
0.464000	---	5.37	46.62	-41.25	N	ON	10.1
0.464000	17.82	---	56.62	-38.80	N	ON	10.1
0.888000	---	12.80	46.00	-33.20	N	ON	9.9
0.888000	19.13	---	56.00	-36.87	N	ON	9.9
1.604000	---	9.99	46.00	-36.01	N	ON	9.9
1.604000	16.96	---	56.00	-39.04	N	ON	9.9
10.384000	---	8.47	50.00	-41.53	N	ON	9.9
10.384000	19.83	---	60.00	-40.17	N	ON	9.9

- REMARKS:**
1. Q.P. and AV. are abbreviations of quasi-peak and average individually.
 2. "-": The Quasi-peak reading value also meets average limit and measurement with the average detector is unnecessary.
 3. The emission levels of other frequencies were very low against the limit.
 4. Margin value = Emission level - Limit value
 5. Correction factor = Insertion loss + Cable loss
 6. Emission Level = Correction Factor + Reading Value.

Full Spectrum

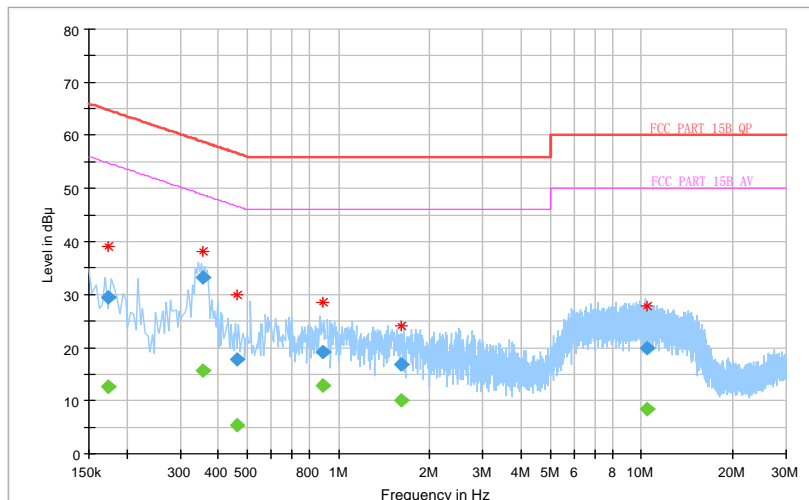



3.3 MAXIMUM CONDUCTED OUTPUT POWER MEASUREMENT

3.3.1 LIMITS OF MAXIMUM CONDUCTED OUTPUT POWER MEASUREMENT

Operation Band	EUT Category		LIMIT
U-NII-1		Outdoor Access Point	1 Watt (30 dBm) (Max. e.i.r.p \leq 125mW(21 dBm) at any elevation angle above 30 degrees as measured from the horizon)
		Fixed point-to-point Access Point	1 Watt (30 dBm)
		Indoor Access Point	1 Watt (30 dBm)
	√	Client devices	250mW (24 dBm)
U-NII-2A	√		250mW (24 dBm) or 11 dBm+10 log B*
U-NII-2C	√		250mW (24 dBm) or 11 dBm+10 log B*
U-NII-3	√		1 Watt (30 dBm)

NOTE: Where B is the 26dB emission bandwidth in MHz.



3.3.2 TEST SETUP

FOR POWER OUTPUT MEASUREMENT

802.11a, 802.11n (20MHz), 802.11n (40MHz) TEST CONFIGURATION

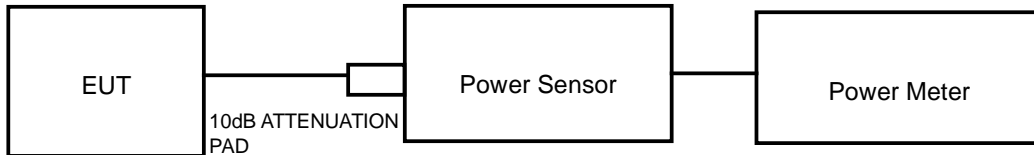

FOR 26dB BANDWIDTH

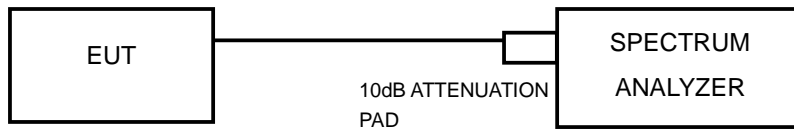

3.3.3 TEST INSTRUMENTS

Equipment	Manufacturer	Model No.	Serial No.	Last Cal.	Next Cal.
Power Meter	ANRITSU	ML2495A	1506002	Mar. 02,18	Mar. 01,19
EXA Signal Analyzer	KEYSIGHT	N9010A-526	MY54510523	Mar. 16,18	Mar. 15,19
EXA Signal Analyzer	KEYSIGHT	N9010A-544	MY54510332	Mar. 16,18	Mar. 15,19
Power Sensor	ANRITSU	MA2411B	1339352	Mar. 16,18	Mar. 15,19

NOTE:

1. The calibration interval of the above test instruments is 12 months and the calibrations are traceable to CEPREI/CHINA, GRGT/CHINA and NIM/CHINA.
2. The test was performed in RF Oven room.



3.3.4 TEST PROCEDURE

FOR POWER MEASUREMENT

For 802.11a, 802.11n (20MHz), 802.11n (40MHz)

Method PM is used to perform output power measurement, trigger and gating function of wide band power meter is enabled to measure max output power of TX on burst. Duty factor is not added to measured value.

FOR 99 PERCENT OCCUPIED BANDWIDTH

The following procedure shall be used for measuring (99 %) power bandwidth:

1. Set center frequency to the nominal EUT channel center frequency.
2. Set span = 1.5 times to 5.0 times the OBW.
3. Set RBW = 1 % to 5 % of the OBW
4. Set VBW $\geq 3 \cdot$ RBW
5. Video averaging is not permitted. Where practical, a sample detection and single sweep mode shall be used. Otherwise, peak detection and max hold mode (until the trace stabilizes) shall be used.
6. Use the 99 % power bandwidth function of the instrument (if available).
7. If the instrument does not have a 99 % power bandwidth function, the trace data points are recovered and directly summed in power units. The recovered amplitude data points, beginning at the lowest frequency, are placed in a running sum until 0.5 % of the total is reached; that frequency is recorded as the lower frequency. The process is repeated until 99.5 % of the total is reached; that frequency is recorded as the upper frequency. The 99% occupied bandwidth is the difference between these two frequencies.

FOR 26dB BANDWIDTH

- 1) Set RBW = approximately 1% of the emission bandwidth.
- 2) Set the VBW > RBW.
- 3) Detector = Peak.
- 4) Trace mode = max hold.
- 5) Measure the maximum width of the emission that is 26 dB down from the peak of the emission. Compare this with the RBW setting of the analyzer. Readjust RBW and repeat measurement as needed until the RBW/EBW ratio is approximately 1%.



FOR 6dB BANDWIDTH

1. Set RBW = 100 kHz.
2. Set the video bandwidth (VBW) ≥ 3 RBW.
3. Detector = Peak.
4. Trace mode = max hold.
5. Sweep = auto couple.
6. Allow the trace to stabilize.
7. Measure the maximum width of the emission that is constrained by the frequencies associated with the two outermost amplitude points (upper and lower frequencies) that are attenuated by 6 dB relative to the maximum level measured in the fundamental emission.

3.3.5 DEVIATION FROM TEST STANDARD

No deviation.

3.3.6 EUT OPERATING CONDITIONS

The software provided by client to enable the EUT under transmission condition continuously at specific channel frequencies individually.

3.3.7 TEST RESULTS

The test results was recorded in Reports No.: RF180626C04-2.



3.4 MAXIMUM POWER SPECTRAL DENSITY MEASUREMENT

3.4.1 LIMITS OF MAXIMUM POWER SPECTRAL DENSITY MEASUREMENT

Operation Band	EUT Category		LIMIT
U-NII-1		Outdoor Access Point	17dBm/ MHz
		Fixed point-to-point Access Point	
		Indoor Access Point	
	√	Client devices	11dBm/ MHz
U-NII-2A	√		11dBm/ MHz
U-NII-2C	√		11dBm/ MHz
U-NII-3	√		30dBm/ 500kHz

3.4.2 TEST SETUP

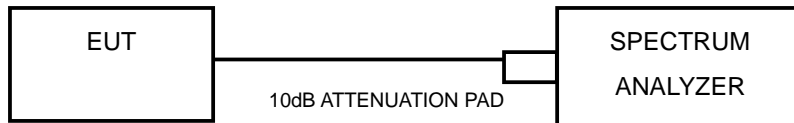

3.4.3 TEST INSTRUMENTS

Refer to section 3.3.3 to get information of above instrument.



3.4.4 TEST PROCEDURES

Using method SA-2

- 1) Set span to encompass the entire emission bandwidth (EBW) of the signal.
- 2) Set RBW = 1 MHz, Set VBW \geq 3 MHz, Detector = RMS
- 3) Set Channel power measure = 1MHz
- 4) Sweep time = auto, trigger set to "free run".
- 5) Trace average at least 100 traces in power averaging mode.
- 6) Add $10 \log (1/x)$, where x is the duty cycle, to the measured power in order to compute the average power during the actual transmission times (because the measurement represents an average over both the on and off times of the transmission).
- 7) Record the max value

3.4.5 DEVIATION FROM TEST STANDARD

No deviation.

3.4.6 EUT OPERATING CONDITIONS

Same as 3.1.6.

3.4.7 TEST RESULTS

The test results was recorded in Reports No.: RF180626C04-2.



3.5 FREQUENCY STABILITY

3.5.1 LIMITS OF FREQUENCY STABILITY MEASUREMENT

The frequency of the carrier signal shall be maintained within band of operation

3.5.2 TEST SETUP

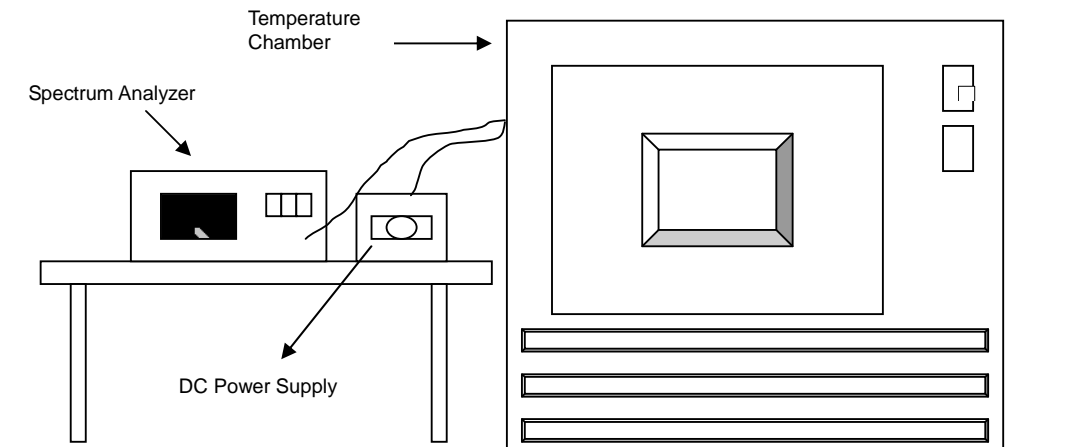

3.5.3 TEST INSTRUMENTS

Refer to section 3.3.3 to get information of above instrument.



3.5.4 TEST PROCEDURE

- a. The EUT was placed inside the environmental test chamber and powered by nominal DC voltage.
- b. Turn the EUT on and couple its output to a spectrum analyzer.
- c. Turn the EUT off and set the chamber to the highest temperature specified.
- d. Allow sufficient time (approximately 30 min) for the temperature of the chamber to stabilize, turn the EUT on and measure the operating frequency after 2, 5, and 10 minutes.
- e. Repeat step 2 and 3 with the temperature chamber set to the lowest temperature.
- f. The test chamber was allowed to stabilize at +20 degree C for a minimum of 30 minutes. The supply voltage was then adjusted on the EUT from 85% to 115% and the frequency record.

3.5.5 DEVIATION FROM TEST STANDARD

No deviation.

3.5.6 EUT OPERATING CONDITION

Set the EUT transmit at un-modulation mode to test frequency stability.

3.5.7 TEST RESULTS

The test results was recorded in Reports No.: RF180626C04-2.



**BUREAU
VERITAS**

Test Report No.: RF181022W002-3

4 PHOTOGRAPHS OF THE TEST CONFIGURATION

Please refer to the attached file (Test Setup Photo).



**BUREAU
VERITAS**

Test Report No.: RF181022W002-3

5 APPENDIX A – MODIFICATIONS RECORDERS FOR ENGINEERING CHANGES TO THE EUT BY THE LAB

No modifications were made to the EUT by the lab during the test.

---END---