

## FCC Test Report

**Report No.:** RF180626C04-4

**FCC ID:** O57TBX605F

**Test Model:** Lenovo TB-X605F

**Received Date:** Jun. 26, 2018

**Test Date:** Jul. 17, 2018 ~ Jul. 27, 2018

**Issued Date:** Aug. 01, 2018

**Applicant:** Lenovo(Shanghai) Electronics Technology Co., Ltd.

**Address:** NO.68 BUILDING, 199 FENJU RD, China (Shanghai) Pilot Free Trade Zone, 200131, CHINA

**Manufacturer:** Lenovo PC HK Limited

**Address:** 23/F, Lincoln House, Taikoo Place 979 King's Road, Quarry Bay, Hong Kong

**Issued By:** Bureau Veritas Consumer Products Services (H.K.) Ltd., Taoyuan Branch

**Lab Address:** No. 47-2, 14th Ling, Chia Pau Vil., Lin Kou Dist., New Taipei City, Taiwan ( R.O.C )

**Test Location:** No.19, Hwa Ya 2nd Rd., Wen Hwa Vil., Kwei Shan Dist., Taoyuan City 33383, Taiwan, R.O.C.

**FCC Registration /  
Designation Number:** 788550 / TW0003



This report is for your exclusive use. Any copying or replication of this report to or for any other person or entity, or use of our name or trademark, is permitted only with our prior written permission. This report sets forth our findings solely with respect to the test samples identified herein. The results set forth in this report are not indicative or representative of the quality or characteristics of the lot from which a test sample was taken or any similar or identical product unless specifically and expressly noted. Our report includes all of the tests requested by you and the results thereof based upon the information that you provided to us. You have 60 days from date of issuance of this report to notify us of any material error or omission caused by our negligence, provided, however, that such notice shall be in writing and shall specifically address the issue you wish to raise. A failure to raise such issue within the prescribed time shall constitute your unqualified acceptance of the completeness of this report, the tests conducted and the correctness of the report contents. Unless specifically mentioned, the uncertainty of measurement has been explicitly taken into account to declare the compliance or non-compliance to the specification. The report must not be used by the client to claim product certification, approval, or endorsement by TAF or any government agencies.

## Table of Contents

<b>Release Control Record .....</b>	<b>4</b>
<b>1 Certificate of Conformity .....</b>	<b>5</b>
<b>2 Summary of Test Results .....</b>	<b>6</b>
2.1 Measurement Uncertainty .....	6
2.2 Modification Record.....	6
<b>3 General Information .....</b>	<b>7</b>
3.1 General Description of EUT .....	7
3.2 Description of Test Modes .....	10
3.2.1 Test Mode Applicability and Tested Channel Detail .....	12
3.3 Duty Cycle of Test Signal .....	14
3.4 Description of Support Units.....	15
3.4.1 Configuration of System under Test.....	15
3.5 General Description of Applied Standards .....	15
<b>4 Test Types and Results .....</b>	<b>16</b>
4.1 Radiated Emission and Bandedge Measurement .....	16
4.1.1 Limits of Radiated Emission and Bandedge Measurement .....	16
4.1.2 Limits of Unwanted Emission Out of the Restricted Bands .....	17
4.1.3 Test Instruments .....	18
4.1.4 Test Procedures.....	20
4.1.5 Deviation from Test Standard.....	21
4.1.6 Test Setup .....	21
4.1.7 EUT Operating Conditions .....	22
4.1.8 Test Results .....	23
4.2 Conducted Emission Measurement .....	67
4.2.1 Limits of Conducted Emission Measurement .....	67
4.2.2 Test Instruments .....	67
4.2.3 Test Procedures.....	68
4.2.4 Deviation from Test Standard.....	68
4.2.5 Test Setup .....	68
4.2.6 EUT Operating Conditions .....	68
4.2.7 Test Results .....	69
4.3 Transmit Power Measurement .....	73
4.3.1 Limits of Transmit Power Measurement .....	73
4.3.2 Test Setup .....	73
4.3.3 Test Instruments .....	74
4.3.4 Test Procedure .....	74
4.3.5 Deviation from Test Standard.....	74
4.3.6 EUT Operating Conditions .....	74
4.3.7 Test Results .....	75
4.4 Occupied Bandwidth Measurement .....	81
4.4.1 Test Setup .....	81
4.4.2 Test Instruments .....	81
4.4.3 Test Procedure .....	81
4.4.4 Test Results .....	82
4.5 Peak Power Spectral Density Measurement.....	85
4.5.1 Limits of Peak Power Spectral Density Measurement .....	85
4.5.2 Test Setup .....	85
4.5.3 Test Instruments .....	85
4.5.4 Test Procedures.....	85
4.5.5 Deviation from Test Standard.....	86
4.5.6 EUT Operating Conditions .....	86
4.5.7 Test Results .....	87
4.6 Frequency Stability .....	92

4.6.1	Limit of Frequency Stability Measurement .....	92
4.6.2	Test Setup .....	92
4.6.3	Test Instruments .....	92
4.6.4	Test Procedure .....	92
4.6.5	Deviation from Test Standard .....	92
4.6.6	EUT Operating Condition .....	92
4.6.7	Test Results .....	93
4.7	6 dB Bandwidth Measurement .....	94
4.7.1	Limits of 6 dB Bandwidth Measurement.....	94
4.7.2	Test Setup .....	94
4.7.3	Test Instruments .....	94
4.7.4	Test Procedure .....	94
4.7.5	Deviation from Test Standard.....	94
4.7.6	EUT Operating Condition .....	94
4.7.7	Test Results .....	95
<b>5</b>	<b>Pictures of Test Arrangements .....</b>	<b>97</b>
	<b>Annex A- Radiated Out of Band Emisison (OOBE) Measurement (For U-NII-3 band) .....</b>	<b>98</b>
	<b>Appendix – Information on the Testing Laboratories .....</b>	<b>101</b>

### Release Control Record

Issue No.	Description	Date Issued
RF180626C04-4	Original Release	Aug. 01, 2018

## 1 Certificate of Conformity

**Product:** Portable Tablet Computer

**Brand:** Lenovo

**Test Model:** Lenovo TB-X605F

**Sample Status:** Production Unit

**Applicant:** Lenovo(Shanghai) Electronics Technology Co., Ltd.

**Test Date:** Jul. 17, 2018 ~ Jul. 27, 2018

**Standards:** 47 CFR FCC Part 15, Subpart E (Section 15.407)  
ANSI C63.10:2013

The above equipment has been tested by **Bureau Veritas Consumer Products Services (H.K.) Ltd., Taoyuan Branch**, and found compliance with the requirement of the above standards. The test record, data evaluation & Equipment Under Test (EUT) configurations represented herein are true and accurate accounts of the measurements of the sample's RF characteristics under the conditions specified in this report.

**Prepared by :**

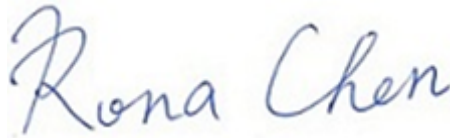

**Date:**

Aug. 01, 2018

Rona Chen / Specialist

**Approved by :**

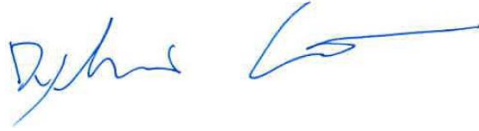

**Date:**

Aug. 01, 2018

Dylan Chiou / Project Engineer

## 2 Summary of Test Results

47 CFR FCC Part 15, Subpart E (Section 15.407)			
FCC Clause	Test Item	Result	Remarks
15.407(b)(6)	AC Power Conducted Emissions	Pass	Meet the requirement of limit. Minimum passing margin is -14.51 dB at 0.17925 MHz.
15.407(b)(1/2/3/4(iii)/6)	Radiated Emissions & Band Edge Measurement	Pass	Meet the requirement of limit. Minimum passing margin is -3.2 dB at 11570.00 MHz.
15.407(a)(1/2/3)	Max Average Transmit Power	Pass	Meet the requirement of limit.
---	Occupied Bandwidth Measurement	-	Reference only
15.407(a)(1/2/3)	Peak Power Spectral Density	Pass	Meet the requirement of limit.
15.407(e)	6 dB Bandwidth	Pass	Meet the requirement of limit. (U-NII-3 Band only)
15.407(g)	Frequency Stability	Pass	Meet the requirement of limit.
15.203	Antenna Requirement	Pass	No antenna connector is used.

\*For U-NII-3 band compliance with rule part 15.407(b)(4)(i), the OOB test plots were recorded in Annex A.

### 2.1 Measurement Uncertainty

Where relevant, the following measurement uncertainty levels have been estimated for tests performed on the EUT as specified in CISPR 16-4-2:

Measurement	Frequency	Expanded Uncertainty (k=2) (±)
Conducted Emissions at mains ports	150 kHz ~ 30 MHz	2.44 dB
Radiated Emissions up to 1 GHz	30 MHz ~ 200 MHz	3.86 dB
	200 MHz ~ 1000 MHz	3.87 dB
Radiated Emissions above 1 GHz	1 GHz ~ 18 GHz	2.29 dB
	18 GHz ~ 40 GHz	2.29 dB

### 2.2 Modification Record

There were no modifications required for compliance.

### 3 General Information

#### 3.1 General Description of EUT

<b>Product</b>	Portable Tablet Computer
<b>Brand</b>	Lenovo
<b>Test Model</b>	Lenovo TB-X605F
<b>Status of EUT</b>	Production Unit
<b>Power Supply Rating</b>	3.85 Vdc (Battery) 5 Vdc (Adapter or host equipment)
<b>Modulation Type</b>	256QAM, 64QAM, 16QAM, QPSK, BPSK
<b>Modulation Technology</b>	OFDM
<b>Transfer Rate</b>	802.11a: 54.0/ 48.0/ 36.0/ 24.0/ 18.0/ 12.0/ 9.0/ 6.0 Mbps 802.11n: up to 135.0 Mbps 802.11ac: up to 433.3 Mbps
<b>Operating Frequency</b>	5180 ~ 5240 MHz, 5260 ~ 5320 MHz, 5500 ~ 5720 MHz, 5745 ~ 5825 MHz
<b>Number of Channel</b>	5180 ~ 5240 MHz: 4 for 802.11a, 802.11n (HT20) 2 for 802.11n (HT40) 1 for 802.11ac (VHT80) 5260 ~ 5320 MHz: 4 for 802.11a, 802.11n (HT20) 2 for 802.11n (HT40) 1 for 802.11ac (VHT80) 5500 ~ 5720 MHz: 12 for 802.11a, 802.11n (HT20) 6 for 802.11n (HT40) 3 for 802.11ac (VHT80) 5745 ~ 5825 MHz: 5 for 802.11a, 802.11n (HT20) 2 for 802.11n (HT40) 1 for 802.11ac (VHT80)
<b>Output Power</b>	5180 ~ 5240 MHz: 802.11a: 16.87 dBm / 48.641 mW 802.11n (HT20): 17.01 dBm / 50.234 mW 802.11n (HT40): 17.35 dBm / 54.325 mW 802.11ac (VHT80): 13.98 dBm / 25.003 mW 5260 ~ 5320 MHz: 802.11a: 17.11 dBm / 51.404 mW 802.11n (HT20): 17.24 dBm / 52.966 mW 802.11n (HT40): 17.69 dBm / 58.749 mW 802.11ac (VHT80): 14.46 dBm / 27.925 mW 5500 ~ 5720 MHz: 802.11a: 17.10 dBm / 51.286 mW 802.11n (HT20): 17.19 dBm / 52.36 mW 802.11n (HT40): 17.57 dBm / 57.148 mW 802.11ac (VHT80): 14.66 dBm / 29.242 mW 5745 ~ 5825 MHz: 802.11a: 16.30 dBm / 42.658 mW 802.11n (HT20): 16.37 dBm / 37.844 mW 802.11n (HT40): 16.87 dBm / 48.641 mW 802.11ac (VHT80): 13.68 dBm / 23.335 mW

<b>Antenna Type</b>	Monopole antenna with -4 dBi gain (5180 ~ 5240 MHz) Monopole antenna with -4 dBi gain (5260 ~ 5320 MHz) Monopole antenna with -4 dBi gain (5500 ~ 5720 MHz) Monopole antenna with -4 dBi gain (5745 ~ 5825 MHz)
<b>Antenna Connector</b>	Coaxial Connector
<b>Product HW Version</b>	Lenovo Tablet TB-X605F
<b>Product SW Version</b>	TB-X605F_RF01_20180615
<b>Accessory Device</b>	Refer to Note as below
<b>Data Cable Supplied</b>	Refer to Note as below

**Note:**

1. The EUT provides 1 completed transmitter and 1 receiver.

Modulation Mode	Tx Function
802.11a	1TX
802.11n (HT20)	1TX
802.11n (HT40)	1TX
802.11ac (VHT80)	1TX

2. The EUT contains following accessory devices.

Product	Brand	Model	Description
Adapter 1	Salom	SC-41	I/P: 100-240 Vac, 50/60 Hz, 0.3 A O/P: 5 Vdc, 2 A
Adapter 2	AcBel	SC-41	I/P: 100-240 Vac, 50/60 Hz, 0.3 A O/P: 5 Vdc, 2 A
Battery	ATL	L18D1P32	3.85 Vdc, 4850 mAh
USB Cable 1 (White)	LiQi	LQ-02300039	1 m shielded cable w/o core
USB Cable 2 (Black)	LiQi	LQ-02300040	1 m shielded cable w/o core
LCD Panel 1 (Black)	BOE	TV101WUM-LL2	10.1 "
LCD Panel 2 (White)	BOE	TV101WUM-LL3	10.1 "
Photo Camera 1	Lcetron	LE5143AM	5M AF
Photo Camera 2	Holitek	MF81Q	5M AF
Photo Camera 3	Lcetron	ZRT2509V-P102F	2M FF
Photo Camera 4	Holitek	HSU1005	2M FF
CPU	Qualcomm	SDA450	792nsp

\* USB Cable 1 and USB Cable 2 is electrically identical, difference models are for color distinguished. Therefore, only USB Cable 1 is as a representative for final test.

\* LCD Panel 1 and LCD Panel 2 is electrically identical, difference models are for color distinguished. Therefore, only LCD Panel 2 is as a representative for final test.



Product	Brand	Model	Description
EMMC1 + DDR1	SAMSUNG	KMQE60013M-B318 ( 2+16 )	16G
EMMC2 + DDR2	HYNIX	H9TQ17ABJTCCUR-KUM ( 2+16 )	16G
EMMC3 + DDR3	SAMSUNG	KMGD6001BM-B421 ( 3+32 )	32G
EMMC4 + DDR4	HYNIX	H9TQ27ADFTMCUR-KUM ( 3+32 )	32G
EMMC5 + DDR5	SAMSUNG	KMRH60014A-B614 ( 4+64 )	64G
EMMC6 + DDR6	HYNIX	H9TQ52ACLTMCUR-KUM ( 4+64 )	64G
Speaker 1	Keysound	QM171219AW84	--
Speaker 2	Keysound	QM171219AW85	--
Motor 1	AWA	YK2455R	--
Motor 2	Baolong	BLX-431320S	--
Main Board 1	huashen	W93M71B2-3-03	--
Main Board 2	yilianda	W93M71B2-3-05	--
BT/WLAN Module	Qualcomm	WCN3680B-0-79BWLNSP	--

- The Adapter 1 and Adapter 2 had been pre-tested to determine the worst-case. The worst case was found in Adapter 1. Therefore, only Adapter 1 was chosen for the final test.
- The EUT contains two samples.

Sample	Configurations
A	EUT + LCD Panel 2 + Photo Camera 1 + Photo Camera 3 + EMMC 3 + DDR 3 + Speaker 1 + Speaker 2 + Motor 2 + Main Board 1 + BT/WLAN Module + Battery
B	EUT + LCD Panel 2 + Photo Camera 2 + Photo Camera 4 + EMMC 4 + DDR 4 + Speaker 1 + Speaker 2 + Motor 1 + Main Board 2 + BT/WLAN Module + Battery

- The above EUT information is declared by manufacturer and for more detailed features description, please refers to the manufacturer's specifications or user's manual.

### 3.2 Description of Test Modes

#### For 5180 ~ 5240 MHz

4 channels are provided for 802.11a, 802.11n (HT20):

Channel	Frequency (MHz)	Channel	Frequency (MHz)
36	5180	44	5220
40	5200	48	5240

2 channels are provided for 802.11n (HT40):

Channel	Frequency (MHz)	Channel	Frequency (MHz)
38	5190	46	5230

1 channel is provided for 802.11ac (VHT80):

Channel	Frequency (MHz)
42	5210

#### For 5260 ~ 5320 MHz

4 channels are provided for 802.11a, 802.11n (HT20):

Channel	Frequency (MHz)	Channel	Frequency (MHz)
52	5260	60	5300
56	5280	64	5320

2 channels are provided for 802.11n (HT40):

Channel	Frequency (MHz)	Channel	Frequency (MHz)
54	5270	62	5310

1 channel is provided for 802.11ac (VHT80):

Channel	Frequency (MHz)
58	5290

### For 5500 ~ 5700 MHz

12 channels are provided for 802.11a, 802.11n (HT20):

Channel	Frequency (MHz)	Channel	Frequency (MHz)
100	5500	124	5620
104	5520	128	5640
108	5540	132	5660
112	5560	136	5680
116	5580	140	5700
120	5600	144	5720

6 channels are provided for 802.11n (HT40):

Channel	Frequency (MHz)	Channel	Frequency (MHz)
102	5510	126	5630
110	5550	134	5670
118	5590	142	5710

3 channels are provided for 802.11ac (VHT80):

Channel	Frequency (MHz)	Channel	Frequency (MHz)
106	5530	138	5690
122	5610		

### For 5745 ~ 5825 MHz:

5 channels are provided for 802.11a, 802.11n (HT20):

Channel	Frequency (MHz)	Channel	Frequency (MHz)
149	5745	161	5805
153	5765	165	5825
157	5785		

2 channels are provided for 802.11n (HT40):

Channel	Frequency (MHz)	Channel	Frequency (MHz)
151	5755	159	5795

1 channel is provided for 802.11ac (VHT80):

Channel	Frequency (MHz)
155	5775

### 3.2.1 Test Mode Applicability and Tested Channel Detail

EUT Configure Mode	Applicable To				Description
	RE $\geq$ 1G	RE $<$ 1G	PLC	APCM	
A	√	√	√	√	Sample A
B	-	√	√	-	Sample B

Where **RE $\geq$ 1G**: Radiated Emission above 1 GHz      **RE $<$ 1G**: Radiated Emission below 1 GHz  
**PLC**: Power Line Conducted Emission      **APCM**: Antenna Port Conducted Measurement

**NOTE:**

1. The EUT had been pre-tested on the positioned of each 3 axis. The worst case was found when positioned on **X-plane**.
2. "-" means no effect.

#### **Radiated Emission Test (Above 1 GHz):**

- Pre-Scan has been conducted to determine the worst-case mode from all possible combinations between available modulations, data rates and antenna ports (if EUT with antenna diversity architecture).
- Following channel(s) was (were) selected for the final test as listed below.

EUT Configure Mode	Frequency Band (MHz)	Mode	Available Channel	Tested Channel	Modulation Technology	Modulation Type	Data Rate (Mbps)
A	5180-5240	802.11a	36 to 48	36, 40, 48	OFDM	BPSK	6.0
		802.11n (HT20)	36 to 48	36, 40, 48	OFDM	BPSK	6.5
		802.11n (HT40)	38 to 46	38, 46	OFDM	BPSK	13.5
		802.11ac (VHT80)	42	42	OFDM	BPSK	29.3
	5260-5320	802.11a	52 to 64	52, 60, 64	OFDM	BPSK	6.0
		802.11n (HT20)	52 to 64	52, 60, 64	OFDM	BPSK	6.5
		802.11n (HT40)	54 to 62	54, 62	OFDM	BPSK	13.5
		802.11ac (VHT80)	58	58	OFDM	BPSK	29.3
	5500-5720	802.11a	100 to 144	100, 116, 140, 144	OFDM	BPSK	6.0
		802.11n (HT20)	100 to 144	100, 116, 140, 144	OFDM	BPSK	6.5
		802.11n (HT40)	102 to 142	102, 110, 134, 142	OFDM	BPSK	13.5
		802.11ac (VHT80)	106 to 138	106, 122, 138	OFDM	BPSK	29.3
	5745-5825	802.11a	149 to 165	149, 157, 165	OFDM	BPSK	6.0
		802.11n (HT20)	149 to 165	149, 157, 165	OFDM	BPSK	6.5
		802.11n (HT40)	151 to 159	151, 159	OFDM	BPSK	13.5
		802.11ac (VHT80)	155	155	OFDM	BPSK	29.3

#### **Radiated Emission Test (Below 1 GHz):**

- Pre-Scan has been conducted to determine the worst-case mode from all possible combinations between available modulations, data rates and antenna ports (if EUT with antenna diversity architecture).
- Following channel(s) was (were) selected for the final test as listed below.

EUT Configure Mode	Frequency Band (MHz)	Mode	Available Channel	Tested Channel	Modulation Technology	Modulation Type	Data Rate (Mbps)
A, B	5745-5825	802.11n (HT20)	149 to 165	157	OFDM	BPSK	6.5

**Power Line Conducted Emission Test:**

- Pre-Scan has been conducted to determine the worst-case mode from all possible combinations between available modulations, data rates and antenna ports (if EUT with antenna diversity architecture).
- Following channel(s) was (were) selected for the final test as listed below.

EUT Configure Mode	Test Condition
A, B	WLAN 5G + USB Cable + Adapter

**Antenna Port Conducted Measurement:**

- This item includes all test value of each mode, but only includes spectrum plot of worst value of each mode.
- Pre-Scan has been conducted to determine the worst-case mode from all possible combinations between available modulations, data rates and antenna ports (if EUT with antenna diversity architecture).
- Following channel(s) was (were) selected for the final test as listed below.

EUT Configure Mode	Frequency Band (MHz)	Mode	Available Channel	Tested Channel	Modulation Technology	Modulation Type	Data Rate (Mbps)
A, B	5180-5240	802.11a	36 to 48	36, 40, 48	OFDM	BPSK	6.0
		802.11n (HT20)	36 to 48	36, 40, 48	OFDM	BPSK	6.5
		802.11n (HT40)	38 to 46	38, 46	OFDM	BPSK	13.5
		802.11ac (VHT80)	42	42	OFDM	BPSK	29.3
	5260-5320	802.11a	52 to 64	52, 60, 64	OFDM	BPSK	6.0
		802.11n (HT20)	52 to 64	52, 60, 64	OFDM	BPSK	6.5
		802.11n (HT40)	54 to 62	54, 62	OFDM	BPSK	13.5
		802.11ac (VHT80)	58	58	OFDM	BPSK	29.3
	5500-5720	802.11a	100 to 144	100, 116, 140, 144	OFDM	BPSK	6.0
		802.11n (HT20)	100 to 144	100, 116, 140, 144	OFDM	BPSK	6.5
		802.11n (HT40)	102 to 142	102, 110, 134, 142	OFDM	BPSK	13.5
		802.11ac (VHT80)	106 to 138	106, 122, 138	OFDM	BPSK	29.3
	5745-5825	802.11a	149 to 165	149, 157, 165	OFDM	BPSK	6.0
		802.11n (HT20)	149 to 165	149, 157, 165	OFDM	BPSK	6.5
		802.11n (HT40)	151 to 159	151, 159	OFDM	BPSK	13.5
		802.11ac (VHT80)	155	155	OFDM	BPSK	29.3

**Test Condition:**

Applicable To	Environmental Conditions	Input Power	Tested by
RE≥1G	25 deg. C, 65 % RH	120 Vac, 60 Hz	James Wei
RE<1G	25 deg. C, 65 % RH	120 Vac, 60 Hz	James Wei
PLC	25 deg. C, 65 % RH	120 Vac, 60 Hz	Adair Peng
APCM	25 deg. C, 65 % RH	3.85 Vdc	Frank Chiu

### 3.3 Duty Cycle of Test Signal

#### MODULATION TYPE: BPSK

**802.11a:** Duty cycle =  $1.360/1.578 = 0.862$ , Duty factor =  $10 * \log(1/0.862) = 0.64$

**802.11n (HT20):** Duty cycle =  $1.274/1.474 = 0.864$ , Duty factor =  $10 * \log(1/0.864) = 0.63$

**802.11n (HT40):** Duty cycle =  $0.632/0.836 = 0.756$ , Duty factor =  $10 * \log(1/0.756) = 1.21$

**802.11ac (VHT80):** Duty cycle =  $0.245/0.447 = 0.548$ , Duty factor =  $10 * \log(1/0.548) = 2.61$

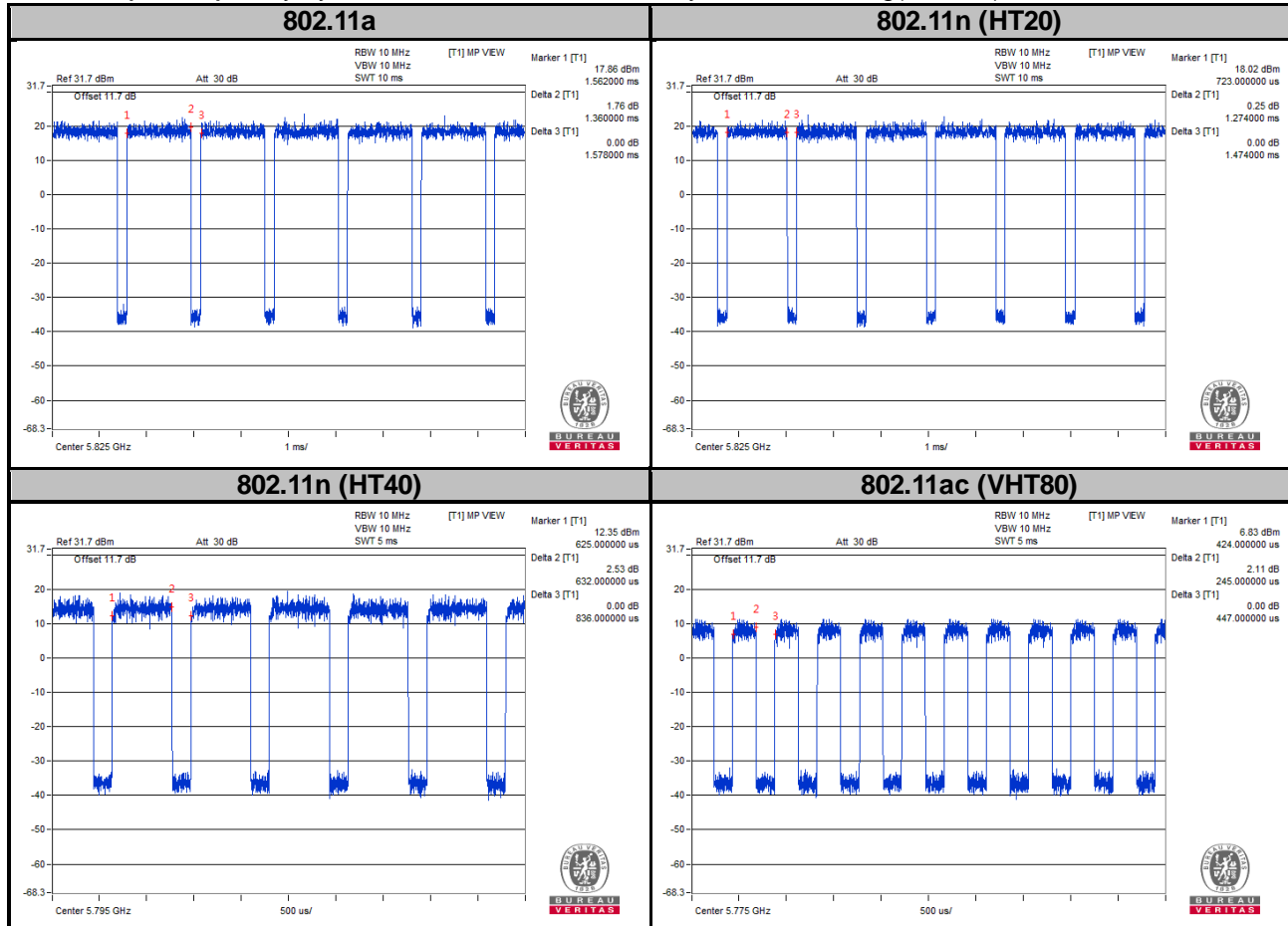

### 3.4 Description of Support Units

The EUT has been tested as an independent unit together with other necessary accessories or support units. The following support units or accessories were used to form a representative test configuration during the tests.

No.	Product	Brand	Model No.	Serial No.	FCC ID
1.	Earphone	N/A	N/A	N/A	N/A

No.	Signal Cable Description of The Above Support Units
1.	N/A

Note:

1. All power cords of the above support units are non-shielded (1.8m).

#### 3.4.1 Configuration of System under Test

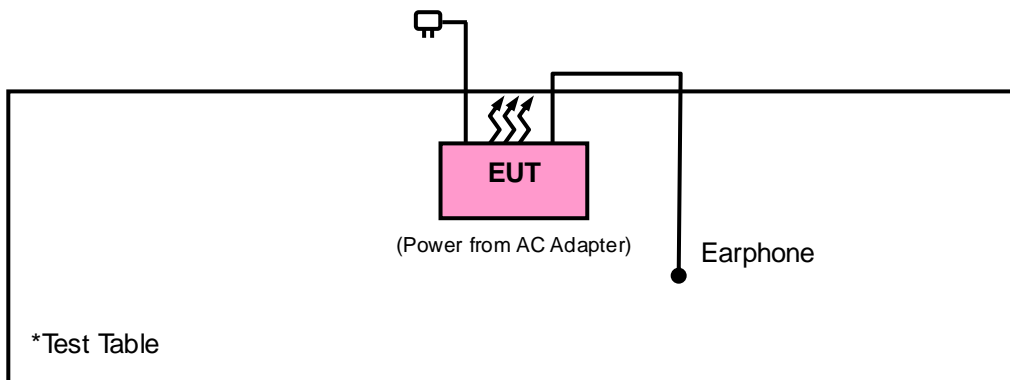

### 3.5 General Description of Applied Standards

The EUT is a RF Product. According to the specifications of the manufacturer, it must comply with the requirements of the following standards:

**FCC Part 15, Subpart E (15.407)**

**789033 D02 General UNII Test Procedures New Rules v02r01**

ANSI C63.10-2013

All test items have been performed and recorded as per the above standards.

## 4 Test Types and Results

### 4.1 Radiated Emission and Bandedge Measurement

#### 4.1.1 Limits of Radiated Emission and Bandedge Measurement

Radiated emissions which fall in the restricted bands must comply with the radiated emission limits specified as below table. Other emissions shall be at least 20 dB below the highest level of the desired power:

Frequencies (MHz)	Field Strength (microvolts/meter)	Measurement Distance (meters)
0.009 ~ 0.490	2400/F (kHz)	300
0.490 ~ 1.705	24000/F (kHz)	30
1.705 ~ 30.0	30	30
30 ~ 88	100	3
88 ~ 216	150	3
216 ~ 960	200	3
Above 960	500	3

**Note:**

1. The lower limit shall apply at the transition frequencies.
2. Emission level (dBuV/m) = 20 log Emission level (uV/m).
3. For frequencies above 1000 MHz, the field strength limits are based on average detector, however, the peak field strength of any emission shall not exceed the maximum permitted average limits, specified above by more than 20 dB under any condition of modulation.



#### 4.1.2 Limits of Unwanted Emission Out of the Restricted Bands

Applicable To		Limit	
789033 D02 General UNII Test Procedures New Rules v02r01		Field Strength at 3 m	
		PK: 74 (dBµV/m)	AV: 54 (dBµV/m)
Frequency Band	Applicable To	EIRP Limit	Equivalent Field Strength at 3 m
5150~5250 MHz	15.407(b)(1)	PK: -27 (dBm/MHz)	PK: 68.2 (dBµV/m)
5250~5350 MHz	15.407(b)(2)		
5470~5725 MHz	15.407(b)(3)		
5725~5850 MHz	15.407(b)(4)(i)	PK:-27 (dBm/MHz) <sup>*1</sup> PK:10 (dBm/MHz) <sup>*2</sup> PK:15.6 (dBm/MHz) <sup>*3</sup> PK:27 (dBm/MHz) <sup>*4</sup>	PK: 68.2 (dBµV/m) <sup>*1</sup> PK:105.2 (dBµV/m) <sup>*2</sup> PK: 110.8 (dBµV/m) <sup>*3</sup> PK:122.2 (dBµV/m) <sup>*4</sup>
	15.407(b)(4)(ii)	Emission limits in section 15.247(d)	

<sup>\*1</sup> beyond 75 MHz or more above of the band edge.

<sup>\*2</sup> below the band edge increasing linearly to 10 dBm/MHz at 25 MHz above.

<sup>\*3</sup> below the band edge increasing linearly to a level of 15.6 dBm/MHz at 5 MHz above.

<sup>\*4</sup> from 5 MHz above or below the band edge increasing linearly to a level of 27 dBm/MHz at the band edge.

**Note:**

The following formula is used to convert the equipment isotropic radiated power (eirp) to field strength:

$$E = \frac{1000000\sqrt{30P}}{3} \mu\text{V/m, where P is the eirp (Watts).}$$

## 4.1.3 Test Instruments

Description & Manufacturer	Model No.	Serial No.	Date of Calibration	Due Date of Calibration
Test Receiver ROHDE & SCHWARZ	ESIB7	100187	May 29, 2018	May 28, 2019
Spectrum Analyzer ROHDE & SCHWARZ	FSU43	101261	Jan. 11, 2018	Jan. 10, 2019
BILOG Antenna SCHWARZBECK	VULB9168	9168-171	Dec. 11, 2017	Dec. 10, 2018
HORN Antenna SCHWARZBECK	9120D	209	Dec. 13, 2017	Dec. 12, 2018
HORN Antenna SCHWARZBECK	BBHA 9170	BBHA9170241	Dec. 01, 2017	Nov. 30, 2018
1W Rotary Attenuator Woken	00801A1GGAM02Y	NA	May 17, 2018	May 16, 2019
Loop Antenna	EM-6879	269	Aug. 11, 2017	Aug. 10, 2018
Preamplifier Agilent (Below 1GHz)	8447D	2944A10738	Aug. 21, 2017	Aug. 20, 2018
Preamplifier Agilent (Above 1GHz)	8449B	3008A02465	Apr. 03, 2018	Apr. 02, 2019
Power Meter Anritsu	ML2495A	1012010	Aug. 15, 2017	Aug. 14, 2018
Power Sensor Anritsu	MA2411B	1315050	Aug. 15, 2017	Aug. 14, 2018
RF signal cable HUBER+SUHNER	SUCOFLEX 104	Cable-CH3-03 (223653/4)	Aug. 21, 2017	Aug. 20, 2018
RF signal cable HUBER+SUHNER & EMCI	SUCOFLEX 104&EMC104-SM- SM-8000	Cable-CH3-03 (309224+170907)	Sep.11, 2017	Sep. 10, 2018
Boresight Antenna Fixture	FBA-01	FBA-SIP01	NA	NA
26GHz ~ 40GHz Amplifier Agilent	8449B	3008A1960	Aug. 08, 2017	Aug. 07, 2018
Software BV ADT	ADT_Radiated_ V7.6.15.9.5	NA	NA	NA
Antenna Tower inn-co GmbH	MA 4000	013303	NA	NA
Antenna Tower Controller BV ADT	AT100	AT93021702	NA	NA
Turn Table BV ADT	TT100	TT93021702	NA	NA
Turn Table Controller BV ADT	SC100	SC93021702	NA	NA
WIT Standard Temperature And Humidity Chamber	TH-4S-C	W981030	Jun. 04, 2018	Jun. 03, 2019
DC Power Supply Topward	33010D	807748	Oct. 25, 2016	Oct. 24, 2018
Digital Multimeter Fluke	87-III	70360742	Jun. 29, 2018	Jun. 28, 2019

- Note:
1. The calibration interval of the above test instruments is 12 months and the calibrations are traceable to NML/ROC and NIST/USA.
  2. The test was performed in HwaYa Chamber 3.
  3. The horn antenna and preamplifier (model: 8449B) are used only for the measurement of emission frequency above 1 GHz if tested.
  4. The IC Site Registration No. is 7450F-3.

#### 4.1.4 Test Procedures

##### **For Radiated Emission below 30 MHz**

- a. The EUT was placed on the top of a rotating table 0.8 meters above the ground at a 3 meter chamber room. The table was rotated 360 degrees to determine the position of the highest radiation.
- b. The EUT was set 3 meters away from the interference-receiving antenna, which was mounted on the top of a variable-height antenna tower.
- c. Both Parallel, perpendicular, and ground-parallel orientations of the antenna are set to make the measurement.
- d. For each suspected emission, the EUT was arranged to its worst case and the rotatable table was turned from 0 degrees to 360 degrees to find the maximum reading.
- e. The test-receiver system was set to Quasi-Peak Detect Function and Specified Bandwidth with Maximum Hold Mode.

##### **Note:**

1. The resolution bandwidth and video bandwidth of test receiver/spectrum analyzer is 9 kHz at frequency below 30 MHz.

##### **For Radiated Emission above 30 MHz**

- a. The EUT was placed on the top of a rotating table 0.8 meters (for 30 MHz ~ 1 GHz) / 1.5 meters (for above 1 GHz) above the ground at 3 meter chamber room for test. The table was rotated 360 degrees to determine the position of the highest radiation.
- b. The EUT was set 3 meters away from the interference-receiving antenna, which was mounted on the top of a variable-height antenna tower.
- c. The height of antenna is varied from one meter to four meters above the ground to determine the maximum value of the field strength. Both horizontal and vertical polarizations of the antenna are set to make the measurement.
- d. For each suspected emission, the EUT was arranged to its worst case and then the antenna was tuned to heights from 1 meter to 4 meters and the rotatable table was turned from 0 degrees to 360 degrees to find the maximum reading.
- e. The test-receiver system was set to quasi-peak detect function and specified bandwidth with maximum hold mode when the test frequency is below 1 GHz.
- f. The test-receiver system was set to peak and average detected function and specified bandwidth with maximum hold mode when the test frequency is above 1 GHz. If the peak reading value also meets average limit, measurement with the average detector is unnecessary.

##### **Note:**

1. The resolution bandwidth and video bandwidth of test receiver/spectrum analyzer is 120 kHz for Quasi-peak detection (QP) at frequency below 1 GHz.
2. The resolution bandwidth of test receiver/spectrum analyzer is 1 MHz and the video bandwidth is 3 MHz for Peak detection (PK) at frequency above 1 GHz.
3. The resolution bandwidth of test receiver/spectrum analyzer is 1 MHz and the video bandwidth is  $\geq 1/T$  (Duty cycle < 98 %) or 10 Hz (Duty cycle  $\geq$  98 %) for Average detection (AV) at frequency above 1 GHz.  
(11a: RBW = 1 MHz, VBW = 1 kHz ; 11n (HT20): RBW = 1 MHz, VBW = 1 kHz ;  
11n (HT40): RBW = 1 MHz, VBW = 3 kHz ; 11ac (VHT80): RBW = 1 MHz, VBW = 10 kHz)
4. All modes of operation were investigated and the worst-case emissions are reported.

4.1.5 Deviation from Test Standard

No deviation.

4.1.6 Test Setup

<Radiated Emission below 30 MHz>

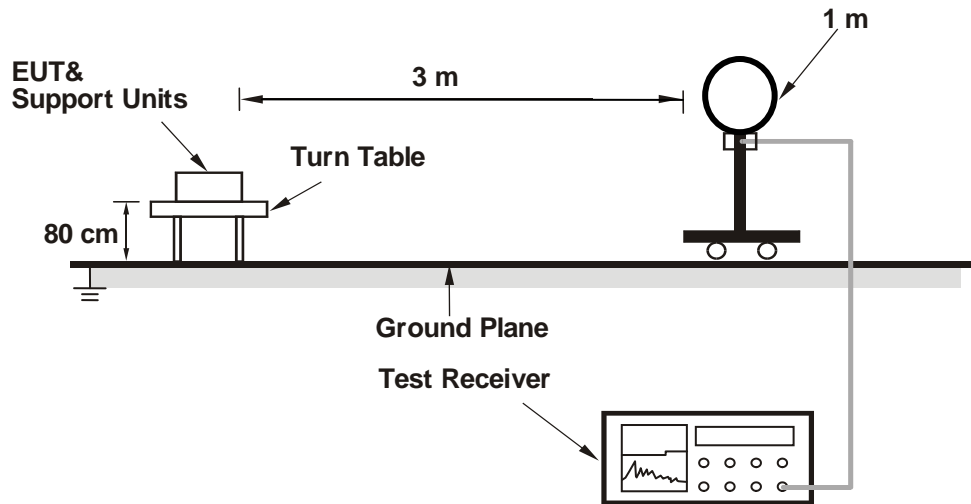

<Radiated Emission 30 MHz to 1 GHz>

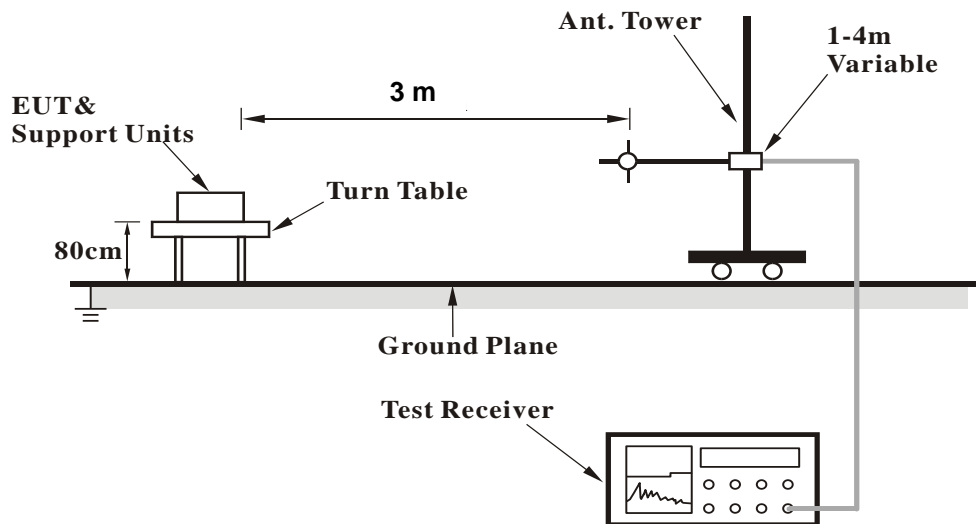

### <Radiated Emission above 1 GHz>

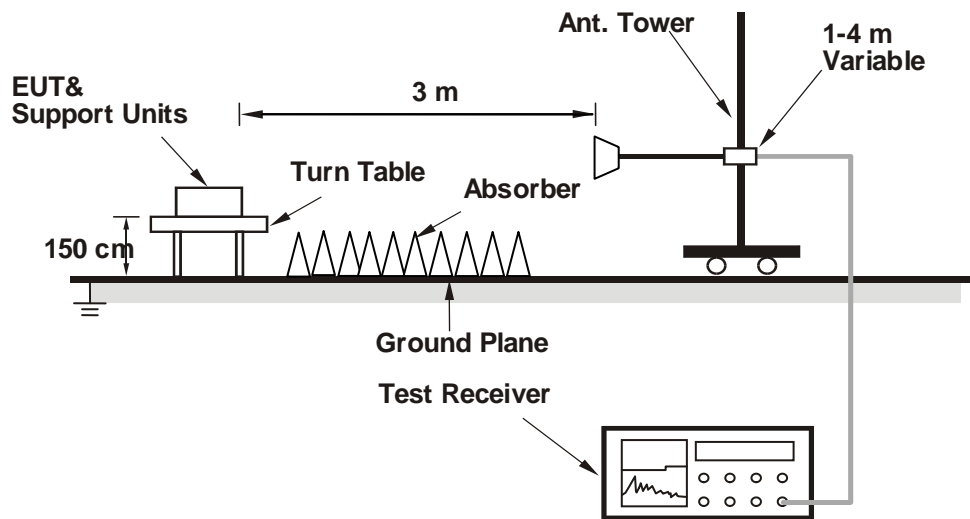

For the actual test configuration, please refer to the attached file (Test Setup Photo).

#### 4.1.7 EUT Operating Conditions

- a. Placed the EUT on a testing table.
- b. Use the software to control the EUT under transmission condition continuously at specific channel frequency.

#### 4.1.8 Test Results

#### Above 1 GHz Data :

#### Mode A

#### 802.11a

<b>CHANNEL</b>	TX Channel 36	<b>DETECTOR FUNCTION</b>	Peak (PK)
<b>FREQUENCY RANGE</b>	1GHz ~ 40GHz		Average (AV)

#### ANTENNA POLARITY & TEST DISTANCE: HORIZONTAL AT 3 M

NO.	FREQ. (MHz)	EMISSION LEVEL (dBUV/m)	LIMIT (dBUV/m)	MARGIN (dB)	ANTENNA HEIGHT (m)	TABLE ANGLE (Degree)	RAW VALUE (dBUV)	CORRECTION FACTOR (dB/m)
1	5150.00	54.5 PK	74.0	-19.5	2.37 H	289	50.8	3.7
2	5150.00	41.6 AV	54.0	-12.4	2.37 H	289	38.0	3.7
3	*5180.00	98.8 PK			2.37 H	289	95.4	3.4
4	*5180.00	87.5 AV			2.37 H	289	84.1	3.4
5	#10360.00	54.6 PK	74.0	-19.4	1.13 H	291	39.9	14.7
6	#10360.00	40.0 AV	54.0	-14.0	1.13 H	291	25.3	14.7

#### ANTENNA POLARITY & TEST DISTANCE: VERTICAL AT 3 M

NO.	FREQ. (MHz)	EMISSION LEVEL (dBUV/m)	LIMIT (dBUV/m)	MARGIN (dB)	ANTENNA HEIGHT (m)	TABLE ANGLE (Degree)	RAW VALUE (dBUV)	CORRECTION FACTOR (dB/m)
1	5150.00	55.4 PK	74.0	-18.6	1.09 V	21	51.8	3.7
2	5150.00	43.1 AV	54.0	-10.9	1.09 V	21	39.4	3.7
3	*5180.00	101.6 PK			1.09 V	21	98.2	3.4
4	*5180.00	90.3 AV			1.09 V	21	87.0	3.4
5	#10360.00	55.5 PK	74.0	-18.5	1.55 V	327	40.8	14.7
6	#10360.00	41.5 AV	54.0	-12.5	1.55 V	327	26.8	14.7

#### REMARKS:

1. Emission Level(dBUV/m) = Raw Value(dBUV) + Correction Factor(dB/m)
2. Correction Factor(dB/m) = Antenna Factor(dB/m) + Cable Factor(dB) – Pre-Amplifier Factor(dB)
3. The other emission levels were very low against the limit.
4. Margin value = Emission Level – Limit value
5. " \* ": Fundamental frequency.
6. " # ": The radiated frequency is out of the restricted band.

<b>CHANNEL</b>	TX Channel 40	<b>DETECTOR FUNCTION</b>	Peak (PK)
<b>FREQUENCY RANGE</b>	1GHz ~ 40GHz		Average (AV)

**ANTENNA POLARITY & TEST DISTANCE: HORIZONTAL AT 3 M**

NO.	FREQ. (MHz)	EMISSION LEVEL (dBuV/m)	LIMIT (dBuV/m)	MARGIN (dB)	ANTENNA HEIGHT (m)	TABLE ANGLE (Degree)	RAW VALUE (dBuV)	CORRECTION FACTOR (dB/m)
1	*5200.00	98.5 PK			2.33 H	293	95.3	3.2
2	*5200.00	87.2 AV			2.33 H	293	84.1	3.2
3	#10400.00	54.8 PK	74.0	-19.2	1.28 H	287	39.8	14.9
4	#10400.00	40.3 AV	54.0	-13.8	1.28 H	287	25.3	14.9

**ANTENNA POLARITY & TEST DISTANCE: VERTICAL AT 3 M**

NO.	FREQ. (MHz)	EMISSION LEVEL (dBuV/m)	LIMIT (dBuV/m)	MARGIN (dB)	ANTENNA HEIGHT (m)	TABLE ANGLE (Degree)	RAW VALUE (dBuV)	CORRECTION FACTOR (dB/m)
1	*5200.00	101.3 PK			1.12 V	20	98.1	3.2
2	*5200.00	90.1 AV			1.12 V	20	86.9	3.2
3	#10400.00	55.6 PK	74.0	-18.4	1.38 V	298	40.7	14.9
4	#10400.00	41.6 AV	54.0	-12.4	1.38 V	298	26.6	14.9

**REMARKS:**

1. Emission Level(dBuV/m) = Raw Value(dBuV) + Correction Factor(dB/m)
2. Correction Factor(dB/m) = Antenna Factor(dB/m) + Cable Factor(dB) – Pre-Amplifier Factor(dB)
3. The other emission levels were very low against the limit.
4. Margin value = Emission Level – Limit value
5. " \* ": Fundamental frequency.
6. " # ": The radiated frequency is out of the restricted band.



<b>CHANNEL</b>	TX Channel 48	<b>DETECTOR FUNCTION</b>	Peak (PK)
<b>FREQUENCY RANGE</b>	1GHz ~ 40GHz		Average (AV)

**ANTENNA POLARITY & TEST DISTANCE: HORIZONTAL AT 3 M**

NO.	FREQ. (MHz)	EMISSION LEVEL (dBuV/m)	LIMIT (dBuV/m)	MARGIN (dB)	ANTENNA HEIGHT (m)	TABLE ANGLE (Degree)	RAW VALUE (dBuV)	CORRECTION FACTOR (dB/m)
1	*5240.00	99.9 PK			2.41 H	290	96.9	3.0
2	*5240.00	89.0 AV			2.41 H	290	86.0	3.0
3	5350.00	52.5 PK	74.0	-21.5	2.41 H	290	49.6	2.9
4	5350.00	39.1 AV	54.0	-15.0	2.41 H	290	36.1	2.9
5	#10480.00	55.5 PK	74.0	-18.5	1.18 H	287	40.0	15.5
6	#10480.00	41.1 AV	54.0	-12.9	1.18 H	287	25.6	15.5

**ANTENNA POLARITY & TEST DISTANCE: VERTICAL AT 3 M**

NO.	FREQ. (MHz)	EMISSION LEVEL (dBuV/m)	LIMIT (dBuV/m)	MARGIN (dB)	ANTENNA HEIGHT (m)	TABLE ANGLE (Degree)	RAW VALUE (dBuV)	CORRECTION FACTOR (dB/m)
1	*5240.00	102.7 PK			1.13 V	24	99.7	3.0
2	*5240.00	91.9 AV			1.13 V	24	88.9	3.0
3	5350.00	53.8 PK	74.0	-20.2	1.13 V	24	50.9	2.9
4	5350.00	40.6 AV	54.0	-13.4	1.13 V	24	37.7	2.9
5	#10480.00	56.8 PK	74.0	-17.2	1.68 V	302	41.3	15.5
6	#10480.00	42.4 AV	54.0	-11.6	1.68 V	302	26.9	15.5

**REMARKS:**

1. Emission Level(dBuV/m) = Raw Value(dBuV) + Correction Factor(dB/m)
2. Correction Factor(dB/m) = Antenna Factor(dB/m) + Cable Factor(dB) – Pre-Amplifier Factor(dB)
3. The other emission levels were very low against the limit.
4. Margin value = Emission Level – Limit value
5. " \* ": Fundamental frequency.
6. " # ": The radiated frequency is out of the restricted band.

<b>CHANNEL</b>	TX Channel 52	<b>DETECTOR FUNCTION</b>	Peak (PK)
<b>FREQUENCY RANGE</b>	1GHz ~ 40GHz		Average (AV)

**ANTENNA POLARITY & TEST DISTANCE: HORIZONTAL AT 3 M**

NO.	FREQ. (MHz)	EMISSION LEVEL (dBuV/m)	LIMIT (dBuV/m)	MARGIN (dB)	ANTENNA HEIGHT (m)	TABLE ANGLE (Degree)	RAW VALUE (dBuV)	CORRECTION FACTOR (dB/m)
1	5150.00	54.9 PK	74.0	-19.1	2.51 H	292	51.2	3.7
2	5150.00	40.9 AV	54.0	-13.1	2.51 H	292	37.3	3.7
3	*5260.00	97.9 PK			2.51 H	292	95.0	2.9
4	*5260.00	86.8 AV			2.51 H	292	83.9	2.9
5	#10520.00	55.4 PK	74.0	-18.6	1.10 H	285	39.7	15.6
6	#10520.00	40.9 AV	54.0	-13.1	1.10 H	285	25.2	15.6

**ANTENNA POLARITY & TEST DISTANCE: VERTICAL AT 3 M**

NO.	FREQ. (MHz)	EMISSION LEVEL (dBuV/m)	LIMIT (dBuV/m)	MARGIN (dB)	ANTENNA HEIGHT (m)	TABLE ANGLE (Degree)	RAW VALUE (dBuV)	CORRECTION FACTOR (dB/m)
1	5150.00	55.8 PK	74.0	-18.2	1.00 V	24	52.2	3.7
2	5150.00	42.3 AV	54.0	-11.7	1.00 V	24	38.6	3.7
3	*5260.00	100.6 PK			1.00 V	24	97.7	2.9
4	*5260.00	89.6 AV			1.00 V	24	86.7	2.9
5	#10520.00	56.3 PK	74.0	-17.7	1.68 V	332	40.7	15.6
6	#10520.00	42.2 AV	54.0	-11.8	1.68 V	332	26.6	15.6

**REMARKS:**

1. Emission Level(dBuV/m) = Raw Value(dBuV) + Correction Factor(dB/m)
2. Correction Factor(dB/m) = Antenna Factor(dB/m) + Cable Factor(dB) – Pre-Amplifier Factor(dB)
3. The other emission levels were very low against the limit.
4. Margin value = Emission Level – Limit value
5. " \* ": Fundamental frequency.
6. " # ": The radiated frequency is out of the restricted band.

<b>CHANNEL</b>	TX Channel 60	<b>DETECTOR FUNCTION</b>	Peak (PK)
<b>FREQUENCY RANGE</b>	1GHz ~ 40GHz		Average (AV)

**ANTENNA POLARITY & TEST DISTANCE: HORIZONTAL AT 3 M**

NO.	FREQ. (MHz)	EMISSION LEVEL (dBuV/m)	LIMIT (dBuV/m)	MARGIN (dB)	ANTENNA HEIGHT (m)	TABLE ANGLE (Degree)	RAW VALUE (dBuV)	CORRECTION FACTOR (dB/m)
1	*5300.00	97.1 PK			2.55 H	291	94.3	2.8
2	*5300.00	85.8 AV			2.55 H	291	83.0	2.8
3	10600.00	55.2 PK	74.0	-18.8	1.08 H	297	39.6	15.6
4	10600.00	40.7 AV	54.0	-13.3	1.08 H	297	25.1	15.6

**ANTENNA POLARITY & TEST DISTANCE: VERTICAL AT 3 M**

NO.	FREQ. (MHz)	EMISSION LEVEL (dBuV/m)	LIMIT (dBuV/m)	MARGIN (dB)	ANTENNA HEIGHT (m)	TABLE ANGLE (Degree)	RAW VALUE (dBuV)	CORRECTION FACTOR (dB/m)
1	*5300.00	99.6 PK			1.12 V	23	96.8	2.8
2	*5300.00	88.8 AV			1.12 V	23	86.0	2.8
3	10600.00	56.2 PK	74.0	-17.9	1.62 V	328	40.6	15.6
4	10600.00	42.0 AV	54.0	-12.0	1.62 V	328	26.5	15.6

**REMARKS:**

1. Emission Level(dBuV/m) = Raw Value(dBuV) + Correction Factor(dB/m)
2. Correction Factor(dB/m) = Antenna Factor(dB/m) + Cable Factor(dB) – Pre-Amplifier Factor(dB)
3. The other emission levels were very low against the limit.
4. Margin value = Emission Level – Limit value
5. " \* ": Fundamental frequency.

<b>CHANNEL</b>	TX Channel 64	<b>DETECTOR FUNCTION</b>	Peak (PK)
<b>FREQUENCY RANGE</b>	1GHz ~ 40GHz		Average (AV)

**ANTENNA POLARITY & TEST DISTANCE: HORIZONTAL AT 3 M**

NO.	FREQ. (MHz)	EMISSION LEVEL (dBuV/m)	LIMIT (dBuV/m)	MARGIN (dB)	ANTENNA HEIGHT (m)	TABLE ANGLE (Degree)	RAW VALUE (dBuV)	CORRECTION FACTOR (dB/m)
1	*5320.00	97.8 PK			2.55 H	287	95.0	2.8
2	*5320.00	86.6 AV			2.55 H	287	83.8	2.8
3	5350.00	53.0 PK	74.0	-21.0	2.55 H	287	50.1	2.9
4	5350.00	40.1 AV	54.0	-14.0	2.55 H	287	37.1	2.9
5	10640.00	55.1 PK	74.0	-18.9	1.11 H	279	39.7	15.5
6	10640.00	40.6 AV	54.0	-13.4	1.11 H	279	25.2	15.5

**ANTENNA POLARITY & TEST DISTANCE: VERTICAL AT 3 M**

NO.	FREQ. (MHz)	EMISSION LEVEL (dBuV/m)	LIMIT (dBuV/m)	MARGIN (dB)	ANTENNA HEIGHT (m)	TABLE ANGLE (Degree)	RAW VALUE (dBuV)	CORRECTION FACTOR (dB/m)
1	*5320.00	100.4 PK			1.12 V	31	97.6	2.8
2	*5320.00	89.1 AV			1.12 V	31	86.2	2.8
3	5350.00	54.6 PK	74.0	-19.4	1.12 V	31	51.6	2.9
4	5350.00	41.4 AV	54.0	-12.6	1.12 V	31	38.5	2.9
5	10640.00	56.1 PK	74.0	-18.0	1.66 V	321	40.6	15.5
6	10640.00	42.0 AV	54.0	-12.0	1.66 V	321	26.5	15.5

**REMARKS:**

1. Emission Level(dBuV/m) = Raw Value(dBuV) + Correction Factor(dB/m)
2. Correction Factor(dB/m) = Antenna Factor(dB/m) + Cable Factor(dB) – Pre-Amplifier Factor(dB)
3. The other emission levels were very low against the limit.
4. Margin value = Emission Level – Limit value
5. " \* ": Fundamental frequency.

<b>CHANNEL</b>	TX Channel 100	<b>DETECTOR FUNCTION</b>	Peak (PK)
<b>FREQUENCY RANGE</b>	1GHz ~ 40GHz		Average (AV)

**ANTENNA POLARITY & TEST DISTANCE: HORIZONTAL AT 3 M**

NO.	FREQ. (MHz)	EMISSION LEVEL (dBuV/m)	LIMIT (dBuV/m)	MARGIN (dB)	ANTENNA HEIGHT (m)	TABLE ANGLE (Degree)	RAW VALUE (dBuV)	CORRECTION FACTOR (dB/m)
1	5460.00	54.1 PK	74.0	-19.9	2.38 H	297	50.8	3.3
2	5460.00	41.4 AV	54.0	-12.6	2.38 H	297	38.1	3.3
3	#5470.00	55.0 PK	68.2	-13.2	2.38 H	297	51.7	3.3
4	*5500.00	98.1 PK			2.38 H	297	94.8	3.2
5	*5500.00	87.1 AV			2.38 H	297	83.9	3.2
6	11000.00	55.4 PK	74.0	-18.6	1.28 H	302	39.6	15.9
7	11000.00	40.9 AV	54.0	-13.1	1.28 H	302	25.0	15.9

**ANTENNA POLARITY & TEST DISTANCE: VERTICAL AT 3 M**

NO.	FREQ. (MHz)	EMISSION LEVEL (dBuV/m)	LIMIT (dBuV/m)	MARGIN (dB)	ANTENNA HEIGHT (m)	TABLE ANGLE (Degree)	RAW VALUE (dBuV)	CORRECTION FACTOR (dB/m)
1	5460.00	54.9 PK	74.0	-19.1	1.26 V	345	51.6	3.3
2	5460.00	42.5 AV	54.0	-11.5	1.26 V	345	39.2	3.3
3	#5470.00	56.4 PK	68.2	-11.8	1.26 V	345	53.1	3.3
4	*5500.00	100.5 PK			1.26 V	345	97.3	3.2
5	*5500.00	89.9 AV			1.26 V	345	86.7	3.2
6	11000.00	56.5 PK	74.0	-17.6	1.81 V	342	40.6	15.9
7	11000.00	42.3 AV	54.0	-11.7	1.81 V	342	26.4	15.9

**REMARKS:**

1. Emission Level(dBuV/m) = Raw Value(dBuV) + Correction Factor(dB/m)
2. Correction Factor(dB/m) = Antenna Factor(dB/m) + Cable Factor(dB) – Pre-Amplifier Factor(dB)
3. The other emission levels were very low against the limit.
4. Margin value = Emission Level – Limit value
5. " \* ": Fundamental frequency.
6. " # ": The radiated frequency is out of the restricted band.

<b>CHANNEL</b>	TX Channel 116	<b>DETECTOR FUNCTION</b>	Peak (PK)
<b>FREQUENCY RANGE</b>	1GHz ~ 40GHz		Average (AV)

**ANTENNA POLARITY & TEST DISTANCE: HORIZONTAL AT 3 M**

NO.	FREQ. (MHz)	EMISSION LEVEL (dBuV/m)	LIMIT (dBuV/m)	MARGIN (dB)	ANTENNA HEIGHT (m)	TABLE ANGLE (Degree)	RAW VALUE (dBuV)	CORRECTION FACTOR (dB/m)
1	*5580.00	99.7 PK			2.33 H	305	96.2	3.6
2	*5580.00	88.3 AV			2.33 H	305	84.7	3.6
3	11160.00	56.1 PK	74.0	-17.9	1.31 H	300	39.8	16.3
4	11160.00	41.7 AV	54.0	-12.3	1.31 H	300	25.4	16.3

**ANTENNA POLARITY & TEST DISTANCE: VERTICAL AT 3 M**

NO.	FREQ. (MHz)	EMISSION LEVEL (dBuV/m)	LIMIT (dBuV/m)	MARGIN (dB)	ANTENNA HEIGHT (m)	TABLE ANGLE (Degree)	RAW VALUE (dBuV)	CORRECTION FACTOR (dB/m)
1	*5580.00	102.4 PK			1.25 V	342	98.8	3.6
2	*5580.00	91.3 AV			1.25 V	342	87.7	3.6
3	11160.00	57.1 PK	74.0	-16.9	1.97 V	341	40.9	16.3
4	11160.00	43.0 AV	54.0	-11.1	1.97 V	341	26.7	16.3

**REMARKS:**

1. Emission Level(dBuV/m) = Raw Value(dBuV) + Correction Factor(dB/m)
2. Correction Factor(dB/m) = Antenna Factor(dB/m) + Cable Factor(dB) – Pre-Amplifier Factor(dB)
3. The other emission levels were very low against the limit.
4. Margin value = Emission Level – Limit value
5. " \* ": Fundamental frequency.

<b>CHANNEL</b>	TX Channel 140	<b>DETECTOR FUNCTION</b>	Peak (PK)
<b>FREQUENCY RANGE</b>	1GHz ~ 40GHz		Average (AV)

**ANTENNA POLARITY & TEST DISTANCE: HORIZONTAL AT 3 M**

NO.	FREQ. (MHz)	EMISSION LEVEL (dBuV/m)	LIMIT (dBuV/m)	MARGIN (dB)	ANTENNA HEIGHT (m)	TABLE ANGLE (Degree)	RAW VALUE (dBuV)	CORRECTION FACTOR (dB/m)
1	*5700.00	99.3 PK			2.41 H	295	95.2	4.1
2	*5700.00	98.2 AV			2.41 H	295	94.0	4.1
3	#5725.00	56.5 PK	68.2	-11.7	2.41 H	295	52.2	4.3
4	11400.00	55.9 PK	74.0	-18.1	1.33 H	311	39.6	16.3
5	11400.00	41.5 AV	54.0	-12.5	1.33 H	311	25.2	16.3

**ANTENNA POLARITY & TEST DISTANCE: VERTICAL AT 3 M**

NO.	FREQ. (MHz)	EMISSION LEVEL (dBuV/m)	LIMIT (dBuV/m)	MARGIN (dB)	ANTENNA HEIGHT (m)	TABLE ANGLE (Degree)	RAW VALUE (dBuV)	CORRECTION FACTOR (dB/m)
1	*5700.00	102.4 PK			1.29 V	338	98.3	4.1
2	*5700.00	91.1 AV			1.29 V	338	87.0	4.1
3	#5725.00	58.6 PK	68.2	-9.6	1.29 V	338	54.3	4.3
4	11400.00	56.9 PK	74.0	-17.1	1.90 V	351	40.7	16.3
5	11400.00	42.7 AV	54.0	-11.3	1.90 V	351	26.5	16.3

**REMARKS:**

1. Emission Level(dBuV/m) = Raw Value(dBuV) + Correction Factor(dB/m)
2. Correction Factor(dB/m) = Antenna Factor(dB/m) + Cable Factor(dB) – Pre-Amplifier Factor(dB)
3. The other emission levels were very low against the limit.
4. Margin value = Emission Level – Limit value
5. " \* ": Fundamental frequency.
6. " # ": The radiated frequency is out of the restricted band.

<b>CHANNEL</b>	TX Channel 144	<b>DETECTOR FUNCTION</b>	Peak (PK)
<b>FREQUENCY RANGE</b>	1GHz ~ 40GHz		Average (AV)

**ANTENNA POLARITY & TEST DISTANCE: HORIZONTAL AT 3 M**

NO.	FREQ. (MHz)	EMISSION LEVEL (dBuV/m)	LIMIT (dBuV/m)	MARGIN (dB)	ANTENNA HEIGHT (m)	TABLE ANGLE (Degree)	RAW VALUE (dBuV)	CORRECTION FACTOR (dB/m)
1	5460.00	55.1 PK	74.0	-18.9	1.61 H	13	50.7	4.4
2	5460.00	42.8 AV	54.0	-11.2	1.61 H	13	50.7	4.4
3	#5470.00	57.1 PK	68.2	-11.1	1.55 H	13	52.7	4.4
4	*5720.00	104.0 PK			1.49 H	9	64.0	40.0
5	#5825.00	55.7 PK	68.2	-12.5	1.63 H	13	50.9	4.8
6	11440.00	53.1 PK	74.0	-20.9	1.73 H	288	35.5	17.6
7	11440.00	41.8 AV	54.0	-15.2	1.73 H	288	35.5	17.6

**ANTENNA POLARITY & TEST DISTANCE: VERTICAL AT 3 M**

NO.	FREQ. (MHz)	EMISSION LEVEL (dBuV/m)	LIMIT (dBuV/m)	MARGIN (dB)	ANTENNA HEIGHT (m)	TABLE ANGLE (Degree)	RAW VALUE (dBuV)	CORRECTION FACTOR (dB/m)
1	5460.00	54.7 PK	74.0	-19.3	1.20 V	10	50.3	4.4
2	5460.00	42.5 AV	54.0	-11.5	1.61 H	13	50.7	4.4
3	#5470.00	56.7 PK	68.2	-11.5	1.15 V	357	52.3	4.4
4	*5720.00	98.7 PK			1.21 V	355	58.7	40.0
5	#5825.00	55.0 PK	68.2	-13.2	1.08 V	2	50.2	4.8
6	11440.00	52.8 PK	74.0	-21.2	1.99 V	211	35.2	17.6
7	11440.00	40.5 AV	54.0	-13.5	1.73 H	288	35.5	17.6

**REMARKS:**

1. Emission Level(dBuV/m) = Raw Value(dBuV) + Correction Factor(dB/m)
2. Correction Factor(dB/m) = Antenna Factor(dB/m) + Cable Factor(dB) – Pre-Amplifier Factor(dB)
3. The other emission levels were very low against the limit.
4. Margin value = Emission Level – Limit value
5. " \* ": Fundamental frequency.
6. " # ": The radiated frequency is out of the restricted band.



<b>CHANNEL</b>	TX Channel 149	<b>DETECTOR FUNCTION</b>	Peak (PK)
<b>FREQUENCY RANGE</b>	1GHz ~ 40GHz		Average (AV)

**ANTENNA POLARITY & TEST DISTANCE: HORIZONTAL AT 3 M**

NO.	FREQ. (MHz)	EMISSION LEVEL (dBuV/m)	LIMIT (dBuV/m)	MARGIN (dB)	ANTENNA HEIGHT (m)	TABLE ANGLE (Degree)	RAW VALUE (dBuV)	CORRECTION FACTOR (dB/m)
1	#5591.92	53.5 PK	68.2	-14.7	2.11 H	284	49.9	3.6
2	*5745.00	99.7 PK			2.11 H	284	95.2	4.5
3	*5745.00	88.4 AV			2.11 H	284	84.0	4.5
4	#5954.57	52.4 PK	68.2	-15.9	2.11 H	284	47.1	5.3
5	11490.00	55.9 PK	74.0	-18.1	1.45 H	284	39.4	16.5
6	11490.00	41.5 AV	54.0	-12.5	1.45 H	284	25.0	16.5

**ANTENNA POLARITY & TEST DISTANCE: VERTICAL AT 3 M**

NO.	FREQ. (MHz)	EMISSION LEVEL (dBuV/m)	LIMIT (dBuV/m)	MARGIN (dB)	ANTENNA HEIGHT (m)	TABLE ANGLE (Degree)	RAW VALUE (dBuV)	CORRECTION FACTOR (dB/m)
1	#5635.93	53.4 PK	68.2	-14.8	1.29 V	336	49.6	3.8
2	*5745.00	102.4 PK			1.29 V	336	97.9	4.5
3	*5745.00	91.2 AV			1.29 V	336	86.8	4.5
4	#5932.37	52.6 PK	68.2	-15.6	1.29 V	336	47.5	5.2
5	11490.00	56.9 PK	74.0	-17.1	1.82 V	334	40.4	16.5
6	11490.00	42.8 AV	54.0	-11.2	1.82 V	334	26.3	16.5

**REMARKS:**

1. Emission Level(dBuV/m) = Raw Value(dBuV) + Correction Factor(dB/m)
2. Correction Factor(dB/m) = Antenna Factor(dB/m) + Cable Factor(dB) – Pre-Amplifier Factor(dB)
3. The other emission levels were very low against the limit.
4. Margin value = Emission Level – Limit value
5. " \* ": Fundamental frequency.
6. " # ": The radiated frequency is out of the restricted band.

<b>CHANNEL</b>	TX Channel 157	<b>DETECTOR FUNCTION</b>	Peak (PK)
<b>FREQUENCY RANGE</b>	1GHz ~ 40GHz		Average (AV)

**ANTENNA POLARITY & TEST DISTANCE: HORIZONTAL AT 3 M**

NO.	FREQ. (MHz)	EMISSION LEVEL (dBuV/m)	LIMIT (dBuV/m)	MARGIN (dB)	ANTENNA HEIGHT (m)	TABLE ANGLE (Degree)	RAW VALUE (dBuV)	CORRECTION FACTOR (dB/m)
1	#5591.92	53.5 PK	68.2	-14.7	2.11 H	284	49.9	3.6
2	#5641.66	52.2 PK	68.2	-16.0	2.28 H	267	48.4	3.8
3	*5785.00	100.4 PK			2.28 H	267	95.6	4.8
4	*5785.00	89.5 AV			2.28 H	267	84.7	4.8
5	#5954.57	52.4 PK	68.2	-15.9	2.11 H	284	47.1	5.3
6	#5969.47	53.9 PK	68.2	-14.3	2.28 H	267	48.6	5.3
7	11570.00	56.2 PK	74.0	-17.8	1.59 H	244	39.6	16.6
8	11570.00	41.8 AV	54.0	-12.2	1.59 H	244	25.2	16.6

**ANTENNA POLARITY & TEST DISTANCE: VERTICAL AT 3 M**

NO.	FREQ. (MHz)	EMISSION LEVEL (dBuV/m)	LIMIT (dBuV/m)	MARGIN (dB)	ANTENNA HEIGHT (m)	TABLE ANGLE (Degree)	RAW VALUE (dBuV)	CORRECTION FACTOR (dB/m)
1	#5638.87	53.2 PK	68.2	-15.0	1.20 V	336	49.4	3.8
2	*5785.00	103.2 PK			1.20 V	336	98.4	4.8
3	*5785.00	92.3 AV			1.20 V	336	87.5	4.8
4	#5970.78	53.9 PK	68.2	-14.3	1.20 V	336	48.6	5.3
5	11570.00	57.1 PK	74.0	-16.9	1.69 V	329	40.5	16.6
6	11570.00	43.0 AV	54.0	-11.0	1.69 V	329	26.4	16.6

**REMARKS:**

1. Emission Level(dBuV/m) = Raw Value(dBuV) + Correction Factor(dB/m)
2. Correction Factor(dB/m) = Antenna Factor(dB/m) + Cable Factor(dB) – Pre-Amplifier Factor(dB)
3. The other emission levels were very low against the limit.
4. Margin value = Emission Level – Limit value
5. " \* ": Fundamental frequency.
6. " # ": The radiated frequency is out of the restricted band.

<b>CHANNEL</b>	TX Channel 165	<b>DETECTOR FUNCTION</b>	Peak (PK)
<b>FREQUENCY RANGE</b>	1GHz ~ 40GHz		Average (AV)

**ANTENNA POLARITY & TEST DISTANCE: HORIZONTAL AT 3 M**

NO.	FREQ. (MHz)	EMISSION LEVEL (dBuV/m)	LIMIT (dBuV/m)	MARGIN (dB)	ANTENNA HEIGHT (m)	TABLE ANGLE (Degree)	RAW VALUE (dBuV)	CORRECTION FACTOR (dB/m)
1	#5632.48	52.3 PK	68.2	-15.9	2.27 H	291	48.6	3.7
2	*5825.00	100.4 PK			2.27 H	291	95.4	5.0
3	*5825.00	89.6 AV			2.27 H	291	84.6	5.0
4	#5971.38	52.7 PK	68.2	-15.5	2.27 H	291	47.4	5.3
5	11650.00	55.8 PK	74.0	-18.2	1.64 H	238	39.4	16.4
6	11650.00	41.4 AV	54.0	-12.6	1.64 H	238	25.0	16.4

**ANTENNA POLARITY & TEST DISTANCE: VERTICAL AT 3 M**

NO.	FREQ. (MHz)	EMISSION LEVEL (dBuV/m)	LIMIT (dBuV/m)	MARGIN (dB)	ANTENNA HEIGHT (m)	TABLE ANGLE (Degree)	RAW VALUE (dBuV)	CORRECTION FACTOR (dB/m)
1	#5634.85	54.4 PK	68.2	-13.8	1.20 V	335	50.6	3.8
2	*5825.00	103.2 PK			1.20 V	335	98.3	5.0
3	*5825.00	91.8 AV			1.20 V	335	86.8	5.0
4	#5958.13	52.6 PK	68.2	-15.6	1.20 V	335	47.3	5.3
5	11650.00	56.8 PK	74.0	-17.2	1.58 V	334	40.4	16.4
6	11650.00	42.6 AV	54.0	-11.4	1.58 V	334	26.3	16.4

**REMARKS:**

1. Emission Level(dBuV/m) = Raw Value(dBuV) + Correction Factor(dB/m)
2. Correction Factor(dB/m) = Antenna Factor(dB/m) + Cable Factor(dB) – Pre-Amplifier Factor(dB)
3. The other emission levels were very low against the limit.
4. Margin value = Emission Level – Limit value
5. " \* ": Fundamental frequency.
6. " # ": The radiated frequency is out of the restricted band.

802.11n (HT20)

<b>CHANNEL</b>	TX Channel 36	<b>DETECTOR FUNCTION</b>	Peak (PK)
<b>FREQUENCY RANGE</b>	1GHz ~ 40GHz		Average (AV)

**ANTENNA POLARITY & TEST DISTANCE: HORIZONTAL AT 3 M**

NO.	FREQ. (MHz)	EMISSION LEVEL (dBuV/m)	LIMIT (dBuV/m)	MARGIN (dB)	ANTENNA HEIGHT (m)	TABLE ANGLE (Degree)	RAW VALUE (dBuV)	CORRECTION FACTOR (dB/m)
1	5150.00	54.2 PK	74.0	-19.8	2.27 H	325	50.6	3.7
2	5150.00	41.7 AV	54.0	-12.3	2.27 H	325	38.0	3.7
3	*5180.00	97.5 PK			2.27 H	325	94.1	3.4
4	*5180.00	85.8 AV			2.27 H	325	82.4	3.4
5	#10360.00	53.5 PK	74.0	-20.5	1.48 H	257	38.8	14.7
6	#10360.00	39.8 AV	54.0	-14.2	1.48 H	257	25.1	14.7

**ANTENNA POLARITY & TEST DISTANCE: VERTICAL AT 3 M**

NO.	FREQ. (MHz)	EMISSION LEVEL (dBuV/m)	LIMIT (dBuV/m)	MARGIN (dB)	ANTENNA HEIGHT (m)	TABLE ANGLE (Degree)	RAW VALUE (dBuV)	CORRECTION FACTOR (dB/m)
1	5150.00	55.8 PK	74.0	-18.2	1.23 V	25	52.2	3.7
2	5150.00	42.7 AV	54.0	-11.3	1.23 V	25	39.0	3.7
3	*5180.00	99.7 PK			1.23 V	25	96.3	3.4
4	*5180.00	88.2 AV			1.23 V	25	84.8	3.4
5	#10360.00	54.9 PK	74.0	-19.1	1.78 V	295	40.2	14.7
6	#10360.00	41.4 AV	54.0	-12.6	1.78 V	295	26.7	14.7

**REMARKS:**

1. Emission Level(dBuV/m) = Raw Value(dBuV) + Correction Factor(dB/m)
2. Correction Factor(dB/m) = Antenna Factor(dB/m) + Cable Factor(dB) – Pre-Amplifier Factor(dB)
3. The other emission levels were very low against the limit.
4. Margin value = Emission Level – Limit value
5. " \* ": Fundamental frequency.
6. " # ": The radiated frequency is out of the restricted band.

<b>CHANNEL</b>	TX Channel 40	<b>DETECTOR FUNCTION</b>	Peak (PK)
<b>FREQUENCY RANGE</b>	1GHz ~ 40GHz		Average (AV)

**ANTENNA POLARITY & TEST DISTANCE: HORIZONTAL AT 3 M**

NO.	FREQ. (MHz)	EMISSION LEVEL (dBuV/m)	LIMIT (dBuV/m)	MARGIN (dB)	ANTENNA HEIGHT (m)	TABLE ANGLE (Degree)	RAW VALUE (dBuV)	CORRECTION FACTOR (dB/m)
1	*5200.00	97.2 PK			2.28 H	352	94.0	3.2
2	*5200.00	85.5 AV			2.28 H	352	82.3	3.2
3	#10400.00	54.6 PK	74.0	-19.4	1.51 H	261	39.7	14.9
4	#10400.00	40.0 AV	54.0	-14.0	1.51 H	261	25.0	14.9

**ANTENNA POLARITY & TEST DISTANCE: VERTICAL AT 3 M**

NO.	FREQ. (MHz)	EMISSION LEVEL (dBuV/m)	LIMIT (dBuV/m)	MARGIN (dB)	ANTENNA HEIGHT (m)	TABLE ANGLE (Degree)	RAW VALUE (dBuV)	CORRECTION FACTOR (dB/m)
1	*5200.00	99.2 PK			1.15 V	24	96.0	3.2
2	*5200.00	87.7 AV			1.15 V	24	84.5	3.2
3	#10400.00	55.0 PK	74.0	-19.0	1.82 V	303	40.0	14.9
4	#10400.00	41.6 AV	54.0	-12.4	1.82 V	303	26.7	14.9

**REMARKS:**

1. Emission Level(dBuV/m) = Raw Value(dBuV) + Correction Factor(dB/m)
2. Correction Factor(dB/m) = Antenna Factor(dB/m) + Cable Factor(dB) – Pre-Amplifier Factor(dB)
3. The other emission levels were very low against the limit.
4. Margin value = Emission Level – Limit value
5. " \* ": Fundamental frequency.
6. " # ": The radiated frequency is out of the restricted band.

<b>CHANNEL</b>	TX Channel 48	<b>DETECTOR FUNCTION</b>	Peak (PK)
<b>FREQUENCY RANGE</b>	1GHz ~ 40GHz		Average (AV)

**ANTENNA POLARITY & TEST DISTANCE: HORIZONTAL AT 3 M**

NO.	FREQ. (MHz)	EMISSION LEVEL (dBuV/m)	LIMIT (dBuV/m)	MARGIN (dB)	ANTENNA HEIGHT (m)	TABLE ANGLE (Degree)	RAW VALUE (dBuV)	CORRECTION FACTOR (dB/m)
1	*5240.00	97.3 PK			2.31 H	326	94.3	3.0
2	*5240.00	85.5 AV			2.31 H	326	82.5	3.0
3	5350.00	52.0 PK	74.0	-22.0	2.31 H	326	49.1	2.9
4	5350.00	39.0 AV	54.0	-15.0	2.31 H	326	36.1	2.9
5	#10480.00	54.5 PK	74.0	-19.5	1.51 H	255	39.0	15.5
6	#10480.00	40.7 AV	54.0	-13.3	1.51 H	255	25.2	15.5

**ANTENNA POLARITY & TEST DISTANCE: VERTICAL AT 3 M**

NO.	FREQ. (MHz)	EMISSION LEVEL (dBuV/m)	LIMIT (dBuV/m)	MARGIN (dB)	ANTENNA HEIGHT (m)	TABLE ANGLE (Degree)	RAW VALUE (dBuV)	CORRECTION FACTOR (dB/m)
1	*5240.00	99.3 PK			1.14 V	25	96.3	3.0
2	*5240.00	88.1 AV			1.14 V	25	85.1	3.0
3	5350.00	53.3 PK	74.0	-20.7	1.14 V	25	50.4	2.9
4	5350.00	40.2 AV	54.0	-13.8	1.14 V	25	37.3	2.9
5	#10480.00	55.8 PK	74.0	-18.2	1.72 V	300	40.3	15.5
6	#10480.00	42.3 AV	54.0	-11.7	1.72 V	300	26.8	15.5

**REMARKS:**

1. Emission Level(dBuV/m) = Raw Value(dBuV) + Correction Factor(dB/m)
2. Correction Factor(dB/m) = Antenna Factor(dB/m) + Cable Factor(dB) – Pre-Amplifier Factor(dB)
3. The other emission levels were very low against the limit.
4. Margin value = Emission Level – Limit value
5. " \* ": Fundamental frequency.
6. " # ": The radiated frequency is out of the restricted band.

<b>CHANNEL</b>	TX Channel 52	<b>DETECTOR FUNCTION</b>	Peak (PK)
<b>FREQUENCY RANGE</b>	1GHz ~ 40GHz		Average (AV)

**ANTENNA POLARITY & TEST DISTANCE: HORIZONTAL AT 3 M**

NO.	FREQ. (MHz)	EMISSION LEVEL (dBuV/m)	LIMIT (dBuV/m)	MARGIN (dB)	ANTENNA HEIGHT (m)	TABLE ANGLE (Degree)	RAW VALUE (dBuV)	CORRECTION FACTOR (dB/m)
1	5150.00	53.3 PK	74.0	-20.7	2.33 H	319	49.7	3.7
2	5150.00	40.8 AV	54.0	-13.2	2.33 H	319	37.2	3.7
3	*5260.00	97.4 PK			2.33 H	319	94.5	2.9
4	*5260.00	85.7 AV			2.33 H	319	82.8	2.9
5	#10520.00	54.5 PK	74.0	-19.5	1.54 H	261	38.8	15.6
6	#10520.00	40.8 AV	54.0	-13.2	1.54 H	261	25.2	15.6

**ANTENNA POLARITY & TEST DISTANCE: VERTICAL AT 3 M**

NO.	FREQ. (MHz)	EMISSION LEVEL (dBuV/m)	LIMIT (dBuV/m)	MARGIN (dB)	ANTENNA HEIGHT (m)	TABLE ANGLE (Degree)	RAW VALUE (dBuV)	CORRECTION FACTOR (dB/m)
1	5150.00	54.8 PK	74.0	-19.2	1.00 V	25	51.1	3.7
2	5150.00	41.9 AV	54.0	-12.1	1.00 V	25	38.3	3.7
3	*5260.00	99.4 PK			1.00 V	25	96.5	2.9
4	*5260.00	88.1 AV			1.00 V	25	85.2	2.9
5	#10520.00	55.9 PK	74.0	-18.1	1.80 V	321	40.2	15.6
6	#10520.00	42.4 AV	54.0	-11.6	1.80 V	321	26.8	15.6

**REMARKS:**

1. Emission Level(dBuV/m) = Raw Value(dBuV) + Correction Factor(dB/m)
2. Correction Factor(dB/m) = Antenna Factor(dB/m) + Cable Factor(dB) – Pre-Amplifier Factor(dB)
3. The other emission levels were very low against the limit.
4. Margin value = Emission Level – Limit value
5. " \* ": Fundamental frequency.
6. " # ": The radiated frequency is out of the restricted band.

<b>CHANNEL</b>	TX Channel 60	<b>DETECTOR FUNCTION</b>	Peak (PK)
<b>FREQUENCY RANGE</b>	1GHz ~ 40GHz		Average (AV)

**ANTENNA POLARITY & TEST DISTANCE: HORIZONTAL AT 3 M**

NO.	FREQ. (MHz)	EMISSION LEVEL (dBuV/m)	LIMIT (dBuV/m)	MARGIN (dB)	ANTENNA HEIGHT (m)	TABLE ANGLE (Degree)	RAW VALUE (dBuV)	CORRECTION FACTOR (dB/m)
1	*5300.00	97.1 PK			2.51 H	315	94.3	2.8
2	*5300.00	85.4 AV			2.51 H	315	82.6	2.8
3	10600.00	54.2 PK	74.0	-19.8	1.59 H	270	38.7	15.6
4	10600.00	40.6 AV	54.0	-13.4	1.59 H	270	25.0	15.6

**ANTENNA POLARITY & TEST DISTANCE: VERTICAL AT 3 M**

NO.	FREQ. (MHz)	EMISSION LEVEL (dBuV/m)	LIMIT (dBuV/m)	MARGIN (dB)	ANTENNA HEIGHT (m)	TABLE ANGLE (Degree)	RAW VALUE (dBuV)	CORRECTION FACTOR (dB/m)
1	*5300.00	99.1 PK			1.12 V	32	96.3	2.8
2	*5300.00	88.2 AV			1.12 V	32	85.4	2.8
3	10600.00	55.7 PK	74.0	-18.3	1.89 V	314	40.2	15.6
4	10600.00	42.2 AV	54.0	-11.8	1.89 V	314	26.7	15.6

**REMARKS:**

1. Emission Level(dBuV/m) = Raw Value(dBuV) + Correction Factor(dB/m)
2. Correction Factor(dB/m) = Antenna Factor(dB/m) + Cable Factor(dB) – Pre-Amplifier Factor(dB)
3. The other emission levels were very low against the limit.
4. Margin value = Emission Level – Limit value
5. " \* ": Fundamental frequency.



<b>CHANNEL</b>	TX Channel 64	<b>DETECTOR FUNCTION</b>	Peak (PK)
<b>FREQUENCY RANGE</b>	1GHz ~ 40GHz		Average (AV)

**ANTENNA POLARITY & TEST DISTANCE: HORIZONTAL AT 3 M**

NO.	FREQ. (MHz)	EMISSION LEVEL (dBuV/m)	LIMIT (dBuV/m)	MARGIN (dB)	ANTENNA HEIGHT (m)	TABLE ANGLE (Degree)	RAW VALUE (dBuV)	CORRECTION FACTOR (dB/m)
1	*5320.00	98.1 PK			2.41 H	333	95.3	2.8
2	*5320.00	86.5 AV			2.41 H	333	83.7	2.8
3	5350.00	51.7 PK	74.0	-22.4	2.41 H	333	48.7	2.9
4	5350.00	39.8 AV	54.0	-14.2	2.41 H	333	36.9	2.9
5	10640.00	54.4 PK	74.0	-19.6	1.61 H	264	39.0	15.5
6	10640.00	40.8 AV	54.0	-13.2	1.61 H	264	25.3	15.5

**ANTENNA POLARITY & TEST DISTANCE: VERTICAL AT 3 M**

NO.	FREQ. (MHz)	EMISSION LEVEL (dBuV/m)	LIMIT (dBuV/m)	MARGIN (dB)	ANTENNA HEIGHT (m)	TABLE ANGLE (Degree)	RAW VALUE (dBuV)	CORRECTION FACTOR (dB/m)
1	*5320.00	100.7 PK			1.12 V	32	97.9	2.8
2	*5320.00	88.6 AV			1.12 V	32	85.8	2.8
3	5350.00	53.4 PK	74.0	-20.7	1.12 V	32	50.4	2.9
4	5350.00	41.0 AV	54.0	-13.0	1.12 V	32	38.1	2.9
5	10640.00	55.8 PK	74.0	-18.2	1.72 V	324	40.4	15.5
6	10640.00	42.4 AV	54.0	-11.6	1.72 V	324	26.9	15.5

**REMARKS:**

1. Emission Level(dBuV/m) = Raw Value(dBuV) + Correction Factor(dB/m)
2. Correction Factor(dB/m) = Antenna Factor(dB/m) + Cable Factor(dB) – Pre-Amplifier Factor(dB)
3. The other emission levels were very low against the limit.
4. Margin value = Emission Level – Limit value
5. " \* ": Fundamental frequency.

<b>CHANNEL</b>	TX Channel 100	<b>DETECTOR FUNCTION</b>	Peak (PK)
<b>FREQUENCY RANGE</b>	1GHz ~ 40GHz		Average (AV)

**ANTENNA POLARITY & TEST DISTANCE: HORIZONTAL AT 3 M**

NO.	FREQ. (MHz)	EMISSION LEVEL (dBuV/m)	LIMIT (dBuV/m)	MARGIN (dB)	ANTENNA HEIGHT (m)	TABLE ANGLE (Degree)	RAW VALUE (dBuV)	CORRECTION FACTOR (dB/m)
1	5460.00	52.9 PK	74.0	-21.1	1.89 H	322	49.6	3.3
2	5460.00	40.7 AV	54.0	-13.3	1.89 H	322	37.5	3.3
3	#5470.00	55.1 PK	68.2	-13.1	1.89 H	322	51.8	3.3
4	*5500.00	97.6 PK			1.89 H	322	94.4	3.2
5	*5500.00	86.1 AV			1.89 H	322	82.9	3.2
6	11000.00	54.9 PK	74.0	-19.1	1.68 H	246	39.0	15.9
7	11000.00	41.2 AV	54.0	-12.9	1.68 H	246	25.3	15.9

**ANTENNA POLARITY & TEST DISTANCE: VERTICAL AT 3 M**

NO.	FREQ. (MHz)	EMISSION LEVEL (dBuV/m)	LIMIT (dBuV/m)	MARGIN (dB)	ANTENNA HEIGHT (m)	TABLE ANGLE (Degree)	RAW VALUE (dBuV)	CORRECTION FACTOR (dB/m)
1	5460.00	54.5 PK	74.0	-19.5	1.25 V	346	51.2	3.3
2	5460.00	42.2 AV	54.0	-11.8	1.25 V	346	39.0	3.3
3	#5470.00	55.9 PK	68.2	-12.3	1.25 V	346	52.7	3.3
4	*5500.00	99.8 PK			1.25 V	346	96.6	3.2
5	*5500.00	88.7 AV			1.25 V	346	85.5	3.2
6	11000.00	56.2 PK	74.0	-17.8	1.96 V	271	40.3	15.9
7	11000.00	42.7 AV	54.0	-11.3	1.96 V	271	26.8	15.9

**REMARKS:**

1. Emission Level(dBuV/m) = Raw Value(dBuV) + Correction Factor(dB/m)
2. Correction Factor(dB/m) = Antenna Factor(dB/m) + Cable Factor(dB) – Pre-Amplifier Factor(dB)
3. The other emission levels were very low against the limit.
4. Margin value = Emission Level – Limit value
5. " \* ": Fundamental frequency.
6. " # ": The radiated frequency is out of the restricted band.

<b>CHANNEL</b>	TX Channel 116	<b>DETECTOR FUNCTION</b>	Peak (PK)
<b>FREQUENCY RANGE</b>	1GHz ~ 40GHz		Average (AV)

**ANTENNA POLARITY & TEST DISTANCE: HORIZONTAL AT 3 M**

NO.	FREQ. (MHz)	EMISSION LEVEL (dBuV/m)	LIMIT (dBuV/m)	MARGIN (dB)	ANTENNA HEIGHT (m)	TABLE ANGLE (Degree)	RAW VALUE (dBuV)	CORRECTION FACTOR (dB/m)
1	*5580.00	99.0 PK			1.88 H	325	95.4	3.6
2	*5580.00	87.5 AV			1.88 H	325	83.9	3.6
3	11160.00	55.5 PK	74.0	-18.5	1.70 H	248	39.3	16.3
4	11160.00	41.7 AV	54.0	-12.3	1.70 H	248	25.5	16.3

**ANTENNA POLARITY & TEST DISTANCE: VERTICAL AT 3 M**

NO.	FREQ. (MHz)	EMISSION LEVEL (dBuV/m)	LIMIT (dBuV/m)	MARGIN (dB)	ANTENNA HEIGHT (m)	TABLE ANGLE (Degree)	RAW VALUE (dBuV)	CORRECTION FACTOR (dB/m)
1	*5580.00	101.4 PK			1.24 V	343	97.8	3.6
2	*5580.00	90.5 AV			1.24 V	343	87.0	3.6
3	11160.00	56.8 PK	74.0	-17.2	1.95 V	282	40.5	16.3
4	11160.00	43.3 AV	54.0	-10.8	1.95 V	282	27.0	16.3

**REMARKS:**

1. Emission Level(dBuV/m) = Raw Value(dBuV) + Correction Factor(dB/m)
2. Correction Factor(dB/m) = Antenna Factor(dB/m) + Cable Factor(dB) – Pre-Amplifier Factor(dB)
3. The other emission levels were very low against the limit.
4. Margin value = Emission Level – Limit value
5. " \* ": Fundamental frequency.

<b>CHANNEL</b>	TX Channel 140	<b>DETECTOR FUNCTION</b>	Peak (PK)
<b>FREQUENCY RANGE</b>	1GHz ~ 40GHz		Average (AV)

**ANTENNA POLARITY & TEST DISTANCE: HORIZONTAL AT 3 M**

NO.	FREQ. (MHz)	EMISSION LEVEL (dBuV/m)	LIMIT (dBuV/m)	MARGIN (dB)	ANTENNA HEIGHT (m)	TABLE ANGLE (Degree)	RAW VALUE (dBuV)	CORRECTION FACTOR (dB/m)
1	*5700.00	99.1 PK			1.14 H	338	95.0	4.1
2	*5700.00	87.5 AV			1.14 H	338	83.4	4.1
3	#5725.00	56.2 PK	68.2	-12.0	1.14 H	338	51.9	4.3
4	11400.00	55.3 PK	74.0	-18.7	2.04 H	277	39.0	16.3
5	11400.00	41.5 AV	54.0	-12.5	2.04 H	277	25.3	16.3

**ANTENNA POLARITY & TEST DISTANCE: VERTICAL AT 3 M**

NO.	FREQ. (MHz)	EMISSION LEVEL (dBuV/m)	LIMIT (dBuV/m)	MARGIN (dB)	ANTENNA HEIGHT (m)	TABLE ANGLE (Degree)	RAW VALUE (dBuV)	CORRECTION FACTOR (dB/m)
1	*5700.00	100.9 PK			1.14 V	338	96.8	4.1
2	*5700.00	90.4 AV			1.14 V	338	86.2	4.1
3	#5725.00	58.0 PK	68.2	-10.2	1.14 V	338	53.7	4.3
4	11400.00	56.5 PK	74.0	-17.5	2.04 V	277	40.3	16.3
5	11400.00	42.9 AV	54.0	-11.1	2.04 V	277	26.7	16.3

**REMARKS:**

1. Emission Level(dBuV/m) = Raw Value(dBuV) + Correction Factor(dB/m)
2. Correction Factor(dB/m) = Antenna Factor(dB/m) + Cable Factor(dB) – Pre-Amplifier Factor(dB)
3. The other emission levels were very low against the limit.
4. Margin value = Emission Level – Limit value
5. " \* ": Fundamental frequency.
6. " # ": The radiated frequency is out of the restricted band.

<b>CHANNEL</b>	TX Channel 144	<b>DETECTOR FUNCTION</b>	Peak (PK)
<b>FREQUENCY RANGE</b>	1GHz ~ 40GHz		Average (AV)

**ANTENNA POLARITY & TEST DISTANCE: HORIZONTAL AT 3 M**

NO.	FREQ. (MHz)	EMISSION LEVEL (dBuV/m)	LIMIT (dBuV/m)	MARGIN (dB)	ANTENNA HEIGHT (m)	TABLE ANGLE (Degree)	RAW VALUE (dBuV)	CORRECTION FACTOR (dB/m)
1	5460.00	54.7 PK	74.0	-19.3	1.53 H	7	50.3	4.4
2	5460.00	42.5 AV	54.0	-11.5	1.53 H	7	50.3	4.4
3	#5470.00	56.8 PK	68.2	-11.4	1.66 H	11	52.4	4.4
4	*5720.00	103.1 PK			1.60 H	9	63.1	40.0
5	#5825.00	55.9 PK	68.2	-12.3	1.69 H	15	51.1	4.8
6	11440.00	53.7 PK	74.0	-18.1	1.99 H	263	36.1	17.6
7	11440.00	40.7 AV	54.0	-13.3	1.99 H	263	36.1	17.6

**ANTENNA POLARITY & TEST DISTANCE: VERTICAL AT 3 M**

NO.	FREQ. (MHz)	EMISSION LEVEL (dBuV/m)	LIMIT (dBuV/m)	MARGIN (dB)	ANTENNA HEIGHT (m)	TABLE ANGLE (Degree)	RAW VALUE (dBuV)	CORRECTION FACTOR (dB/m)
1	5460.00	54.5 PK	74.0	-19.5	1.11 V	359	50.1	4.4
2	5460.00	42.3 AV	54.0	-11.7	1.53 H	7	50.3	4.4
3	#5470.00	56.5 PK	68.2	-11.7	1.05 V	359	52.1	4.4
4	*5720.00	97.9 PK			1.15 V	355	57.9	40.0
5	#5825.00	55.5 PK	68.2	-12.7	1.13 V	4	50.7	4.8
6	11440.00	53.3 PK	74.0	-18.5	1.83 V	220	35.7	17.6
7	11440.00	41.1 AV	54.0	-12.9	1.99 H	263	36.1	17.6

**REMARKS:**

1. Emission Level(dBuV/m) = Raw Value(dBuV) + Correction Factor(dB/m)
2. Correction Factor(dB/m) = Antenna Factor(dB/m) + Cable Factor(dB) – Pre-Amplifier Factor(dB)
3. The other emission levels were very low against the limit.
4. Margin value = Emission Level – Limit value
5. " \* ": Fundamental frequency.
6. " # ": The radiated frequency is out of the restricted band.

<b>CHANNEL</b>	TX Channel 149	<b>DETECTOR FUNCTION</b>	Peak (PK)
<b>FREQUENCY RANGE</b>	1GHz ~ 40GHz		Average (AV)

**ANTENNA POLARITY & TEST DISTANCE: HORIZONTAL AT 3 M**

NO.	FREQ. (MHz)	EMISSION LEVEL (dBuV/m)	LIMIT (dBuV/m)	MARGIN (dB)	ANTENNA HEIGHT (m)	TABLE ANGLE (Degree)	RAW VALUE (dBuV)	CORRECTION FACTOR (dB/m)
1	#5644.01	53.2 PK	68.2	-15.0	2.48 H	311	49.4	3.8
2	*5745.00	98.7 PK			2.48 H	311	94.3	4.5
3	*5745.00	87.0 AV			2.48 H	311	82.6	4.5
4	#5945.54	52.8 PK	68.2	-15.4	2.48 H	311	47.6	5.2
5	11490.00	55.4 PK	74.0	-18.6	1.67 H	302	38.9	16.5
6	11490.00	41.8 AV	54.0	-12.2	1.67 H	302	25.3	16.5

**ANTENNA POLARITY & TEST DISTANCE: VERTICAL AT 3 M**

NO.	FREQ. (MHz)	EMISSION LEVEL (dBuV/m)	LIMIT (dBuV/m)	MARGIN (dB)	ANTENNA HEIGHT (m)	TABLE ANGLE (Degree)	RAW VALUE (dBuV)	CORRECTION FACTOR (dB/m)
1	#5620.29	52.6 PK	68.2	-15.6	1.14 V	336	48.9	3.7
2	*5745.00	101.1 PK			1.14 V	336	96.6	4.5
3	*5745.00	90.0 AV			1.14 V	336	85.5	4.5
4	#5947.39	53.0 PK	68.2	-15.3	1.14 V	336	47.7	5.2
5	11490.00	56.8 PK	74.0	-17.2	1.42 V	263	40.3	16.5
6	11490.00	43.3 AV	54.0	-10.7	1.42 V	263	26.8	16.5

**REMARKS:**

1. Emission Level(dBuV/m) = Raw Value(dBuV) + Correction Factor(dB/m)
2. Correction Factor(dB/m) = Antenna Factor(dB/m) + Cable Factor(dB) – Pre-Amplifier Factor(dB)
3. The other emission levels were very low against the limit.
4. Margin value = Emission Level – Limit value
5. " \* ": Fundamental frequency.
6. " # ": The radiated frequency is out of the restricted band.

<b>CHANNEL</b>	TX Channel 157	<b>DETECTOR FUNCTION</b>	Peak (PK)
<b>FREQUENCY RANGE</b>	1GHz ~ 40GHz		Average (AV)

**ANTENNA POLARITY & TEST DISTANCE: HORIZONTAL AT 3 M**

NO.	FREQ. (MHz)	EMISSION LEVEL (dBuV/m)	LIMIT (dBuV/m)	MARGIN (dB)	ANTENNA HEIGHT (m)	TABLE ANGLE (Degree)	RAW VALUE (dBuV)	CORRECTION FACTOR (dB/m)
1	#5646.85	53.0 PK	68.2	-15.2	2.57 H	308	49.2	3.8
2	*5785.00	99.1 PK			2.57 H	308	94.3	4.8
3	*5785.00	87.4 AV			2.57 H	308	82.6	4.8
4	#5966.92	52.7 PK	68.2	-15.5	2.57 H	308	47.4	5.3
5	11570.00	58.12 PK	74.0	-15.88	1.72 H	300	25.3	16.6
6	11570.00	50.8 AV	54.0	-3.2	1.72 H	300	39.0	16.6

**ANTENNA POLARITY & TEST DISTANCE: VERTICAL AT 3 M**

NO.	FREQ. (MHz)	EMISSION LEVEL (dBuV/m)	LIMIT (dBuV/m)	MARGIN (dB)	ANTENNA HEIGHT (m)	TABLE ANGLE (Degree)	RAW VALUE (dBuV)	CORRECTION FACTOR (dB/m)
1	#5613.25	52.3 PK	68.2	-15.9	1.34 V	337	48.6	3.7
2	*5785.00	101.5 PK			1.34 V	334	96.8	4.8
3	*5785.00	90.5 AV			1.34 V	334	85.8	4.8
4	#5988.31	54.4 PK	68.2	-13.8	1.34 V	337	49.0	5.4
5	11570.00	57.44 PK	74.0	-4.31	1.48 V	271	36.9	16.6
6	11570.00	51.81 AV	54.0	-18.68	1.48 V	271	40.4	16.6

**REMARKS:**

1. Emission Level(dBuV/m) = Raw Value(dBuV) + Correction Factor(dB/m)
2. Correction Factor(dB/m) = Antenna Factor(dB/m) + Cable Factor(dB) – Pre-Amplifier Factor(dB)
3. The other emission levels were very low against the limit.
4. Margin value = Emission Level – Limit value
5. " \* ": Fundamental frequency.
6. " # ": The radiated frequency is out of the restricted band.

<b>CHANNEL</b>	TX Channel 165	<b>DETECTOR FUNCTION</b>	Peak (PK)
<b>FREQUENCY RANGE</b>	1GHz ~ 40GHz		Average (AV)

**ANTENNA POLARITY & TEST DISTANCE: HORIZONTAL AT 3 M**

NO.	FREQ. (MHz)	EMISSION LEVEL (dBuV/m)	LIMIT (dBuV/m)	MARGIN (dB)	ANTENNA HEIGHT (m)	TABLE ANGLE (Degree)	RAW VALUE (dBuV)	CORRECTION FACTOR (dB/m)
1	#5626.49	55.0 PK	68.2	-13.2	2.53 H	308	51.3	3.7
2	*5825.00	100.3 PK			2.53 H	308	95.3	5.0
3	*5825.00	88.7 AV			2.53 H	308	83.7	5.0
4	#5939.84	53.7 PK	68.2	-14.5	2.53 H	308	48.5	5.2
5	11650.00	55.4 PK	74.0	-18.6	1.81 H	289	39.0	16.4
6	11650.00	41.8 AV	54.0	-12.2	1.81 H	289	25.4	16.4

**ANTENNA POLARITY & TEST DISTANCE: VERTICAL AT 3 M**

NO.	FREQ. (MHz)	EMISSION LEVEL (dBuV/m)	LIMIT (dBuV/m)	MARGIN (dB)	ANTENNA HEIGHT (m)	TABLE ANGLE (Degree)	RAW VALUE (dBuV)	CORRECTION FACTOR (dB/m)
1	#5640.63	52.1 PK	68.2	-16.1	1.27 V	335	48.3	3.8
2	*5825.00	102.4 PK			1.27 V	335	97.5	5.0
3	*5825.00	91.5 AV			1.27 V	335	86.5	5.0
4	#5938.84	53.4 PK	68.2	-14.8	1.27 V	335	48.2	5.2
5	11650.00	56.9 PK	74.0	-17.1	1.44 V	272	40.6	16.4
6	11650.00	43.3 AV	54.0	-10.7	1.44 V	272	26.9	16.4

**REMARKS:**

1. Emission Level(dBuV/m) = Raw Value(dBuV) + Correction Factor(dB/m)
2. Correction Factor(dB/m) = Antenna Factor(dB/m) + Cable Factor(dB) – Pre-Amplifier Factor(dB)
3. The other emission levels were very low against the limit.
4. Margin value = Emission Level – Limit value
5. " \* ": Fundamental frequency.
6. " # ": The radiated frequency is out of the restricted band.



802.11n (HT40)

<b>CHANNEL</b>	TX Channel 38	<b>DETECTOR FUNCTION</b>	Peak (PK)
<b>FREQUENCY RANGE</b>	1GHz ~ 40GHz		Average (AV)

**ANTENNA POLARITY & TEST DISTANCE: HORIZONTAL AT 3 M**

NO.	FREQ. (MHz)	EMISSION LEVEL (dBuV/m)	LIMIT (dBuV/m)	MARGIN (dB)	ANTENNA HEIGHT (m)	TABLE ANGLE (Degree)	RAW VALUE (dBuV)	CORRECTION FACTOR (dB/m)
1	5150.00	56.1 PK	74.0	-17.9	2.39 H	292	52.4	3.7
2	5150.00	41.2 AV	54.0	-12.8	2.39 H	292	37.5	3.7
3	*5190.00	94.5 PK			2.39 H	292	91.2	3.3
4	*5190.00	83.8 AV			2.39 H	292	80.5	3.3
5	#10380.00	54.1 PK	74.0	-19.9	1.22 H	285	39.3	14.8
6	#10380.00	39.8 AV	54.0	-14.2	1.22 H	285	25.0	14.8

**ANTENNA POLARITY & TEST DISTANCE: VERTICAL AT 3 M**

NO.	FREQ. (MHz)	EMISSION LEVEL (dBuV/m)	LIMIT (dBuV/m)	MARGIN (dB)	ANTENNA HEIGHT (m)	TABLE ANGLE (Degree)	RAW VALUE (dBuV)	CORRECTION FACTOR (dB/m)
1	5150.00	56.9 PK	74.0	-17.1	1.46 V	26	53.2	3.7
2	5150.00	42.4 AV	54.0	-11.6	1.46 V	26	38.7	3.7
3	*5190.00	96.9 PK			1.46 V	26	93.6	3.3
4	*5190.00	86.0 AV			1.46 V	26	82.7	3.3
5	#10380.00	55.4 PK	74.0	-18.6	1.57 V	134	40.6	14.8
6	#10380.00	41.2 AV	54.0	-12.9	1.57 V	134	26.3	14.8

**REMARKS:**

1. Emission Level(dBuV/m) = Raw Value(dBuV) + Correction Factor(dB/m)
2. Correction Factor(dB/m) = Antenna Factor(dB/m) + Cable Factor(dB) – Pre-Amplifier Factor(dB)
3. The other emission levels were very low against the limit.
4. Margin value = Emission Level – Limit value
5. " \* ": Fundamental frequency.
6. " # ": The radiated frequency is out of the restricted band.

<b>CHANNEL</b>	TX Channel 46	<b>DETECTOR FUNCTION</b>	Peak (PK)
<b>FREQUENCY RANGE</b>	1GHz ~ 40GHz		Average (AV)

**ANTENNA POLARITY & TEST DISTANCE: HORIZONTAL AT 3 M**

NO.	FREQ. (MHz)	EMISSION LEVEL (dBuV/m)	LIMIT (dBuV/m)	MARGIN (dB)	ANTENNA HEIGHT (m)	TABLE ANGLE (Degree)	RAW VALUE (dBuV)	CORRECTION FACTOR (dB/m)
1	*5230.00	95.2 PK			2.29 H	279	92.1	3.0
2	*5230.00	84.3 AV			2.29 H	279	81.3	3.0
3	5350.00	53.1 PK	74.0	-20.9	2.29 H	279	50.2	2.9
4	5350.00	39.2 AV	54.0	-14.8	2.29 H	279	36.3	2.9
5	#10460.00	54.8 PK	74.0	-19.2	1.31 H	299	39.5	15.4
6	#10460.00	40.5 AV	54.0	-13.5	1.31 H	299	25.2	15.4

**ANTENNA POLARITY & TEST DISTANCE: VERTICAL AT 3 M**

NO.	FREQ. (MHz)	EMISSION LEVEL (dBuV/m)	LIMIT (dBuV/m)	MARGIN (dB)	ANTENNA HEIGHT (m)	TABLE ANGLE (Degree)	RAW VALUE (dBuV)	CORRECTION FACTOR (dB/m)
1	*5230.00	97.1 PK			1.43 V	25	94.1	3.0
2	*5230.00	86.2 AV			1.43 V	25	83.1	3.0
3	5350.00	54.3 PK	74.0	-19.7	1.43 V	25	51.3	2.9
4	5350.00	40.8 AV	54.0	-13.2	1.43 V	25	37.9	2.9
5	#10460.00	56.0 PK	74.0	-18.1	1.52 V	39	40.6	15.4
6	#10460.00	41.9 AV	54.0	-12.1	1.52 V	39	26.5	15.4

**REMARKS:**

1. Emission Level(dBuV/m) = Raw Value(dBuV) + Correction Factor(dB/m)
2. Correction Factor(dB/m) = Antenna Factor(dB/m) + Cable Factor(dB) – Pre-Amplifier Factor(dB)
3. The other emission levels were very low against the limit.
4. Margin value = Emission Level – Limit value
5. " \* ": Fundamental frequency.
6. " # ": The radiated frequency is out of the restricted band.

<b>CHANNEL</b>	TX Channel 54	<b>DETECTOR FUNCTION</b>	Peak (PK)
<b>FREQUENCY RANGE</b>	1GHz ~ 40GHz		Average (AV)

**ANTENNA POLARITY & TEST DISTANCE: HORIZONTAL AT 3 M**

NO.	FREQ. (MHz)	EMISSION LEVEL (dBuV/m)	LIMIT (dBuV/m)	MARGIN (dB)	ANTENNA HEIGHT (m)	TABLE ANGLE (Degree)	RAW VALUE (dBuV)	CORRECTION FACTOR (dB/m)
1	5150.00	55.9 PK	74.0	-18.1	2.33 H	291	52.3	3.7
2	5150.00	41.0 AV	54.0	-13.0	2.33 H	291	37.3	3.7
3	*5270.00	95.0 PK			2.33 H	291	92.1	2.9
4	*5270.00	84.5 AV			2.33 H	291	81.6	2.9
5	#10540.00	55.1 PK	74.0	-18.9	2.08 H	157	39.5	15.6
6	#10540.00	40.7 AV	54.0	-13.3	2.08 H	157	25.1	15.6

**ANTENNA POLARITY & TEST DISTANCE: VERTICAL AT 3 M**

NO.	FREQ. (MHz)	EMISSION LEVEL (dBuV/m)	LIMIT (dBuV/m)	MARGIN (dB)	ANTENNA HEIGHT (m)	TABLE ANGLE (Degree)	RAW VALUE (dBuV)	CORRECTION FACTOR (dB/m)
1	5150.00	57.1 PK	74.0	-16.9	1.60 V	25	53.5	3.7
2	5150.00	42.3 AV	54.0	-11.7	1.60 V	25	38.7	3.7
3	*5270.00	97.2 PK			1.60 V	25	94.3	2.9
4	*5270.00	86.0 AV			1.60 V	25	83.1	2.9
5	#10540.00	56.1 PK	74.0	-17.9	1.18 V	136	40.5	15.6
6	#10540.00	42.6 AV	54.0	-11.4	1.18 V	136	27.0	15.6

**REMARKS:**

1. Emission Level(dBuV/m) = Raw Value(dBuV) + Correction Factor(dB/m)
2. Correction Factor(dB/m) = Antenna Factor(dB/m) + Cable Factor(dB) – Pre-Amplifier Factor(dB)
3. The other emission levels were very low against the limit.
4. Margin value = Emission Level – Limit value
5. " \* ": Fundamental frequency.
6. " # ": The radiated frequency is out of the restricted band.

<b>CHANNEL</b>	TX Channel 62	<b>DETECTOR FUNCTION</b>	Peak (PK)
<b>FREQUENCY RANGE</b>	1GHz ~ 40GHz		Average (AV)

**ANTENNA POLARITY & TEST DISTANCE: HORIZONTAL AT 3 M**

NO.	FREQ. (MHz)	EMISSION LEVEL (dBuV/m)	LIMIT (dBuV/m)	MARGIN (dB)	ANTENNA HEIGHT (m)	TABLE ANGLE (Degree)	RAW VALUE (dBuV)	CORRECTION FACTOR (dB/m)
1	*5310.00	95.0 PK			2.45 H	288	92.2	2.8
2	*5310.00	84.1 AV			2.45 H	288	81.3	2.8
3	5350.00	53.7 PK	74.0	-20.3	2.45 H	288	50.8	2.9
4	5350.00	40.8 AV	54.0	-13.2	2.45 H	288	37.9	2.9
5	10620.00	55.0 PK	74.0	-19.0	1.96 H	205	39.5	15.5
6	10620.00	40.6 AV	54.0	-13.4	1.96 H	205	25.1	15.5

**ANTENNA POLARITY & TEST DISTANCE: VERTICAL AT 3 M**

NO.	FREQ. (MHz)	EMISSION LEVEL (dBuV/m)	LIMIT (dBuV/m)	MARGIN (dB)	ANTENNA HEIGHT (m)	TABLE ANGLE (Degree)	RAW VALUE (dBuV)	CORRECTION FACTOR (dB/m)
1	*5310.00	96.9 PK			1.39 V	46	94.1	2.8
2	*5310.00	86.0 AV			1.39 V	46	83.2	2.8
3	5350.00	54.1 PK	74.0	-19.9	1.39 V	46	51.2	2.9
4	5350.00	41.7 AV	54.0	-12.3	1.39 V	46	38.8	2.9
5	10620.00	56.0 PK	74.0	-18.0	1.28 V	154	40.4	15.5
6	10620.00	41.9 AV	54.0	-12.1	1.28 V	154	26.4	15.5

**REMARKS:**

1. Emission Level(dBuV/m) = Raw Value(dBuV) + Correction Factor(dB/m)
2. Correction Factor(dB/m) = Antenna Factor(dB/m) + Cable Factor(dB) – Pre-Amplifier Factor(dB)
3. The other emission levels were very low against the limit.
4. Margin value = Emission Level – Limit value
5. " \* ": Fundamental frequency.

<b>CHANNEL</b>	TX Channel 102	<b>DETECTOR FUNCTION</b>	Peak (PK)
<b>FREQUENCY RANGE</b>	1GHz ~ 40GHz		Average (AV)

**ANTENNA POLARITY & TEST DISTANCE: HORIZONTAL AT 3 M**

NO.	FREQ. (MHz)	EMISSION LEVEL (dBuV/m)	LIMIT (dBuV/m)	MARGIN (dB)	ANTENNA HEIGHT (m)	TABLE ANGLE (Degree)	RAW VALUE (dBuV)	CORRECTION FACTOR (dB/m)
1	5460.00	54.7 PK	74.0	-19.3	2.45 H	296	51.5	3.3
2	5460.00	43.2 AV	54.0	-10.8	2.45 H	296	40.0	3.3
3	#5470.00	56.0 PK	68.2	-12.2	2.45 H	296	52.7	3.3
4	*5510.00	95.5 PK			2.45 H	296	92.2	3.3
5	*5510.00	84.8 AV			2.45 H	296	81.6	3.3
6	11020.00	55.5 PK	74.0	-18.5	1.88 H	247	39.5	16.0
7	11020.00	41.4 AV	54.0	-12.6	1.88 H	247	25.4	16.0

**ANTENNA POLARITY & TEST DISTANCE: VERTICAL AT 3 M**

NO.	FREQ. (MHz)	EMISSION LEVEL (dBuV/m)	LIMIT (dBuV/m)	MARGIN (dB)	ANTENNA HEIGHT (m)	TABLE ANGLE (Degree)	RAW VALUE (dBuV)	CORRECTION FACTOR (dB/m)
1	5460.00	55.7 PK	74.0	-18.3	1.45 V	49	52.5	3.3
2	5460.00	44.6 AV	54.0	-9.4	1.45 V	49	41.3	3.3
3	#5470.00	57.2 PK	68.2	-11.0	1.45 V	49	53.9	3.3
4	*5510.00	97.5 PK			1.45 V	49	94.2	3.3
5	*5510.00	86.8 AV			1.45 V	49	83.5	3.3
6	11020.00	56.6 PK	74.0	-17.4	1.47 V	198	40.6	16.0
7	11020.00	42.5 AV	54.0	-11.5	1.47 V	198	26.5	16.0

**REMARKS:**

1. Emission Level(dBuV/m) = Raw Value(dBuV) + Correction Factor(dB/m)
2. Correction Factor(dB/m) = Antenna Factor(dB/m) + Cable Factor(dB) – Pre-Amplifier Factor(dB)
3. The other emission levels were very low against the limit.
4. Margin value = Emission Level – Limit value
5. " \* ": Fundamental frequency.
6. " # ": The radiated frequency is out of the restricted band.

<b>CHANNEL</b>	TX Channel 110	<b>DETECTOR FUNCTION</b>	Peak (PK)
<b>FREQUENCY RANGE</b>	1GHz ~ 40GHz		Average (AV)

**ANTENNA POLARITY & TEST DISTANCE: HORIZONTAL AT 3 M**

NO.	FREQ. (MHz)	EMISSION LEVEL (dBuV/m)	LIMIT (dBuV/m)	MARGIN (dB)	ANTENNA HEIGHT (m)	TABLE ANGLE (Degree)	RAW VALUE (dBuV)	CORRECTION FACTOR (dB/m)
1	*5550.00	96.0 PK			2.69 H	274	92.6	3.4
2	*5550.00	85.2 AV			2.69 H	274	81.8	3.4
3	11100.00	55.9 PK	74.0	-18.1	1.96 H	218	39.5	16.4
4	11100.00	41.6 AV	54.0	-12.4	1.96 H	218	25.2	16.4

**ANTENNA POLARITY & TEST DISTANCE: VERTICAL AT 3 M**

NO.	FREQ. (MHz)	EMISSION LEVEL (dBuV/m)	LIMIT (dBuV/m)	MARGIN (dB)	ANTENNA HEIGHT (m)	TABLE ANGLE (Degree)	RAW VALUE (dBuV)	CORRECTION FACTOR (dB/m)
1	*5550.00	97.6 PK			1.42 V	42	94.1	3.4
2	*5550.00	86.7 AV			1.42 V	42	83.2	3.4
3	11100.00	56.9 PK	74.0	-17.1	1.28 V	139	40.5	16.4
4	11100.00	42.6 AV	54.0	-11.4	1.28 V	139	26.2	16.4

**REMARKS:**

1. Emission Level(dBuV/m) = Raw Value(dBuV) + Correction Factor(dB/m)
2. Correction Factor(dB/m) = Antenna Factor(dB/m) + Cable Factor(dB) – Pre-Amplifier Factor(dB)
3. The other emission levels were very low against the limit.
4. Margin value = Emission Level – Limit value
5. " \* ": Fundamental frequency.

<b>CHANNEL</b>	TX Channel 134	<b>DETECTOR FUNCTION</b>	Peak (PK)
<b>FREQUENCY RANGE</b>	1GHz ~ 40GHz		Average (AV)

**ANTENNA POLARITY & TEST DISTANCE: HORIZONTAL AT 3 M**

NO.	FREQ. (MHz)	EMISSION LEVEL (dBuV/m)	LIMIT (dBuV/m)	MARGIN (dB)	ANTENNA HEIGHT (m)	TABLE ANGLE (Degree)	RAW VALUE (dBuV)	CORRECTION FACTOR (dB/m)
1	*5670.00	96.7 PK			2.66 H	292	92.8	3.9
2	*5670.00	85.5 AV			2.66 H	292	81.5	3.9
3	#5725.00	57.1 PK	68.2	-11.1	2.66 H	292	52.8	4.3
5	11340.00	55.9 PK	74.0	-18.1	2.09 H	294	39.9	16.0
6	11340.00	41.1 AV	54.0	-12.9	2.09 H	294	25.1	16.0

**ANTENNA POLARITY & TEST DISTANCE: VERTICAL AT 3 M**

NO.	FREQ. (MHz)	EMISSION LEVEL (dBuV/m)	LIMIT (dBuV/m)	MARGIN (dB)	ANTENNA HEIGHT (m)	TABLE ANGLE (Degree)	RAW VALUE (dBuV)	CORRECTION FACTOR (dB/m)
1	*5670.00	98.3 PK			1.48 V	48	94.3	3.9
2	*5670.00	87.4 AV			1.48 V	48	83.5	3.9
3	#5725.00	59.5 PK	68.2	-8.7	1.48 V	48	55.2	4.3
5	11340.00	57.0 PK	74.0	-17.1	1.27 V	157	41.0	16.0
6	11340.00	42.8 AV	54.0	-11.2	1.27 V	157	26.8	16.0

**REMARKS:**

1. Emission Level(dBuV/m) = Raw Value(dBuV) + Correction Factor(dB/m)
2. Correction Factor(dB/m) = Antenna Factor(dB/m) + Cable Factor(dB) – Pre-Amplifier Factor(dB)
3. The other emission levels were very low against the limit.
4. Margin value = Emission Level – Limit value
5. " \* ": Fundamental frequency.
6. " # ": The radiated frequency is out of the restricted band.

<b>CHANNEL</b>	TX Channel 142	<b>DETECTOR FUNCTION</b>	Peak (PK)
<b>FREQUENCY RANGE</b>	1GHz ~ 40GHz		Average (AV)

**ANTENNA POLARITY & TEST DISTANCE: HORIZONTAL AT 3 M**

NO.	FREQ. (MHz)	EMISSION LEVEL (dBuV/m)	LIMIT (dBuV/m)	MARGIN (dB)	ANTENNA HEIGHT (m)	TABLE ANGLE (Degree)	RAW VALUE (dBuV)	CORRECTION FACTOR (dB/m)
1	5460.00	55.3 PK	74.0	-18.7	1.11 H	10	50.9	4.4
2	5460.00	43.0 AV	54.0	-11.0	1.11 H	10	50.9	4.4
3	#5470.00	56.3 PK	68.2	-11.9	1.29 H	19	51.9	4.4
4	*5710.00	102.0 PK			1.05 H	10	62.0	40.0
5	#5825.00	56.2 PK	68.2	-12.0	1.20 H	13	51.4	4.8
6	11420.00	53.5 PK	74.0	-20.3	1.86 H	253	36.0	17.5
7	11420.00	40.1 AV	54.0	-13.9	1.86 H	253	36.0	17.5

**ANTENNA POLARITY & TEST DISTANCE: VERTICAL AT 3 M**

NO.	FREQ. (MHz)	EMISSION LEVEL (dBuV/m)	LIMIT (dBuV/m)	MARGIN (dB)	ANTENNA HEIGHT (m)	TABLE ANGLE (Degree)	RAW VALUE (dBuV)	CORRECTION FACTOR (dB/m)
1	5460.00	54.7 PK	74.0	-19.3	1.10 V	353	50.3	4.4
2	5460.00	42.2 AV	54.0	-11.5	1.11 H	10	50.9	4.4
2	#5470.00	56.1 PK	68.2	-12.1	1.08 V	2	51.7	4.4
3	*5710.00	61.4 PK			1.20 V	356	57.0	4.4
4	#5825.00	55.8 PK	68.2	-12.4	1.14 V	356	51.0	4.8
5	11420.00	53.1 PK	74.0	-20.9	1.89 V	231	35.6	17.5
7	11420.00	40.0 AV	54.0	-14.0	1.86 H	253	36.0	17.5

**REMARKS:**

1. Emission Level(dBuV/m) = Raw Value(dBuV) + Correction Factor(dB/m)
2. Correction Factor(dB/m) = Antenna Factor(dB/m) + Cable Factor(dB) – Pre-Amplifier Factor(dB)
3. The other emission levels were very low against the limit.
4. Margin value = Emission Level – Limit value
5. " \* ": Fundamental frequency.
6. " # ": The radiated frequency is out of the restricted band.



<b>CHANNEL</b>	TX Channel 151	<b>DETECTOR FUNCTION</b>	Peak (PK)
<b>FREQUENCY RANGE</b>	1GHz ~ 40GHz		Average (AV)

**ANTENNA POLARITY & TEST DISTANCE: HORIZONTAL AT 3 M**

NO.	FREQ. (MHz)	EMISSION LEVEL (dBuV/m)	LIMIT (dBuV/m)	MARGIN (dB)	ANTENNA HEIGHT (m)	TABLE ANGLE (Degree)	RAW VALUE (dBuV)	CORRECTION FACTOR (dB/m)
1	#5625.85	53.8 PK	68.2	-14.4	2.42 H	269	50.1	3.7
2	*5755.00	97.4 PK			2.42 H	269	92.9	4.5
3	*5755.00	86.0 AV			2.42 H	269	81.5	4.5
4	#6017.82	55.6 PK	68.2	-12.6	2.42 H	269	50.1	5.5
5	11510.00	56.2 PK	74.0	-17.8	1.87 H	271	39.6	16.5
6	11510.00	42.4 AV	54.0	-11.6	1.87 H	271	25.8	16.5

**ANTENNA POLARITY & TEST DISTANCE: VERTICAL AT 3 M**

NO.	FREQ. (MHz)	EMISSION LEVEL (dBuV/m)	LIMIT (dBuV/m)	MARGIN (dB)	ANTENNA HEIGHT (m)	TABLE ANGLE (Degree)	RAW VALUE (dBuV)	CORRECTION FACTOR (dB/m)
1	#5594.00	54.1 PK	68.2	-14.1	1.04 V	19	50.5	3.6
2	*5755.00	99.0 PK			1.04 V	19	94.5	4.5
3	*5755.00	88.1 AV			1.04 V	19	83.6	4.5
4	#5994.14	54.9 PK	68.2	-13.3	1.04 V	19	49.5	5.5
5	11510.00	56.8 PK	74.0	-17.2	1.56 V	169	40.3	16.5
6	11510.00	43.4 AV	54.0	-10.6	1.56 V	169	26.9	16.5

**REMARKS:**

1. Emission Level(dBuV/m) = Raw Value(dBuV) + Correction Factor(dB/m)
2. Correction Factor(dB/m) = Antenna Factor(dB/m) + Cable Factor(dB) – Pre-Amplifier Factor(dB)
3. The other emission levels were very low against the limit.
4. Margin value = Emission Level – Limit value
5. " \* ": Fundamental frequency.
6. " # ": The radiated frequency is out of the restricted band.

<b>CHANNEL</b>	TX Channel 159	<b>DETECTOR FUNCTION</b>	Peak (PK)
<b>FREQUENCY RANGE</b>	1GHz ~ 40GHz		Average (AV)

**ANTENNA POLARITY & TEST DISTANCE: HORIZONTAL AT 3 M**

NO.	FREQ. (MHz)	EMISSION LEVEL (dBuV/m)	LIMIT (dBuV/m)	MARGIN (dB)	ANTENNA HEIGHT (m)	TABLE ANGLE (Degree)	RAW VALUE (dBuV)	CORRECTION FACTOR (dB/m)
1	#5622.73	49.4 PK	68.2	-18.8	2.58 H	269	45.7	3.7
2	*5795.00	97.5 PK			2.58 H	269	92.6	4.8
3	*5795.00	86.3 AV			2.58 H	269	81.4	4.8
4	#5997.24	48.6 PK	68.2	-19.7	2.58 H	269	43.1	5.5
5	11590.00	56.0 PK	74.0	-18.0	1.93 H	243	39.4	16.6
6	11590.00	42.5 AV	54.0	-11.5	1.93 H	243	25.9	16.6

**ANTENNA POLARITY & TEST DISTANCE: VERTICAL AT 3 M**

NO.	FREQ. (MHz)	EMISSION LEVEL (dBuV/m)	LIMIT (dBuV/m)	MARGIN (dB)	ANTENNA HEIGHT (m)	TABLE ANGLE (Degree)	RAW VALUE (dBuV)	CORRECTION FACTOR (dB/m)
1	#5624.77	50.3 PK	68.2	-17.9	1.28 V	35	46.6	3.7
2	*5795.00	99.6 PK			1.28 V	35	94.7	4.8
3	*5795.00	88.4 AV			1.28 V	35	83.5	4.8
4	#5976.80	50.8 PK	68.2	-17.4	1.28 V	35	45.4	5.4
5	11590.00	57.3 PK	74.0	-16.7	1.74 V	125	40.7	16.6
6	11590.00	43.3 AV	54.0	-10.7	1.74 V	125	26.7	16.6

**REMARKS:**

1. Emission Level(dBuV/m) = Raw Value(dBuV) + Correction Factor(dB/m)
2. Correction Factor(dB/m) = Antenna Factor(dB/m) + Cable Factor(dB) – Pre-Amplifier Factor(dB)
3. The other emission levels were very low against the limit.
4. Margin value = Emission Level – Limit value
5. " \* ": Fundamental frequency.
6. " # ": The radiated frequency is out of the restricted band.

802.11ac (VHT80)

<b>CHANNEL</b>	TX Channel 42	<b>DETECTOR FUNCTION</b>	Peak (PK)
<b>FREQUENCY RANGE</b>	1GHz ~ 40GHz		Average (AV)

**ANTENNA POLARITY & TEST DISTANCE: HORIZONTAL AT 3 M**

NO.	FREQ. (MHz)	EMISSION LEVEL (dBuV/m)	LIMIT (dBuV/m)	MARGIN (dB)	ANTENNA HEIGHT (m)	TABLE ANGLE (Degree)	RAW VALUE (dBuV)	CORRECTION FACTOR (dB/m)
1	5150.00	54.1 PK	74.0	-19.9	2.77 H	286	50.4	3.7
2	5150.00	40.0 AV	54.0	-14.0	2.77 H	286	36.4	3.7
3	*5210.00	87.9 PK			2.77 H	286	84.8	3.1
4	*5210.00	77.7 AV			2.77 H	286	74.5	3.1
5	5350.00	53.0 PK	74.0	-21.1	2.77 H	286	50.0	2.9
6	5350.00	38.2 AV	54.0	-15.8	2.77 H	286	35.3	2.9
7	#10420.00	54.8 PK	74.0	-19.2	1.97 H	272	39.7	15.1
8	#10420.00	40.6 AV	54.0	-13.5	1.97 H	272	25.5	15.1

**ANTENNA POLARITY & TEST DISTANCE: VERTICAL AT 3 M**

NO.	FREQ. (MHz)	EMISSION LEVEL (dBuV/m)	LIMIT (dBuV/m)	MARGIN (dB)	ANTENNA HEIGHT (m)	TABLE ANGLE (Degree)	RAW VALUE (dBuV)	CORRECTION FACTOR (dB/m)
1	5150.00	55.5 PK	74.0	-18.5	1.29 V	29	51.8	3.7
2	5150.00	41.5 AV	54.0	-12.5	1.29 V	29	37.9	3.7
3	*5210.00	89.7 PK			1.29 V	29	86.6	3.1
4	*5210.00	79.5 AV			1.29 V	29	76.4	3.1
5	5350.00	54.0 PK	74.0	-20.0	1.29 V	29	51.1	2.9
6	5350.00	39.7 AV	54.0	-14.3	1.29 V	29	36.8	2.9
7	#10420.00	55.7 PK	74.0	-18.3	1.28 V	169	40.6	15.1
8	#10420.00	41.9 AV	54.0	-12.1	1.28 V	169	26.9	15.1

**REMARKS:**

1. Emission Level(dBuV/m) = Raw Value(dBuV) + Correction Factor(dB/m)
2. Correction Factor(dB/m) = Antenna Factor(dB/m) + Cable Factor(dB) – Pre-Amplifier Factor(dB)
3. The other emission levels were very low against the limit.
4. Margin value = Emission Level – Limit value
5. " \* ": Fundamental frequency.
6. " # ": The radiated frequency is out of the restricted band.

<b>CHANNEL</b>	TX Channel 58	<b>DETECTOR FUNCTION</b>	Peak (PK)
<b>FREQUENCY RANGE</b>	1GHz ~ 40GHz		Average (AV)

**ANTENNA POLARITY & TEST DISTANCE: HORIZONTAL AT 3 M**

NO.	FREQ. (MHz)	EMISSION LEVEL (dBuV/m)	LIMIT (dBuV/m)	MARGIN (dB)	ANTENNA HEIGHT (m)	TABLE ANGLE (Degree)	RAW VALUE (dBuV)	CORRECTION FACTOR (dB/m)
1	5150.00	52.8 PK	74.0	-21.2	2.33 H	298	49.2	3.7
2	5150.00	39.0 AV	54.0	-15.0	2.33 H	298	35.3	3.7
3	*5290.00	88.0 PK			2.33 H	298	85.2	2.8
4	*5290.00	78.2 AV			2.33 H	298	75.4	2.8
5	5350.00	53.1 PK	74.0	-20.9	2.33 H	298	50.1	2.9
6	5350.00	38.1 AV	54.0	-15.9	2.33 H	298	35.2	2.9
7	#10580.00	55.2 PK	74.0	-18.8	2.15 H	233	39.6	15.6
8	#10580.00	40.7 AV	54.0	-13.3	2.15 H	233	25.2	15.6

**ANTENNA POLARITY & TEST DISTANCE: VERTICAL AT 3 M**

NO.	FREQ. (MHz)	EMISSION LEVEL (dBuV/m)	LIMIT (dBuV/m)	MARGIN (dB)	ANTENNA HEIGHT (m)	TABLE ANGLE (Degree)	RAW VALUE (dBuV)	CORRECTION FACTOR (dB/m)
1	5150.00	54.1 PK	74.0	-19.9	1.31 V	36	50.5	3.7
2	5150.00	40.1 AV	54.0	-13.9	1.31 V	36	36.5	3.7
3	*5290.00	90.3 PK			1.31 V	36	87.5	2.8
4	*5290.00	80.0 AV			1.31 V	36	77.2	2.8
5	5350.00	54.3 PK	74.0	-19.8	3.13 V	36	51.3	2.9
6	5350.00	39.6 AV	54.0	-14.4	3.13 V	36	36.7	2.9
7	#10580.00	55.7 PK	74.0	-18.3	1.39 V	229	40.2	15.6
8	#10580.00	42.0 AV	54.0	-12.0	1.39 V	229	26.4	15.6

**REMARKS:**

1. Emission Level(dBuV/m) = Raw Value(dBuV) + Correction Factor(dB/m)
2. Correction Factor(dB/m) = Antenna Factor(dB/m) + Cable Factor(dB) – Pre-Amplifier Factor(dB)
3. The other emission levels were very low against the limit.
4. Margin value = Emission Level – Limit value
5. " \* ": Fundamental frequency.
6. " # ": The radiated frequency is out of the restricted band.

<b>CHANNEL</b>	TX Channel 106	<b>DETECTOR FUNCTION</b>	Peak (PK)
<b>FREQUENCY RANGE</b>	1GHz ~ 40GHz		Average (AV)

**ANTENNA POLARITY & TEST DISTANCE: HORIZONTAL AT 3 M**

NO.	FREQ. (MHz)	EMISSION LEVEL (dBuV/m)	LIMIT (dBuV/m)	MARGIN (dB)	ANTENNA HEIGHT (m)	TABLE ANGLE (Degree)	RAW VALUE (dBuV)	CORRECTION FACTOR (dB/m)
1	5460.00	54.5 PK	74.0	-19.5	2.45 H	281	51.3	3.3
2	5460.00	42.4 AV	54.0	-11.6	2.45 H	281	39.1	3.3
3	#5470.00	55.7 PK	68.2	-12.5	2.45 H	281	52.4	3.3
4	*5530.00	88.8 PK			2.45 H	281	85.4	3.4
5	*5530.00	78.7 AV			2.45 H	281	75.3	3.4
6	11060.00	55.8 PK	74.0	-18.2	1.98 H	248	39.6	16.2
7	11060.00	42.0 AV	54.0	-12.0	1.98 H	248	25.8	16.2

**ANTENNA POLARITY & TEST DISTANCE: VERTICAL AT 3 M**

NO.	FREQ. (MHz)	EMISSION LEVEL (dBuV/m)	LIMIT (dBuV/m)	MARGIN (dB)	ANTENNA HEIGHT (m)	TABLE ANGLE (Degree)	RAW VALUE (dBuV)	CORRECTION FACTOR (dB/m)
1	5460.00	55.7 PK	74.0	-18.3	1.34 V	22	52.4	3.3
2	5460.00	43.4 AV	54.0	-10.6	1.34 V	22	40.2	3.3
3	#5470.00	57.1 PK	68.2	-11.1	1.34 V	22	53.9	3.3
4	*5530.00	90.7 PK			1.34 V	22	87.3	3.4
5	*5530.00	80.6 AV			1.34 V	22	77.2	3.4
6	11060.00	56.6 PK	74.0	-17.4	1.11 V	127	40.4	16.2
7	11060.00	42.9 AV	54.0	-11.1	1.11 V	127	26.7	16.2

**REMARKS:**

1. Emission Level(dBuV/m) = Raw Value(dBuV) + Correction Factor(dB/m)
2. Correction Factor(dB/m) = Antenna Factor(dB/m) + Cable Factor(dB) – Pre-Amplifier Factor(dB)
3. The other emission levels were very low against the limit.
4. Margin value = Emission Level – Limit value
5. " \* ": Fundamental frequency.
6. " # ": The radiated frequency is out of the restricted band.

<b>CHANNEL</b>	TX Channel 122	<b>DETECTOR FUNCTION</b>	Peak (PK)
<b>FREQUENCY RANGE</b>	1GHz ~ 40GHz		Average (AV)

**ANTENNA POLARITY & TEST DISTANCE: HORIZONTAL AT 3 M**

NO.	FREQ. (MHz)	EMISSION LEVEL (dBuV/m)	LIMIT (dBuV/m)	MARGIN (dB)	ANTENNA HEIGHT (m)	TABLE ANGLE (Degree)	RAW VALUE (dBuV)	CORRECTION FACTOR (dB/m)
1	*5610.00	88.9 PK			2.58 H	279	85.2	3.7
2	*5610.00	79.2 AV			2.58 H	279	75.5	3.7
3	#5725.00	56.1 PK	68.2	-12.1	2.58 H	279	51.8	4.3
4	11220.00	55.7 PK	74.0	-18.3	2.14 H	299	39.6	16.1
5	11220.00	41.5 AV	54.0	-12.5	2.14 H	299	25.4	16.1

**ANTENNA POLARITY & TEST DISTANCE: VERTICAL AT 3 M**

NO.	FREQ. (MHz)	EMISSION LEVEL (dBuV/m)	LIMIT (dBuV/m)	MARGIN (dB)	ANTENNA HEIGHT (m)	TABLE ANGLE (Degree)	RAW VALUE (dBuV)	CORRECTION FACTOR (dB/m)
1	*5610.00	91.3 PK			1.39 V	32	87.6	3.7
2	*5610.00	81.0 AV			1.39 V	32	77.3	3.7
3	#5725.00	56.6 PK	68.2	-12.6	1.39 V	32	52.3	4.3
4	11220.00	56.7 PK	74.0	-17.3	1.36 V	118	40.6	16.1
5	11220.00	42.8 AV	54.0	-11.3	1.36 V	118	26.7	16.1

**REMARKS:**

1. Emission Level(dBuV/m) = Raw Value(dBuV) + Correction Factor(dB/m)
2. Correction Factor(dB/m) = Antenna Factor(dB/m) + Cable Factor(dB) – Pre-Amplifier Factor(dB)
3. The other emission levels were very low against the limit.
4. Margin value = Emission Level – Limit value
5. " \* ": Fundamental frequency.
6. " # ": The radiated frequency is out of the restricted band.

<b>CHANNEL</b>	TX Channel 138	<b>DETECTOR FUNCTION</b>	Peak (PK)
<b>FREQUENCY RANGE</b>	1GHz ~ 40GHz		Average (AV)

**ANTENNA POLARITY & TEST DISTANCE: HORIZONTAL AT 3 M**

NO.	FREQ. (MHz)	EMISSION LEVEL (dBuV/m)	LIMIT (dBuV/m)	MARGIN (dB)	ANTENNA HEIGHT (m)	TABLE ANGLE (Degree)	RAW VALUE (dBuV)	CORRECTION FACTOR (dB/m)
1	5460.00	55.4 PK	74.0	-18.6	1.09 H	19	51.0	4.4
2	5460.00	41.0 AV	54.0	-13.0	1.09 H	19	51.0	4.4
3	#5470.00	56.7 PK	68.2	-11.5	1.14 H	13	52.3	4.4
4	*5690.00	95.4 PK			1.11 H	10	55.4	40.0
5	#5825.00	55.7 PK	68.2	-12.5	1.20 H	12	50.9	4.8
6	11380.00	53.7 PK	74.0	-20.3	1.69 H	259	36.2	17.5
7	11380.00	40.9 AV	54.0	-13.1	1.69 H	259	36.2	17.5

**ANTENNA POLARITY & TEST DISTANCE: VERTICAL AT 3 M**

NO.	FREQ. (MHz)	EMISSION LEVEL (dBuV/m)	LIMIT (dBuV/m)	MARGIN (dB)	ANTENNA HEIGHT (m)	TABLE ANGLE (Degree)	RAW VALUE (dBuV)	CORRECTION FACTOR (dB/m)
1	5460.00	55.1 PK	74.0	-18.9	1.09 V	10	50.7	4.4
2	5460.00	40.8 AV	54.0	-13.2	1.09 H	19	51.0	4.4
3	#5470.00	56.4 PK	68.2	-11.8	1.15 V	359	52.0	4.4
4	*5690.00	90.1 PK			1.19 V	356	50.1	40.0
5	#5825.00	55.5 PK	68.2	-12.7	1.21 V	3	50.7	4.8
6	11380.00	53.3 PK	74.0	-20.7	1.90 V	205	35.8	17.5
7	11380.00	39.8 AV	54.0	-14.2	1.69 H	259	36.2	17.5

**REMARKS:**

1. Emission Level(dBuV/m) = Raw Value(dBuV) + Correction Factor(dB/m)
2. Correction Factor(dB/m) = Antenna Factor(dB/m) + Cable Factor(dB) – Pre-Amplifier Factor(dB)
3. The other emission levels were very low against the limit.
4. Margin value = Emission Level – Limit value
5. " \* ": Fundamental frequency.
6. " # ": The radiated frequency is out of the restricted band.

<b>CHANNEL</b>	TX Channel 155	<b>DETECTOR FUNCTION</b>	Peak (PK)
<b>FREQUENCY RANGE</b>	1GHz ~ 40GHz		Average (AV)

**ANTENNA POLARITY & TEST DISTANCE: HORIZONTAL AT 3 M**

NO.	FREQ. (MHz)	EMISSION LEVEL (dBuV/m)	LIMIT (dBuV/m)	MARGIN (dB)	ANTENNA HEIGHT (m)	TABLE ANGLE (Degree)	RAW VALUE (dBuV)	CORRECTION FACTOR (dB/m)
1	#5618.73	50.9 PK	68.2	-17.3	2.47 H	281	47.2	3.7
2	*5775.00	91.0 PK			2.47 H	281	86.3	4.7
3	*5775.00	81.3 AV			2.47 H	281	76.6	4.7
4	#5960.83	50.4 PK	68.2	-17.8	2.47 H	281	45.1	5.3
5	11550.00	55.8 PK	74.0	-18.2	2.22 H	233	39.2	16.6
6	11550.00	42.4 AV	54.0	-11.6	2.22 H	233	25.8	16.6

**ANTENNA POLARITY & TEST DISTANCE: VERTICAL AT 3 M**

NO.	FREQ. (MHz)	EMISSION LEVEL (dBuV/m)	LIMIT (dBuV/m)	MARGIN (dB)	ANTENNA HEIGHT (m)	TABLE ANGLE (Degree)	RAW VALUE (dBuV)	CORRECTION FACTOR (dB/m)
1	#5562.86	54.9 PK	68.2	-13.3	1.36 V	31	51.4	3.5
2	*5775.00	92.3 PK			1.36 V	31	87.6	4.7
3	*5775.00	82.6 AV			1.36 V	31	77.9	4.7
4	#5985.44	55.6 PK	68.2	-12.6	1.36 V	31	50.2	5.4
5	11550.00	57.0 PK	74.0	-17.0	1.45 V	205	40.4	16.6
6	11550.00	43.4 AV	54.0	-10.6	1.45 V	205	26.8	16.6

**REMARKS:**

1. Emission Level(dBuV/m) = Raw Value(dBuV) + Correction Factor(dB/m)
2. Correction Factor(dB/m) = Antenna Factor(dB/m) + Cable Factor(dB) – Pre-Amplifier Factor(dB)
3. The other emission levels were very low against the limit.
4. Margin value = Emission Level – Limit value
5. " \* ": Fundamental frequency.
6. " # ": The radiated frequency is out of the restricted band.



**9 kHz ~ 30 MHz Data:**

The amplitude of spurious emissions attenuated more than 20 dB below the permissible value is not required to be report.

**30 MHz ~ 1 GHz Worst-Case Data:**

**Mode A**

**802.11n (HT20)**

<b>CHANNEL</b>	TX Channel 157	<b>DETECTOR FUNCTION</b>	Quasi-Peak (QP)
<b>FREQUENCY RANGE</b>	30MHz ~ 1GHz		

**ANTENNA POLARITY & TEST DISTANCE: HORIZONTAL AT 3 M**

NO.	FREQ. (MHz)	EMISSION LEVEL (dBuV/m)	LIMIT (dBuV/m)	MARGIN (dB)	ANTENNA HEIGHT (m)	TABLE ANGLE (Degree)	RAW VALUE (dBuV)	CORRECTION FACTOR (dB/m)
1	33.59	22.1 QP	40.0	-17.9	1.77 H	133	30.7	-8.6
2	59.83	19.5 QP	40.0	-20.6	1.03 H	254	26.9	-7.4
3	552.54	28.0 QP	46.0	-18.0	2.35 H	260	28.5	-0.5
4	641.05	29.5 QP	46.0	-16.5	2.89 H	235	27.8	1.7
5	808.33	33.1 QP	46.0	-13.0	1.65 H	18	28.9	4.2
6	873.37	34.4 QP	46.0	-11.6	2.77 H	102	29.3	5.1

**ANTENNA POLARITY & TEST DISTANCE: VERTICAL AT 3 M**

NO.	FREQ. (MHz)	EMISSION LEVEL (dBuV/m)	LIMIT (dBuV/m)	MARGIN (dB)	ANTENNA HEIGHT (m)	TABLE ANGLE (Degree)	RAW VALUE (dBuV)	CORRECTION FACTOR (dB/m)
1	43.48	25.8 QP	40.0	-14.2	1.12 V	131	33.2	-7.4
2	64.53	20.3 QP	40.0	-19.7	2.56 V	357	28.4	-8.1
3	521.11	27.4 QP	46.0	-18.6	1.75 V	98	28.3	-0.9
4	662.73	29.9 QP	46.0	-16.1	2.39 V	279	28.0	1.9
5	815.85	32.2 QP	46.0	-13.8	1.84 V	285	27.6	4.5
6	913.96	34.4 QP	46.0	-11.6	2.47 V	262	28.1	6.3

**REMARKS:**

1. Emission Level(dBuV/m) = Raw Value(dBuV) + Correction Factor(dB/m)
2. Correction Factor(dB/m) = Antenna Factor(dB/m) + Cable Factor(dB) – Pre-Amplifier Factor(dB)
3. The other emission levels were very low against the limit.
4. Margin value = Emission Level – Limit value

**Mode B**

**802.11n (HT20)**

<b>CHANNEL</b>	TX Channel 157	<b>DETECTOR FUNCTION</b>	Quasi-Peak (QP)
<b>FREQUENCY RANGE</b>	30MHz ~ 1GHz		

**ANTENNA POLARITY & TEST DISTANCE: HORIZONTAL AT 3 M**

NO.	FREQ. (MHz)	EMISSION LEVEL (dBuV/m)	LIMIT (dBuV/m)	MARGIN (dB)	ANTENNA HEIGHT (m)	TABLE ANGLE (Degree)	RAW VALUE (dBuV)	CORRECTION FACTOR (dB/m)
1	51.29	29.7 QP	40.0	-10.3	1.99 H	138	39.0	-9.3
2	101.84	29.8 QP	43.5	-13.7	1.99 H	184	43.2	-13.4
3	167.94	37.3 QP	43.5	-6.2	1.00 H	191	46.3	-9.0
4	298.21	34.0 QP	46.0	-12.0	1.00 H	318	41.2	-7.2
5	486.81	33.3 QP	46.0	-12.7	1.49 H	271	36.5	-3.2
6	663.74	32.0 QP	46.0	-14.0	1.49 H	8	31.5	0.5

**ANTENNA POLARITY & TEST DISTANCE: VERTICAL AT 3 M**

NO.	FREQ. (MHz)	EMISSION LEVEL (dBuV/m)	LIMIT (dBuV/m)	MARGIN (dB)	ANTENNA HEIGHT (m)	TABLE ANGLE (Degree)	RAW VALUE (dBuV)	CORRECTION FACTOR (dB/m)
1	57.12	27.8 QP	40.0	-12.2	1.00 V	303	37.3	-9.5
2	97.95	32.3 QP	43.5	-11.2	1.00 V	64	46.0	-13.7
3	169.89	28.2 QP	43.5	-15.3	1.00 V	71	37.1	-8.9
4	366.26	26.3 QP	46.0	-19.7	1.49 V	200	32.1	-5.8
5	500.42	28.4 QP	46.0	-17.6	1.99 V	194	31.3	-2.9
6	724.01	28.4 QP	46.0	-17.6	1.99 V	276	26.6	1.8

**REMARKS:**

1. Emission Level(dBuV/m) = Raw Value(dBuV) + Correction Factor(dB/m)
2. Correction Factor(dB/m) = Antenna Factor(dB/m) + Cable Factor(dB) – Pre-Amplifier Factor(dB)
3. The other emission levels were very low against the limit.
4. Margin value = Emission Level – Limit value

## 4.2 Conducted Emission Measurement

### 4.2.1 Limits of Conducted Emission Measurement

Frequency (MHz)	Conducted Limit (dBuV)	
	Quasi-Peak	Average
0.15 - 0.5	66 - 56	56 - 46
0.50 - 5.0	56	46
5.0 - 30.0	60	50

- Note: 1. The lower limit shall apply at the transition frequencies.  
 2. The limit decreases in line with the logarithm of the frequency in the range of 0.15 to 0.50 MHz.

### 4.2.2 Test Instruments

Description & Manufacturer	Model No.	Serial No.	Date of Calibration	Due Date of Calibration
Test Receiver ROHDE & SCHWARZ	ESR3	102412	Feb. 08, 2018	Feb. 07, 2019
RF signal cable (with 10dB PAD) Woken	5D-FB	Cable-cond2-01	Sep. 08, 2017	Sep. 07, 2018
LISN/AMN ROHDE & SCHWARZ (EUT)	ESH2-Z5	100100	Feb. 05, 2018	Feb. 04, 2019
LISN/AMN ROHDE & SCHWARZ (Peripheral)	ESH3-Z5	100312	Aug. 02, 2017	Aug. 01, 2018
Software ADT	BV ADT_Cond_ V7.3.7.4	NA	NA	NA

- Note: 1. The calibration interval of the above test instruments is 12 months and the calibrations are traceable to NML/ROC and NIST/USA.  
 2. The test was performed in HwaYa Shielded Room 2.  
 3. The VCCI Site Registration No. is C-2047.

#### 4.2.3 Test Procedures

- a. The EUT was placed 0.4 meters from the conducting wall of the shielded room with EUT being connected to the power mains through a line impedance stabilization network (LISN). Other support units were connected to the power mains through another LISN. The two LISNs provide 50 ohm/ 50uH of coupling impedance for the measuring instrument.
- b. Both lines of the power mains connected to the EUT were checked for maximum conducted interference.
- c. The frequency range from 150 kHz to 30 MHz was searched. Emission levels under (Limit -20 dB) was not recorded.

**Note:** All modes of operation were investigated and the worst-case emissions are reported.

#### 4.2.4 Deviation from Test Standard

No deviation.

#### 4.2.5 Test Setup

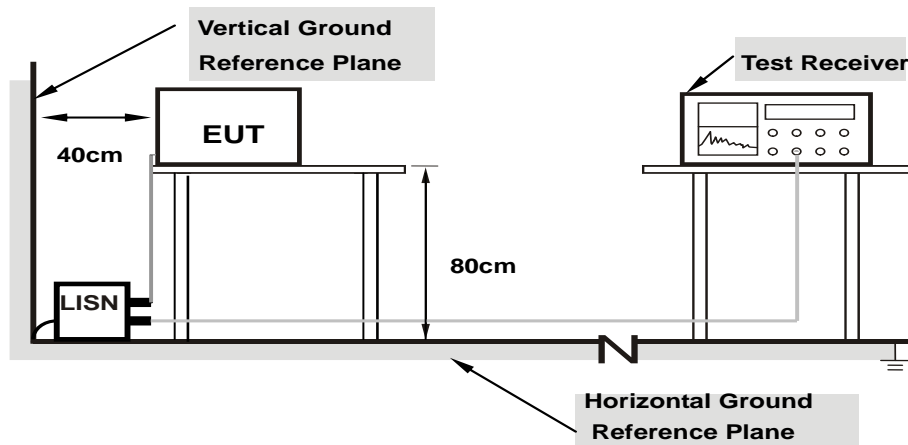

- Note:**
- 1.Support units were connected to second LISN.
  - 2.Both of LISNs (AMN) are 80 cm from EUT and at least 80 from other units and other metal planes

For the actual test configuration, please refer to the attached file (Test Setup Photo).

#### 4.2.6 EUT Operating Conditions

- a. Placed the EUT on a testing table.
- b. Use the software to control the EUT under transmission condition continuously at specific channel frequency.

#### 4.2.7 Test Results

##### Mode A

Frequency Range	150kHz ~ 30MHz	Detector Function & Resolution Bandwidth	Quasi-Peak (QP) / Average (AV), 9kHz
Input Power	120Vac, 60Hz	Environmental Conditions	22°C, 66%RH
Tested by	Adair Peng	Test Date	2018/7/20

Phase Of Power : Line (L)										
No	Frequency (MHz)	Correction Factor (dB)	Reading Value (dBuV)		Emission Level (dBuV)		Limit (dBuV)		Margin (dB)	
			Q.P.	AV.	Q.P.	AV.	Q.P.	AV.	Q.P.	AV.
1	0.16093	10.25	37.79	21.20	48.04	31.45	65.42	55.42	-17.38	-23.97
2	0.53503	10.28	19.91	10.35	30.19	20.63	56.00	46.00	-25.81	-25.37
3	2.82975	10.41	9.95	4.86	20.36	15.27	56.00	46.00	-35.64	-30.73
4	13.37157	10.66	11.49	6.47	22.15	17.13	60.00	50.00	-37.85	-32.87
5	14.64900	10.69	11.33	7.19	22.02	17.88	60.00	50.00	-37.98	-32.12
6	18.17250	10.79	16.57	11.12	27.36	21.91	60.00	50.00	-32.64	-28.09

#### Remarks:

1. Q.P. and AV. are abbreviations of quasi-peak and average individually.
2. The emission levels of other frequencies were very low against the limit.
3. Margin value = Emission level – Limit value
4. Correction factor = Insertion loss + Cable loss
5. Emission Level = Correction Factor + Reading Value

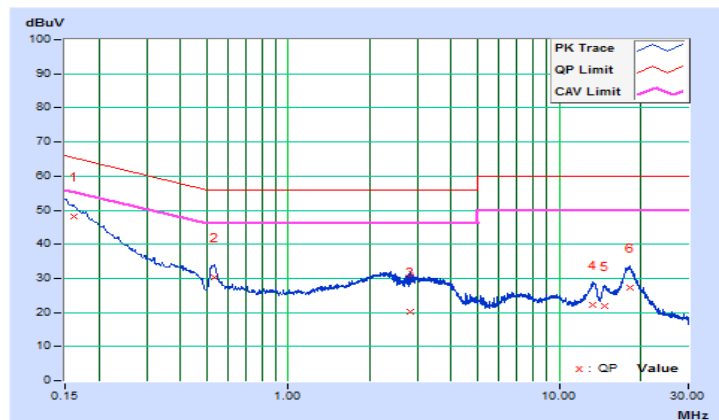

Frequency Range	150kHz ~ 30MHz	Detector Function & Resolution Bandwidth	Quasi-Peak (QP) / Average (AV), 9kHz
Input Power	120Vac, 60Hz	Environmental Conditions	22°C, 66%RH
Tested by	Adair Peng	Test Date	2018/7/20

Phase Of Power : Neutral (N)										
No	Frequency (MHz)	Correction Factor (dB)	Reading Value (dBuV)		Emission Level (dBuV)		Limit (dBuV)		Margin (dB)	
			Q.P.	AV.	Q.P.	AV.	Q.P.	AV.	Q.P.	AV.
1	0.15900	10.25	38.88	23.44	49.13	33.69	65.52	55.52	-16.39	-21.83
2	0.52385	10.29	23.05	14.13	33.34	24.42	56.00	46.00	-22.66	-21.58
3	2.29875	10.40	18.69	14.18	29.09	24.58	56.00	46.00	-26.91	-21.42
4	5.18100	10.51	16.58	9.38	27.09	19.89	60.00	50.00	-32.91	-30.11
5	13.42050	10.75	18.04	10.95	28.79	21.70	60.00	50.00	-31.21	-28.30
6	18.20850	10.92	16.21	10.79	27.13	21.71	60.00	50.00	-32.87	-28.29

Remarks:

1. Q.P. and AV. are abbreviations of quasi-peak and average individually.
2. The emission levels of other frequencies were very low against the limit.
3. Margin value = Emission level – Limit value
4. Correction factor = Insertion loss + Cable loss
5. Emission Level = Correction Factor + Reading Value

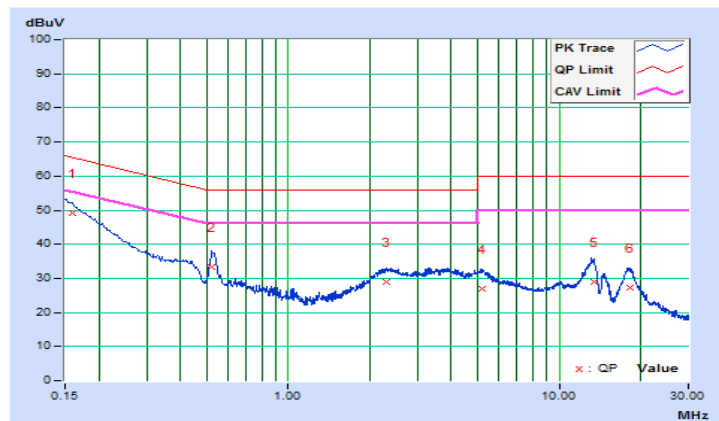

**Mode B**

Frequency Range	150kHz ~ 30MHz	Detector Function & Resolution Bandwidth	Quasi-Peak (QP) / Average (AV), 9kHz
Input Power	120Vac, 60Hz	Environmental Conditions	22°C, 66%RH
Tested by	Adair Peng	Test Date	2018/7/27

Phase Of Power : Line (L)										
No	Frequency (MHz)	Correction Factor (dB)	Reading Value (dBuV)		Emission Level (dBuV)		Limit (dBuV)		Margin (dB)	
			Q.P.	AV.	Q.P.	AV.	Q.P.	AV.	Q.P.	AV.
1	0.15900	10.24	37.10	17.02	47.34	27.26	65.52	55.52	-18.18	-28.26
2	0.51900	10.28	22.16	14.31	32.44	24.59	56.00	46.00	-23.56	-21.41
3	3.20500	10.42	15.53	8.96	25.95	19.38	56.00	46.00	-30.05	-26.62
4	13.48350	10.66	17.68	12.23	28.34	22.89	60.00	50.00	-31.66	-27.11
5	14.62425	10.69	16.37	11.26	27.06	21.95	60.00	50.00	-32.94	-28.05
6	18.45150	10.80	19.99	14.56	30.79	25.36	60.00	50.00	-29.21	-24.64

Remarks:

1. Q.P. and AV. are abbreviations of quasi-peak and average individually.
2. The emission levels of other frequencies were very low against the limit.
3. Margin value = Emission level – Limit value
4. Correction factor = Insertion loss + Cable loss
5. Emission Level = Correction Factor + Reading Value

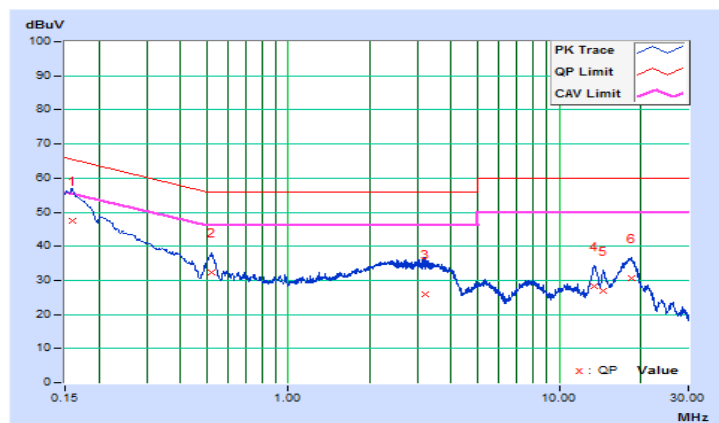

Frequency Range	150kHz ~ 30MHz	Detector Function & Resolution Bandwidth	Quasi-Peak (QP) / Average (AV), 9kHz
Input Power	120Vac, 60Hz	Environmental Conditions	22°C, 66%RH
Tested by	Adair Peng	Test Date	2018/7/27

Phase Of Power : Neutral (N)										
No	Frequency (MHz)	Correction Factor (dB)	Reading Value (dBuV)		Emission Level (dBuV)		Limit (dBuV)		Margin (dB)	
			Q.P.	AV.	Q.P.	AV.	Q.P.	AV.	Q.P.	AV.
1	0.17925	10.26	39.75	24.33	50.01	34.59	64.52	54.52	-14.51	-19.93
2	0.52523	10.29	24.80	16.88	35.09	27.17	56.00	46.00	-20.91	-18.83
3	2.36175	10.40	19.24	14.29	29.64	24.69	56.00	46.00	-26.36	-21.31
4	3.67125	10.46	20.21	14.63	30.67	25.09	56.00	46.00	-25.33	-20.91
5	13.37550	10.75	24.31	16.94	35.06	27.69	60.00	50.00	-24.94	-22.31
6	18.28500	10.93	19.53	14.22	30.46	25.15	60.00	50.00	-29.54	-24.85

Remarks:

1. Q.P. and AV. are abbreviations of quasi-peak and average individually.
2. The emission levels of other frequencies were very low against the limit.
3. Margin value = Emission level – Limit value
4. Correction factor = Insertion loss + Cable loss
5. Emission Level = Correction Factor + Reading Value

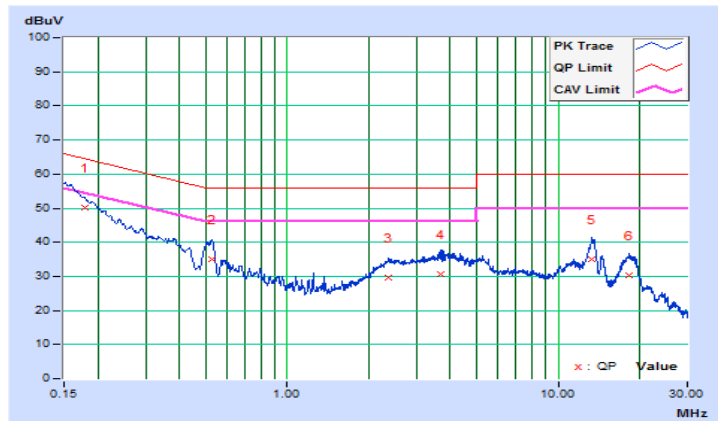



### 4.3 Transmit Power Measurement

#### 4.3.1 Limits of Transmit Power Measurement

Operation Band	EUT Category		Limit
U-NII-1		Outdoor Access Point	1 Watt (30 dBm) (Max. e.i.r.p $\leq$ 125 mW (21 dBm) at any elevation angle above 30 degrees as measured from the horizon)
		Fixed point-to-point Access Point	1 Watt (30 dBm)
		Indoor Access Point	1 Watt (30 dBm)
	√	Mobile and Portable client device	250 mW (24 dBm)
U-NII-2A		√	250 mW (24 dBm) or 11 dBm + 10 log B*
U-NII-2C		√	250 mW (24 dBm) or 11 dBm + 10 log B*
U-NII-3		√	1 Watt (30 dBm)

\*B is the 26 dB emission bandwidth in megahertz

Per KDB 662911 Method of conducted output power measurement on IEEE 802.11 devices,

Array Gain = 0 dB (i.e., no array gain) for  $N_{ANT} \leq 4$ ;

Array Gain = 0 dB (i.e., no array gain) for channel widths  $\geq$  40 MHz for any  $N_{ANT}$ ;

Array Gain =  $5 \log(N_{ANT}/N_{SS})$  dB or 3 dB, whichever is less for 20 MHz channel widths with  $N_{ANT} \geq 5$ .

For power measurements on all other devices: Array Gain =  $10 \log(N_{ANT}/N_{SS})$  dB.

#### 4.3.2 Test Setup

##### <Power Output Measurement>

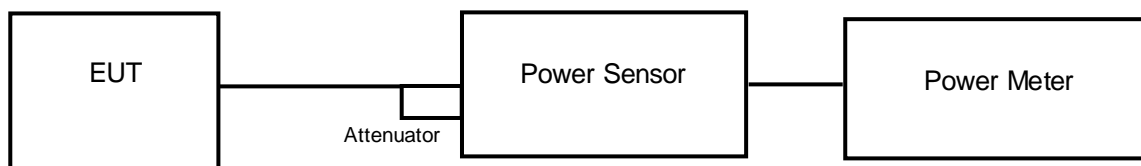

or

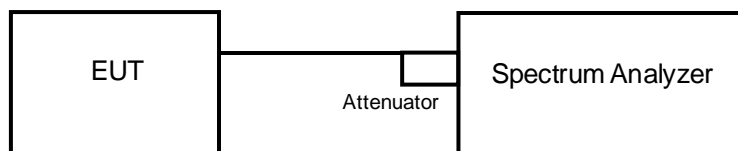

##### <26 dB Bandwidth>

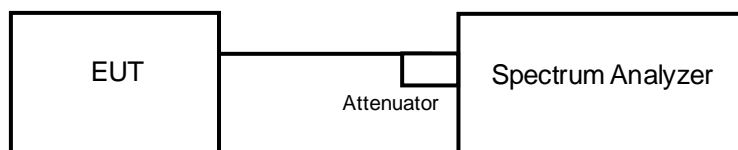

#### 4.3.3 Test Instruments

Refer to section 4.1.2 to get information of above instrument.

#### 4.3.4 Test Procedure

##### **Average Power Measurement**

<802.11a, 802.11n (HT20), 802.11n (HT40)>

Method PM is used to perform output power measurement, trigger and gating function of wide band power meter is enabled to measure max output power of TX on burst. Duty factor is not added to measured value.

<802.11ac (VHT80)>

- a. Set span to encompass the entire 26 dB EBW (or, alternatively, the entire 99 % occupied bandwidth) of the signal.
- b. Set sweep trigger to "free run".
- c. Set RBW = 1 MHz.
- d. Set VBW  $\geq$  3 MHz
- e. Number of points in sweep  $\geq$  2 Span / RBW.
- f. Sweep time  $\leq$  (number of points in sweep) \* T
- g. Using emission bandwidth to determine the frequency span for integration the channel bandwidth.
- h. Detector = RMS.
- i. Trace mode = max hold.
- j. Allow max hold to run for at least 60 seconds, or longer as needed to allow the trace to stabilize.

##### **26 dB Bandwidth**

- a. Set RBW = approximately 1 % of the emission bandwidth.
- b. Set the VBW > RBW.
- c. Detector = Peak.
- d. Trace mode = max hold.
- e. Measure the maximum width of the emission that is 26 dB down from the peak of the emission. Compare this with the RBW setting of the analyzer. Readjust RBW and repeat measurement as needed until the RBW/EBW ratio is approximately 1 %.

#### 4.3.5 Deviation from Test Standard

No deviation.

#### 4.3.6 EUT Operating Conditions

The software provided by client to enable the EUT under transmission condition continuously at lowest, middle and highest channel frequencies individually.

#### 4.3.7 Test Results

##### Power Output:

##### 802.11a

Channel	Frequency (MHz)	Maximum Conducted Power (mW)	Maximum Conducted Power (dBm)	Power Limit (dBm)	Pass / Fail
36	5180	48.641	16.87	24	Pass
40	5200	47.315	16.75	24	Pass
48	5240	46.452	16.67	24	Pass
52	5260	48.865	16.89	24	Pass
60	5300	51.404	17.11	24	Pass
64	5320	50.816	17.06	24	Pass
100	5500	48.417	16.85	24	Pass
116	5580	51.286	17.10	24	Pass
140	5700	50.466	17.03	24	Pass
144	5720 (U-NII-2C)	42.073	16.24	23.10	Pass
144	5720 (U-NII-3)	42.073	16.24	30	Pass
149	5745	41.115	16.14	30	Pass
157	5785	42.658	16.30	30	Pass
165	5825	42.364	16.27	30	Pass

##### Note:

##### For U-NII-2A, U-NII-2C Band:

- $11 \text{ dBm} + 10\log ( 22.51 ) = 24.52 \text{ dBm} > 24 \text{ dBm}.$
- $11 \text{ dBm} + 10\log ( 22.25 ) = 24.47 \text{ dBm} > 24 \text{ dBm}.$
- $11 \text{ dBm} + 10\log ( 22.72 ) = 24.56 \text{ dBm} > 24 \text{ dBm}.$
- $11 \text{ dBm} + 10\log ( 22.20 ) = 24.46 \text{ dBm} > 24 \text{ dBm}.$
- $11 \text{ dBm} + 10\log ( 22.61 ) = 24.54 \text{ dBm} > 24 \text{ dBm}.$
- $11 \text{ dBm} + 10\log ( 22.60 ) = 24.54 \text{ dBm} > 24 \text{ dBm}.$
- $11 \text{ dBm} + 10\log ( 16.23 ) = 23.10 \text{ dBm} < 24 \text{ dBm}.$

### 802.11n (HT20)

Channel	Frequency (MHz)	Maximum Conducted Power (mW)	Maximum Conducted Power (dBm)	Power Limit (dBm)	Pass / Fail
36	5180	46.132	16.64	24	Pass
40	5200	48.641	16.87	24	Pass
48	5240	50.234	17.01	24	Pass
52	5260	52	17.16	24	Pass
60	5300	52.966	17.24	24	Pass
64	5320	51.88	17.15	24	Pass
100	5500	48.865	16.89	24	Pass
116	5580	50.582	17.04	24	Pass
140	5700	52.36	17.19	24	Pass
144	5720 (U-NII-2C)	42.855	16.32	23.14	Pass
144	5720 (U-NII-3)	42.855	16.32	30	Pass
149	5745	43.351	16.37	30	Pass
157	5785	37.844	15.78	30	Pass
165	5825	41.687	16.20	30	Pass

**Note:**

**For U-NII-2A, U-NII-2C Band:**

- $11 \text{ dBm} + 10\log ( 22.72 ) = 24.56 \text{ dBm} > 24 \text{ dBm}.$
- $11 \text{ dBm} + 10\log ( 22.69 ) = 24.56 \text{ dBm} > 24 \text{ dBm}.$
- $11 \text{ dBm} + 10\log ( 22.67 ) = 24.55 \text{ dBm} > 24 \text{ dBm}.$
- $11 \text{ dBm} + 10\log ( 22.71 ) = 24.56 \text{ dBm} > 24 \text{ dBm}.$
- $11 \text{ dBm} + 10\log ( 22.54 ) = 24.53 \text{ dBm} > 24 \text{ dBm}.$
- $11 \text{ dBm} + 10\log ( 22.95 ) = 24.61 \text{ dBm} > 24 \text{ dBm}.$
- $11 \text{ dBm} + 10\log ( 16.38 ) = 23.14 \text{ dBm} < 24 \text{ dBm}.$

### 802.11n (HT40)

Channel	Frequency (MHz)	Maximum Conducted Power (mW)	Maximum Conducted Power (dBm)	Power Limit (dBm)	Pass / Fail
38	5190	51.523	17.12	24	Pass
46	5230	54.325	17.35	24	Pass
54	5270	58.749	17.69	24	Pass
62	5310	56.754	17.54	24	Pass
102	5510	54.954	17.40	24	Pass
110	5550	54.075	17.33	24	Pass
134	5670	57.148	17.57	24	Pass
142	5710 (U-NII-2C)	48.417	16.85	24	Pass
142	5710 (U-NII-3)	48.417	16.85	30	Pass
151	5755	47.643	16.78	30	Pass
159	5795	48.641	16.87	30	Pass

**Note:**

**For U-NII-2A, U-NII-2C Band:**

1.  $11 \text{ dBm} + 10\log ( 46.02 ) = 27.63 \text{ dBm} > 24 \text{ dBm}$ .
2.  $11 \text{ dBm} + 10\log ( 44.83 ) = 27.52 \text{ dBm} > 24 \text{ dBm}$ .
3.  $11 \text{ dBm} + 10\log ( 45.46 ) = 27.58 \text{ dBm} > 24 \text{ dBm}$ .
4.  $11 \text{ dBm} + 10\log ( 45.51 ) = 27.58 \text{ dBm} > 24 \text{ dBm}$ .
5.  $11 \text{ dBm} + 10\log ( 45.81 ) = 27.61 \text{ dBm} > 24 \text{ dBm}$ .
6.  $11 \text{ dBm} + 10\log ( 38.04 ) = 26.80 \text{ dBm} > 24 \text{ dBm}$ .

### 802.11ac (VHT80)

Channel	Frequency (MHz)	Maximum Conducted Power (mW)	Maximum Conducted Power (dBm)	Power Limit (dBm)	Pass / Fail
42	5210	25.003	13.98	24	Pass
58	5290	27.925	14.46	24	Pass
106	5530	26.853	14.29	24	Pass
122	5610	29.242	14.66	24	Pass
138	5690 (U-NII-2C)	23.335	13.68	24	Pass
138	5690 (U-NII-3)	23.335	13.68	30	Pass
155	5775	21.478	13.32	30	Pass

**Note:**

**For U-NII-2A, U-NII-2C Band:**

1.  $11 \text{ dBm} + 10\log ( 84.81 ) = 30.28 \text{ dBm} > 24 \text{ dBm}$ .
2.  $11 \text{ dBm} + 10\log ( 84.81 ) = 30.28 \text{ dBm} > 24 \text{ dBm}$ .
3.  $11 \text{ dBm} + 10\log ( 85.17 ) = 30.30 \text{ dBm} > 24 \text{ dBm}$ .
4.  $11 \text{ dBm} + 10\log ( 77.10 ) = 29.87 \text{ dBm} > 24 \text{ dBm}$ .

**26 dB Bandwidth:**

**802.11a**

Channel	Frequency (MHz)	26 dBc Bandwidth (MHz)
36	5180	22.44
40	5200	22.40
48	5240	22.63
52	5260	22.51
60	5300	22.25
64	5320	22.72
100	5500	22.20
116	5580	22.61
140	5700	22.60
144	5720 (U-NII-2C)	16.23
144	5720 (U-NII-3)	6.00

**802.11n (HT20)**

Channel	Frequency (MHz)	26 dBc Bandwidth (MHz)
36	5180	22.76
40	5200	22.70
48	5240	22.84
52	5260	22.72
60	5300	22.69
64	5320	22.67
100	5500	22.71
116	5580	22.54
140	5700	22.95
144	5720 (U-NII-2C)	16.38
144	5720 (U-NII-3)	6.33

### 802.11n (HT40)

Channel	Frequency (MHz)	26 dBc Bandwidth (MHz)
38	5190	45.78
46	5230	45.79
54	5270	46.02
62	5310	44.83
102	5510	45.46
110	5550	45.51
134	5670	45.81
142	5710 (U-NII-2C)	38.04
142	5710 (U-NII-3)	7.76

### 802.11ac (VHT80)

Channel	Frequency (MHz)	26 dBc Bandwidth (MHz)
42	5210	84.90
58	5290	84.81
106	5530	84.81
122	5610	85.17
138	5690 (U-NII-2C)	77.10
138	5690 (U-NII-3)	7.63

### Spectrum Plot of Worst Value

#### 802.11a

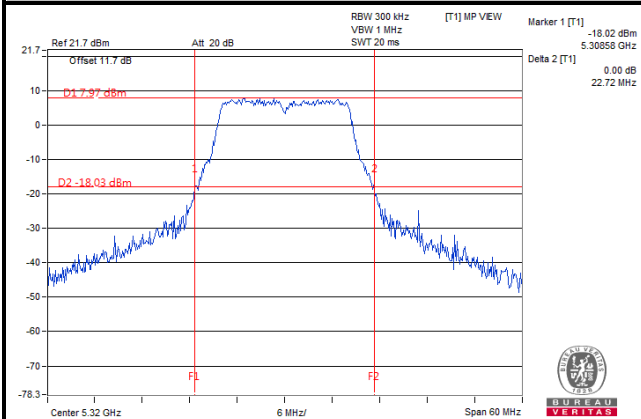

#### 802.11n (HT20)

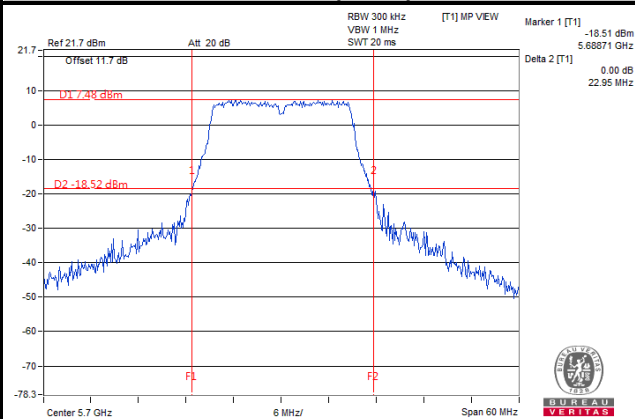

#### 802.11n (HT40)

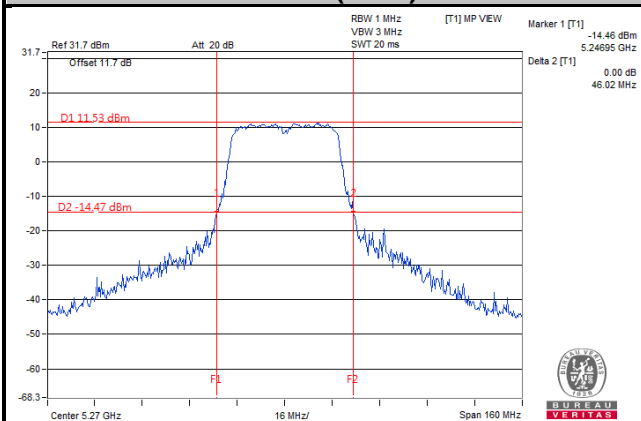

#### 802.11ac (VHT80)

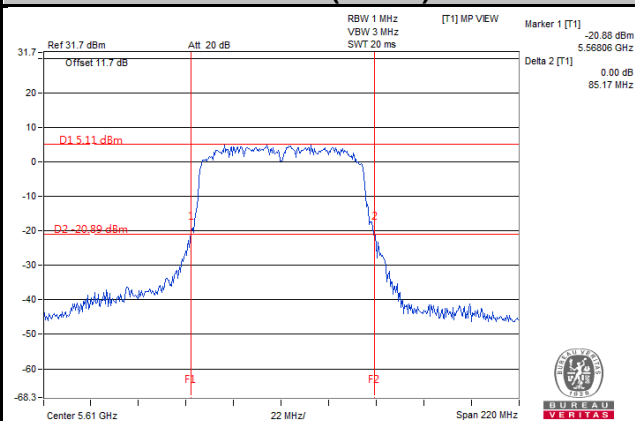



## 4.4 Occupied Bandwidth Measurement

### 4.4.1 Test Setup

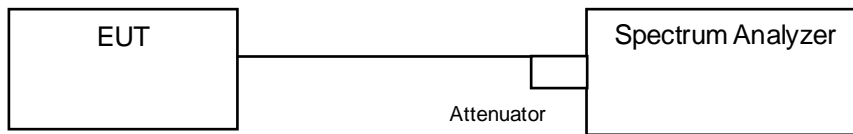

### 4.4.2 Test Instruments

Refer to section 4.1.2 to get information of above instrument.

### 4.4.3 Test Procedure

The transmitter output was connected to the spectrum analyzer through an attenuator. The bandwidth of the fundamental frequency was measured by spectrum analyzer with resolution bandwidth in the range of 1 % to 5 % of the anticipated emission bandwidth, and a video bandwidth at least 3x the resolution bandwidth and set the detector to SAMPLE. The width of a frequency band such that, below the lower and above the upper frequency limits, the mean powers emitted are each equal to a specified percentage 0.5 % of the total mean power of a given emission.

#### 4.4.4 Test Results

##### 802.11a

Channel	Channel Frequency (MHz)	Occupied Bandwidth (MHz)
36	5180	17.04
40	5200	16.92
48	5240	17.04
52	5260	16.92
60	5300	16.92
64	5320	17.04
100	5500	16.92
116	5580	17.04
140	5700	17.04
144	5720 (U-NII-2C)	13.28
144	5720 (U-NII-3)	3.16
149	5745	16.93
157	5785	17.02
165	5825	17.02

##### 802.11n (HT20)

Channel	Channel Frequency (MHz)	Occupied Bandwidth (MHz)
36	5180	18.00
40	5200	18.12
48	5240	18.00
52	5260	18.00
60	5300	18.12
64	5320	18.00
100	5500	18.00
116	5580	18.00
140	5700	17.88
144	5720 (U-NII-2C)	13.88
144	5720 (U-NII-3)	3.76
149	5745	18.08
157	5785	18.08
165	5825	17.88

**802.11n (HT40)**

Channel	Channel Frequency (MHz)	Occupied Bandwidth (MHz)
38	5190	36.48
46	5230	36.48
54	5270	36.48
62	5310	36.36
102	5510	36.36
110	5550	36.48
134	5670	36.48
142	5710 (U-NII-2C)	33.48
142	5710 (U-NII-3)	3.12
151	5755	36.48
159	5795	36.60

**802.11ac (VHT80)**

Channel	Channel Frequency (MHz)	Occupied Bandwidth (MHz)
42	5210	74.88
58	5290	74.88
106	5530	74.88
122	5610	74.88
138	5690 (U-NII-2C)	72.68
138	5690 (U-NII-3)	2.20
155	5775	75.00

### Spectrum Plot of Worst Value

#### 802.11a

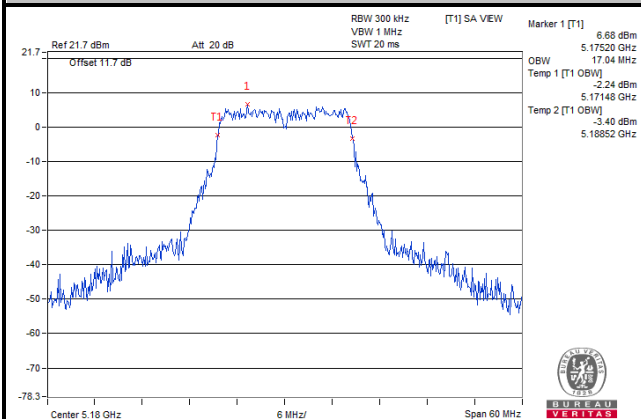

#### 802.11n (HT20)

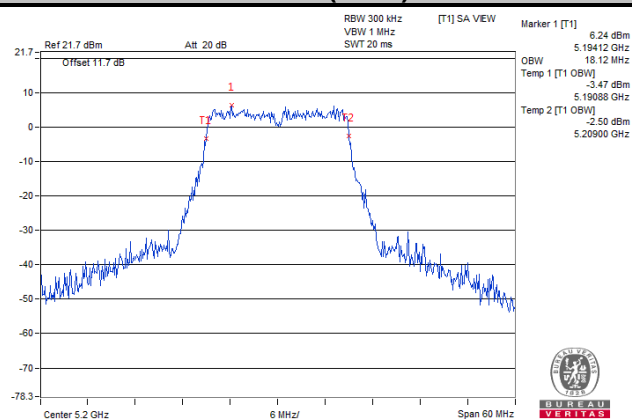

#### 802.11n (HT40)

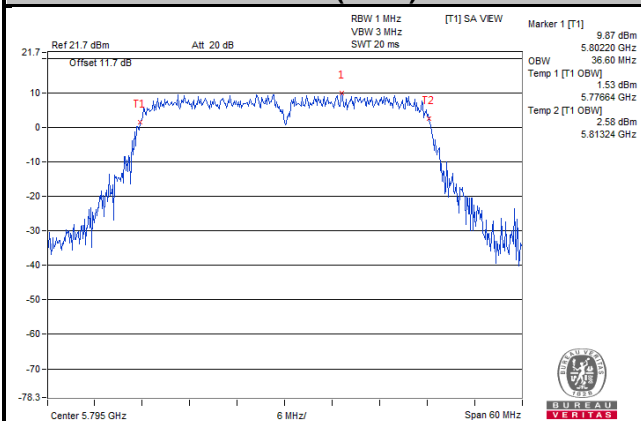

#### 802.11ac (VHT80)

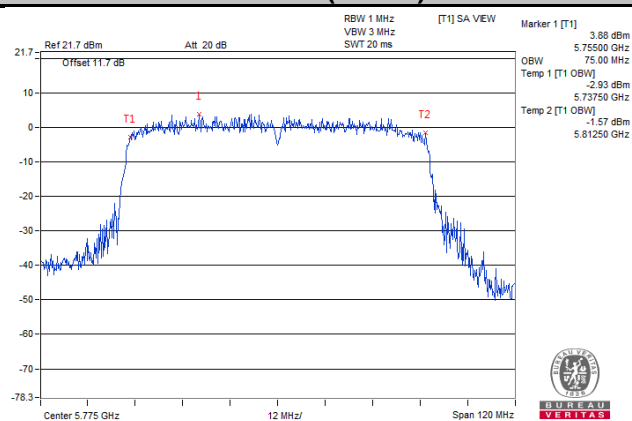

## 4.5 Peak Power Spectral Density Measurement

### 4.5.1 Limits of Peak Power Spectral Density Measurement

Operation Band	EUT Category		Limit
U-NII-1		Outdoor Access Point	17 dBm/MHz
		Fixed point-to-point Access Point	
		Indoor Access Point	
	√	Mobile and Portable client device	11 dBm/MHz
U-NII-2A		√	11 dBm/MHz
U-NII-2C		√	11 dBm/MHz
U-NII-3		√	30 dBm/500 kHz

### 4.5.2 Test Setup

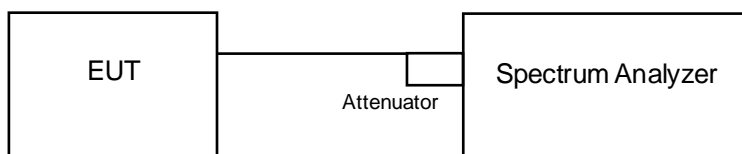

### 4.5.3 Test Instruments

Refer to section 4.1.3 to get information of above instrument.

### 4.5.4 Test Procedures

#### For U-NII-1, U-NII-2A, U-NII-2C band:

Using method SA-2

1. Set span to encompass the entire emission bandwidth (EBW) of the signal.
2. Set RBW = 1 MHz, Set VBW  $\geq$  3 RBW, Detector = RMS
3. Sweep time = auto, trigger set to "free run".
4. Trace average at least 100 traces in power averaging mode.
5. Record the max value and add  $10 \log (1/\text{duty cycle})$

#### ※For U-NII-3:

1. Set span to encompass the entire emission bandwidth (EBW) of the signal.
2. Set RBW = 300 kHz, Set VBW  $\geq$  3 RBW, Detector = RMS
3. Use the peak marker function to determine the maximum power level in any 500 kHz band segment within the fundamental EBW.
4. Scale the observed power level to an equivalent value in 500 kHz by adjusting (reducing) the measured power by a bandwidth correction factor (BWCF) where  $BWCF = 10 \log(500 \text{ kHz}/300 \text{ kHz})$
5. Sweep time = auto, trigger set to "free run".
6. Trace average at least 100 traces in power averaging mode.
7. Record the max value and add  $10 \log (1/\text{duty cycle})$

#### 4.5.5 Deviation from Test Standard

No deviation.

#### 4.5.6 EUT Operating Conditions

The software provided by client to enable the EUT under transmission condition continuously at lowest, middle and highest channel frequencies individually.

4.5.7 Test Results

For U-NII-1, U-NII-2A, U-NII-2C Band

802.11a

Channel	Frequency (MHz)	PSD w/o Duty Factor (dBm/MHz)	Duty Factor (dB)	PSD with Duty Factor (dBm/MHz)	Maximum Limit (dBm/MHz)	Pass / Fail
36	5180	1.32	0.64	1.96	11	Pass
40	5200	1.44	0.64	2.08	11	Pass
48	5240	1.31	0.64	1.95	11	Pass
52	5260	1.50	0.64	2.14	11	Pass
60	5300	1.82	0.64	2.46	11	Pass
64	5320	1.98	0.64	2.62	11	Pass
100	5500	1.43	0.64	2.07	11	Pass
116	5580	1.64	0.64	2.28	11	Pass
140	5700	1.60	0.64	2.24	11	Pass
144	5720 (U-NII-2C)	3.38	0.64	4.02	11	Pass

**Note:** Refer to section 3.3 for duty cycle spectrum plot.

802.11n (HT20)

Channel	Frequency (MHz)	PSD w/o Duty Factor (dBm/MHz)	Duty Factor (dB)	PSD with Duty Factor (dBm/MHz)	Maximum Limit (dBm/MHz)	Pass / Fail
36	5180	1.12	0.63	1.75	11	Pass
40	5200	1.23	0.63	1.86	11	Pass
48	5240	1.22	0.63	1.85	11	Pass
52	5260	1.98	0.63	2.61	11	Pass
60	5300	1.78	0.63	2.41	11	Pass
64	5320	1.83	0.63	2.46	11	Pass
100	5500	1.26	0.63	1.89	11	Pass
116	5580	1.51	0.63	2.14	11	Pass
140	5700	1.23	0.63	1.86	11	Pass
144	5720 (U-NII-2C)	3.38	0.63	0.63	11	Pass

**Note:** Refer to section 3.3 for duty cycle spectrum plot.

### 802.11n (HT40)

Channel	Frequency (MHz)	PSD w/o Duty Factor (dBm/MHz)	Duty Factor (dB)	PSD with Duty Factor (dBm/MHz)	Maximum Limit (dBm/MHz)	Pass / Fail
38	5190	-1.62	1.21	-0.41	11	Pass
46	5230	-1.70	1.21	-0.49	11	Pass
54	5270	-1.09	1.21	0.12	11	Pass
62	5310	-1.66	1.21	-0.45	11	Pass
102	5510	-1.20	1.21	0.01	11	Pass
110	5550	-1.26	1.21	-0.05	11	Pass
134	5670	-1.21	1.21	0.00	11	Pass
142	5710 (U-NII-2C)	0.33	1.21	1.54	11	Pass

**Note:** Refer to section 3.3 for duty cycle spectrum plot.

### 802.11ac (VHT80)

Channel	Frequency (MHz)	PSD w/o Duty Factor (dBm/MHz)	Duty Factor (dB)	PSD with Duty Factor (dBm/MHz)	Maximum Limit (dBm/MHz)	Pass / Fail
42	5210	-8.57	2.61	-5.96	11	Pass
58	5290	-8.61	2.61	-6.00	11	Pass
106	5530	-8.90	2.61	-6.29	11	Pass
122	5610	-8.70	2.61	-6.09	11	Pass
138	5690 (U-NII-2C)	-11.41	2.61	-8.80	11	Pass

**Note:** Refer to section 3.3 for duty cycle spectrum plot.



### Spectrum Plot of Worst Value

#### 802.11a

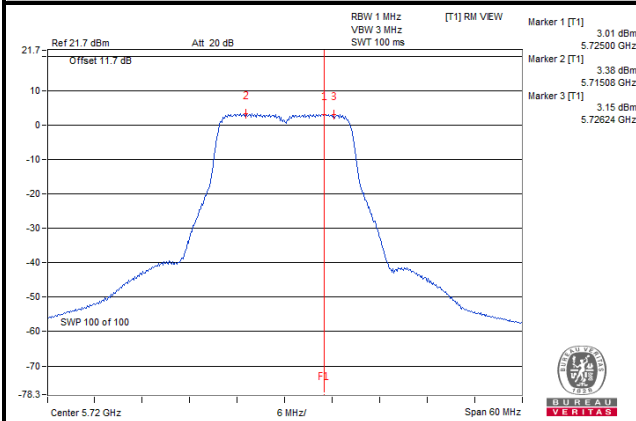

#### 802.11n (HT20)

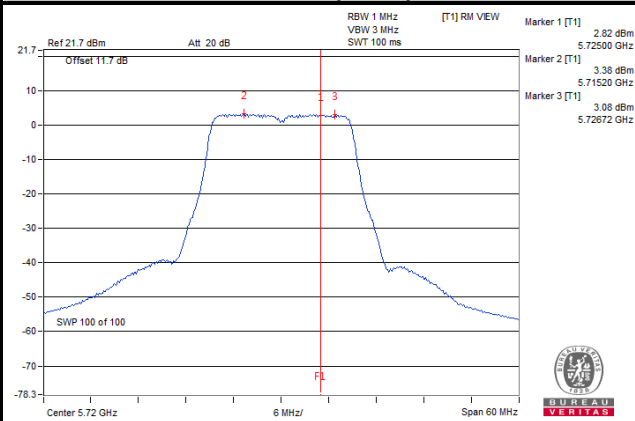

#### 802.11n (HT40)

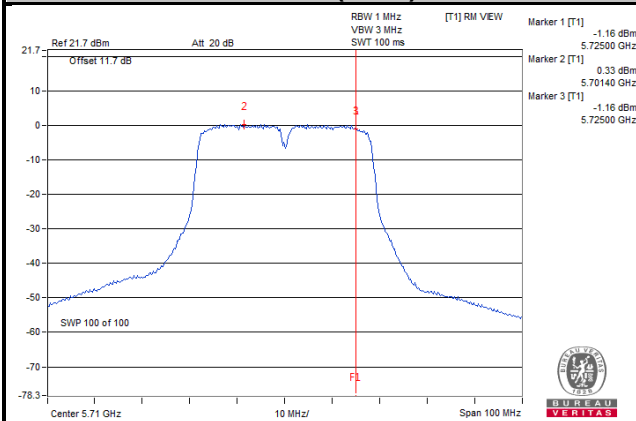

#### 802.11ac (VHT80)

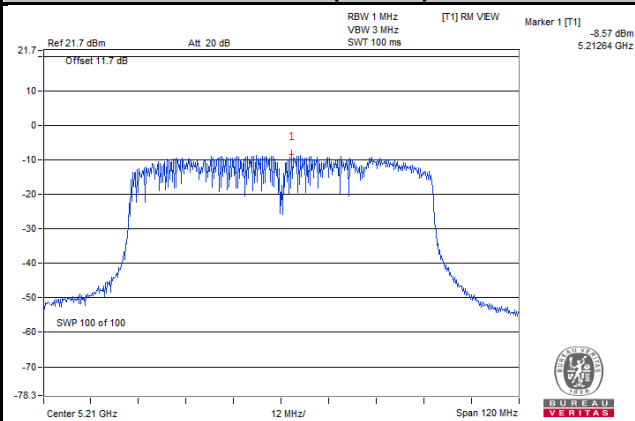

### For U-NII-3 Band

#### 802.11a

Channel	Frequency (MHz)	PSD w/o Duty Factor (dBm/300 kHz)	PSD w/o Duty Factor (dBm/500 kHz)	Duty Factor (dB)	PSD with Duty Factor (dBm/500 kHz)	Limit (dBm/500 kHz)	Pass / Fail
144	5720 (U-NII-3)	-2.15	0.07	0.64	0.71	30	Pass
149	5745	-6.89	-4.67	0.64	-4.03	30	Pass
157	5785	-6.45	-4.23	0.64	-3.59	30	Pass
165	5825	-6.30	-4.08	0.64	-3.44	30	Pass

**Note:** Refer to section 3.3 for duty cycle spectrum plot.

#### 802.11n (HT20)

Channel	Frequency (MHz)	PSD w/o Duty Factor (dBm/300 kHz)	PSD w/o Duty Factor (dBm/500 kHz)	Duty Factor (dB)	PSD with Duty Factor (dBm/500 kHz)	Limit (dBm/500 kHz)	Pass / Fail
144	5720 (U-NII-3)	-2.15	0.07	0.63	0.70	30	Pass
149	5745	-6.00	-3.78	0.63	-3.15	30	Pass
157	5785	-5.94	-3.72	0.63	-3.09	30	Pass
165	5825	-6.00	-3.78	0.63	-3.15	30	Pass

**Note:** Refer to section 3.3 for duty cycle spectrum plot.

#### 802.11n (HT40)

Channel	Frequency (MHz)	PSD w/o Duty Factor (dBm/300 kHz)	PSD w/o Duty Factor (dBm/500 kHz)	Duty Factor (dB)	PSD with Duty Factor (dBm/500 kHz)	Limit (dBm/500 kHz)	Pass / Fail
142	5710 (U-NII-3)	-5.70	-3.48	1.21	-2.27	30	Pass
151	5755	-10.35	-8.13	1.21	-6.92	30	Pass
159	5795	-10.75	-8.53	1.21	-7.32	30	Pass

**Note:** Refer to section 3.3 for duty cycle spectrum plot.

#### 802.11ac (VHT80)

Channel	Frequency (MHz)	PSD w/o Duty Factor (dBm/300 kHz)	PSD w/o Duty Factor (dBm/500 kHz)	Duty Factor (dB)	PSD with Duty Factor (dBm/500 kHz)	Limit (dBm/500 kHz)	Pass / Fail
138	5690 (U-NII-3)	-16.09	-13.87	2.61	-11.26	30	Pass
155	5775	-17.62	-15.40	2.61	-12.79	30	Pass

**Note:** Refer to section 3.3 for duty cycle spectrum plot.

### Spectrum Plot of Worst Value

#### 802.11a

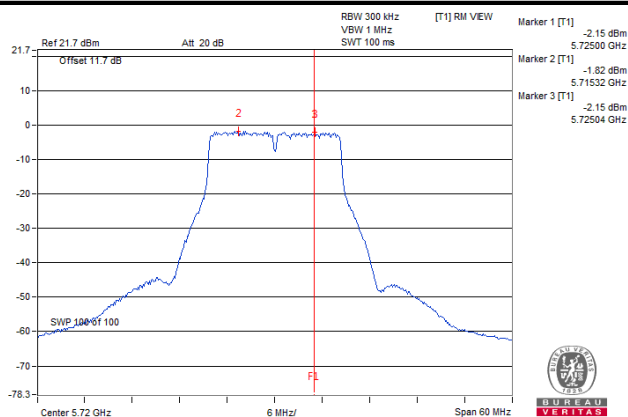

#### 802.11n (HT20)

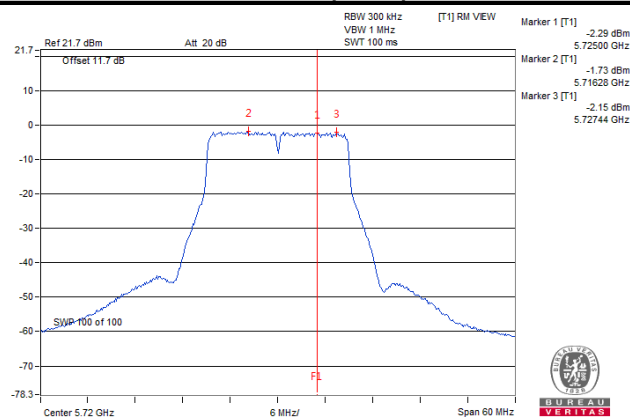

#### 802.11n (HT40)

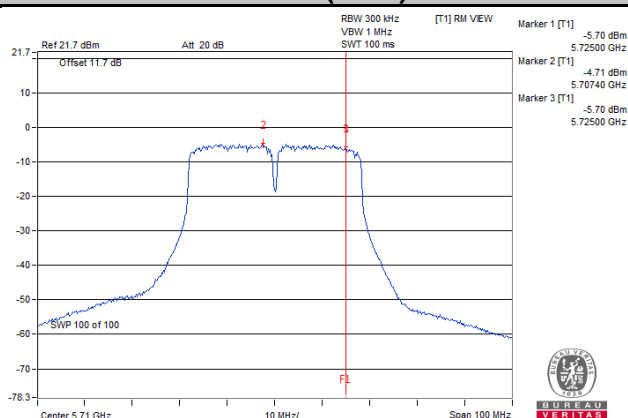

#### 802.11ac (VHT80)

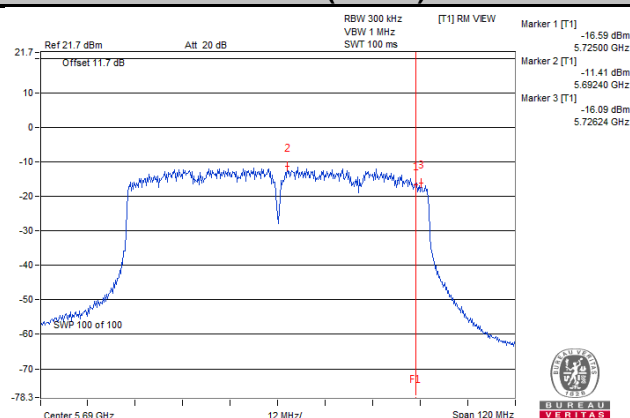

## 4.6 Frequency Stability

### 4.6.1 Limit of Frequency Stability Measurement

The frequency of the carrier signal shall be maintained within band of operation.

### 4.6.2 Test Setup

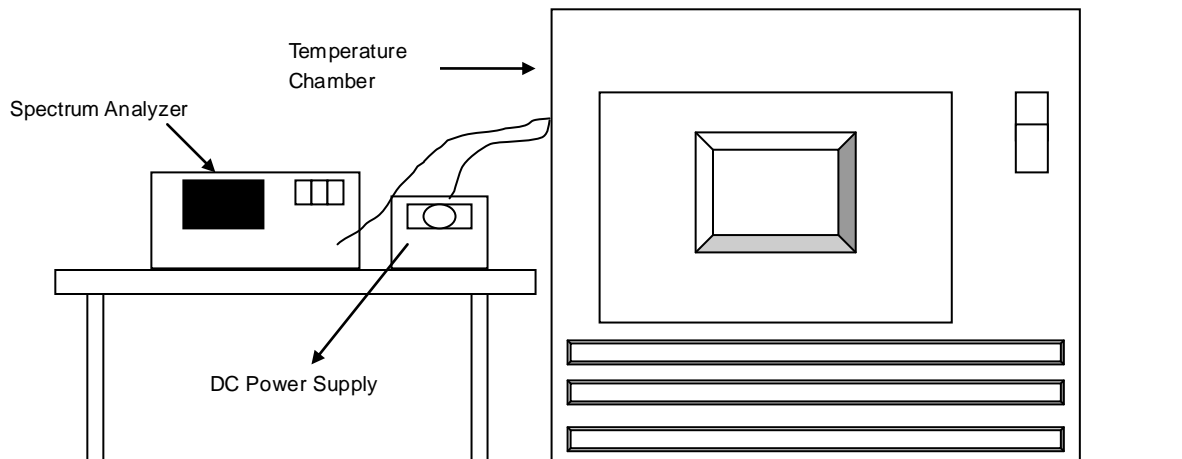

### 4.6.3 Test Instruments

Refer to section 4.1.3 to get information of above instrument.

### 4.6.4 Test Procedure

- To ensure emission at the band edge is maintained within the authorized band, those values shall be measured by radiation emissions at upper and lower frequency points, and finally compensated by frequency deviation as procedures below.
- The EUT was operated at the maximum output power, and connected to the spectrum analyzer, which is set to maximum hold function and peak detector. The peak value of the power envelope was measured and noted. The upper and lower frequency points were respectively measured relatively 10 dB lower than the measured peak value.
- The frequency deviation was calculated by adding the upper frequency point and the lower frequency point divided by two. Those detailed values of frequency deviation are provided in table below.

### 4.6.5 Deviation from Test Standard

No deviation.

### 4.6.6 EUT Operating Condition

Set the EUT transmit at un-modulation mode to test frequency stability.

#### 4.6.7 Test Results

Frequency Stability Versus Temp.									
Operating Frequency: 5210 MHz									
Temp. (°C)	Power Supply (Vdc)	0 Minute		2 Minute		5 Minute		10 Minute	
		Measured Frequency (MHz)	Result	Measured Frequency (MHz)	Result	Measured Frequency (MHz)	Result	Measured Frequency (MHz)	Result
50	3.85	5209.9873	PASS	5209.9898	PASS	5209.9867	PASS	5209.9879	PASS
40	3.85	5210.0077	PASS	5210.0101	PASS	5210.0094	PASS	5210.0091	PASS
30	3.85	5209.999	PASS	5210.0034	PASS	5210.0001	PASS	5210.0036	PASS
20	3.85	5209.9866	PASS	5209.9895	PASS	5209.9868	PASS	5209.9913	PASS
10	3.85	5209.9966	PASS	5209.9934	PASS	5209.9943	PASS	5209.9972	PASS
0	3.85	5209.9904	PASS	5209.9872	PASS	5209.9888	PASS	5209.9883	PASS
-10	3.85	5210.0142	PASS	5210.014	PASS	5210.0151	PASS	5210.0122	PASS
-20	3.85	5209.9857	PASS	5209.9896	PASS	5209.9853	PASS	5209.9846	PASS
-30	3.85	5209.9769	PASS	5209.9815	PASS	5209.9792	PASS	5209.9769	PASS

Frequency Stability Versus Temp.									
Operating Frequency: 5210 MHz									
Temp. (°C)	Power Supply (Vdc)	0 Minute		2 Minute		5 Minute		10 Minute	
		Measured Frequency (MHz)	Result	Measured Frequency (MHz)	Result	Measured Frequency (MHz)	Result	Measured Frequency (MHz)	Result
20	4.4	5209.9874	PASS	5209.9892	PASS	5209.9873	PASS	5209.9915	PASS
	3.85	5209.9866	PASS	5209.9895	PASS	5209.9868	PASS	5209.9913	PASS
	3.6	5209.9866	PASS	5209.99	PASS	5209.9869	PASS	5209.9905	PASS

## 4.7 6 dB Bandwidth Measurement

### 4.7.1 Limits of 6 dB Bandwidth Measurement

The minimum of 6 dB Bandwidth Measurement is 0.5 MHz.

### 4.7.2 Test Setup

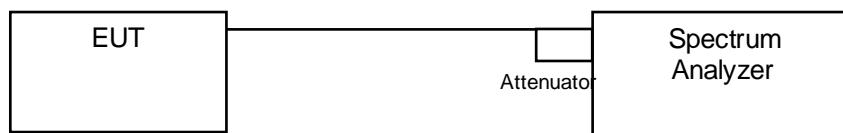

### 4.7.3 Test Instruments

Refer to section 4.1.3 to get information of above instrument.

### 4.7.4 Test Procedure

#### MEASUREMENT PROCEDURE REF

- Set resolution bandwidth (RBW) = 100 kHz
- Set the video bandwidth (VBW)  $\geq 3 \times$  RBW, Detector = Peak.
- Trace mode = max hold.
- Sweep = auto couple.
- Measure the maximum width of the emission that is constrained by the frequencies associated with the two amplitude points (upper and lower) that are attenuated by 6 dB relative to the maximum level measured in the fundamental emission

### 4.7.5 Deviation from Test Standard

No deviation.

### 4.7.6 EUT Operating Condition

The software provided by client to enable the EUT under transmission condition continuously at lowest, middle and highest channel frequencies individually.

#### 4.7.7 Test Results

##### 802.11a

Channel	Frequency (MHz)	6 dB Bandwidth (MHz)	Minimum Limit (MHz)	Pass / Fail
144	5720 (U-NII-3)	3.22	0.5	Pass
149	5745	16.42	0.5	Pass
157	5785	16.41	0.5	Pass
165	5825	16.43	0.5	Pass

##### 802.11n (HT20)

Channel	Frequency (MHz)	6 dB Bandwidth (MHz)	Minimum Limit (MHz)	Pass / Fail
144	5720 (U-NII-3)	3.82	0.5	Pass
149	5745	17.63	0.5	Pass
157	5785	17.64	0.5	Pass
165	5825	17.63	0.5	Pass

##### 802.11n (HT40)

Channel	Frequency (MHz)	6 dB Bandwidth (MHz)	Minimum Limit (MHz)	Pass / Fail
142	5710 (U-NII-3)	2.67	0.5	Pass
151	5755	35.25	0.5	Pass
159	5795	35.35	0.5	Pass

##### 802.11ac (VHT80)

Channel	Frequency (MHz)	6 dB Bandwidth (MHz)	Minimum Limit (MHz)	Pass / Fail
138	5690 (U-NII-3)	2.63	0.5	Pass
155	5775	75.34	0.5	Pass

### Spectrum Plot of Worst Value

#### 802.11a

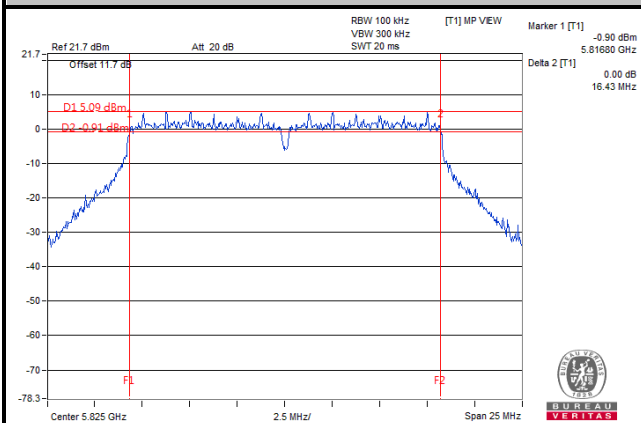

#### 802.11n (HT20)

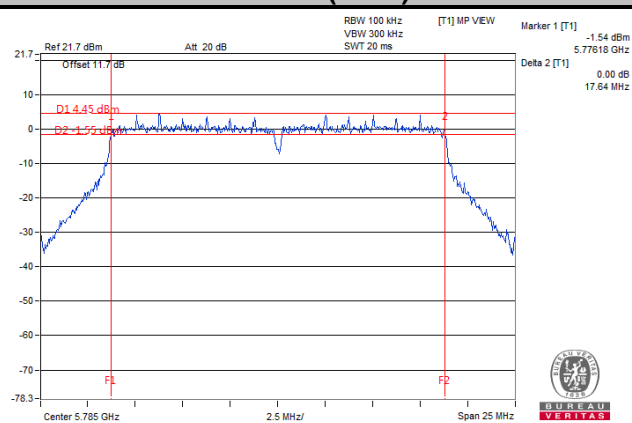

#### 802.11n (HT40)

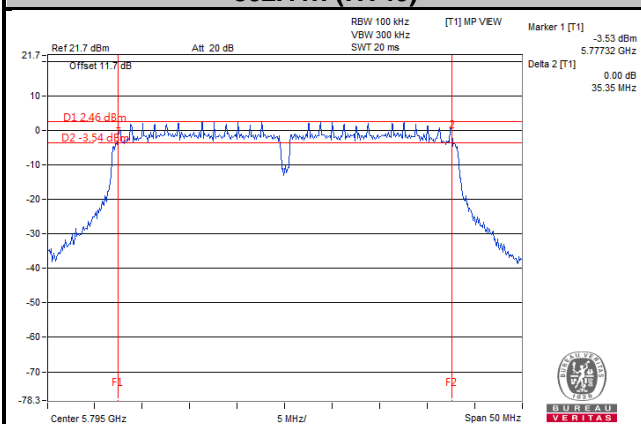

#### 802.11ac (VHT80)

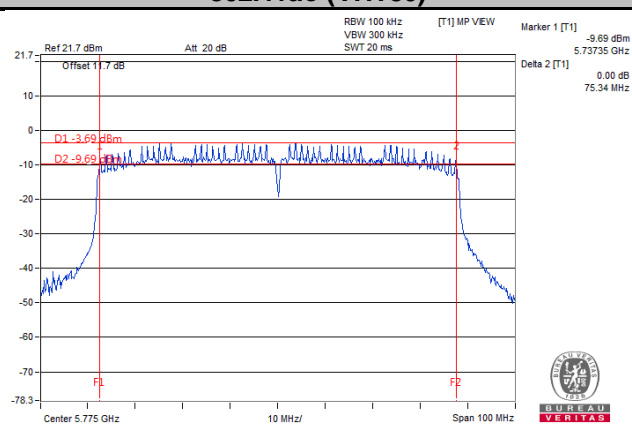



## 5 Pictures of Test Arrangements

Please refer to the attached file (Test Setup Photo).

# Annex A- Radiated Out of Band Emisison (OOBE) Measurement (For U-NII-3 band)

## 802.11a

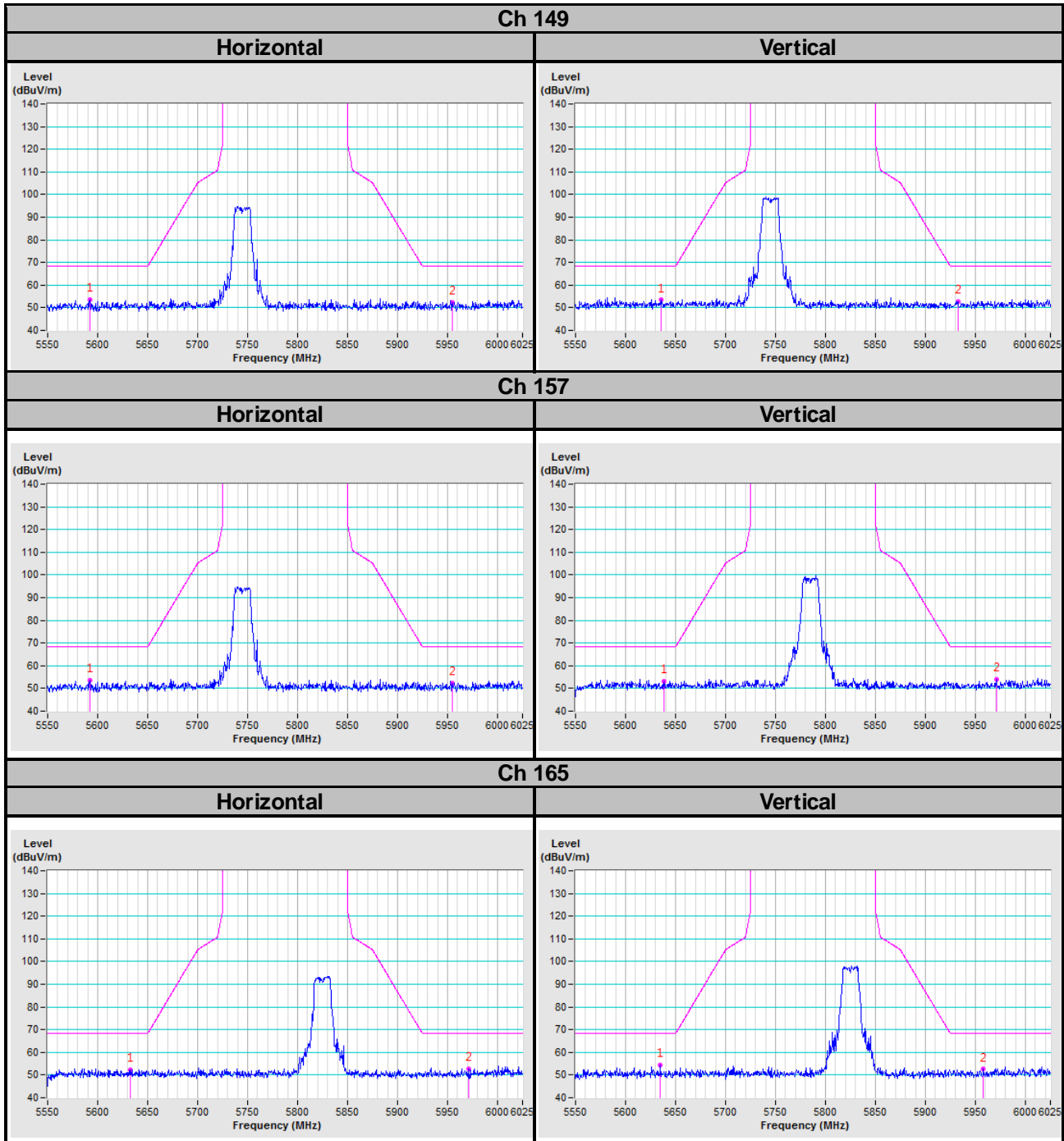

802.11n (HT20)

Ch 149

Horizontal

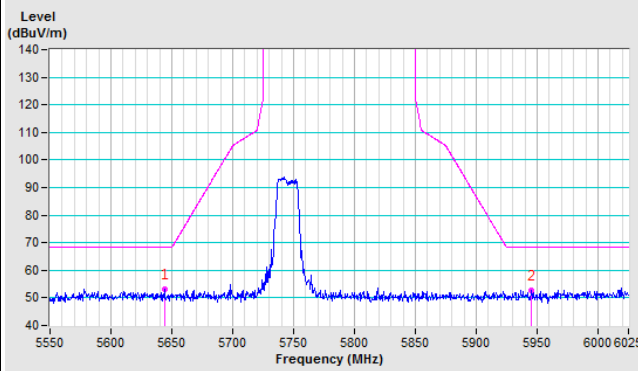

Vertical

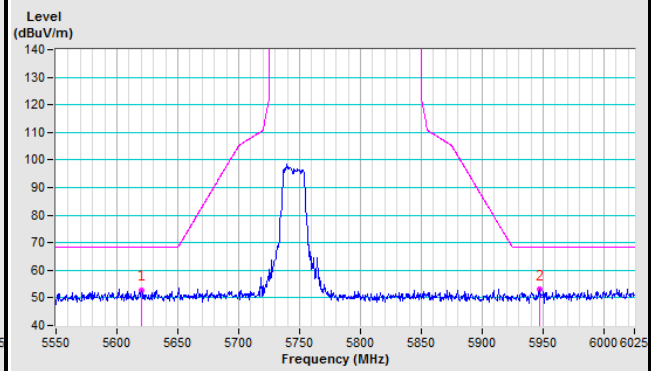

Ch 157

Horizontal

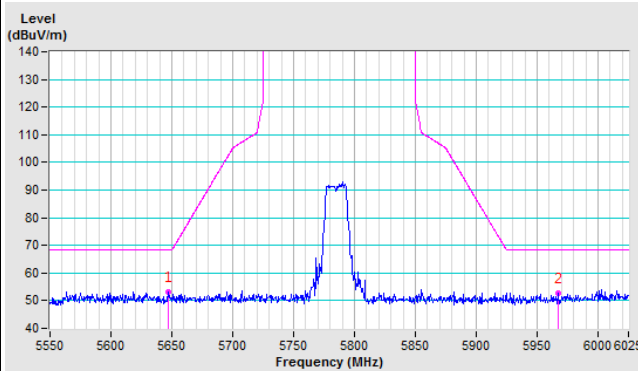

Vertical

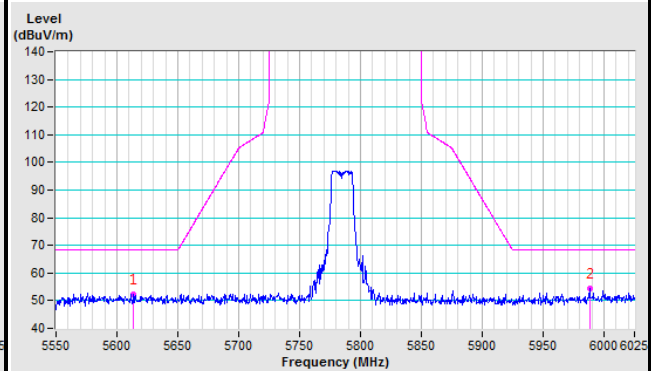

Ch 165

Horizontal

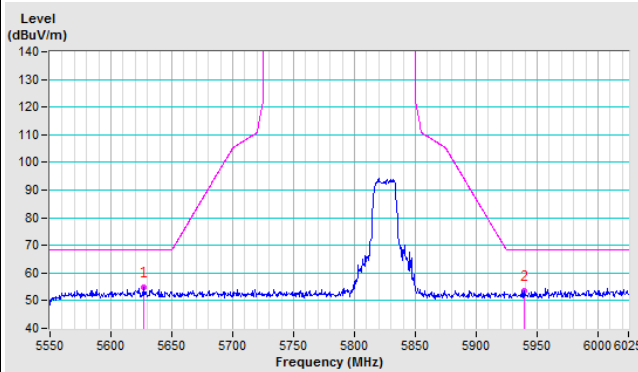

Vertical

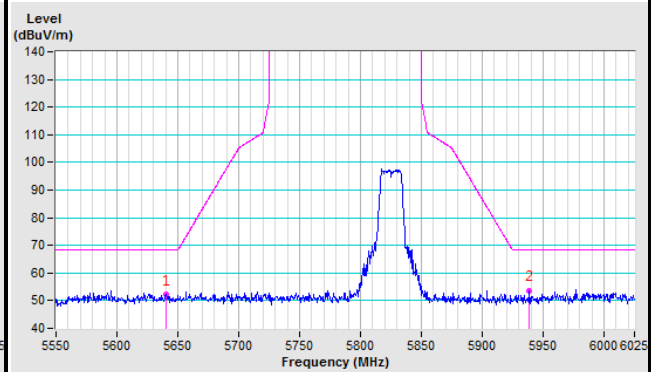

### 802.11n (HT40)

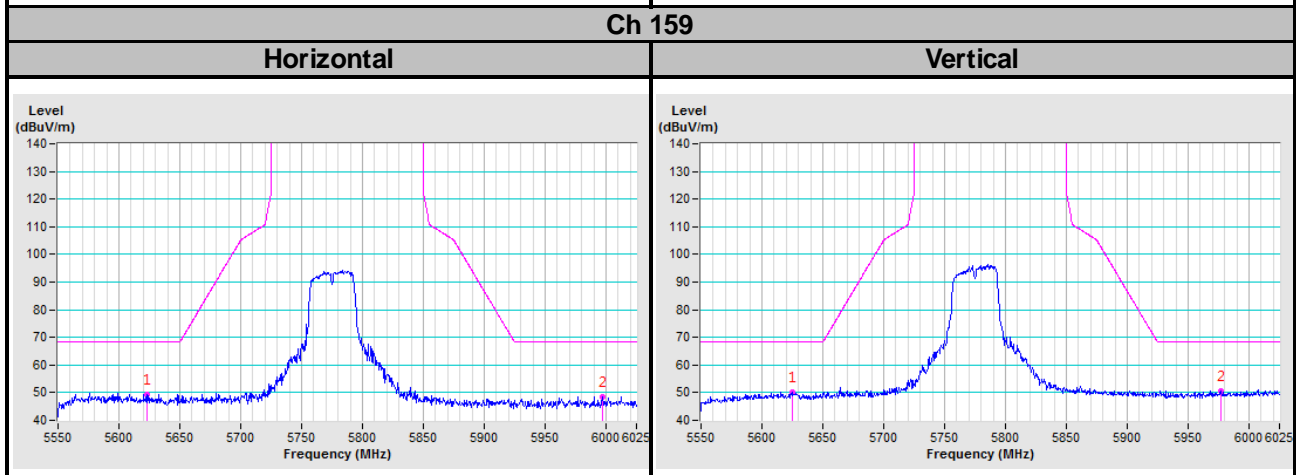
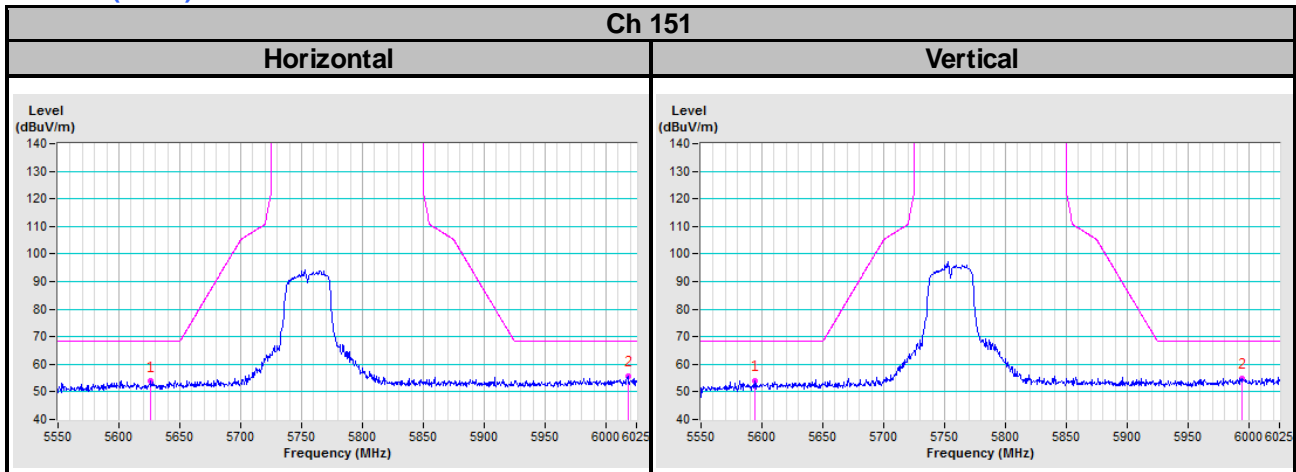

### 802.11ac (VHT80)

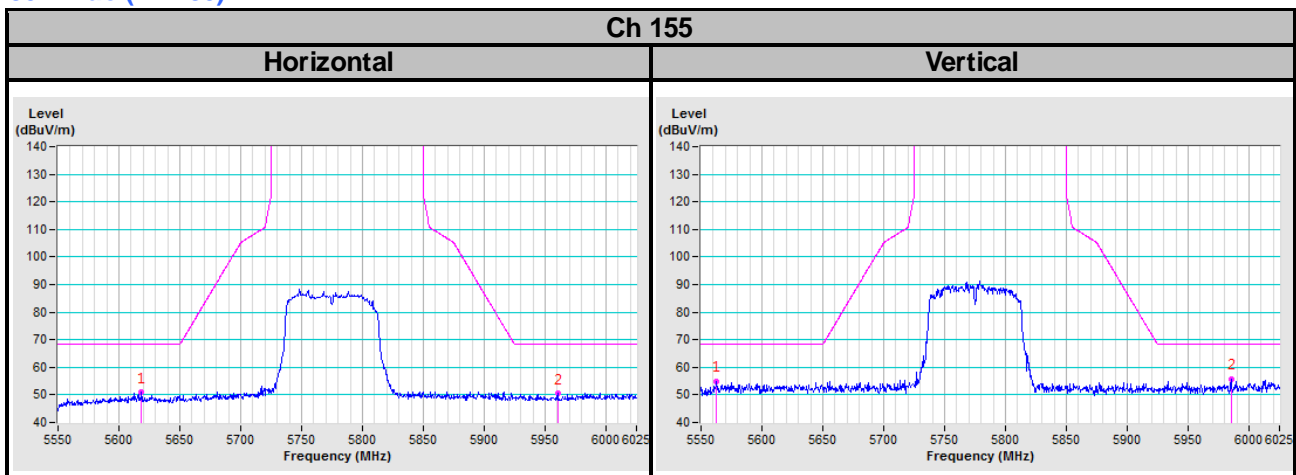

## Appendix – Information on the Testing Laboratories

We, Bureau Veritas Consumer Products Services (H.K.) Ltd., Taoyuan Branch, were founded in 1988 to provide our best service in EMC, Radio, Telecom and Safety consultation. Our laboratories are FCC recognized accredited test firms and accredited according to ISO/IEC 17025.

If you have any comments, please feel free to contact us at the following:

**Linko EMC/RF Lab**

Tel: 886-2-26052180

Fax: 886-2-26051924

**Hsin Chu EMC/RF/Telecom Lab**

Tel: 886-3-6668565

Fax: 886-3-6668323

**Hwa Ya EMC/RF/Safety**

Tel: 886-3-3183232

Fax: 886-3-3270892

**Email:** [service.adt@tw.bureauveritas.com](mailto:service.adt@tw.bureauveritas.com)

**Web Site:** [www.bureauveritas-adt.com](http://www.bureauveritas-adt.com)

The address and road map of all our labs can be found in our web site also.

--- END ---