

FCC Test Report

Report No.: RF180626C04-2

FCC ID: O57TBX605F

Test Model: Lenovo TB-X605F

Received Date: Jun. 26, 2018

Test Date: Jul. 17, 2018 ~ Jul. 27, 2018

Issued Date: Aug. 01, 2018

Applicant: Lenovo(Shanghai) Electronics Technology Co., Ltd.

Address: NO.68 BUILDING, 199 FENJU RD, China (Shanghai) Pilot Free Trade Zone, 200131, CHINA

Manufacturer: Lenovo PC HK Limited

Address: 23/F, Lincoln House, Taikoo Place 979 King's Road, Quarry Bay, Hong Kong

Issued By: Bureau Veritas Consumer Products Services (H.K.) Ltd., Taoyuan Branch

Lab Address: No. 47-2, 14th Ling, Chia Pau Vil., Lin Kou Dist., New Taipei City, Taiwan (R.O.C)

Test Location: No.19, Hwa Ya 2nd Rd., Wen Hwa Vil., Kwei Shan Dist., Taoyuan City 33383, Taiwan, R.O.C.

**FCC Registration /
Designation Number:** 788550 / TW0003



This report is for your exclusive use. Any copying or replication of this report to or for any other person or entity, or use of our name or trademark, is permitted only with our prior written permission. This report sets forth our findings solely with respect to the test samples identified herein. The results set forth in this report are not indicative or representative of the quality or characteristics of the lot from which a test sample was taken or any similar or identical product unless specifically and expressly noted. Our report includes all of the tests requested by you and the results thereof based upon the information that you provided to us. You have 60 days from date of issuance of this report to notify us of any material error or omission caused by our negligence, provided, however, that such notice shall be in writing and shall specifically address the issue you wish to raise. A failure to raise such issue within the prescribed time shall constitute your unqualified acceptance of the completeness of this report, the tests conducted and the correctness of the report contents. Unless specific mention, the uncertainty of measurement has been explicitly taken into account to declare the compliance or non-compliance to the specification. The report must not be used by the client to claim product certification, approval, or endorsement by TAF or any government agencies.

Table of Contents

Release Control Record	4
1 Certificate of Conformity	5
2 Summary of Test Results	6
2.1 Measurement Uncertainty	6
2.2 Modification Record.....	7
3 General Information	8
3.1 General Description of EUT	8
3.2 Description of Test Modes	10
3.2.1 Test Mode Applicability and Tested Channel Detail	11
3.3 Duty Cycle of Test Signal	13
3.4 Description of Support Units.....	14
3.4.1 Configuration of System under Test.....	14
3.5 General Description of Applied Standards	14
4 Test Types and Results	15
4.1 Radiated Emission and Bandedge Measurement	15
4.1.1 Limits of Radiated Emission and Bandedge Measurement	15
4.1.2 Test Instruments	16
4.1.3 Test Procedures.....	17
4.1.4 Deviation from Test Standard.....	17
4.1.5 Test Set Up	18
4.1.6 EUT Operating Conditions	19
4.1.7 Test Results	20
4.2 Conducted Emission Measurement	29
4.2.1 Limits of Conducted Emission Measurement	29
4.2.2 Test Instruments	29
4.2.3 Test Procedures.....	30
4.2.4 Deviation from Test Standard.....	30
4.2.5 Test Setup.....	30
4.2.6 EUT Operating Condition	30
4.2.7 Test Results	31
4.3 Number of Hopping Frequency Used	35
4.3.1 Limits of Hopping Frequency Used Measurement	35
4.3.2 Test Setup.....	35
4.3.3 Test Instruments	35
4.3.4 Test Procedure	35
4.3.5 Deviation from Test Standard.....	35
4.3.6 Test Results	36
4.4 Dwell Time on Each Channel	37
4.4.1 Limits of Dwell Time on Each Channel Measurement	37
4.4.2 Test Setup.....	37
4.4.3 Test Instruments	37
4.4.4 Test Procedures.....	37
4.4.5 Deviation from Test Standard.....	37
4.4.6 Test Results	38
4.5 Channel Bandwidth	40
4.5.1 Limits of Channel Bandwidth Measurement	40
4.5.2 Test Setup.....	40
4.5.3 Test Instruments	40
4.5.4 Test Procedure	40
4.5.5 Deviation from Test Standard.....	40
4.5.6 EUT Operating Condition	40
4.5.7 Test Results	41
4.6 Occupied Bandwidth Measurement	42

4.6.1	Test Setup	42
4.6.2	Test Instruments	42
4.6.3	Test Procedure	42
4.6.4	Deviation from Test Standard	42
4.6.5	EUT Operating Conditions	42
4.6.6	Test Results	43
4.7	Hopping Channel Separation	44
4.7.1	Limits of Hopping Channel Separation Measurement	44
4.7.2	Test Setup	44
4.7.3	Test Instruments	44
4.7.4	Test Procedure	44
4.7.5	Deviation from Test Standard	44
4.7.6	Test Results	45
4.8	Maximum Output Power	46
4.8.1	Limits of Maximum Output Power Measurement	46
4.8.2	Test Setup	46
4.8.3	Test Instruments	46
4.8.4	Test Procedure	46
4.8.5	Deviation from Test Standard	46
4.8.6	EUT Operating Condition	46
4.8.7	Test Results	47
4.9	Conducted Out of Band Emission Measurement	49
4.9.1	Limits Of Conducted Out of Band Emission Measurement	49
4.9.2	Test Instruments	49
4.9.3	Test Procedure	49
4.9.4	Deviation from Test Standard	49
4.9.5	EUT Operating Condition	49
4.9.6	Test Results	49
5	Pictures of Test Arrangements	54
	Appendix – Information on the Testing Laboratories	55

Release Control Record

Issue No.	Description	Date Issued
RF180626C04-2	Original Release	Aug. 01, 2018

1 Certificate of Conformity

Product: Portable Tablet Computer

Brand: Lenovo

Test Model: Lenovo TB-X605F

Sample Status: Production Unit

Applicant: Lenovo(Shanghai) Electronics Technology Co., Ltd.

Test Date: Jul. 17, 2018 ~ Jul. 27, 2018

Standards: 47 CFR FCC Part 15, Subpart C (Section 15.247)
ANSI C63.10:2013

The above equipment has been tested by **Bureau Veritas Consumer Products Services (H.K.) Ltd., Taoyuan Branch**, and found compliance with the requirement of the above standards. The test record, data evaluation & Equipment Under Test (EUT) configurations represented herein are true and accurate accounts of the measurements of the sample's RF characteristics under the conditions specified in this report.

Prepared by :

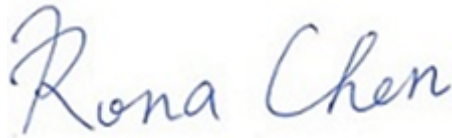

Date:

Aug. 01, 2018

Rona Chen / Specialist

Approved by :

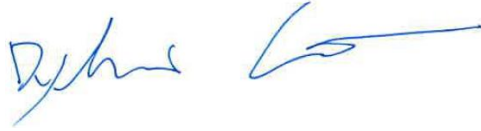

Date:

Aug. 01, 2018

Dylan Chiou / Project Engineer

2 Summary of Test Results

47 CFR FCC Part 15, Subpart C (Section 15.247)			
FCC Clause	Test Item	Result	Remarks
15.207	AC Power Conducted Emission	Pass	Meet the requirement of limit. Minimum passing margin is -9.77 dB at 0.16350 MHz.
15.247(a)(1)(iii)	Number of Hopping Frequency Used	Pass	Meet the requirement of limit.
15.247(a)(1)(iii)	Dwell Time on Each Channel	Pass	Meet the requirement of limit.
15.247(a)(1)	1. Hopping Channel Separation 2. Spectrum Bandwidth of a Frequency Hopping Sequence Spread Spectrum System	Pass	Meet the requirement of limit.
15.247(b)	Maximum Peak Output Power	Pass	Meet the requirement of limit.
---	Occupied Bandwidth Measurement	Pass	Reference only
15.205 & 209	Radiated Emissions	Pass	Meet the requirement of limit. Minimum passing margin is -3.9 dB at 58.55 MHz.
15.247(d)	Band Edge Measurement	Pass	Meet the requirement of limit.
15.247(d)	Antenna Port Emission	Pass	Meet the requirement of limit.
15.203	Antenna Requirement	Pass	No antenna connector is used.

Note: If The Frequency Hopping System operating in 2400-2483.5 MHz band and the output power less than 125 mW. The hopping channel carrier frequencies separated by a minimum of 25 kHz or two-thirds of the 20 dB bandwidth of hopping channel whichever is greater.

2.1 Measurement Uncertainty

Where relevant, the following measurement uncertainty levels have been estimated for tests performed on the EUT:

The listed uncertainties are the worst case uncertainty for the entire range of measurement. Please note that the uncertainty values are provided for informational purposes only and are not used in determining the PASS/FAIL results.

Measurement	Frequency	Expanded Uncertainty (k=2) (±)
Conducted Emissions at mains ports	150 kHz ~ 30 MHz	2.44 dB
Radiated Emissions up to 1 GHz	30 MHz ~ 200 MHz	3.86 dB
	200 MHz ~ 1000 MHz	3.87 dB
Radiated Emissions above 1 GHz	1 GHz ~ 18 GHz	2.29 dB
	18 GHz ~ 40 GHz	2.29 dB

2.2 Modification Record

There were no modifications required for compliance.

3 General Information

3.1 General Description of EUT

Product	Portable Tablet Computer
Brand	Lenovo
Test Model	Lenovo TB-X605F
Status of EUT	Production Unit
Power Supply Rating	3.85 Vdc (Battery) 5 Vdc (Adapter or host equipment)
Modulation Type	GFSK, $\pi/4$ -DQPSK, 8DPSK
Transfer Rate	1/2/3 Mbps
Operating Frequency	2402 ~ 2480 MHz
Number of Channel	79
Output Power	10.01 dBm / 10.023 mW
Antenna Type	Monopole antenna with -5 dBi gain
Antenna Connector	Coaxial Connector
Product HW Version	Lenovo Tablet TB-X605F
Product SW Version	TB-X605F_RF01_20180615
Accessory Device	Refer to Note as below
Data Cable Supplied	Refer to Note as below

Note:

- The EUT contains following accessory devices.

Product	Brand	Model	Description
Adapter 1	Salom	SC-41	I/P: 100-240 Vac, 50/60 Hz, 0.3 A O/P: 5 Vdc, 2 A
Adapter 2	AcBel	SC-41	I/P: 100-240 Vac, 50/60 Hz, 0.3 A O/P: 5 Vdc, 2 A
Battery	ATL	L18D1P32	3.85 Vdc, 4850 mAh
USB Cable 1 (White)	LiQi	LQ-02300039	1 m shielded cable w/o core
USB Cable 2 (Black)	LiQi	LQ-02300040	1 m shielded cable w/o core
LCD Panel 1 (Black)	BOE	TV101WUM-LL2	10.1 "
LCD Panel 2 (White)	BOE	TV101WUM-LL3	10.1 "
Photo Camera 1	Lcetron	LE5143AM	5M AF
Photo Camera 2	Holitek	MF81Q	5M AF
Photo Camera 3	Lcetron	ZRT2509V-P102F	2M FF
Photo Camera 4	Holitek	HSU1005	2M FF
CPU	Qualcomm	SDA450	792nsp

* USB Cable 1 and USB Cable 2 is electrically identical, difference models are for color distinguished. Therefore, only USB Cable 1 is as a representative for final test.

* LCD Panel 1 and LCD Panel 2 is electrically identical, difference models are for color distinguished. Therefore, only LCD Panel 2 is as a representative for final test.

Product	Brand	Model	Description
EMMC1 + DDR1	SAMSUNG	KMQE60013M-B318 (2+16)	16G
EMMC2 + DDR2	HYNIX	H9TQ17ABJTCCUR-KUM (2+16)	16G
EMMC3 + DDR3	SAMSUNG	KMGD6001BM-B421 (3+32)	32G
EMMC4 + DDR4	HYNIX	H9TQ27ADFTMCUR-KUM (3+32)	32G
EMMC5 + DDR5	SAMSUNG	KMRH60014A-B614 (4+64)	64G
EMMC6 + DDR6	HYNIX	H9TQ52ACLTMCUR-KUM (4+64)	64G
Speaker 1	Keysound	QM171219AW84	--
Speaker 2	Keysound	QM171219AW85	--
Motor 1	AWA	YK2455R	--
Motor 2	Baolong	BLX-431320S	--
Main Board 1	huashen	W93M71B2-3-03	--
Main Board 2	yilianda	W93M71B2-3-05	--
BT/WLAN Module	Qualcomm	WCN-3680B-0-79BWLNSP	--

- The Adapter 1 and Adapter 2 had been pre-tested to determine the worst-case. The worst case was found in Adapter 1. Therefore, only Adapter 1 was chosen for the final test.
- The EUT contains two samples.

Sample	Configurations
A	EUT + LCD Panel 2 + Photo Camera 1 + Photo Camera 3 + EMMC 3 + DDR 3 + Speaker 1 + Speaker 2 + Motor 2 + Main Board 1 + BT/WLAN Module + Battery
B	EUT + LCD Panel 2 + Photo Camera 2 + Photo Camera 4 + EMMC 4 + DDR 4 + Speaker 1 + Speaker 2 + Motor 1 + Main Board 2 + BT/WLAN Module + Battery

- The above EUT information is declared by manufacturer and for more detailed features description, please refers to the manufacturer's specifications or user's manual.

3.2 Description of Test Modes

79 channels are provided to this EUT:

Channel	Freq. (MHz)	Channel	Freq. (MHz)	Channel	Freq. (MHz)	Channel	Freq. (MHz)
0	2402	20	2422	40	2442	60	2462
1	2403	21	2423	41	2443	61	2463
2	2404	22	2424	42	2444	62	2464
3	2405	23	2425	43	2445	63	2465
4	2406	24	2426	44	2446	64	2466
5	2407	25	2427	45	2447	65	2467
6	2408	26	2428	46	2448	66	2468
7	2409	27	2429	47	2449	67	2469
8	2410	28	2430	48	2450	68	2470
9	2411	29	2431	49	2451	69	2471
10	2412	30	2432	50	2452	70	2472
11	2413	31	2433	51	2453	71	2473
12	2414	32	2434	52	2454	72	2474
13	2415	33	2435	53	2455	73	2475
14	2416	34	2436	54	2456	74	2476
15	2417	35	2437	55	2457	75	2477
16	2418	36	2438	56	2458	76	2478
17	2419	37	2439	57	2459	77	2479
18	2420	38	2440	58	2460	78	2480
19	2421	39	2441	59	2461		

3.2.1 Test Mode Applicability and Tested Channel Detail

EUT Configure Mode	Applicable To				Description
	RE \geq 1G	RE $<$ 1G	PLC	APCM	
A	√	√	√	√	Sample A
B	-	√	√	-	Sample B

Where **RE \geq 1G**: Radiated Emission above 1 GHz **RE $<$ 1G**: Radiated Emission below 1 GHz
PLC: Power Line Conducted Emission **APCM**: Antenna Port Conducted Measurement

NOTE:

- The EUT had been pre-tested on the positioned of each 3 axis. The worst case was found when positioned on **X-plane**.
- "-" means no effect.

Radiated Emission Test (Above 1 GHz):

- Pre-Scan has been conducted to determine the worst-case mode from all possible combinations between available modulations, data rates and antenna ports (if EUT with antenna diversity architecture).
- Following channel(s) was (were) selected for the final test as listed below.

EUT Configure Mode	Available Channel	Tested Channel	Modulation Technology	Modulation Type	Packet Type
A	0 to 78	0, 39, 78	FHSS	GFSK	DH5
	0 to 78	0, 39, 78	FHSS	8DPSK	3DH5

Radiated Emission Test (Below 1 GHz):

- Pre-Scan has been conducted to determine the worst-case mode from all possible combinations between available modulations, data rates and antenna ports (if EUT with antenna diversity architecture).
- Following channel(s) was (were) selected for the final test as listed below.

EUT Configure Mode	Available Channel	Tested Channel	Modulation Technology	Modulation Type	Packet Type
A, B	0 to 78	0	FHSS	GFSK	DH5

Power Line Conducted Emission Test:

- Pre-Scan has been conducted to determine the worst-case mode from all possible combinations between available modulations, data rates and antenna ports (if EUT with antenna diversity architecture).
- Following channel(s) was (were) selected for the final test as listed below.

EUT Configure Mode	Test Condition
A, B	BT + USB Cable + Adapter

Antenna Port Conducted Measurement:

- This item includes all test value of each mode, but only includes spectrum plot of worst value of each mode.
- Pre-Scan has been conducted to determine the worst-case mode from all possible combinations between available modulations, data rates and antenna ports (if EUT with antenna diversity architecture).
- Following channel(s) was (were) selected for the final test as listed below.

EUT Configure Mode	Available Channel	Tested Channel	Modulation Technology	Modulation Type	Packet Type
A	0 to 78	0, 39, 78	FHSS	GFSK	DH5
	0 to 78	0, 39, 78	FHSS	8DPSK	3DH5

Test Condition:

Applicable To	Environmental Conditions	Input Power	Tested by
RE \geq 1G	25 deg. C, 65 % RH	120 Vac, 60 Hz	Adair Peng
RE $<$ 1G	25 deg. C, 65 % RH	120 Vac, 60 Hz	Adair Peng
PLC	25 deg. C, 65 % RH	120 Vac, 60 Hz	Adair Peng
APCM	25 deg. C, 65 % RH	3.85 Vdc	Frank Chiu

3.3 Duty Cycle of Test Signal

GFSK

Duty cycle = $2.874/3.753 = 0.766$, Duty factor = $10 * \log(1/0.766) = 1.16$

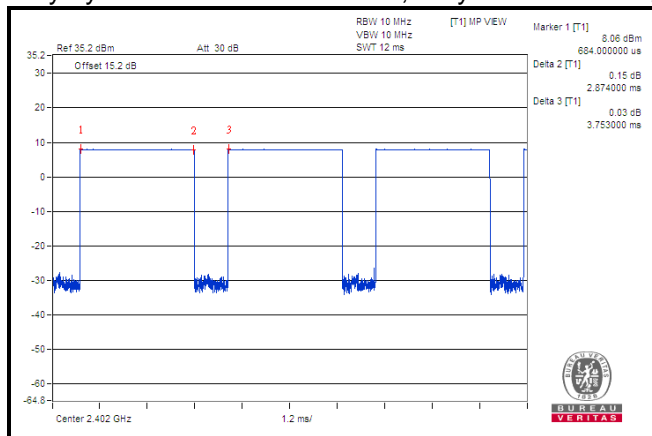

8DPSK

Duty cycle = $2.877/3.891 = 0.739$, Duty factor = $10 * \log(1/0.739) = 1.31$

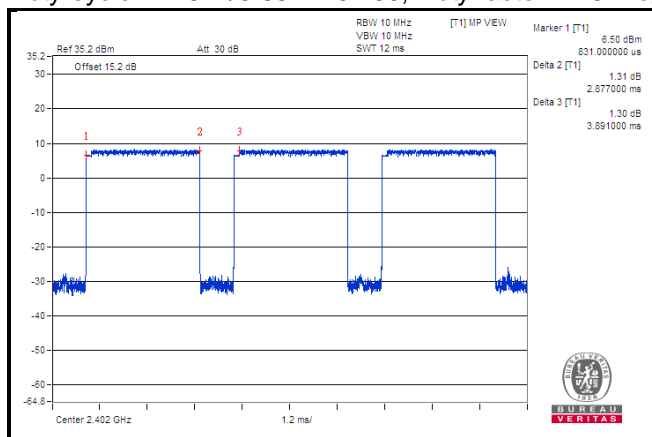

3.4 Description of Support Units

The EUT has been tested as an independent unit together with other necessary accessories or support units. The following support units or accessories were used to form a representative test configuration during the tests.

No.	Product	Brand	Model No.	Serial No.	FCC ID
1.	Earphone	N/A	N/A	N/A	N/A

No.	Signal Cable Description of The Above Support Units
1.	N/A

Note:

1. All power cords of the above support units are non-shielded (1.8m).

3.4.1 Configuration of System under Test

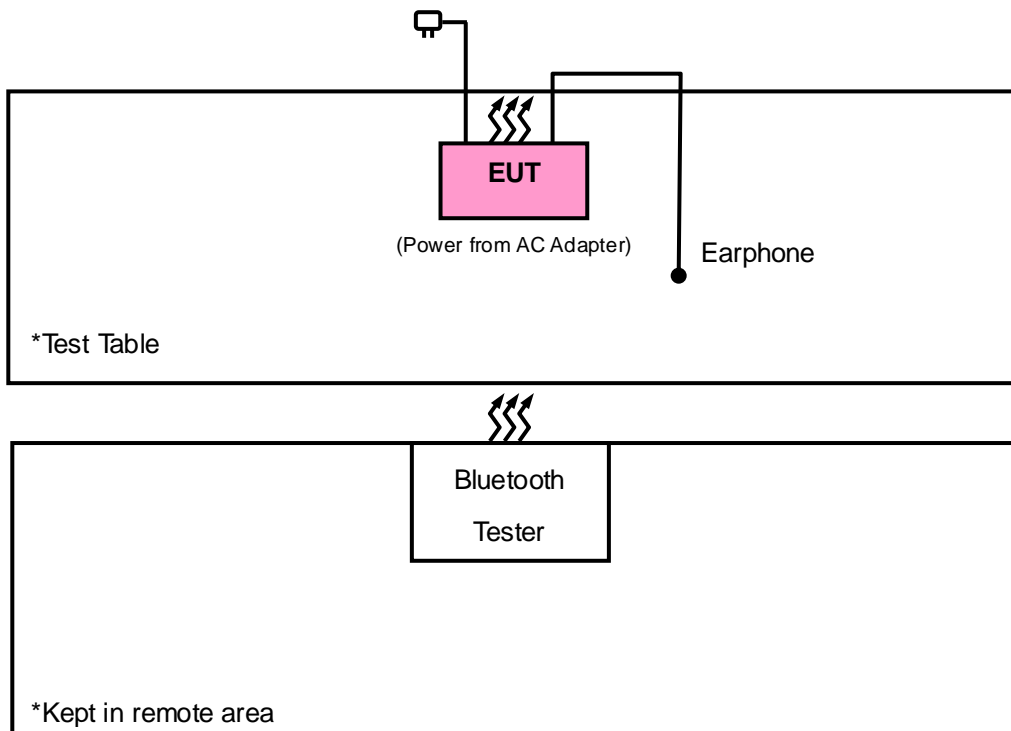

3.5 General Description of Applied Standards

The EUT is a RF Product. According to the specifications of the manufacturer, it must comply with the requirements of the following standards:

FCC Part 15, Subpart C (15.247)

ANSI C63.10-2013

All test items have been performed and recorded as per the above standards.

4 Test Types and Results

4.1 Radiated Emission and Bandedge Measurement

4.1.1 Limits of Radiated Emission and Bandedge Measurement

Radiated emissions which fall in the restricted bands must comply with the radiated emission limits specified as below table. Other emissions shall be at least 20 dB below the highest level of the desired power:

Frequencies (MHz)	Field Strength (microvolts/meter)	Measurement Distance (meters)
0.009 ~ 0.490	2400/F (kHz)	300
0.490 ~ 1.705	24000/F (kHz)	30
1.705 ~ 30.0	30	30
30 ~ 88	100	3
88 ~ 216	150	3
216 ~ 960	200	3
Above 960	500	3

Note:

1. The lower limit shall apply at the transition frequencies.
2. Emission level (dBuV/m) = 20 log Emission level (uV/m).
3. For frequencies above 1000 MHz, the field strength limits are based on average detector, however, the peak field strength of any emission shall not exceed the maximum permitted average limits, specified above by more than 20 dB under any condition of modulation.

4.1.2 Test Instruments

Description & Manufacturer	Model No.	Serial No.	Date of Calibration	Due Date of Calibration
Test Receiver ROHDE & SCHWARZ	ESIB7	100187	May 29, 2018	May 28, 2019
Spectrum Analyzer ROHDE & SCHWARZ	FSU43	101261	Jan. 11, 2018	Jan. 10, 2019
BILOG Antenna SCHWARZBECK	VULB9168	9168-171	Dec. 11, 2017	Dec. 10, 2018
HORN Antenna SCHWARZBECK	9120D	209	Dec. 13, 2017	Dec. 12, 2018
HORN Antenna SCHWARZBECK	BBHA 9170	BBHA9170241	Dec. 01, 2017	Nov. 30, 2018
1W Rotary Attenuator Woken	00801A1GGAM02Y	NA	May 17, 2018	May 16, 2019
Bluetooth Tester	CBT	100980	Jun. 28, 2017	Jun. 27, 2019
Loop Antenna	EM-6879	269	Aug. 11, 2017	Aug. 10, 2018
Preamplifier Agilent (Below 1GHz)	8447D	2944A10738	Aug. 21, 2017	Aug. 20, 2018
Preamplifier Agilent (Above 1GHz)	8449B	3008A02465	Apr. 03, 2018	Apr. 02, 2019
Power Meter Anritsu	ML2495A	1012010	Aug. 15, 2017	Aug. 14, 2018
Power Sensor Anritsu	MA2411B	1315050	Aug. 15, 2017	Aug. 14, 2018
RF signal cable HUBER+SUHNER	SUCOFLEX 104	Cable-CH3-03 (223653/4)	Aug. 21, 2017	Aug. 20, 2018
RF signal cable HUBER+SUHNER& EMCI	SUCOFLEX 104&EMC104-SM- SM-8000	Cable-CH3-03 (309224+170907)	Sep.11, 2017	Sep. 10, 2018
Boresight Antenna Fixture	FBA-01	FBA-SIP01	NA	NA
Software BV ADT	ADT_Radiated_ V7.6.15.9.5	NA	NA	NA
Antenna Tower inn-co GmbH	MA 4000	013303	NA	NA
Antenna Tower Controller BV ADT	AT100	AT93021702	NA	NA
Turn Table BV ADT	TT100	TT93021702	NA	NA
Turn Table Controller BV ADT	SC100	SC93021702	NA	NA

- Note: 1. The calibration interval of the above test instruments is 12 / 24 months and the calibrations are traceable to NML/ROC and NIST/USA.
2. The test was performed in HwaYa Chamber 3.
3. The horn antenna and preamplifier (model: 8449B) are used only for the measurement of emission frequency above 1 GHz if tested.
4. The IC Site Registration No. is 7450F-3.

4.1.3 Test Procedures

For Radiated Emission below 30 MHz

- a. The EUT was placed on the top of a rotating table 0.8 meters above the ground at a 3 meter chamber room. The table was rotated 360 degrees to determine the position of the highest radiation.
- b. The EUT was set 3 meters away from the interference-receiving antenna, which was mounted on the top of a variable-height antenna tower.
- c. Both Parallel, perpendicular, and ground-parallel orientations of the antenna are set to make the measurement.
- d. For each suspected emission, the EUT was arranged to its worst case and the rotatable table was turned from 0 degrees to 360 degrees to find the maximum reading.
- e. The test-receiver system was set to Quasi-Peak Detect Function and Specified Bandwidth with Maximum Hold Mode.

Note:

1. The resolution bandwidth and video bandwidth of test receiver/spectrum analyzer is 9 kHz at frequency below 30 MHz.

For Radiated Emission above 30 MHz

- a. The EUT was placed on the top of a rotating table 0.8 meters (for 30 MHz ~ 1 GHz) / 1.5 meters (for above 1 GHz) above the ground at 3 meter chamber room for test. The table was rotated 360 degrees to determine the position of the highest radiation.
- b. The EUT was set 3 meters away from the interference-receiving antenna, which was mounted on the top of a variable-height antenna tower.
- c. The height of antenna is varied from one meter to four meters above the ground to determine the maximum value of the field strength. Both horizontal and vertical polarizations of the antenna are set to make the measurement.
- d. For each suspected emission, the EUT was arranged to its worst case and then the antenna was tuned to heights from 1 meter to 4 meters and the rotatable table was turned from 0 degrees to 360 degrees to find the maximum reading.
- e. The test-receiver system was set to quasi-peak detect function and specified bandwidth with maximum hold mode when the test frequency is below 1 GHz.
- f. The test-receiver system was set to peak and average detected function and specified bandwidth with maximum hold mode when the test frequency is above 1 GHz. If the peak reading value also meets average limit, measurement with the average detector is unnecessary.

Note:

1. The resolution bandwidth and video bandwidth of test receiver/spectrum analyzer is 120 kHz for Quasi-peak detection (QP) at frequency below 1 GHz.
2. The resolution bandwidth of test receiver/spectrum analyzer is 1 MHz and the video bandwidth is 3 MHz for Peak detection (PK) at frequency above 1 GHz.
3. The resolution bandwidth of test receiver/spectrum analyzer is 1 MHz and the video bandwidth is $\geq 1/T$ (Duty cycle < 98 %) or 10 Hz (Duty cycle ≥ 98 %) for Average detection (AV) at frequency above 1 GHz. (RBW = 1 MHz, VBW = 1 kHz)
4. All modes of operation were investigated and the worst-case emissions are reported.

4.1.4 Deviation from Test Standard

No deviation.

4.1.5 Test Set Up

<Radiated Emission below 30 MHz>

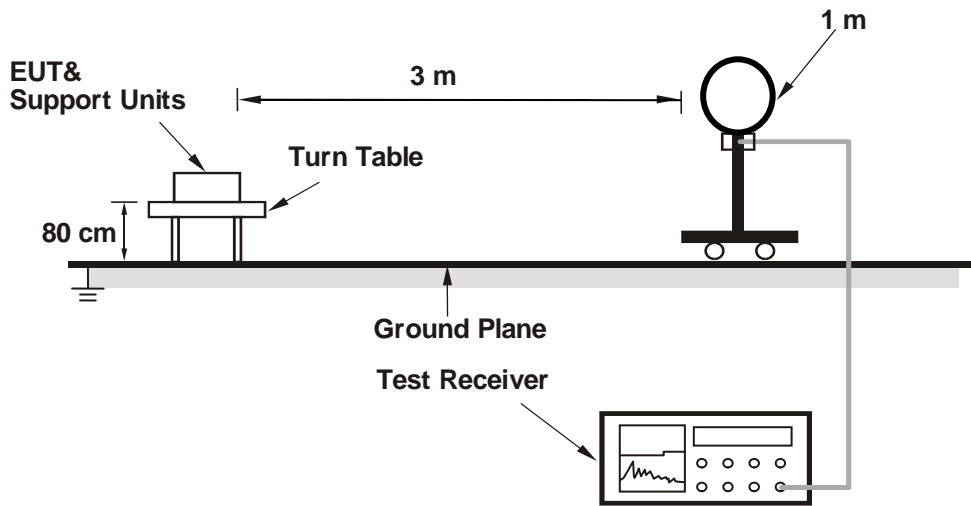

<Radiated Emission 30 MHz to 1 GHz>

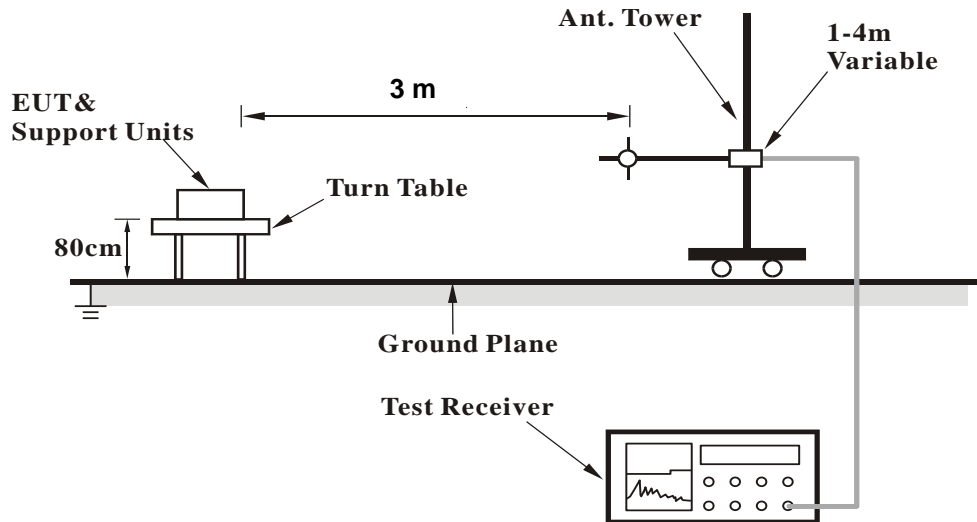

<Radiated Emission above 1 GHz>

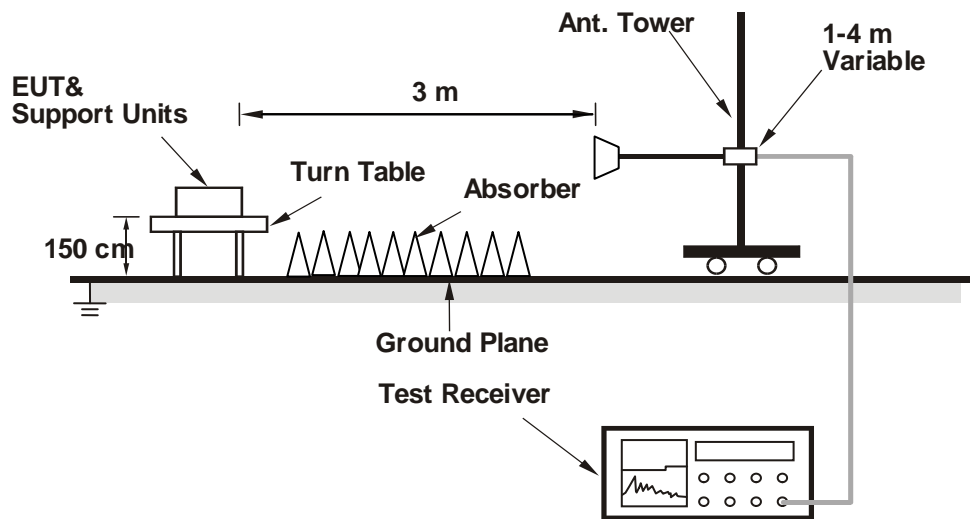

For the actual test configuration, please refer to the attached file (Test Setup Photo).

4.1.6 EUT Operating Conditions

Set the EUT under transmission condition continuously at specific channel frequency.

4.1.7 Test Results

Above 1 GHz Data:

Mode A

GFSK

CHANNEL	TX Channel 0	DETECTOR FUNCTION	Peak (PK)
FREQUENCY RANGE	1GHz ~ 25GHz		Average (AV)

ANTENNA POLARITY & TEST DISTANCE: HORIZONTAL AT 3 M

NO.	FREQ. (MHz)	EMISSION LEVEL (dBuV/m)	LIMIT (dBuV/m)	MARGIN (dB)	ANTENNA HEIGHT (m)	TABLE ANGLE (Degree)	RAW VALUE (dBuV)	CORRECTION FACTOR (dB/m)
1	2390.00	60.8 PK	74.0	-13.2	3.11 H	104	27.3	33.5
2	2390.00	48.1 AV	54.0	-5.9	3.11 H	104	14.6	33.5
3	*2402.00	99.4 PK			3.09 H	99	66.0	33.4
4	*2402.00	98.6 AV			3.09 H	99	65.2	33.4
5	4804.00	45.4 PK	74.0	-28.6	2.03 H	255	41.5	3.9
6	4804.00	32.1 AV	54.0	-21.9	2.03 H	255	28.2	3.9

ANTENNA POLARITY & TEST DISTANCE: VERTICAL AT 3 M

NO.	FREQ. (MHz)	EMISSION LEVEL (dBuV/m)	LIMIT (dBuV/m)	MARGIN (dB)	ANTENNA HEIGHT (m)	TABLE ANGLE (Degree)	RAW VALUE (dBuV)	CORRECTION FACTOR (dB/m)
1	2390.00	60.0 PK	74.0	-14.0	3.91 V	60	26.5	33.5
2	2390.00	47.8 AV	54.0	-6.2	3.91 V	60	14.3	33.5
3	*2402.00	97.1 PK			3.88 V	62	63.7	33.4
4	*2402.00	96.2 AV			3.88 V	62	62.8	33.4
5	4804.00	45.1 PK	74.0	-28.9	3.50 V	333	41.2	3.9
6	4804.00	31.9 AV	54.0	-22.1	3.50 V	333	28.0	3.9

REMARKS:

1. Emission Level(dBuV/m) = Raw Value(dBuV) + Correction Factor(dB/m)
2. Correction Factor(dB/m) = Antenna Factor(dB/m) + Cable Factor(dB) – Pre-Amplifier Factor(dB)
3. The other emission levels were very low against the limit.
4. Margin value = Emission Level – Limit value
5. " * ": Fundamental frequency.

CHANNEL	TX Channel 39	DETECTOR FUNCTION	Peak (PK)
FREQUENCY RANGE	1GHz ~ 25GHz		Average (AV)

ANTENNA POLARITY & TEST DISTANCE: HORIZONTAL AT 3 M

NO.	FREQ. (MHz)	EMISSION LEVEL (dBuV/m)	LIMIT (dBuV/m)	MARGIN (dB)	ANTENNA HEIGHT (m)	TABLE ANGLE (Degree)	RAW VALUE (dBuV)	CORRECTION FACTOR (dB/m)
1	*2441.00	101.1 PK			3.22 H	89	67.7	33.4
2	*2441.00	100.3 AV			3.22 H	89	66.9	33.4
3	4882.00	46.3 PK	74.0	-27.7	2.15 H	263	42.7	3.6
4	4882.00	32.5 AV	54.0	-21.5	2.15 H	263	28.9	3.6

ANTENNA POLARITY & TEST DISTANCE: VERTICAL AT 3 M

NO.	FREQ. (MHz)	EMISSION LEVEL (dBuV/m)	LIMIT (dBuV/m)	MARGIN (dB)	ANTENNA HEIGHT (m)	TABLE ANGLE (Degree)	RAW VALUE (dBuV)	CORRECTION FACTOR (dB/m)
1	*2441.00	99.1 PK			2.46 V	73	65.7	33.4
2	*2441.00	98.3 AV			2.46 V	73	64.9	33.4
3	4882.00	45.9 PK	74.0	-28.1	3.55 V	322	42.3	3.6
4	4882.00	32.2 AV	54.0	-21.8	3.55 V	322	28.6	3.6

REMARKS:

1. Emission Level(dBuV/m) = Raw Value(dBuV) + Correction Factor(dB/m)
2. Correction Factor(dB/m) = Antenna Factor(dB/m) + Cable Factor(dB) – Pre-Amplifier Factor(dB)
3. The other emission levels were very low against the limit.
4. Margin value = Emission Level – Limit value
5. " * ": Fundamental frequency.

CHANNEL	TX Channel 78	DETECTOR FUNCTION	Peak (PK)
FREQUENCY RANGE	1GHz ~ 25GHz		Average (AV)

ANTENNA POLARITY & TEST DISTANCE: HORIZONTAL AT 3 M

NO.	FREQ. (MHz)	EMISSION LEVEL (dBuV/m)	LIMIT (dBuV/m)	MARGIN (dB)	ANTENNA HEIGHT (m)	TABLE ANGLE (Degree)	RAW VALUE (dBuV)	CORRECTION FACTOR (dB/m)
1	*2480.00	99.8 PK			3.07 H	91	66.6	33.2
2	*2480.00	99.1 AV			3.07 H	91	65.9	33.2
3	2483.50	60.6 PK	74.0	-13.4	3.15 H	100	27.4	33.2
4	2483.50	48.1 AV	54.0	-5.9	3.15 H	100	14.9	33.2
5	4960.00	47.0 PK	74.0	-27.0	1.99 H	249	43.3	3.7
6	4960.00	32.5 AV	54.0	-21.5	1.99 H	249	28.8	3.7

ANTENNA POLARITY & TEST DISTANCE: VERTICAL AT 3 M

NO.	FREQ. (MHz)	EMISSION LEVEL (dBuV/m)	LIMIT (dBuV/m)	MARGIN (dB)	ANTENNA HEIGHT (m)	TABLE ANGLE (Degree)	RAW VALUE (dBuV)	CORRECTION FACTOR (dB/m)
1	*2480.00	97.6 PK			3.17 V	60	64.4	33.2
2	*2480.00	96.7 AV			3.17 V	60	63.5	33.2
3	2483.50	60.6 PK	74.0	-13.4	3.20 V	65	27.4	33.2
4	2483.50	47.8 AV	54.0	-6.2	3.20 V	65	14.6	33.2
5	4960.00	46.7 PK	74.0	-27.3	3.47 V	315	43.0	3.7
6	4960.00	32.1 AV	54.0	-21.9	3.47 V	315	28.4	3.7

REMARKS:

1. Emission Level(dBuV/m) = Raw Value(dBuV) + Correction Factor(dB/m)
2. Correction Factor(dB/m) = Antenna Factor(dB/m) + Cable Factor(dB) – Pre-Amplifier Factor(dB)
3. The other emission levels were very low against the limit.
4. Margin value = Emission Level – Limit value
5. " * ": Fundamental frequency.

8DPSK

CHANNEL	TX Channel 0	DETECTOR FUNCTION	Peak (PK)
FREQUENCY RANGE	1GHz ~ 25GHz		Average (AV)

ANTENNA POLARITY & TEST DISTANCE: HORIZONTAL AT 3 M

NO.	FREQ. (MHz)	EMISSION LEVEL (dBuV/m)	LIMIT (dBuV/m)	MARGIN (dB)	ANTENNA HEIGHT (m)	TABLE ANGLE (Degree)	RAW VALUE (dBuV)	CORRECTION FACTOR (dB/m)
1	2390.00	60.2 PK	74.0	-13.8	3.09 H	95	26.7	33.5
2	2390.00	47.9 AV	54.0	-6.1	3.09 H	95	14.4	33.5
3	*2402.00	97.5 PK			3.11 H	100	64.1	33.4
4	*2402.00	93.7 AV			3.11 H	100	60.3	33.4
5	4804.00	45.3 PK	74.0	-28.7	2.20 H	254	41.4	3.9
6	4804.00	31.6 AV	54.0	-22.4	2.20 H	254	27.7	3.9

ANTENNA POLARITY & TEST DISTANCE: VERTICAL AT 3 M

NO.	FREQ. (MHz)	EMISSION LEVEL (dBuV/m)	LIMIT (dBuV/m)	MARGIN (dB)	ANTENNA HEIGHT (m)	TABLE ANGLE (Degree)	RAW VALUE (dBuV)	CORRECTION FACTOR (dB/m)
1	2390.00	60.1 PK	74.0	-13.9	3.50 V	55	26.6	33.5
2	2390.00	47.8 AV	54.0	-6.2	3.50 V	55	14.3	33.5
3	*2402.00	97.1 PK			3.41 V	60	63.7	33.4
4	*2402.00	93.0 AV			3.41 V	60	59.6	33.4
5	4804.00	45.0 PK	74.0	-29.0	3.33 V	340	41.1	3.9
6	4804.00	31.2 AV	54.0	-22.8	3.33 V	340	27.3	3.9

REMARKS:

1. Emission Level(dBuV/m) = Raw Value(dBuV) + Correction Factor(dB/m)
2. Correction Factor(dB/m) = Antenna Factor(dB/m) + Cable Factor(dB) – Pre-Amplifier Factor(dB)
3. The other emission levels were very low against the limit.
4. Margin value = Emission Level – Limit value
5. " * ": Fundamental frequency.

CHANNEL	TX Channel 39	DETECTOR FUNCTION	Peak (PK)
FREQUENCY RANGE	1GHz ~ 25GHz		Average (AV)

ANTENNA POLARITY & TEST DISTANCE: HORIZONTAL AT 3 M

NO.	FREQ. (MHz)	EMISSION LEVEL (dBuV/m)	LIMIT (dBuV/m)	MARGIN (dB)	ANTENNA HEIGHT (m)	TABLE ANGLE (Degree)	RAW VALUE (dBuV)	CORRECTION FACTOR (dB/m)
1	*2441.00	99.8 PK			3.18 H	89	66.4	33.4
2	*2441.00	95.7 AV			3.18 H	89	62.3	33.4
3	4882.00	46.0 PK	74.0	-28.0	2.09 H	247	42.4	3.6
4	4882.00	32.6 AV	54.0	-21.4	2.09 H	247	29.0	3.6

ANTENNA POLARITY & TEST DISTANCE: VERTICAL AT 3 M

NO.	FREQ. (MHz)	EMISSION LEVEL (dBuV/m)	LIMIT (dBuV/m)	MARGIN (dB)	ANTENNA HEIGHT (m)	TABLE ANGLE (Degree)	RAW VALUE (dBuV)	CORRECTION FACTOR (dB/m)
1	*2441.00	97.6 PK			3.38 V	64	64.2	33.4
2	*2441.00	93.6 AV			3.38 V	64	60.2	33.4
3	4882.00	45.7 PK	74.0	-28.3	3.59 V	339	42.1	3.6
4	4882.00	32.1 AV	54.0	-21.9	3.59 V	339	28.5	3.6

REMARKS:

1. Emission Level(dBuV/m) = Raw Value(dBuV) + Correction Factor(dB/m)
2. Correction Factor(dB/m) = Antenna Factor(dB/m) + Cable Factor(dB) – Pre-Amplifier Factor(dB)
3. The other emission levels were very low against the limit.
4. Margin value = Emission Level – Limit value
5. " * ": Fundamental frequency.

CHANNEL	TX Channel 78	DETECTOR FUNCTION	Peak (PK)
FREQUENCY RANGE	1GHz ~ 25GHz		Average (AV)

ANTENNA POLARITY & TEST DISTANCE: HORIZONTAL AT 3 M

NO.	FREQ. (MHz)	EMISSION LEVEL (dBuV/m)	LIMIT (dBuV/m)	MARGIN (dB)	ANTENNA HEIGHT (m)	TABLE ANGLE (Degree)	RAW VALUE (dBuV)	CORRECTION FACTOR (dB/m)
1	*2480.00	98.7 PK			3.11 H	89	65.5	33.2
2	*2480.00	94.7 AV			3.11 H	89	61.5	33.2
3	2483.50	60.0 PK	74.0	-14.0	3.15 H	93	26.8	33.2
4	2483.50	47.9 AV	54.0	-6.1	3.15 H	93	14.7	33.2
5	4960.00	46.3 PK	74.0	-27.7	2.09 H	263	42.6	3.7
6	4960.00	32.5 AV	54.0	-21.5	2.09 H	263	28.8	3.7

ANTENNA POLARITY & TEST DISTANCE: VERTICAL AT 3 M

NO.	FREQ. (MHz)	EMISSION LEVEL (dBuV/m)	LIMIT (dBuV/m)	MARGIN (dB)	ANTENNA HEIGHT (m)	TABLE ANGLE (Degree)	RAW VALUE (dBuV)	CORRECTION FACTOR (dB/m)
1	*2480.00	97.0 PK			3.56 V	65	63.8	33.2
2	*2480.00	93.0 AV			3.56 V	65	59.8	33.2
3	2483.50	59.7 PK	74.0	-14.3	3.60 V	61	26.5	33.2
4	2483.50	47.7 AV	54.0	-6.3	3.60 V	61	14.5	33.2
5	4960.00	45.9 PK	74.0	-28.1	3.29 V	299	42.2	3.7
6	4960.00	32.0 AV	54.0	-22.0	3.29 V	299	28.3	3.7

REMARKS:

1. Emission Level(dBuV/m) = Raw Value(dBuV) + Correction Factor(dB/m)
2. Correction Factor(dB/m) = Antenna Factor(dB/m) + Cable Factor(dB) – Pre-Amplifier Factor(dB)
3. The other emission levels were very low against the limit.
4. Margin value = Emission Level – Limit value
5. " * ": Fundamental frequency.

9 kHz ~ 30 MHz Data:

The amplitude of spurious emissions attenuated more than 20 dB below the permissible value is not required to be report.

30 MHz ~ 1 GHz Worst-Case Data:

GFSK

Mode A

CHANNEL	TX Channel 0	DETECTOR FUNCTION	Quasi-Peak (QP)
FREQUENCY RANGE	30MHz ~ 1GHz		

ANTENNA POLARITY & TEST DISTANCE: HORIZONTAL AT 3 M

NO.	FREQ. (MHz)	EMISSION LEVEL (dBuV/m)	LIMIT (dBuV/m)	MARGIN (dB)	ANTENNA HEIGHT (m)	TABLE ANGLE (Degree)	RAW VALUE (dBuV)	CORRECTION FACTOR (dB/m)
1	58.37	33.9 QP	40.0	-6.1	2.00 H	19	43.4	-9.5
2	166.03	37.2 QP	43.5	-6.3	1.48 H	93	46.1	-8.9
3	335.15	31.2 QP	46.0	-14.8	1.00 H	85	37.6	-6.4
4	432.37	30.0 QP	46.0	-16.0	1.99 H	111	34.1	-4.1
5	527.64	30.8 QP	46.0	-15.2	1.49 H	87	33.3	-2.5
6	624.85	31.9 QP	46.0	-14.1	1.49 H	15	31.8	0.1

ANTENNA POLARITY & TEST DISTANCE: VERTICAL AT 3 M

NO.	FREQ. (MHz)	EMISSION LEVEL (dBuV/m)	LIMIT (dBuV/m)	MARGIN (dB)	ANTENNA HEIGHT (m)	TABLE ANGLE (Degree)	RAW VALUE (dBuV)	CORRECTION FACTOR (dB/m)
1	58.55	36.1 QP	40.0	-3.9	1.00 V	45	45.6	-9.5
2	97.95	35.9 QP	43.5	-7.6	1.00 V	67	49.6	-13.7
3	142.67	34.0 QP	43.5	-9.5	1.00 V	90	43.1	-9.1
4	212.66	32.5 QP	43.5	-11.0	1.00 V	22	43.7	-11.2
5	335.15	28.1 QP	46.0	-17.9	1.50 V	65	34.5	-6.4
6	527.64	27.9 QP	46.0	-18.1	1.99 V	285	30.4	-2.5

REMARKS:

1. Emission Level(dBuV/m) = Raw Value(dBuV) + Correction Factor(dB/m)
2. Correction Factor(dB/m) = Antenna Factor(dB/m) + Cable Factor(dB) – Pre-Amplifier Factor(dB)
3. The other emission levels were very low against the limit.
4. Margin value = Emission Level – Limit value

Mode B

CHANNEL	TX Channel 0	DETECTOR FUNCTION	Quasi-Peak (QP)
FREQUENCY RANGE	30MHz ~ 1GHz		

ANTENNA POLARITY & TEST DISTANCE: HORIZONTAL AT 3 M

NO.	FREQ. (MHz)	EMISSION LEVEL (dBuV/m)	LIMIT (dBuV/m)	MARGIN (dB)	ANTENNA HEIGHT (m)	TABLE ANGLE (Degree)	RAW VALUE (dBuV)	CORRECTION FACTOR (dB/m)
1	57.12	28.2 QP	40.0	-11.8	1.99 H	10	37.7	-9.5
2	92.12	30.7 QP	43.5	-12.8	1.99 H	145	45.5	-14.8
3	160.17	31.2 QP	43.5	-12.3	1.49 H	8	39.9	-8.7
4	222.38	31.2 QP	46.0	-14.8	1.00 H	287	42.2	-11.0
5	498.47	27.9 QP	46.0	-18.1	1.99 H	19	30.8	-2.9
6	648.18	27.6 QP	46.0	-18.4	1.99 H	64	27.3	0.3

REMARKS:

1. Emission Level(dBuV/m) = Raw Value(dBuV) + Correction Factor(dB/m)
2. Correction Factor(dB/m) = Antenna Factor(dB/m) + Cable Factor(dB) – Pre-Amplifier Factor(dB)
3. The other emission levels were very low against the limit.
4. Margin value = Emission Level – Limit value

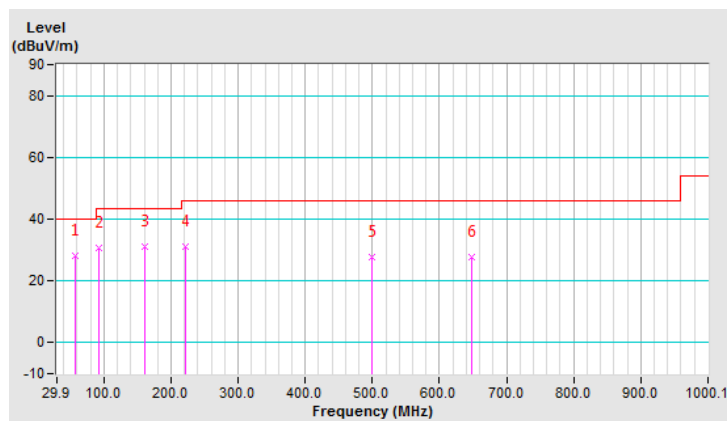

CHANNEL	TX Channel 0	DETECTOR FUNCTION	Quasi-Peak (QP)
FREQUENCY RANGE	30MHz ~ 1GHz		

ANTENNA POLARITY & TEST DISTANCE: VERTICAL AT 3 M

NO.	FREQ. (MHz)	EMISSION LEVEL (dBuV/m)	LIMIT (dBuV/m)	MARGIN (dB)	ANTENNA HEIGHT (m)	TABLE ANGLE (Degree)	RAW VALUE (dBuV)	CORRECTION FACTOR (dB/m)
1	57.12	27.8 QP	40.0	-12.2	1.00 V	303	37.3	-9.5
2	97.95	32.3 QP	43.5	-11.2	1.00 V	64	46.0	-13.7
3	164.06	28.3 QP	43.5	-15.2	1.00 V	126	37.2	-8.9
4	302.10	19.5 QP	46.0	-26.5	1.99 V	226	26.6	-7.1
5	480.97	25.4 QP	46.0	-20.6	1.00 V	324	28.7	-3.3
6	661.79	28.0 QP	46.0	-18.0	1.99 V	249	27.6	0.4

REMARKS:

1. Emission Level(dBuV/m) = Raw Value(dBuV) + Correction Factor(dB/m)
2. Correction Factor(dB/m) = Antenna Factor(dB/m) + Cable Factor(dB) – Pre-Amplifier Factor(dB)
3. The other emission levels were very low against the limit.
4. Margin value = Emission Level – Limit value

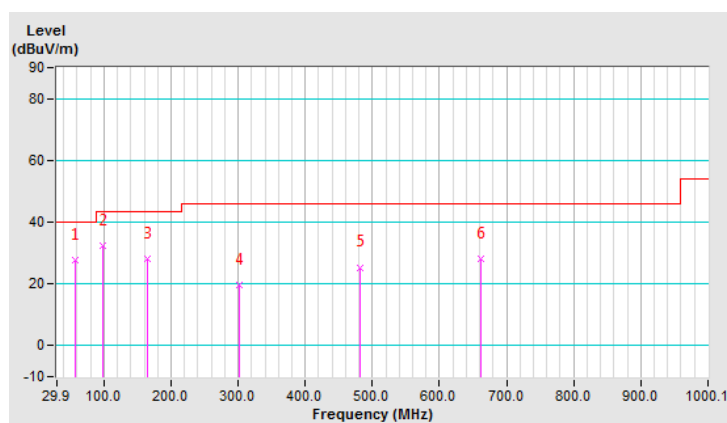

4.2 Conducted Emission Measurement

4.2.1 Limits of Conducted Emission Measurement

Frequency (MHz)	Conducted Limit (dBuV)	
	Quasi-Peak	Average
0.15 - 0.5	66 - 56	56 - 46
0.50 - 5.0	56	46
5.0 - 30.0	60	50

- Note: 1. The lower limit shall apply at the transition frequencies.
 2. The limit decreases in line with the logarithm of the frequency in the range of 0.15 to 0.50 MHz.

4.2.2 Test Instruments

Description & Manufacturer	Model No.	Serial No.	Date of Calibration	Due Date of Calibration
Test Receiver ROHDE & SCHWARZ	ESR3	102412	Feb. 08, 2018	Feb. 07, 2019
RF signal cable (with 10dB PAD) Woken	5D-FB	Cable-cond2-01	Sep. 08, 2017	Sep. 07, 2018
LISN/AMN ROHDE & SCHWARZ (EUT)	ESH2-Z5	100100	Feb. 05, 2018	Feb. 04, 2019
LISN/AMN ROHDE & SCHWARZ (Peripheral)	ESH3-Z5	100312	Aug. 02, 2017	Aug. 01, 2018
Software ADT	BV ADT_Cond_ V7.3.7.4	NA	NA	NA

- Note: 1. The calibration interval of the above test instruments is 12 months and the calibrations are traceable to NML/ROC and NIST/USA.
 2. The test was performed in HwaYa Shielded Room 2.
 3. The VCCI Site Registration No. is C-2047.

4.2.3 Test Procedures

- a. The EUT was placed 0.4 meters from the conducting wall of the shielded room with EUT being connected to the power mains through a line impedance stabilization network (LISN). Other support units were connected to the power mains through another LISN. The two LISNs provide 50 ohm/ 50 uH of coupling impedance for the measuring instrument.
- b. Both lines of the power mains connected to the EUT were checked for maximum conducted interference.
- c. The frequency range from 150 kHz to 30 MHz was searched. Emission levels under (Limit – 20 dB) was not recorded.

Note: The resolution bandwidth and video bandwidth of test receiver is 9 kHz for quasi-peak detection (QP) and average detection (AV) at frequency 0.15 MHz - 30 MHz.

4.2.4 Deviation from Test Standard

No deviation.

4.2.5 Test Setup

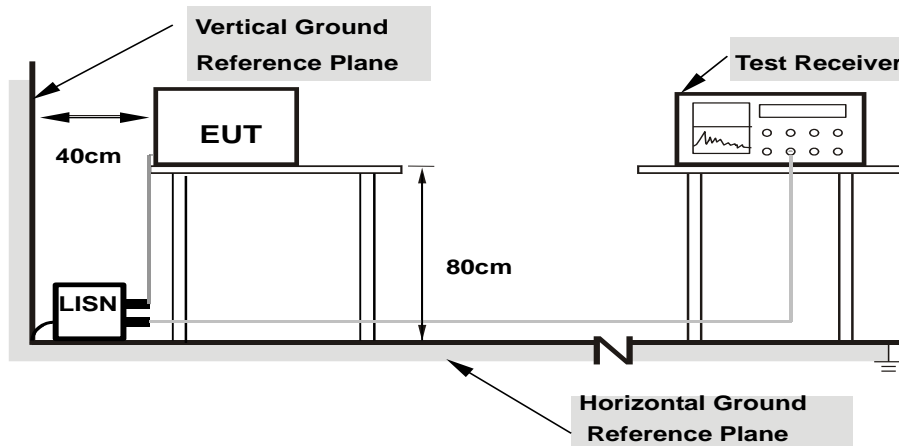

- Note:**
- 1.Support units were connected to second LISN.
 - 2.Both of LISNs (AMN) are 80 cm from EUT and at least 80 from other units and other metal planes

For the actual test configuration, please refer to the attached file (Test Setup Photo).

4.2.6 EUT Operating Condition

Set the EUT under transmission condition continuously at specific channel frequency.

4.2.7 Test Results

CONDUCTED WORST-CASE DATA : GFSK

Mode A

Frequency Range	150kHz ~ 30MHz	Detector Function & Resolution Bandwidth	Quasi-Peak (QP) / Average (AV), 9kHz
Input Power	120Vac, 60Hz	Environmental Conditions	22°C, 66%RH
Tested by	Adair Peng	Test Date	2018/7/20

Phase Of Power : Line (L)										
No	Frequency (MHz)	Correction Factor (dB)	Reading Value (dBuV)		Emission Level (dBuV)		Limit (dBuV)		Margin (dB)	
			Q.P.	AV.	Q.P.	AV.	Q.P.	AV.	Q.P.	AV.
1	0.16350	10.25	36.96	19.88	47.21	30.13	65.28	55.28	-18.07	-25.15
2	0.53362	10.28	19.65	9.74	29.93	20.02	56.00	46.00	-26.07	-25.98
3	2.26725	10.39	17.14	12.61	27.53	23.00	56.00	46.00	-28.47	-23.00
4	13.42050	10.66	11.49	6.50	22.15	17.16	60.00	50.00	-37.85	-32.84
5	14.85150	10.69	11.30	7.12	21.99	17.81	60.00	50.00	-38.01	-32.19
6	18.11400	10.79	16.53	11.07	27.32	21.86	60.00	50.00	-32.68	-28.14

Remarks:

1. Q.P. and AV. are abbreviations of quasi-peak and average individually.
2. The emission levels of other frequencies were very low against the limit.
3. Margin value = Emission level – Limit value
4. Correction factor = Insertion loss + Cable loss
5. Emission Level = Correction Factor + Reading Value

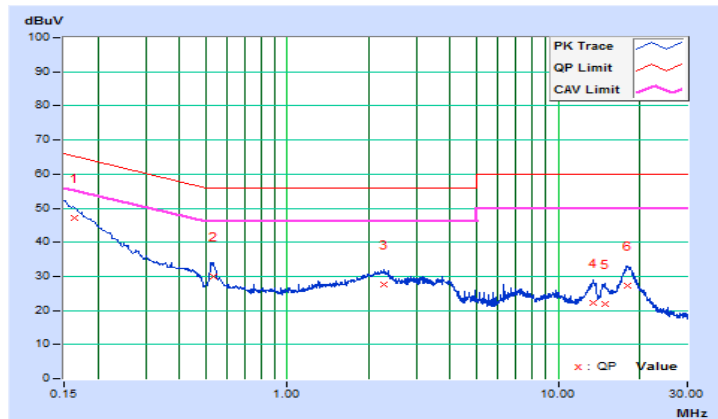

Frequency Range	150kHz ~ 30MHz	Detector Function & Resolution Bandwidth	Quasi-Peak (QP) / Average (AV), 9kHz
Input Power	120Vac, 60Hz	Environmental Conditions	22°C, 66%RH
Tested by	Adair Peng	Test Date	2018/7/20

Phase Of Power : Neutral (N)										
No	Frequency (MHz)	Correction Factor (dB)	Reading Value (dBuV)		Emission Level (dBuV)		Limit (dBuV)		Margin (dB)	
			Q.P.	AV.	Q.P.	AV.	Q.P.	AV.	Q.P.	AV.
1	0.16093	10.26	37.54	22.43	47.80	32.69	65.42	55.42	-17.62	-22.73
2	0.52662	10.29	23.58	15.31	33.87	25.60	56.00	46.00	-22.13	-20.40
3	2.33025	10.40	18.85	14.32	29.25	24.72	56.00	46.00	-26.75	-21.28
4	3.79950	10.46	15.28	10.67	25.74	21.13	56.00	46.00	-30.26	-24.87
5	13.40700	10.75	17.90	10.74	28.65	21.49	60.00	50.00	-31.35	-28.51
6	18.44250	10.93	15.34	9.82	26.27	20.75	60.00	50.00	-33.73	-29.25

Remarks:

1. Q.P. and AV. are abbreviations of quasi-peak and average individually.
2. The emission levels of other frequencies were very low against the limit.
3. Margin value = Emission level – Limit value
4. Correction factor = Insertion loss + Cable loss
5. Emission Level = Correction Factor + Reading Value

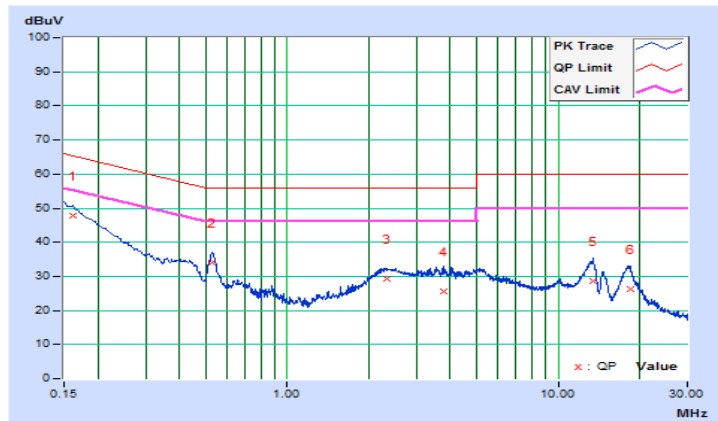

Mode B

Frequency Range	150kHz ~ 30MHz	Detector Function & Resolution Bandwidth	Quasi-Peak (QP) / Average (AV), 9kHz
Input Power	120Vac, 60Hz	Environmental Conditions	22°C, 66%RH
Tested by	Adair Peng	Test Date	2018/7/27

Phase Of Power : Line (L)										
No	Frequency (MHz)	Correction Factor (dB)	Reading Value (dBuV)		Emission Level (dBuV)		Limit (dBuV)		Margin (dB)	
			Q.P.	AV.	Q.P.	AV.	Q.P.	AV.	Q.P.	AV.
1	0.16350	10.25	45.26	30.33	55.51	40.58	65.28	55.28	-9.77	-14.70
2	0.26647	10.26	30.03	13.20	40.29	23.46	61.23	51.23	-20.94	-27.77
3	0.50751	10.28	23.30	11.70	33.58	21.98	56.00	46.00	-22.42	-24.02
4	2.24025	10.39	20.42	15.34	30.81	25.73	56.00	46.00	-25.19	-20.27
5	13.48800	10.66	17.80	12.38	28.46	23.04	60.00	50.00	-31.54	-26.96
6	18.70575	10.80	20.41	15.02	31.21	25.82	60.00	50.00	-28.79	-24.18

Remarks:

1. Q.P. and AV. are abbreviations of quasi-peak and average individually.
2. The emission levels of other frequencies were very low against the limit.
3. Margin value = Emission level – Limit value
4. Correction factor = Insertion loss + Cable loss
5. Emission Level = Correction Factor + Reading Value

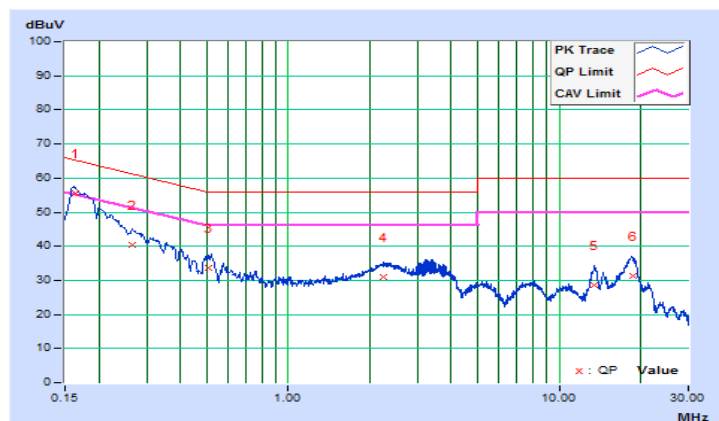

Frequency Range	150kHz ~ 30MHz	Detector Function & Resolution Bandwidth	Quasi-Peak (QP) / Average (AV), 9kHz
Input Power	120Vac, 60Hz	Environmental Conditions	22°C, 66%RH
Tested by	Adair Peng	Test Date	2018/7/27

Phase Of Power : Neutral (N)										
No	Frequency (MHz)	Correction Factor (dB)	Reading Value (dBuV)		Emission Level (dBuV)		Limit (dBuV)		Margin (dB)	
			Q.P.	AV.	Q.P.	AV.	Q.P.	AV.	Q.P.	AV.
1	0.16125	10.26	43.89	26.38	54.15	36.64	65.40	55.40	-11.25	-18.76
2	0.25144	10.27	32.60	18.32	42.87	28.59	61.71	51.71	-18.84	-23.12
3	0.58994	10.30	19.23	10.18	29.53	20.48	56.00	46.00	-26.47	-25.52
4	3.91875	10.47	19.65	13.76	30.12	24.23	56.00	46.00	-25.88	-21.77
5	13.54200	10.76	24.42	17.25	35.18	28.01	60.00	50.00	-24.82	-21.99
6	19.03650	10.95	18.57	13.46	29.52	24.41	60.00	50.00	-30.48	-25.59

Remarks:

1. Q.P. and AV. are abbreviations of quasi-peak and average individually.
2. The emission levels of other frequencies were very low against the limit.
3. Margin value = Emission level – Limit value
4. Correction factor = Insertion loss + Cable loss
5. Emission Level = Correction Factor + Reading Value

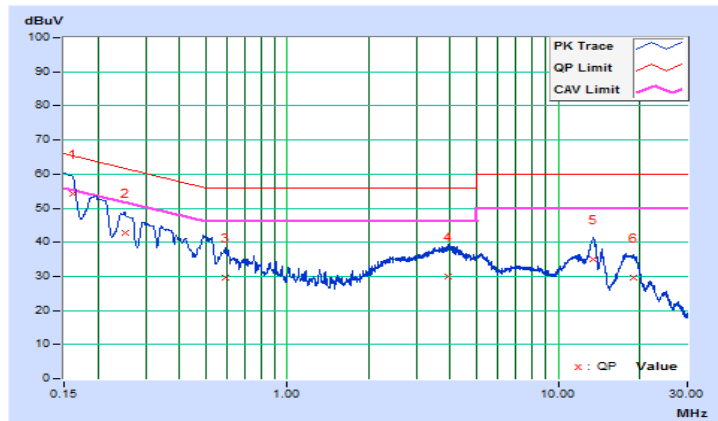

4.3 Number of Hopping Frequency Used

4.3.1 Limits of Hopping Frequency Used Measurement

At least 15 channels frequencies, and should be equally spaced.

4.3.2 Test Setup

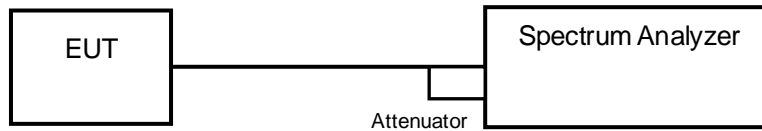

4.3.3 Test Instruments

Refer to section 4.1.2 to get information of above instrument.

4.3.4 Test Procedure

- a. Check the calibration of the measuring instrument (SA) using either an internal calibrator or a known signal from an external generator.
- b. Turn on the EUT and connect its antenna terminal to measurement via a low loss cable. Then set it to any one measured frequency within its operating range and make sure the instrument is operated in its linear range.
- c. Set the SA on MaxHold Mode, and then keep the EUT in hopping mode. Record all the signals from each channel until each one has been recorded.
- d. Set the SA on View mode and then plot the result on SA screen.
- e. Repeat above procedures until all frequencies measured were complete.

4.3.5 Deviation from Test Standard

No deviation.

4.3.6 Test Results

There are 79 hopping frequencies in the hopping mode. Please refer to next page for the test result. On the plots, it shows that the hopping frequencies are equally spaced.

<GFSK>

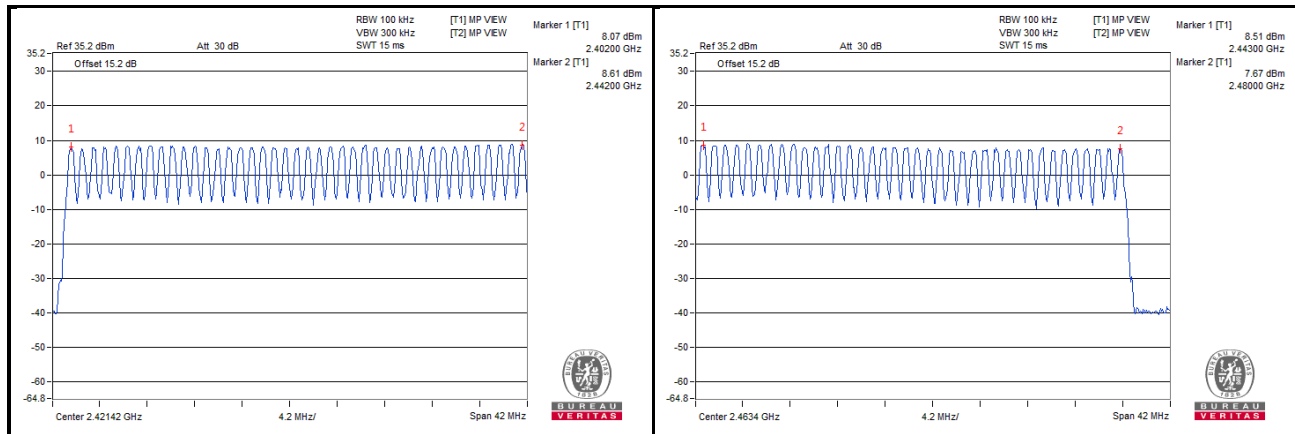

<8DPSK>

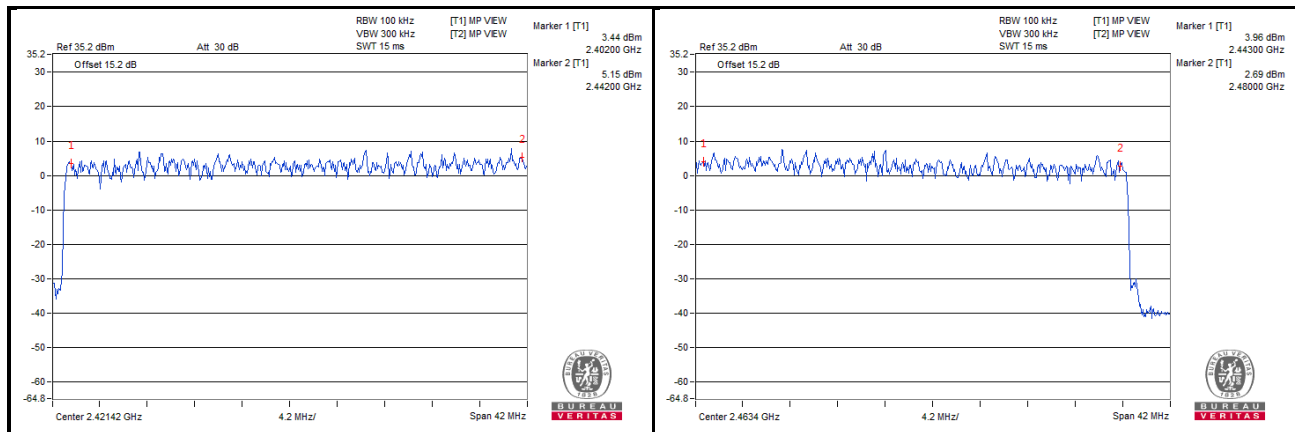

4.4 Dwell Time on Each Channel

4.4.1 Limits of Dwell Time on Each Channel Measurement

The average time of occupancy on any channel shall not be greater than 0.4 seconds within a period of 0.4 seconds multiplied by the number of hopping channels employed.

4.4.2 Test Setup

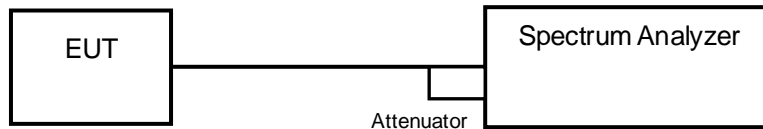

4.4.3 Test Instruments

Refer to section 4.1.2 to get information of above instrument.

4.4.4 Test Procedures

- a. Check the calibration of the measuring instrument (SA) using either an internal calibrator or a known signal from an external generator.
- b. Turn on the EUT and connect its antenna terminal to measurement via a low loss cable. Then set it to any one measured frequency within its operating range and make sure the instrument is operated in its linear range.
- c. Adjust the center frequency of SA on any frequency be measured and set SA to zero span mode. And then, set RBW and VBW of spectrum analyzer to proper value.
- d. Measure the time duration of one transmission on the measured frequency. And then plot the result with time difference of this time duration.
- e. Repeat above procedures until all different time-slot modes have been completed.

4.4.5 Deviation from Test Standard

No deviation.

4.4.6 Test Results

GFSK

Mode	Number of Transmission in a 31.6 (79 Hopping*0.4)	Length of Transmission Time (msec)	Result (msec)	Limit (sec)
DH1	50 (times / 5 sec) * 6.32 = 316 times	0.42	132.7	0.4
DH3	26 (times / 5 sec) * 6.32 = 164.32 times	1.74	285.9	0.4
DH5	18 (times / 5 sec) * 6.32 = 113.76 times	2.99	340.1	0.4

Note: Test plots of the transmitting time slot are shown as below.



8DPSK

Mode	Number of Transmission in a 31.6 (79 Hopping*0.4)	Length of Transmission Time (msec)	Result (msec)	Limit (sec)
3DH1	51 (times / 5 sec) * 6.32 = 322.32 times	0.44	141.8	0.4
3DH3	25 (times / 5 sec) * 6.32 = 158 times	1.74	274.9	0.4
3DH5	16 (times / 5 sec) * 6.32 = 101.12 times	2.97	300.3	0.4

Note: Test plots of the transmitting time slot are shown as below.



4.5 Channel Bandwidth

4.5.1 Limits of Channel Bandwidth Measurement

For frequency hopping system operating in the 2400-2483.5 MHz, if the 20 dB bandwidth of hopping channel is greater than 25 kHz, two-thirds 20 dB bandwidth of hopping channel shall be a minimum limit for the hopping channel separation.

4.5.2 Test Setup

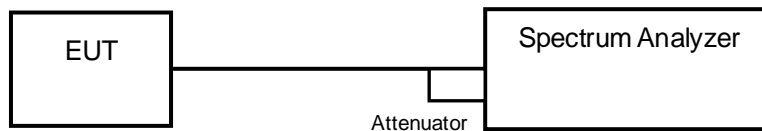

4.5.3 Test Instruments

Refer to section 4.1.2 to get information of above instrument.

4.5.4 Test Procedure

- Check the calibration of the measuring instrument using either an internal calibrator or a known signal from an external generator.
- Turn on the EUT and connect it to measurement instrument. Then set it to any one convenient frequency within its operating range. Set a reference level on the measuring instrument equal to the highest peak value.
- Measure the frequency difference of two frequencies that were attenuated 20 dB from the reference level. Record the frequency difference as the emission bandwidth.
- Repeat above procedures until all frequencies measured were complete.

4.5.5 Deviation from Test Standard

No deviation.

4.5.6 EUT Operating Condition

The software provided by client enabled the EUT to transmit and receive data at lowest, middle and highest channel frequencies individually.

4.5.7 Test Results

Channel	Frequency (MHz)	20 dB Bandwidth (MHz)	
		GFSK	8DPSK
0	2402	0.94	1.31
39	2441	1.00	1.30
78	2480	1.02	1.30

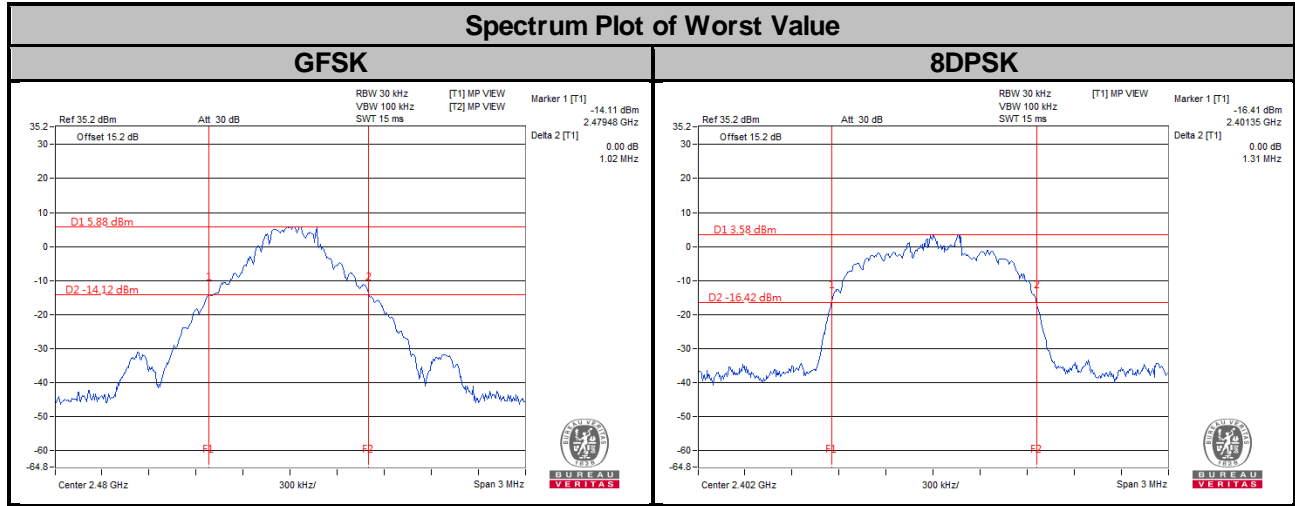

4.6 Occupied Bandwidth Measurement

4.6.1 Test Setup

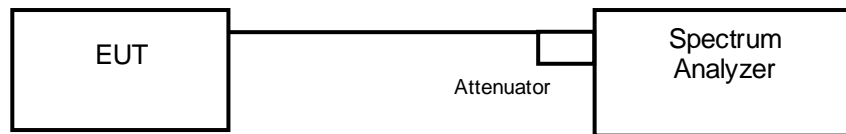

4.6.2 Test Instruments

Refer to section 4.1.2 to get information of above instrument

4.6.3 Test Procedure

The transmitter output was connected to the spectrum analyzer through an attenuator. The bandwidth of the fundamental frequency was measured by spectrum analyzer with resolution bandwidth in the range of 1 % to 5 % of the anticipated emission bandwidth, and a video bandwidth at least 3x the resolution bandwidth and set the detector to PEAK. The width of a frequency band such that, below the lower and above the upper frequency limits, the mean powers emitted are each equal to a specified percentage 0.5 % of the total mean power of a given emission.

4.6.4 Deviation from Test Standard

No deviation.

4.6.5 EUT Operating Conditions

The software provided by client to enable the EUT under transmission condition continuously at lowest, middle and highest channel frequencies individually.

4.6.6 Test Results

Channel	Frequency (MHz)	Occupied Bandwidth (MHz)	
		GFSK	8DPSK
0	2402	0.91	1.19
39	2441	0.90	1.19
78	2480	0.91	1.19

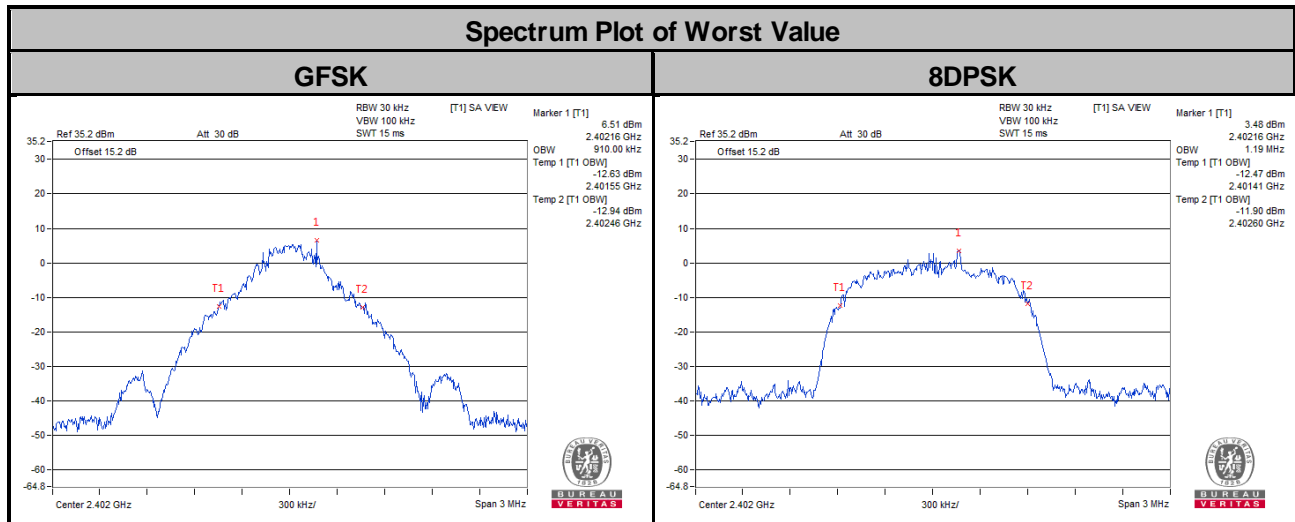

4.7 Hopping Channel Separation

4.7.1 Limits of Hopping Channel Separation Measurement

At least 25 kHz or two-third of 20 dB hopping channel bandwidth (whichever is greater).

4.7.2 Test Setup

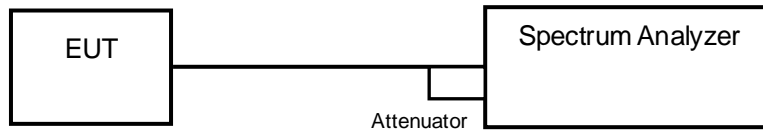

4.7.3 Test Instruments

Refer to section 4.1.2 to get information of above instrument.

4.7.4 Test Procedure

Measurement Procedure REF

- Check the calibration of the measuring instrument using either an internal calibrator or a known signal from an external generator.
- Turn on the EUT and connect it to measurement instrument. Then set it to any one convenient frequency within its operating range.
- By using the MaxHold function record the separation of two adjacent channels.
- Measure the frequency difference of these two adjacent channels by SA MARK function. And then plot the result on SA screen.
- Repeat above procedures until all frequencies measured were complete.

4.7.5 Deviation from Test Standard

No deviation.

4.7.6 Test Results

Channel	Freq. (MHz)	Adjacent Channel Separation (MHz)		20 dB Bandwidth (MHz)		Minimum Limit (MHz)		Pass / Fail
		GFSK	8DPSK	GFSK	8DPSK	GFSK	8DPSK	
0	2402	1.00	1.00	0.94	1.31	0.63	0.88	Pass
39	2441	1.00	1.00	1.00	1.30	0.67	0.87	Pass
78	2480	1.00	1.00	1.02	1.30	0.68	0.87	Pass

Note:

- The minimum limit is two-third 20 dB bandwidth.

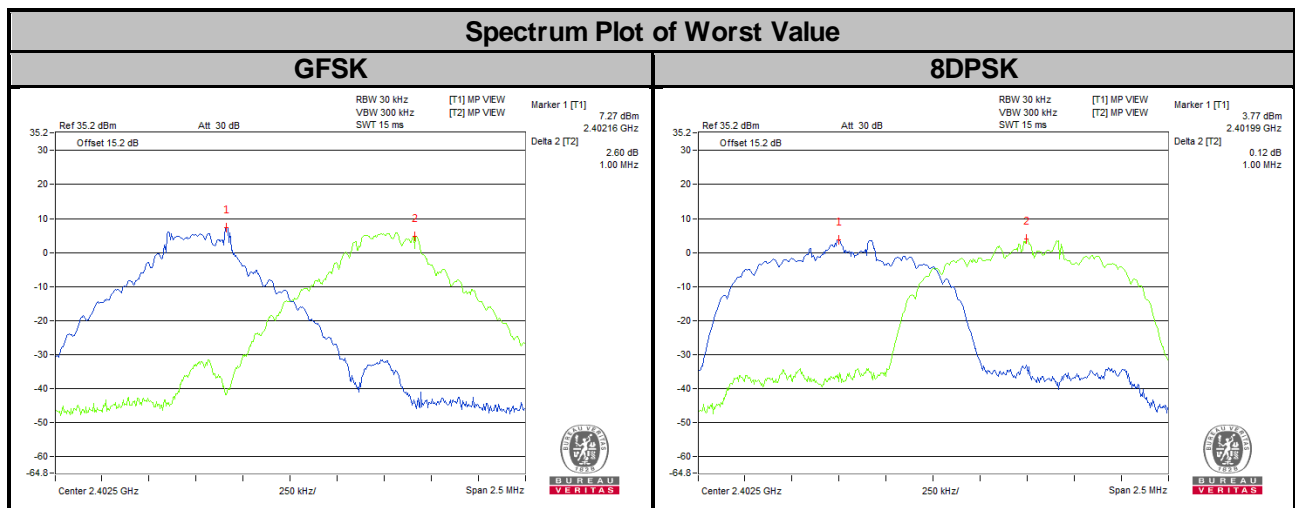

4.8 Maximum Output Power

4.8.1 Limits of Maximum Output Power Measurement

The Maximum Output Power Measurement is 125 mW.

4.8.2 Test Setup

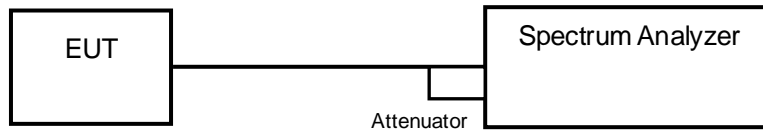

4.8.3 Test Instruments

Refer to section 4.1.2 to get information of above instrument.

4.8.4 Test Procedure

4. Check the calibration of the measuring instrument using either an internal calibrator or a known signal from an external generator.
5. Turn on the EUT and connect it to measurement instrument. Then set it to any one convenient frequency within its operating range. Set a reference level on the measuring instrument equal to the highest peak value.
6. The center frequency of the spectrum analyzer is set to the fundamental frequency and using 3 MHz RBW and 10 MHz VBW.
7. Measure the captured power within the band and recording the plot.
8. Repeat above procedures until all frequencies required were complete.

4.8.5 Deviation from Test Standard

No deviation.

4.8.6 EUT Operating Condition

The software provided by client enabled the EUT to transmit and receive data at lowest, middle and highest channel frequencies individually.

4.8.7 Test Results

<Peak Power>

<GFSK>

Channel	Freq. (MHz)	Output Power (mW)	Output Power (dBm)	Power Limit (mW)	Pass / Fail
0	2402	7.362	8.67	125	Pass
39	2441	10	10.00	125	Pass
78	2480	8.054	9.06	125	Pass

<8DPSK>

Channel	Freq. (MHz)	Output Power (mW)	Output Power (dBm)	Power Limit (mW)	Pass / Fail
0	2402	7.379	8.68	125	Pass
39	2441	10.023	10.01	125	Pass
78	2480	8.017	9.04	125	Pass

Spectrum Plot of Worst Value

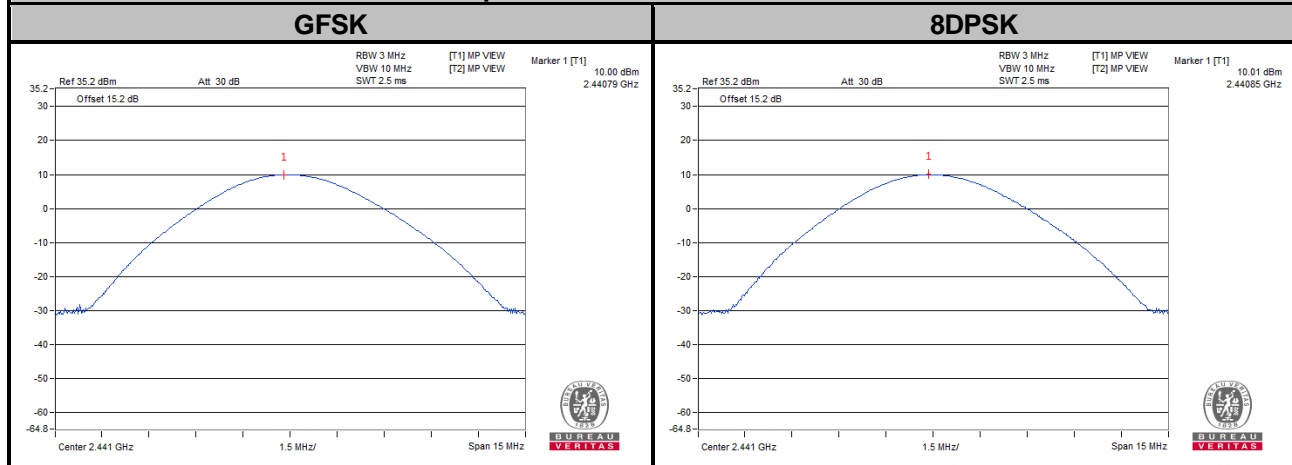

<Average Power (For Reference)>

<GFSK>

Channel	Freq. (MHz)	Output Power (mW)	Output Power (dBm)
0	2402	5.929	7.73
39	2441	8.017	9.04
78	2480	6.339	8.02

<8DPSK>

Channel	Freq. (MHz)	Output Power (mW)	Output Power (dBm)
0	2402	3.648	5.62
39	2441	4.955	6.95
78	2480	3.846	5.85

4.9 Conducted Out of Band Emission Measurement

4.9.1 Limits Of Conducted Out of Band Emission Measurement

Below -20 dB of the highest emission level of operating band (in 100 kHz RBW).

4.9.2 Test Instruments

Refer to section 4.1.2 to get information of above instrument.

4.9.3 Test Procedure

The transmitter output was connected to the spectrum analyzer via a low lose cable. Set both RBW and VBW of spectrum analyzer to 100 kHz and 300 kHz with suitable frequency span including 100 MHz bandwidth from band edge. The band edges was measured and recorded.

4.9.4 Deviation from Test Standard

No deviation.

4.9.5 EUT Operating Condition

The software provided by client enabled the EUT to transmit and receive data at lowest, middle and highest channel frequencies individually.

4.9.6 Test Results

The spectrum plots are attached on the following images. D1 line indicates the highest level, D2 line indicates the 20 dB offset below D1. It shows compliance with the requirement.

GFSK

Hopping Disabled_Low Channel

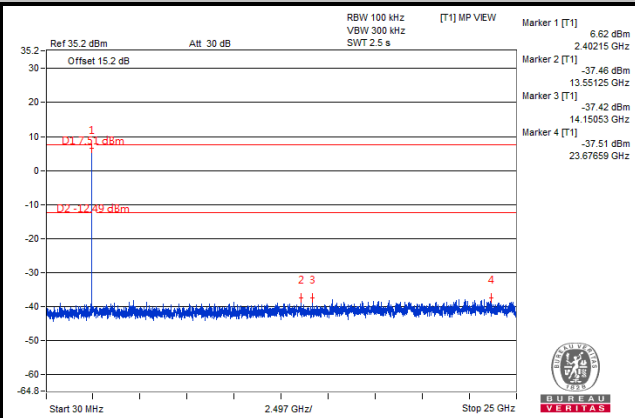
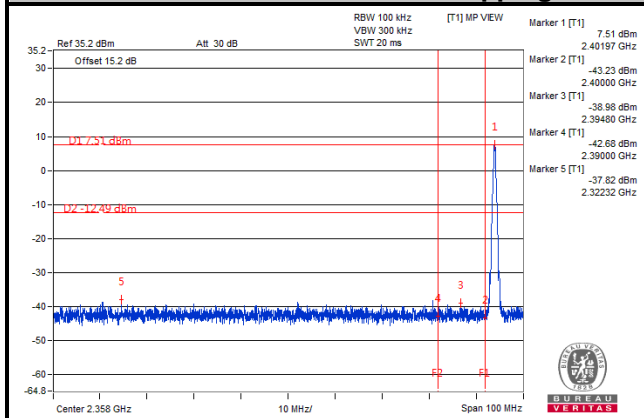

Hopping Disabled_Middle Channel

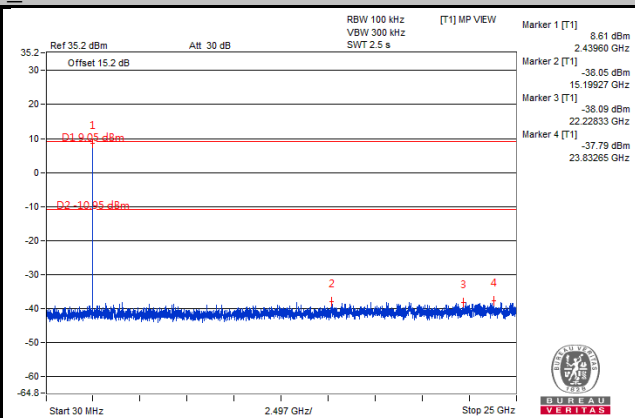
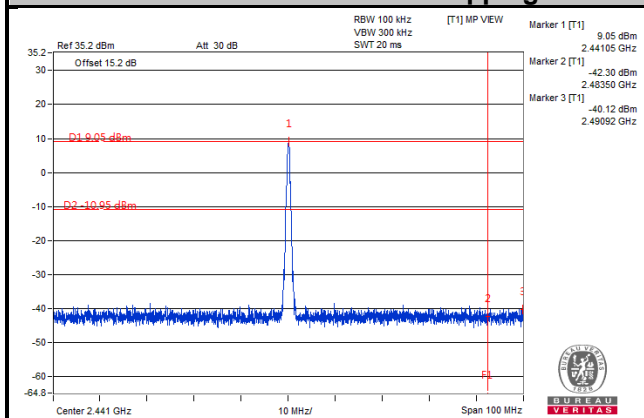

Hopping Disabled_High Channel

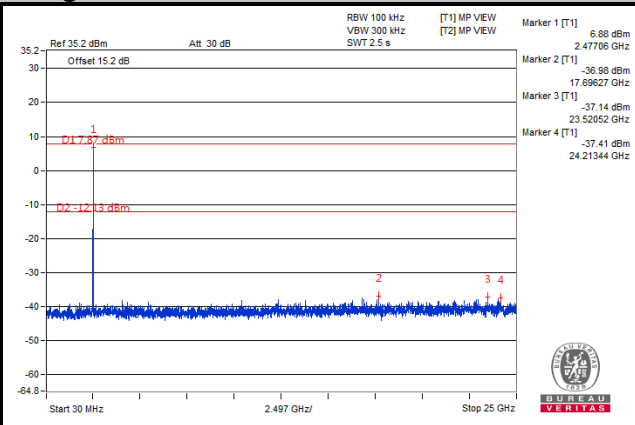
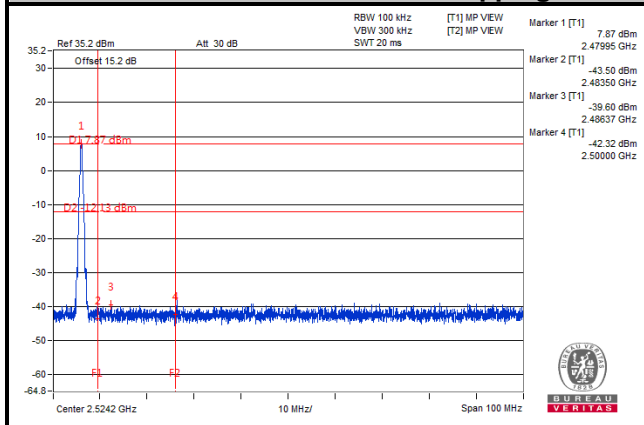

Hopping Enabled_Low Channel

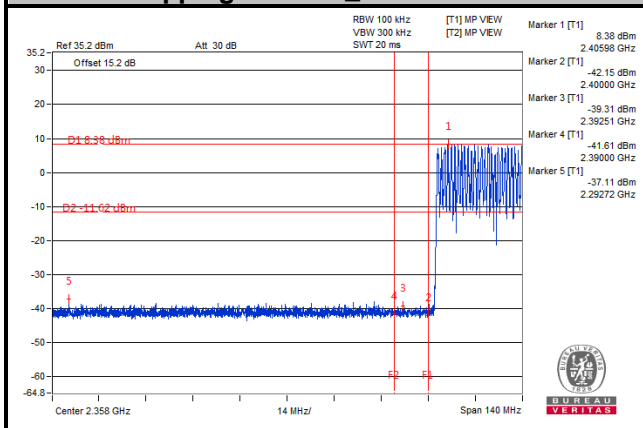

Hopping Enabled_High Channel

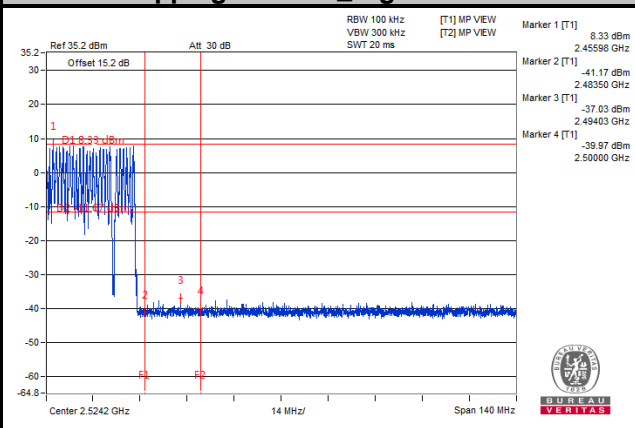

8DPSK

Hopping Disabled_Low Channel

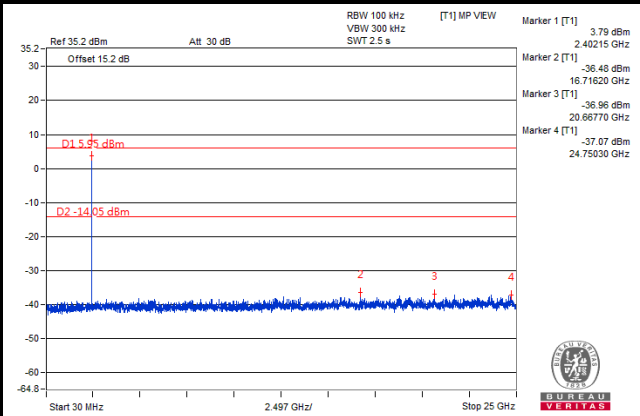
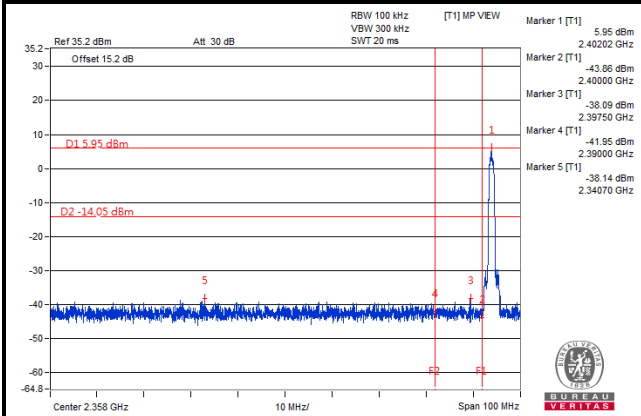

Hopping Disabled_Middle Channel

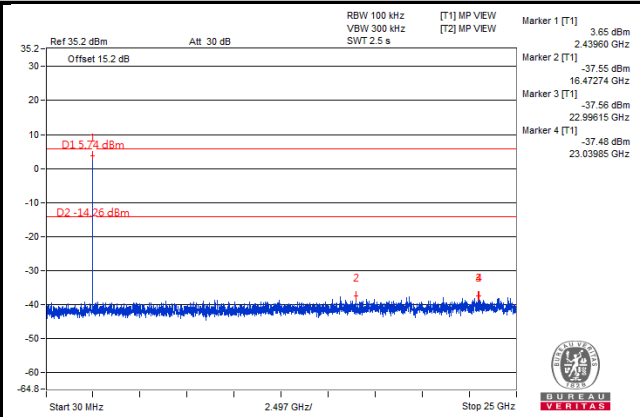
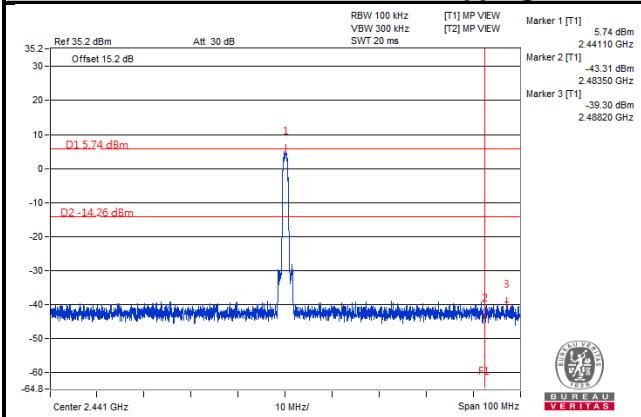

Hopping Disabled_High Channel

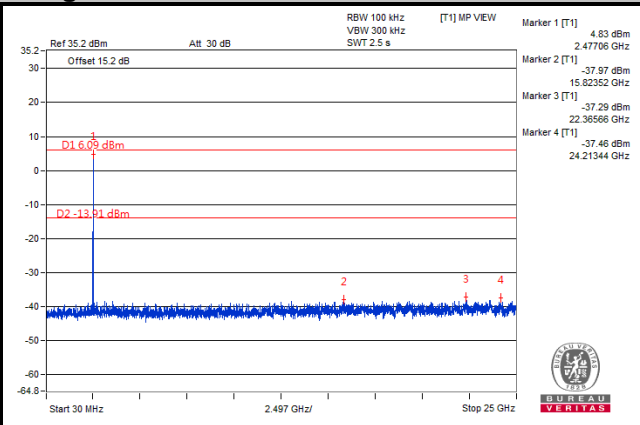
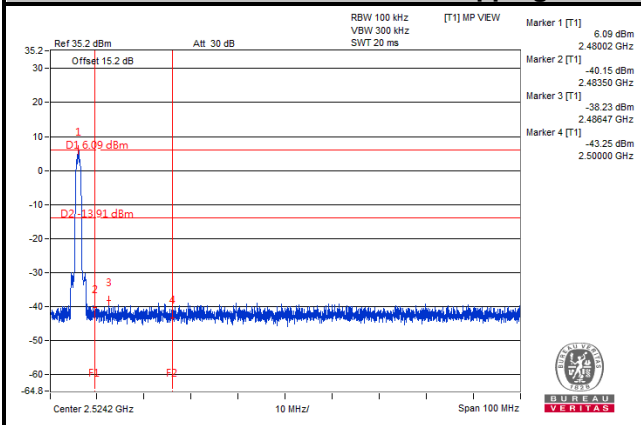

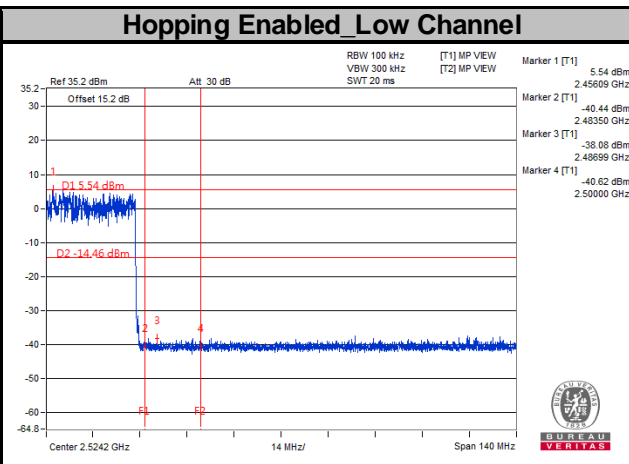
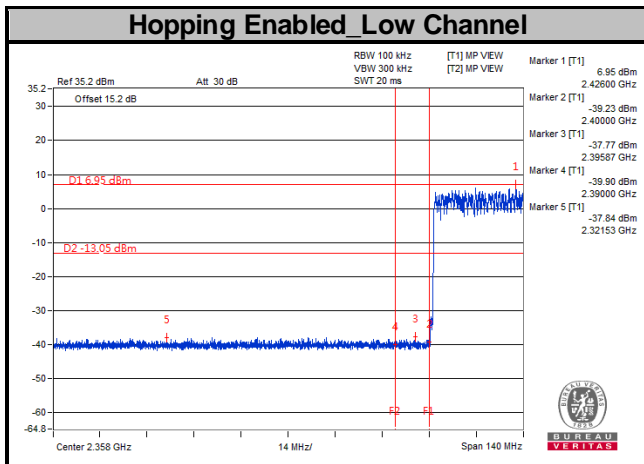

5 Pictures of Test Arrangements

Please refer to the attached file (Test Setup Photo).

Appendix – Information on the Testing Laboratories

We, Bureau Veritas Consumer Products Services (H.K.) Ltd., Taoyuan Branch, were founded in 1988 to provide our best service in EMC, Radio, Telecom and Safety consultation. Our laboratories are FCC recognized accredited test firms and accredited according to ISO/IEC 17025.

If you have any comments, please feel free to contact us at the following:

Linko EMC/RF Lab

Tel: 886-2-26052180

Fax: 886-2-26051924

Hsin Chu EMC/RF/Telecom Lab

Tel: 886-3-6668565

Fax: 886-3-6668323

Hwa Ya EMC/RF/Safety

Tel: 886-3-3183232

Fax: 886-3-3270892

Email: service.adt@tw.bureauveritas.com

Web Site: www.bureauveritas-adt.com

The address and road map of all our labs can be found in our web site also.

--- END ---