

## FCC Test Report

**Report No.:** RF180626C04

**FCC ID:** O57TBX605F

**Test Model:** Lenovo TB-X605F

**Received Date:** Jun. 26, 2018

**Test Date:** Jul. 17, 2018 ~ Jul. 27, 2018

**Issued Date:** Aug. 01, 2018

**Applicant:** Lenovo(Shanghai) Electronics Technology Co., Ltd.

**Address:** NO.68 BUILDING, 199 FENJU RD, China (Shanghai) Pilot Free Trade Zone, 200131, CHINA

**Manufacturer:** Lenovo PC HK Limited

**Address:** 23/F, Lincoln House, Taikoo Place 979 King's Road, Quarry Bay, Hong Kong

**Issued By:** Bureau Veritas Consumer Products Services (H.K.) Ltd., Taoyuan Branch

**Lab Address:** No. 47-2, 14th Ling, Chia Pau Vil., Lin Kou Dist., New Taipei City, Taiwan ( R.O.C )

**Test Location:** No.19, Hwa Ya 2nd Rd., Wen Hwa Vil., Kwei Shan Dist., Taoyuan City 33383, Taiwan, R.O.C.

**FCC Registration /  
Designation Number:** 788550 / TW0003



This report is for your exclusive use. Any copying or replication of this report to or for any other person or entity, or use of our name or trademark, is permitted only with our prior written permission. This report sets forth our findings solely with respect to the test samples identified herein. The results set forth in this report are not indicative or representative of the quality or characteristics of the lot from which a test sample was taken or any similar or identical product unless specifically and expressly noted. Our report includes all of the tests requested by you and the results thereof based upon the information that you provided to us. You have 60 days from date of issuance of this report to notify us of any material error or omission caused by our negligence, provided, however, that such notice shall be in writing and shall specifically address the issue you wish to raise. A failure to raise such issue within the prescribed time shall constitute your unqualified acceptance of the completeness of this report, the tests conducted and the correctness of the report contents. Unless specifically mentioned, the uncertainty of measurement has been explicitly taken into account to declare the compliance or non-compliance to the specification. The report must not be used by the client to claim product certification, approval, or endorsement by TAF or any government agencies.

## Table of Contents

<b>Release Control Record .....</b>	<b>4</b>
<b>1 Certificate of Conformity .....</b>	<b>5</b>
<b>2 Summary of Test Results .....</b>	<b>6</b>
2.1 Measurement Uncertainty .....	6
2.2 Modification Record.....	6
<b>3 General Information .....</b>	<b>7</b>
3.1 General Description of EUT .....	7
3.2 Description of Test Modes .....	10
3.2.1 Test Mode Applicability and Tested Channel Detail .....	11
3.3 Duty Cycle of Test Signal .....	13
3.4 Description of Support Units.....	14
3.4.1 Configuration of System under Test.....	14
3.5 General Description of Applied Standards .....	14
<b>4 Test Types and Results .....</b>	<b>15</b>
4.1 Radiated Emission and Bandedge Measurement .....	15
4.1.1 Limits of Radiated Emission and Bandedge Measurement.....	15
4.1.2 Test Instruments .....	16
4.1.3 Test Procedures.....	17
4.1.4 Deviation from Test Standard.....	18
4.1.5 Test Set Up .....	18
4.1.6 EUT Operating Conditions .....	19
4.1.7 Test Results .....	20
4.2 Conducted Emission Measurement .....	34
4.2.1 Limits of Conducted Emission Measurement .....	34
4.2.2 Test Instruments .....	34
4.2.3 Test Procedures.....	35
4.2.4 Deviation from Test Standard.....	35
4.2.5 Test Setup.....	35
4.2.6 EUT Operating Conditions .....	35
4.2.7 Test Results .....	36
4.3 6 dB Bandwidth Measurement .....	40
4.3.1 Limits of 6 dB Bandwidth Measurement.....	40
4.3.2 Test Setup.....	40
4.3.3 Test Instruments .....	40
4.3.4 Test Procedure .....	40
4.3.5 Deviation from Test Standard.....	40
4.3.6 EUT Operating Conditions .....	40
4.3.7 Test Results .....	41
4.4 Occupied Bandwidth Measurement .....	43
4.4.1 Test Setup.....	43
4.4.2 Test Instruments .....	43
4.4.3 Test Procedure .....	43
4.4.4 Deviation from Test Standard.....	43
4.4.5 EUT Operating Conditions .....	43
4.4.6 Test Results .....	44
4.5 Conducted Output Power Measurement .....	46
4.5.1 Limits of Conducted Output Power Measurement.....	46
4.5.2 Test Setup.....	46
4.5.3 Test Instruments .....	46
4.5.4 Test Procedures.....	46
4.5.5 Deviation from Test Standard.....	46
4.5.6 EUT Operating Conditions .....	46
4.5.7 Test Results .....	47

4.6	Power Spectral Density Measurement .....	49
4.6.1	Limits of Power Spectral Density Measurement .....	49
4.6.2	Test Setup .....	49
4.6.3	Test Instruments .....	49
4.6.4	Test Procedure .....	49
4.6.5	Deviation from Test Standard .....	49
4.6.6	EUT Operating Condition .....	49
4.6.7	Test Results .....	50
4.7	Conducted Out of Band Emission Measurement .....	52
4.7.1	Limits of Conducted Out of Band Emission Measurement .....	52
4.7.2	Test Setup .....	52
4.7.3	Test Instruments .....	52
4.7.4	Test Procedure .....	52
4.7.5	Deviation from Test Standard .....	52
4.7.6	EUT Operating Condition .....	52
4.7.7	Test Results .....	53
<b>5</b>	<b>Pictures of Test Arrangements .....</b>	<b>61</b>
	<b>Appendix – Information on the Testing Laboratories .....</b>	<b>62</b>

### Release Control Record

Issue No.	Description	Date Issued
RF180626C04	Original Release	Aug. 01, 2018

## 1 Certificate of Conformity

**Product:** Portable Tablet Computer

**Brand:** Lenovo

**Test Model:** Lenovo TB-X605F

**Sample Status:** Production Unit

**Applicant:** Lenovo(Shanghai) Electronics Technology Co., Ltd.

**Test Date:** Jul. 17, 2018 ~ Jul. 27, 2018

**Standards:** 47 CFR FCC Part 15, Subpart C (Section 15.247)  
ANSI C63.10:2013

The above equipment has been tested by **Bureau Veritas Consumer Products Services (H.K.) Ltd., Taoyuan Branch**, and found compliance with the requirement of the above standards. The test record, data evaluation & Equipment Under Test (EUT) configurations represented herein are true and accurate accounts of the measurements of the sample's RF characteristics under the conditions specified in this report.

**Prepared by :** Rona Chen, **Date:** Aug. 01, 2018  
Rona Chen / Specialist

**Approved by :** Dylan Chiou, **Date:** Aug. 01, 2018  
Dylan Chiou / Project Engineer

## 2 Summary of Test Results

47 CFR FCC Part 15, Subpart C (Section 15.247)			
FCC Clause	Test Item	Result	Remarks
15.207	AC Power Conducted Emission	Pass	Meet the requirement of limit. Minimum passing margin is -10.18 dB at 0.16051 MHz.
15.205 / 15.209 / 15.247(d)	Radiated Emissions and Band Edge Measurement	Pass	Meet the requirement of limit. Minimum passing margin is -1.9 dB at 2483.50 MHz.
15.247(d)	Antenna Port Emission	Pass	Meet the requirement of limit.
15.247(a)(2)	6 dB Bandwidth	Pass	Meet the requirement of limit.
---	Occupied Bandwidth Measurement	Pass	Reference only
15.247(b)	Conducted power	Pass	Meet the requirement of limit.
15.247(e)	Power Spectral Density	Pass	Meet the requirement of limit.
15.203	Antenna Requirement	Pass	No antenna connector is used.

### 2.1 Measurement Uncertainty

Where relevant, the following measurement uncertainty levels have been estimated for tests performed on the EUT:

The listed uncertainties are the worst case uncertainty for the entire range of measurement. Please note that the uncertainty values are provided for informational purposes only and are not used in determining the PASS/FAIL results.

Measurement	Frequency	Expanded Uncertainty (k=2) (±)
Conducted Emissions at mains ports	150 kHz ~ 30 MHz	2.44 dB
Radiated Emissions up to 1 GHz	30 MHz ~ 200 MHz	3.86 dB
	200 MHz ~ 1000 MHz	3.87 dB
Radiated Emissions above 1 GHz	1 GHz ~ 18 GHz	2.29 dB
	18 GHz ~ 40 GHz	2.29 dB

### 2.2 Modification Record

There were no modifications required for compliance.

### 3 General Information

#### 3.1 General Description of EUT

<b>Product</b>	Portable Tablet Computer
<b>Brand</b>	Lenovo
<b>Test Model</b>	Lenovo TB-X605F
<b>Status of EUT</b>	Production Unit
<b>Power Supply Rating</b>	3.85 Vdc (Battery) 5 Vdc (Adapter or host equipment)
<b>Modulation Type</b>	CCK, DQPSK, DBPSK for DSSS 64QAM, 16QAM, QPSK, BPSK for OFDM
<b>Modulation Technology</b>	DSSS, OFDM
<b>Transfer Rate</b>	802.11b: 11.0 / 5.5 / 2.0 / 1.0 Mbps 802.11g: 54.0 / 48.0 / 36.0 / 24.0 / 18.0 / 12.0 / 9.0 / 6.0 Mbps 802.11n: up to 135.0 Mbps
<b>Operating Frequency</b>	2412 ~ 2462 MHz
<b>Number of Channel</b>	11 for 802.11b, 802.11g, 802.11n (HT20) 7 for 802.11n (HT40)
<b>Output Power</b>	802.11b: 23.29 dBm / 213.304 mW 802.11g: 25.76 dBm / 376.704 mW 802.11n (HT20): 25.65 dBm / 367.282 mW 802.11n (HT40): 25.67 dBm / 368.978 mW
<b>Antenna Type</b>	Monopole antenna with -5 dBi gain
<b>Antenna Connector</b>	Coaxial Connector
<b>Product HW Version</b>	Lenovo Tablet TB-X605F
<b>Product SW Version</b>	TB-X605F_RF01_20180615
<b>Accessory Device</b>	Refer to Note as below
<b>Data Cable Supplied</b>	Refer to Note as below

Note:

1. The EUT provides 1 completed transmitter and 1 receiver.

Modulation Mode	Tx Function
802.11b	1TX
802.11g	1TX
802.11n (HT20)	1TX
802.11n (HT40)	1TX

2. The EUT contains following accessory devices.

Product	Brand	Model	Description
Adapter 1	Salom	SC-41	I/P: 100-240 Vac, 50/60 Hz, 0.3 A O/P: 5 Vdc, 2 A
Adapter 2	AcBel	SC-41	I/P: 100-240 Vac, 50/60 Hz, 0.3 A O/P: 5 Vdc, 2 A
Battery	ATL	L18D1P32	3.85 Vdc, 4850 mAh
USB Cable 1 (White)	LiQi	LQ-02300039	1 m shielded cable w/o core
USB Cable 2 (Black)	LiQi	LQ-02300040	1 m shielded cable w/o core
LCD Panel 1 (Black)	BOE	TV101WUM-LL2	10.1 "
LCD Panel 2 (White)	BOE	TV101WUM-LL3	10.1 "
Photo Camera 1	Lcetron	LE5143AM	5M AF
Photo Camera 2	Holitek	MF81Q	5M AF
Photo Camera 3	Lcetron	ZRT2509V-P102F	2M FF
Photo Camera 4	Holitek	HSU1005	2M FF
CPU	Qualcomm	SDA450	792nsp
EMMC1 + DDR1	SAMSUNG	KMQE60013M-B318 ( 2+16 )	16G
EMMC2 + DDR2	HYNIX	H9TQ17ABJTCCUR-KUM ( 2+16 )	16G
EMMC3 + DDR3	SAMSUNG	KMGD6001BM-B421 ( 3+32 )	32G
EMMC4 + DDR4	HYNIX	H9TQ27ADFTMCUR-KUM ( 3+32 )	32G
EMMC5 + DDR5	SAMSUNG	KMRH60014A-B614 ( 4+64 )	64G
EMMC6 + DDR6	HYNIX	H9TQ52ACLTCUR-KUM( 4+64 )	64G
Speaker 1	Keysound	QM171219AW84	--
Speaker 2	Keysound	QM171219AW85	--
Motor 1	AWA	YK2455R	--
Motor 2	Baolong	BLX-431320S	--
Main Board 1	huashen	W93M71B2-3-03	--
Main Board 2	yilianda	W93M71B2-3-05	--
BT/WLAN Module	Qualcomm	WCN-3680B-0-79BWLNSP	--

\* USB Cable 1 and USB Cable 2 is electrically identical, difference models are for color distinguished. Therefore, only USB Cable 1 is as a representative for final test.

\* LCD Panel 1 and LCD Panel 2 is electrically identical, difference models are for color distinguished. Therefore, only LCD Panel 2 is as a representative for final test.

3. The Adapter 1 and Adapter 2 had been pre-tested to determine the worst-case. The worst case was found in Adapter 1. Therefore, only Adapter 1 was chosen for the final test.



4. The EUT contains two samples.

Sample	Configurations
A	EUT + LCD Panel 2 + Photo Camera 1 + Photo Camera 3 + EMMC 3 + DDR 3 + Speaker 1 + Speaker 2 + Motor 2 + Main Board 1 + BT/WLAN Module + Battery
B	EUT + LCD Panel 2 + Photo Camera 2 + Photo Camera 4 + EMMC 4 + DDR 4 + Speaker 1 + Speaker 2 + Motor 1 + Main Board 2 + BT/WLAN Module + Battery

5. The above EUT information is declared by manufacturer and for more detailed features description, please refers to the manufacturer's specifications or user's manual.

### 3.2 Description of Test Modes

11 channels are provided for 802.11b, 802.11g and 802.11n (HT20):

Channel	Frequency (MHz)	Channel	Frequency (MHz)
1	2412	7	2442
2	2417	8	2447
3	2422	9	2452
4	2427	10	2457
5	2432	11	2462
6	2437		

7 channels are provided for 802.11n (HT40):

Channel	Frequency (MHz)	Channel	Frequency (MHz)
3	2422	7	2442
4	2427	8	2447
5	2432	9	2452
6	2437		

### 3.2.1 Test Mode Applicability and Tested Channel Detail

EUT Configure Mode	Applicable To				Description
	RE $\geq$ 1G	RE<1G	PLC	APCM	
A	√	√	√	√	Sample A
B	-	√	√	-	Sample B

Where **RE $\geq$ 1G**: Radiated Emission above 1 GHz      **RE<1G**: Radiated Emission below 1 GHz  
**PLC**: Power Line Conducted Emission      **APCM**: Antenna Port Conducted Measurement

**NOTE:**

1. The EUT had been pre-tested on the positioned of each 3 axis. The worst case was found when positioned on **X-plane**.
2. "-" means no effect.

#### **Radiated Emission Test (Above 1 GHz):**

- Pre-Scan has been conducted to determine the worst-case mode from all possible combinations between available modulations, data rates and antenna ports (if EUT with antenna diversity architecture).
- Following channel(s) was (were) selected for the final test as listed below.

EUT Configure Mode	Mode	Available Channel	Tested Channel	Modulation Technology	Modulation Type	Data Rate (Mbps)
A	802.11b	1 to 11	1, 6, 11	DSSS	DBPSK	1.0
	802.11g	1 to 11	1, 6, 11	OFDM	BPSK	6.0
	802.11n (HT20)	1 to 11	1, 6, 11	OFDM	BPSK	6.5
	802.11n (HT40)	3 to 9	3, 6, 9	OFDM	BPSK	13.5

#### **Radiated Emission Test (Below 1 GHz):**

- Pre-Scan has been conducted to determine the worst-case mode from all possible combinations between available modulations, data rates and antenna ports (if EUT with antenna diversity architecture).
- Following channel(s) was (were) selected for the final test as listed below.

EUT Configure Mode	Mode	Available Channel	Tested Channel	Modulation Technology	Modulation Type	Data Rate (Mbps)
A, B	802.11n (HT40)	3 to 9	9	OFDM	BPSK	13.5

#### **Power Line Conducted Emission Test:**

- Pre-Scan has been conducted to determine the worst-case mode from all possible combinations between available modulations, data rates and antenna ports (if EUT with antenna diversity architecture).
- Following channel(s) was (were) selected for the final test as listed below.

EUT Configure Mode	Test Condition
A, B	WLAN 2.4G + USB Cable + Adapter

**Antenna Port Conducted Measurement:**

- This item includes all test value of each mode, but only includes spectrum plot of worst value of each mode.
- Pre-Scan has been conducted to determine the worst-case mode from all possible combinations between available modulations, data rates and antenna ports (if EUT with antenna diversity architecture).
- Following channel(s) was (were) selected for the final test as listed below.

EUT Configure Mode	Mode	Available Channel	Tested Channel	Modulation Technology	Modulation Type	Data Rate (Mbps)
A	802.11b	1 to 11	1, 6, 11	DSSS	DBPSK	1.0
	802.11g	1 to 11	1, 6, 11	OFDM	BPSK	6.0
	802.11n (HT20)	1 to 11	1, 6, 11	OFDM	BPSK	6.5
	802.11n (HT40)	3 to 9	3, 6, 9	OFDM	BPSK	13.5

**Test Condition:**

Applicable To	Environmental Conditions	Input Power	Tested by
RE≥1G	25 deg. C, 65 % RH	120 Vac, 60 Hz	Daniel Dai
RE<1G	25 deg. C, 65 % RH	120 Vac, 60 Hz	James Wei
PLC	25 deg. C, 65 % RH	120 Vac, 60 Hz	Adair Peng
APCM	25 deg. C, 65 % RH	3.85 Vdc	Frank Chiu

### 3.3 Duty Cycle of Test Signal

**802.11b:** Duty cycle =  $8.225/8.43 = 0.976$ , Duty factor =  $10 * \log(1/0.976) = 0.11$

**802.11g:** Duty cycle =  $1.363/1.578 = 0.864$ , Duty factor =  $10 * \log(1/0.864) = 0.63$

**802.11n (HT20):** Duty cycle =  $1.274/1.489 = 0.856$ , Duty factor =  $10 * \log(1/0.856) = 0.68$

**802.11n (HT40):** Duty cycle =  $0.623/0.845 = 0.737$ , Duty factor =  $10 * \log(1/0.737) = 1.33$

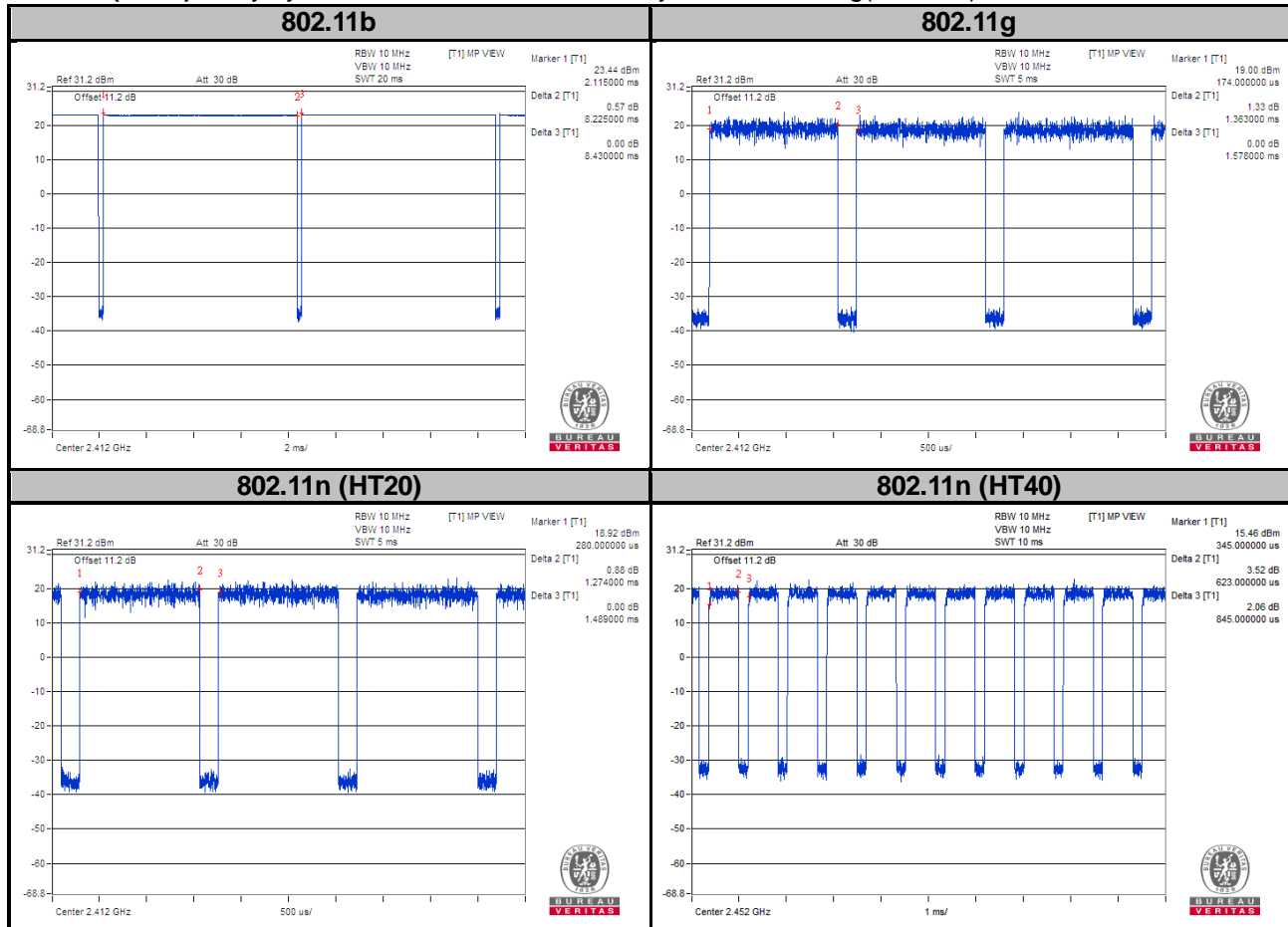

### 3.4 Description of Support Units

The EUT has been tested as an independent unit together with other necessary accessories or support units. The following support units or accessories were used to form a representative test configuration during the tests.

No.	Product	Brand	Model No.	Serial No.	FCC ID
1.	Earphone	N/A	N/A	N/A	N/A

No.	Signal Cable Description of The Above Support Units
1.	N/A

Note:

1. All power cords of the above support units are non-shielded (1.8m).

#### 3.4.1 Configuration of System under Test

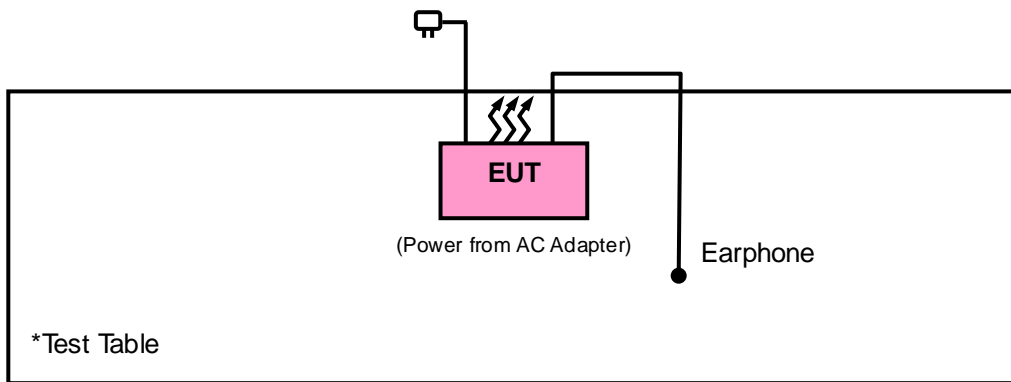

### 3.5 General Description of Applied Standards

The EUT is a RF Product. According to the specifications of the manufacturer, it must comply with the requirements of the following standards:

- FCC Part 15, Subpart C (15.247)**
- 558074 D01 DTS Meas Guidance v04**
- ANSI C63.10-2013**

All test items have been performed and recorded as per the above standards.

## 4 Test Types and Results

### 4.1 Radiated Emission and Bandedge Measurement

#### 4.1.1 Limits of Radiated Emission and Bandedge Measurement

Radiated emissions which fall in the restricted bands must comply with the radiated emission limits specified as below table. Other emissions shall be at least 20 dB below the highest level of the desired power:

Frequencies (MHz)	Field Strength (microvolts/meter)	Measurement Distance (meters)
0.009 ~ 0.490	2400/F (kHz)	300
0.490 ~ 1.705	24000/F (kHz)	30
1.705 ~ 30.0	30	30
30 ~ 88	100	3
88 ~ 216	150	3
216 ~ 960	200	3
Above 960	500	3

**NOTE:**

1. The lower limit shall apply at the transition frequencies.
2. Emission level (dBuV/m) = 20 log Emission level (uV/m).
3. For frequencies above 1000 MHz, the field strength limits are based on average detector, however, the peak field strength of any emission shall not exceed the maximum permitted average limits, specified above by more than 20 dB under any condition of modulation.

## 4.1.2 Test Instruments

Description & Manufacturer	Model No.	Serial No.	Date of Calibration	Due Date of Calibration
Test Receiver ROHDE & SCHWARZ	ESIB7	100187	May 29, 2018	May 28, 2019
Spectrum Analyzer ROHDE & SCHWARZ	FSU43	101261	Jan. 11, 2018	Jan. 10, 2019
BILOG Antenna SCHWARZBECK	VULB9168	9168-171	Dec. 11, 2017	Dec. 10, 2018
HORN Antenna SCHWARZBECK	9120D	209	Dec. 13, 2017	Dec. 12, 2018
HORN Antenna SCHWARZBECK	BBHA 9170	BBHA9170241	Dec. 01, 2017	Nov. 30, 2018
1W Rotary Attenuator Woken	00801A1GGAM02Y	NA	May 17, 2018	May 16, 2019
Loop Antenna	EM-6879	269	Aug. 11, 2017	Aug. 10, 2018
Preamplifier Agilent (Below 1GHz)	8447D	2944A10738	Aug. 21, 2017	Aug. 20, 2018
Preamplifier Agilent (Above 1GHz)	8449B	3008A02465	Apr. 03, 2018	Apr. 02, 2019
Power Meter Anritsu	ML2495A	1012010	Aug. 15, 2017	Aug. 14, 2018
Power Sensor Anritsu	MA2411B	1315050	Aug. 15, 2017	Aug. 14, 2018
RF signal cable HUBER+SUHNER	SUCOFLEX 104	Cable-CH3-03 (223653/4)	Aug. 21, 2017	Aug. 20, 2018
RF signal cable HUBER+SUHNER & EMCI	SUCOFLEX 104&EMC104-SM- SM-8000	Cable-CH3-03 (309224+170907)	Sep.11, 2017	Sep. 10, 2018
Boresight Antenna Fixture	FBA-01	FBA-SIP01	NA	NA
Software BV ADT	ADT_Radiated_ V7.6.15.9.5	NA	NA	NA
Antenna Tower inn-co GmbH	MA 4000	013303	NA	NA
Antenna Tower Controller BV ADT	AT100	AT93021702	NA	NA
Turn Table BV ADT	TT100	TT93021702	NA	NA
Turn Table Controller BV ADT	SC100	SC93021702	NA	NA

- Note: 1. The calibration interval of the above test instruments is 12 months and the calibrations are traceable to NML/ROC and NIST/USA.
2. The test was performed in HwaYa Chamber 3.
3. The horn antenna and preamplifier (model: 8449B) are used only for the measurement of emission frequency above 1 GHz if tested.
4. The IC Site Registration No. is 7450F-3.



#### 4.1.3 Test Procedures

##### **For Radiated Emission below 30 MHz**

- a. The EUT was placed on the top of a rotating table 0.8 meters above the ground at a 3 meter chamber room. The table was rotated 360 degrees to determine the position of the highest radiation.
- b. The EUT was set 3 meters away from the interference-receiving antenna, which was mounted on the top of a variable-height antenna tower.
- c. Parallel, perpendicular, and ground-parallel orientations of the antenna are set to make the measurement.
- d. For each suspected emission, the EUT was arranged to its worst case and the rotatable table was turned from 0 degrees to 360 degrees to find the maximum reading.
- e. The test-receiver system was set to Quasi-Peak Detect Function and Specified Bandwidth with Maximum Hold Mode.

##### **Note:**

1. The resolution bandwidth and video bandwidth of test receiver/spectrum analyzer is 9 kHz at frequency below 30 MHz.

##### **For Radiated Emission above 30 MHz**

- a. The EUT was placed on the top of a rotating table 0.8 meters (for 30 MHz ~ 1 GHz) / 1.5 meters (for above 1 GHz) above the ground at 3 meter chamber room for test. The table was rotated 360 degrees to determine the position of the highest radiation.
- b. The EUT was set 3 meters away from the interference-receiving antenna, which was mounted on the top of a variable-height antenna tower.
- c. The height of antenna is varied from one meter to four meters above the ground to determine the maximum value of the field strength. Both horizontal and vertical polarizations of the antenna are set to make the measurement.
- d. For each suspected emission, the EUT was arranged to its worst case and then the antenna was tuned to heights from 1 meter to 4 meters and the rotatable table was turned from 0 degrees to 360 degrees to find the maximum reading.
- e. The test-receiver system was set to quasi-peak detect function and specified bandwidth with maximum hold mode when the test frequency is below 1 GHz.
- f. The test-receiver system was set to peak and average detected function and specified bandwidth with maximum hold mode when the test frequency is above 1 GHz. If the peak reading value also meets average limit, measurement with the average detector is unnecessary.

##### **Note:**

1. The resolution bandwidth and video bandwidth of test receiver/spectrum analyzer is 120 kHz for Quasi-peak detection (QP) at frequency below 1 GHz.
2. The resolution bandwidth of test receiver/spectrum analyzer is 1 MHz and the video bandwidth is 3 MHz for Peak detection (PK) at frequency above 1 GHz.
3. The resolution bandwidth of test receiver/spectrum analyzer is 1 MHz and the video bandwidth is  $\geq 1/T$  (Duty cycle < 98 %) or 10 Hz (Duty cycle  $\geq 98$  %) for Average detection (AV) at frequency above 1 GHz.  
(11b: RBW = 1 MHz, VBW = 300 Hz ; 11g: RBW = 1 MHz, VBW = 1 kHz ;  
11n (HT20): RBW = 1 MHz, VBW = 1 kHz ; 11n (HT40): RBW = 1 MHz, VBW = 3 kHz)
4. All modes of operation were investigated and the worst-case emissions are reported.

4.1.4 Deviation from Test Standard

No deviation.

4.1.5 Test Set Up

<Radiated Emission below 30 MHz>

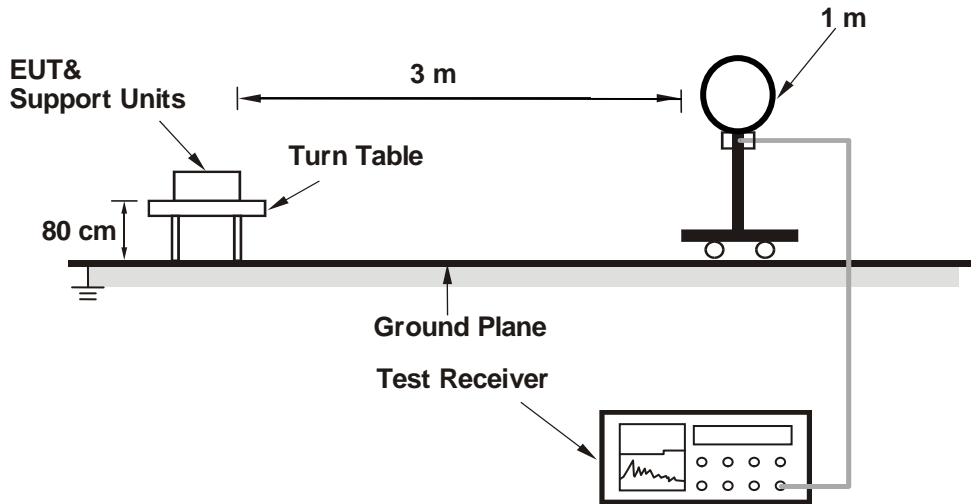

<Radiated Emission 30 MHz to 1 GHz>

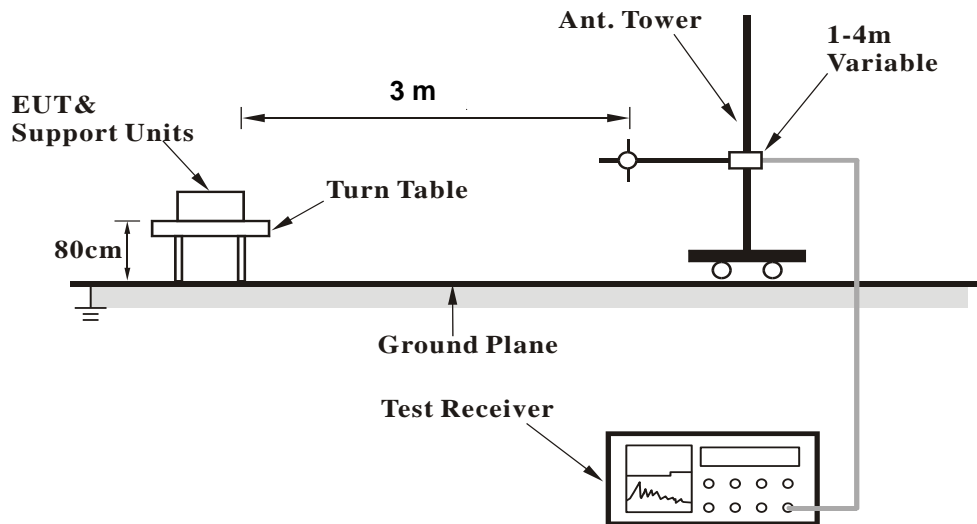

### <Radiated Emission above 1 GHz>

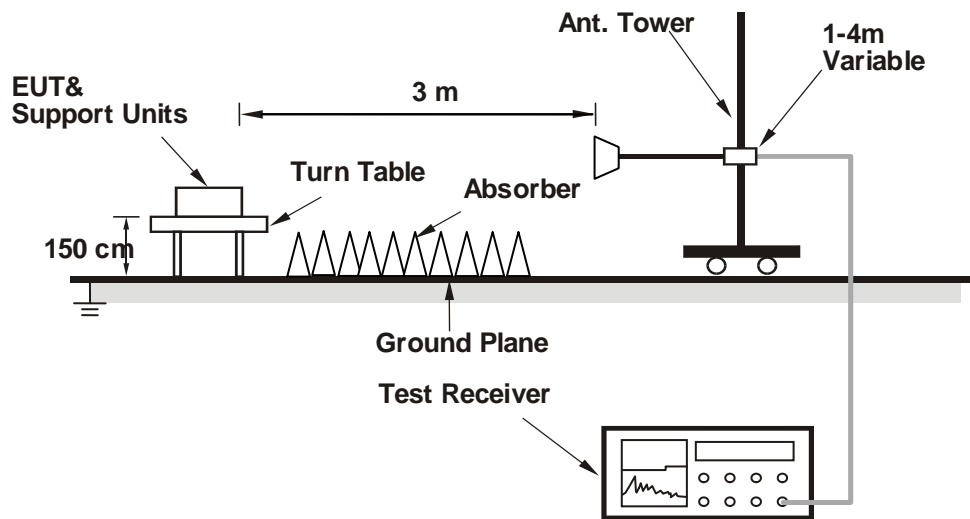

For the actual test configuration, please refer to the attached file (Test Setup Photo).

#### 4.1.6 EUT Operating Conditions

- Placed the EUT on a testing table.
- Use the software to control the EUT under transmission condition continuously at specific channel frequency.

4.1.7 Test Results

Above 1 GHz Data :

Mode A

TX\_High

ABOVE 1GHz DATA

802.11b

<b>CHANNEL</b>	TX Channel 1	<b>DETECTOR FUNCTION</b>	Peak (PK)
<b>FREQUENCY RANGE</b>	1GHz ~ 25GHz		Average (AV)

**ANTENNA POLARITY & TEST DISTANCE: HORIZONTAL AT 3 M**

NO.	FREQ. (MHz)	EMISSION LEVEL (dBuV/m)	LIMIT (dBuV/m)	MARGIN (dB)	ANTENNA HEIGHT (m)	TABLE ANGLE (Degree)	RAW VALUE (dBuV)	CORRECTION FACTOR (dB/m)
1	2390.00	54.9 PK	74.0	-19.1	1.32 H	280	57.3	-2.4
2	2390.00	40.2 AV	54.0	-13.8	1.32 H	280	42.6	-2.4
3	*2412.00	108.7 PK			1.21 H	288	111.2	-2.5
4	*2412.00	104.8 AV			1.21 H	288	107.4	-2.5
5	4824.00	44.9 PK	74.0	-29.1	1.53 H	89	41.6	3.3
6	4824.00	33.6 AV	54.0	-20.4	1.53 H	89	30.3	3.3

**ANTENNA POLARITY & TEST DISTANCE: VERTICAL AT 3 M**

NO.	FREQ. (MHz)	EMISSION LEVEL (dBuV/m)	LIMIT (dBuV/m)	MARGIN (dB)	ANTENNA HEIGHT (m)	TABLE ANGLE (Degree)	RAW VALUE (dBuV)	CORRECTION FACTOR (dB/m)
1	2390.00	53.8 PK	74.0	-20.2	2.83 V	261	56.2	-2.4
2	2390.00	38.8 AV	54.0	-15.2	2.83 V	261	41.2	-2.4
3	*2412.00	105.4 PK			2.91 V	225	107.9	-2.5
4	*2412.00	100.8 AV			2.91 V	225	103.3	-2.5
5	4824.00	43.6 PK	74.0	-30.4	1.98 V	16	40.3	3.3
6	4824.00	32.7 AV	54.0	-21.3	1.98 V	16	29.4	3.3

**REMARKS:**

1. Emission Level(dBuV/m) = Raw Value(dBuV) + Correction Factor(dB/m)
2. Correction Factor(dB/m) = Antenna Factor(dB/m) + Cable Factor(dB) – Pre-Amplifier Factor(dB)
3. The other emission levels were very low against the limit.
4. Margin value = Emission Level – Limit value
5. " \* ": Fundamental frequency.

<b>CHANNEL</b>	TX Channel 6	<b>DETECTOR FUNCTION</b>	Peak (PK)
<b>FREQUENCY RANGE</b>	1GHz ~ 25GHz		Average (AV)

**ANTENNA POLARITY & TEST DISTANCE: HORIZONTAL AT 3 M**

NO.	FREQ. (MHz)	EMISSION LEVEL (dBuV/m)	LIMIT (dBuV/m)	MARGIN (dB)	ANTENNA HEIGHT (m)	TABLE ANGLE (Degree)	RAW VALUE (dBuV)	CORRECTION FACTOR (dB/m)
1	*2437.00	109.9 PK			1.53 H	277	112.5	-2.6
2	*2437.00	106.0 AV			1.53 H	277	108.7	-2.6
3	4874.00	45.4 PK	74.0	-28.6	1.74 H	62	42.1	3.4
4	4874.00	34.9 AV	54.0	-19.1	1.74 H	62	31.6	3.4

**ANTENNA POLARITY & TEST DISTANCE: VERTICAL AT 3 M**

NO.	FREQ. (MHz)	EMISSION LEVEL (dBuV/m)	LIMIT (dBuV/m)	MARGIN (dB)	ANTENNA HEIGHT (m)	TABLE ANGLE (Degree)	RAW VALUE (dBuV)	CORRECTION FACTOR (dB/m)
1	*2437.00	104.9 PK			2.69 V	240	107.5	-2.6
2	*2437.00	100.6 AV			2.69 V	240	103.2	-2.6
3	4874.00	43.9 PK	74.0	-30.1	2.23 V	351	40.6	3.4
4	4874.00	33.3 AV	54.0	-20.7	2.23 V	351	29.9	3.4

**REMARKS:**

1. Emission Level(dBuV/m) = Raw Value(dBuV) + Correction Factor(dB/m)
2. Correction Factor(dB/m) = Antenna Factor(dB/m) + Cable Factor(dB) – Pre-Amplifier Factor(dB)
3. The other emission levels were very low against the limit.
4. Margin value = Emission Level – Limit value
5. " \* ": Fundamental frequency.

<b>CHANNEL</b>	TX Channel 11	<b>DETECTOR FUNCTION</b>	Peak (PK)
<b>FREQUENCY RANGE</b>	1GHz ~ 25GHz		Average (AV)

**ANTENNA POLARITY & TEST DISTANCE: HORIZONTAL AT 3 M**

NO.	FREQ. (MHz)	EMISSION LEVEL (dBuV/m)	LIMIT (dBuV/m)	MARGIN (dB)	ANTENNA HEIGHT (m)	TABLE ANGLE (Degree)	RAW VALUE (dBuV)	CORRECTION FACTOR (dB/m)
1	*2462.00	110.5 PK			1.45 H	281	113.1	-2.5
2	*2462.00	106.7 AV			1.45 H	281	109.2	-2.5
3	2483.50	60.2 PK	74.0	-13.9	1.78 H	259	62.4	-2.2
4	2483.50	42.2 AV	54.0	-11.8	1.78 H	259	44.5	-2.2
5	4924.00	46.2 PK	74.0	-27.8	1.66 H	70	42.9	3.2
6	4924.00	36.7 AV	54.0	-17.3	1.66 H	70	33.5	3.2

**ANTENNA POLARITY & TEST DISTANCE: VERTICAL AT 3 M**

NO.	FREQ. (MHz)	EMISSION LEVEL (dBuV/m)	LIMIT (dBuV/m)	MARGIN (dB)	ANTENNA HEIGHT (m)	TABLE ANGLE (Degree)	RAW VALUE (dBuV)	CORRECTION FACTOR (dB/m)
1	*2462.00	106.1 PK			2.73 V	238	108.7	-2.5
2	*2462.00	102.1 AV			2.73 V	238	104.6	-2.5
3	2483.50	58.6 PK	74.0	-15.4	2.69 V	251	60.9	-2.2
4	2483.50	40.7 AV	54.0	-13.3	2.69 V	251	42.9	-2.2
5	4924.00	44.8 PK	74.0	-29.2	2.17 V	358	41.5	3.2
6	4924.00	35.2 AV	54.0	-18.8	2.17 V	358	32.0	3.2

**REMARKS:**

1. Emission Level(dBuV/m) = Raw Value(dBuV) + Correction Factor(dB/m)
2. Correction Factor(dB/m) = Antenna Factor(dB/m) + Cable Factor(dB) – Pre-Amplifier Factor(dB)
3. The other emission levels were very low against the limit.
4. Margin value = Emission Level – Limit value
5. " \* ": Fundamental frequency.

802.11g

<b>CHANNEL</b>	TX Channel 1	<b>DETECTOR FUNCTION</b>	Peak (PK)
<b>FREQUENCY RANGE</b>	1GHz ~ 25GHz		Average (AV)

**ANTENNA POLARITY & TEST DISTANCE: HORIZONTAL AT 3 M**

NO.	FREQ. (MHz)	EMISSION LEVEL (dBuV/m)	LIMIT (dBuV/m)	MARGIN (dB)	ANTENNA HEIGHT (m)	TABLE ANGLE (Degree)	RAW VALUE (dBuV)	CORRECTION FACTOR (dB/m)
1	2390.00	68.4 PK	74.0	-5.6	1.46 H	291	70.7	-2.4
2	2390.00	50.5 AV	54.0	-3.5	1.46 H	291	52.9	-2.4
3	*2412.00	110.6 PK			1.53 H	277	113.1	-2.5
4	*2412.00	100.8 AV			1.53 H	277	103.3	-2.5
5	4824.00	49.0 PK	74.0	-25.0	1.38 H	114	45.7	3.3
6	4824.00	33.1 AV	54.0	-20.9	1.38 H	114	29.7	3.3

**ANTENNA POLARITY & TEST DISTANCE: VERTICAL AT 3 M**

NO.	FREQ. (MHz)	EMISSION LEVEL (dBuV/m)	LIMIT (dBuV/m)	MARGIN (dB)	ANTENNA HEIGHT (m)	TABLE ANGLE (Degree)	RAW VALUE (dBuV)	CORRECTION FACTOR (dB/m)
1	2390.00	65.5 PK	74.0	-8.5	2.79 V	255	67.9	-2.4
2	2390.00	48.1 AV	54.0	-5.9	2.79 V	255	50.5	-2.4
3	*2412.00	106.0 PK			2.87 V	231	108.5	-2.5
4	*2412.00	96.6 AV			2.87 V	231	99.1	-2.5
5	4824.00	48.3 PK	74.0	-25.8	2.03 V	344	44.9	3.3
6	4824.00	32.1 AV	54.0	-21.9	2.03 V	344	28.8	3.3

**REMARKS:**

1. Emission Level(dBuV/m) = Raw Value(dBuV) + Correction Factor(dB/m)
2. Correction Factor(dB/m) = Antenna Factor(dB/m) + Cable Factor(dB) – Pre-Amplifier Factor(dB)
3. The other emission levels were very low against the limit.
4. Margin value = Emission Level – Limit value
5. " \* ": Fundamental frequency.

<b>CHANNEL</b>	TX Channel 6	<b>DETECTOR FUNCTION</b>	Peak (PK)
<b>FREQUENCY RANGE</b>	1GHz ~ 25GHz		Average (AV)

**ANTENNA POLARITY & TEST DISTANCE: HORIZONTAL AT 3 M**

NO.	FREQ. (MHz)	EMISSION LEVEL (dBuV/m)	LIMIT (dBuV/m)	MARGIN (dB)	ANTENNA HEIGHT (m)	TABLE ANGLE (Degree)	RAW VALUE (dBuV)	CORRECTION FACTOR (dB/m)
1	*2437.00	110.9 PK			1.56 H	270	113.6	-2.6
2	*2437.00	101.1 AV			1.56 H	270	103.7	-2.6
3	4874.00	50.2 PK	74.0	-23.8	1.42 H	125	46.9	3.4
4	4874.00	33.3 AV	54.0	-20.7	1.42 H	125	30.0	3.4

**ANTENNA POLARITY & TEST DISTANCE: VERTICAL AT 3 M**

NO.	FREQ. (MHz)	EMISSION LEVEL (dBuV/m)	LIMIT (dBuV/m)	MARGIN (dB)	ANTENNA HEIGHT (m)	TABLE ANGLE (Degree)	RAW VALUE (dBuV)	CORRECTION FACTOR (dB/m)
1	*2437.00	106.5 PK			2.77 V	229	109.1	-2.6
2	*2437.00	96.7 AV			2.77 V	229	99.4	-2.6
3	4874.00	48.5 PK	74.0	-25.5	1.94 V	352	45.1	3.4
4	4874.00	32.3 AV	54.0	-21.7	1.94 V	352	29.0	3.4

**REMARKS:**

1. Emission Level(dBuV/m) = Raw Value(dBuV) + Correction Factor(dB/m)
2. Correction Factor(dB/m) = Antenna Factor(dB/m) + Cable Factor(dB) – Pre-Amplifier Factor(dB)
3. The other emission levels were very low against the limit.
4. Margin value = Emission Level – Limit value
5. " \* ": Fundamental frequency.



<b>CHANNEL</b>	TX Channel 11	<b>DETECTOR FUNCTION</b>	Peak (PK)
<b>FREQUENCY RANGE</b>	1GHz ~ 25GHz		Average (AV)

**ANTENNA POLARITY & TEST DISTANCE: HORIZONTAL AT 3 M**

NO.	FREQ. (MHz)	EMISSION LEVEL (dBuV/m)	LIMIT (dBuV/m)	MARGIN (dB)	ANTENNA HEIGHT (m)	TABLE ANGLE (Degree)	RAW VALUE (dBuV)	CORRECTION FACTOR (dB/m)
1	*2462.00	111.5 PK			1.51 H	280	114.1	-2.5
2	*2462.00	101.7 AV			1.51 H	280	104.2	-2.5
3	2483.50	71.9 PK	74.0	-2.1	1.66 H	283	74.1	-2.2
4	2483.50	50.3 AV	54.0	-3.7	1.66 H	283	52.5	-2.2
5	4924.00	48.6 PK	74.0	-25.4	1.40 H	108	45.4	3.2
6	4924.00	33.1 AV	54.0	-20.9	1.40 H	108	29.9	3.2

**ANTENNA POLARITY & TEST DISTANCE: VERTICAL AT 3 M**

NO.	FREQ. (MHz)	EMISSION LEVEL (dBuV/m)	LIMIT (dBuV/m)	MARGIN (dB)	ANTENNA HEIGHT (m)	TABLE ANGLE (Degree)	RAW VALUE (dBuV)	CORRECTION FACTOR (dB/m)
1	*2462.00	106.4 PK			2.73 V	227	108.9	-2.5
2	*2462.00	96.6 AV			2.73 V	227	99.1	-2.5
3	2483.50	70.1 PK	74.0	-3.9	2.65 V	196	72.3	-2.2
4	2483.50	49.0 AV	54.0	-5.0	2.65 V	196	51.3	-2.2
5	4924.00	47.9 PK	74.0	-26.1	1.84 V	17	44.7	3.2
6	4924.00	32.1 AV	54.0	-21.9	1.84 V	17	28.8	3.2

**REMARKS:**

1. Emission Level(dBuV/m) = Raw Value(dBuV) + Correction Factor(dB/m)
2. Correction Factor(dB/m) = Antenna Factor(dB/m) + Cable Factor(dB) – Pre-Amplifier Factor(dB)
3. The other emission levels were very low against the limit.
4. Margin value = Emission Level – Limit value
5. " \* ": Fundamental frequency.

802.11n (HT20)

<b>CHANNEL</b>	TX Channel 1	<b>DETECTOR FUNCTION</b>	Peak (PK)
<b>FREQUENCY RANGE</b>	1GHz ~ 25GHz		Average (AV)

**ANTENNA POLARITY & TEST DISTANCE: HORIZONTAL AT 3 M**

NO.	FREQ. (MHz)	EMISSION LEVEL (dBuV/m)	LIMIT (dBuV/m)	MARGIN (dB)	ANTENNA HEIGHT (m)	TABLE ANGLE (Degree)	RAW VALUE (dBuV)	CORRECTION FACTOR (dB/m)
1	2390.00	71.0 PK	74.0	-3.0	1.44 H	252	73.4	-2.4
2	2390.00	50.3 AV	54.0	-3.7	1.44 H	252	52.7	-2.4
3	*2412.00	111.2 PK			1.55 H	279	113.7	-2.5
4	*2412.00	101.3 AV			1.55 H	279	103.8	-2.5
5	4824.00	50.1 PK	74.0	-23.9	1.39 H	120	46.7	3.3
6	4824.00	33.1 AV	54.0	-20.9	1.39 H	120	29.7	3.3

**ANTENNA POLARITY & TEST DISTANCE: VERTICAL AT 3 M**

NO.	FREQ. (MHz)	EMISSION LEVEL (dBuV/m)	LIMIT (dBuV/m)	MARGIN (dB)	ANTENNA HEIGHT (m)	TABLE ANGLE (Degree)	RAW VALUE (dBuV)	CORRECTION FACTOR (dB/m)
1	2390.00	64.8 PK	74.0	-9.2	2.68 V	209	67.2	-2.4
2	2390.00	38.0 AV	54.0	-16.0	2.68 V	209	40.4	-2.4
3	*2412.00	106.3 PK			2.75 V	227	108.8	-2.5
4	*2412.00	96.6 AV			2.75 V	227	99.1	-2.5
5	4824.00	48.6 PK	74.0	-25.4	1.98 V	15	45.3	3.3
6	4824.00	31.9 AV	54.0	-22.1	1.98 V	15	28.6	3.3

**REMARKS:**

1. Emission Level(dBuV/m) = Raw Value(dBuV) + Correction Factor(dB/m)
2. Correction Factor(dB/m) = Antenna Factor(dB/m) + Cable Factor(dB) – Pre-Amplifier Factor(dB)
3. The other emission levels were very low against the limit.
4. Margin value = Emission Level – Limit value
5. " \* ": Fundamental frequency.

<b>CHANNEL</b>	TX Channel 6	<b>DETECTOR FUNCTION</b>	Peak (PK)
<b>FREQUENCY RANGE</b>	1GHz ~ 25GHz		Average (AV)

**ANTENNA POLARITY & TEST DISTANCE: HORIZONTAL AT 3 M**

NO.	FREQ. (MHz)	EMISSION LEVEL (dBuV/m)	LIMIT (dBuV/m)	MARGIN (dB)	ANTENNA HEIGHT (m)	TABLE ANGLE (Degree)	RAW VALUE (dBuV)	CORRECTION FACTOR (dB/m)
1	*2437.00	111.4 PK			1.50 H	282	114.1	-2.6
2	*2437.00	101.7 AV			1.50 H	282	104.3	-2.6
3	4874.00	49.9 PK	74.0	-24.1	1.26 H	111	46.5	3.4
4	4874.00	33.2 AV	54.0	-20.8	1.26 H	111	29.9	3.4

**ANTENNA POLARITY & TEST DISTANCE: VERTICAL AT 3 M**

NO.	FREQ. (MHz)	EMISSION LEVEL (dBuV/m)	LIMIT (dBuV/m)	MARGIN (dB)	ANTENNA HEIGHT (m)	TABLE ANGLE (Degree)	RAW VALUE (dBuV)	CORRECTION FACTOR (dB/m)
1	*2437.00	106.4 PK			2.81 V	216	109.0	-2.6
2	*2437.00	96.7 AV			2.81 V	216	99.4	-2.6
3	4874.00	49.0 PK	74.0	-25.0	1.84 V	351	45.7	3.4
4	4874.00	32.2 AV	54.0	-21.9	1.84 V	351	28.8	3.4

**REMARKS:**

1. Emission Level(dBuV/m) = Raw Value(dBuV) + Correction Factor(dB/m)
2. Correction Factor(dB/m) = Antenna Factor(dB/m) + Cable Factor(dB) – Pre-Amplifier Factor(dB)
3. The other emission levels were very low against the limit.
4. Margin value = Emission Level – Limit value
5. " \* ": Fundamental frequency.

<b>CHANNEL</b>	TX Channel 11	<b>DETECTOR FUNCTION</b>	Peak (PK)
<b>FREQUENCY RANGE</b>	1GHz ~ 25GHz		Average (AV)

**ANTENNA POLARITY & TEST DISTANCE: HORIZONTAL AT 3 M**

NO.	FREQ. (MHz)	EMISSION LEVEL (dBuV/m)	LIMIT (dBuV/m)	MARGIN (dB)	ANTENNA HEIGHT (m)	TABLE ANGLE (Degree)	RAW VALUE (dBuV)	CORRECTION FACTOR (dB/m)
1	*2462.00	111.7 PK			1.54 H	283	114.2	-2.5
2	*2462.00	102.0 AV			1.54 H	283	104.5	-2.5
3	2483.50	72.1 PK	74.0	-1.9	1.70 H	271	74.3	-2.2
4	2483.50	50.5 AV	54.0	-3.5	1.70 H	271	52.8	-2.2
5	4924.00	49.1 PK	74.0	-24.9	1.33 H	105	45.9	3.2
6	4924.00	32.9 AV	54.0	-21.1	1.33 H	105	29.7	3.2

**ANTENNA POLARITY & TEST DISTANCE: VERTICAL AT 3 M**

NO.	FREQ. (MHz)	EMISSION LEVEL (dBuV/m)	LIMIT (dBuV/m)	MARGIN (dB)	ANTENNA HEIGHT (m)	TABLE ANGLE (Degree)	RAW VALUE (dBuV)	CORRECTION FACTOR (dB/m)
1	*2462.00	106.1 PK			2.68 V	205	108.7	-2.5
2	*2462.00	96.4 AV			2.68 V	205	99.0	-2.5
3	2483.50	68.6 PK	74.0	-5.4	2.70 V	188	70.8	-2.2
4	2483.50	47.9 AV	54.0	-6.1	2.70 V	188	50.2	-2.2
5	4924.00	48.0 PK	74.0	-26.0	1.91 V	27	44.8	3.2
6	4924.00	32.1 AV	54.0	-21.9	1.91 V	27	28.9	3.2

**REMARKS:**

1. Emission Level(dBuV/m) = Raw Value(dBuV) + Correction Factor(dB/m)
2. Correction Factor(dB/m) = Antenna Factor(dB/m) + Cable Factor(dB) – Pre-Amplifier Factor(dB)
3. The other emission levels were very low against the limit.
4. Margin value = Emission Level – Limit value
5. " \* ": Fundamental frequency.

802.11n (HT40)

<b>CHANNEL</b>	TX Channel 3	<b>DETECTOR FUNCTION</b>	Peak (PK)
<b>FREQUENCY RANGE</b>	1GHz ~ 25GHz		Average (AV)

**ANTENNA POLARITY & TEST DISTANCE: HORIZONTAL AT 3 M**

NO.	FREQ. (MHz)	EMISSION LEVEL (dBuV/m)	LIMIT (dBuV/m)	MARGIN (dB)	ANTENNA HEIGHT (m)	TABLE ANGLE (Degree)	RAW VALUE (dBuV)	CORRECTION FACTOR (dB/m)
1	2390.00	69.1 PK	74.0	-4.9	1.26 H	280	35.6	33.5
2	2390.00	51.4 AV	54.0	-2.6	1.26 H	280	17.9	33.5
3	*2422.00	102.3 PK			1.22 H	278	68.9	33.4
4	*2422.00	90.8 AV			1.22 H	278	57.4	33.4
5	4844.00	45.0 PK	74.0	-29.0	1.79 H	127	41.2	3.8
6	4844.00	31.9 AV	54.0	-22.1	1.79 H	127	28.1	3.8

**ANTENNA POLARITY & TEST DISTANCE: VERTICAL AT 3 M**

NO.	FREQ. (MHz)	EMISSION LEVEL (dBuV/m)	LIMIT (dBuV/m)	MARGIN (dB)	ANTENNA HEIGHT (m)	TABLE ANGLE (Degree)	RAW VALUE (dBuV)	CORRECTION FACTOR (dB/m)
1	2390.00	67.8 PK	74.0	-6.2	3.51 V	250	34.3	33.5
2	2390.00	50.5 AV	54.0	-3.5	3.51 V	250	17.0	33.5
3	*2422.00	99.9 PK			3.76 V	244	66.5	33.4
4	*2422.00	89.4 AV			3.76 V	244	56.0	33.4
5	4844.00	46.0 PK	74.0	-28.0	2.46 V	320	42.2	3.8
6	4844.00	32.6 AV	54.0	-21.4	2.46 V	320	28.8	3.8

**REMARKS:**

1. Emission Level(dBuV/m) = Raw Value(dBuV) + Correction Factor(dB/m)
2. Correction Factor(dB/m) = Antenna Factor(dB/m) + Cable Factor(dB) – Pre-Amplifier Factor(dB)
3. The other emission levels were very low against the limit.
4. Margin value = Emission Level – Limit value
5. " \* ": Fundamental frequency.

<b>CHANNEL</b>	TX Channel 6	<b>DETECTOR FUNCTION</b>	Peak (PK)
<b>FREQUENCY RANGE</b>	1GHz ~ 25GHz		Average (AV)

**ANTENNA POLARITY & TEST DISTANCE: HORIZONTAL AT 3 M**

NO.	FREQ. (MHz)	EMISSION LEVEL (dBuV/m)	LIMIT (dBuV/m)	MARGIN (dB)	ANTENNA HEIGHT (m)	TABLE ANGLE (Degree)	RAW VALUE (dBuV)	CORRECTION FACTOR (dB/m)
1	*2437.00	101.3 PK			1.17 H	288	67.9	33.4
2	*2437.00	90.2 AV			1.17 H	288	56.8	33.4
3	4874.00	45.9 PK	74.0	-28.1	1.81 H	143	42.2	3.7
4	4874.00	32.7 AV	54.0	-21.3	1.81 H	143	29.0	3.7

**ANTENNA POLARITY & TEST DISTANCE: VERTICAL AT 3 M**

NO.	FREQ. (MHz)	EMISSION LEVEL (dBuV/m)	LIMIT (dBuV/m)	MARGIN (dB)	ANTENNA HEIGHT (m)	TABLE ANGLE (Degree)	RAW VALUE (dBuV)	CORRECTION FACTOR (dB/m)
1	*2437.00	99.2 PK			2.47 V	234	65.8	33.4
2	*2437.00	89.0 AV			2.47 V	234	55.6	33.4
3	4874.00	46.6 PK	74.0	-27.4	2.39 V	293	42.9	3.7
4	4874.00	33.7 AV	54.0	-20.3	2.39 V	293	30.0	3.7

**REMARKS:**

1. Emission Level(dBuV/m) = Raw Value(dBuV) + Correction Factor(dB/m)
2. Correction Factor(dB/m) = Antenna Factor(dB/m) + Cable Factor(dB) – Pre-Amplifier Factor(dB)
3. The other emission levels were very low against the limit.
4. Margin value = Emission Level – Limit value
5. " \* ": Fundamental frequency.

<b>CHANNEL</b>	TX Channel 9	<b>DETECTOR FUNCTION</b>	Peak (PK)
<b>FREQUENCY RANGE</b>	1GHz ~ 25GHz		Average (AV)

**ANTENNA POLARITY & TEST DISTANCE: HORIZONTAL AT 3 M**

NO.	FREQ. (MHz)	EMISSION LEVEL (dBuV/m)	LIMIT (dBuV/m)	MARGIN (dB)	ANTENNA HEIGHT (m)	TABLE ANGLE (Degree)	RAW VALUE (dBuV)	CORRECTION FACTOR (dB/m)
1	*2452.00	100.2 PK			1.12 H	287	66.8	33.4
2	*2452.00	89.4 AV			1.12 H	287	56.0	33.4
3	2483.50	70.0 PK	74.0	-4.0	1.22 H	281	36.8	33.2
4	2483.50	52.0 AV	54.0	-2.0	1.22 H	281	18.8	33.2
5	4904.00	46.0 PK	74.0	-28.0	1.70 H	133	42.5	3.5
6	4904.00	32.9 AV	54.0	-21.1	1.70 H	133	29.4	3.5

**ANTENNA POLARITY & TEST DISTANCE: VERTICAL AT 3 M**

NO.	FREQ. (MHz)	EMISSION LEVEL (dBuV/m)	LIMIT (dBuV/m)	MARGIN (dB)	ANTENNA HEIGHT (m)	TABLE ANGLE (Degree)	RAW VALUE (dBuV)	CORRECTION FACTOR (dB/m)
1	*2452.00	99.5 PK			3.80 V	255	66.1	33.4
2	*2452.00	88.4 AV			3.80 V	255	55.0	33.4
3	2483.50	71.5 PK	74.0	-2.5	3.63 V	261	38.3	33.2
<b>4</b>	<b>2483.50</b>	<b>52.1 AV</b>	<b>54.0</b>	<b>-1.9</b>	<b>3.63 V</b>	<b>261</b>	<b>18.9</b>	<b>33.2</b>
5	4904.00	46.5 PK	74.0	-27.5	2.22 V	309	43.0	3.5
6	4904.00	32.8 AV	54.0	-21.2	2.22 V	309	29.3	3.5

**REMARKS:**

1. Emission Level(dBuV/m) = Raw Value(dBuV) + Correction Factor(dB/m)
2. Correction Factor(dB/m) = Antenna Factor(dB/m) + Cable Factor(dB) – Pre-Amplifier Factor(dB)
3. The other emission levels were very low against the limit.
4. Margin value = Emission Level – Limit value
5. " \* ": Fundamental frequency.

**9 kHz ~ 30 MHz Data:**

The amplitude of spurious emissions attenuated more than 20 dB below the permissible value is not required to be report.

**30 MHz ~ 1 GHz Worst-Case Data:**

**Mode A**

**802.11n (HT40)**

<b>CHANNEL</b>	TX Channel 9	<b>DETECTOR FUNCTION</b>	Quasi-Peak (QP)
<b>FREQUENCY RANGE</b>	30MHz ~ 1GHz		

**ANTENNA POLARITY & TEST DISTANCE: HORIZONTAL AT 3 M**

NO.	FREQ. (MHz)	EMISSION LEVEL (dBuV/m)	LIMIT (dBuV/m)	MARGIN (dB)	ANTENNA HEIGHT (m)	TABLE ANGLE (Degree)	RAW VALUE (dBuV)	CORRECTION FACTOR (dB/m)
1	46.30	23.4 QP	40.0	-16.6	2.29 H	260	30.6	-7.2
2	62.79	19.5 QP	40.0	-20.5	1.46 H	181	27.5	-7.9
3	146.30	21.5 QP	43.5	-22.0	2.27 H	122	28.7	-7.2
4	524.70	26.7 QP	46.0	-19.3	1.06 H	60	27.5	-0.8
5	674.27	29.5 QP	46.0	-16.5	1.45 H	330	27.4	2.1
6	808.91	32.4 QP	46.0	-13.6	1.82 H	104	28.2	4.2

**ANTENNA POLARITY & TEST DISTANCE: VERTICAL AT 3 M**

NO.	FREQ. (MHz)	EMISSION LEVEL (dBuV/m)	LIMIT (dBuV/m)	MARGIN (dB)	ANTENNA HEIGHT (m)	TABLE ANGLE (Degree)	RAW VALUE (dBuV)	CORRECTION FACTOR (dB/m)
1	43.92	30.4 QP	40.0	-9.6	2.25 V	60	37.8	-7.4
2	114.58	22.3 QP	43.5	-21.2	1.05 V	169	32.2	-9.9
3	522.52	27.4 QP	46.0	-18.6	1.16 V	304	28.3	-0.8
4	663.56	29.4 QP	46.0	-16.6	2.95 V	85	27.5	1.9
5	785.73	31.8 QP	46.0	-14.2	2.46 V	304	27.9	4.0
6	873.51	33.5 QP	46.0	-12.5	2.03 V	340	28.4	5.1

**REMARKS:**

1. Emission Level(dBuV/m) = Raw Value(dBuV) + Correction Factor(dB/m)
2. Correction Factor(dB/m) = Antenna Factor(dB/m) + Cable Factor(dB) – Pre-Amplifier Factor(dB)
3. The other emission levels were very low against the limit.
4. Margin value = Emission Level – Limit value



**Mode B**

**802.11n (HT40)**

<b>CHANNEL</b>	TX Channel 9	<b>DETECTOR FUNCTION</b>	Quasi-Peak (QP)
<b>FREQUENCY RANGE</b>	30MHz ~ 1GHz		

**ANTENNA POLARITY & TEST DISTANCE: HORIZONTAL AT 3 M**

NO.	FREQ. (MHz)	EMISSION LEVEL (dBuV/m)	LIMIT (dBuV/m)	MARGIN (dB)	ANTENNA HEIGHT (m)	TABLE ANGLE (Degree)	RAW VALUE (dBuV)	CORRECTION FACTOR (dB/m)
1	57.12	28.2 QP	40.0	-11.8	1.99 H	10	37.7	-9.5
2	92.12	30.7 QP	43.5	-12.8	1.99 H	145	45.5	-14.8
3	167.94	37.3 QP	43.5	-6.2	1.00 H	191	46.3	-9.0
4	302.10	30.6 QP	46.0	-15.4	1.00 H	322	37.7	-7.1
5	492.64	23.9 QP	46.0	-22.1	1.99 H	10	27.1	-3.2
6	667.63	32.0 QP	46.0	-14.0	1.49 H	113	31.5	0.5

**ANTENNA POLARITY & TEST DISTANCE: VERTICAL AT 3 M**

NO.	FREQ. (MHz)	EMISSION LEVEL (dBuV/m)	LIMIT (dBuV/m)	MARGIN (dB)	ANTENNA HEIGHT (m)	TABLE ANGLE (Degree)	RAW VALUE (dBuV)	CORRECTION FACTOR (dB/m)
1	43.51	29.6 QP	40.0	-10.4	1.00 V	355	39.2	-9.6
2	97.95	32.3 QP	43.5	-11.2	1.00 V	64	46.0	-13.7
3	167.94	31.0 QP	43.5	-12.5	1.00 V	123	40.0	-9.0
4	335.15	25.6 QP	46.0	-20.4	1.00 V	256	32.0	-6.4
5	492.64	24.8 QP	46.0	-21.2	1.00 V	172	28.0	-3.2
6	663.74	32.4 QP	46.0	-13.6	1.00 V	14	31.9	0.5

**REMARKS:**

1. Emission Level(dBuV/m) = Raw Value(dBuV) + Correction Factor(dB/m)
2. Correction Factor(dB/m) = Antenna Factor(dB/m) + Cable Factor(dB) – Pre-Amplifier Factor(dB)
3. The other emission levels were very low against the limit.
4. Margin value = Emission Level – Limit value

## 4.2 Conducted Emission Measurement

### 4.2.1 Limits of Conducted Emission Measurement

Frequency (MHz)	Conducted Limit (dBuV)	
	Quasi-Peak	Average
0.15 - 0.5	66 - 56	56 - 46
0.50 - 5.0	56	46
5.0 - 30.0	60	50

- Note: 1. The lower limit shall apply at the transition frequencies.  
 2. The limit decreases in line with the logarithm of the frequency in the range of 0.15 to 0.50 MHz.

### 4.2.2 Test Instruments

Description & Manufacturer	Model No.	Serial No.	Date of Calibration	Due Date of Calibration
Test Receiver ROHDE & SCHWARZ	ESR3	102412	Feb. 08, 2018	Feb. 07, 2019
RF signal cable (with 10dB PAD) Woken	5D-FB	Cable-cond2-01	Sep. 08, 2017	Sep. 07, 2018
LISN/AMN ROHDE & SCHWARZ (EUT)	ESH2-Z5	100100	Feb. 05, 2018	Feb. 04, 2019
LISN/AMN ROHDE & SCHWARZ (Peripheral)	ESH3-Z5	100312	Aug. 02, 2017	Aug. 01, 2018
Software ADT	BV ADT_Cond_ V7.3.7.4	NA	NA	NA

- Note: 1. The calibration interval of the above test instruments is 12 months and the calibrations are traceable to NML/ROC and NIST/USA.  
 2. The test was performed in HwaYa Shielded Room 2.  
 3. The VCCI Site Registration No. is C-2047.

#### 4.2.3 Test Procedures

- a. The EUT was placed 0.4 meters from the conducting wall of the shielded room with EUT being connected to the power mains through a line impedance stabilization network (LISN). Other support units were connected to the power mains through another LISN. The two LISNs provide 50 ohm/50 uH of coupling impedance for the measuring instrument.
- b. Both lines of the power mains connected to the EUT were checked for maximum conducted interference.
- c. The frequency range from 150 kHz to 30 MHz was searched. Emission levels under (Limit – 20 dB) was not recorded.

**Note:** The resolution bandwidth and video bandwidth of test receiver is 9 kHz for quasi-peak detection (QP) and average detection (AV) at frequency 0.15 MHz – 30 MHz.

#### 4.2.4 Deviation from Test Standard

No deviation.

#### 4.2.5 Test Setup

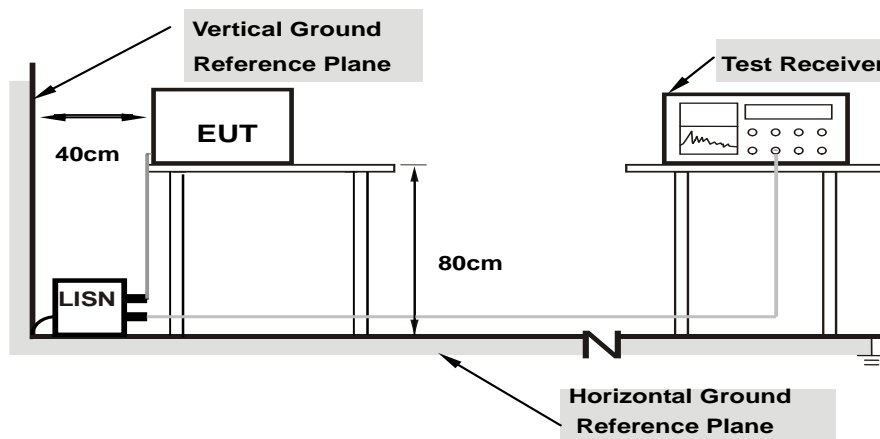

**Note:** 1.Support units were connected to second LISN.

For the actual test configuration, please refer to the attached file (Test Setup Photo).

#### 4.2.6 EUT Operating Conditions

- a. Placed the EUT on a testing table.
- b. Use the software to control the EUT under transmission condition continuously at specific channel frequency.

#### 4.2.7 Test Results

##### Mode A

Frequency Range	150kHz ~ 30MHz	Detector Function & Resolution Bandwidth	Quasi-Peak (QP) / Average (AV), 9kHz
Input Power	120Vac, 60Hz	Environmental Conditions	22°C, 66%RH
Tested by	Adair Peng	Test Date	2018/7/20

Phase Of Power : Line (L)										
No	Frequency (MHz)	Correction Factor (dB)	Reading Value (dBuV)		Emission Level (dBuV)		Limit (dBuV)		Margin (dB)	
			Q.P.	AV.	Q.P.	AV.	Q.P.	AV.	Q.P.	AV.
1	0.16966	10.25	37.25	18.39	47.50	28.64	64.98	54.98	-17.48	-26.34
2	0.52575	10.28	19.82	8.63	30.10	18.91	56.00	46.00	-25.90	-27.09
3	2.29192	10.39	20.19	15.08	30.58	25.47	56.00	46.00	-25.42	-20.53
4	3.69614	10.44	20.15	10.20	30.59	20.64	56.00	46.00	-25.41	-25.36
5	13.60500	10.66	16.00	9.57	26.66	20.23	60.00	50.00	-33.34	-29.77
6	18.55725	10.80	16.11	10.49	26.91	21.29	60.00	50.00	-33.09	-28.71

##### Remarks:

1. Q.P. and AV. are abbreviations of quasi-peak and average individually.
2. The emission levels of other frequencies were very low against the limit.
3. Margin value = Emission level – Limit value
4. Correction factor = Insertion loss + Cable loss
5. Emission Level = Correction Factor + Reading Value

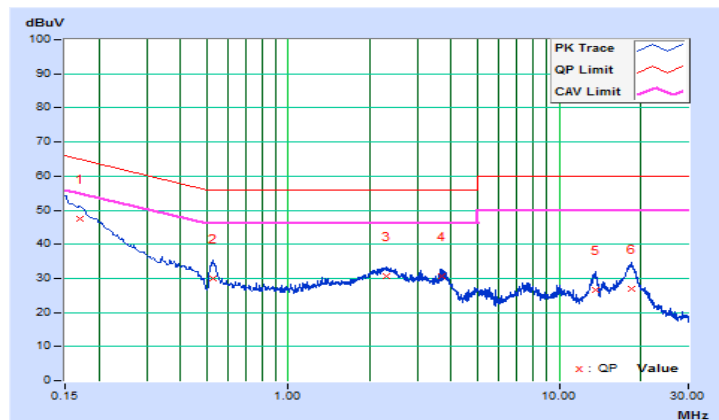

Frequency Range	150kHz ~ 30MHz	Detector Function & Resolution Bandwidth	Quasi-Peak (QP) / Average (AV), 9kHz
Input Power	120Vac, 60Hz	Environmental Conditions	22°C, 66%RH
Tested by	Adair Peng	Test Date	2018/7/20

Phase Of Power : Neutral (N)										
No	Frequency (MHz)	Correction Factor (dB)	Reading Value (dBuV)		Emission Level (dBuV)		Limit (dBuV)		Margin (dB)	
			Q.P.	AV.	Q.P.	AV.	Q.P.	AV.	Q.P.	AV.
1	0.16524	10.26	38.21	21.74	48.47	32.00	65.20	55.20	-16.73	-23.20
2	0.52125	10.29	22.40	13.11	32.69	23.40	56.00	46.00	-23.31	-22.60
3	2.31225	10.40	18.81	14.24	29.21	24.64	56.00	46.00	-26.79	-21.36
4	5.14725	10.51	16.67	9.35	27.18	19.86	60.00	50.00	-32.82	-30.14
5	13.42725	10.75	18.17	11.14	28.92	21.89	60.00	50.00	-31.08	-28.11
6	17.96325	10.91	16.07	10.66	26.98	21.57	60.00	50.00	-33.02	-28.43

Remarks:

1. Q.P. and AV. are abbreviations of quasi-peak and average individually.
2. The emission levels of other frequencies were very low against the limit.
3. Margin value = Emission level – Limit value
4. Correction factor = Insertion loss + Cable loss
5. Emission Level = Correction Factor + Reading Value

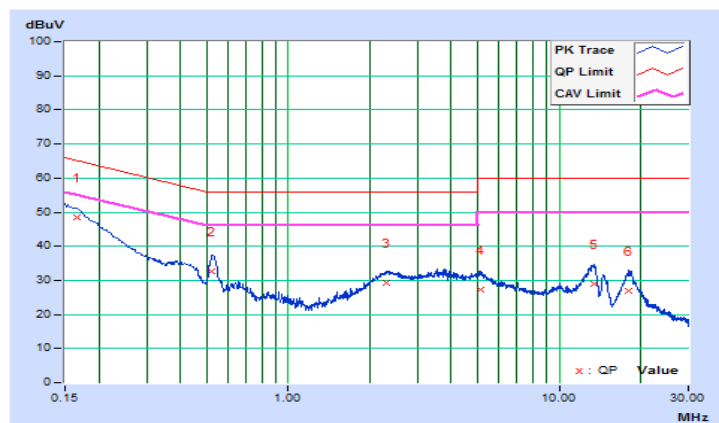

**Mode B**

Frequency Range	150kHz ~ 30MHz	Detector Function & Resolution Bandwidth	Quasi-Peak (QP) / Average (AV), 9kHz
Input Power	120Vac, 60Hz	Environmental Conditions	22°C , 66%RH
Tested by	Adair Peng	Test Date	2018/7/27

Phase Of Power : Line (L)										
No	Frequency (MHz)	Correction Factor (dB)	Reading Value (dBuV)		Emission Level (dBuV)		Limit (dBuV)		Margin (dB)	
			Q.P.	AV.	Q.P.	AV.	Q.P.	AV.	Q.P.	AV.
1	0.16136	10.25	41.52	22.56	51.77	32.81	65.39	55.39	-13.62	-22.58
2	0.51834	10.28	22.22	13.33	32.50	23.61	56.00	46.00	-23.50	-22.39
3	2.34600	10.39	24.17	17.00	34.56	27.39	56.00	46.00	-21.44	-18.61
4	3.51825	10.43	16.89	7.28	27.32	17.71	56.00	46.00	-28.68	-28.29
5	13.49475	10.66	17.86	12.40	28.52	23.06	60.00	50.00	-31.48	-26.94
6	18.62025	10.80	19.93	14.50	30.73	25.30	60.00	50.00	-29.27	-24.70

Remarks:

1. Q.P. and AV. are abbreviations of quasi-peak and average individually.
2. The emission levels of other frequencies were very low against the limit.
3. Margin value = Emission level – Limit value
4. Correction factor = Insertion loss + Cable loss
5. Emission Level = Correction Factor + Reading Value

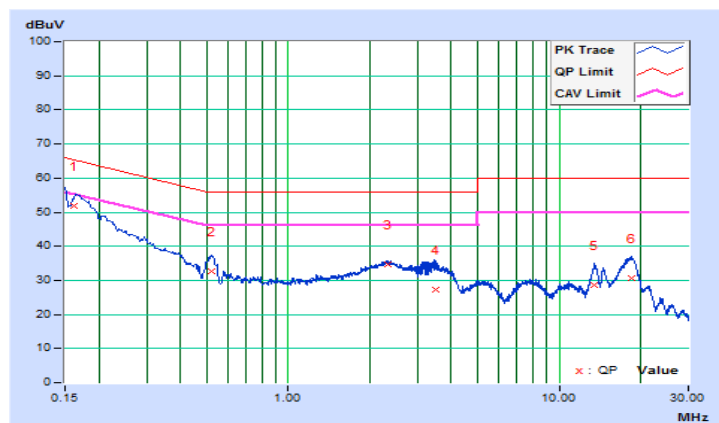

Frequency Range	150kHz ~ 30MHz	Detector Function & Resolution Bandwidth	Quasi-Peak (QP) / Average (AV), 9kHz
Input Power	120Vac, 60Hz	Environmental Conditions	22°C, 66%RH
Tested by	Adair Peng	Test Date	2018/7/27

Phase Of Power : Neutral (N)										
No	Frequency (MHz)	Correction Factor (dB)	Reading Value (dBuV)		Emission Level (dBuV)		Limit (dBuV)		Margin (dB)	
			Q.P.	AV.	Q.P.	AV.	Q.P.	AV.	Q.P.	AV.
1	0.16051	10.25	45.01	28.92	55.26	39.17	65.44	55.44	-10.18	-16.27
2	0.50350	10.29	24.52	15.91	34.81	26.20	56.00	46.00	-21.19	-19.80
3	2.33250	10.40	19.21	14.15	29.61	24.55	56.00	46.00	-26.39	-21.45
4	3.84225	10.47	19.91	14.33	30.38	24.80	56.00	46.00	-25.62	-21.20
5	13.43850	10.75	24.32	17.11	35.07	27.86	60.00	50.00	-24.93	-22.14
6	18.48075	10.93	19.32	14.25	30.25	25.18	60.00	50.00	-29.75	-24.82

Remarks:

1. Q.P. and AV. are abbreviations of quasi-peak and average individually.
2. The emission levels of other frequencies were very low against the limit.
3. Margin value = Emission level – Limit value
4. Correction factor = Insertion loss + Cable loss
5. Emission Level = Correction Factor + Reading Value

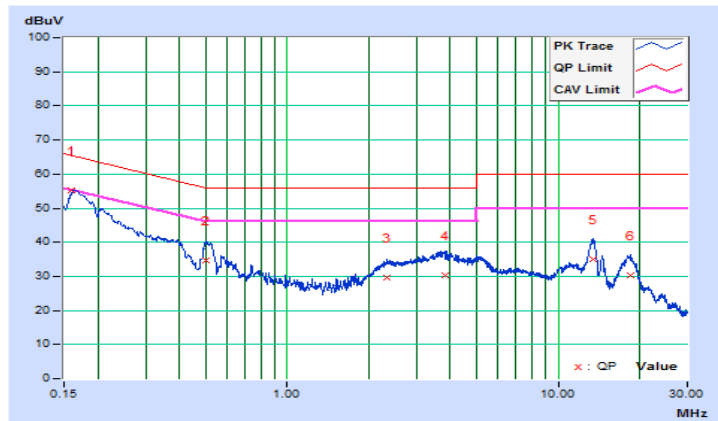

### 4.3 6 dB Bandwidth Measurement

#### 4.3.1 Limits of 6 dB Bandwidth Measurement

The minimum of 6 dB Bandwidth Measurement is 0.5 MHz.

#### 4.3.2 Test Setup

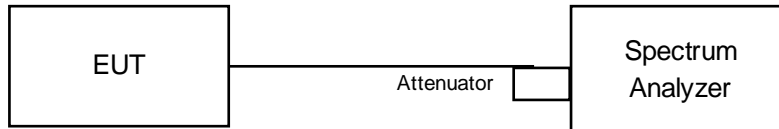

#### 4.3.3 Test Instruments

Refer to section 4.1.2 to get information of above instrument.

#### 4.3.4 Test Procedure

- Set resolution bandwidth (RBW) = 100 kHz
- Set the video bandwidth (VBW)  $\geq 3 \times$  RBW, Detector = Peak.
- Trace mode = max hold.
- Sweep = auto couple.
- Measure the maximum width of the emission that is constrained by the frequencies associated with the two amplitude points (upper and lower) that are attenuated by 6 dB relative to the maximum level measured in the fundamental emission

#### 4.3.5 Deviation from Test Standard

No deviation.

#### 4.3.6 EUT Operating Conditions

The software provided by client to enable the EUT under transmission condition continuously at lowest, middle and highest channel frequencies individually.



#### 4.3.7 Test Results

##### 802.11b

Channel	Frequency (MHz)	6 dB Bandwidth (MHz)	Minimum Limit (MHz)	Pass / Fail
1	2412	8.59	0.5	Pass
6	2437	8.11	0.5	Pass
11	2462	8.57	0.5	Pass

##### 802.11g

Channel	Frequency (MHz)	6 dB Bandwidth (MHz)	Minimum Limit (MHz)	Pass / Fail
1	2412	16.39	0.5	Pass
6	2437	16.39	0.5	Pass
11	2462	16.41	0.5	Pass

##### 802.11n (HT20)

Channel	Frequency (MHz)	6 dB Bandwidth (MHz)	Minimum Limit (MHz)	Pass / Fail
1	2412	17.61	0.5	Pass
6	2437	17.63	0.5	Pass
11	2462	17.57	0.5	Pass

##### 802.11n (HT40)

Channel	Frequency (MHz)	6 dB Bandwidth (MHz)	Minimum Limit (MHz)	Pass / Fail
3	2422	35.22	0.5	Pass
6	2437	35.35	0.5	Pass
9	2452	35.32	0.5	Pass

### Spectrum Plot of Worst Value

#### 802.11b

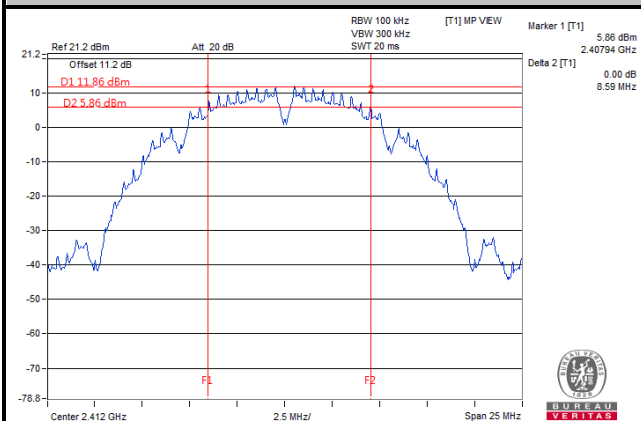

#### 802.11g

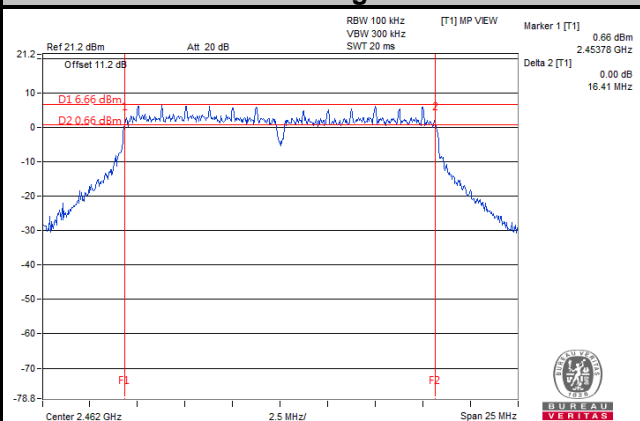

#### 802.11n (HT20)

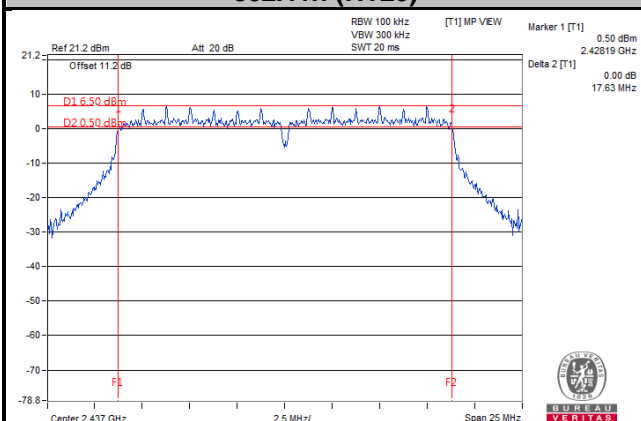

#### 802.11n (HT40)

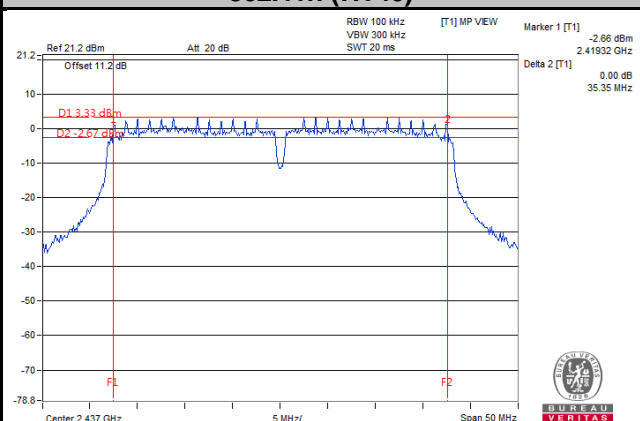

## 4.4 Occupied Bandwidth Measurement

### 4.4.1 Test Setup

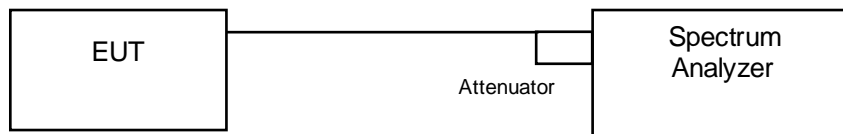

### 4.4.2 Test Instruments

Refer to section 4.1.2 to get information of above instrument.

### 4.4.3 Test Procedure

The transmitter output was connected to the spectrum analyzer through an attenuator. The bandwidth of the fundamental frequency was measured by spectrum analyzer with resolution bandwidth in the range of 1 % to 5 % of the anticipated emission bandwidth, and a video bandwidth at least 3x the resolution bandwidth and set the detector to PEAK. The width of a frequency band such that, below the lower and above the upper frequency limits, the mean powers emitted are each equal to a specified percentage 0.5 % of the total mean power of a given emission.

### 4.4.4 Deviation from Test Standard

No deviation.

### 4.4.5 EUT Operating Conditions

The software provided by client to enable the EUT under transmission condition continuously at lowest, middle and highest channel frequencies individually.

#### 4.4.6 Test Results

##### 802.11b

Channel	Frequency (MHz)	Occupied Bandwidth (MHz)	Pass / Fail
1	2412	13.08	Pass
6	2437	13.08	Pass
11	2462	13.07	Pass

##### 802.11g

Channel	Frequency (MHz)	Occupied Bandwidth (MHz)	Pass / Fail
1	2412	17.21	Pass
6	2437	17.12	Pass
11	2462	17.21	Pass

##### 802.11n (HT20)

Channel	Frequency (MHz)	Occupied Bandwidth (MHz)	Pass / Fail
1	2412	18.08	Pass
6	2437	18.26	Pass
11	2462	18.17	Pass

##### 802.11n (HT40)

Channel	Frequency (MHz)	Occupied Bandwidth (MHz)	Pass / Fail
3	2422	36.42	Pass
6	2437	36.72	Pass
9	2452	36.36	Pass

### Spectrum Plot of Worst Value

#### 802.11b

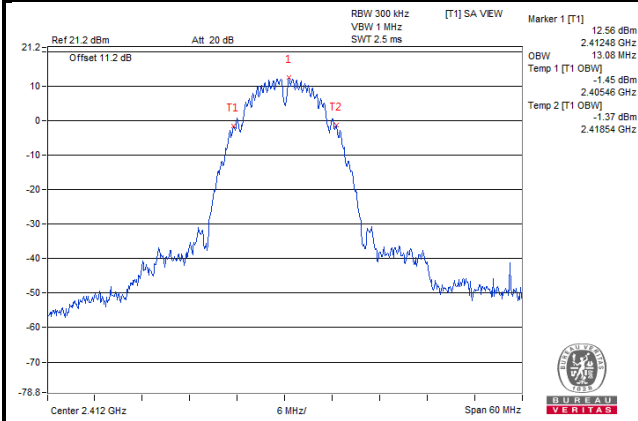

#### 802.11g

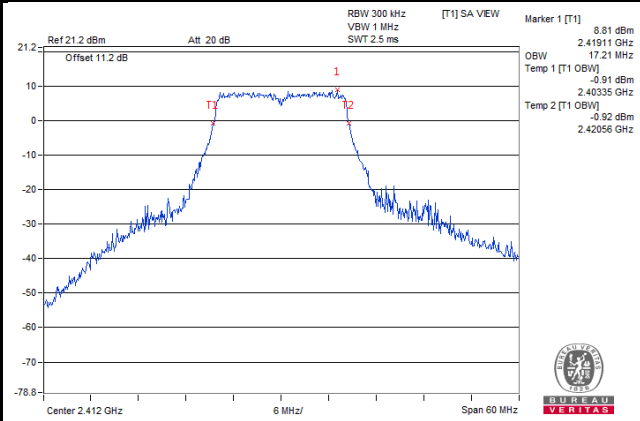

#### 802.11n (HT20)

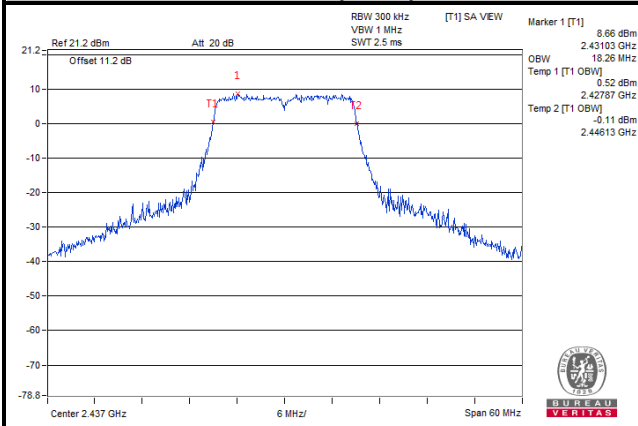

#### 802.11n (HT40)

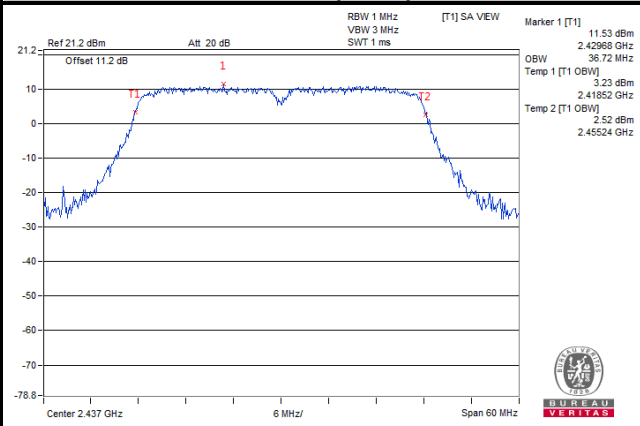

## 4.5 Conducted Output Power Measurement

### 4.5.1 Limits of Conducted Output Power Measurement

For systems using digital modulation in the 2400–2483.5 MHz bands: 1 Watt (30 dBm)

### 4.5.2 Test Setup

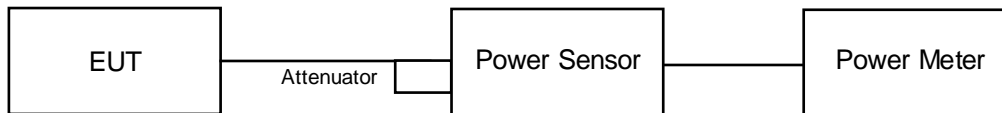

### 4.5.3 Test Instruments

Refer to section 4.1.2 to get information of above instrument.

### 4.5.4 Test Procedures

A peak power sensor was used on the output port of the EUT. A power meter was used to read the response of the peak power sensor. Record the power level.

### 4.5.5 Deviation from Test Standard

No deviation.

### 4.5.6 EUT Operating Conditions

The software provided by client to enable the EUT under transmission condition continuously at lowest, middle and highest channel frequencies individually.

#### 4.5.7 Test Results

##### <Peak Power>

##### 802.11b

Channel	Frequency (MHz)	Peak Power (mW)	Peak Power (dBm)	Limit (dBm)	Pass / Fail
1	2412	205.116	23.12	30	Pass
6	2437	210.863	23.24	30	Pass
11	2462	213.304	23.29	30	Pass

##### 802.11g

Channel	Frequency (MHz)	Peak Power (mW)	Peak Power (dBm)	Limit (dBm)	Pass / Fail
1	2412	359.749	25.56	30	Pass
6	2437	342.768	25.35	30	Pass
11	2462	376.704	25.76	30	Pass

##### 802.11n (HT20)

Channel	Frequency (MHz)	Peak Power (mW)	Peak Power (dBm)	Limit (dBm)	Pass / Fail
1	2412	349.14	25.43	30	Pass
6	2437	350.752	25.45	30	Pass
11	2462	367.282	25.65	30	Pass

##### 802.11n (HT40)

Channel	Frequency (MHz)	Peak Power (mW)	Peak Power (dBm)	Limit (dBm)	Pass / Fail
3	2422	358.096	25.54	30	Pass
6	2437	368.978	25.67	30	Pass
9	2452	363.915	25.61	30	Pass

<Average Power (For Reference)>

802.11b

Channel	Frequency (MHz)	Average Power (mW)	Average Power (dBm)
1	2412	107.647	20.32
6	2437	113.24	20.54
11	2462	112.72	20.52

802.11g

Channel	Frequency (MHz)	Average Power (mW)	Average Power (dBm)
1	2412	58.345	17.66
6	2437	58.749	17.69
11	2462	60.534	17.82

802.11n (HT20)

Channel	Frequency (MHz)	Average Power (mW)	Average Power (dBm)
1	2412	58.21	17.65
6	2437	59.566	17.75
11	2462	60.395	17.81

802.11n (HT40)

Channel	Frequency (MHz)	Average Power (mW)	Average Power (dBm)
3	2422	53.333	17.27
6	2437	54.325	17.35
9	2452	55.208	17.42



## 4.6 Power Spectral Density Measurement

### 4.6.1 Limits of Power Spectral Density Measurement

The Maximum of Power Spectral Density Measurement is 8 dBm.

### 4.6.2 Test Setup

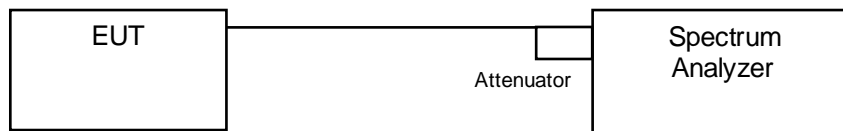

### 4.6.3 Test Instruments

Refer to section 4.1.2 to get information of above instrument.

### 4.6.4 Test Procedure

- a. Set analyzer center frequency to DTS channel center frequency.
- b. Set the span to 1.5 times the DTS bandwidth.
- c. Set the RBW to:  $3 \text{ kHz} \leq \text{RBW} \leq 100 \text{ kHz}$ .
- d. Set the VBW  $\geq 3 \times \text{RBW}$ .
- e. Detector = peak.
- f. Sweep time = auto couple.
- g. Trace mode = max hold.
- h. Allow trace to fully stabilize.
- i. Use the peak marker function to determine the maximum amplitude level within the RBW.

### 4.6.5 Deviation from Test Standard

No deviation.

### 4.6.6 EUT Operating Condition

The software provided by client to enable the EUT under transmission condition continuously at lowest, middle and highest channel frequencies individually.

## 4.6.7 Test Results

## 802.11b

Channel	Frequency (MHz)	PSD with Duty Factor (dBm/3 kHz)	Limit (dBm/3 kHz)	Pass / Fail
1	2412	-3.16	8	Pass
6	2437	-2.33	8	Pass
11	2462	-2.98	8	Pass

## 802.11g

Channel	Frequency (MHz)	PSD with Duty Factor (dBm/3 kHz)	Limit (dBm/3 kHz)	Pass / Fail
1	2412	-9.07	8	Pass
6	2437	-8.68	8	Pass
11	2462	-8.17	8	Pass

## 802.11n (HT20)

Channel	Frequency (MHz)	PSD with Duty Factor (dBm/3 kHz)	Limit (dBm/3 kHz)	Pass / Fail
1	2412	-8.75	8	Pass
6	2437	-8.32	8	Pass
11	2462	-8.12	8	Pass

## 802.11n (HT40)

Channel	Frequency (MHz)	PSD with Duty Factor (dBm/3 kHz)	Limit (dBm/3 kHz)	Pass / Fail
3	2422	-8.83	8	Pass
6	2437	-8.91	8	Pass
9	2452	-8.85	8	Pass

### Spectrum Plot of Worst Value

#### 802.11b

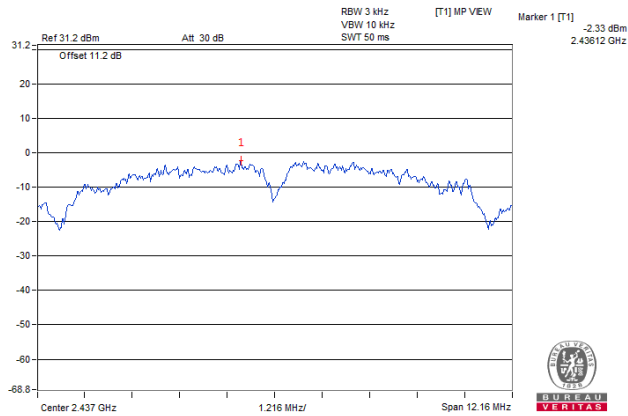

#### 802.11g

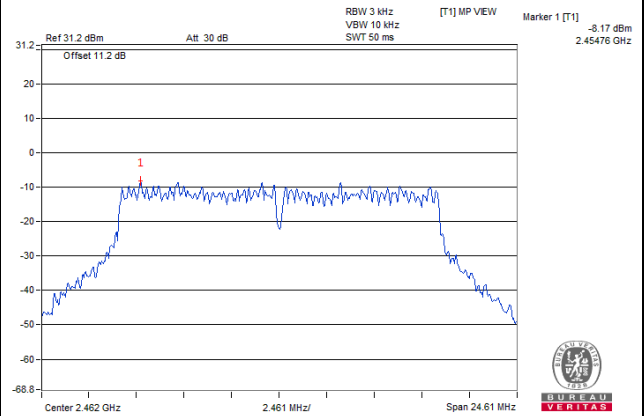

#### 802.11n (HT20)

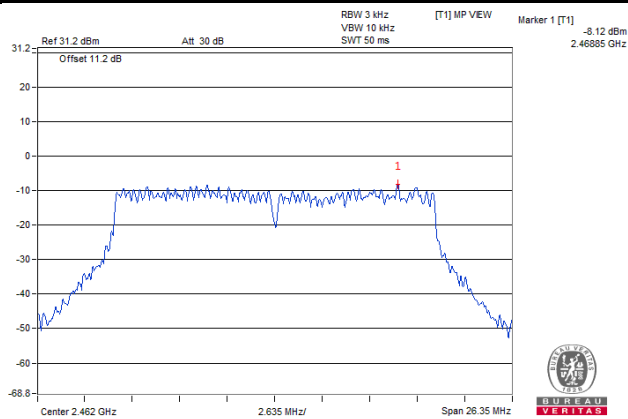

#### 802.11n (HT40)

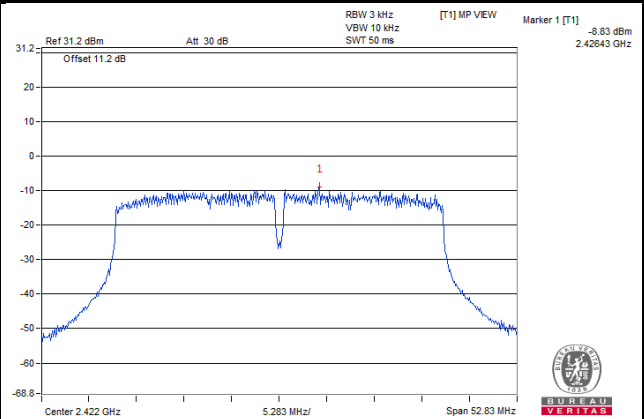

## 4.7 Conducted Out of Band Emission Measurement

### 4.7.1 Limits of Conducted Out of Band Emission Measurement

Below -20 dB of the highest emission level of operating band (in 100 kHz Resolution Bandwidth).

### 4.7.2 Test Setup

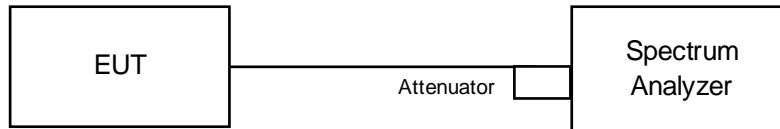

### 4.7.3 Test Instruments

Refer to section 4.1.2 to get information of above instrument.

### 4.7.4 Test Procedure

#### MEASUREMENT PROCEDURE REF

1. Set the RBW = 100 kHz.
2. Set the VBW  $\geq$  300 kHz.
3. Detector = peak.
4. Sweep time = auto couple.
5. Trace mode = max hold.
6. Allow trace to fully stabilize.
7. Use the peak marker function to determine the maximum power level in any 100 kHz band segment within the fundamental EBW.

#### MEASUREMENT PROCEDURE OOB

1. Set RBW = 100 kHz.
2. Set VBW  $\geq$  300 kHz.
3. Detector = peak.
4. Sweep = auto couple.
5. Trace Mode = max hold.
6. Allow trace to fully stabilize.
7. Use the peak marker function to determine the maximum amplitude level.

### 4.7.5 Deviation from Test Standard

No deviation.

### 4.7.6 EUT Operating Condition

The software provided by client to enable the EUT under transmission condition continuously at lowest, middle and highest channel frequencies individually.

### 4.7.7 Test Results

The spectrum plots are attached on the following images. D1 line indicates the highest level, and D2 line indicates the 20 dB offset below D1. It shows compliance with the requirement.

#### 802.11b

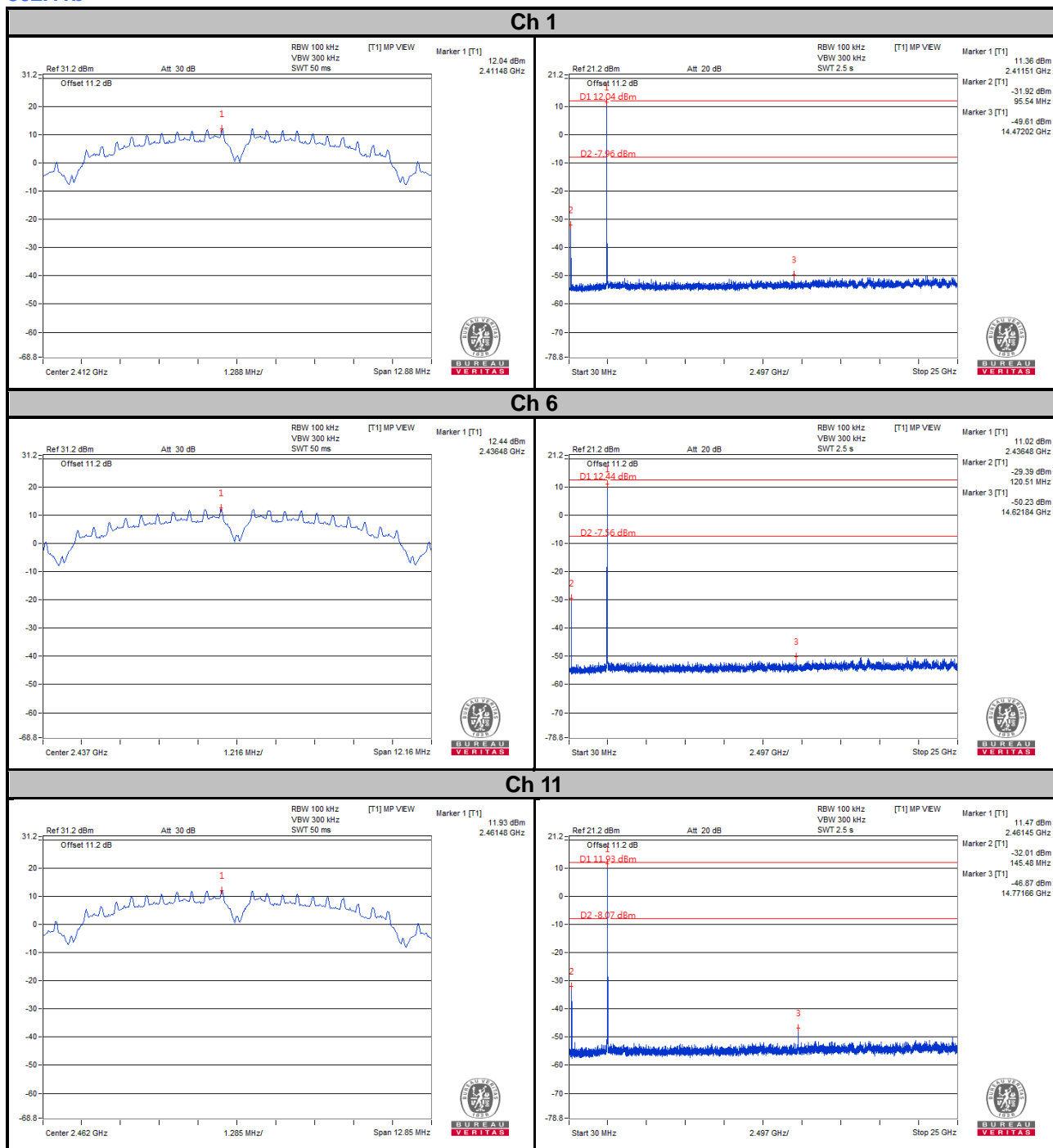

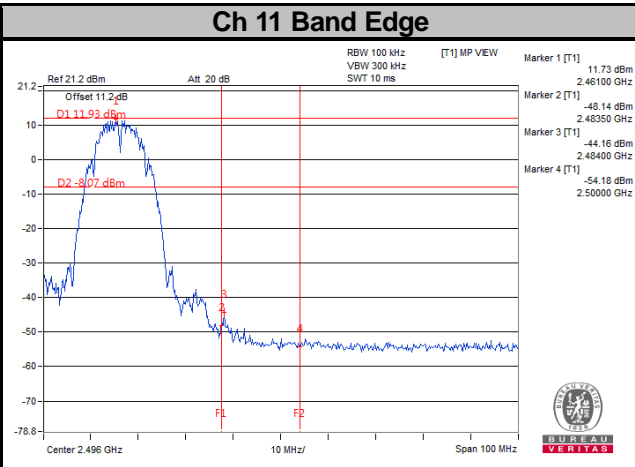
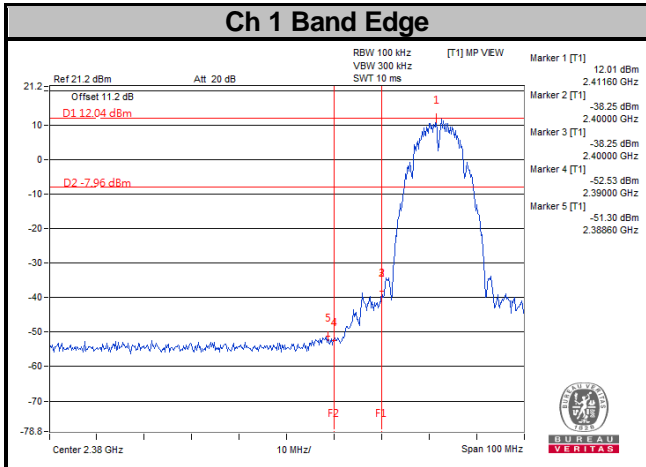

# 802.11g

## Ch 1

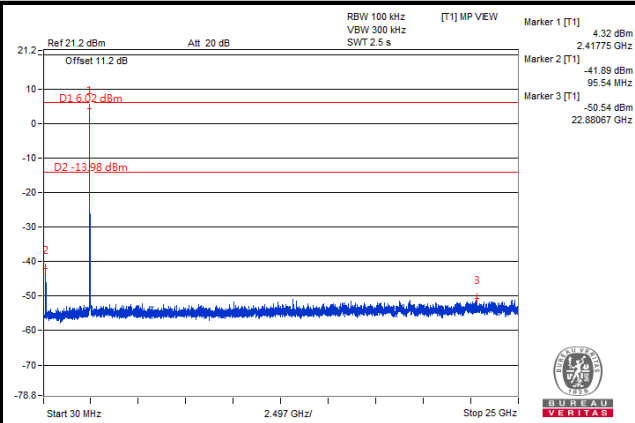
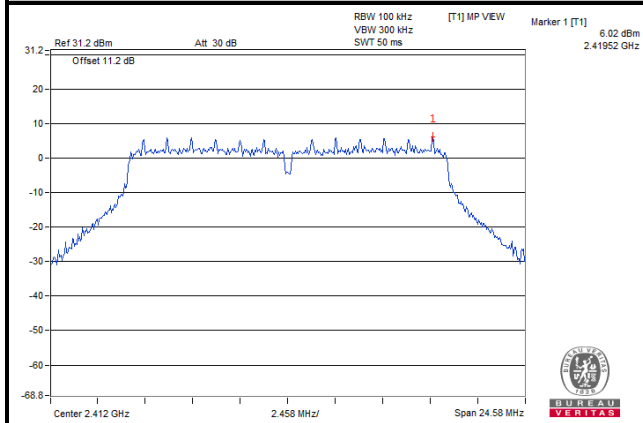

## Ch 6

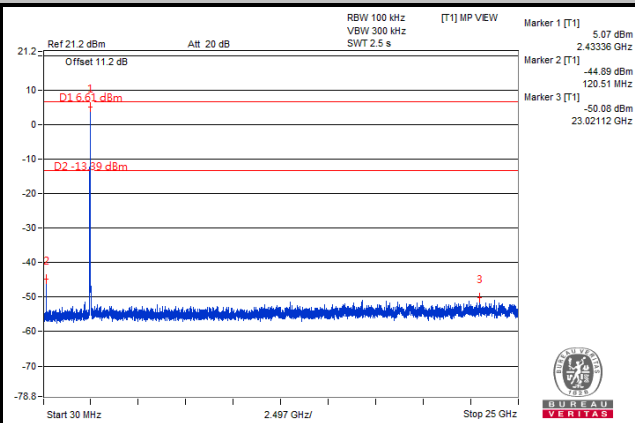
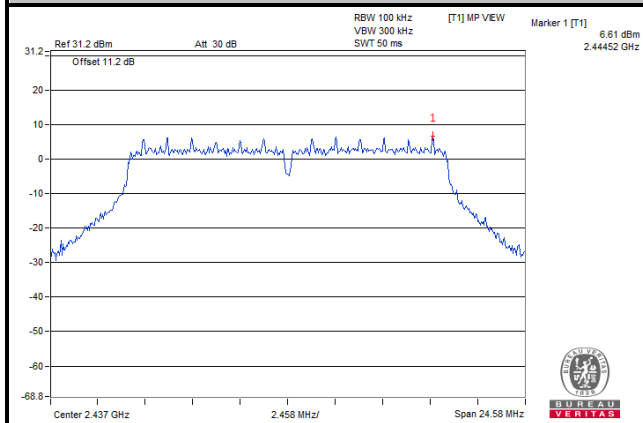

## Ch 11

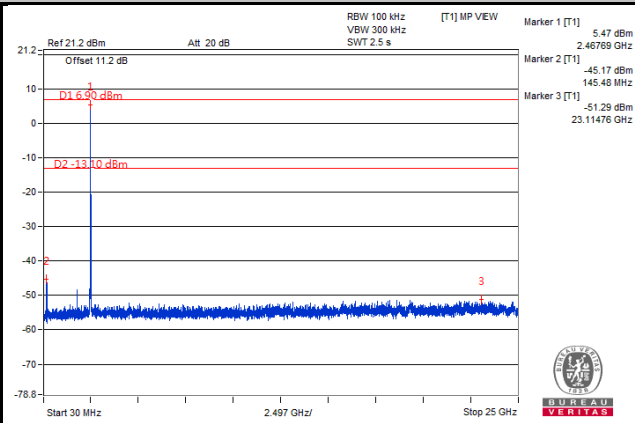
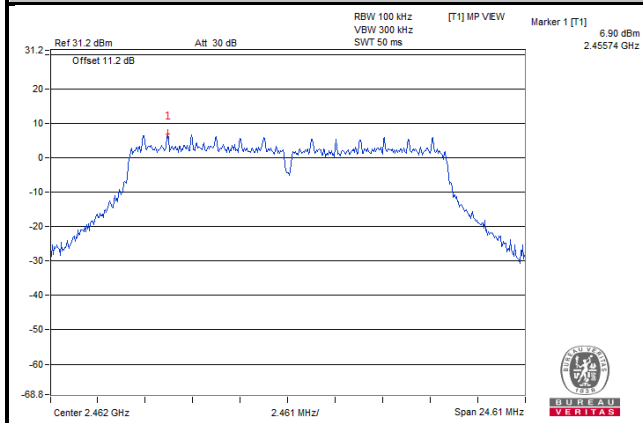

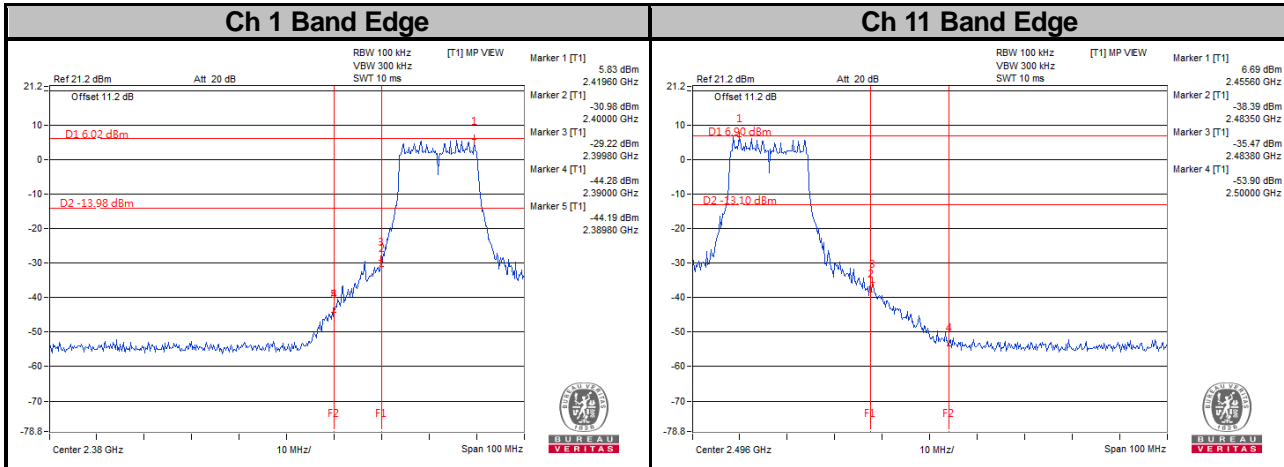



# 802.11n (HT20)

## Ch 1

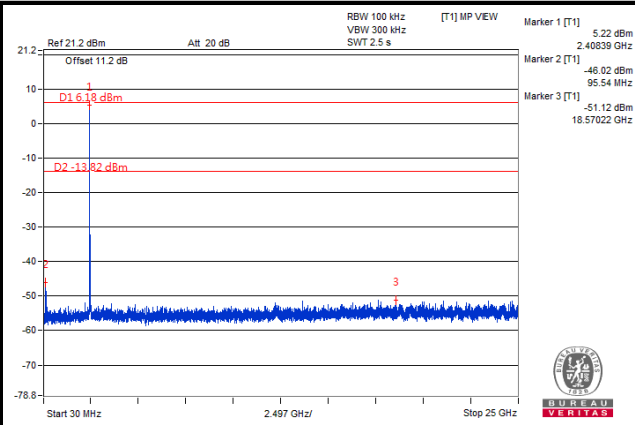
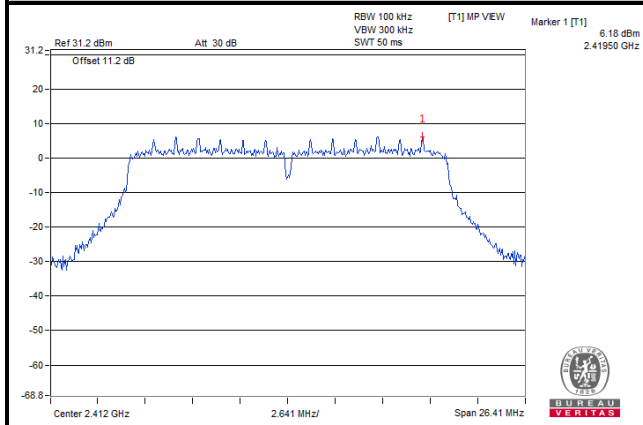

## Ch 6

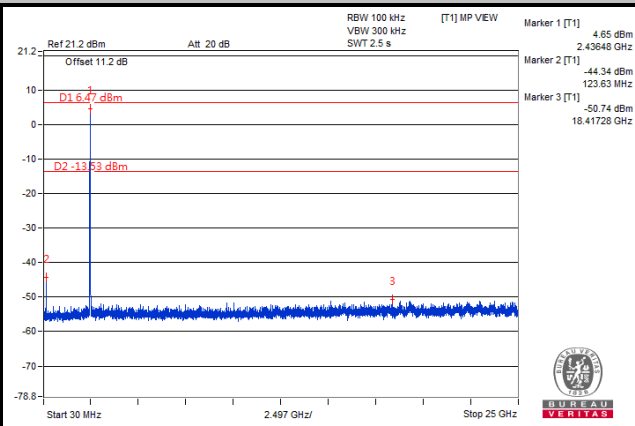
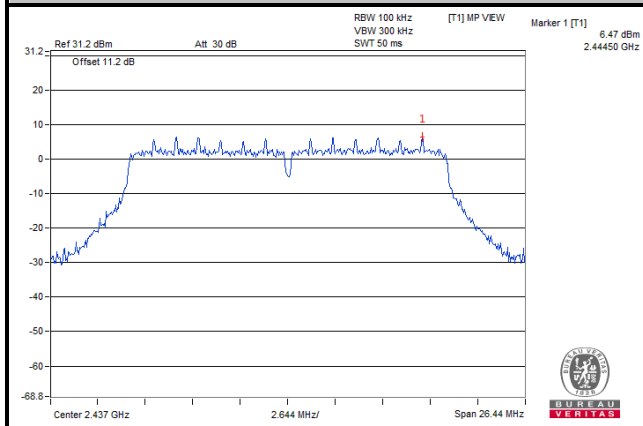

## Ch 11

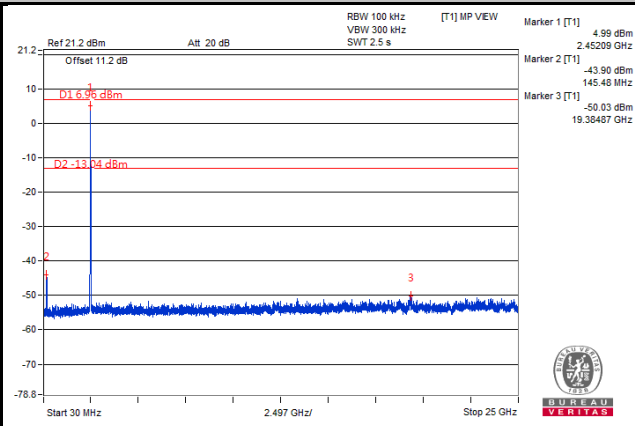
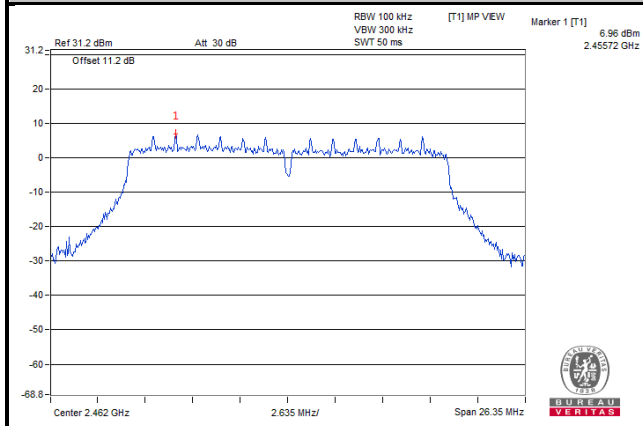

### Ch 1 Band Edge

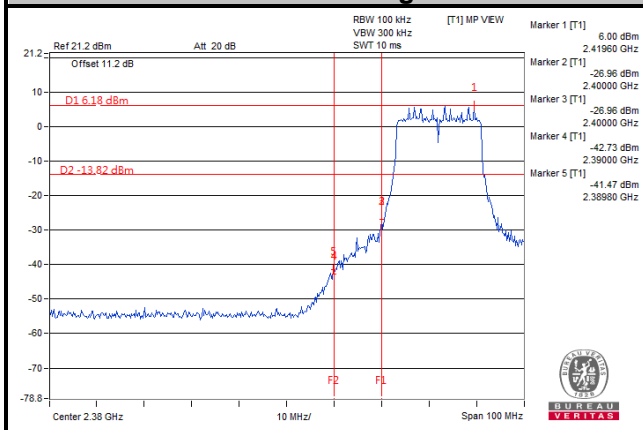

### Ch 11 Band Edge

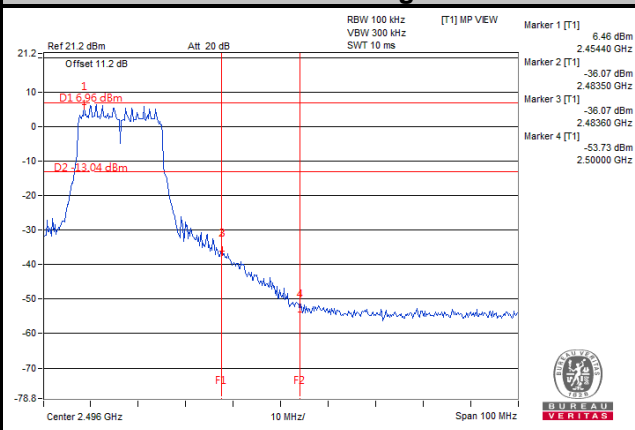

# 802.11n (HT40)

## Ch 3

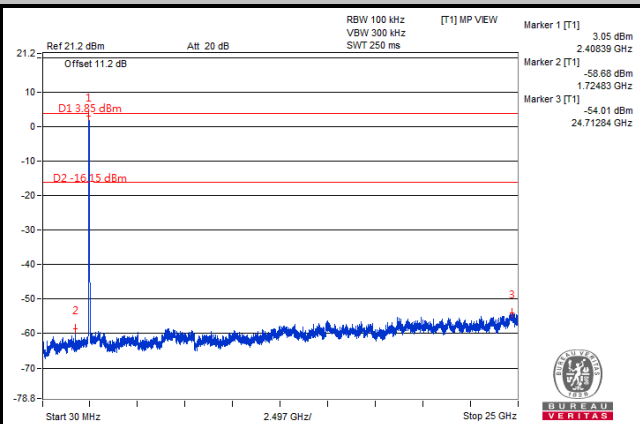
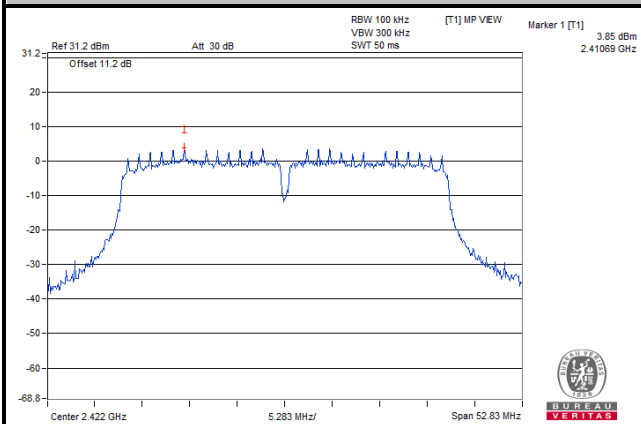

## Ch 6

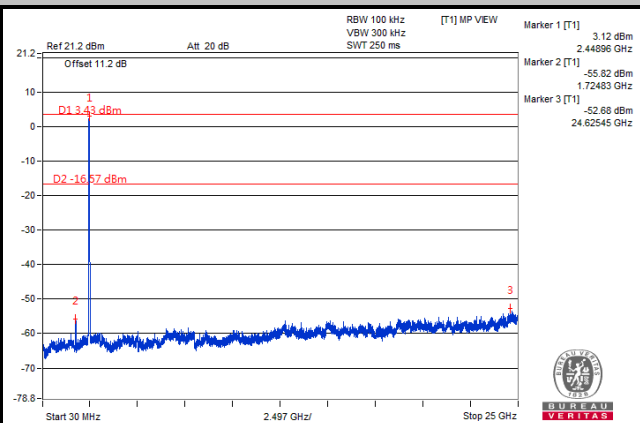
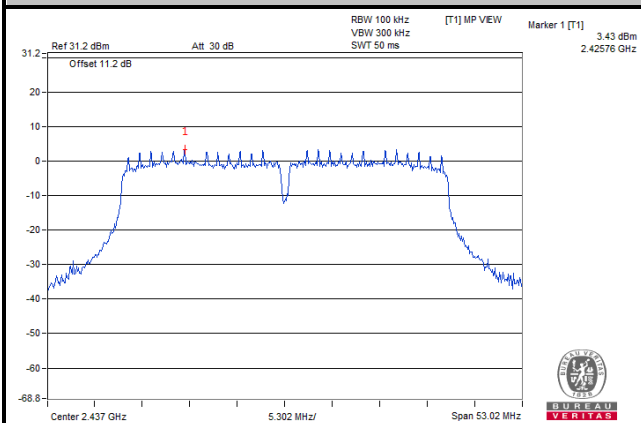

## Ch 9

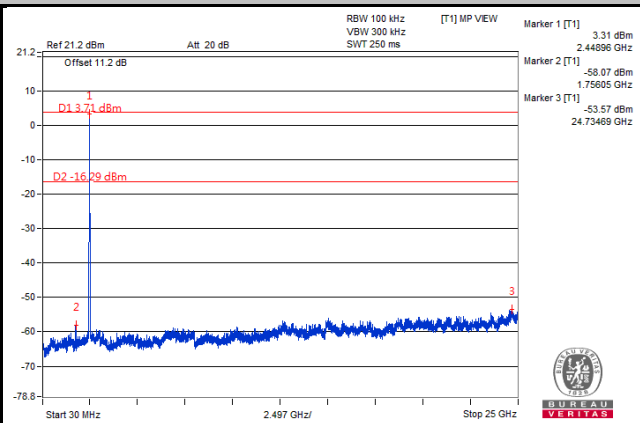
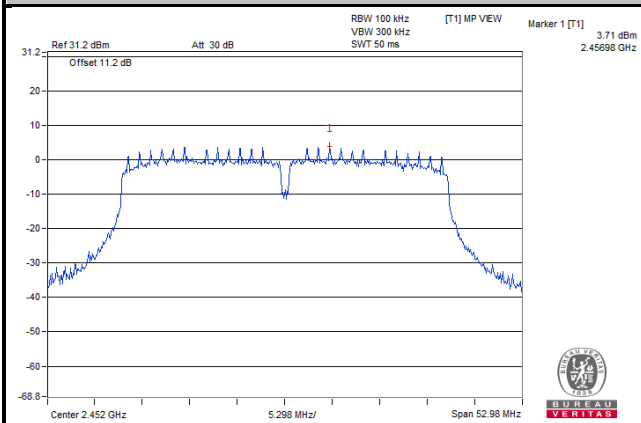

### Ch 3 Band Edge

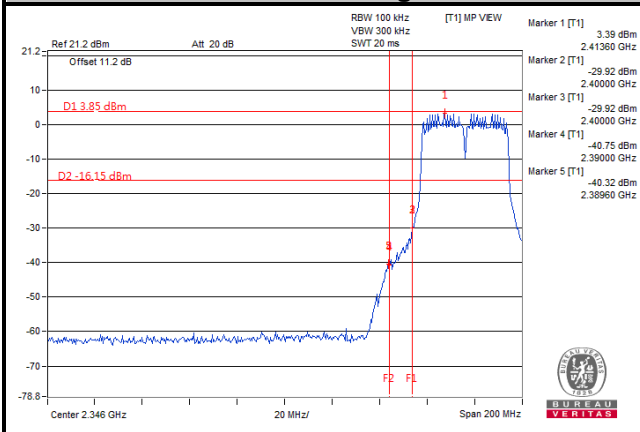

### Ch 9 Band Edge

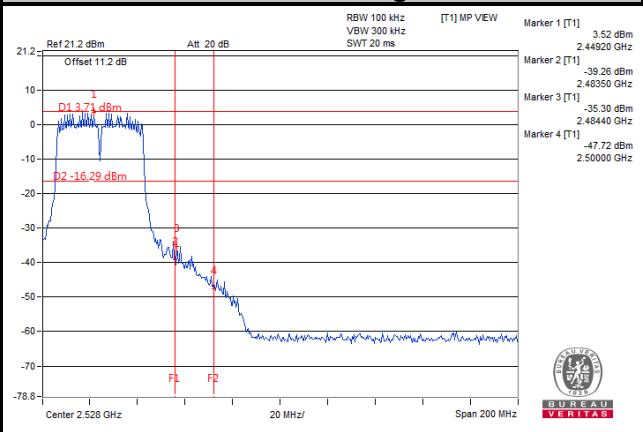

## 5 Pictures of Test Arrangements

Please refer to the attached file (Test Setup Photo).

## Appendix – Information on the Testing Laboratories

We, Bureau Veritas Consumer Products Services (H.K.) Ltd., Taoyuan Branch, were founded in 1988 to provide our best service in EMC, Radio, Telecom and Safety consultation. Our laboratories are FCC recognized accredited test firms and accredited according to ISO/IEC 17025.

If you have any comments, please feel free to contact us at the following:

**Linko EMC/RF Lab**

Tel: 886-2-26052180

Fax: 886-2-26051924

**Hsin Chu EMC/RF/Telecom Lab**

Tel: 886-3-6668565

Fax: 886-3-6668323

**Hwa Ya EMC/RF/Safety Lab**

Tel: 886-3-3183232

Fax: 886-3-3270892

**Email:** [service.adt@tw.bureauveritas.com](mailto:service.adt@tw.bureauveritas.com)

**Web Site:** [www.bureauveritas-adt.com](http://www.bureauveritas-adt.com)

The address and road map of all our labs can be found in our web site also.

--- END ---