



SAR TEST REPORT

No. I17Z40076-SEM02

For

Lenovo PC HK Limited

Portable Tablet Computer

Model Name: Lenovo TB-X304L

With

Hardware Version: Lenovo Tablet TB-X304L

Software Version: TB-X304L_RF01_170209

FCC ID: O57TBX304L

Issued Date: 2017-4-18



Note:

The test results in this test report relate only to the devices specified in this report. This report shall not be reproduced except in full without the written approval of CTTL.

Test Laboratory:

CTTL, Telecommunication Technology Labs, Academy of Telecommunication Research, MIIT
No. 51 Shouxiang Science Building, Xueyuan Road, Haidian District, Beijing, P. R. China100191
Tel:+86(0)10-62304633-2512,Fax:+86(0)10-62304633-2504
Email: ctl_terminals@catr.cn, website:www.chinattl.com



REPORT HISTORY

Report Number	Revision	Issue Date	Description
I17Z40076-SEM02	Rev.0	2017-4-15	Initial creation of test report
I17Z40076-SEM02	Rev.1	2017-4-18	Update the hardware and software on page 1&8
I17Z40076-SEM02	Rev.2	2017-4-18	Add the evaluation of tablet tilt angle influences in annex I on page 160

TABLE OF CONTENT

1 TEST LABORATORY	5
1.1 TESTING LOCATION	5
1.2 TESTING ENVIRONMENT	5
1.3 PROJECT DATA.....	5
1.4 SIGNATURE.....	5
2 STATEMENT OF COMPLIANCE	6
3 CLIENT INFORMATION	7
3.1 APPLICANT INFORMATION	7
3.2 MANUFACTURER INFORMATION	7
4 EQUIPMENT UNDER TEST (EUT) AND ANCILLARY EQUIPMENT (AE)	8
4.1 ABOUT EUT.....	8
4.2 INTERNAL IDENTIFICATION OF EUT USED DURING THE TEST	8
4.3 INTERNAL IDENTIFICATION OF AE USED DURING THE TEST.....	8
5 TEST METHODOLOGY	10
5.1 APPLICABLE LIMIT REGULATIONS	10
5.2 APPLICABLE MEASUREMENT STANDARDS.....	10
6 SPECIFIC ABSORPTION RATE (SAR).....	11
6.1 INTRODUCTION.....	11
6.2 SAR DEFINITION	11
7 TISSUE SIMULATING LIQUIDS	12
7.1 TARGETS FOR TISSUE SIMULATING LIQUID	12
7.2 DIELECTRIC PERFORMANCE	12
8 SYSTEM VERIFICATION	15
8.1 SYSTEM SETUP	15
8.2 SYSTEM VERIFICATION.....	16
9 MEASUREMENT PROCEDURES	17
9.1 TESTS TO BE PERFORMED.....	17
9.2 GENERAL MEASUREMENT PROCEDURE	18
9.3 WCDMA MEASUREMENT PROCEDURES FOR SAR.....	20
9.4 SAR MEASUREMENT FOR LTE	21
9.5 BLUETOOTH & WI-FI MEASUREMENT PROCEDURES FOR SAR	23
9.6 POWER DRIFT	23
10 AREA SCAN BASED 1-G SAR.....	24
10.1 REQUIREMENT OF KDB.....	24
10.2 FAST SAR ALGORITHMS.....	24
11 CONDUCTED OUTPUT POWER	25

11.1 GSM MEASUREMENT RESULT	25
11.2 WCDMA MEASUREMENT RESULT	27
11.3 LTE MEASUREMENT RESULT	29
11.4 WI-FI AND BT MEASUREMENT RESULT	51
12 SIMULTANEOUS TX SAR CONSIDERATIONS	53
12.1 INTRODUCTION	53
12.2 TRANSMIT ANTENNA SEPARATION DISTANCES	53
12.3 SAR MEASUREMENT POSITIONS	53
12.4 STANDALONE SAR TEST EXCLUSION CONSIDERATIONS	54
13 EVALUATION OF SIMULTANEOUS	55
14 SAR TEST RESULT	56
14.1 SAR RESULTS FOR FAST SAR	56
14.2 SAR RESULTS FOR STANDARD PROCEDURE	62
15 SAR MEASUREMENT VARIABILITY	64
16 MEASUREMENT UNCERTAINTY	66
16.1 MEASUREMENT UNCERTAINTY FOR NORMAL SAR TESTS (300MHZ~3GHZ)	66
16.2 MEASUREMENT UNCERTAINTY FOR NORMAL SAR TESTS (3~6GHZ).....	67
16.3 MEASUREMENT UNCERTAINTY FOR FAST SAR TESTS (300MHZ~3GHZ).....	68
16.4 MEASUREMENT UNCERTAINTY FOR FAST SAR TESTS (3~6GHZ).....	69
17 MAIN TEST INSTRUMENTS	70
ANNEX A GRAPH RESULTS	71
ANNEX B SYSTEM VERIFICATION RESULTS	91
ANNEX C SAR MEASUREMENT SETUP	97
ANNEX D POSITION OF THE WIRELESS DEVICE IN RELATION TO THE PHANTOM	103
ANNEX E EQUIVALENT MEDIA RECIPES	104
ANNEX F SYSTEM VALIDATION	105
ANNEX G PROBE CALIBRATION CERTIFICATE	106
ANNEX H DIPOLE CALIBRATION CERTIFICATE	117
ANNEX I SENSOR TRIGGERING DATA SUMMARY	157
ANNEX J ACCREDITATION CERTIFICATE	161

1 Test Laboratory

1.1 Testing Location

Company Name:	CTTL(Shouxiang)
Address:	No. 51 Shouxiang Science Building, Xueyuan Road, Haidian District, Beijing, P. R. China100191

1.2 Testing Environment

Temperature:	18°C~25°C,
Relative humidity:	30%~ 70%
Ground system resistance:	< 0.5 Ω
Ambient noise & Reflection:	< 0.012 W/kg

1.3 Project Data

Project Leader:	Qi Dianyuan
Test Engineer:	Lin Xiaojun
Testing Start Date:	March 20, 2017
Testing End Date:	March 24, 2017

1.4 Signature



Lin Xiaojun
(Prepared this test report)

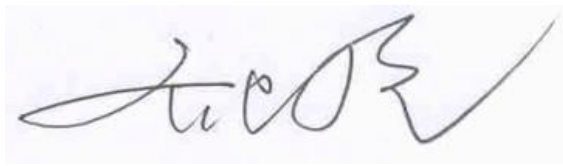

Qi Dianyuan
(Reviewed this test report)

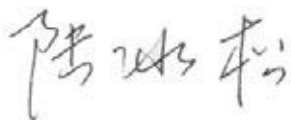

Lu Bingsong
Deputy Director of the laboratory
(Approved this test report)

2 Statement of Compliance

The maximum results of SAR found during testing for Lenovo PC HK Limited Portable Tablet Computer Lenovo TB-X304L are as follows:

Table 2.1: Highest Reported SAR (1g)

Exposure Configuration	Technology Band	Highest Reported SAR 1g(W/kg)	Equipment Class
Body SAR	GSM 850	0.78	PCE
	PCS 1900	1.06	
	WCDMA 850	0.73	
	WCDMA 1900	1.11	
	LTE Band 2	1.02	
	LTE Band 4	1.28	
	LTE Band 5	0.91	
	LTE Band 7	0.85	
	LTE Band 38	1.10	
	WLAN 2.4 GHz	0.31	DTS

The SAR values found for the Mobile Phone are below the maximum recommended levels of 1.6 W/Kg as averaged over any 1g tissue according to the ANSI C95.1-1992.

For body worn operation, this device has been tested and meets FCC RF exposure guidelines when used with any accessory that contains no metal and which provides a minimum separation distance of 0 mm and 13mm between this device and the body of the user. Use of other accessories may not ensure compliance with FCC RF exposure guidelines.

The EUT battery must be fully charged and checked periodically during the test to ascertain uniform power output.

The measurement together with the test system set-up is described in annex C of this test report. A detailed description of the equipment under test can be found in chapter 4 of this test report. The highest reported SAR value is obtained at the case of **(Table 2.1)**, and the values are: **1.28 W/kg(1g)**.

Table 2.2: The sum of reported SAR values for main antenna and WiFi

	Position	Main antenna	WiFi	Sum
Highest reported SAR value for Body	Rear 0mm	1.10	0.31	1.41
	Rear 13mm	1.28	0.03	1.31

Table 2.3: The sum of reported SAR values for main antenna and BT

	Position	Main antenna	BT	Sum
Maximum reported SAR value for Body	Rear 0mm	1.10	0.21 ^[1]	1.31
	Rear 13mm	1.28	0.08 ^[1]	1.36

[1] - Estimated SAR for Bluetooth (see the table 13.3)

According to the above tables, the highest sum of reported SAR values is **1.41 W/kg (1g)**. The detail for simultaneous transmission consideration is described in chapter 13.

3 Client Information

3.1 Applicant Information

Company Name:	Lenovo(Shanghai) Electronics Technology Co., Ltd.
Address /Post:	NO.68 BUILDING, 199 FENJU RD, Pilot Free Trade Zone, 200131, China
Contact:	Svan Liu
Email:	liujl11@lenovo.com
Telephone:	+86-21-50504500-8281
Fax:	+86-21-50807240

3.2 Manufacturer Information

Company Name:	Lenovo PC HK Limited
Address /Post:	23/F, Lincoln House, Taikoo Place 979 King's Road, Quarry Bay, Hong Kong
Contact:	Joanna Yu
Email:	yujia8@lenovo.com
Telephone:	+86-21-50504500-8281
Fax:	+86-21-50807240

4 Equipment Under Test (EUT) and Ancillary Equipment (AE)

4.1 About EUT

Description:	Portable Tablet Computer
Model name:	Lenovo TB-X304L
Operating mode(s):	GSM 850/900/1800/1900, UMTS FDD 1/2/5/8, BT, Wi-Fi2.4G LTE Band 1/2/3/4/5/7/8/20/38/40
Tested Tx Frequency:	825 – 848.8 MHz (GSM 850)
	1850.2 – 1910 MHz (GSM 1900)
	826.4–846.6 MHz (WCDMA 850 Band V)
	1852.4–1907.6 MHz (WCDMA1900 Band II)
	1860 – 1900 MHz (LTE Band 2)
	1720 – 1745 MHz (LTE Band 4)
	824.7 – 848.3 MHz (LTE Band 5)
	2502.5 – 2567.5 MHz (LTE Band 7)
	2570 – 2620 MHz (LTE Band 38)
2412 – 2462 MHz (Wi-Fi 2.4G)	
GPRS/EGPRS Multislot Class:	12
GPRS capability Class:	B
Test device Production information:	Production unit
Device type:	Portable device
Antenna type:	Integrated antenna

4.2 Internal Identification of EUT used during the test

EUT ID*	SN	HW Version	SW Version
EUT1	D7021603383	Lenovo Tablet TB-X304L	TB-X304L_RF01_170209
EUT2	D7021603323	Lenovo Tablet TB-X304L	TB-X304L_RF01_170209
EUT3	D7021603379	Lenovo Tablet TB-X304L	TB-X304L_RF01_170209
EUT4	D7021603291	Lenovo Tablet TB-X304L	TB-X304L_RF01_170209
EUT5	D7021603432	Lenovo Tablet TB-X304L	TB-X304L_RF01_170209

*EUT ID: is used to identify the test sample in the lab internally.

Note: It is performed to test SAR with the EUT1&2&3&4 and conducted power with the EUT5.

4.3 Internal Identification of AE used during the test

AE ID*	Description	Model	SN	Manufacturer
AE1	Battery	L16D2P31	/	SCUD(Fujian) Electronics Co., Ltd.
AE2	Battery	L16D2P31	/	Celxpert+coslight

*AE ID: is used to identify the test sample in the lab internally.



There are Two kinds of combination modes to be tested and the detail information is as follows:

SKU9			SKU14		
Material description	Model	Supplier	Material description	Model	Supplier
PCB	A6000A_MB_V4_P CBA	RED BOARD LTD	PCB	A6000A_MB_V4_PCBA	HUAXIN
LPDDR3 Emcp	KMQE10013M-B31 8	2+16 Samsung	LPDDR3 Emcp	H9TQ26ADFTBCUR-K UM	3+32 Hynix
Motor	HZF-Z04B-RL10B2 0-90	HONGZHIFA	Motor	CY0408L-021HB-015	KUNWAN G
Battery	16D2P31	SCUD(FUJIA N)	Battery	16D2P31	Celxpert
speakerBox 1	HQZA6000AJA_08	KEYSOUND	speakerBox 1	XHB171218B08-01-B-R H	HAOSHE NG
speakerBox 2	HQZA6000AJA_09	KEYSOUND	speakerBox 2	XHB171218B08-02-B1 F-RH	HAOSHE NG
LCM	P101DCA-AB0	Innolux	LCM	TV101WXM-NL1-39P0	BOE
Camera_Ba ck	F5695AV	Q-tech	Camera_Ba ck	F5V08B	Sunny
Camera_Fr ont	K7P2-A6000FHQ	Kingcom	Camera_Fr ont	BLX2375H-A6000-F	BO LI XIN

We'll perform the SAR measurement with SKU9 and retest on highest value point with SKU14.

5 TEST METHODOLOGY

5.1 Applicable Limit Regulations

ANSI C95.1–1992:IEEE Standard for Safety Levels with Respect to Human Exposure to Radio Frequency Electromagnetic Fields, 3 kHz to 300 GHz.

It specifies the maximum exposure limit of **1.6 W/kg** as averaged over any 1 gram of tissue for portable devices being used within 20 cm of the user in the uncontrolled environment.

5.2 Applicable Measurement Standards

IEEE 1528–2013: Recommended Practice for Determining the Peak Spatial-Average Specific Absorption Rate (SAR) in the Human Head from Wireless Communications Devices: Measurement Techniques.

KDB447498 D01: General RF Exposure Guidance v06: Mobile and Portable Devices RF Exposure Procedures and Equipment Authorization Policies.

KDB941225 D01 SAR test for 3G devices v03r01: SAR Measurement Procedures for 3G Devices

KDB941225 D05 SAR for LTE Devices v02r05: SAR Evaluation Considerations for LTE Devices

KDB941225 D06 Hotspot Mode SAR v02r01: SAR Evaluation Procedures for Portable Devices with Wireless Router Capabilities

KDB248227 D01 802.11 Wi-Fi SAR v02r02: SAR GUIDANCE FOR IEEE 802.11 (Wi-Fi) TRANSMITTERS

KDB616217 D04 SAR for laptop and tablets v01r02 SAR Evaluation Considerations for Laptop, Notebook, Notebook and Tablet Computers.

KDB865664 D01 SAR measurement 100 MHz to 6 GHz v01r04: SAR Measurement Requirements for 100 MHz to 6 GHz.

KDB865664 D02RF Exposure Reporting v01r02: RF Exposure Compliance Reporting and Documentation Considerations

6 Specific Absorption Rate (SAR)

6.1 Introduction

SAR is related to the rate at which energy is absorbed per unit mass in an object exposed to a radio field. The SAR distribution in a biological body is complicated and is usually carried out by experimental techniques or numerical modeling. The standard recommends limits for two tiers of groups, occupational/controlled and general population/uncontrolled, based on a person's awareness and ability to exercise control over his or her exposure. In general, occupational/controlled exposure limits are higher than the limits for general population/uncontrolled.

6.2 SAR Definition

The SAR definition is the time derivative (rate) of the incremental energy (dW) absorbed by (dissipated in) an incremental mass (dm) contained in a volume element (dv) of a given density (ρ). The equation description is as below:

$$SAR = \frac{d}{dt} \left(\frac{dW}{dm} \right) = \frac{d}{dt} \left(\frac{dW}{\rho dv} \right)$$

SAR is expressed in units of Watts per kilogram (W/kg)

SAR measurement can be either related to the temperature elevation in tissue by

$$SAR = c \left(\frac{\delta T}{\delta t} \right)$$

Where: C is the specific heat capacity, δT is the temperature rise and δt is the exposure duration, or related to the electrical field in the tissue by

$$SAR = \frac{\sigma |E|^2}{\rho}$$

Where: σ is the conductivity of the tissue, ρ is the mass density of tissue and E is the RMS electrical field strength.

However for evaluating SAR of low power transmitter, electrical field measurement is typically applied.

7 Tissue Simulating Liquids

7.1 Targets for tissue simulating liquid

Table 7.1: Targets for tissue simulating liquid

Frequency(MHz)	Liquid Type	Conductivity(σ)	$\pm 5\%$ Range	Permittivity(ϵ)	$\pm 5\%$ Range
835	Head	0.90	0.86~0.95	41.5	39.4~43.6
835	Body	0.97	0.92~1.02	55.2	52.4~58.0
1750	Head	1.37	1.30~1.44	40.08	38.1~42.1
1750	Body	1.49	1.42~1.56	53.4	50.7~56.1
1900	Head	1.40	1.33~1.47	40.0	38.0~42.0
1900	Body	1.52	1.44~1.60	53.3	50.6~56.0
2450	Head	1.80	1.71~1.89	39.2	37.2~41.2
2450	Body	1.95	1.85~2.05	52.7	50.1~55.3
2600	Head	1.96	1.86~2.06	39.01	37.1~41.0
2600	Body	2.16	2.05~2.27	52.5	49.9~55.1

7.2 Dielectric Performance

Table 7.2: Dielectric Performance of Tissue Simulating Liquid

Measurement Date (yyyy-mm-dd)	Type	Frequency	Permittivity ϵ	Drift (%)	Conductivity σ (S/m)	Drift (%)
2017-3-20	Body	835 MHz	55.91	1.29	0.991	2.16
2017-3-21	Body	1750 MHz	54.12	1.35	1.516	1.74
2017-3-22	Body	1900 MHz	52.41	-1.67	1.527	0.46
2017-3-23	Body	2450 MHz	51.79	-1.73	1.987	1.90
2017-3-24	Body	2600 MHz	52.11	-0.74	2.171	0.51

Note: The liquid temperature is 22.0°C



Picture 7-1 Liquid depth in the Flat Phantom (835 MHz)

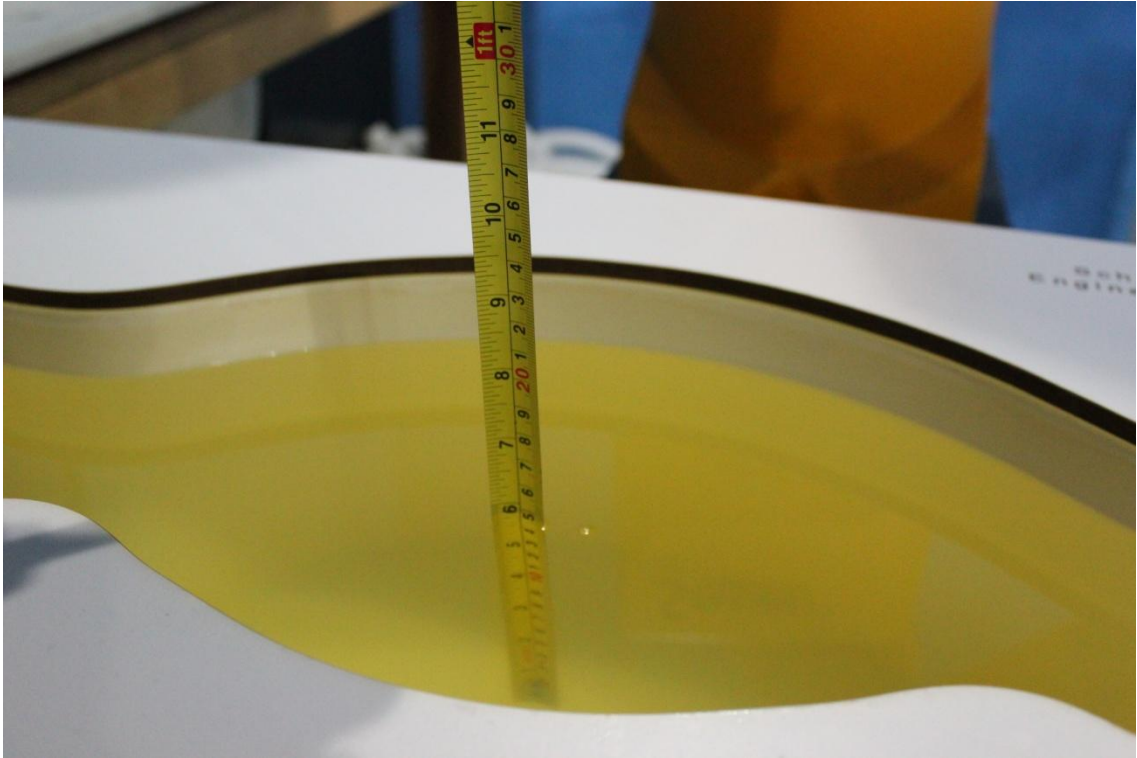

Picture 7-2 Liquid depth in the Flat Phantom (1750MHz)



Picture 7-3 Liquid depth in the Flat Phantom (1900MHz)

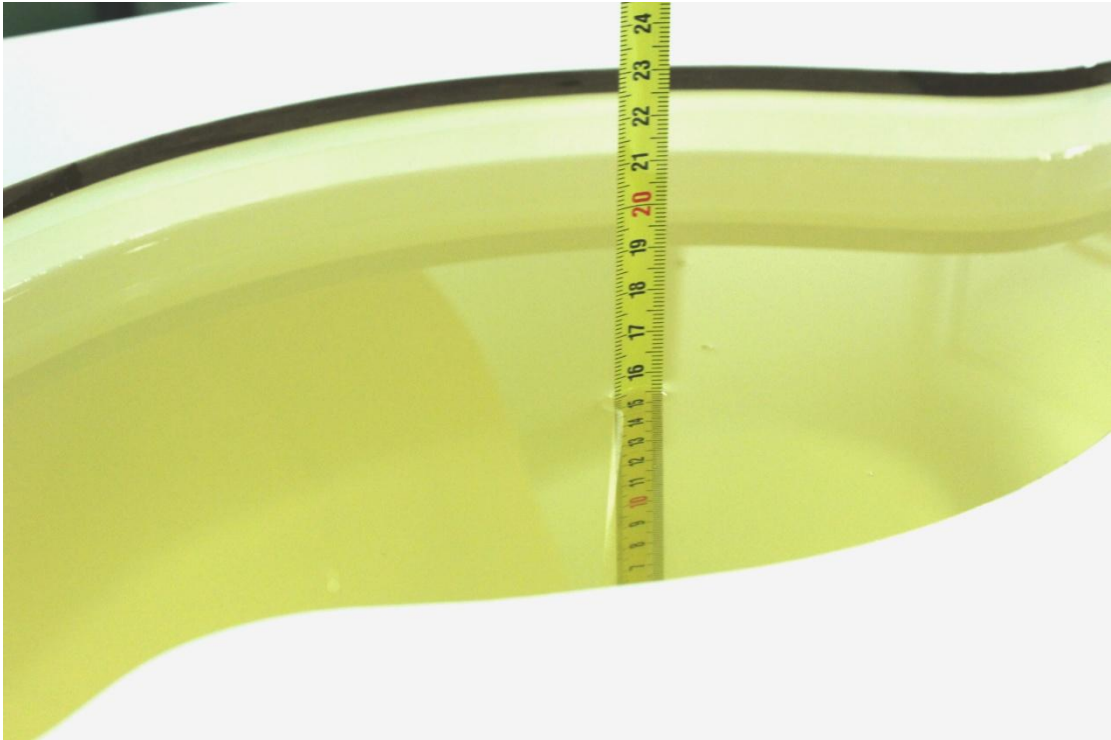

Picture 7-4 Liquid depth in the Flat Phantom (2450MHz)

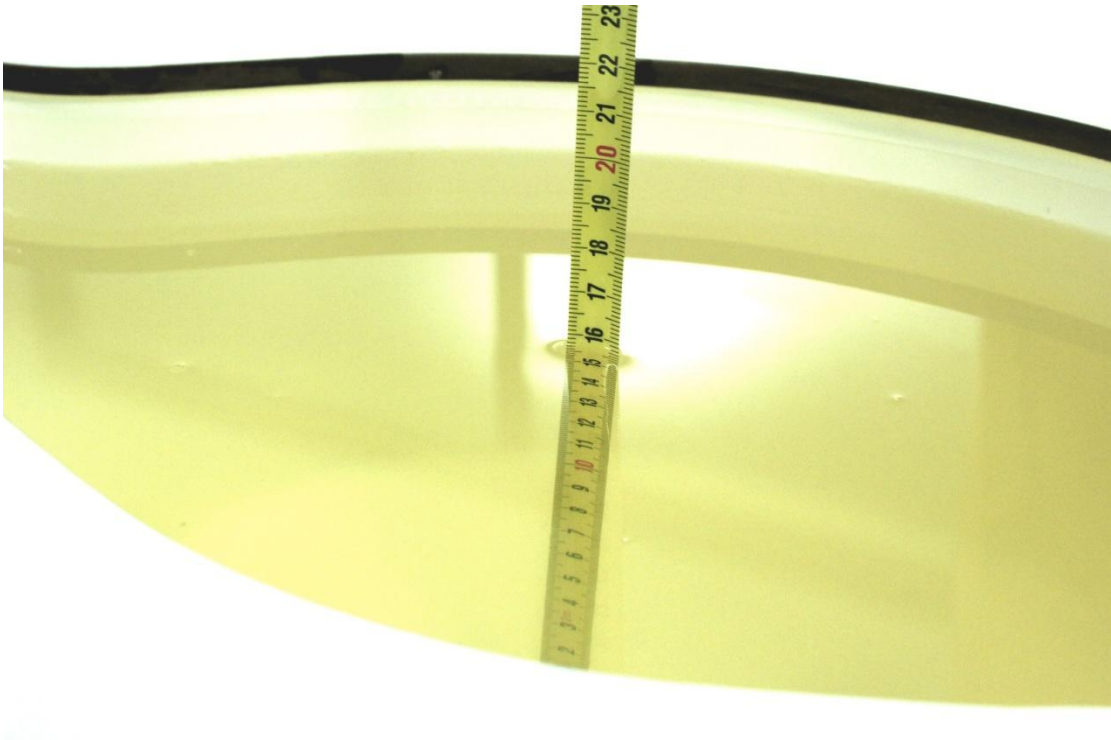

Picture 7-5 Liquid depth in the Flat Phantom (2600MHz)

8 System verification

8.1 System Setup

In the simplified setup for system evaluation, the DUT is replaced by a calibrated dipole and the power source is replaced by a continuous wave that comes from a signal generator. The calibrated dipole must be placed beneath the flat phantom section of the SAM twin phantom with the correct distance holder. The distance holder should touch the phantom surface with a light pressure at the reference marking and be oriented parallel to the long side of the phantom. The equipment setup is shown below:

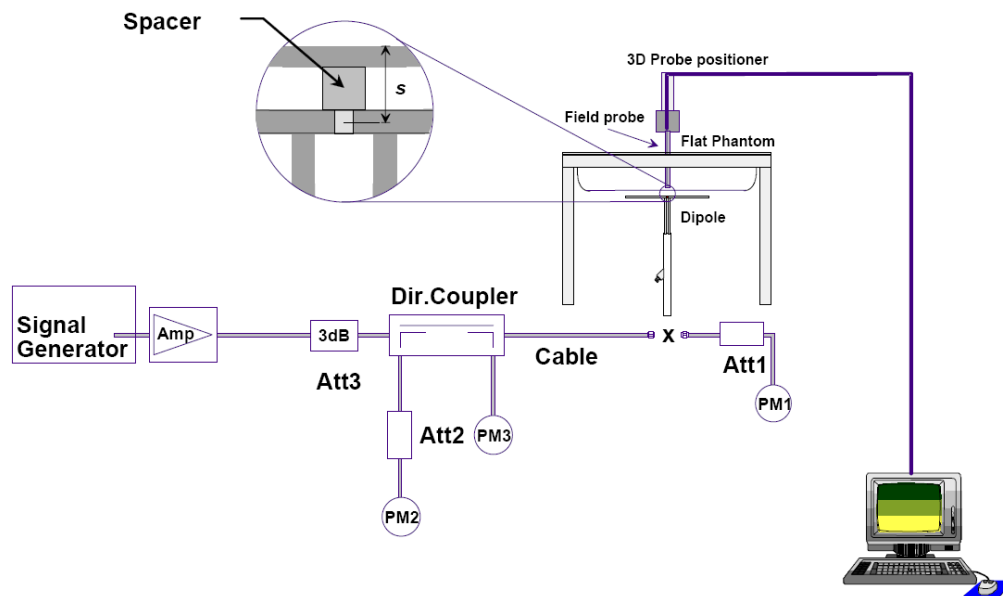

Picture 8.1 System Setup for System Evaluation



Picture 8.2 Photo of Dipole Setup

8.2 System Verification

SAR system verification is required to confirm measurement accuracy, according to the tissue dielectric media, probe calibration points and other system operating parameters required for measuring the SAR of a test device. The system verification must be performed for each frequency band and within the valid range of each probe calibration point required for testing the device.

The system verification results are required that the area scan estimated 1-g SAR is within 3% of the zoom scan 1-g SAR. The details are presented in annex B.

Table 8.1: System Verification of Body

Measurement Date (yyyy-mm-dd)	Frequency	Target value (W/kg)		Measured value (W/kg)		Deviation	
		10 g Average	1 g Average	10 g Average	1 g Average	10 g Average	1 g Average
2017-3-20	835 MHz	6.36	9.69	6.24	9.52	-1.89%	-1.75%
2017-3-21	1750 MHz	19.6	37.0	19.92	37.64	1.63%	1.73%
2017-3-22	1900 MHz	21.3	40.1	21.44	40.80	0.66%	1.75%
2017-3-23	2450 MHz	24.1	51.2	24.64	52.40	2.24%	2.34%
2017-3-24	2600 MHz	24.8	55.3	25.36	57.20	2.26%	3.44%

9 Measurement Procedures

9.1 Tests to be performed

In order to determine the highest value of the peak spatial-average SAR of a handset, all device positions, configurations and operational modes shall be tested for each frequency band according to steps 1 to 3 below. A flowchart of the test process is shown in picture 9.1.

Step 1: The tests described in 9.2 shall be performed at the channel that is closest to the centre of the transmit frequency band (f_c) for:

- a) all device positions (cheek and tilt, for both left and right sides of the SAM phantom, as described in annex D),
- b) all configurations for each device position in a), e.g., antenna extended and retracted, and
- c) all operational modes, e.g., analogue and digital, for each device position in a) and configuration in b) in each frequency band.

If more than three frequencies need to be tested according to 11.1 (i.e., $N_c > 3$), then all frequencies, configurations and modes shall be tested for all of the above test conditions.

Step 2: For the condition providing highest peak spatial-average SAR determined in Step 1, perform all tests described in 9.2 at all other test frequencies, i.e., lowest and highest frequencies. In addition, for all other conditions (device position, configuration and operational mode) where the peak spatial-average SAR value determined in Step 1 is within 3 dB of the applicable SAR limit, it is recommended that all other test frequencies shall be tested as well.

Step 3: Examine all data to determine the highest value of the peak spatial-average SAR found in Steps 1 to 2.

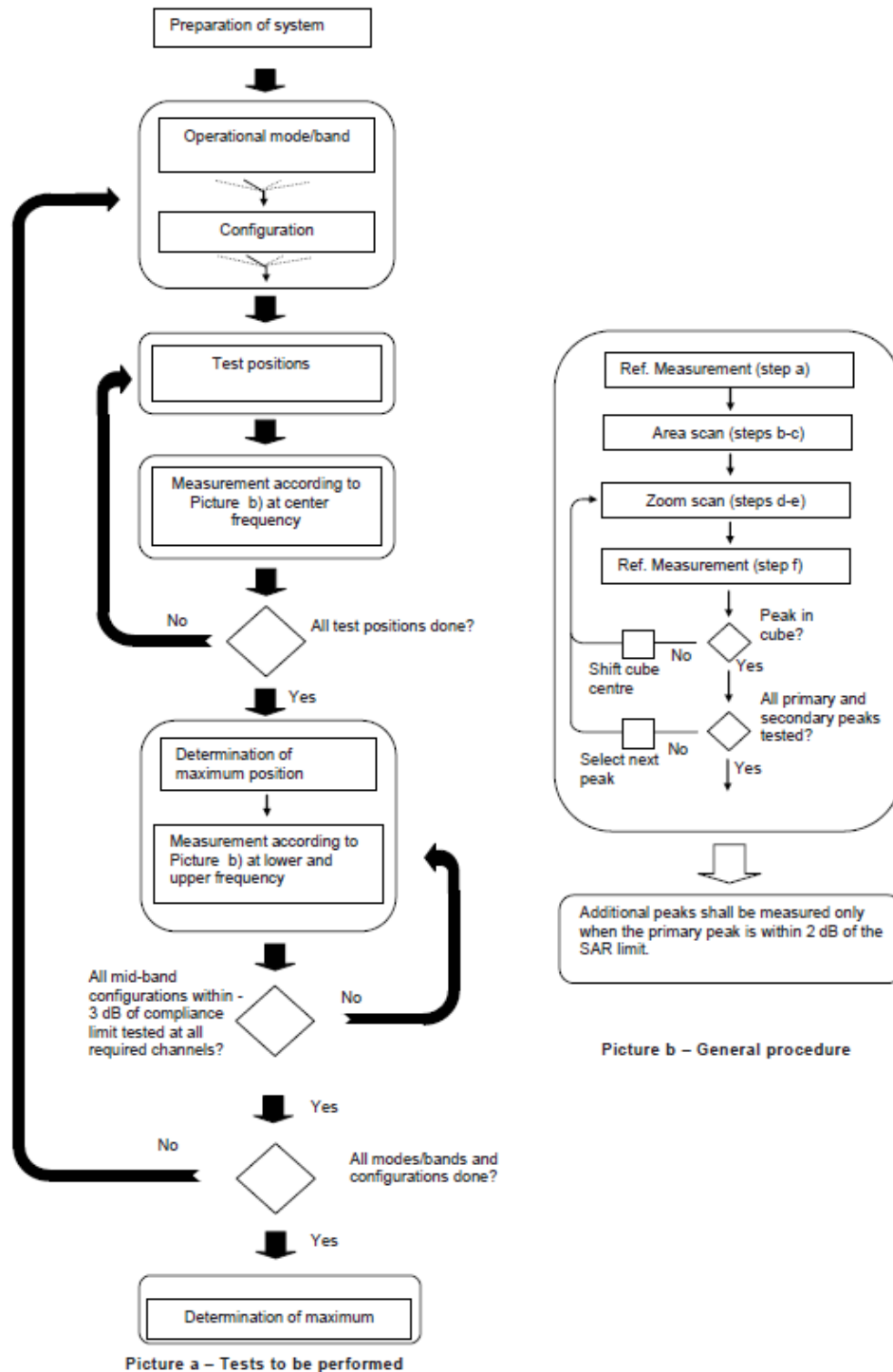

Picture 9.1 Block diagram of the tests to be performed

9.2 General Measurement Procedure

The area and zoom scan resolutions specified in the table below must be applied to the SAR measurements and fully documented in SAR reports to qualify for TCB approval. Probe boundary effect error compensation is required for measurements with the probe tip closer than half a probe tip diameter to the phantom surface. Both the probe tip diameter and sensor offset distance must satisfy measurement protocols; to ensure probe boundary effect errors are minimized and the

higher fields closest to the phantom surface can be correctly measured and extrapolated to the phantom surface for computing 1-g SAR. Tolerances of the post-processing algorithms must be verified by the test laboratory for the scan resolutions used in the SAR measurements, according to the reference distribution functions specified in IEEE Std 1528-2003. The results should be documented as part of the system validation records and may be requested to support test results when all the measurement parameters in the following table are not satisfied.

		≤ 3 GHz	> 3 GHz	
Maximum distance from closest measurement point (geometric center of probe sensors) to phantom surface		5 ± 1 mm	$\frac{1}{2} \delta \ln(2) \pm 0.5$ mm	
Maximum probe angle from probe axis to phantom surface normal at the measurement location		$30^\circ \pm 1^\circ$	$20^\circ \pm 1^\circ$	
Maximum area scan spatial resolution: Δx_{Area} , Δy_{Area}		≤ 2 GHz: ≤ 15 mm 2 – 3 GHz: ≤ 12 mm	3 – 4 GHz: ≤ 12 mm 4 – 6 GHz: ≤ 10 mm	
		When the x or y dimension of the test device, in the measurement plane orientation, is smaller than the above, the measurement resolution must be \leq the corresponding x or y dimension of the test device with at least one measurement point on the test device.		
Maximum zoom scan spatial resolution: Δx_{Zoom} , Δy_{Zoom}		≤ 2 GHz: ≤ 8 mm 2 – 3 GHz: ≤ 5 mm*	3 – 4 GHz: ≤ 5 mm* 4 – 6 GHz: ≤ 4 mm*	
Maximum zoom scan spatial resolution, normal to phantom surface	uniform grid: $\Delta z_{Zoom}(n)$	≤ 5 mm	3 – 4 GHz: ≤ 4 mm 4 – 5 GHz: ≤ 3 mm 5 – 6 GHz: ≤ 2 mm	
	graded grid	$\Delta z_{Zoom}(1)$: between 1 st two points closest to phantom surface	≤ 4 mm	3 – 4 GHz: ≤ 3 mm 4 – 5 GHz: ≤ 2.5 mm 5 – 6 GHz: ≤ 2 mm
		$\Delta z_{Zoom}(n>1)$: between subsequent points	$\leq 1.5 \cdot \Delta z_{Zoom}(n-1)$	
Minimum zoom scan volume	x, y, z	≥ 30 mm	3 – 4 GHz: ≥ 28 mm 4 – 5 GHz: ≥ 25 mm 5 – 6 GHz: ≥ 22 mm	
<p>Note: δ is the penetration depth of a plane-wave at normal incidence to the tissue medium; see draft standard IEEE P1528-2011 for details.</p> <p>* When zoom scan is required and the <i>reported</i> SAR from the area scan based 1-g SAR estimation procedures of KDB 447498 is ≤ 1.4 W/kg, ≤ 8 mm, ≤ 7 mm and ≤ 5 mm zoom scan resolution may be applied, respectively, for 2 GHz to 3 GHz, 3 GHz to 4 GHz and 4 GHz to 6 GHz.</p>				

9.3 WCDMA Measurement Procedures for SAR

The following procedures are applicable to WCDMA handsets operating under 3GPP Release99, Release 5 and Release 6. The default test configuration is to measure SAR with an established radio link between the DUT and a communication test set using a 12.2kbps RMC (reference measurement channel) configured in Test Loop Mode 1. SAR is selectively confirmed for other physical channel configurations (DPCCH & DPDCH_n), HSDPA and HSPA (HSUPA/HSDPA) modes according to output power, exposure conditions and device operating capabilities. Both uplink and downlink should be configured with the same RMC or AMR, when required. SAR for Release 5 HSDPA and Release 6 HSPA are measured using the applicable FRC (fixed reference channel) and E-DCH reference channel configurations. Maximum output power is verified according to applicable versions of 3GPP TS 34.121 and SAR must be measured according to these maximum output conditions. When Maximum Power Reduction (MPR) is not implemented according to Cubic Metric (CM) requirements for Release 6 HSPA, the following procedures do not apply.

For Release 5 HSDPA Data Devices:

Sub-test	β_c	β_d	β_d (SF)	β_c / β_d	β_{hs}	CM/dB
1	2/15	15/15	64	2/15	4/15	0.0
2	12/15	15/15	64	12/15	24/25	1.0
3	15/15	8/15	64	15/8	30/15	1.5
4	15/15	4/15	64	15/4	30/15	1.5

For Release 6 HSPA Data Devices

Sub-test	β_c	β_d	β_d (SF)	β_c / β_d	β_{hs}	β_{ec}	β_{ed}	β_{ed} (SF)	β_{ed} (codes)	CM (dB)	MPR (dB)	AG Index	E-TFCI
1	11/15	15/15	64	11/15	22/15	209/225	1039/225	4	1	1.5	1.5	20	75
2	6/15	15/15	64	6/15	12/15	12/15	12/15	4	1	1.5	1.5	12	67
3	15/15	9/15	64	15/9	30/15	30/15	$\beta_{ed1}:47/15$ $\beta_{ed2}:47/15$	4	2	1.5	1.5	15	92
4	2/15	15/15	64	2/15	4/15	4/15	56/75	4	1	1.5	1.5	17	71
5	15/15	15/15	64	15/15	24/15	30/15	134/15	4	1	1.5	1.5	21	81

Rel.8 DC-HSDPA (Cat 24)

SAR test exclusion for Rel.8 DC-HSDPA must satisfy the SAR test exclusion requirements of Rel.5 HSDPA. SAR test exclusion for DC-HSDPA devices is determined by power measurements according to the H-Set 12, Fixed Reference Channel (FRC) configuration in Table C.8.1.12 of 3GPP TS 34.121-1. A primary and a secondary serving HS-DSCH Cell are required to perform the power measurement and for the results to qualify for SAR test exclusion.

9.4 SAR Measurement for LTE

SAR tests for LTE are performed with a base station simulator, Rohde & Schwarz CMW500. Closed loop power control was used so the UE transmits with maximum output power during SAR testing. All powers were measured with the CMW 500.

It is performed for conducted power and SAR based on the KDB941225 D05.

SAR is evaluated separately according to the following procedures for the different test positions in each exposure condition – head, body, body-worn accessories and other use conditions. The procedures in the following subsections are applied separately to test each LTE frequency band.

1) QPSK with 1 RB allocation

Start with the largest channel bandwidth and measure SAR for QPSK with 1 RB allocation, using the RB offset and required test channel combination with the highest maximum output power among RB offsets at the upper edge, middle and lower edge of each required test channel. When the reported SAR is ≤ 0.8 W/kg, testing of the remaining RB offset configurations and required test channels is not required for 1 RB allocation; otherwise, SAR is required for the remaining required test channels and only for the RB offset configuration with the highest output power for that channel. When the reported SAR of a required test channel is > 1.45 W/kg, SAR is required for all three RB offset configurations for that required test channel.

2) QPSK with 50% RB allocation

The procedures required for 1 RB allocation in 1) are applied to measure the SAR for QPSK with 50% RB allocation.

3) QPSK with 100% RB allocation

For QPSK with 100% RB allocation, SAR is not required when the highest maximum output power for 100 % RB allocation is less than the highest maximum output power in 50% and 1 RB allocations and the highest reported SAR for 1 RB and 50% RB allocation in 1) and 2) are ≤ 0.8 W/kg. Otherwise, SAR is measured for the highest output power channel; and if the reported SAR is > 1.45 W/kg, the remaining required test channels must also be tested.

TDD test:

TDD testing is performed using guidance from FCC KDB 941225 D05 v02r05 and the SAR test guidance provided in April 2013 TCB works hop notes. TDD is tested at the highest duty factor using UL-DL configuration 0 with special subframe configuration 6 and applying the FDD LTE procedures in KDB 941225 D05 v02r05. SAR testing is performed using the extended cyclic prefix listed in 3GPP TS 36.211.

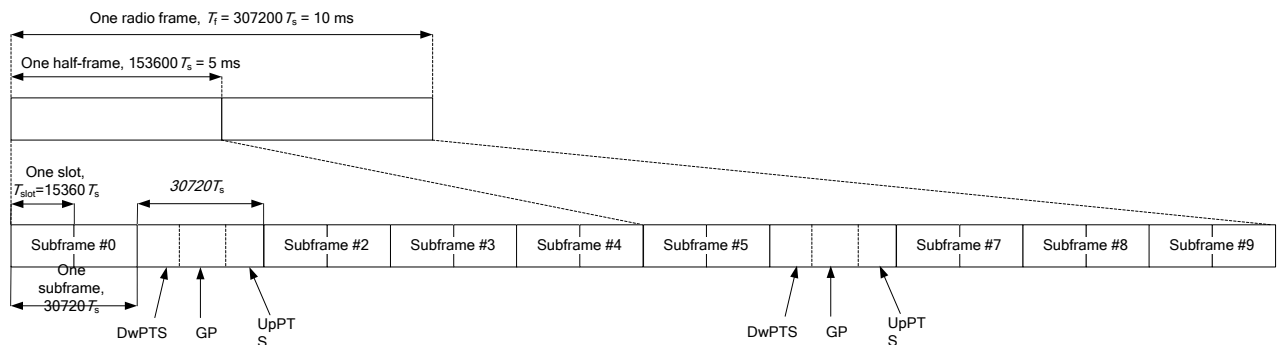

Figure 9.2: Frame structure type 2 (for 5 ms switch-point periodicity)

Table 9.1: Configuration of special subframe (lengths of DwPTS/GP/UpPTS)

Special subframe configuration	Normal cyclic prefix in downlink			Extended cyclic prefix in downlink		
	DwPTS	UpPTS		DwPTS	UpPTS	
		Normal cyclic prefix in uplink	Extended cyclic prefix in uplink		Normal cyclic prefix in uplink	Extended cyclic prefix in uplink
0	$6592 \cdot T_s$	$2192 \cdot T_s$	$2560 \cdot T_s$	$7680 \cdot T_s$	$2192 \cdot T_s$	$2560 \cdot T_s$
1	$19760 \cdot T_s$			$20480 \cdot T_s$		
2	$21952 \cdot T_s$			$23040 \cdot T_s$		
3	$24144 \cdot T_s$			$25600 \cdot T_s$		
4	$26336 \cdot T_s$	$4384 \cdot T_s$	$5120 \cdot T_s$	$7680 \cdot T_s$	$4384 \cdot T_s$	$5120 \cdot T_s$
5	$6592 \cdot T_s$			$20480 \cdot T_s$		
6	$19760 \cdot T_s$			$23040 \cdot T_s$		
7	$21952 \cdot T_s$			$12800 \cdot T_s$		
8	$24144 \cdot T_s$			-		
9	$13168 \cdot T_s$	-	-	-	-	-

Table 9.2: Uplink-downlink configurations

Uplink-downlink configuration	Downlink-to-Uplink Switch-point periodicity	Subframe number										
		0	1	2	3	4	5	6	7	8	9	
0	5 ms	D	S	U	U	U	D	S	U	U	U	
1	5 ms	D	S	U	U	D	D	S	U	U	D	
2	5 ms	D	S	U	D	D	D	S	U	D	D	
3	10 ms	D	S	U	U	U	D	D	D	D	D	
4	10 ms	D	S	U	U	D	D	D	D	D	D	
5	10 ms	D	S	U	D	D	D	D	D	D	D	
6	5 ms	D	S	U	U	U	D	S	U	U	D	

Duty factor is calculated by:

$$\begin{aligned}
 \text{Duty factor} &= \text{uplink frame} \cdot 6 + \text{UpPTS} \cdot 2 / \text{one frame length} \\
 &= (30720 \cdot T_s \cdot 6 + 5120 \cdot T_s \cdot 2) / 307200 \cdot T_s \\
 &= 0.633
 \end{aligned}$$

According to the KDB 447498 D01, SAR should be evaluated at more than 3 frequencies for devices supporting transmit bands wider than 100MHz. Oct.2014 FCC-TCB conference notes (Dec. 2014 rev.) specifies the 5 test channels to use for 3GPP band 41 SAR evaluation.

9.5 Bluetooth & Wi-Fi Measurement Procedures for SAR

Normal network operating configurations are not suitable for measuring the SAR of 802.11 transmitters in general. Unpredictable fluctuations in network traffic and antenna diversity conditions can introduce undesirable variations in SAR results. The SAR for these devices should be measured using chipset based test mode software to ensure that the results are consistent and reliable.

Chipset based test mode software is hardware dependent and generally varies among manufacturers. The device operating parameters established in a test mode for SAR measurements must be identical to those programmed in production units, including output power levels, amplifier gain settings and other RF performance tuning parameters. The test frequencies should correspond to actual channel frequencies defined for domestic use. SAR for devices with switched diversity should be measured with only one antenna transmitting at a time during each SAR measurement, according to a fixed modulation and data rate. The same data pattern should be used for all measurements.

9.6 Power Drift

To control the output power stability during the SAR test, DASY4 system calculates the power drift by measuring the E-field at the same location at the beginning and at the end of the measurement for each test position. These drift values can be found in section 14 labeled as: (Power Drift [dB]). This ensures that the power drift during one measurement is within 5%.

10 Area Scan Based 1-g SAR

10.1 Requirement of KDB

According to the KDB447498 D01 v05, when the implementation is based the specific polynomial fit algorithm as presented at the 29th Bioelectromagnetics Society meeting (2007) and the estimated 1-gSAR is ≤ 1.2 W/kg, a zoom scan measurement is not required provided it is also not needed for any other purpose; for example, if the peak SAR location required for simultaneous transmission SAR test exclusion can be determined accurately by the SAR system or manually to discriminate between distinctive peaks and scattered noisy SAR distributions from area scans.

There must not be any warning or alert messages due to various measurement concerns identified by the SAR system; for example, noise in measurements, peaks too close to scan boundary, peaks are too sharp, spatial resolution and uncertainty issues etc. The SAR system verification must also demonstrate that the area scan estimated 1-g SAR is within 3% of the zoom scan 1-g SAR (See Annex B). When all the SAR results for each exposure condition in a frequency band and wireless mode are based on estimated 1-g SAR, the 1-g SAR for the highest SAR configuration must be determined by a zoom scan.

10.2 Fast SAR Algorithms

The approach is based on the area scan measurement applying a frequency dependent attenuation parameter. This attenuation parameter was empirically determined by analyzing a large number of phones. The MOTOROLA FAST SAR was developed and validated by the MOTOROLA Research Group in Ft. Lauderdale.

In the initial study, an approximation algorithm based on Linear fit was developed. The accuracy of the algorithm has been demonstrated across a broad frequency range (136-2450 MHz) and for both 1- and 10-g averaged SAR using a sample of 264 SAR measurements from 55 wireless handsets. For the sample size studied, the root-mean-squared errors of the algorithm are 1.2% and 5.8% for 1- and 10-g averaged SAR, respectively. The paper describing the algorithm in detail is expected to be published in August 2004 within the Special Issue of Transactions on MTT.

In the second step, the same research group optimized the fitting algorithm to an Polynomial fit whereby the frequency validity was extended to cover the range 30-6000MHz. Details of this study can be found in the BEMS 2007 Proceedings.

Both algorithms are implemented in DASY software.

11 Conducted Output Power

This device uses a proximity sensor for SAR compliance. The proximity sensor is activated when the device is used in close proximity to the user's body. The proximity sensors trigger power reduction for all bands except Bluetooth. There is no power reduction mechanism for BT modes for SAR purposes.

11.1 GSM Measurement result

During the process of testing, the EUT was controlled via Agilent Digital Radio Communication tester (E5515C) to ensure the maximum power transmission and proper modulation. This result contains conducted output power for the EUT. In all cases, the measured peak output power should be greater and within 5% than EMI measurement.

Normal Power – Proximity sensor not active

Table 11.1-1: The conducted power measurement results for GPRS and EGPRS

GSM 850 GPRS (GMSK)	Measured Power (dBm)			Tune up	calculation	Averaged Power (dBm)		
	251	190	128			251	190	128
1 Txslot	33.48	33.66	33.66	34	-9.03	24.45	24.63	24.63
2 Txslots	31.33	31.36	31.31	31.5	-6.02	25.31	25.34	25.29
3Txslots	29.58	29.63	29.56	30	-4.26	25.32	25.37	25.30
4 Txslots	28.29	28.38	28.26	29	-3.01	25.28	25.37	25.25
GSM 850 EGPRS (GMSK)	Measured Power (dBm)			Tune up	calculation	Averaged Power (dBm)		
	251	190	128			251	190	128
1 Txslot	33.46	33.63	33.63	34	-9.03	24.43	24.60	24.60
2 Txslots	31.32	31.35	31.31	31.5	-6.02	25.30	25.33	25.29
3Txslots	29.57	29.63	29.56	30	-4.26	25.31	25.37	25.30
4 Txslots	28.28	28.37	28.25	29	-3.01	25.27	25.36	25.24
GSM 850 EGPRS (8PSK)	Measured Power (dBm)			Tune up	calculation	Averaged Power (dBm)		
	251	190	128			251	190	128
1 Txslot	26.97	27.05	27.09	27.5	-9.03	17.94	18.02	18.06
2 Txslots	24.83	24.95	25.02	25.5	-6.02	18.81	18.93	19.00
3Txslots	23.13	23.31	23.37	24.5	-4.26	18.87	19.05	19.11
4 Txslots	23.00	23.16	22.87	23.5	-3.01	19.99	20.15	19.86
PCS1900 GPRS (GMSK)	Measured Power (dBm)			Tune up	calculation	Averaged Power (dBm)		
	810	661	512			810	661	512
1 Txslot	30.30	30.33	30.56	31	-9.03	21.27	21.30	21.53
2 Txslots	28.35	28.11	28.15	28.5	-6.02	22.33	22.09	22.13
3Txslots	26.78	26.55	26.58	27	-4.26	22.52	22.29	22.32
4 Txslots	25.68	25.58	25.62	26	-3.01	22.67	22.57	22.61

PCS1900 EGPRS (GMSK)	Measured Power (dBm)			Tune up	calculation	Averaged Power (dBm)		
	810	661	512			810	661	512
1 Txslot	30.28	30.30	30.53	31	-9.03	21.25	21.27	21.50
2 Txslots	28.34	28.08	28.13	28.5	-6.02	22.32	22.06	22.11
3Txslots	26.76	26.53	26.56	27	-4.26	22.50	22.27	22.30
4 Txslots	25.66	25.57	25.60	26	-3.01	22.65	22.56	22.59
PCS1900 EGPRS (8PSK)	Measured Power (dBm)			Tune up	calculation	Averaged Power (dBm)		
	810	661	512			810	661	512
1 Txslot	25.99	25.93	26.18	26.5	-9.03	16.96	16.90	17.15
2 Txslots	23.83	23.79	23.93	24.5	-6.02	17.81	17.77	17.91
3Txslots	22.10	22.03	22.22	23	-4.26	17.84	17.77	17.96
4 Txslots	20.83	20.83	20.98	22	-3.01	17.82	17.82	17.97

NOTES:

1) Division Factors

To average the power, the division factor is as follows:

1TX-slot = 1 transmit time slot out of 8 time slots=> conducted power divided by (8/1) => -9.03dB

2TX-slots = 2 transmit time slots out of 8 time slots=> conducted power divided by (8/2) => -6.02dB

3TX-slots = 3 transmit time slots out of 8 time slots=> conducted power divided by (8/3) => -4.26dB

4TX-slots = 4 transmit time slots out of 8 time slots=> conducted power divided by (8/4) => -3.01dB

According to the conducted power as above, the body measurements are performed with 3Txslots for GSM850 and 4Txslots for GSM1900.

Low Power – Proximity sensor active

Table 11.1-2: The conducted power measurement results for GSM, GPRS and EGPRS

GSM 850 GPRS (GMSK)	Measured Power (dBm)			Tune up	calculation	Averaged Power (dBm)		
	251	190	128			251	190	128
1 Txslot	24.89	25.04	24.99	25.5	-9.03	15.86	16.01	15.96
2 Txslots	24.80	24.84	24.82	25.5	-6.02	18.78	18.82	18.80
3Txslots	24.51	24.65	24.63	25.5	-4.26	20.25	20.39	20.37
4 Txslots	24.39	24.43	24.42	25.5	-3.01	21.38	21.42	21.41
GSM 850 EGPRS (GMSK)	Measured Power (dBm)			Tune up	calculation	Averaged Power (dBm)		
	251	190	128			251	190	128
1 Txslot	24.83	24.96	24.95	25.5	-9.03	15.80	15.93	15.92
2 Txslots	24.65	24.79	24.77	25.5	-6.02	18.63	18.77	18.75
3Txslots	24.46	24.60	24.57	25.5	-4.26	20.20	20.34	20.31
4 Txslots	24.23	24.38	24.36	25.5	-3.01	21.22	21.37	21.35
GSM 850 EGPRS (8PSK)	Measured Power (dBm)			Tune up	calculation	Averaged Power (dBm)		
	251	190	128			251	190	128
1 Txslot	18.86	19.01	19.02	20.5	-9.03	9.83	9.98	9.99
2 Txslots	18.73	18.91	18.90	20.5	-6.02	12.71	12.89	12.88
3Txslots	18.53	18.76	18.78	20.5	-4.26	14.27	14.50	14.52
4 Txslots	18.53	18.58	18.59	20.5	-3.01	15.52	15.57	15.58

PCS1900 GPRS (GMSK)	Measured Power (dBm)			Tune up	calculation	Averaged Power (dBm)		
	810	661	512			810	661	512
1 Txslot	16.18	16.34	16.47	17	-9.03	7.15	7.31	7.44
2 Txslots	15.98	16.13	16.30	17	-6.02	9.96	10.11	10.28
3Txslots	15.77	15.92	16.07	17	-4.26	11.51	11.66	11.81
4 Txslots	15.74	15.79	15.84	17	-3.01	12.73	12.78	12.83
PCS1900 EGPRS (GMSK)	Measured Power (dBm)			Tune up	calculation	Averaged Power (dBm)		
	810	661	512			810	661	512
1 Txslot	16.19	16.35	16.50	17	-9.03	7.16	7.32	7.47
2 Txslots	15.99	16.15	16.32	17	-6.02	9.97	10.13	10.30
3Txslots	15.79	15.95	16.09	17	-4.26	11.53	11.69	11.83
4 Txslots	15.76	15.76	15.85	17	-3.01	12.75	12.75	12.84
PCS1900 EGPRS (8PSK)	Measured Power (dBm)			Tune up	calculation	Averaged Power (dBm)		
	810	661	512			810	661	512
1 Txslot	10.97	10.89	11.01	11.5	-9.03	1.94	1.86	1.98
2 Txslots	10.74	10.77	10.80	11.5	-6.02	4.72	4.75	4.78
3Txslots	10.50	10.50	10.60	11.5	-4.26	6.24	6.24	6.34
4 Txslots	10.27	10.24	10.37	11.5	-3.01	7.26	7.23	7.36

NOTES:

1) Division Factors

To average the power, the division factor is as follows:

1TX-slot = 1 transmit time slot out of 8 time slots=> conducted power divided by (8/1) => -9.03dB

2TX-slots = 2 transmit time slots out of 8 time slots=> conducted power divided by (8/2) => -6.02dB

3TX-slots = 3 transmit time slots out of 8 time slots=> conducted power divided by (8/3) => -4.26dB

4TX-slots = 4 transmit time slots out of 8 time slots=> conducted power divided by (8/4) => -3.01dB

According to the conducted power as above, the body measurements are performed with 4Txslots for GSM850/1900.

11.2 WCDMA Measurement result

Normal Power – Proximity sensor not active

Table 11.2-1: The conducted Power for WCDMA

Item	band	FDDV result			Tune up
	ARFCN	4132 (826.4MHz)	4182 (836.4MHz)	4233 (846.6MHz)	
WCDMA	\	21.98	21.95	21.69	23
HSUPA	1	22.24	22.60	22.36	23
	2	21.90	21.39	21.18	23
	3	21.46	21.29	21.07	23
	4	22.53	22.45	22.22	23
	5	22.99	22.94	22.66	23
DC-HSDPA	1	22.56	22.54	22.31	23
	2	22.54	22.52	22.33	23
	3	22.52	22.54	22.29	23
	4	22.53	22.53	22.27	23

Item	band	FDDII result			
	ARFCN	9262 (1852.4MHz)	9400 (1880MHz)	9538 (1907.6MHz)	Tune up
WCDMA	\	22.03	21.99	22.01	23
HSUPA	1	22.57	22.26	22.33	23
	2	21.44	21.70	21.66	23
	3	21.56	21.35	21.31	23
	4	22.22	22.14	22.24	23
	5	22.62	22.57	22.65	23
DC-HSDPA	1	22.35	22.25	22.41	23
	2	22.33	22.22	22.37	23
	3	22.31	22.25	22.39	23
	4	22.32	22.23	22.40	23

Low Power – Proximity sensor active

Table 11.2-2: The conducted Power for WCDMA

Item	band	FDDV result			
	ARFCN	4132 (826.4MHz)	4182 (836.4MHz)	4233 (846.6MHz)	Tune up
WCDMA	\	19.80	19.74	19.62	20
HSUPA	1	18.27	18.68	18.36	20
	2	17.87	17.44	17.14	18.5
	3	17.49	17.06	16.77	18.5
	4	18.44	18.37	18.15	20
	5	18.92	18.97	18.57	20
DC-HSDPA	1	18.61	18.57	18.35	20
	2	18.58	18.55	18.32	20
	3	18.59	18.56	18.34	20
	4	18.59	18.55	18.33	20

Item	band	FDDII result			
	ARFCN	9262 (1852.4MHz)	9400 (1880MHz)	9538 (1907.6MHz)	Tune up
WCDMA	\	12.32	12.25	11.97	13
HSUPA	1	10.35	10.53	10.09	11
	2	9.93	9.88	9.45	11
	3	9.50	9.43	9.01	11
	4	10.53	10.35	9.94	11
	5	11.05	10.86	10.45	11.5
DC-HSDPA	1	10.69	10.37	10.12	11
	2	10.68	10.38	10.10	11
	3	10.65	10.38	10.11	11
	4	10.66	10.37	10.11	11

11.3 LTE Measurement result

Normal Power – Proximity sensor not active

Table 11.3-1: The conducted Power for LTE

Band 2								
Bandwidth (MHz)	RB allocation	Frequency (MHz)	Max. Target Power (dBm)	QPSK		16QAM		
	RB offset (Start RB)			Actual output power (dBm)	MPR	Actual output power (dBm)	MPR	
1.4 MHz	1RB High (5)	1909.3	23	22.33	0	21.45	1	
		1880	23	22.31	0	21.89	1	
		1850.7	23	22.18	0	21.32	1	
	1RB Middle (3)	1909.3	23	22.29	0	21.33	1	
		1880	23	22.41	0	21.69	1	
		1850.7	23	22.62	0	21.87	1	
	1RB Low (0)	1909.3	23	22.25	0	21.33	1	
		1880	23	22.15	0	21.86	1	
		1850.7	23	22.33	0	21.48	1	
	3RB High (3)	1909.3	23	22.42	0	21.41	1	
		1880	23	22.36	0	21.38	1	
		1850.7	23	22.46	0	21.31	1	
	3RB Middle (1)	1909.3	23	22.48	0	21.57	1	
		1880	23	22.43	0	21.45	1	
		1850.7	23	22.49	0	21.60	1	
	3RB Low (0)	1909.3	23	22.41	0	21.50	1	
		1880	23	22.38	0	21.41	1	
		1850.7	23	22.33	0	21.44	1	
	6RB (0)	1909.3	23	21.44	1	20.39	2	
		1880	23	21.34	1	20.41	2	
		1850.7	23	21.42	1	20.37	2	
	3 MHz	1RB High (14)	1908.5	23	22.47	0	21.73	1
			1880	23	22.36	0	21.62	1
			1851.5	23	22.50	0	21.63	1
		1RB Middle (7)	1908.5	23	22.35	0	21.81	1
			1880	23	22.42	0	21.65	1
			1851.5	23	22.43	0	21.90	1
1RB Low (0)		1908.5	23	22.41	0	21.83	1	
		1880	23	22.39	0	21.62	1	
		1851.5	23	22.54	0	21.80	1	
8RB High (7)		1908.5	23	21.38	1	20.73	2	
		1880	23	21.35	1	20.63	2	
		1851.5	23	21.42	1	20.59	2	
8RB Middle (4)		1908.5	23	21.38	1	20.38	2	
		1880	23	21.35	1	20.48	2	
		1851.5	23	21.49	1	20.61	2	
8RB Low (0)		1908.5	23	21.43	1	20.55	2	
		1880	23	21.41	1	20.62	2	
		1851.5	23	21.49	1	20.61	2	

	15RB (0)	1908.5	23	21.50	1	20.58	2	
		1880	23	21.38	1	20.47	2	
		1851.5	23	21.41	1	20.41	2	
5 MHz	1RB High (24)	1907.5	23	22.34	0	21.80	1	
		1880	23	22.26	0	21.74	1	
		1852.5	23	22.34	0	21.84	1	
	1RB Middle (12)	1907.5	23	22.36	0	21.68	1	
		1880	23	22.31	0	21.64	1	
		1852.5	23	22.41	0	21.69	1	
	1RB Low (0)	1907.5	23	22.38	0	21.77	1	
		1880	23	22.32	0	21.73	1	
		1852.5	23	22.40	0	21.81	1	
	12RB High (13)	1907.5	23	21.48	1	20.64	2	
		1880	23	21.35	1	20.47	2	
		1852.5	23	21.39	1	20.35	2	
	12RB Middle (6)	1907.5	23	21.45	1	20.44	2	
		1880	23	21.40	1	20.31	2	
		1852.5	23	21.37	1	20.35	2	
	12RB Low (0)	1907.5	23	21.38	1	20.46	2	
		1880	23	21.53	1	20.44	2	
		1852.5	23	21.46	1	20.45	2	
	25RB (0)	1907.5	23	21.44	1	20.65	2	
		1880	23	21.50	1	20.51	2	
		1852.5	23	21.50	1	20.46	2	
	10 MHz	1RB High (49)	1905	23	22.30	0	21.73	1
			1880	23	22.23	0	21.83	1
			1855	23	22.38	0	21.72	1
1RB Middle (24)		1905	23	22.76	0	21.75	1	
		1880	23	22.43	0	21.98	1	
		1855	23	22.24	0	21.82	1	
1RB Low (0)		1905	23	22.40	0	21.76	1	
		1880	23	22.51	0	21.95	1	
		1855	23	22.32	0	21.94	1	
25RB High (25)		1905	23	21.49	1	20.53	2	
		1880	23	21.37	1	20.61	2	
		1855	23	21.43	1	20.39	2	
25RB Middle (12)		1905	23	21.44	1	20.51	2	
		1880	23	21.43	1	20.60	2	
		1855	23	21.36	1	20.44	2	
25RB Low (0)		1905	23	21.49	1	20.57	2	
		1880	23	21.49	1	20.57	2	
		1855	23	21.43	1	20.41	2	
50RB (0)		1905	23	21.47	1	20.52	2	
		1880	23	21.37	1	20.50	2	
		1855	23	21.46	1	20.53	2	
15 MHz		1RB High (74)	1902.5	23	22.31	0	21.75	1
			1880	23	22.30	0	21.81	1
			1857.5	23	22.49	0	21.76	1

	1RB Middle (37)	1902.5	23	22.45	0	21.93	1	
		1880	23	22.33	0	21.55	1	
		1857.5	23	22.31	0	21.85	1	
	1RB Low (0)	1902.5	23	22.35	0	22.00	1	
		1880	23	22.37	0	21.59	1	
		1857.5	23	22.27	0	21.95	1	
	36RB High (38)	1902.5	23	21.52	1	20.53	2	
		1880	23	21.38	1	20.43	2	
		1857.5	23	21.55	1	20.50	2	
	36RB Middle (19)	1902.5	23	21.46	1	20.52	2	
		1880	23	21.49	1	20.55	2	
		1857.5	23	21.40	1	20.50	2	
	36RB Low (0)	1902.5	23	21.57	1	20.53	2	
		1880	23	21.55	1	20.65	2	
		1857.5	23	21.35	1	20.44	2	
	75RB (0)	1902.5	23	21.43	1	20.59	2	
		1880	23	21.35	1	20.42	2	
		1857.5	23	21.38	1	20.47	2	
	20 MHz	1RB High (99)	1900	23	22.68	0	21.54	1
			1880	23	22.55	0	20.89	1
			1860	23	22.62	0	21.64	1
		1RB Middle (50)	1900	23	23.00	0	21.73	1
			1880	23	22.65	0	21.58	1
			1860	23	22.58	0	21.62	1
		1RB Low (0)	1900	23	22.74	0	21.32	1
			1880	23	22.59	0	21.56	1
			1860	23	22.58	0	21.57	1
50RB High (50)		1900	23	21.42	1	20.54	2	
		1880	23	21.31	1	20.53	2	
		1860	23	21.58	1	20.62	2	
50RB Middle (25)		1900	23	21.51	1	20.64	2	
		1880	23	21.44	1	20.59	2	
		1860	23	21.48	1	20.43	2	
50RB Low (0)		1900	23	21.47	1	20.62	2	
		1880	23	21.50	1	20.56	2	
		1860	23	21.46	1	20.52	2	
100RB (0)		1900	23	21.39	1	20.44	2	
		1880	23	21.42	1	20.49	2	
		1860	23	21.51	1	20.45	2	
Band 4								
Bandwidth (MHz)		RB allocation	Frequency (MHz)	Max. Target Power (dBm)	QPSK		16QAM	
		RB offset (Start RB)			Actual output power (dBm)	MPR	Actual output power (dBm)	MPR
1.4 MHz		1RB High (5)	1754.3	22.5	21.37	0	20.85	1
			1732.5	22.5	21.20	0	20.42	1
			1710.7	22.5	21.53	0	21.05	1

	1RB Middle (3)	1754.3	22.5	21.57	0	21.03	1
		1732.5	22.5	21.40	0	20.66	1
		1710.7	22.5	21.51	0	21.07	1
	1RB Low (0)	1754.3	22.5	21.32	0	20.75	1
		1732.5	22.5	21.23	0	20.47	1
		1710.7	22.5	21.51	0	20.94	1
	3RB High (3)	1754.3	22.5	21.37	0	20.43	1
		1732.5	22.5	21.41	0	20.37	1
		1710.7	22.5	21.52	0	20.32	1
	3RB Middle (1)	1754.3	22.5	21.48	0	20.46	1
		1732.5	22.5	21.46	0	20.40	1
		1710.7	22.5	21.61	0	20.46	1
	3RB Low (0)	1754.3	22.5	21.32	0	20.42	1
		1732.5	22.5	21.35	0	20.45	1
		1710.7	22.5	21.54	0	20.52	1
6RB (0)	1754.3	22.5	20.30	1	19.23	2	
	1732.5	22.5	20.33	1	19.38	2	
	1710.7	22.5	20.46	1	19.39	2	
3 MHz	1RB High (14)	1753.5	22.5	21.51	0	20.76	1
		1732.5	22.5	21.42	0	20.80	1
		1711.5	22.5	21.41	0	21.11	1
	1RB Middle (7)	1753.5	22.5	21.39	0	20.55	1
		1732.5	22.5	21.20	0	20.66	1
		1711.5	22.5	21.32	0	20.72	1
	1RB Low (0)	1753.5	22.5	21.39	0	20.50	1
		1732.5	22.5	21.38	0	20.62	1
		1711.5	22.5	21.52	0	20.65	1
	8RB High (7)	1753.5	22.5	20.32	1	19.50	2
		1732.5	22.5	20.36	1	19.35	2
		1711.5	22.5	20.47	1	19.64	2
	8RB Middle (4)	1753.5	22.5	20.32	1	19.46	2
		1732.5	22.5	20.34	1	19.44	2
		1711.5	22.5	20.62	1	19.62	2
	8RB Low (0)	1753.5	22.5	20.31	1	19.38	2
		1732.5	22.5	20.31	1	19.32	2
		1711.5	22.5	20.55	1	19.71	2
	15RB (0)	1753.5	22.5	20.24	1	19.30	2
		1732.5	22.5	20.40	1	19.47	2
		1711.5	22.5	20.55	1	19.61	2
5 MHz	1RB High (24)	1752.5	22.5	21.46	0	20.85	1
		1732.5	22.5	21.31	0	20.77	1
		1712.5	22.5	21.20	0	20.57	1
	1RB Middle (12)	1752.5	22.5	21.35	0	20.72	1
		1732.5	22.5	21.20	0	20.60	1
		1712.5	22.5	21.22	0	20.98	1
	1RB Low (0)	1752.5	22.5	21.48	0	20.80	1
		1732.5	22.5	21.31	0	20.80	1
		1712.5	22.5	21.32	0	20.78	1

	12RB High (13)	1752.5	22.5	20.36	1	19.51	2	
		1732.5	22.5	20.34	1	19.40	2	
		1712.5	22.5	20.46	1	19.52	2	
	12RB Middle (6)	1752.5	22.5	20.32	1	19.48	2	
		1732.5	22.5	20.36	1	19.43	2	
		1712.5	22.5	20.48	1	19.43	2	
	12RB Low (0)	1752.5	22.5	20.43	1	19.33	2	
		1732.5	22.5	20.34	1	19.61	2	
		1712.5	22.5	20.60	1	19.56	2	
	25RB (0)	1752.5	22.5	20.35	1	19.43	2	
		1732.5	22.5	20.40	1	19.54	2	
		1712.5	22.5	20.48	1	19.54	2	
10 MHz	1RB High (49)	1750	22.5	21.52	0	20.80	1	
		1732.5	22.5	21.19	0	20.87	1	
		1715	22.5	21.35	0	20.89	1	
	1RB Middle (24)	1750	22.5	21.68	0	21.19	1	
		1732.5	22.5	21.32	0	21.19	1	
		1715	22.5	21.47	0	21.00	1	
	1RB Low (0)	1750	22.5	21.54	0	20.72	1	
		1732.5	22.5	21.24	0	20.87	1	
		1715	22.5	21.48	0	21.04	1	
	25RB High (25)	1750	22.5	20.30	1	19.43	2	
		1732.5	22.5	20.33	1	19.35	2	
		1715	22.5	20.48	1	19.50	2	
	25RB Middle (12)	1750	22.5	20.33	1	19.37	2	
		1732.5	22.5	20.30	1	19.34	2	
		1715	22.5	20.43	1	19.46	2	
	25RB Low (0)	1750	22.5	20.49	1	19.52	2	
		1732.5	22.5	20.35	1	19.28	2	
		1715	22.5	20.55	1	19.58	2	
	50RB (0)	1750	22.5	20.38	1	19.41	2	
		1732.5	22.5	20.34	1	19.45	2	
		1715	22.5	20.50	1	19.51	2	
	15 MHz	1RB High (74)	1747.5	22.5	21.30	0	20.66	1
			1732.5	22.5	21.44	0	20.49	1
			1717.5	22.5	21.31	0	20.80	1
1RB Middle (37)		1747.5	22.5	21.47	0	20.63	1	
		1732.5	22.5	21.26	0	20.74	1	
		1717.5	22.5	21.38	0	20.40	1	
1RB Low (0)		1747.5	22.5	21.43	0	20.89	1	
		1732.5	22.5	21.30	0	20.77	1	
		1717.5	22.5	21.58	0	20.47	1	
36RB High (38)		1747.5	22.5	20.32	1	19.30	2	
		1732.5	22.5	20.39	1	19.39	2	
		1717.5	22.5	20.37	1	19.47	2	
36RB Middle (19)		1747.5	22.5	20.31	1	19.32	2	
		1732.5	22.5	20.32	1	19.33	2	
		1717.5	22.5	20.51	1	19.50	2	

	36RB Low (0)	1747.5	22.5	20.38	1	19.49	2	
		1732.5	22.5	20.36	1	19.36	2	
		1717.5	22.5	20.51	1	19.41	2	
	75RB (0)	1747.5	22.5	20.39	1	19.42	2	
		1732.5	22.5	20.38	1	19.41	2	
		1717.5	22.5	20.49	1	19.51	2	
20 MHz	1RB High (99)	1745	22.5	21.56	0	20.35	1	
		1732.5	22.5	21.45	0	20.74	1	
		1720	22.5	21.55	0	20.47	1	
	1RB Middle (50)	1745	22.5	21.93	0	20.49	1	
		1732.5	22.5	21.20	0	20.90	1	
		1720	22.5	21.86	0	20.47	1	
	1RB Low (0)	1745	22.5	21.69	0	20.62	1	
		1732.5	22.5	21.21	0	20.93	1	
		1720	22.5	21.57	0	20.57	1	
	50RB High (50)	1745	22.5	20.30	1	19.44	2	
		1732.5	22.5	20.38	1	19.40	2	
		1720	22.5	20.32	1	19.35	2	
	50RB Middle (25)	1745	22.5	20.66	1	19.51	2	
		1732.5	22.5	20.57	1	19.21	2	
		1720	22.5	20.55	1	19.31	2	
	50RB Low (0)	1745	22.5	20.39	1	19.34	2	
		1732.5	22.5	20.29	1	19.14	2	
		1720	22.5	20.45	1	19.39	2	
	100RB (0)	1745	22.5	20.36	1	19.43	2	
		1732.5	22.5	20.34	1	19.41	2	
		1720	22.5	20.39	1	19.30	2	
	Band 5							
	Bandwidth (MHz)	RB allocation	Frequency (MHz)	Max. Target Power (dBm)	QPSK		16QAM	
		RB offset (Start RB)			Actual output power (dBm)	MPR	Actual output power (dBm)	MPR
1.4 MHz	1RB High (5)	848.3	23	22.03	0	21.36	1	
		836.5	23	21.96	0	21.31	1	
		824.7	23	22.08	0	21.20	1	
	1RB Middle (3)	848.3	23	21.76	0	21.48	1	
		836.5	23	21.95	0	21.52	1	
		824.7	23	22.23	0	20.94	1	
	1RB Low (0)	848.3	23	21.87	0	21.42	1	
		836.5	23	21.82	0	21.30	1	
		824.7	23	22.09	0	21.39	1	
	3RB High (3)	848.3	23	21.92	0	20.90	1	
		836.5	23	22.10	0	21.02	1	
		824.7	23	22.17	0	20.91	1	
	3RB Middle (1)	848.3	23	21.85	0	20.90	1	
		836.5	23	21.91	0	21.04	1	
		824.7	23	22.24	0	21.09	1	

	3RB Low (0)	848.3	23	21.82	0	20.78	1	
		836.5	23	21.93	0	21.08	1	
		824.7	23	22.07	0	21.11	1	
	6RB (0)	848.3	23	20.70	1	19.70	2	
		836.5	23	20.87	1	19.86	2	
		824.7	23	21.02	1	20.01	2	
3 MHz	1RB High (14)	847.5	23	21.94	0	21.27	1	
		836.5	23	21.97	0	21.41	1	
		825.5	23	22.06	0	21.22	1	
	1RB Middle (7)	847.5	23	21.74	0	21.24	1	
		836.5	23	21.92	0	21.18	1	
		825.5	23	22.07	0	21.26	1	
	1RB Low (0)	847.5	23	21.84	0	21.31	1	
		836.5	23	21.85	0	21.23	1	
		825.5	23	22.11	0	21.21	1	
	8RB High (7)	847.5	23	20.93	1	19.94	2	
		836.5	23	21.06	1	19.88	2	
		825.5	23	21.24	1	19.97	2	
	8RB Middle (4)	847.5	23	20.82	1	19.88	2	
		836.5	23	20.95	1	20.18	2	
		825.5	23	21.08	1	20.23	2	
	8RB Low (0)	847.5	23	20.88	1	20.12	2	
		836.5	23	20.97	1	20.21	2	
		825.5	23	20.97	1	20.11	2	
	15RB (0)	847.5	23	20.93	1	19.94	2	
		836.5	23	20.96	1	19.98	2	
		825.5	23	21.04	1	20.20	2	
	5 MHz	1RB High (24)	846.5	23	21.60	0	21.19	1
			836.5	23	21.82	0	21.13	1
			826.5	23	21.84	0	21.26	1
1RB Middle (12)		846.5	23	21.73	0	21.07	1	
		836.5	23	22.04	0	21.28	1	
		826.5	23	21.87	0	21.32	1	
1RB Low (0)		846.5	23	21.57	0	20.97	1	
		836.5	23	21.82	0	21.13	1	
		826.5	23	21.96	0	21.38	1	
12RB High (13)		846.5	23	20.86	1	19.88	2	
		836.5	23	20.92	1	20.00	2	
		826.5	23	21.06	1	19.99	2	
12RB Middle (6)		846.5	23	20.76	1	19.76	2	
		836.5	23	21.02	1	19.89	2	
		826.5	23	21.02	1	20.04	2	
12RB Low (0)		846.5	23	20.57	1	19.78	2	
		836.5	23	20.90	1	19.91	2	
		826.5	23	21.03	1	19.96	2	
25RB (0)		846.5	23	20.72	1	19.84	2	
		836.5	23	20.93	1	19.96	2	
		826.5	23	20.85	1	19.97	2	

10 MHz	1RB High (49)	844.0	23	21.89	0	21.30	1	
		836.5	23	22.11	0	21.54	1	
		829.0	23	22.04	0	21.38	1	
	1RB Middle (24)	844.0	23	22.11	0	21.21	1	
		836.5	23	22.17	0	21.55	1	
		829.0	23	21.91	0	21.34	1	
	1RB Low (0)	844.0	23	21.82	0	21.24	1	
		836.5	23	21.97	0	21.50	1	
		829.0	23	21.92	0	21.49	1	
	25RB High (25)	844.0	23	21.00	1	19.87	2	
		836.5	23	21.07	1	20.14	2	
		829.0	23	21.04	1	19.93	2	
	25RB Middle (12)	844.0	23	20.86	1	19.69	2	
		836.5	23	20.90	1	19.88	2	
		829.0	23	21.04	1	20.03	2	
	25RB Low (0)	844.0	23	20.86	1	19.93	2	
		836.5	23	20.98	1	20.17	2	
		829.0	23	20.98	1	20.18	2	
	50RB (0)	844.0	23	20.85	1	19.91	2	
		836.5	23	20.98	1	19.90	2	
		829.0	23	20.99	1	19.98	2	
	Band 7							
	Bandwidth (MHz)	RB allocation	Frequency (MHz)	Max. Target Power (dBm)	QPSK		16QAM	
		RB offset (Start RB)			Actual output power (dBm)	MPR	Actual output power (dBm)	MPR
5 MHz	1RB High (24)	2567.5	23	21.51	0	20.91	1	
		2535	23	21.65	0	20.87	1	
		2502.5	23	21.62	0	20.84	1	
	1RB Middle (12)	2567.5	23	21.56	0	21.11	1	
		2535	23	21.67	0	21.08	1	
		2502.5	23	21.82	0	20.99	1	
	1RB Low (0)	2567.5	23	21.53	0	20.90	1	
		2535	23	21.35	0	20.79	1	
		2502.5	23	21.54	0	21.10	1	
	12RB High (13)	2567.5	23	20.60	1	19.77	2	
		2535	23	20.61	1	19.55	2	
		2502.5	23	20.63	1	19.93	2	
	12RB Middle (6)	2567.5	23	20.71	1	19.81	2	
		2535	23	20.60	1	19.82	2	
		2502.5	23	20.59	1	19.90	2	
	12RB Low (0)	2567.5	23	20.58	1	19.73	2	
		2535	23	20.37	1	19.78	2	
		2502.5	23	20.66	1	19.74	2	
	25RB (0)	2567.5	23	20.66	1	19.69	2	
		2535	23	20.57	1	19.62	2	
		2502.5	23	20.57	1	19.73	2	

10 MHz	1RB High (49)	2565	23	21.84	0	21.36	1
		2535	23	21.71	0	20.92	1
		2505	23	21.58	0	20.79	1
	1RB Middle (24)	2565	23	21.87	0	21.40	1
		2535	23	21.85	0	20.90	1
		2505	23	21.72	0	20.85	1
	1RB Low (0)	2565	23	21.77	0	21.44	1
		2535	23	21.62	0	20.85	1
		2505	23	21.75	0	21.10	1
	25RB High (25)	2565	23	20.70	1	19.95	2
		2535	23	20.51	1	19.60	2
		2505	23	20.65	1	19.73	2
	25RB Middle (12)	2565	23	20.72	1	19.82	2
		2535	23	20.55	1	19.66	2
		2505	23	20.61	1	19.71	2
	25RB Low (0)	2565	23	20.74	1	19.93	2
		2535	23	20.48	1	19.68	2
		2505	23	20.49	1	19.69	2
50RB (0)	2565	23	20.72	1	19.63	2	
	2535	23	20.58	1	19.58	2	
	2505	23	20.65	1	19.75	2	
15 MHz	1RB High (74)	2562.5	23	21.71	0	21.17	1
		2535	23	21.79	0	21.30	1
		2507.5	23	21.39	0	21.22	1
	1RB Middle (37)	2562.5	23	21.79	0	21.02	1
		2535	23	21.70	0	21.14	1
		2507.5	23	21.63	0	21.28	1
	1RB Low (0)	2562.5	23	21.68	0	21.18	1
		2535	23	21.47	0	21.19	1
		2507.5	23	21.54	0	21.48	1
	36RB High (38)	2562.5	23	20.71	1	19.84	2
		2535	23	20.57	1	19.74	2
		2507.5	23	20.62	1	19.71	2
	36RB Middle (19)	2562.5	23	20.78	1	19.88	2
		2535	23	20.64	1	19.73	2
		2507.5	23	20.61	1	19.70	2
	36RB Low (0)	2562.5	23	20.72	1	19.83	2
		2535	23	20.36	1	19.68	2
		2507.5	23	20.54	1	19.77	2
75RB (0)	2562.5	23	20.65	1	19.74	2	
	2535	23	20.56	1	19.66	2	
	2507.5	23	20.62	1	19.73	2	
20 MHz	1RB High (99)	2560	23	21.93	0	20.85	1
		2535	23	21.74	0	20.68	1
		2510	23	21.53	0	20.55	1
	1RB Middle (50)	2560	23	22.04	0	20.67	1
		2535	23	22.21	0	20.75	1
		2510	23	22.02	0	20.65	1

	1RB Low (0)	2560	23	21.86	0	20.74	1
		2535	23	21.54	0	20.62	1
		2510	23	21.75	0	20.78	1
	50RB High (50)	2560	23	20.67	1	19.69	2
		2535	23	20.56	1	19.62	2
		2510	23	20.55	1	19.62	2
	50RB Middle (25)	2560	23	20.70	1	19.78	2
		2535	23	20.59	1	19.67	2
		2510	23	20.54	1	19.52	2
	50RB Low (0)	2560	23	20.68	1	19.68	2
		2535	23	20.46	1	19.68	2
		2510	23	20.48	1	19.67	2
100RB (0)	2560	23	20.74	1	19.70	2	
	2535	23	20.57	1	19.66	2	
	2510	23	20.52	1	19.61	2	
Band 38							
Bandwidth (MHz)	RB allocation	Frequency (MHz)	Max. Target Power (dBm)	QPSK		16QAM	
	RB offset (Start RB)			Actual output power (dBm)	MPR	Actual output power (dBm)	MPR
5 MHz	1RB High (24)	2617.5	23	21.46	0	21.01	1
		2595	23	21.65	0	21.30	1
		2572.5	23	21.58	0	21.17	1
	1RB Middle (12)	2617.5	23	21.59	0	21.19	1
		2595	23	21.72	0	21.12	1
		2572.5	23	21.83	0	21.46	1
	1RB Low (0)	2617.5	23	21.57	0	21.35	1
		2595	23	21.70	0	21.17	1
		2572.5	23	21.60	0	21.32	1
	12RB High (13)	2617.5	23	20.90	1	20.05	2
		2595	23	21.00	1	19.84	2
		2572.5	23	21.07	1	20.22	2
	12RB Middle (6)	2617.5	23	20.94	1	19.78	2
		2595	23	20.92	1	20.17	2
		2572.5	23	21.06	1	20.12	2
	12RB Low (0)	2617.5	23	20.97	1	20.01	2
		2595	23	21.01	1	19.86	2
		2572.5	23	21.01	1	20.14	2
25RB (0)	2617.5	23	21.04	1	19.96	2	
	2595	23	21.02	1	19.99	2	
	2572.5	23	21.16	1	20.12	2	
10 MHz	1RB High (49)	2615	23	22.02	0	21.43	1
		2595	23	22.15	0	21.29	1
		2575	23	22.15	0	21.62	1
	1RB Middle (24)	2615	23	22.11	0	22.00	1
		2595	23	22.36	0	21.69	1
		2575	23	22.46	0	21.91	1

	1RB Low (0)	2615	23	22.07	0	21.51	1
		2595	23	22.18	0	21.35	1
		2575	23	22.12	0	21.52	1
	25RB High (25)	2615	23	21.09	1	19.93	2
		2595	23	21.00	1	19.93	2
		2575	23	21.31	1	20.00	2
	25RB Middle (12)	2615	23	21.03	1	19.86	2
		2595	23	21.01	1	19.96	2
		2575	23	21.15	1	20.19	2
	25RB Low (0)	2615	23	20.96	1	19.85	2
		2595	23	21.00	1	19.94	2
		2575	23	21.06	1	20.00	2
50RB (0)	2615	23	20.90	1	20.04	2	
	2595	23	20.96	1	19.96	2	
	2575	23	21.19	1	20.14	2	
15 MHz	1RB High (74)	2612.5	23	21.98	0	21.02	1
		2595	23	22.26	0	21.70	1
		2577.5	23	22.26	0	21.24	1
	1RB Middle (37)	2612.5	23	22.09	0	20.99	1
		2595	23	22.08	0	21.65	1
		2577.5	23	22.15	0	21.17	1
	1RB Low (0)	2612.5	23	22.18	0	21.76	1
		2595	23	22.21	0	21.75	1
		2577.5	23	22.11	0	21.78	1
	36RB High (38)	2612.5	23	20.91	1	19.97	2
		2595	23	20.93	1	20.04	2
		2577.5	23	21.09	1	20.11	2
	36RB Middle (19)	2612.5	23	20.93	1	20.05	2
		2595	23	21.06	1	20.09	2
		2577.5	23	21.03	1	20.18	2
	36RB Low (0)	2612.5	23	20.95	1	20.02	2
		2595	23	20.98	1	20.02	2
		2577.5	23	21.16	1	20.18	2
	75RB (0)	2612.5	23	20.94	1	19.99	2
		2595	23	20.98	1	20.04	2
		2577.5	23	21.09	1	20.16	2
20 MHz	1RB High (99)	2610	23	21.57	0	20.37	1
		2595	23	21.85	0	20.73	1
		2580	23	21.67	0	20.54	1
	1RB Middle (50)	2610	23	22.16	0	20.76	1
		2595	23	22.26	0	20.80	1
		2580	23	22.28	0	20.80	1
	1RB Low (0)	2610	23	21.66	0	20.55	1
		2595	23	21.80	0	20.70	1
		2580	23	21.69	0	20.50	1
	50RB High (50)	2610	23	20.94	1	19.97	2
		2595	23	20.91	1	19.93	2
		2580	23	21.10	1	20.13	2

	50RB Middle (25)	2610	23	20.97	1	20.01	2
		2595	23	20.98	1	19.92	2
		2580	23	21.07	1	20.13	2
	50RB Low (0)	2610	23	20.99	1	19.93	2
		2595	23	20.98	1	19.92	2
		2580	23	21.01	1	20.06	2
	100RB (0)	2610	23	20.95	1	19.83	2
		2595	23	20.97	1	19.82	2
		2580	23	21.05	1	19.90	2

Low Power – Proximity sensor active

Table 11.3-2: The conducted Power for LTE

Band 2							
Bandwidth (MHz)	RB allocation	Frequency (MHz)	Max. Target Power (dBm)	QPSK		16QAM	
	RB offset (Start RB)			Actual output power (dBm)	MPR	Actual output power (dBm)	MPR
1.4 MHz	1RB High (5)	1909.3	15	14.29	0	14.25	0
		1880	15	14.08	0	14.03	0
		1850.7	15	13.84	0	13.98	0
	1RB Middle (3)	1909.3	15	14.38	0	14.39	0
		1880	15	14.25	0	14.25	0
		1850.7	15	14.00	0	14.17	0
	1RB Low (0)	1909.3	15	14.20	0	14.16	0
		1880	15	14.21	0	14.17	0
		1850.7	15	13.86	0	14.00	0
	3RB High (3)	1909.3	15	14.40	0	14.41	0
		1880	15	14.26	0	14.27	0
		1850.7	15	14.03	0	14.23	0
	3RB Middle (1)	1909.3	15	14.40	0	14.44	0
		1880	15	14.35	0	14.38	0
		1850.7	15	14.08	0	14.30	0
	3RB Low (0)	1909.3	15	14.33	0	14.38	0
		1880	15	14.32	0	14.37	0
		1850.7	15	14.03	0	14.26	0
	6RB (0)	1909.3	15	13.79	0	13.73	0
		1880	15	14.23	0	13.99	0
		1850.7	15	14.41	0	14.17	0
3 MHz	1RB High (14)	1908.5	15	14.48	0	14.57	0
		1880	15	14.27	0	14.35	0
		1851.5	15	13.96	0	14.10	0
	1RB Middle (7)	1908.5	15	14.42	0	14.42	0
		1880	15	14.34	0	14.34	0
		1851.5	15	14.02	0	14.20	0
	1RB Low (0)	1908.5	15	14.39	0	14.50	0
		1880	15	14.47	0	14.58	0
		1851.5	15	14.07	0	14.24	0

	8RB High (7)	1908.5	15	13.92	0	14.01	0	
		1880	15	14.28	0	14.20	0	
		1851.5	15	14.42	0	14.33	0	
	8RB Middle (4)	1908.5	15	13.89	0	14.01	0	
		1880	15	14.34	0	14.28	0	
		1851.5	15	14.44	0	14.37	0	
	8RB Low (0)	1908.5	15	13.84	0	13.96	0	
		1880	15	14.41	0	14.35	0	
		1851.5	15	14.45	0	14.39	0	
	15RB (0)	1908.5	15	13.84	0	13.91	0	
		1880	15	14.29	0	14.19	0	
		1851.5	15	14.38	0	14.28	0	
5 MHz	1RB High (24)	1907.5	15	14.60	0	14.86	0	
		1880	15	14.43	0	14.67	0	
		1852.5	15	14.24	0	14.55	0	
	1RB Middle (12)	1907.5	15	14.51	0	14.66	0	
		1880	15	14.40	0	14.54	0	
		1852.5	15	14.03	0	14.35	0	
	1RB Low (0)	1907.5	15	14.51	0	14.77	0	
		1880	15	14.57	0	14.83	0	
		1852.5	15	14.16	0	14.49	0	
	12RB High (13)	1907.5	15	13.91	0	14.08	0	
		1880	15	14.29	0	14.28	0	
		1852.5	15	14.43	0	14.41	0	
	12RB Middle (6)	1907.5	15	13.91	0	14.08	0	
		1880	15	14.38	0	14.39	0	
		1852.5	15	14.43	0	14.44	0	
	12RB Low (0)	1907.5	15	13.77	0	13.96	0	
		1880	15	14.35	0	14.49	0	
		1852.5	15	14.36	0	14.50	0	
	25RB (0)	1907.5	15	13.76	0	13.86	0	
		1880	15	14.23	0	14.28	0	
		1852.5	15	14.31	0	14.36	0	
	10 MHz	1RB High (49)	1905	15	14.02	0	14.14	0
			1880	15	13.80	0	13.91	0
			1855	15	14.22	0	14.40	0
1RB Middle (24)		1905	15	14.42	0	14.42	0	
		1880	15	14.36	0	14.36	0	
		1855	15	14.15	0	14.32	0	
1RB Low (0)		1905	15	14.13	0	14.26	0	
		1880	15	14.10	0	14.23	0	
		1855	15	13.62	0	13.80	0	
25RB High (25)		1905	15	13.63	0	13.73	0	
		1880	15	14.05	0	14.06	0	
		1855	15	14.52	0	14.53	0	
25RB Middle (12)	1905	15	13.84	0	13.90	0		
	1880	15	14.34	0	14.22	0		
	1855	15	14.50	0	14.40	0		

	25RB Low (0)	1905	15	13.63	0	13.73	0	
		1880	15	14.25	0	14.28	0	
		1855	15	14.13	0	14.15	0	
	50RB (0)	1905	15	13.59	0	13.68	0	
		1880	15	14.11	0	14.11	0	
		1855	15	14.33	0	14.35	0	
15 MHz	1RB High (74)	1902.5	15	14.09	0	14.22	0	
		1880	15	13.92	0	14.05	0	
		1857.5	15	14.76	0	14.94	0	
	1RB Middle (37)	1902.5	15	14.44	0	14.44	0	
		1880	15	14.30	0	14.30	0	
		1857.5	15	14.34	0	14.51	0	
	1RB Low (0)	1902.5	15	14.38	0	14.51	0	
		1880	15	14.30	0	14.43	0	
		1857.5	15	13.67	0	13.85	0	
	36RB High (38)	1902.5	15	13.80	0	13.86	0	
		1880	15	14.08	0	14.09	0	
		1857.5	15	14.83	0	14.86	0	
	36RB Middle (19)	1902.5	15	14.07	0	14.14	0	
		1880	15	14.39	0	14.28	0	
		1857.5	15	14.66	0	14.57	0	
	36RB Low (0)	1902.5	15	13.93	0	14.04	0	
		1880	15	14.32	0	14.38	0	
		1857.5	15	14.14	0	14.19	0	
	75RB (0)	1902.5	15	13.79	0	13.86	0	
		1880	15	14.12	0	14.14	0	
		1857.5	15	14.44	0	14.47	0	
	20 MHz	1RB High (99)	1900	15	13.93	0	14.10	0
			1880	15	14.03	0	14.20	0
			1860	15	14.68	0	14.85	0
		1RB Middle (50)	1900	15	14.71	0	14.76	0
			1880	15	14.42	0	14.47	0
			1860	15	14.76	0	14.97	0
1RB Low (0)		1900	15	14.11	0	14.30	0	
		1880	15	14.38	0	14.57	0	
		1860	15	13.45	0	13.70	0	
50RB High (50)		1900	15	13.60	0	13.67	0	
		1880	15	13.88	0	13.87	0	
		1860	15	14.97	0	14.98	0	
50RB Middle (25)		1900	15	14.13	0	14.18	0	
		1880	15	14.36	0	14.22	0	
		1860	15	14.91	0	14.78	0	
50RB Low (0)		1900	15	13.80	0	13.88	0	
		1880	15	14.13	0	14.14	0	
		1860	15	14.11	0	14.13	0	
100RB (0)		1900	15	13.64	0	13.72	0	
		1880	15	14.00	0	14.00	0	
		1860	15	14.45	0	14.45	0	

Band 4							
Bandwidth (MHz)	RB allocation	Frequency (MHz)	Max. Target Power (dBm)	QPSK		16QAM	
	RB offset (Start RB)			Actual output power (dBm)	MPR	Actual output power (dBm)	MPR
1.4 MHz	1RB High (5)	1754.3	14	13.12	0	13.25	0
		1732.5	14	13.00	0	13.11	0
		1710.7	14	13.41	0	13.55	0
	1RB Middle (3)	1754.3	14	13.24	0	13.42	0
		1732.5	14	13.16	0	13.27	0
		1710.7	14	13.50	0	13.67	0
	1RB Low (0)	1754.3	14	13.13	0	13.27	0
		1732.5	14	12.96	0	13.07	0
		1710.7	14	13.32	0	13.46	0
	3RB High (3)	1754.3	14	13.22	0	13.41	0
		1732.5	14	13.13	0	13.25	0
		1710.7	14	13.48	0	13.69	0
	3RB Middle (1)	1754.3	14	13.27	0	13.48	0
		1732.5	14	13.16	0	13.32	0
		1710.7	14	13.50	0	13.72	0
	3RB Low (0)	1754.3	14	13.22	0	13.44	0
		1732.5	14	13.11	0	13.28	0
		1710.7	14	13.44	0	13.66	0
	6RB (0)	1754.3	14	12.96	0	12.92	0
		1732.5	14	13.09	0	12.97	0
		1710.7	14	13.64	0	13.57	0
3 MHz	1RB High (14)	1753.5	14	13.47	0	13.60	0
		1732.5	14	13.50	0	13.57	0
		1711.5	14	13.66	0	13.71	0
	1RB Middle (7)	1753.5	14	13.46	0	13.63	0
		1732.5	14	13.33	0	13.45	0
		1711.5	14	13.44	0	13.66	0
	1RB Low (0)	1753.5	14	13.56	0	13.63	0
		1732.5	14	13.42	0	13.41	0
		1711.5	14	13.55	0	13.70	0
	8RB High (7)	1753.5	14	13.12	0	13.20	0
		1732.5	14	13.31	0	13.35	0
		1711.5	14	13.76	0	13.86	0
	8RB Middle (4)	1753.5	14	13.14	0	13.25	0
		1732.5	14	13.30	0	13.36	0
		1711.5	14	13.84	0	13.96	0
	8RB Low (0)	1753.5	14	13.05	0	13.15	0
		1732.5	14	13.28	0	13.33	0
		1711.5	14	13.78	0	13.89	0
	15RB (0)	1753.5	14	13.08	0	13.14	0
		1732.5	14	13.25	0	13.26	0
		1711.5	14	13.78	0	13.85	0

5 MHz	1RB High (24)	1752.5	14	13.53	0	13.83	0
		1732.5	14	13.58	0	13.82	0
		1712.5	14	13.83	0	13.97	0
	1RB Middle (12)	1752.5	14	13.47	0	13.77	0
		1732.5	14	13.30	0	13.57	0
		1712.5	14	13.58	0	13.95	0
	1RB Low (0)	1752.5	14	13.70	0	13.81	0
		1732.5	14	13.50	0	13.64	0
		1712.5	14	13.71	0	13.83	0
	12RB High (13)	1752.5	14	13.02	0	13.18	0
		1732.5	14	13.22	0	13.42	0
		1712.5	14	13.82	0	13.99	0
	12RB Middle (6)	1752.5	14	12.98	0	13.15	0
		1732.5	14	13.24	0	13.35	0
		1712.5	14	13.75	0	13.93	0
	12RB Low (0)	1752.5	14	13.02	0	13.14	0
		1732.5	14	13.22	0	13.24	0
		1712.5	14	13.75	0	13.94	0
25RB (0)	1752.5	14	13.07	0	13.08	0	
	1732.5	14	13.29	0	13.22	0	
	1712.5	14	13.73	0	13.82	0	
10 MHz	1RB High (49)	1750	14	12.98	0	13.61	0
		1732.5	14	13.20	0	13.29	0
		1715	14	13.19	0	13.28	0
	1RB Middle (24)	1750	14	13.52	0	13.75	0
		1732.5	14	13.34	0	13.45	0
		1715	14	13.52	0	13.75	0
	1RB Low (0)	1750	14	13.19	0	13.84	0
		1732.5	14	13.02	0	13.11	0
		1715	14	13.15	0	13.34	0
	25RB High (25)	1750	14	12.97	0	12.93	0
		1732.5	14	13.32	0	13.30	0
		1715	14	13.56	0	13.54	0
	25RB Middle (12)	1750	14	13.09	0	13.13	0
		1732.5	14	13.29	0	13.29	0
		1715	14	13.54	0	13.69	0
	25RB Low (0)	1750	14	13.07	0	13.04	0
		1732.5	14	13.22	0	13.13	0
		1715	14	13.50	0	13.57	0
50RB (0)	1750	14	12.98	0	12.93	0	
	1732.5	14	13.22	0	13.12	0	
	1715	14	13.53	0	13.54	0	
15 MHz	1RB High (74)	1747.5	14	13.08	0	13.26	0
		1732.5	14	13.23	0	13.76	0
		1717.5	14	13.11	0	13.57	0
	1RB Middle (37)	1747.5	14	13.59	0	13.77	0
		1732.5	14	13.16	0	13.73	0
1717.5	14	13.27	0	13.98	0		

	1RB Low (0)	1747.5	14	13.36	0	13.46	0
		1732.5	14	13.01	0	13.56	0
		1717.5	14	13.20	0	13.87	0
	36RB High (38)	1747.5	14	13.07	0	13.02	0
		1732.5	14	13.28	0	13.25	0
		1717.5	14	13.31	0	13.28	0
	36RB Middle (19)	1747.5	14	13.15	0	13.17	0
		1732.5	14	13.22	0	13.18	0
		1717.5	14	13.43	0	13.51	0
	36RB Low (0)	1747.5	14	13.13	0	13.01	0
		1732.5	14	13.14	0	13.01	0
		1717.5	14	13.55	0	13.49	0
	75RB (0)	1747.5	14	12.99	0	12.96	0
		1732.5	14	13.10	0	13.08	0
		1717.5	14	13.45	0	13.41	0
20 MHz	1RB High (99)	1745	14	12.95	0	13.17	0
		1732.5	14	13.15	0	13.40	0
		1720	14	12.83	0	12.96	0
	1RB Middle (50)	1745	14	13.63	0	13.85	0
		1732.5	14	13.23	0	13.51	0
		1720	14	13.34	0	13.61	0
	1RB Low (0)	1745	14	12.89	0	13.05	0
		1732.5	14	12.87	0	13.05	0
		1720	14	13.04	0	13.29	0
	50RB High (50)	1745	14	12.87	0	12.84	0
		1732.5	14	13.13	0	13.11	0
		1720	14	13.04	0	12.93	0
	50RB Middle (25)	1745	14	13.12	0	13.19	0
		1732.5	14	13.15	0	13.15	0
		1720	14	13.20	0	13.32	0
	50RB Low (0)	1745	14	12.99	0	12.97	0
		1732.5	14	12.97	0	12.87	0
		1720	14	13.29	0	13.27	0
	100RB (0)	1745	14	12.99	0	12.98	0
		1732.5	14	12.92	0	12.91	0
		1720	14	13.03	0	13.04	0
Band 5							
Bandwidth (MHz)	RB allocation	Frequency (MHz)	Max. Target Power (dBm)	QPSK		16QAM	
	RB offset (Start RB)			Actual output power (dBm)	MPR	Actual output power (dBm)	MPR
1.4 MHz	1RB High (5)	848.3	21	20.30	0	20.92	0
		836.5	21	20.46	0	20.64	0
		824.7	21	20.40	0	20.85	0
	1RB Middle (3)	848.3	21	20.47	0	20.96	0
		836.5	21	20.66	0	20.78	0
		824.7	21	20.54	0	20.83	0

	1RB Low (0)	848.3	21	20.42	0	20.81	0	
		836.5	21	20.52	0	20.61	0	
		824.7	21	20.55	0	20.97	0	
	3RB High (3)	848.3	21	20.41	0	20.45	0	
		836.5	21	20.62	0	20.71	0	
		824.7	21	20.62	0	20.48	0	
	3RB Middle (1)	848.3	21	20.40	0	20.46	0	
		836.5	21	20.57	0	20.53	0	
		824.7	21	20.58	0	20.65	0	
	3RB Low (0)	848.3	21	20.47	0	20.50	0	
		836.5	21	20.52	0	20.57	0	
		824.7	21	20.70	0	20.47	0	
	6RB (0)	848.3	21	20.37	0	19.36	0	
		836.5	21	20.48	0	19.46	0	
		824.7	21	20.51	0	19.29	0	
3 MHz	1RB High (14)	847.5	21	20.37	0	20.52	0	
		836.5	21	20.49	0	20.64	0	
		825.5	21	20.34	0	20.43	0	
	1RB Middle (7)	847.5	21	20.37	0	20.69	0	
		836.5	21	20.66	0	20.78	0	
		825.5	21	20.32	0	20.43	0	
	1RB Low (0)	847.5	21	20.34	0	20.44	0	
		836.5	21	20.61	0	20.70	0	
		825.5	21	20.42	0	20.54	0	
	8RB High (7)	847.5	21	20.46	0	19.59	0	
		836.5	21	20.55	0	19.57	0	
		825.5	21	20.55	0	19.48	0	
	8RB Middle (4)	847.5	21	20.46	0	19.61	0	
		836.5	21	20.45	0	19.60	0	
		825.5	21	20.54	0	19.51	0	
	8RB Low (0)	847.5	21	20.33	0	19.56	0	
		836.5	21	20.53	0	19.67	0	
		825.5	21	20.46	0	19.51	0	
	15RB (0)	847.5	21	20.47	0	19.49	0	
		836.5	21	20.49	0	19.50	0	
		825.5	21	20.45	0	19.66	0	
	5 MHz	1RB High (24)	846.5	21	20.27	0	20.18	0
			836.5	21	20.37	0	20.60	0
			826.5	21	20.45	0	20.79	0
1RB Middle (12)		846.5	21	20.33	0	20.47	0	
		836.5	21	20.50	0	20.76	0	
		826.5	21	20.48	0	20.75	0	
1RB Low (0)		846.5	21	20.08	0	20.34	0	
		836.5	21	20.54	0	20.87	0	
		826.5	21	20.58	0	20.99	0	
12RB High (13)		846.5	21	20.48	0	19.45	0	
		836.5	21	20.53	0	19.53	0	
		826.5	21	20.55	0	19.66	0	
12RB	846.5	21	20.35	0	19.28	0		

	Middle (6)	836.5	21	20.49	0	19.61	0	
		826.5	21	20.42	0	19.53	0	
		846.5	21	20.19	0	19.43	0	
	12RB Low (0)	836.5	21	20.55	0	19.57	0	
		826.5	21	20.43	0	19.54	0	
		846.5	21	20.29	0	19.37	0	
	25RB (0)	836.5	21	20.50	0	19.62	0	
		826.5	21	20.51	0	19.55	0	
		844.0	21	20.44	0	20.69	0	
10 MHz	1RB High (49)	836.5	21	20.35	0	20.82	0	
		829.0	21	20.37	0	20.32	0	
		844.0	21	20.47	0	20.87	0	
	1RB Middle (24)	836.5	21	20.48	0	20.77	0	
		829.0	21	20.38	0	20.32	0	
		844.0	21	20.33	0	20.71	0	
	1RB Low (0)	836.5	21	20.38	0	20.87	0	
		829.0	21	20.17	0	20.17	0	
		844.0	21	20.51	0	19.57	0	
	25RB High (25)	836.5	21	20.58	0	19.51	0	
		829.0	21	20.51	0	19.43	0	
		844.0	21	20.30	0	19.49	0	
	25RB Middle (12)	836.5	21	20.35	0	19.36	0	
		829.0	21	20.28	0	19.42	0	
		844.0	21	20.33	0	19.49	0	
	25RB Low (0)	836.5	21	20.45	0	19.51	0	
		829.0	21	20.30	0	19.44	0	
		844.0	21	20.43	0	19.49	0	
	50RB (0)	836.5	21	20.47	0	19.37	0	
		829.0	21	20.31	0	19.41	0	
		844.0	21	20.43	0	19.49	0	
	Band 7							
	Bandwidth (MHz)	RB allocation	Frequency (MHz)	Max. Target Power (dBm)	QPSK		16QAM	
		RB offset (Start RB)			Actual output power (dBm)	MPR	Actual output power (dBm)	MPR
	5 MHz	1RB High (24)	2567.5	13	12.35	0	12.63	0
			2535	13	12.31	0	12.63	0
			2502.5	13	12.25	0	12.35	0
1RB Middle (12)		2567.5	13	12.51	0	12.80	0	
		2535	13	12.41	0	12.76	0	
		2502.5	13	12.45	0	12.51	0	
1RB Low (0)		2567.5	13	12.22	0	12.50	0	
		2535	13	12.04	0	12.38	0	
		2502.5	13	12.09	0	12.15	0	
12RB High (13)		2567.5	13	11.90	0	12.09	0	
		2535	13	12.39	0	12.56	0	
		2502.5	13	12.29	0	12.45	0	



	12RB Middle (6)	2567.5	13	11.90	0	12.11	0
		2535	13	12.38	0	12.56	0
		2502.5	13	12.39	0	12.51	0
	12RB Low (0)	2567.5	13	11.81	0	12.01	0
		2535	13	12.16	0	12.37	0
		2502.5	13	12.23	0	12.36	0
	25RB (0)	2567.5	13	11.82	0	11.95	0
		2535	13	12.31	0	12.41	0
		2502.5	13	12.16	0	12.25	0
10 MHz	1RB High (49)	2565	13	11.67	0	11.85	0
		2535	13	11.71	0	11.92	0
		2505	13	11.69	0	11.92	0
	1RB Middle (24)	2565	13	12.39	0	12.56	0
		2535	13	12.31	0	12.54	0
		2505	13	12.28	0	12.52	0
	1RB Low (0)	2565	13	11.35	0	11.57	0
		2535	13	11.32	0	11.54	0
		2505	13	11.43	0	11.60	0
	25RB High (25)	2565	13	11.67	0	11.76	0
		2535	13	12.22	0	12.28	0
		2505	13	12.28	0	12.35	0
	25RB Middle (12)	2565	13	11.84	0	11.93	0
		2535	13	12.33	0	12.40	0
		2505	13	12.39	0	12.46	0
	25RB Low (0)	2565	13	11.45	0	11.54	0
		2535	13	11.88	0	11.96	0
		2505	13	11.98	0	12.04	0
50RB (0)	2565	13	11.52	0	11.61	0	
	2535	13	12.12	0	12.18	0	
	2505	13	12.08	0	12.17	0	
15 MHz	1RB High (74)	2562.5	13	11.82	0	12.00	0
		2535	13	11.87	0	12.12	0
		2507.5	13	11.92	0	12.18	0
	1RB Middle (37)	2562.5	13	12.19	0	12.34	0
		2535	13	12.27	0	12.50	0
		2507.5	13	12.37	0	12.62	0
	1RB Low (0)	2562.5	13	11.54	0	11.77	0
		2535	13	11.37	0	11.59	0
		2507.5	13	11.65	0	11.81	0
	36RB High (38)	2562.5	13	11.78	0	11.84	0
		2535	13	12.37	0	12.43	0
		2507.5	13	12.48	0	12.57	0
	36RB Middle (19)	2562.5	13	11.84	0	11.94	0
		2535	13	12.37	0	12.45	0
		2507.5	13	12.42	0	12.53	0
	36RB Low (0)	2562.5	13	11.52	0	11.66	0
		2535	13	11.95	0	12.05	0
		2507.5	13	12.15	0	12.25	0

	75RB (0)	2562.5	13	11.67	0	11.77	0
		2535	13	12.08	0	12.17	0
		2507.5	13	12.23	0	12.33	0
20 MHz	1RB High (99)	2560	13	11.56	0	11.75	0
		2535	13	11.69	0	11.93	0
		2510	13	11.48	0	11.75	0
	1RB Middle (50)	2560	13	12.23	0	12.46	0
		2535	13	12.33	0	12.57	0
		2510	13	12.52	0	12.78	0
	1RB Low (0)	2560	13	11.44	0	11.72	0
		2535	13	11.16	0	11.43	0
		2510	13	11.33	0	11.52	0
	50RB High (50)	2560	13	11.64	0	11.70	0
		2535	13	12.29	0	12.34	0
		2510	13	12.22	0	12.32	0
	50RB Middle (25)	2560	13	11.74	0	11.83	0
		2535	13	12.35	0	12.41	0
		2510	13	12.47	0	12.55	0
	50RB Low (0)	2560	13	11.57	0	11.70	0
		2535	13	11.80	0	11.87	0
		2510	13	12.03	0	12.10	0
	100RB (0)	2560	13	11.63	0	11.71	0
		2535	13	12.02	0	12.10	0
		2510	13	12.10	0	12.17	0
Band 38							
Bandwidth (MHz)	RB allocation	Frequency (MHz)	Max. Target Power (dBm)	QPSK		16QAM	
	RB offset (Start RB)			Actual output power (dBm)	MPR	Actual output power (dBm)	MPR
5 MHz	1RB High (24)	2617.5	18.5	17.26	0	17.57	0
		2595	18.5	17.24	0	17.65	0
		2572.5	18.5	17.65	0	17.77	0
	1RB Middle (12)	2617.5	18.5	17.34	0	17.82	0
		2595	18.5	17.42	0	17.89	0
		2572.5	18.5	17.71	0	18.01	0
	1RB Low (0)	2617.5	18.5	17.29	0	17.51	0
		2595	18.5	17.33	0	17.82	0
		2572.5	18.5	17.46	0	17.85	0
	12RB High (13)	2617.5	18.5	17.45	0	17.58	0
		2595	18.5	17.66	0	17.68	0
		2572.5	18.5	17.64	0	17.78	0
	12RB Middle (6)	2617.5	18.5	17.42	0	17.43	0
		2595	18.5	17.63	0	17.74	0
		2572.5	18.5	17.68	0	17.74	0
12RB Low (0)	2617.5	18.5	17.46	0	17.46	0	
	2595	18.5	17.66	0	17.78	0	
	2572.5	18.5	17.60	0	17.66	0	

	25RB (0)	2617.5	18.5	17.45	0	17.51	0	
		2595	18.5	17.64	0	17.59	0	
		2572.5	18.5	17.75	0	17.68	0	
10 MHz	1RB High (49)	2615	18.5	17.65	0	17.92	0	
		2595	18.5	17.73	0	18.09	0	
		2575	18.5	17.75	0	18.17	0	
	1RB Middle (24)	2615	18.5	17.62	0	18.04	0	
		2595	18.5	17.95	0	18.10	0	
		2575	18.5	18.06	0	18.32	0	
	1RB Low (0)	2615	18.5	17.63	0	17.56	0	
		2595	18.5	17.83	0	18.06	0	
		2575	18.5	17.73	0	18.16	0	
	25RB High (25)	2615	18.5	17.58	0	17.61	0	
		2595	18.5	17.60	0	17.50	0	
		2575	18.5	17.70	0	17.55	0	
	25RB Middle (12)	2615	18.5	17.55	0	17.57	0	
		2595	18.5	17.64	0	17.57	0	
		2575	18.5	17.66	0	17.63	0	
	25RB Low (0)	2615	18.5	17.42	0	17.45	0	
		2595	18.5	17.59	0	17.59	0	
		2575	18.5	17.62	0	17.59	0	
	50RB (0)	2615	18.5	17.46	0	17.49	0	
		2595	18.5	17.62	0	17.65	0	
		2575	18.5	17.72	0	17.82	0	
	15 MHz	1RB High (74)	2612.5	18.5	17.46	0	17.99	0
			2595	18.5	17.73	0	18.06	0
			2577.5	18.5	17.84	0	18.28	0
1RB Middle (37)		2612.5	18.5	17.53	0	17.57	0	
		2595	18.5	17.67	0	17.72	0	
		2577.5	18.5	17.76	0	18.09	0	
1RB Low (0)		2612.5	18.5	17.71	0	18.07	0	
		2595	18.5	17.96	0	18.29	0	
		2577.5	18.5	17.71	0	17.78	0	
36RB High (38)		2612.5	18.5	17.43	0	17.56	0	
		2595	18.5	17.60	0	17.64	0	
		2577.5	18.5	17.77	0	17.78	0	
36RB Middle (19)		2612.5	18.5	17.48	0	17.60	0	
		2595	18.5	17.65	0	17.68	0	
		2577.5	18.5	17.63	0	17.70	0	
36RB Low (0)		2612.5	18.5	17.42	0	17.56	0	
		2595	18.5	17.62	0	17.74	0	
		2577.5	18.5	17.63	0	17.68	0	
75RB (0)		2612.5	18.5	17.41	0	17.56	0	
		2595	18.5	17.58	0	17.71	0	
		2577.5	18.5	17.72	0	17.71	0	
20 MHz		1RB High (99)	2610	18.5	17.26	0	17.01	0
			2595	18.5	17.48	0	17.17	0
			2580	18.5	17.52	0	17.23	0

	1RB Middle (50)	2610	18.5	17.73	0	17.25	0
		2595	18.5	18.02	0	17.35	0
		2580	18.5	18.33	0	17.47	0
	1RB Low (0)	2610	18.5	17.42	0	17.13	0
		2595	18.5	17.62	0	17.35	0
		2580	18.5	17.43	0	17.16	0
	50RB High (50)	2610	18.5	17.45	0	17.43	0
		2595	18.5	17.60	0	17.66	0
		2580	18.5	17.67	0	17.74	0
	50RB Middle (25)	2610	18.5	17.47	0	17.61	0
		2595	18.5	17.61	0	17.65	0
		2580	18.5	17.88	0	17.66	0
	50RB Low (0)	2610	18.5	17.43	0	17.56	0
		2595	18.5	17.59	0	17.62	0
		2580	18.5	17.65	0	17.68	0
	100RB (0)	2610	18.5	17.45	0	17.38	0
		2595	18.5	17.62	0	17.55	0
		2580	18.5	17.77	0	17.56	0

11.4 Wi-Fi and BT Measurement result

The output power of BT antenna is as following:

Mode	Conducted Power (dBm)		
	Channel 0 (2402MHz)	Channel 39 (2441MHz)	Channel 78(2480MHz)
GFSK	3.97	5.57	3.31
EDR2M-4_DQPSK	4.75	6.39	4.07
EDR3M-8DPSK	4.20	5.79	3.50
Tune up	5	7	5

The average conducted power for Wi-Fi is as following:

Normal Power – Proximity sensor not active

802.11b (dBm)

Channel\data rate	1Mbps	2Mbps	5.5Mbps	11Mbps
1	15.34	/	/	/
6	15.69	15.55	15.32	15.06
11	15.57	/	/	/
Tune up	16	16	16	16

802.11g (dBm)

Channel\data rate	6Mbps	9Mbps	12Mbps	18Mbps	24Mbps	36Mbps	48Mbps	54Mbps
1	13.86	13.64	13.44	13.08	12.74	12.17	11.68	11.52
6	13.85	/	/	/	/	/	/	/
11	13.18	/	/	/	/	/	/	/
Tune up	15	15	15	15	14	14	13	13



802.11n (dBm) - HT20 (2.4G)

Channel\data rate	MCS0	MCS1	MCS2	MCS3	MCS4	MCS5	MCS6	MCS7
1	13.95	13.49	13.13	12.77	12.24	11.80	11.63	11.43
6	13.92	/	/	/	/	/	/	/
11	13.21	/	/	/	/	/	/	/
Tune up	15	15	15	14	14	13	13	13

Low Power – Proximity sensor active

802.11b (dBm)

Channel\data rate	1Mbps	2Mbps	5.5Mbps	11Mbps
1	8.69	8.57	8.35	8.12
6	8.58	/	/	/
11	7.78	/	/	/
Tune up	9	9	9	9

802.11g (dBm)

Channel\data rate	6Mbps	9Mbps	12Mbps	18Mbps	24Mbps	36Mbps	48Mbps	54Mbps
1	7.47	7.26	7.07	6.71	6.36	5.80	5.32	5.16
6	7.08	/	/	/	/	/	/	/
11	6.51	/	/	/	/	/	/	/
Tune up	8	8	8	8	7	7	7	7

802.11n (dBm) - HT20 (2.4G)

Channel\data rate	MCS0	MCS1	MCS2	MCS3	MCS4	MCS5	MCS6	MCS7
1	7.50	7.08	6.73	6.38	5.86	5.42	5.24	5.07
6	7.06	/	/	/	/	/	/	/
11	6.51	/	/	/	/	/	/	/
Tune up	8	8	8	8	7	7	7	7

12 Simultaneous TX SAR Considerations

12.1 Introduction

The following procedures adopted from “FCC SAR Considerations for Cell Phones with Multiple Transmitters” are applicable to handsets with built-in unlicensed transmitters such as 802.11 a/b/g and Bluetooth devices which may simultaneously transmit with the licensed transmitter.

For this device, the BT and Wi-Fi can transmit simultaneous with other transmitters.

12.2 Transmit Antenna Separation Distances

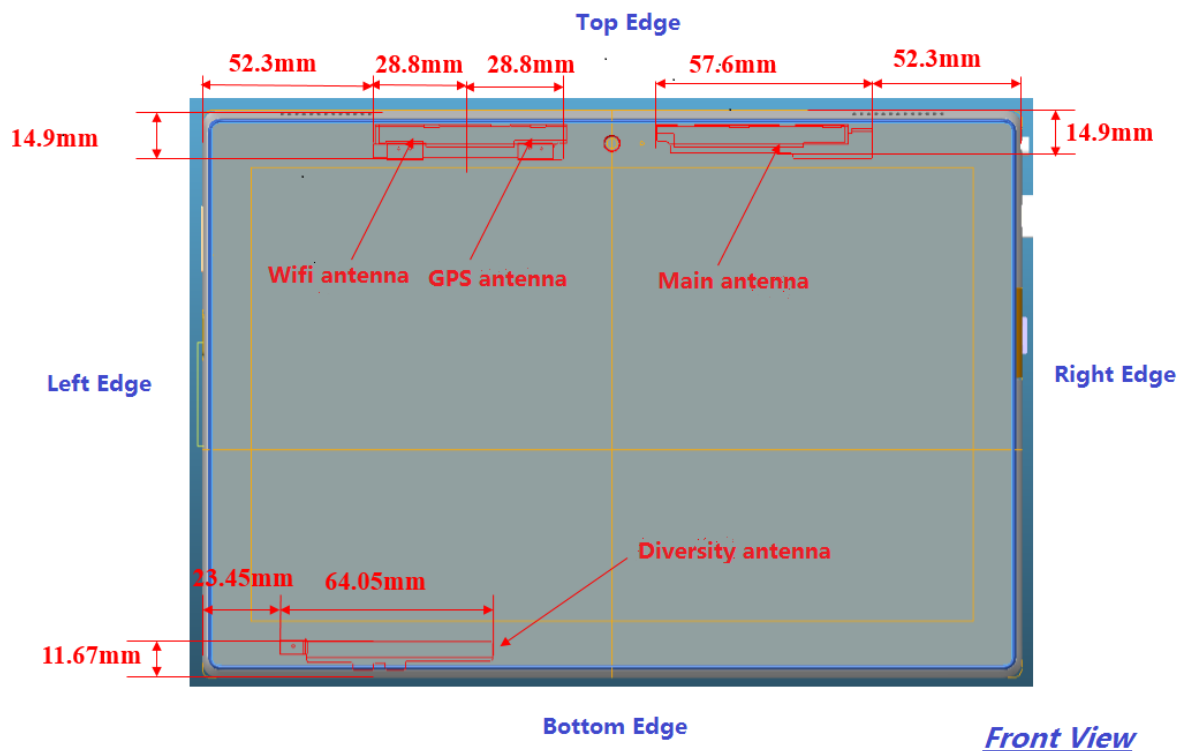

Picture 12.1 Antenna Locations

12.3 SAR Measurement Positions

According to the KDB941225 D06 Hot Spot SAR v01, the edges with less than 2.5 cm distance to the antennas need to be tested for SAR.

SAR measurement positions						
Mode	Front	Rear	Left edge	Right edge	Top edge	Bottom edge
Main antenna	No	Yes	No	No	Yes	No
WLAN	No	Yes	No	No	Yes	No

12.4 Standalone SAR Test Exclusion Considerations

Standalone 1-g head or body SAR evaluation by measurement or numerical simulation is not required when the corresponding SAR Exclusion Threshold condition, listed below, is satisfied. The 1-g SAR test exclusion threshold for 100 MHz to 6 GHz at test separation distances ≤ 50 mm are determined by:

$[(\text{max. power of channel, including tune-up tolerance, mW}) / (\text{min. test separation distance, mm})] \cdot [\sqrt{f(\text{GHz})}] \leq 3.0$ for 1-g SAR, where

- $f(\text{GHz})$ is the RF channel transmit frequency in GHz
- Power and distance are rounded to the nearest mW and mm before calculation
- The result is rounded to one decimal place for comparison

Table 12.1: Standalone SAR test exclusion considerations

Band/Mode	F(GHz)	Position	SAR test exclusion threshold(mW)	RF output power		SAR test exclusion
				dBm	mW	
Bluetooth	2.441	Body	19.20	7	5.01	Yes
2.4GHz WLAN	2.45	Body	19.17	16	39.81	No

13 Evaluation of Simultaneous

Table 13.1: The sum of reported SAR values for main antenna and WiFi

	Position	Main antenna	WiFi	Sum
Highest reported SAR value for Body	Rear 0mm	1.10	0.31	1.41
	Rear 13mm	1.28	0.03	1.31

Table 13.2: The sum of reported SAR values for main antenna and BT

	Position	Main antenna	BT	Sum
Maximum reported SAR value for Body	Rear 0mm	1.10	0.21 ^[1]	1.31
	Rear 13mm	1.28	0.08 ^[1]	1.36

[1] - Estimated SAR for Bluetooth (see the table 13.3)

Table 13.3: Estimated SAR for Bluetooth

Mode/Band	F (GHz)	Position	Distance (mm)	Upper limit of power *		Estimated _{1g} (W/kg)
				dBm	mW	
Bluetooth	2.441	Body	5	7	5.01	0.21
			13	7	5.01	0.08

* - Maximum possible output power declared by manufacturer

When standalone SAR test exclusion applies to an antenna that transmits simultaneously with other antennas, the standalone SAR must be estimated according to following to determine simultaneous transmission SAR test exclusion:

(max. power of channel, including tune-up tolerance, mW)/(min. test separation distance,mm)]·[√f(GHz)/x] W/kg for test separation distances ≤ 50 mm;
where x = 7.5 for 1-g SAR.

When the minimum test separation distance is < 5 mm, a distance of 5 mm is applied to determine SAR test exclusion

Conclusion:

According to the above tables, the sum of reported SAR values is<1.6W/kg. So the simultaneous transmission SAR with volume scans is not required.

14 SAR Test Result

It is determined by KDB 616217 D04 for the distance between the EUT and the phantom bottom (0mm and 13mm).

It is performed for all SAR measurements with area scan based 1-g SAR estimation (Fast SAR). A zoom scan measurement is added when the estimated 1-gSAR is the highest measured SAR in each exposure configuration, wireless mode and frequency band combination or more than 1.2W/kg.

The calculated SAR is obtained by the following formula:

$$\text{Reported SAR} = \text{Measured SAR} \times 10^{(P_{\text{Target}} - P_{\text{Measured}})/10}$$

Where P_{Target} is the power of manufacturing upper limit;

P_{Measured} is the measured power in chapter 11.

Table 14.1: Duty Cycle

Mode	Duty Cycle
GPRS&EGPRS for GSM850 with Normal power	1:2.67
GPRS&EGPRS for GSM1900 with Normal power	1:2
GPRS&EGPRS for GSM850/1900 with Low power	1:2
WCDMA<E FDD	1:1
LTE TDD	1:1.58

14.1 SAR results for Fast SAR

Table 14.1-1: SAR Values (GSM 850 MHz Band - Body)

Frequency		Mode (number of timeslots)	Test Position	Figure No./Note	Conducted Power (dBm)	Max. tune-up Power (dBm)	Ambient Temperature: 22.9°C		Liquid Temperature: 22.5°C		Power Drift (dB)
Ch.	MHz						Measured SAR(10g) (W/kg)	Reported SAR(10g) (W/kg)	Measured SAR(1g) (W/kg)	Reported SAR(1g) (W/kg)	
251	848.8	GPRS (4)	Rear 0mm	Fig.1	24.39	25.5	0.329	0.42	0.606	0.78	0.06
190	836.6	GPRS (4)	Rear 0mm	/	24.43	25.5	0.301	0.39	0.563	0.72	0.08
128	824.2	GPRS (4)	Rear 0mm	/	24.42	25.5	0.261	0.33	0.529	0.68	0.11
190	836.6	GPRS (4)	Top 0mm	/	24.43	25.5	0.202	0.26	0.382	0.49	0.01
190	836.6	GPRS (3)	Rear 13mm	/	29.63	30	0.252	0.27	0.429	0.47	0.04
190	836.6	GPRS (3)	Top 13mm	/	29.63	30	0.131	0.14	0.211	0.23	-0.06
251	848.8	EGPRS (4)	Rear 0mm	/	24.39	25.5	0.299	0.39	0.586	0.76	0.18
251	848.8	GPRS (4)	Rear 0mm	SKU14	24.39	25.5	0.280	0.36	0.572	0.74	-0.07

Table 14.1-2: SAR Values (GSM 1900 MHz Band - Body)

Frequency		Mode (number of timeslots)	Test Position	Figure No./Note	Conducted Power (dBm)	Max. tune-up Power (dBm)	Ambient Temperature: 22.9 °C		Liquid Temperature: 22.5 °C		Power Drift (dB)
Ch.	MHz						Measured SAR(10g) (W/kg)	Reported SAR(10g) (W/kg)	Measured SAR(1g) (W/kg)	Reported SAR(1g) (W/kg)	
810	1909.8	GPRS (4)	Rear 0mm	/	15.74	17	0.388	0.52	0.785	1.05	-0.01
661	1880	GPRS (4)	Rear 0mm	/	15.79	17	0.377	0.50	0.805	1.06	0.03
512	1850.2	GPRS (4)	Rear 0mm	Fig.2	15.84	17	0.385	0.50	0.812	1.06	0.11
661	1880	GPRS (4)	Top 0mm	/	15.69	17	0.271	0.37	0.535	0.72	0.09
661	1880	GPRS (4)	Rear 13mm	/	25.58	26	0.217	0.24	0.362	0.40	0.05
661	1880	GPRS (4)	Top 13mm	/	25.58	26	0.228	0.25	0.383	0.42	-0.07
512	1850.2	EGPRS (4)	Rear 0mm	/	15.85	17	0.378	0.49	0.799	1.04	0.09
512	1850.2	GPRS (4)	Rear 0mm	SKU14	15.84	17	0.308	0.40	0.554	0.72	0.12

Table 14.1-3: SAR Values (WCDMA 850 MHz Band - Body)

Frequency		Test Position	Figure No./Note	Conducted Power (dBm)	Max. tune-up Power (dBm)	Ambient Temperature: 22.9 °C		Liquid Temperature: 22.5 °C		Power Drift (dB)
Ch.	MHz					Measured SAR(10g) (W/kg)	Reported SAR(10g) (W/kg)	Measured SAR(1g) (W/kg)	Reported SAR(1g) (W/kg)	
4233	846.6	Rear 0mm	/	19.62	20	0.339	0.37	0.617	0.67	-0.03
4182	836.4	Rear 0mm	/	19.74	20	0.341	0.36	0.620	0.66	0.16
4132	826.4	Rear 0mm	/	19.80	20	0.352	0.37	0.654	0.68	-0.02
4182	836.4	Top 0mm	/	19.74	20	0.174	0.18	0.319	0.34	0.11
4182	836.4	Rear 13mm	/	21.95	23	0.261	0.33	0.421	0.54	0.11
4182	836.4	Top 13mm	/	21.95	23	0.089	0.11	0.137	0.17	-0.09
4233	846.6	Rear 0mm	SKU14	19.62	20	0.361	0.39	0.656	0.72	0.05
4182	836.4	Rear 0mm	SKU14	19.74	20	0.368	0.39	0.666	0.71	-0.11
4132	826.4	Rear 0mm	Fig.3 SKU14	19.80	20	0.379	0.40	0.695	0.73	0.00

Table 14.1-4: SAR Values (WCDMA 1900 MHz Band - Body)

Frequency		Test Position	Figure No./Note	Conducted Power (dBm)	Max. tune-up Power (dBm)	Ambient Temperature: 22.9 °C		Liquid Temperature: 22.5 °C		Power Drift (dB)
Ch.	MHz					Measured SAR(10g) (W/kg)	Reported SAR(10g) (W/kg)	Measured SAR(1g) (W/kg)	Reported SAR(1g) (W/kg)	
9800	1880	Rear 0mm	/	12.25	13	0.252	0.30	0.491	0.58	0.07
9800	1880	Top 0mm	/	12.25	13	0.241	0.29	0.549	0.65	0.14
9938	1907.6	Rear 13mm	/	22.01	23	0.455	0.57	0.845	1.06	0.04
9800	1880	Rear 13mm	/	21.99	23	0.384	0.48	0.712	0.90	0.01
9662	1852.4	Rear 13mm	/	22.03	23	0.451	0.56	0.843	1.05	0.05
9938	1907.6	Top 13mm	Fig.4	22.01	23	0.500	0.63	0.882	1.11	-0.04
9800	1880	Top 13mm	/	21.99	23	0.396	0.50	0.733	0.92	0.09
9662	1852.4	Top 13mm	/	22.03	23	0.428	0.54	0.762	0.95	-0.11
9938	1907.6	Top 13mm	SKU14	22.01	23	0.495	0.62	0.863	1.08	-0.03

Table 14.1-5: SAR Values (LTE Band2 - Body)

Frequency		Mode	Test Position	Figure No./ Note	Ambient Temperature: 22.9 °C		Liquid Temperature: 22.5 °C				Power Drift (dB)
Ch.	MHz				Conducted Power (dBm)	Max. tune-up Power (dBm)	Measured SAR(10g) (W/kg)	Reported SAR(10g) (W/kg)	Measured SAR(1g) (W/kg)	Reported SAR(1g) (W/kg)	
18700	1860	1RB_Mid	Rear 0mm	/	14.76	15	0.265	0.28	0.528	0.56	0.08
18700	1860	1RB_Mid	Top 0mm	/	14.76	15	0.274	0.29	0.565	0.60	0.05
18700	1860	50RB_High	Rear 0mm	/	14.97	15	0.308	0.31	0.615	0.62	0.16
18700	1860	50RB_High	Top 0mm	/	14.97	15	0.261	0.26	0.538	0.54	-0.05
19100	1900	1RB_Mid	Rear 13mm	/	23.00	23	0.424	0.42	0.743	0.74	0.13
19100	1900	1RB_Mid	Top 13mm	/	23.00	23	0.485	0.49	0.833	0.83	-0.18
18900	1880	1RB_Mid	Top 13mm	Fig.5	22.65	23	0.539	0.58	0.944	1.02	-0.02
18700	1860	1RB_High	Top 13mm		22.62	23	0.478	0.52	0.851	0.93	0.07
18700	1860	50RB_High	Rear 13mm	/	21.58	22	0.359	0.40	0.631	0.70	0.14
18700	1860	50RB_High	Top 13mm	/	21.58	22	0.390	0.43	0.659	0.73	0.05
18700	1860	100RB	Top 13mm	/	21.51	22	0.408	0.46	0.635	0.71	-0.09
18900	1880	1RB_Mid	Top 13mm	SKU14	23.00	23	0.437	0.44	0.754	0.75	-0.11

Note: The LTE mode is QPSK_20MHz.

Table 14.1-6: SAR Values (LTE Band4 - Body)

Frequency		Mode	Test Position	Figure No./ Note	Ambient Temperature: 22.9 °C		Liquid Temperature: 22.5 °C				Power Drift (dB)
Ch.	MHz				Conducted Power (dBm)	Max. tune-up Power (dBm)	Measured SAR(10g) (W/kg)	Reported SAR(10g) (W/kg)	Measured SAR(1g) (W/kg)	Reported SAR(1g) (W/kg)	
20300	1745	1RB_Mid	Rear 0mm	/	13.63	14	0.401	0.44	0.851	0.93	-0.05
20175	1732.5	1RB_Mid	Rear 0mm	/	13.23	14	0.406	0.48	0.857	1.02	-0.07
20050	1720	1RB_Mid	Rear 0mm	/	13.34	14	0.386	0.45	0.817	0.95	0.05
20300	1745	1RB_Mid	Top 0mm	/	13.63	14	0.230	0.25	0.501	0.55	-0.04
20300	1745	50RB_Mid	Rear 0mm	/	13.12	14	0.360	0.44	0.774	0.95	0.09
20175	1732.5	50RB_Mid	Rear 0mm	/	13.15	14	0.377	0.46	0.813	0.99	0.08
20050	1720	50RB_Low	Rear 0mm	/	13.29	14	0.368	0.43	0.787	0.93	0.11
20050	1720	50RB_Low	Top 0mm	/	13.29	14	0.218	0.26	0.478	0.56	0.03
20300	1745	1RB_Mid	Rear 13mm	Fig.6	21.93	22.5	0.603	0.69	1.12	1.28	0.08
20175	1732.5	1RB_High	Rear 13mm	/	21.45	22.5	0.453	0.58	0.843	1.07	0.08
20050	1720	1RB_Mid	Rear 13mm	/	21.86	22.5	0.418	0.48	0.766	0.89	0.03
20300	1745	1RB_Mid	Top 13mm	/	21.93	22.5	0.544	0.62	0.972	1.11	0.05
20175	1732.5	1RB_High	Top 13mm	/	21.45	22.5	0.526	0.67	0.937	1.19	-0.04
20050	1720	1RB_Mid	Top 13mm	/	21.86	22.5	0.484	0.56	0.867	1.00	-0.08
20300	1745	50RB_Mid	Rear 13mm	/	20.66	21.5	0.500	0.61	0.935	1.13	-0.09
20175	1732.5	50RB_Mid	Rear 13mm	/	20.57	21.5	0.540	0.67	0.993	1.23	0.04
20050	1720	50RB_Mid	Rear 13mm	/	20.55	21.5	0.524	0.65	0.956	1.19	0.11



20300	1745	50RB_Mid	Top 13mm	/	20.66	21.5	0.559	0.68	1.04	1.27	0.04
20175	1732.5	50RB_Mid	Top 13mm	/	20.57	21.5	0.515	0.64	0.964	1.19	-0.11
20050	1720	50RB_Mid	Top 13mm		20.55	21.5	0.455	0.57	0.850	1.06	-0.08
20050	1720	100RB	Rear 0mm		13.03	14	0.372	0.47	0.804	1.01	0.09
20050	1720	100RB	Rear 13mm		20.39	21.5	0.510	0.66	0.932	1.20	0.05
20050	1720	100RB	Top 13mm		20.39	21.5	0.512	0.66	0.901	1.16	-0.03
20300	1745	1RB_Mid	Rear 13mm	SKU14	21.93	22.5	0.428	0.49	0.808	0.92	0.06

Note: The LTE mode is QPSK_20MHz.

Table 14.1-7: SAR Values (LTE Band5 - Body)

Frequency		Mode	Test Position	Figure No. /Note	Ambient Temperature: 22.9°C		Liquid Temperature: 22.5°C		Measured SAR(1g) (W/kg)	Reported SAR(1g) (W/kg)	Power Drift (dB)
Ch.	MHz				Conducted Power (dBm)	Max. tune-up Power (dBm)	Measured SAR(10g) (W/kg)	Reported SAR(10g) (W/kg)			
20600	844	1RB_Mid	Rear 0mm	/	20.47	21	0.379	0.43	0.732	0.83	0.06
20525	836.5	1RB_Mid	Rear 0mm	Fig.7	20.48	21	0.420	0.47	0.811	0.91	-0.09
20450	829	1RB_Mid	Rear 0mm	/	20.38	21	0.400	0.46	0.769	0.89	-0.11
20525	836.5	1RB_Mid	Top 0mm	/	20.48	21	0.253	0.29	0.462	0.52	-0.06
20600	844	25RB_High	Rear 0mm	/	20.51	21	0.373	0.42	0.731	0.82	0.04
20525	836.5	25RB_High	Rear 0mm	/	20.58	21	0.392	0.43	0.767	0.84	0.01
20450	829	25RB_High	Rear 0mm	/	20.51	21	0.391	0.44	0.762	0.85	0.05
20525	836.5	25RB_High	Top 0mm	/	20.58	21	0.241	0.27	0.436	0.48	-0.02
20525	836.5	1RB_Mid	Rear 13mm	/	22.17	23	0.285	0.35	0.477	0.58	0.05
20525	836.5	1RB_Mid	Top 13mm	/	22.17	23	0.094	0.11	0.151	0.18	-0.14
20525	836.5	25RB_High	Rear 13mm	/	21.07	22	0.208	0.26	0.349	0.43	0.03
20525	836.5	25RB_High	Top 13mm	/	21.07	22	0.071	0.09	0.116	0.14	0.08
20525	836.5	100RB	Rear 0mm	/	20.47	21	0.373	0.42	0.727	0.82	-0.09
20525	836.5	1RB_Mid	Rear 0mm	SKU14	20.48	21	0.371	0.42	0.724	0.82	-0.07

Note: The LTE mode is QPSK_10MHz.

Table 14.1-8: SAR Values (LTE Band7 - Body)

Frequency		Mode	Test Position	Figure No. /Note	Ambient Temperature: 22.9 °C		Liquid Temperature: 22.5 °C				Power Drift (dB)
Ch.	MHz				Conducted Power (dBm)	Max. tune-up Power (dBm)	Measured SAR(10g) (W/kg)	Reported SAR(10g) (W/kg)	Measured SAR(1g) (W/kg)	Reported SAR(1g) (W/kg)	
20850	2510	1RB_Mid	Rear 0mm	/	12.52	13	0.256	0.29	0.630	0.70	-0.06
20850	2510	1RB_Mid	Top 0mm	/	12.52	13	0.085	0.09	0.199	0.22	0.03
21350	2560	50RB_Mid	Rear 0mm	/	11.74	13	0.271	0.36	0.593	0.79	-0.07
21100	2535	50RB_Mid	Rear 0mm	/	12.35	13	0.296	0.34	0.648	0.75	0.06
20850	2510	50RB_Mid	Rear 0mm	Fig.8	12.47	13	0.326	0.37	0.752	0.85	-0.03
20850	2510	50RB_Mid	Top 0mm	/	12.47	13	0.088	0.10	0.209	0.24	0.11
21350	2560	1RB_Mid	Rear 13mm	/	22.04	23	0.345	0.43	0.676	0.84	0.09
21100	2535	1RB_Mid	Rear 13mm	/	22.21	23	0.358	0.43	0.682	0.82	0.01
20850	2510	1RB_Mid	Rear 13mm	/	22.02	23	0.321	0.40	0.623	0.78	-0.05
21100	2535	1RB_Mid	Top 13mm	/	22.21	23	0.287	0.34	0.547	0.66	-0.02
21350	2560	50RB_Mid	Rear 13mm	/	20.70	22	0.245	0.33	0.478	0.64	0.12
21350	2560	50RB_Mid	Top 13mm	/	20.70	22	0.210	0.28	0.401	0.54	0.15
20850	2510	100RB	Rear 0mm	/	12.10	13	0.254	0.31	0.598	0.74	0.11
21350	2560	100RB	Rear 13mm	/	20.74	22	0.234	0.31	0.491	0.66	0.10
20850	2510	50RB_Mid	Rear 0mm	SKU14	12.47	13	0.306	0.35	0.719	0.81	0.08

Note: The LTE mode is QPSK_20MHz.

Table 14.1-9: SAR Values (LTE Band38 - Body)

Frequency		Mode	Test Position	Figure No. /Note	Ambient Temperature: 22.9 °C		Liquid Temperature: 22.5 °C				Power Drift (dB)
Ch.	MHz				Conducted Power (dBm)	Max. tune-up Power (dBm)	Measured SAR(10g) (W/kg)	Reported SAR(10g) (W/kg)	Measured SAR(1g) (W/kg)	Reported SAR(1g) (W/kg)	
38150	2610	1RB_Mid	Rear 0mm	/	17.73	18.5	0.361	0.43	0.851	1.02	0.05
38000	2595	1RB_Mid	Rear 0mm	Fig.9	18.02	18.5	0.424	0.47	0.984	1.10	-0.09
37850	2580	1RB_Mid	Rear 0mm	/	18.33	18.5	0.410	0.43	0.952	0.99	0.16
37850	2580	1RB_Mid	Top 0mm	/	18.33	18.5	0.134	0.14	0.269	0.28	-0.09
38150	2610	50RB_Mid	Rear 0mm	/	17.47	18.5	0.355	0.45	0.836	1.06	-0.09
38000	2595	50RB_Mid	Rear 0mm	/	17.61	18.5	0.366	0.45	0.858	1.05	-0.04
37850	2580	50RB_Mid	Rear 0mm	/	17.88	18.5	0.362	0.42	0.856	0.99	-0.07
37850	2580	50RB_Mid	Top 0mm	/	17.88	18.5	0.120	0.14	0.243	0.28	0.09
37850	2580	1RB_Mid	Rear 13mm	/	22.28	23	0.138	0.16	0.241	0.28	0.04
37850	2580	1RB_Mid	Top 13mm	/	22.28	23	0.126	0.15	0.222	0.26	0.05
37850	2580	50RB_High	Rear 13mm	/	21.10	22	0.093	0.11	0.166	0.20	-0.04
37850	2580	50RB_High	Top 13mm	/	21.10	22	0.098	0.12	0.172	0.21	0.07
37850	2580	100RB	Rear 0mm	/	17.77	18.5	0.356	0.42	0.831	0.98	0.05
38000	2595	1RB_Mid	Rear 0mm	SKU14	18.33	18.5	0.289	0.30	0.684	0.71	0.11

Note: The LTE mode is QPSK_20MHz.

Table 14.1-10: SAR Values (WLAN - Body)

Frequency		Test Position	Figure No./Note	Conducted Power (dBm)	Max. tune-up Power (dBm)	Measured SAR(10g) (W/kg)	Reported SAR(10g) (W/kg)	Measured SAR(1g) (W/kg)	Reported SAR(1g) (W/kg)	Power Drift (dB)
Ch.	MHz									
11	2462	Rear 0mm	/	7.78	9	0.079	0.11	0.201	0.27	0.11
6	2437	Rear 0mm	/	8.58	9	0.048	0.05	0.122	0.13	0.05
1	2412	Rear 0mm	Fig.10	8.69	9	0.109	0.12	0.278	0.30	0.14
1	2412	Top 0mm	/	8.69	9	0.016	0.02	0.031	0.03	0.10
6	2437	Rear 13mm	/	15.69	16	0.014	0.02	0.027	0.03	0.15
6	2437	Top 13mm	/	15.69	16	0.011	0.01	0.018	0.02	0.19
1	2412	Rear 0mm	SKU14	8.69	9	0.080	0.09	0.197	0.21	0.19

According to the KDB248227 D01, The reported SAR must be scaled to 100% transmission duty factor to determine compliance at the maximum tune-up tolerance limit. The scaled reported SAR is presented as below.

Table 14.1-11: SAR Values (WLAN - Body) – Scaled Reported SAR

Frequency		Test Position	Actual duty factor	maximum duty factor	Reported SAR (1g)(W/kg)	Scaled reported SAR (1g)(W/kg)
MHz	Ch.					
2412	1	Rear 0mm	97.63%	100%	0.30	0.31

SAR is not required for OFDM because the 802.11b adjusted SAR ≤ 1.2 W/kg.

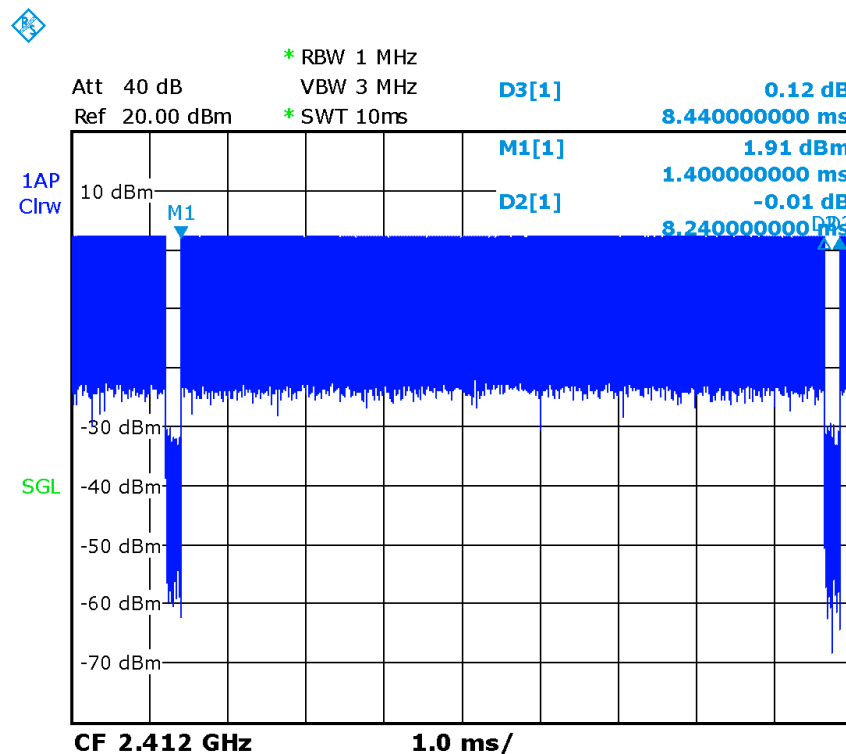

Picture 14.1 Duty factor plot

14.2 SAR results for Standard procedure

There is zoom scan measurement to be added for the highest measured SAR in each exposure configuration/band.

Table 14.2-1: SAR Values (GSM 850 MHz Band - Body)

Ambient Temperature: 22.9 °C					Liquid Temperature: 22.5 °C						
Frequency		Mode (number of timeslots)	Test Position	Figure No./Note	Conducted Power (dBm)	Max. tune-up Power (dBm)	Measured SAR(10g) (W/kg)	Reported SAR(10g) (W/kg)	Measured SAR(1g) (W/kg)	Reported SAR(1g) (W/kg)	Power Drift (dB)
Ch.	MHz										
251	848.8	GPRS (4)	Rear 0mm	Fig.1	24.39	25.5	0.329	0.42	0.606	0.78	0.06

Table 14.2-2: SAR Values (GSM 1900 MHz Band - Body)

Ambient Temperature: 22.9 °C					Liquid Temperature: 22.5 °C						
Frequency		Mode (number of timeslots)	Test Position	Figure No./Note	Conducted Power (dBm)	Max. tune-up Power (dBm)	Measured SAR(10g) (W/kg)	Reported SAR(10g) (W/kg)	Measured SAR(1g) (W/kg)	Reported SAR(1g) (W/kg)	Power Drift (dB)
Ch.	MHz										
512	1850.2	GPRS (4)	Rear 0mm	Fig.2	15.84	17	0.385	0.50	0.812	1.06	0.11

Table 14.2-3: SAR Values (WCDMA 850 MHz Band - Body)

Ambient Temperature: 22.9 °C					Liquid Temperature: 22.5 °C					
Frequency		Test Position	Figure No./Note	Conducted Power (dBm)	Max. tune-up Power (dBm)	Measured SAR(10g) (W/kg)	Reported SAR(10g) (W/kg)	Measured SAR(1g) (W/kg)	Reported SAR(1g) (W/kg)	Power Drift (dB)
Ch.	MHz									
4132	826.4	Rear 0mm	Fig.3 SKU14	19.80	20	0.379	0.40	0.695	0.73	0.00

Table 14.2-4: SAR Values (WCDMA 1900 MHz Band - Body)

Ambient Temperature: 22.9 °C					Liquid Temperature: 22.5 °C					
Frequency		Test Position	Figure No./Note	Conducted Power (dBm)	Max. tune-up Power (dBm)	Measured SAR(10g) (W/kg)	Reported SAR(10g) (W/kg)	Measured SAR(1g) (W/kg)	Reported SAR(1g) (W/kg)	Power Drift (dB)
Ch.	MHz									
9938	1907.6	Top 13mm	Fig.4	22.01	23	0.500	0.63	0.882	1.11	-0.04

Table 14.2-5: SAR Values (LTE Band2 - Body)

Ambient Temperature: 22.9 °C					Liquid Temperature: 22.5 °C						
Frequency		Mode	Test Position	Figure No./Note	Conducted Power (dBm)	Max. tune-up Power (dBm)	Measured SAR(10g) (W/kg)	Reported SAR(10g) (W/kg)	Measured SAR(1g) (W/kg)	Reported SAR(1g) (W/kg)	Power Drift (dB)
Ch.	MHz										
18900	1880	1RB_Mid	Top 13mm	Fig.5	22.65	23	0.539	0.58	0.944	1.02	-0.02

Note: The LTE mode is QPSK_20MHz.

Table 14.2-6: SAR Values (LTE Band4 - Body)

Ambient Temperature: 22.9 °C					Liquid Temperature: 22.5 °C						
Frequency		Mode	Test Position	Figure No. /Note	Conducted Power (dBm)	Max. tune-up Power (dBm)	Measured SAR(10g) (W/kg)	Reported SAR(10g) (W/kg)	Measured SAR(1g) (W/kg)	Reported SAR(1g) (W/kg)	Power Drift (dB)
Ch.	MHz										
20300	1745	1RB_Mid	Rear 13mm	Fig.6	21.93	22.5	0.603	0.69	1.12	1.28	0.08

Note: The LTE mode is QPSK_20MHz.

Table 14.2-7: SAR Values (LTE Band5 - Body)

Ambient Temperature: 22.9 °C					Liquid Temperature: 22.5 °C						
Frequency		Mode	Test Position	Figure No. /Note	Conducted Power (dBm)	Max. tune-up Power (dBm)	Measured SAR(10g) (W/kg)	Reported SAR(10g) (W/kg)	Measured SAR(1g) (W/kg)	Reported SAR(1g) (W/kg)	Power Drift (dB)
Ch.	MHz										
20525	836.5	1RB_Mid	Rear 0mm	Fig.7	20.48	21	0.420	0.47	0.811	0.91	-0.09

Note: The LTE mode is QPSK_10MHz.

Table 14.2-8: SAR Values (LTE Band7 - Body)

Ambient Temperature: 22.9 °C					Liquid Temperature: 22.5 °C						
Frequency		Mode	Test Position	Figure No. /Note	Conducted Power (dBm)	Max. tune-up Power (dBm)	Measured SAR(10g) (W/kg)	Reported SAR(10g) (W/kg)	Measured SAR(1g) (W/kg)	Reported SAR(1g) (W/kg)	Power Drift (dB)
Ch.	MHz										
20850	2510	50RB_Mid	Rear 0mm	Fig.8	12.47	13	0.326	0.37	0.752	0.85	-0.03

Note: The LTE mode is QPSK_20MHz.

Table 14.2-9: SAR Values (LTE Band38 - Body)

Ambient Temperature: 22.9 °C					Liquid Temperature: 22.5 °C						
Frequency		Mode	Test Position	Figure No. /Note	Conducted Power (dBm)	Max. tune-up Power (dBm)	Measured SAR(10g) (W/kg)	Reported SAR(10g) (W/kg)	Measured SAR(1g) (W/kg)	Reported SAR(1g) (W/kg)	Power Drift (dB)
Ch.	MHz										
38000	2595	1RB_Mid	Rear 0mm	Fig.9	18.02	18.5	0.424	0.47	0.984	1.10	-0.09

Note: The LTE mode is QPSK_20MHz.

Table 14.2-10: SAR Values (WLAN - Body)

Ambient Temperature: 22.9 °C					Liquid Temperature: 22.5 °C					
Frequency		Test Position	Figure No./Note	Conducted Power (dBm)	Max. tune-up Power (dBm)	Measured SAR(10g) (W/kg)	Reported SAR(10g) (W/kg)	Measured SAR(1g) (W/kg)	Reported SAR(1g) (W/kg)	Power Drift (dB)
Ch.	MHz									
1	2412	Rear 0mm	Fig.10	8.69	9	0.109	0.12	0.278	0.30	0.14

15 SAR Measurement Variability

SAR measurement variability must be assessed for each frequency band, which is determined by the SAR probe calibration point and tissue-equivalent medium used for the device measurements. When both head and body tissue-equivalent media are required for SAR measurements in a frequency band, the variability measurement procedures should be applied to the tissue medium with the highest measured SAR, using the highest measured SAR configuration for that tissue-equivalent medium.

The following procedures are applied to determine if repeated measurements are required.

- 1) Repeated measurement is not required when the original highest measured SAR is < 0.80 W/kg; steps 2) through 4) do not apply.
- 2) When the original highest measured SAR is ≥ 0.80 W/kg, repeat that measurement once.
- 3) Perform a second repeated measurement only if the ratio of largest to smallest SAR for the original and first repeated measurements is > 1.20 or when the original or repeated measurement is ≥ 1.45 W/kg (~ 10% from the 1-g SAR limit).
- 4) Perform a third repeated measurement only if the original, first or second repeated measurement is ≥ 1.5 W/kg and the ratio of largest to smallest SAR for the original, first and second repeated measurements is > 1.20 .

Table 15.1: SAR Measurement Variability for Body PCS1900 (1g)

Frequency		Test Position	Spacing (mm)	Original SAR (W/kg)	First Repeated SAR (W/kg)	The Ratio	Second Repeated SAR (W/kg)
Ch.	MHz						
512	1850.2	Rear	0	0.812	0.803	1.01	/

Table 15.2: SAR Measurement Variability for Body W1900 (1g)

Frequency		Test Position	Spacing (mm)	Original SAR (W/kg)	First Repeated SAR (W/kg)	The Ratio	Second Repeated SAR (W/kg)
Ch.	MHz						
9938	1907.6	Top	13	0.882	0.875	1.01	/

Table 15.3: SAR Measurement Variability for Body LTE B2 (1g)

Frequency		Mode	Test Position	Spacing (mm)	Original SAR (W/kg)	First Repeated SAR (W/kg)	The Ratio	Second Repeated SAR (W/kg)
Ch.	MHz							
18900	1880	1RB_Mid	Top	13	0.944	0.929	1.02	/

Table 15.4: SAR Measurement Variability for Body LTE B4 (1g)

Frequency		Mode	Test Position	Spacing (mm)	Original SAR (W/kg)	First Repeated SAR (W/kg)	The Ratio	Second Repeated SAR (W/kg)
Ch.	MHz							
20300	1745	1RB_Mid	Rear	13	1.12	1.09	1.03	/

Table 15.5: SAR Measurement Variability for Body LTE B5 (1g)

Frequency		Mode	Test Position	Spacing (mm)	Original SAR (W/kg)	First Repeated SAR (W/kg)	The Ratio	Second Repeated SAR (W/kg)
Ch.	MHz							
20525	836.5	1RB_Mid	Rear	0	0.811	0.804	1.01	/

Table 15.6: SAR Measurement Variability for Body LTE B38 (1g)

Frequency		Mode	Test Position	Spacing (mm)	Original SAR (W/kg)	First Repeated SAR (W/kg)	The Ratio	Second Repeated SAR (W/kg)
Ch.	MHz							
38000	2595	1RB_Mid	Rear	0	0.984	0.977	1.01	/

16 Measurement Uncertainty

16.1 Measurement Uncertainty for Normal SAR Tests (300MHz~3GHz)

No.	Error Description	Type	Uncertainty value	Probably Distribution	Div.	(Ci) 1g	(Ci) 10g	Std. Unc. (1g)	Std. Unc. (10g)	Degree of freedom
Measurement system										
1	Probe calibration	B	6.0	N	1	1	1	6.0	6.0	∞
2	Isotropy	B	4.7	R	$\sqrt{3}$	0.7	0.7	1.9	1.9	∞
3	Boundary effect	B	1.0	R	$\sqrt{3}$	1	1	0.6	0.6	∞
4	Linearity	B	4.7	R	$\sqrt{3}$	1	1	2.7	2.7	∞
5	Detection limit	B	1.0	N	1	1	1	0.6	0.6	∞
6	Readout electronics	B	0.3	R	$\sqrt{3}$	1	1	0.3	0.3	∞
7	Response time	B	0.8	R	$\sqrt{3}$	1	1	0.5	0.5	∞
8	Integration time	B	2.6	R	$\sqrt{3}$	1	1	1.5	1.5	∞
9	RF ambient conditions-noise	B	0	R	$\sqrt{3}$	1	1	0	0	∞
10	RF ambient conditions-reflection	B	0	R	$\sqrt{3}$	1	1	0	0	∞
11	Probe positioned mech. restrictions	B	0.4	R	$\sqrt{3}$	1	1	0.2	0.2	∞
12	Probe positioning with respect to phantom shell	B	2.9	R	$\sqrt{3}$	1	1	1.7	1.7	∞
13	Post-processing	B	1.0	R	$\sqrt{3}$	1	1	0.6	0.6	∞
Test sample related										
14	Test sample positioning	A	3.3	N	1	1	1	3.3	3.3	71
15	Device holder uncertainty	A	3.4	N	1	1	1	3.4	3.4	5
16	Drift of output power	B	5.0	R	$\sqrt{3}$	1	1	2.9	2.9	∞
Phantom and set-up										
17	Phantom uncertainty	B	4.0	R	$\sqrt{3}$	1	1	2.3	2.3	∞
18	Liquid conductivity (target)	B	5.0	R	$\sqrt{3}$	0.64	0.43	1.8	1.2	∞
19	Liquid conductivity (meas.)	A	2.06	N	1	0.64	0.43	1.32	0.89	43
20	Liquid permittivity (target)	B	5.0	R	$\sqrt{3}$	0.6	0.49	1.7	1.4	∞
21	Liquid permittivity (meas.)	A	1.6	N	1	0.6	0.49	1.0	0.8	521

Combined standard uncertainty	$u_c = \sqrt{\sum_{i=1}^{21} c_i^2 u_i^2}$						9.55	9.43	257
Expanded uncertainty (confidence interval of 95 %)	$u_e = 2u_c$						19.1	18.9	

16.2 Measurement Uncertainty for Normal SAR Tests (3~6GHz)

No.	Error Description	Type	Uncertainty value	Probably Distribution	Div.	(Ci) 1g	(Ci) 10g	Std. Unc. (1g)	Std. Unc. (10g)	Degree of freedom
Measurement system										
1	Probe calibration	B	6.55	N	1	1	1	6.55	6.55	∞
2	Isotropy	B	4.7	R	$\sqrt{3}$	0.7	0.7	1.9	1.9	∞
3	Boundary effect	B	2.0	R	$\sqrt{3}$	1	1	1.2	1.2	∞
4	Linearity	B	4.7	R	$\sqrt{3}$	1	1	2.7	2.7	∞
5	Detection limit	B	1.0	R	$\sqrt{3}$	1	1	0.6	0.6	∞
6	Readout electronics	B	0.3	R	$\sqrt{3}$	1	1	0.3	0.3	∞
7	Response time	B	0.8	R	$\sqrt{3}$	1	1	0.5	0.5	∞
8	Integration time	B	2.6	R	$\sqrt{3}$	1	1	1.5	1.5	∞
9	RF ambient conditions-noise	B	0	R	$\sqrt{3}$	1	1	0	0	∞
10	RFambient conditions-reflection	B	0	R	$\sqrt{3}$	1	1	0	0	∞
11	Probe positioned mech. restrictions	B	0.8	R	$\sqrt{3}$	1	1	0.5	0.5	∞
12	Probe positioning with respect to phantom shell	B	6.7	R	$\sqrt{3}$	1	1	3.9	3.9	∞
13	Post-processing	B	4.0	R	$\sqrt{3}$	1	1	2.3	2.3	∞
Test sample related										
14	Test sample positioning	A	3.3	N	1	1	1	3.3	3.3	71
15	Device holder uncertainty	A	3.4	N	1	1	1	3.4	3.4	5
16	Drift of output power	B	5.0	R	$\sqrt{3}$	1	1	2.9	2.9	∞
Phantom and set-up										
17	Phantom uncertainty	B	4.0	R	$\sqrt{3}$	1	1	2.3	2.3	∞
18	Liquid conductivity (target)	B	5.0	R	$\sqrt{3}$	0.64	0.43	1.8	1.2	∞
19	Liquid conductivity (meas.)	A	2.06	N	1	0.64	0.43	1.32	0.89	43
20	Liquid permittivity	B	5.0	R	$\sqrt{3}$	0.6	0.49	1.7	1.4	∞

	(target)									
21	Liquid permittivity (meas.)	A	1.6	N	1	0.6	0.49	1.0	0.8	521
Combined standard uncertainty		$u_c = \sqrt{\sum_{i=1}^{21} c_i^2 u_i^2}$						10.7	10.6	257
Expanded uncertainty (confidence interval of 95 %)		$u_e = 2u_c$						21.4	21.1	

16.3 Measurement Uncertainty for Fast SAR Tests (300MHz~3GHz)

No.	Error Description	Type	Uncertainty value	Probably Distribution	Div.	(Ci) 1g	(Ci) 10g	Std. Unc. (1g)	Std. Unc. (10g)	Degree of freedom
Measurement system										
1	Probe calibration	B	6.0	N	1	1	1	6.0	6.0	∞
2	Isotropy	B	4.7	R	$\sqrt{3}$	0.7	0.7	1.9	1.9	∞
3	Boundary effect	B	1.0	R	$\sqrt{3}$	1	1	0.6	0.6	∞
4	Linearity	B	4.7	R	$\sqrt{3}$	1	1	2.7	2.7	∞
5	Detection limit	B	1.0	R	$\sqrt{3}$	1	1	0.6	0.6	∞
6	Readout electronics	B	0.3	R	$\sqrt{3}$	1	1	0.3	0.3	∞
7	Response time	B	0.8	R	$\sqrt{3}$	1	1	0.5	0.5	∞
8	Integration time	B	2.6	R	$\sqrt{3}$	1	1	1.5	1.5	∞
9	RF ambient conditions-noise	B	0	R	$\sqrt{3}$	1	1	0	0	∞
10	RFambient conditions-reflection	B	0	R	$\sqrt{3}$	1	1	0	0	∞
11	Probe positioned mech. Restrictions	B	0.4	R	$\sqrt{3}$	1	1	0.2	0.2	∞
12	Probe positioning with respect to phantom shell	B	2.9	R	$\sqrt{3}$	1	1	1.7	1.7	∞
13	Post-processing	B	1.0	R	$\sqrt{3}$	1	1	0.6	0.6	∞
14	Fast SAR z-Approximation	B	7.0	R	$\sqrt{3}$	1	1	4.0	4.0	∞
Test sample related										
15	Test sample positioning	A	3.3	N	1	1	1	3.3	3.3	71
16	Device holder uncertainty	A	3.4	N	1	1	1	3.4	3.4	5
17	Drift of output power	B	5.0	R	$\sqrt{3}$	1	1	2.9	2.9	∞
Phantom and set-up										
18	Phantom uncertainty	B	4.0	R	$\sqrt{3}$	1	1	2.3	2.3	∞

19	Liquid conductivity (target)	B	5.0	R	$\sqrt{3}$	0.64	0.43	1.8	1.2	∞
20	Liquid conductivity (meas.)	A	2.06	N	1	0.64	0.43	1.32	0.89	43
21	Liquid permittivity (target)	B	5.0	R	$\sqrt{3}$	0.6	0.49	1.7	1.4	∞
22	Liquid permittivity (meas.)	A	1.6	N	1	0.6	0.49	1.0	0.8	521
Combined standard uncertainty		$u_c = \sqrt{\sum_{i=1}^{22} c_i^2 u_i^2}$						10.4	10.3	257
Expanded uncertainty (confidence interval of 95 %)		$u_e = 2u_c$						20.8	20.6	

16.4 Measurement Uncertainty for Fast SAR Tests (3~6GHz)

No.	Error Description	Type	Uncertainty value	Probably Distribution	Div.	(Ci) 1g	(Ci) 10g	Std. Unc. (1g)	Std. Unc. (10g)	Degree of freedom
Measurement system										
1	Probe calibration	B	6.55	N	1	1	1	6.55	6.55	∞
2	Isotropy	B	4.7	R	$\sqrt{3}$	0.7	0.7	1.9	1.9	∞
3	Boundary effect	B	2.0	R	$\sqrt{3}$	1	1	1.2	1.2	∞
4	Linearity	B	4.7	R	$\sqrt{3}$	1	1	2.7	2.7	∞
5	Detection limit	B	1.0	R	$\sqrt{3}$	1	1	0.6	0.6	∞
6	Readout electronics	B	0.3	R	$\sqrt{3}$	1	1	0.3	0.3	∞
7	Response time	B	0.8	R	$\sqrt{3}$	1	1	0.5	0.5	∞
8	Integration time	B	2.6	R	$\sqrt{3}$	1	1	1.5	1.5	∞
9	RF ambient conditions-noise	B	0	R	$\sqrt{3}$	1	1	0	0	∞
10	RFambient conditions-reflection	B	0	R	$\sqrt{3}$	1	1	0	0	∞
11	Probe positioned mech. Restrictions	B	0.8	R	$\sqrt{3}$	1	1	0.5	0.5	∞
12	Probe positioning with respect to phantom shell	B	6.7	R	$\sqrt{3}$	1	1	3.9	3.9	∞
13	Post-processing	B	1.0	R	$\sqrt{3}$	1	1	0.6	0.6	∞
14	Fast SAR z-Approximation	B	14.0	R	$\sqrt{3}$	1	1	8.1	8.1	∞
Test sample related										
15	Test sample positioning	A	3.3	N	1	1	1	3.3	3.3	71
16	Device holder	A	3.4	N	1	1	1	3.4	3.4	5

	uncertainty										
17	Drift of output power	B	5.0	R	$\sqrt{3}$	1	1	2.9	2.9	∞	
Phantom and set-up											
18	Phantom uncertainty	B	4.0	R	$\sqrt{3}$	1	1	2.3	2.3	∞	
19	Liquid conductivity (target)	B	5.0	R	$\sqrt{3}$	0.64	0.43	1.8	1.2	∞	
20	Liquid conductivity (meas.)	A	2.06	N	1	0.64	0.43	1.32	0.89	43	
21	Liquid permittivity (target)	B	5.0	R	$\sqrt{3}$	0.6	0.49	1.7	1.4	∞	
22	Liquid permittivity (meas.)	A	1.6	N	1	0.6	0.49	1.0	0.8	521	
Combined standard uncertainty									13.5	13.4	257
Expanded uncertainty (confidence interval of 95 %)									27.0	26.8	

17 MAIN TEST INSTRUMENTS

Table 17.1: List of Main Instruments

No.	Name	Type	Serial Number	Calibration Date	Valid Period
01	Network analyzer	E5071C	MY46110673	January 13, 2017	One year
02	Dielectric Probe Kit	85070E	Agilent	No Calibration Requested	
03	Power meter	NRVD	102083	September 22, 2016	One year
04	Power sensor	NRV-Z5	100595		
05	Signal Generator	E4438C	MY49071430	January 13, 2017	One Year
06	Amplifier	60S1G4	0331848	No Calibration Requested	
07	Directional Coupler	778D	MY48220584	No Calibration Requested	
08	BTS	E5515C	MY50263375	January 16, 2017	One year
09	BTS	CMW500	159890	November 25, 2016	One year
10	E-field Probe	SPEAG EX3DV4	3846	January 13, 2017	One year
11	DAE	SPEAG DAE4	1331	January 19, 2017	One year
12	Dipole Validation Kit	SPEAG D835V2	4d069	July 20, 2016	One year
13	Dipole Validation Kit	SPEAG D1750V2	1003	July 21, 2016	One year
14	Dipole Validation Kit	SPEAG D1900V2	5d101	July 28, 2016	One year
15	Dipole Validation Kit	SPEAG D2450V2	853	July 25, 2016	One year
16	Dipole Validation Kit	SPEAG D2600V2	1012	July 25, 2016	One year

END OF REPORT BODY

ANNEX A Graph Results

850 Body Rear High

Date: 2017-3-20

Electronics: DAE4 Sn1331

Medium: Body 850 MHz

Medium parameters used (interpolated): $f = 848.8$ MHz; $\sigma = 0.996$ mho/m; $\epsilon_r = 55.87$; $\rho = 1000$ kg/m³

Ambient Temperature: 22.9°C Liquid Temperature: 22.5°C

Communication System: GSM 850 GPRS Frequency: 848.8 MHz Duty Cycle: 1:2

Probe: EX3DV4 – SN3846 ConvF(9.52, 9.52, 9.52)

Area Scan (91x91x1): Interpolated grid: dx=1.000 mm, dy=1.000 mm

Maximum value of SAR (interpolated) = 0.770 W/kg

Zoom Scan (7x7x7)/Cube 0: Measurement grid: dx=5mm, dy=5mm, dz=5mm

Reference Value = 18.94 V/m; Power Drift = 0.06 dB

Peak SAR (extrapolated) = 1.30 W/kg

SAR(1 g) = 0.606 W/kg; SAR(10 g) = 0.329 W/kg

Maximum value of SAR (measured) = 0.807 W/kg

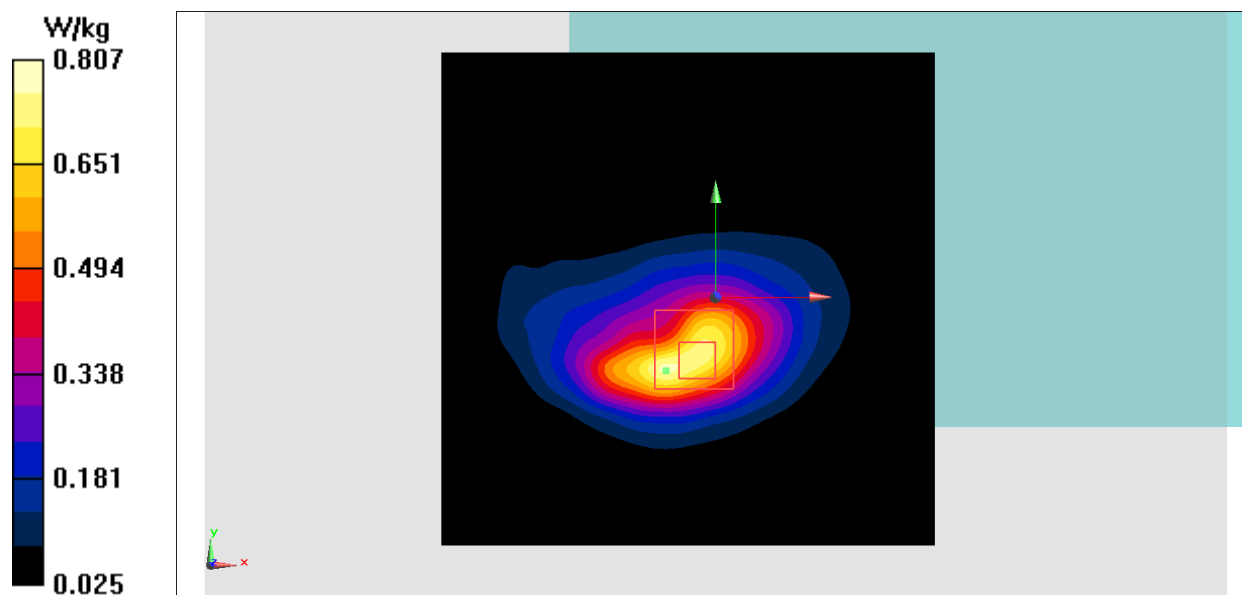

Fig.1 850 MHz

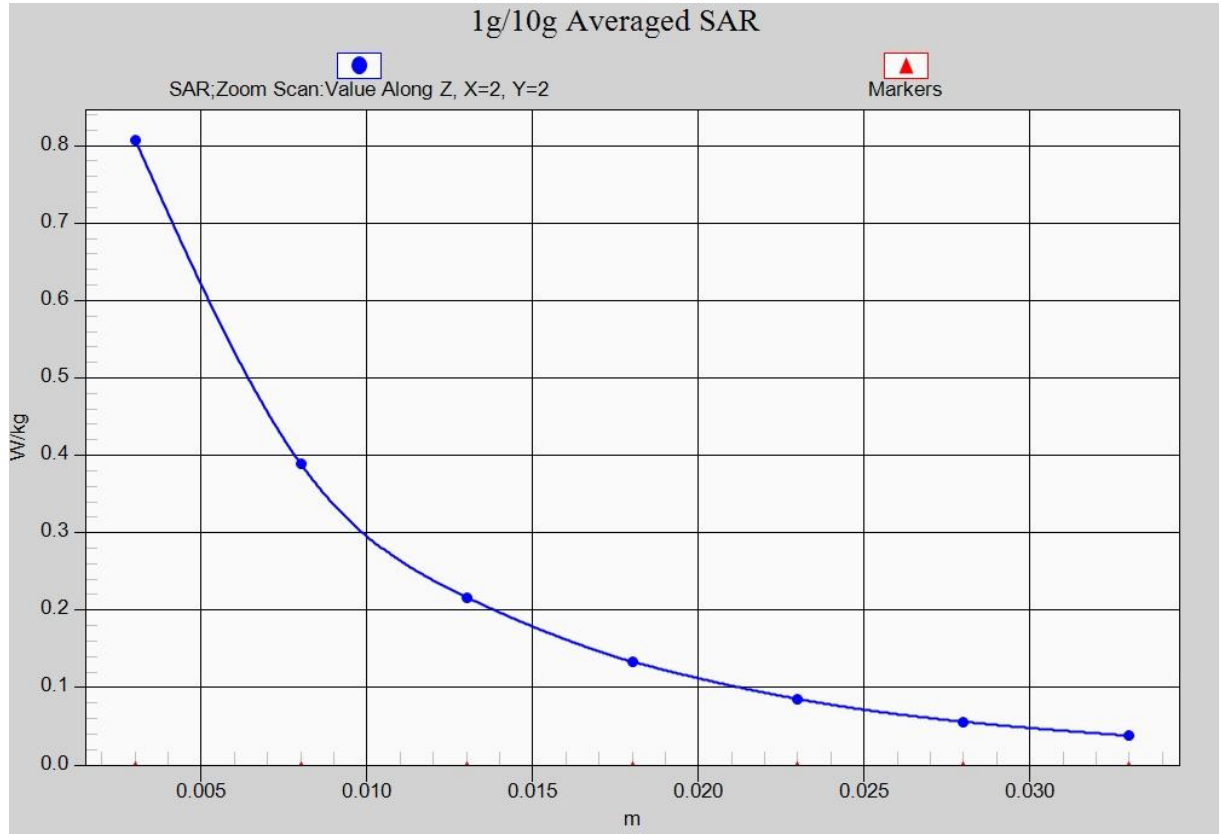

Fig. 1-1 Z-Scan at power reference point (850 MHz)

1900 Body Rear Low

Date: 2017-3-22

Electronics: DAE4 Sn1331

Medium: Body 1900 MHz

Medium parameters used (interpolated): $f = 1850.2$ MHz; $\sigma = 1.515$ mho/m; $\epsilon_r = 52.53$; $\rho = 1000$ kg/m³

Ambient Temperature: 22.9°C Liquid Temperature: 22.5°C

Communication System: GSM 1900MHz GPRS Frequency: 1850.2MHz Duty Cycle: 1:2

Probe: EX3DV4– SN3846 ConvF(7.57, 7.57, 7.57)

Area Scan (91x91x1): Interpolated grid: dx=1.000 mm, dy=1.000 mm

Maximum value of SAR (interpolated) = 1.08 W/kg

Zoom Scan (7x7x7)/Cube 0: Measurement grid: dx=5mm, dy=5mm, dz=5mm

Reference Value = 6.171 V/m; Power Drift = 0.11 dB

Peak SAR (extrapolated) = 1.69 W/kg

SAR(1 g) = 0.812 W/kg; SAR(10 g) = 0.385 W/kg

Maximum value of SAR (measured) = 1.02 W/kg

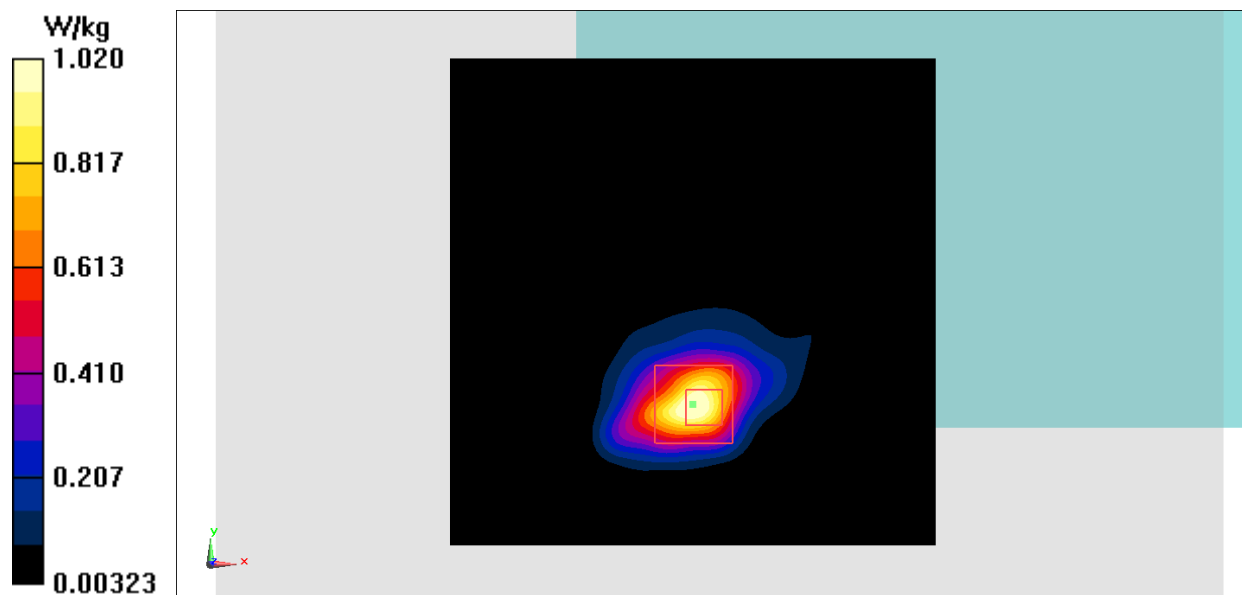

Fig.2 1900 MHz

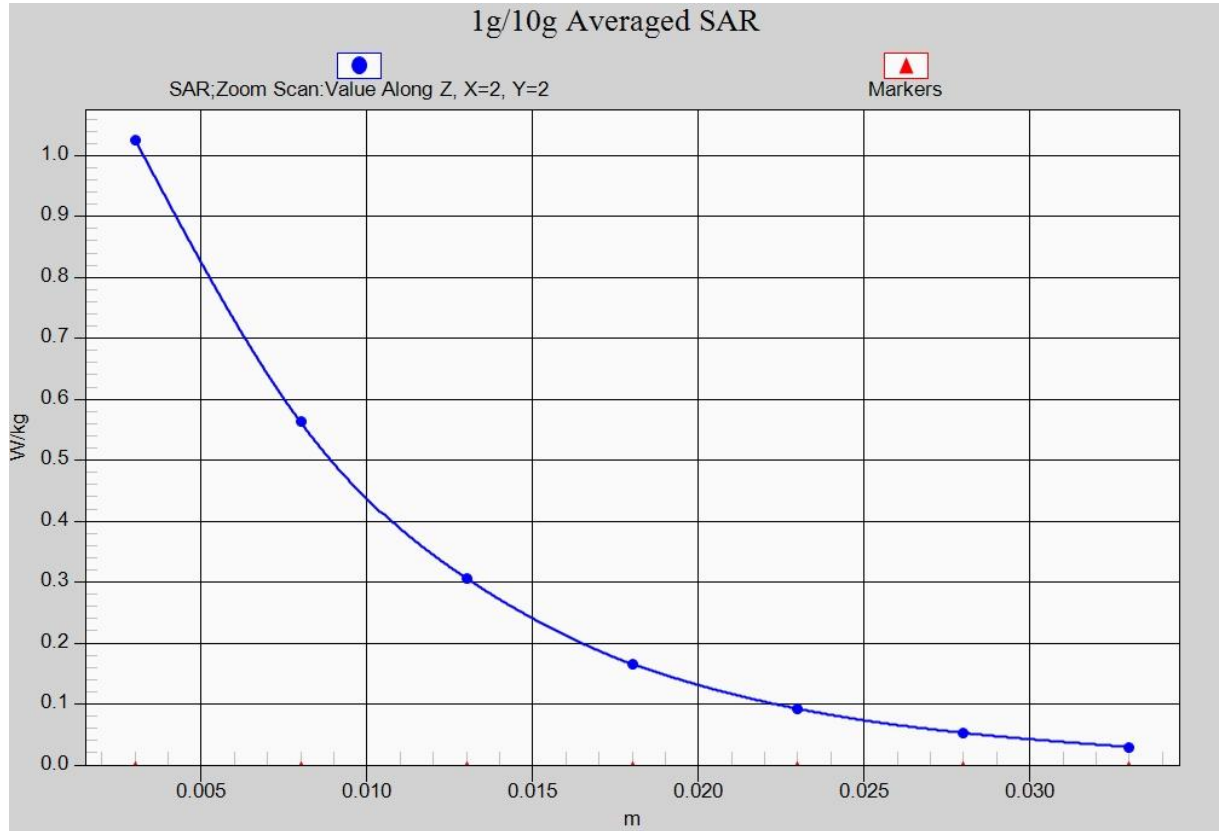

Fig. 2-1 Z-Scan at power reference point (1900 MHz)

WCDMA 850 Body Rear Low

Date: 2017-3-20

Electronics: DAE4 Sn1331

Medium: Body 850 MHz

Medium parameters used (interpolated): $f = 826.4$ MHz; $\sigma = 0.974$ mho/m; $\epsilon_r = 56.066$; $\rho = 1000$ kg/m³

Ambient Temperature: 22.9°C Liquid Temperature: 22.5°C

Communication System: WCDMA; Frequency: 826.4 MHz; Duty Cycle: 1:1

Probe: EX3DV4 – SN3846 ConvF(9.52, 9.52, 9.52)

Area Scan (91x91x1): Interpolated grid: dx=1.000 mm, dy=1.000 mm

Maximum value of SAR (interpolated) = 0.978 W/kg

Zoom Scan (7x7x7)/Cube 0: Measurement grid: dx=5mm, dy=5mm, dz=5mm

Reference Value = 13.23 V/m; Power Drift = 0.00 dB

Peak SAR (extrapolated) = 1.46 W/kg

SAR(1 g) = 0.695 W/kg; SAR(10 g) = 0.379 W/kg

Maximum value of SAR (measured) = 0.893 W/kg

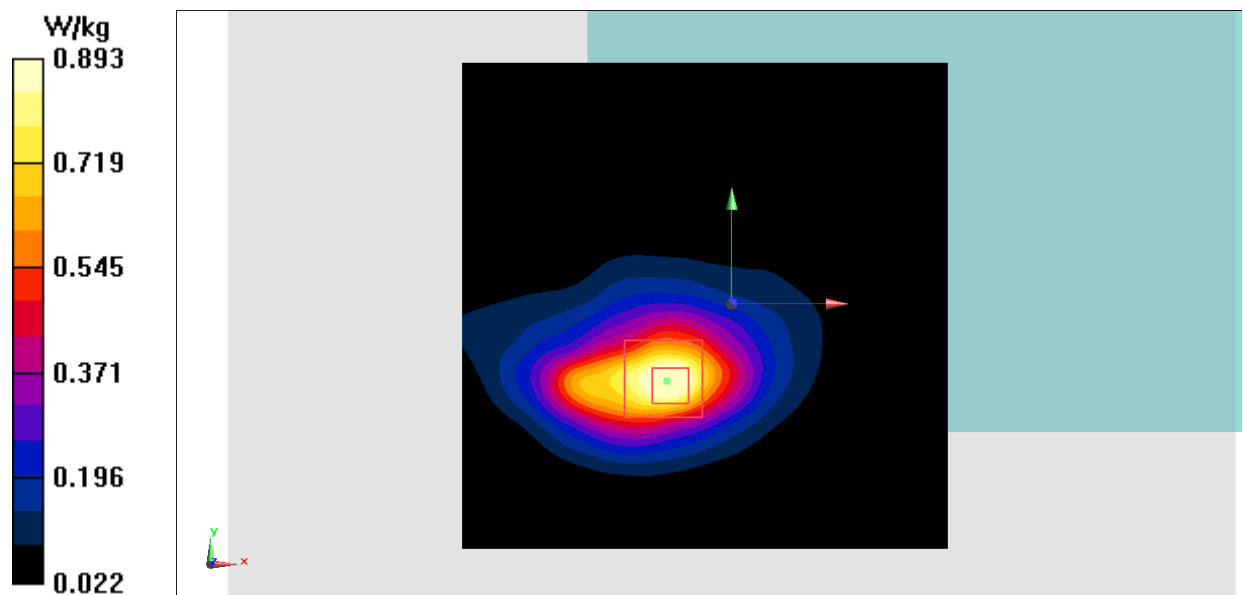

Fig.3 WCDMA 850

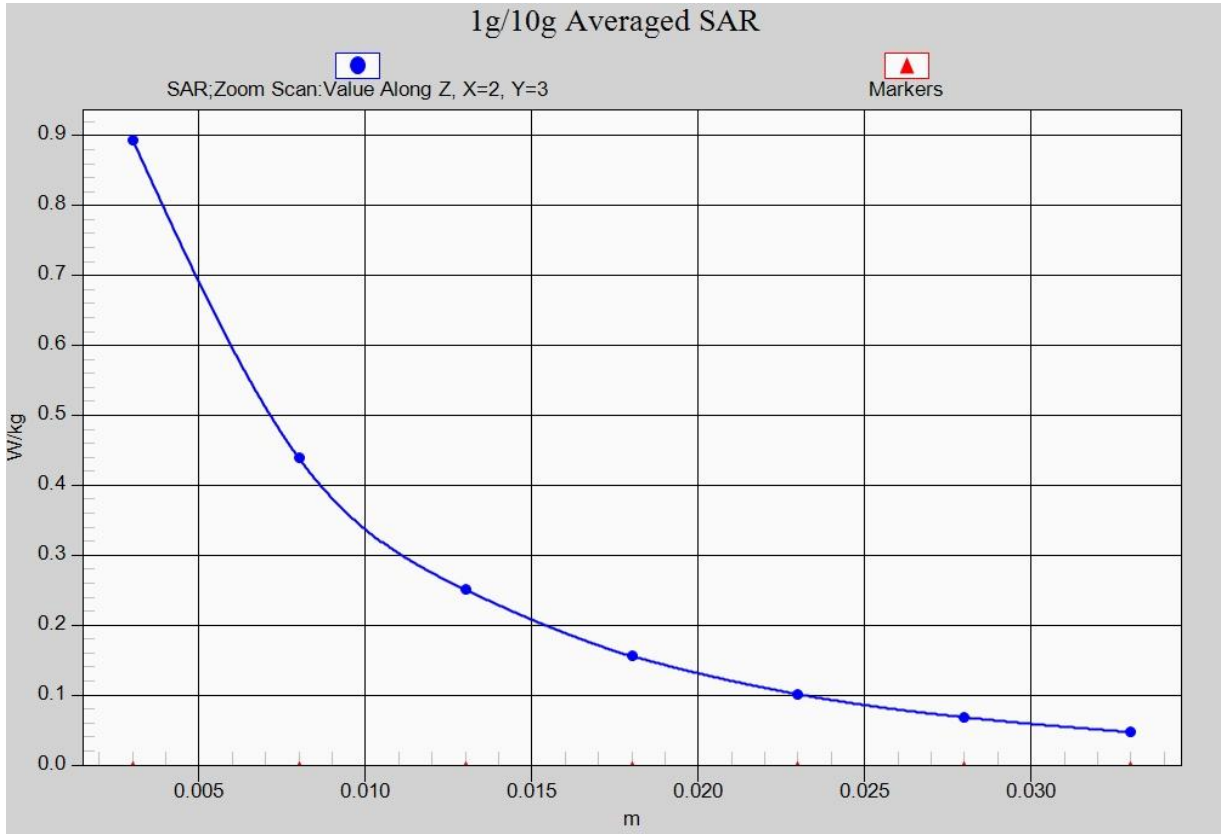

Fig. 3-1 Z-Scan at power reference point (WCDMA850)

WCDMA 1900 Body Top High

Date: 2017-3-22

Electronics: DAE4 Sn1331

Medium: Body 1900 MHz

Medium parameters used (interpolated): $f = 1907.6$ MHz; $\sigma = 1.561$ mho/m; $\epsilon_r = 52.7$; $\rho = 1000$ kg/m³

Ambient Temperature: 22.9°C Liquid Temperature: 22.5°C

Communication System: WCDMA 1900 Frequency: 1907.6 MHz Duty Cycle: 1:1

Probe: EX3DV4– SN3846 ConvF(7.57, 7.57, 7.57)

Area Scan (101x71x1): Interpolated grid: dx=1.000 mm, dy=1.000 mm

Maximum value of SAR (interpolated) = 1.14 W/kg

Zoom Scan (7x7x7)/Cube 0: Measurement grid: dx=5mm, dy=5mm, dz=5mm

Reference Value = 22.62 V/m; Power Drift = -0.04 dB

Peak SAR (extrapolated) = 1.42 W/kg

SAR(1 g) = 0.882 W/kg; SAR(10 g) = 0.500 W/kg

Maximum value of SAR (measured) = 1.03 W/kg

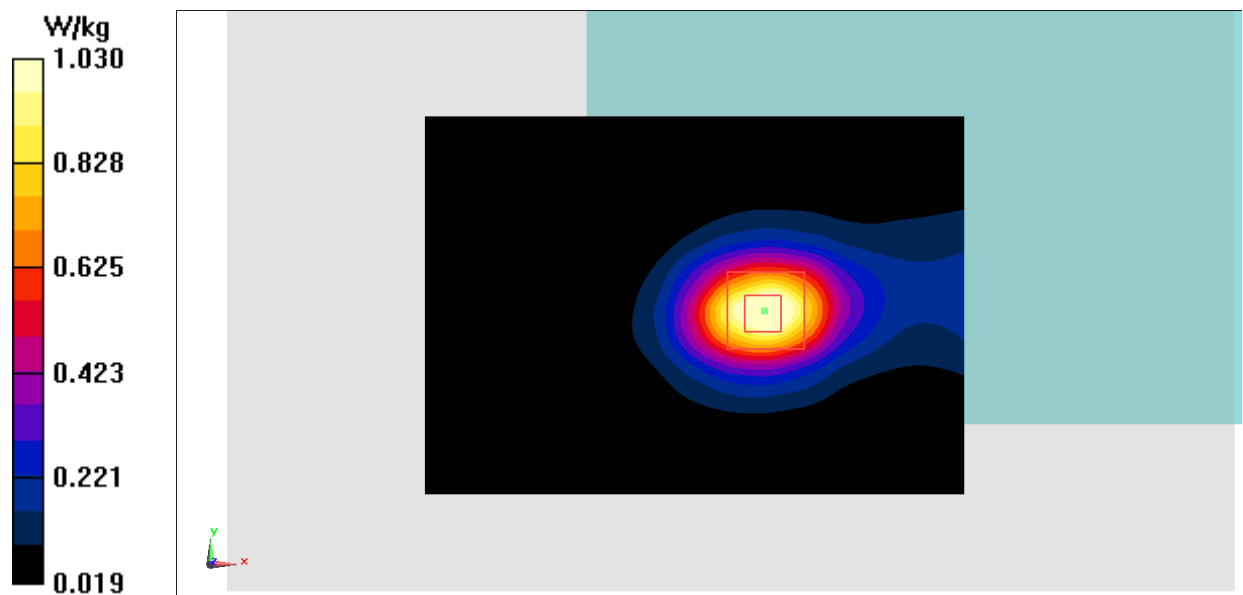

Fig.4 WCDMA1900

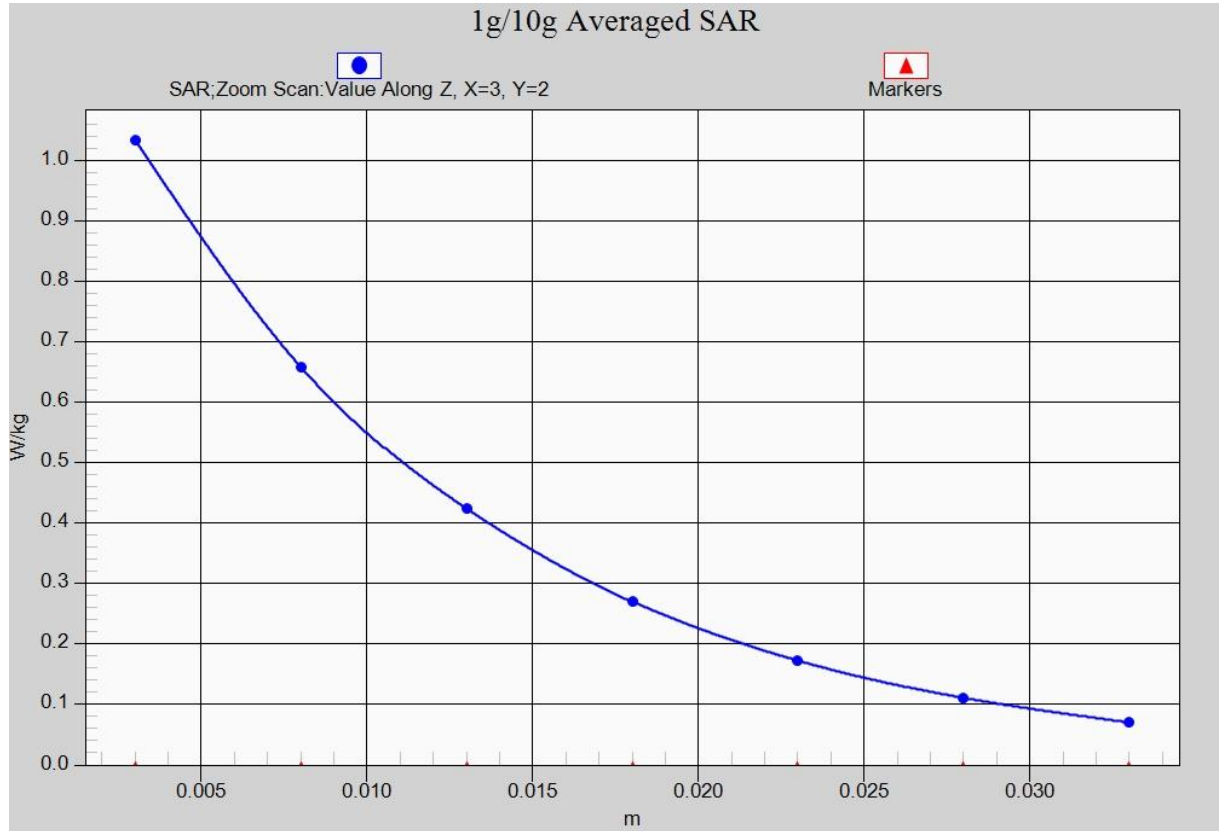

Fig. 4-1 Z-Scan at power reference point (WCDMA1900)

LTE Band2 Body Top Middle with QPSK_20M_1RB_Middle

Date: 2017-3-22

Electronics: DAE4 Sn1331

Medium: Body 1900 MHz

Medium parameters used: $f = 1880$ MHz; $\sigma = 1.508$ mho/m; $\epsilon_r = 52.47$; $\rho = 1000$ kg/m³

Ambient Temperature: 22.9°C Liquid Temperature: 22.5°C

Communication System: LTE Band2 Frequency: 1880 MHz Duty Cycle: 1:1

Probe: EX3DV4– SN3846 ConvF(7.57, 7.57, 7.57)

Area Scan (101x61x1): Interpolated grid: dx=1.000 mm, dy=1.000 mm

Maximum value of SAR (interpolated) = 1.19 W/kg

Zoom Scan (7x7x7)/Cube 0: Measurement grid: dx=5mm, dy=5mm, dz=5mm

Reference Value = 15.31 V/m; Power Drift = -0.02 dB

Peak SAR (extrapolated) = 1.49 W/kg

SAR(1 g) = 0.944 W/kg; SAR(10 g) = 0.539 W/kg

Maximum value of SAR (measured) = 1.11 W/kg

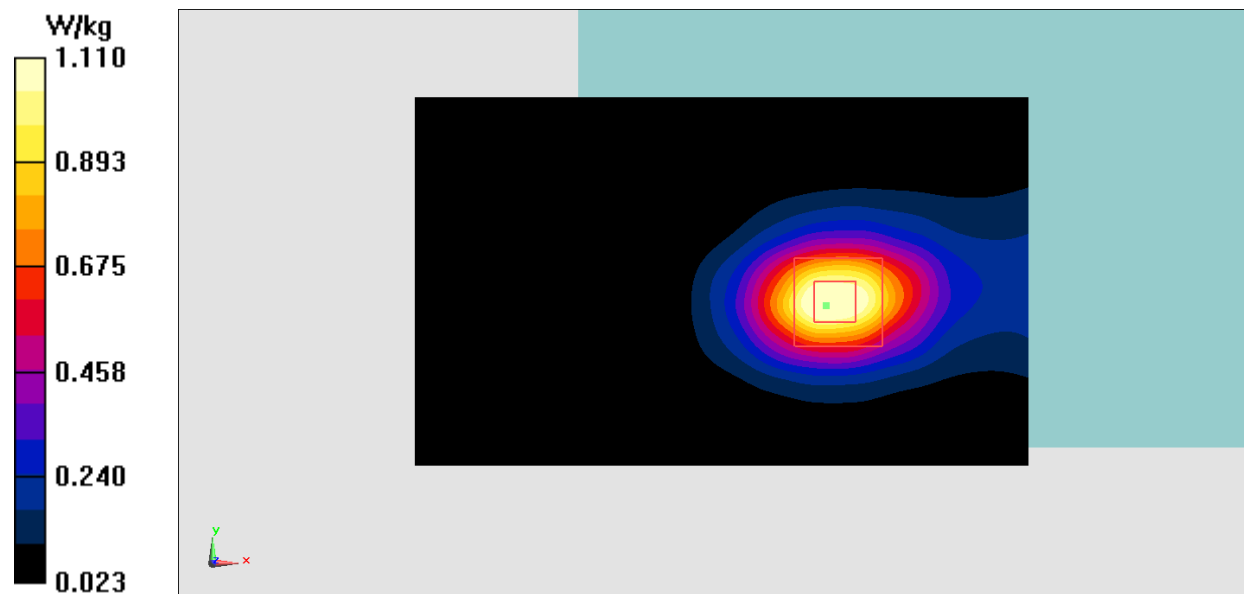

Fig.5 LTE Band2

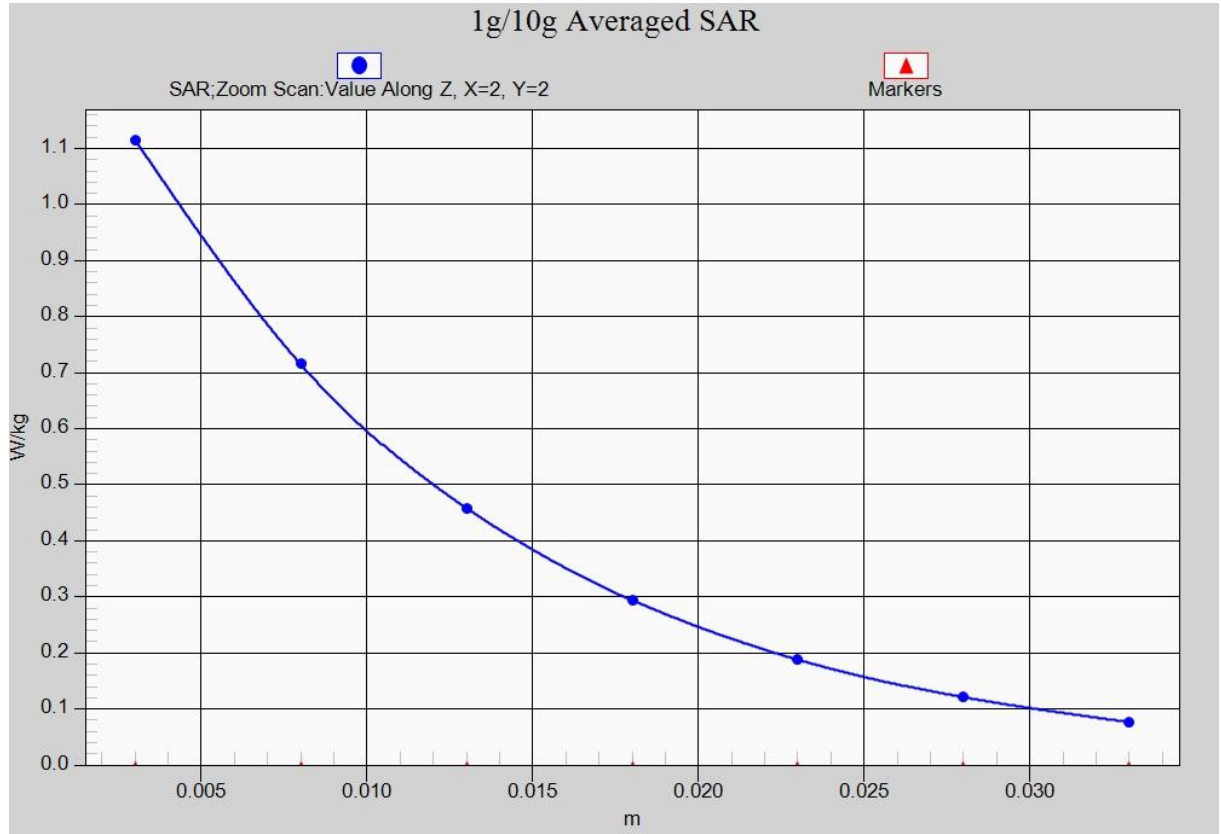

Fig. 5-1 Z-Scan at power reference point (LTE Band2)

LTE Band4 Body Rear High with QPSK_20M_1RB_Middle

Date: 2017-3-21

Electronics: DAE4 Sn1331

Medium: Body 1750 MHz

Medium parameters used: $f = 1745$ MHz; $\sigma = 1.531$ mho/m; $\epsilon_r = 54.029$; $\rho = 1000$ kg/m³

Ambient Temperature: 22.9°C Liquid Temperature: 22.5°C

Communication System: LTE Band4 Frequency: 1745 MHz Duty Cycle: 1:1

Probe: EX3DV4 – SN3846 ConvF(7.90, 7.90, 7.90)

Area Scan (91x91x1): Interpolated grid: dx=1.000 mm, dy=1.000 mm

Maximum value of SAR (interpolated) = 1.47 W/kg

Zoom Scan (7x7x7)/Cube 0: Measurement grid: dx=5mm, dy=5mm, dz=5mm

Reference Value = 7.073 V/m; Power Drift = 0.08 dB

Peak SAR (extrapolated) = 1.94 W/kg

SAR(1 g) = 1.12 W/kg; SAR(10 g) = 0.603 W/kg

Maximum value of SAR (measured) = 1.39 W/kg

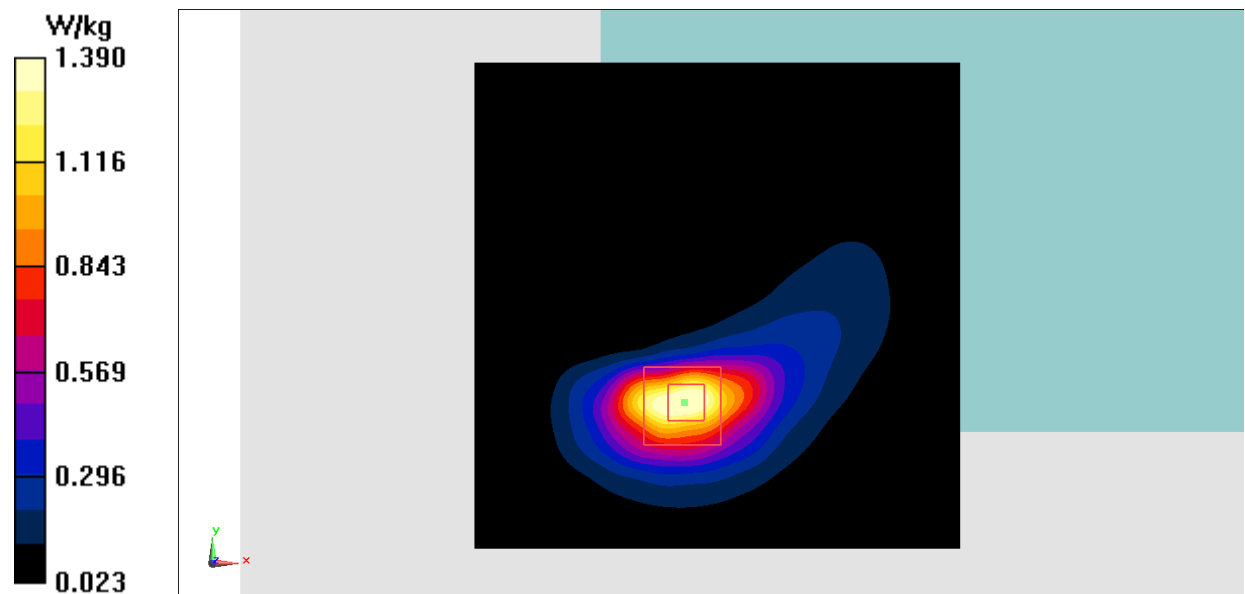

Fig.6 LTE Band4

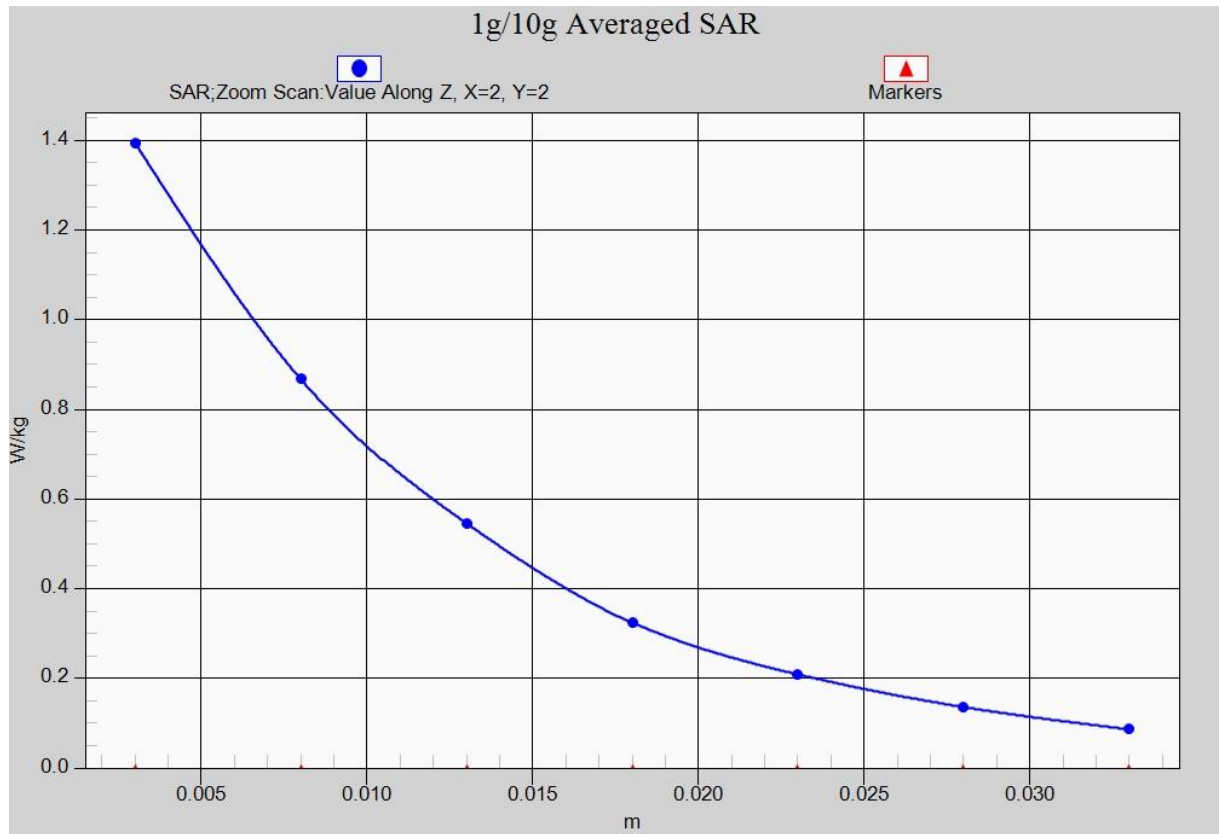

Fig. 6-1 Z-Scan at power reference point (LTE Band4)

LTE Band5 Body Rear Middle with QPSK_10M_1RB_Middle

Date: 2017-3-20

Electronics: DAE4 Sn1331

Medium: Body 850 MHz

Medium parameters used (interpolated): $f = 836.5$ MHz; $\sigma = 1.039$ mho/m; $\epsilon_r = 55.644$; $\rho = 1000$ kg/m³

Ambient Temperature: 22.9°C Liquid Temperature: 22.5°C

Communication System: LTE Band5 Frequency: 836.5MHz Duty Cycle: 1:1

Probe: EX3DV4 – SN3846 ConvF(9.52, 9.52, 9.52)

Area Scan (91x91x1): Interpolated grid: dx=1.000 mm, dy=1.000 mm

Maximum value of SAR (interpolated) = 1.06 W/kg

Zoom Scan (7x7x7)/Cube 0: Measurement grid: dx=5mm, dy=5mm, dz=5mm

Reference Value = 18.71 V/m; Power Drift = -0.09 dB

Peak SAR (extrapolated) = 1.79 W/kg

SAR(1 g) = 0.811 W/kg; SAR(10 g) = 0.420 W/kg

Maximum value of SAR (measured) = 1.09 W/kg

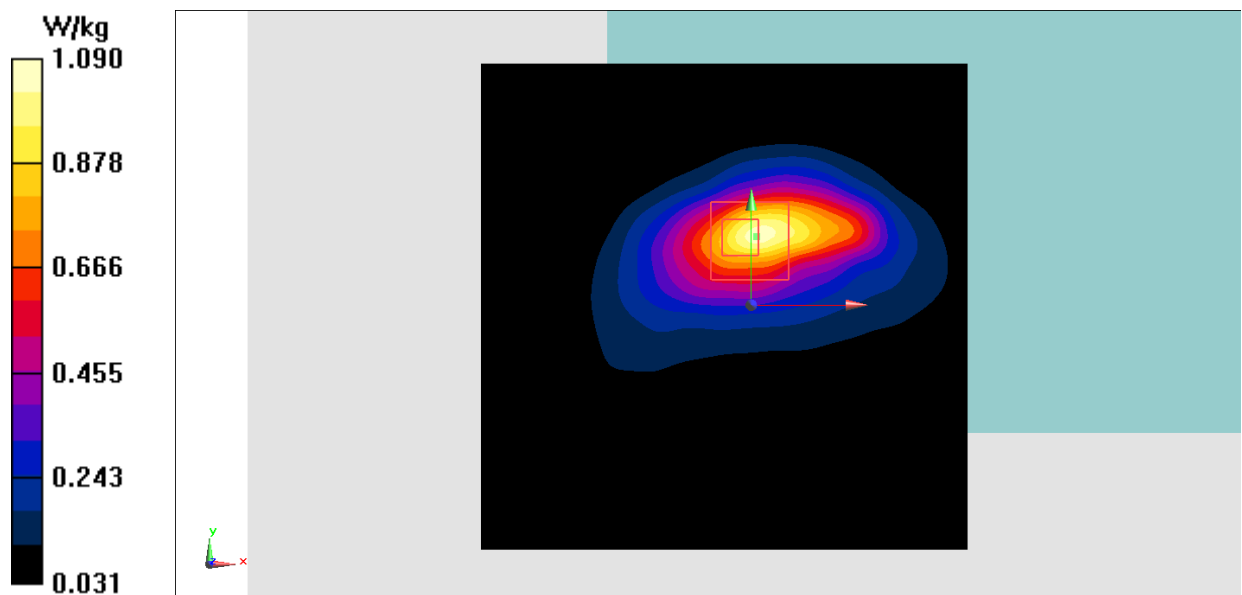

Fig.7 LTE Band5

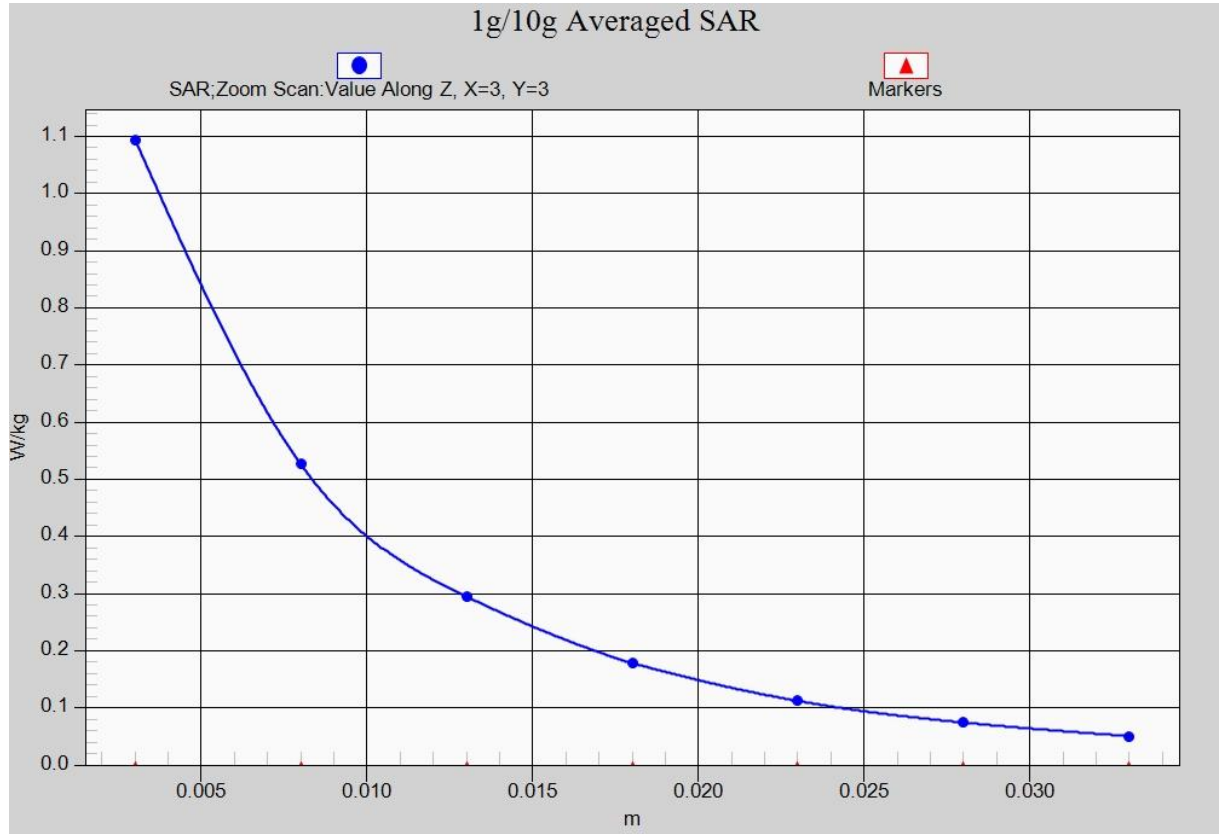

Fig. 7-1 Z-Scan at power reference point (LTE Band5)

LTE Band7 Body Rear Low with QPSK_20M_50RB_Middle

Date: 2017-3-24

Electronics: DAE4 Sn1331

Medium: Body2600 MHz

Medium parameters used: $f = 2510$ MHz; $\sigma = 2.126$ mho/m; $\epsilon_r = 52.15$; $\rho = 1000$ kg/m³

Ambient Temperature: 22.9°C Liquid Temperature: 22.5°C

Communication System: LTE Band7 Frequency: 2510 MHz Duty Cycle: 1:1

Probe: EX3DV4– SN3846 ConvF(7.25, 7.25, 7.25)

Area Scan (91x91x1): Interpolated grid: dx=1.000 mm, dy=1.000 mm

Maximum value of SAR (interpolated) = 1.25 W/kg

Zoom Scan (7x7x7)/Cube 0: Measurement grid: dx=5mm, dy=5mm, dz=5mm

Reference Value = 7.424 V/m; Power Drift = -0.03 dB

Peak SAR (extrapolated) = 1.78 W/kg

SAR(1 g) = 0.752 W/kg; SAR(10 g) = 0.326 W/kg

Maximum value of SAR (measured) = 1.10 W/kg

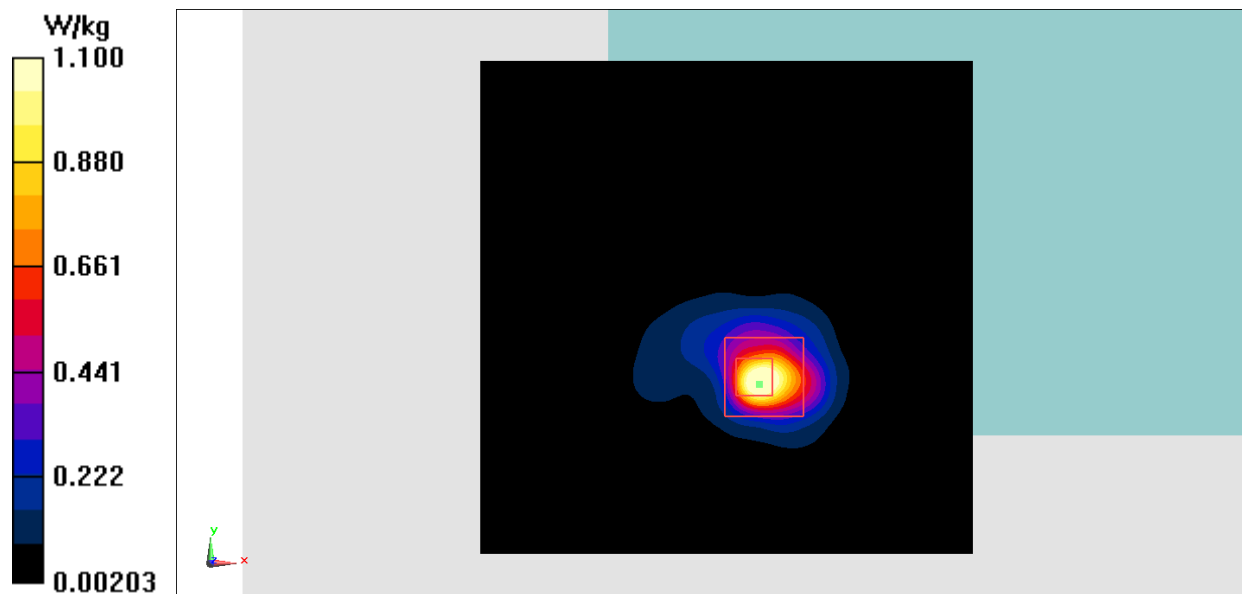

Fig.8 LTE Band7