



Test Report No.: RF170330W002-5



FCC TEST REPORT (PART 27)

Product: Portable Tablet Computer
Model Name: TB-8704V
FCC ID: O57TB8704V
Applicant: Lenovo(Shanghai) Electronics Technology Co., Ltd.
Address: NO.68 BUILDING, 199 FENJU RD, China (Shanghai) Pilot Free Trade Zone, 200131, CHINA
Manufacturer: Lenovo PC HK Limited
Address: 23/F, Lincoln House, Taikoo Place 979 King's Road, Quarry Bay, Hong Kong
Prepared by: Bureau Veritas Shenzhen Co., Ltd. Dongguan Branch
Lab Location: No. 34, Chenwulu Section, Guantai Rd., Houjie Town, Dongguan City, Guangdong 523942, China
TEL: +86 769 8593 5656
FAX: +86 769 8593 1080
E-MAIL: customerservice.dg@cn.bureauveritas.com
Report No.: RF170330W002-5
Received Date: Mar. 30, 2017
Test Date: Apr. 11, 2017 ~ May 10, 2017
Issued Date: May 11, 2017

This report should not be used by the client to claim product certification, approval, or endorsement by A2LA or any government agencies.

This report is for your exclusive use. Any copying or replication of this report to or for any other person or entity, or use of our name or trademark, is permitted only with our prior written permission. This report sets forth our findings solely with respect to the test samples identified herein. The results set forth in this report are not indicative or representative of the quality or characteristics of the lot from which a test sample was taken or any similar or identical product unless specifically and expressly noted. Our report includes all of the tests requested by you and the results thereof based upon the information that you provided to us. You have 60 days from date of issuance of this report to notify us of any material error or omission caused by our negligence, provided, however, that such notice shall be in writing and shall specifically address the issue you wish to raise. A failure to raise such issue within the prescribed time shall constitute your unqualified acceptance of the completeness of this report, the tests conducted and the correctness of the report contents. Unless specific mention, the uncertainty of measurement has been explicitly taken into account to declare the compliance or non-compliance to the specification

Bureau Veritas Shenzhen Co., Ltd.
Dongguan Branch

No. 34, Chenwulu Section, Guantai Rd., Houjie Town,
Dongguan City, Guangdong 523942, China

Tel: +86 769 8593 5656
Fax: +86 769 8593 1080
Email: customerservice.dg@cn.bureauveritas.com



TABLE OF CONTENTS

- RELEASE CONTROL RECORD 4**
- 1 CERTIFICATION 5**
- 2 SUMMARY OF TEST RESULTS 6**
 - 2.1 MEASUREMENT UNCERTAINTY 6
 - 2.2 TEST SITE AND INSTRUMENTS 7
- 3 GENERAL INFORMATION..... 8**
 - 3.1 GENERAL DESCRIPTION OF EUT 8
 - 3.2 CONFIGURATION OF SYSTEM UNDER TEST11
 - 3.3 DESCRIPTION OF SUPPORT UNITS 12
 - 3.4 DESCRIPTION OF TEST MODES..... 12
 - 3.5 GENERAL DESCRIPTION OF APPLIED STANDARDS 17
- 4 TEST TYPES AND RESULTS 18**
 - 4.1 OUTPUT POWER MEASUREMENT 18
 - 4.1.1 LIMITS OF OUTPUT POWER MEASUREMENT 18
 - 4.1.2 TEST PROCEDURES 18
 - 4.1.3 TEST SETUP 19
 - 4.1.4 TEST RESULTS 20
 - 4.2 FREQUENCY STABILITY MEASUREMENT 34
 - 4.2.1 LIMITS OF FREQUENCY STABILIIITY MEASUREMENT..... 34
 - 4.2.2 TEST PROCEDURE..... 34
 - 4.2.3 TEST SETUP..... 34
 - 4.2.4 TEST RESULTS 35
 - 4.3 OCCUPIED BANDWIDTH MEASUREMENT 47
 - 4.3.1 LIMITS OF OCCUPIED BANDWIDTH MEASUREMENT 47
 - 4.3.2 TEST SETUP..... 47
 - 4.3.3 TEST PROCEDURES 47
 - 4.3.4 TEST RESULTS 48
 - 4.4 PEAK TO AVERAGE RATIO 54
 - 4.4.1 LIMITS OF PEAK TO AVERAGE RATIO MEASUREMENT..... 54
 - 4.4.2 TEST SETUP..... 54
 - 4.4.3 TEST PROCEDURES 54
 - 4.4.4 TEST RESULTS 55
 - 4.5 BAND EDGE MEASUREMENT 61
 - 4.5.1 LIMITS OF BAND EDGE MEASUREMENT..... 61
 - 4.5.2 TEST SETUP..... 61
 - 4.5.3 TEST PROCEDURES 62
 - 4.5.4 TEST RESULTS 63
 - 4.6 CONDUCTED SPURIOUS EMISSIONS..... 75
 - 4.6.1 LIMITS OF CONDUCTED SPURIOUS EMISSIONS MEASUREMENT 75
 - 4.6.2 TEST PROCEDURE..... 75
 - 4.6.3 TEST SETUP..... 75
 - 4.6.4 TEST RESULTS 76
 - 4.7 RADIATED EMISSION MEASUREMENT 88
 - 4.7.1 LIMITS OF RADIATED EMISSION MEASUREMENT 88
 - 4.7.2 TEST PROCEDURES 88
 - 4.7.3 DEVIATION FROM TEST STANDARD 88



Test Report No.: RF170330W002-5

4.7.4	TEST SETUP	89
4.7.5	TEST RESULTS	90
5	INFORMATION ON THE TESTING LABORATORIES	128
6	APPENDIX A – MODIFICATIONS RECORDERS FOR ENGINEERING CHANGES TO THE EUT BY THE LAB	129



Test Report No.: RF170330W002-5

RELEASE CONTROL RECORD

ISSUE NO.	REASON FOR CHANGE	DATE ISSUED
RF170330W002-5	Original release	May 11, 2017



Test Report No.: RF170330W002-5

1 CERTIFICATION

PRODUCT: Portable Tablet Computer
BRAND NAME: Lenovo
MODEL NAME: TB-8704V
APPLICANT: Lenovo(Shanghai) Electronics Technology Co., Ltd.
TESTED: Apr. 11, 2017 ~ May 10, 2017
TEST SAMPLE: Production Unit
TEST STANDARDS: **FCC Part 27, Subpart C, L**
FCC Part 2
ANSI/TIE/EIA-603-D

The above equipment has been tested by **Bureau Veritas Shenzhen Co., Ltd. Dongguan Branch**, and found compliance with the requirement of the above standards. The test record, data evaluation & Equipment Under Test (EUT) configurations represented herein are true and accurate accounts of the measurements of the sample's EMC characteristics under the conditions specified in this report.

PREPARED BY : Harry , **DATE:** May 11, 2017
(Harry Li/ Engineer)

APPROVED BY : [Signature] , **DATE:** May 11, 2017
(Sam Tung / Manager)

2 SUMMARY OF TEST RESULTS

The EUT has been tested according to the following specifications:

APPLIED STANDARD: FCC Part 27 & Part 2			
STANDARD SECTION	TEST TYPE AND LIMIT	RESULT	REMARK
2.1046 27.50(d)(4)	Maximum Peak Output Power	PASS	Meet the requirement of limit.
2.1055 27.54	Frequency Stability	PASS	Meet the requirement of limit.
2.1049 27.53(h)	Occupied Bandwidth	PASS	Meet the requirement of limit.
27.50(d)(5)	Peak to average ratio	PASS	Meet the requirement of limit.
27.53(h)	Band Edge Measurements	PASS	Meet the requirement of limit.
2.1051 27.53(h)	Conducted Spurious Emissions	PASS	Meet the requirement of limit.
2.1053 27.53(h)	Radiated Spurious Emissions	PASS	Meet the requirement of limit. Minimum passing margin is -13.57dB at 1572.00MHz.

2.1 MEASUREMENT UNCERTAINTY

Where relevant, the following measurement uncertainty levels have been estimated for tests performed on the EUT as specified in CISPR 16-4-2:

MEASUREMENT	FREQUENCY	UNCERTAINTY
Conducted emissions	9kHz~30MHz	2.70dB
Radiated emissions	9KHz ~ 30MHz	2.90dB
	30MHz ~ 1GMHz	4.06dB
	1GHz ~ 18GHz	4.58dB
	18GHz ~ 40GHz	1.94dB

This uncertainty represents an expanded uncertainty expressed at approximately the 95% confidence level using a coverage factor of k=2.



Test Report No.: RF170330W002-5

2.2 TEST SITE AND INSTRUMENTS

Equipment	Manufacturer	Model No.	Serial No.	Last Cal.	Next Cal.
EMI Test Receiver	Rohde&Schwarz	ESR7	101494	Mar. 05,17	Mar. 04,18
Signal and Spectrum Analyzer	Rohde&Schwarz	FSV7	102331	Nov. 04,16	Nov. 03,17
Signal and Spectrum Analyzer	Rohde&Schwarz	FSV40	101094	Mar. 05,17	Mar. 04,18
Bilog Antenna 1	Teseq	CBL 6111D	30643	Jul. 14, 16	Jul. 13, 17
Bilog Antenna 2	Teseq	CBL 6111D	27089	Jul. 14, 16	Jul. 13, 17
Loop antenna	Daze	ZN30900A	0708	Nov. 28, 16	Nov. 27, 17
Horn Antenna (1GHz -18GHz)	ETS -Lindgren	3117	00062558	May 18,16	May 17,17
Horn Antenna (1GHz -18GHz)	ETS -Lindgren	3117	00062557	May 18,16	May 17,17
10m Semi-anechoic Chamber	CHANGLING	21.4m*12.1m*8.8m	NSEMC006	Mar. 12,16	Mar. 11,18
Test Software	E3	V 9.160323	N/A	N/A	N/A
Test Software	ADT	ADT_Radiated_V7.6.15.9.2	N/A	N/A	N/A
10dB Attenuator	JFW/USA	50HF-010-SM A	1505	Jul. 27, 16	Jul. 26, 17
Horn Antenna (15GHz-40GHz)	SCHWARZBECK	BBHA 9170	BBHA9170147	Mar. 02,17	Mar. 01,18
Horn Antenna (15GHz-40GHz)	SCHWARZBECK	BBHA 9170	BBHA9170242	Mar. 02,17	Mar. 01,18
Amplifier	Burgeon	BPA-530	100220	Mar. 05,17	Mar. 04,18
Amplifier (9kHz-1GHz)	SONOMA	310D	186955	Feb. 10,17	Feb. 09,18
Pre-Amplifier(1-18G)	HP	8449B	3008A00409	Apr. 16,17	Apr. 15,18
Pre-Amplifier (18GHz-40GHz)	EMCI	EMC 184045	980102	Nov. 04,16	Nov. 03,17
Humid & Temp Programmable Tester	Haida	HD-2257	110807201	Sep.05,16	Sep. 04,17
Signal Generator	Agilent	N5183A	MY50140980	Nov. 04,16	Nov. 03,17

- NOTE:**
1. The calibration interval of the above test instruments is 12 months or 24 months and the calibrations are traceable to CEPREI/CHINA, GRGT/CHINA and NIM/CHINA.
 2. The test was performed in 10m Semi-anechoic Chamber and RF Oven Room.
 3. The horn antenna is used only for the measurement of emission frequency above 1GHz if tested.
 4. The FCC Site Registration No. is 502831.



3 GENERAL INFORMATION

3.1 GENERAL DESCRIPTION OF EUT

PRODUCT	Portable Tablet Computer		
MODEL NAME	TB-8704V		
POWER SUPPLY	5.2Vdc (adapter or host equipment) 3.85Vdc (Li-Polymer, battery)		
MODULATION TECHNOLOGY	LTE	QPSK, 16QAM	
FREQUENCY RANGE	LTE Band 4 Channel Bandwidth: 1.4MHz	1710.7MHz ~ 1754.3MHz	
	LTE Band 4 Channel Bandwidth: 3MHz	1711.5MHz ~ 1753.5MHz	
	LTE Band 4 Channel Bandwidth: 5MHz	1712.5MHz ~ 1752.5MHz	
	LTE Band 4 Channel Bandwidth: 10MHz	1715.0MHz ~ 1750.0MHz	
	LTE Band 4 Channel Bandwidth: 15MHz	1717.5MHz ~ 1747.5MHz	
	LTE Band 4 Channel Bandwidth: 20MHz	1720.0MHz ~ 1745.0MHz	
	LTE Band 12 Channel Bandwidth: 1.4MHz	699.7MHz ~ 715.3MHz	
	LTE Band 12 Channel Bandwidth: 3MHz	700.5MHz ~ 714.5MHz	
	LTE Band 12 Channel Bandwidth: 5MHz	701.5MHz ~ 713.5MHz	
	LTE Band 12 Channel Bandwidth: 10MHz	704.0MHz ~ 711.0MHz	
	LTE Band 13 Channel Bandwidth: 5MHz	779.5MHz ~ 784.5MHz	
	LTE Band 13 Channel Bandwidth: 10MHz	782.0MHz	
	EMISSION DESIGNATOR	LTE Band 4 Channel Bandwidth: 1.4MHz	QPSK: 1M09G7D
			16QAM: 1M09W7D
LTE Band 4 Channel Bandwidth: 3MHz		QPSK: 2M68G7D	
		16QAM: 2M68W7D	
LTE Band 4 Channel Bandwidth: 5MHz		QPSK: 4M48G7D	
		16QAM: 4M47W7D	
LTE Band 4 Channel Bandwidth: 10MHz		QPSK: 8M92G7D	
		16QAM: 8M93W7D	
LTE Band 4 Channel Bandwidth: 15MHz		QPSK: 13M4G7D	
		16QAM: 13M4W7D	



Test Report No.: RF170330W002-5

EMISSION DESIGNATOR	LTE Band 4 Channel Bandwidth: 20MHz	QPSK: 17M9G7D 16QAM: 17M8W7D
	LTE Band 12 Channel Bandwidth: 1.4MHz	QPSK: 1M09G7D 16QAM: 1M08W7D
	LTE Band 12 Channel Bandwidth: 3MHz	QPSK: 2M68G7D 16QAM: 2M68W7D
	LTE Band 12 Channel Bandwidth: 5MHz	QPSK: 4M47G7D 16QAM: 4M46W7D
	LTE Band 12 Channel Bandwidth: 10MHz	QPSK: 8M93G7D 16QAM: 8M94W7D
	LTE Band 13 Channel Bandwidth: 5MHz	QPSK: 4M47G7D 16QAM: 4M46W7D
	LTE Band 13 Channel Bandwidth: 10MHz	QPSK: 8M90G7D 16QAM: 8M88W7D
MAX. ERP/EIRP POWER	LTE Band 4 Channel Bandwidth: 1.4MHz	598mW
	LTE Band 4 Channel Bandwidth: 3MHz	625mW
	LTE Band 4 Channel Bandwidth: 5MHz	649mW
	LTE Band 4 Channel Bandwidth: 10MHz	682mW
	LTE Band 4 Channel Bandwidth: 15MHz	639mW
	LTE Band 4 Channel Bandwidth: 20MHz	530mW
	LTE Band 12 Channel Bandwidth: 1.4MHz	233mW
	LTE Band 12 Channel Bandwidth: 3MHz	236mW
	LTE Band 12 Channel Bandwidth: 5MHz	232mW
	LTE Band 12 Channel Bandwidth: 10MHz	209mW
	LTE Band 13 Channel Bandwidth: 5MHz	249mW
	LTE Band 13 Channel Bandwidth: 10MHz	168mW



Test Report No.: RF170330W002-5

ANTENNA TYPE	LTE Band 4	Fixed Internal Antenna with -4dBi
	LTE Band 12/LTE Band 13	Fixed Internal Antenna with -6dBi
HW VERSION	Lenovo Tablet TB-8704V	
SW VERSION	TB-8704V_RF01_170504	
ACCESSORY DEVICE	Refer to note as below	
DATA CABLE	USB cable: non-shielded, detachable, 1.0meter	

NOTE:

- For a more detailed features description, please refer to the manufacturer's specifications or the user's manual.
- There were Sample A and B for this project, the difference is as below:

SAMPLE	EUT CONFIGURATION INFORMATION
A	(LCD+TP)1+ Battery1 + eMMC 1(16G+2G)+Front Camera1+Back Camera1+ USB Cable1 + Adapter 1
B	(LCD+TP)2+ Battery2 + eMMC 1 (16G+2G)+Front Camera2+Back Camera2 + USB Cable2+ Adapter 2

- For the test results, the EUT had been tested with all conditions. But only the worst case was shown in test report.

List of Accessories:

Accessories	Brand	Model	Manufacturer	Specification
AC Adapter 1	Acbel	C-P35	AcBel	I/P:100-240Vac, 300mA O/P: 5.2Vdc, 2000mA
AC Adapter 2	Huntkey	C-P35	Huntkey	I/P:100-240Vac, 500mA O/P: 5.2Vdc, 2000mA
Battery 1	Sunwoda	L16D1P34	Sunwoda	Rating: 3.85Vdc, 4850mAh
Battery 2	SCUD	L16D1P34	SCUD	Rating: 3.85Vdc, 4850mAh
USB Cable 1	Deren	-	Deren	1.0m non-shielded cable w/o core
USB Cable 2	Saibao	-	Saibao	1.0m non-shielded cable w/o core
LCD+TP Panel 1	o-FILM&INX	MTF-080-2711-04IKA	o-FILM&INX	8"
LCD+TP Panel 2	GIS&BOE	TC080GFL06V.C	GIS&BOE	8"
eMMC 1	Samsung	KMQE10013M-B318	Samsung	16G+2G
eMMC 2	Hynix	H9TQ17ABJTBCUR-KUM	Hynix	16G+2G
Front Camera1	Qtech	F5695AK	Qtech	5M
Front Camera2	AVC	CCBFL05006	AVC	5M
Back Camera1	Qtech	FX219BH	Qtech	8M
Back Camera2	o-FILM	OV8856	o-FILM	8M

3.2 CONFIGURATION OF SYSTEM UNDER TEST

FOR RADIATION EMISSION TEST

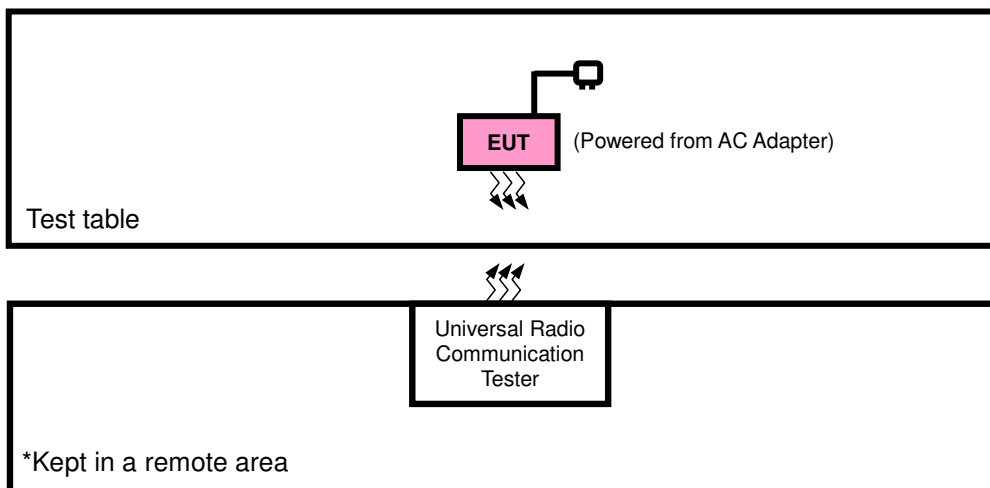

FOR CONDUCTED & E.R.P./E.I.R.P TEST

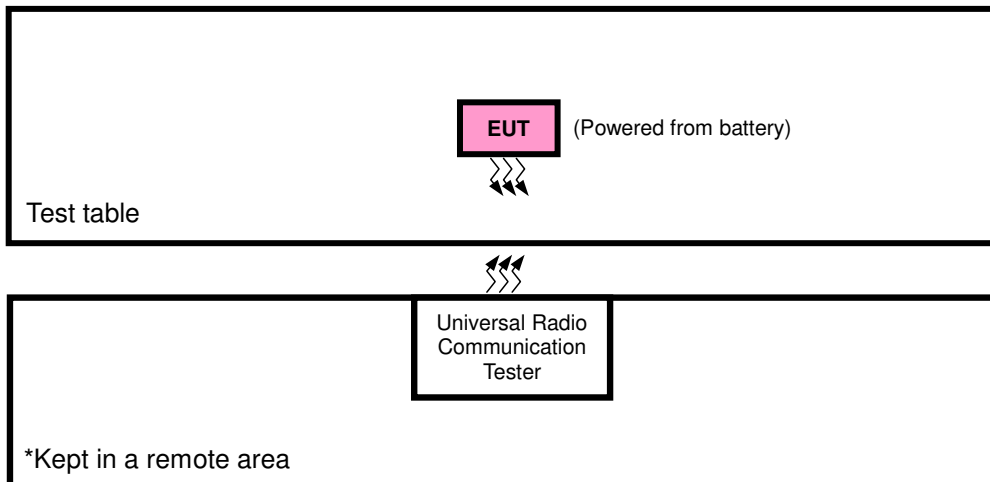



Test Report No.: RF170330W002-5

3.3 DESCRIPTION OF SUPPORT UNITS

The EUT has been tested as an independent unit together with other necessary accessories or support units. The following support units or accessories were used to form a representative test configuration during the tests.

NO.	PRODUCT	BRAND	MODEL NO.	SERIAL NO.	FCC ID
1	DC source	LONG WEI	PS-6403D	010934269	N/A
2	PC	HP	A6608CN	3CR83825X3	N/A

NO.	SIGNAL CABLE DESCRIPTION OF THE ABOVE SUPPORT UNITS
1	DC Line: Unshielded, Detachable 1.0m
2	AC Line: Unshielded, Detachable 1.5m

NOTE:

1. All power cords of the above support units are non shielded (1.8m).

3.4 DESCRIPTION OF TEST MODES

Pre-Scan has been conducted to determine the worst-case mode from all possible combinations between available modulations, data rates, XYZ axis and antenna ports. The worst case in EIRP and radiated emission was found when positioned X-plane for LTE. Following channel(s) was (were) selected for the final test as listed below:

EUT CONFIGURE MODE	DESCRIPTION
A	EUT + Adapter + USB Cable with LTE link
B	EUT + Battery with LTE link



Test Report No.: RF170330W002-5

LTE BAND 4

EUT CONFIGURE MODE	TEST ITEM	AVAILABLE CHANNEL	TESTED CHANNEL	CHANNEL BANDWIDTH	MODULATION	MODE
B	EIRP	19957 to 20393	19957, 20175, 20393	1.4MHz	QPSK, 16QAM	1 RB / 0 RB Offset
		19965 to 20385	19965, 20175, 20385	3MHz	QPSK, 16QAM	1 RB / 0 RB Offset
		19975 to 20375	19975, 20175, 20375	5MHz	QPSK, 16QAM	1 RB / 0 RB Offset
		20000 to 20350	20000, 20175, 20350	10MHz	QPSK, 16QAM	1 RB / 0 RB Offset
		20025 to 20325	20025, 20175, 20325	15MHz	QPSK, 16QAM	1 RB / 0 RB Offset
		20050 to 20300	20050, 20175, 20300	20MHz	QPSK, 16QAM	1 RB / 0 RB Offset
B	FREQUENCY STABILITY	19957 to 20393	19957, 20393	1.4MHz	QPSK, 16QAM	1 RB / 0 RB Offset
		19965 to 20385	19965, 20385	3MHz	QPSK, 16QAM	1 RB / 0 RB Offset
		19975 to 20375	19975, 20375	5MHz	QPSK, 16QAM	1 RB / 0 RB Offset
		20000 to 20350	20000, 20350	10MHz	QPSK, 16QAM	1 RB / 0 RB Offset
		20025 to 20325	20025, 20325	15MHz	QPSK, 16QAM	1 RB / 0 RB Offset
		20050 to 20300	20050, 20300	20MHz	QPSK, 16QAM	1 RB / 0 RB Offset
B	OCCUPIED BANDWIDTH	19957 to 20393	19957, 20175, 20393	1.4MHz	QPSK, 16QAM	6 RB / 0 RB Offset
		19965 to 20385	19965, 20175, 20385	3MHz	QPSK, 16QAM	15 RB / 0 RB Offset
		19975 to 20375	19975, 20175, 20375	5MHz	QPSK, 16QAM	25 RB / 0 RB Offset
		20000 to 20350	20000, 20175, 20350	10MHz	QPSK, 16QAM	50 RB / 0 RB Offset
		20025 to 20325	20025, 20175, 20325	15MHz	QPSK, 16QAM	75 RB / 0 RB Offset
		20050 to 20300	20050, 20175, 20300	20MHz	QPSK, 16QAM	100 RB / 0 RB Offset
B	PEAK TO AVERAGE RATIO	19957 to 20393	19957, 20175, 20393	1.4MHz	QPSK, 16QAM	1 RB / 0 RB Offset
		19965 to 20385	19965, 20175, 20385	3MHz	QPSK, 16QAM	1 RB / 0 RB Offset
		19975 to 20375	19975, 20175, 20375	5MHz	QPSK, 16QAM	1 RB / 0 RB Offset
		20000 to 20350	20000, 20175, 20350	10MHz	QPSK, 16QAM	1 RB / 0 RB Offset
		20025 to 20325	20025, 20175, 20325	15MHz	QPSK, 16QAM	1 RB / 0 RB Offset
		20050 to 20300	20050, 20175, 20300	20MHz	QPSK, 16QAM	1 RB / 0 RB Offset
B	BAND EDGE	19957 to 20393	19957	1.4MHz	QPSK	1 RB / 0 RB Offset 6 RB / 0 RB Offset
			20393	1.4MHz	QPSK	1 RB / 5 RB Offset 6 RB / 0 RB Offset
		19965 to 20385	19965	3MHz	QPSK	1 RB / 0 RB Offset 15 RB / 0 RB Offset
			20385	3MHz	QPSK	1 RB / 14 RB Offset 15 RB / 0 RB Offset
		19975 to 20375	19975	5MHz	QPSK	1 RB / 0 RB Offset 25 RB / 0 RB Offset
			20375	5MHz	QPSK	1 RB / 24 RB Offset 25 RB / 0 RB Offset
		20000 to 20350	20000	10MHz	QPSK	1 RB / 0 RB Offset 50 RB / 0 RB Offset
			20350	10MHz	QPSK	1 RB / 49 RB Offset 50 RB / 0 RB Offset



Test Report No.: RF170330W002-5

B	BAND EDGE	20025 to 20325	20025	15MHz	QPSK	1 RB / 0 RB Offset
						75 RB / 0 RB Offset
		20050 to 20300	20325	15MHz	QPSK	1 RB / 74 RB Offset
						75 RB / 0 RB Offset
			20050	20MHz	QPSK	1 RB / 0 RB Offset
						100 RB / 0 RB Offset
	20300	20MHz	QPSK	1 RB / 99 RB Offset		
					100 RB / 0 RB Offset	
B	CONDCUDETED EMISSION	19957 to 20393	19957, 20175, 20393	1.4MHz	QPSK, 16QAM	1 RB / 0 RB Offset
		19965 to 20385	19965, 20175, 20385	3MHz	QPSK, 16QAM	1 RB / 0 RB Offset
		19975 to 20375	19975, 20175, 20375	5MHz	QPSK, 16QAM	1 RB / 0 RB Offset
		20000 to 20350	20000, 20175, 20350	10MHz	QPSK, 16QAM	1 RB / 0 RB Offset
		20025 to 20325	20025, 20175, 20325	15MHz	QPSK, 16QAM	1 RB / 0 RB Offset
		20050 to 20300	20050, 20175, 20300	20MHz	QPSK, 16QAM	1 RB / 0 RB Offset
A	RADIATED EMISSION	19957 to 20393	20175	1.4MHz	QPSK	1 RB / 0 RB Offset
		19965 to 20385	20175	3MHz	QPSK	1 RB / 0 RB Offset
		19975 to 20375	20175	5MHz	QPSK	1 RB / 0 RB Offset
		20000 to 20350	20000, 20175, 20350	10MHz	QPSK	1 RB / 0 RB Offset
		20025 to 20325	20175	15MHz	QPSK	1 RB / 0 RB Offset
		20050 to 20300	20175	20MHz	QPSK	1 RB / 0 RB Offset

Note: This device was tested under all bandwidths, RB configurations and modulations. The worst case was found in QPSK modulation.



LTE BAND 12

EUT CONFIGURE MODE	TEST ITEM	AVAILABLE CHANNEL	TESTED CHANNEL	CHANNEL BANDWIDTH	MODULATION	MODE		
B	ERP	23017 to 23173	23017, 23095 , 23173	1.4MHz	QPSK,16QAM	1 RB / 0 RB Offset		
		23025 to 23165	23025, 23095 ,23165	3MHz	QPSK,16QAM	1 RB / 0 RB Offset		
		23035 to 23155	23035, 23095 ,23155	5MHz	QPSK,16QAM	1 RB / 0 RB Offset		
		23060 to 23130	23060, 23095 ,23130	10MHz	QPSK,16QAM	1 RB / 0 RB Offset		
B	FREQUENCY STABILITY	23017 to 23173	23017, 23173	1.4MHz	QPSK,16QAM	1 RB / 0 RB Offset		
		23025 to 23165	23025, 23165	3MHz	QPSK,16QAM	1 RB / 0 RB Offset		
		23035 to 23155	23035, 23155	5MHz	QPSK,16QAM	1 RB / 0 RB Offset		
		23060 to 23130	23060, 23130	10MHz	QPSK,16QAM	1 RB / 0 RB Offset		
B	OCCUPIED BANDWIDTH	23017 to 23173	23017, 23095 , 23173	1.4MHz	QPSK,16QAM	6 RB / 0 RB Offset		
		23025 to 23165	23025, 23095 ,23165	3MHz	QPSK,16QAM	15 RB / 0 RB Offset		
		23035 to 23155	23035, 23095 ,23155	5MHz	QPSK,16QAM	25 RB / 0 RB Offset		
		23060 to 23130	23060, 23095 ,23130	10MHz	QPSK,16QAM	50 RB / 0 RB Offset		
B	PEAK TO AVERAGE RATIO	23017 to 23173	23017, 23095 , 23173	1.4MHz	QPSK, 16QAM	1 RB / 0 RB Offset		
		23025 to 23165	23025, 23095 ,23165	3MHz	QPSK, 16QAM	1 RB / 0 RB Offset		
		23035 to 23155	23035, 23095 ,23155	5MHz	QPSK, 16QAM	1 RB / 0 RB Offset		
		23060 to 23130	23060, 23095 ,23130	10MHz	QPSK, 16QAM	1 RB / 0 RB Offset		
B	BAND EDGE	23017 to 23173	23017	1.4MHz	QPSK	1 RB / 0 RB Offset 6 RB / 0 RB Offset		
			23173	1.4MHz	QPSK	1 RB / 5 RB Offset 6 RB / 0 RB Offset		
		23025 to 23165	23025	3MHz	QPSK	1 RB / 0 RB Offset 15 RB / 0 RB Offset		
			23165	3MHz	QPSK	1 RB / 14 RB Offset 15 RB / 0 RB Offset		
		23035 to 23155	23035	5MHz	QPSK	1 RB / 0 RB Offset 25 RB / 0 RB Offset		
			23155	5MHz	QPSK	1 RB / 24 RB Offset 25 RB / 0 RB Offset		
		23060 to 23130	23060	10MHz	QPSK	1 RB / 0 RB Offset 50 RB / 0 RB Offset		
			23130	10MHz	QPSK	1 RB / 49 RB Offset 50 RB / 0 RB Offset		
		B	CONDCUETED EMISSION	23017 to 23173	23017, 23095 , 23173	1.4MHz	QPSK,16QAM	1 RB / 0 RB Offset
				23025 to 23165	23025, 23095 ,23165	3MHz	QPSK,16QAM	1 RB / 0 RB Offset
				23035 to 23155	23035, 23095 ,23155	5MHz	QPSK,16QAM	1 RB / 0 RB Offset
				23060 to 23130	23060, 23095 ,23130	10MHz	QPSK,16QAM	1 RB / 0 RB Offset
A	RADIATED EMISSION	23017 to 23173	23095	1.4MHz	QPSK	1 RB / 0 RB Offset		
		23025 to 23165	23095	3MHz	QPSK	1 RB / 0 RB Offset		
		23035 to 23155	23095	5MHz	QPSK	1 RB / 0 RB Offset		
		23060 to 23130	23060, 23095 ,23130	10MHz	QPSK	1 RB / 0 RB Offset		

Note: This device was tested under all bandwidths, RB configurations and modulations. The worst case was found in QPSK modulation.



Test Report No.: RF170330W002-5

LTE BAND 13

EUT CONFIGURE MODE	TEST ITEM	AVAILABLE CHANNEL	TESTED CHANNEL	CHANNEL BANDWIDTH	MODULATION	MODE
B	ERP	23205 to 23255	23205, 23230, 23255	5MHz	QPSK, 16QAM	1 RB / 0 RB Offset
		23230	23230	10MHz	QPSK, 16QAM	1 RB / 0 RB Offset
B	FREQUENCY STABILITY	23205 to 23255	23205, 23255	5MHz	QPSK, 16QAM	1 RB / 0 RB Offset
		23230	23230	10MHz	QPSK, 16QAM	1 RB / 0 RB Offset
B	OCCUPIED BANDWIDTH	23205 to 23255	23205, 23230, 23255	5MHz	QPSK, 16QAM	25 RB / 0 RB Offset
		23230	23230	10MHz	QPSK, 16QAM	50 RB / 0 RB Offset
B	PEAK TO AVERAGE RATIO	23205 to 23255	23205, 23230, 23255	5MHz	QPSK, 16QAM	1 RB / 0 RB Offset
		23230	23230	10MHz	QPSK, 16QAM	1 RB / 0 RB Offset
B	BAND EDGE	23205 to 23255	23205	5MHz	QPSK	1 RB / 0 RB Offset
			23255	5MHz	QPSK	25 RB / 0 RB Offset
		23230	23230	10MHz	QPSK	1 RB / 24 RB Offset
			23230	10MHz	QPSK	25 RB / 0 RB Offset
			23230	10MHz	QPSK	1 RB / 0 RB Offset
			23230	10MHz	QPSK	50 RB / 0 RB Offset
B	CONDCUDED EMISSION	23205 to 23255	23205, 23230, 23255	5MHz	QPSK, 16QAM	1 RB / 0 RB Offset
		23230	23230	10MHz	QPSK, 16QAM	1 RB / 0 RB Offset
A	RADIATED EMISSION	23205 to 23255	23205, 23230, 23255	5MHz	QPSK	1 RB / 0 RB Offset
		23230	23230	10MHz	QPSK	1 RB / 0 RB Offset

Note: This device was tested under all bandwidths, RB configurations and modulations. The worst case was found in QPSK modulation.

TEST CONDITION:

TEST ITEM	ENVIRONMENTAL CONDITIONS	INPUT POWER	TESTED BY
EIRP(ERP)	24deg. C, 60%RH	3.85Vdc from Battery	Wenliang Wu
FREQUENCY STABILITY	24deg. C, 61%RH	3.85Vdc from Battery	Wenliang Wu
OCCUPIED BANDWIDTH	24deg. C, 61%RH	3.85Vdc from Battery	Wenliang Wu
PEAK TO AVERAGE RATIO	24deg. C, 61%RH	3.85Vdc from Battery	Moon Xiong
BAND EDGE	24deg. C, 61%RH	3.85Vdc from Battery	Moon Xiong
CONDCUDED EMISSION	24deg. C, 61%RH	3.85Vdc from Battery	Moon Xiong
RADIATED EMISSION	23deg. C, 66%RH	5.2Vdc from adapter	Tony Zou



Test Report No.: RF170330W002-5

3.5 GENERAL DESCRIPTION OF APPLIED STANDARDS

The EUT is a RF product. According to the specifications of the manufacturer, it must comply with the requirements of the following standards:

FCC 47 CFR Part 2

FCC 47 CFR Part 27

KDB 971168 D01 Power Meas License Digital Systems v02r02

ANSI/TIA/EIA-603-D

NOTE: All test items have been performed and recorded as per the above standards.



Test Report No.: RF170330W002-5

4 TEST TYPES AND RESULTS

4.1 OUTPUT POWER MEASUREMENT

4.1.1 LIMITS OF OUTPUT POWER MEASUREMENT

Fixed, mobile, and portable (hand-held) stations operating in the 1710–1755 MHz band are limited to 1 watt EIRP.

Portable stations (hand-held devices) operating in the 704-716 MHz and 776-788 MHz bands are limited to 3 watts ERP.

4.1.2 TEST PROCEDURES

EIRP / ERP MEASUREMENT:

- a. The EUT was set up for the maximum power with LTE link data modulation. The power was measured with R&S Spectrum Analyzer. All measurements were done at 3 channels (low, middle and high operational frequency range). RBW and VBW is 10MHz for LTE.
- b. E.I.R.P power measurement. In the semi-anechoic chamber, EUT placed on the 0.8m height of Turn Table, rotated the table around 360 degrees to search the maximum radiation power and receiver antenna shall be rotated vertical and horizontal polarization and moved height from 1m to 4m to find the maximum polar radiated power. The “Read Value” is the spectrum reading the maximum power value.
- c. The substitution horn antenna is substituted for EUT at the same position and signals generator export the CW signal to the substitution antenna via a TX cable. Rotated the Turn Table and moved receiving antenna to find the maximum radiation power. Adjust output power level of S.G to get a Value of spectrum reading equal to “Read Value” of step a. Record the power level of S.G
- d. $EIRP = \text{Output power level of S.G} - \text{TX cable loss} + \text{Antenna gain of substitution horn}$
- e. $E.R.P = E.I.R.P - 2.15 \text{ dB}$

CONDUCTED POWER MEASUREMENT:

- a. The EUT was set up for the maximum power with LTE link data modulation and link up with simulator.
- b. Set the EUT to transmit under low, middle and high channel and record the power level shown on simulator.

4.1.3 TEST SETUP

EIRP / ERP MEASUREMENT:

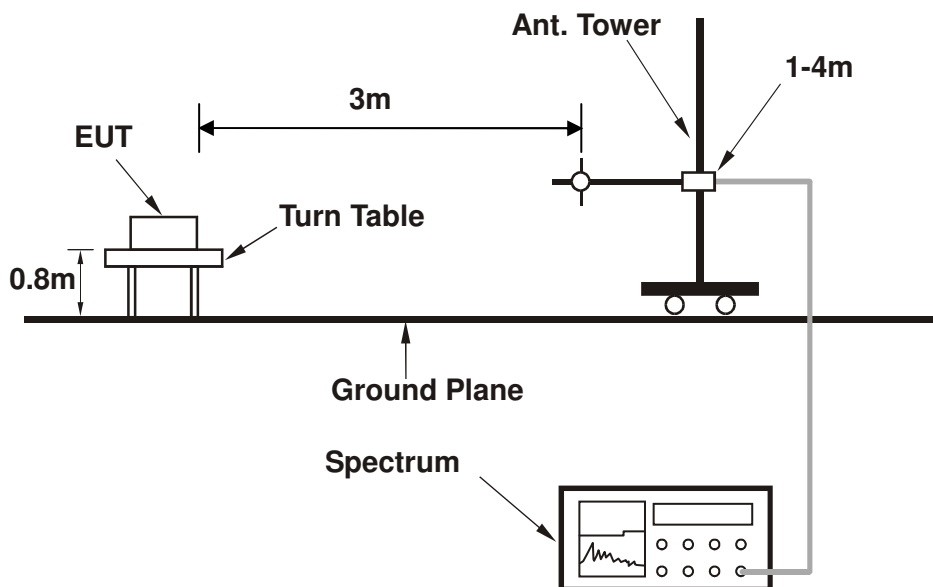

For the actual test configuration, please refer to the attached file (Test Setup Photo).

CONDUCTED POWER MEASUREMENT:

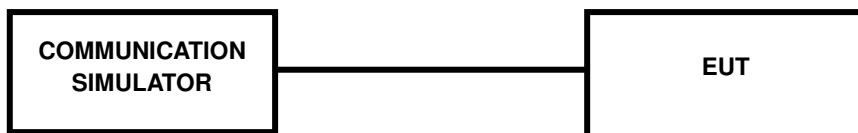

For the actual test configuration, please refer to the attached file (Test Setup Photo).



Test Report No.: RF170330W002-5

4.1.4 TEST RESULTS

AVERAGE CONDUCTED OUTPUT POWER (dBm)

LTE Band 4							
BW	Modulation	RB Size	RB Offset	Low CH 19957	Mid CH 20175	High CH 20393	MPR
				Frequency 1710.7 MHz	Frequency 1732.5 MHz	Frequency 1754.3 MHz	
1.4MHz	QPSK	1	0	23.44	23.70	23.62	0
		1	2	23.38	23.64	23.56	0
		1	5	23.32	23.58	23.50	0
		3	0	23.42	23.68	23.60	0
		3	1	23.36	23.62	23.54	0
		3	3	23.30	23.56	23.48	0
		6	0	22.39	22.65	22.57	1
	16QAM	1	0	22.38	22.64	22.56	1
		1	2	22.32	22.58	22.50	1
		1	5	22.28	22.54	22.46	1
		3	0	22.37	22.63	22.55	1
		3	1	22.31	22.57	22.49	1
		3	3	22.27	22.53	22.45	1
		6	0	21.28	21.54	21.46	2
BW	Modulation	RB Size	RB Offset	Low CH 19965	Mid CH 20175	High CH 20385	MPR
				Frequency 1711.5 MHz	Frequency 1732.5 MHz	Frequency 1753.5 MHz	
3 MHz	QPSK	1	0	23.45	23.71	23.63	0
		1	7	23.39	23.65	23.57	0
		1	14	23.33	23.59	23.51	0
		8	0	22.39	22.65	22.57	1
		8	3	22.34	22.60	22.52	1
		8	7	22.31	22.57	22.49	1
		15	0	22.40	22.66	22.58	1
	16QAM	1	0	22.39	22.65	22.57	1
		1	7	22.33	22.59	22.51	1
		1	14	22.29	22.55	22.47	1
		8	0	21.42	21.68	21.60	2
		8	3	21.39	21.65	21.57	2
		8	7	21.34	21.60	21.52	2
		15	0	21.29	21.55	21.47	2



Test Report No.: RF170330W002-5

LTE Band 4							
BW	Modulation	RB Size	RB Offset	Low CH 19975	Mid CH 20175	High CH 20375	MPR
				Frequency 1712.5 MHz	Frequency 1732.5 MHz	Frequency 1752.5 MHz	
5 MHz	QPSK	1	0	23.48	23.74	23.66	0
		1	12	23.42	23.68	23.60	0
		1	24	23.36	23.62	23.54	0
		12	0	22.42	22.68	22.60	1
		12	6	22.37	22.63	22.55	1
		12	13	22.34	22.60	22.52	1
		25	0	22.43	22.69	22.61	1
	16QAM	1	0	22.42	22.68	22.60	1
		1	12	22.36	22.62	22.54	1
		1	24	22.32	22.58	22.50	1
		12	0	21.45	21.71	21.63	2
		12	6	21.42	21.68	21.60	2
		12	13	21.37	21.63	21.55	2
		25	0	21.32	21.58	21.50	2
BW	Modulation	RB Size	RB Offset	Low CH 20000	Mid CH 20175	High CH 20350	MPR
				Frequency 1715 MHz	Frequency 1732.5 MHz	Frequency 1750 MHz	
10 MHz	QPSK	1	0	23.52	23.78	23.70	0
		1	24	23.46	23.72	23.64	0
		1	49	23.40	23.66	23.58	0
		25	0	22.46	22.72	22.64	1
		25	12	22.41	22.67	22.59	1
		25	25	22.38	22.64	22.56	1
		50	0	22.47	22.73	22.65	1
	16QAM	1	0	22.46	22.72	22.64	1
		1	24	22.40	22.66	22.58	1
		1	49	22.36	22.62	22.54	1
		25	0	21.49	21.75	21.67	2
		25	12	21.46	21.72	21.64	2
		25	25	21.41	21.67	21.59	2
		50	0	21.36	21.62	21.54	2



Test Report No.: RF170330W002-5

LTE Band 4							
BW	Modulation	RB Size	RB Offset	Low CH 20025	Mid CH 20175	High CH 20325	MPR
				Frequency 1717.5 MHz	Frequency 1732.5 MHz	Frequency 1747.5 MHz	
15 MHz	QPSK	1	0	23.58	23.84	23.76	0
		1	37	23.52	23.78	23.70	0
		1	74	23.46	23.72	23.64	0
		36	0	22.52	22.78	22.70	1
		36	19	22.47	22.73	22.65	1
		36	39	22.44	22.70	22.62	1
		75	0	22.53	22.79	22.71	1
	16QAM	1	0	22.52	22.78	22.70	1
		1	37	22.46	22.72	22.64	1
		1	74	22.42	22.68	22.60	1
		36	0	21.55	21.81	21.73	2
		36	19	21.52	21.78	21.70	2
		36	39	21.47	21.73	21.65	2
		75	0	21.42	21.68	21.60	2
BW	Modulation	RB Size	RB Offset	Low CH 20050	Mid CH 20175	High CH 20300	MPR
				Frequency 1720 MHz	Frequency 1732.5 MHz	Frequency 1745 MHz	
20MHz	QPSK	1	0	23.61	23.87	23.79	0
		1	50	23.55	23.81	23.73	0
		1	99	23.49	23.75	23.67	0
		50	0	22.55	22.81	22.73	1
		50	25	22.50	22.76	22.68	1
		50	50	22.47	22.73	22.65	1
		100	0	22.56	22.82	22.74	1
	16QAM	1	0	22.55	22.81	22.73	1
		1	50	22.49	22.75	22.67	1
		1	99	22.45	22.71	22.63	1
		50	0	21.58	21.84	21.76	2
		50	25	21.55	21.81	21.73	2
		50	50	21.50	21.76	21.68	2
		100	0	21.45	21.71	21.63	2



Test Report No.: RF170330W002-5

LTE Band 12							
BW	Modulation	RB Size	RB Offset	Low CH 23017	Mid CH 23095	High CH 23173	MPR
				Frequency 699.7 MHz	Frequency 707.5 MHz	Frequency 715.3 MHz	
1.4 MHz	QPSK	1	0	23.72	24.02	23.99	0
		1	2	23.68	23.98	23.95	0
		1	5	23.65	23.95	23.92	0
		3	0	23.70	24.00	23.97	0
		3	1	23.66	23.96	23.93	0
		3	3	23.63	23.93	23.90	0
		6	0	22.68	22.98	22.95	1
	16QAM	1	0	22.56	22.86	22.83	1
		1	2	22.48	22.78	22.75	1
		1	5	22.44	22.74	22.71	1
		3	0	22.55	22.85	22.82	1
		3	1	22.47	22.77	22.74	1
		3	3	22.43	22.73	22.70	1
		6	0	21.69	21.99	21.96	2
BW	Modulation	RB Size	RB Offset	Low CH 23025	Mid CH 23095	High CH 23165	MPR
				Frequency 700.5 MHz	Frequency 707.5 MHz	Frequency 714.5 MHz	
3 MHz	QPSK	1	0	23.76	24.06	24.03	0
		1	7	23.72	24.02	23.99	0
		1	14	23.69	23.99	23.96	0
		8	0	22.72	23.02	22.99	1
		8	3	22.69	22.99	22.96	1
		8	7	22.66	22.96	22.93	1
		15	0	22.72	23.02	22.99	1
	16QAM	1	0	22.60	22.90	22.87	1
		1	7	22.52	22.82	22.79	1
		1	14	22.48	22.78	22.75	1
		8	0	21.77	22.07	22.04	2
		8	3	21.74	22.04	22.01	2
		8	7	21.68	21.98	21.95	2
		15	0	21.73	22.03	22.00	2



Test Report No.: RF170330W002-5

LTE Band 12							
BW	Modulation	RB Size	RB Offset	Low CH 23035	Mid CH 23095	High CH 23155	MPR
				Frequency 701.5 MHz	Frequency 707.5 MHz	Frequency 713.5 MHz	
5 MHz	QPSK	1	0	23.82	24.12	24.09	0
		1	12	23.78	24.08	24.05	0
		1	24	23.75	24.05	24.02	0
		12	0	22.78	23.08	23.05	1
		12	6	22.75	23.05	23.02	1
		12	13	22.72	23.02	22.99	1
		25	0	22.78	23.08	23.05	1
	16QAM	1	0	22.66	22.96	22.93	1
		1	12	22.58	22.88	22.85	1
		1	24	22.54	22.84	22.81	1
		12	0	21.83	22.13	22.10	2
		12	6	21.80	22.10	22.07	2
		12	13	21.74	22.04	22.01	2
		25	0	21.79	22.09	22.06	2
BW	Modulation	RB Size	RB Offset	Low CH 23060	Mid CH 23095	High CH 23130	MPR
				Frequency 704 MHz	Frequency 707.5 MHz	Frequency 711 MHz	
10 MHz	QPSK	1	0	23.85	24.15	24.12	0
		1	24	23.81	24.11	24.08	0
		1	49	23.78	24.08	24.05	0
		25	0	22.81	23.11	23.08	1
		25	12	22.78	23.08	23.05	1
		25	25	22.75	23.05	23.02	1
		50	0	22.81	23.11	23.08	1
	16QAM	1	0	22.69	22.99	22.96	1
		1	24	22.61	22.91	22.88	1
		1	49	22.57	22.87	22.84	1
		25	0	21.86	22.16	22.13	2
		25	12	21.83	22.13	22.10	2
		25	25	21.77	22.07	22.04	2
		50	0	21.82	22.12	22.09	2



Test Report No.: RF170330W002-5

LTE Band 13							
BW	Modulation	RB Size	RB Offset	Low CH 23205	Mid CH 23230	High CH 23255	MPR
				Frequency 779.5 MHz	Frequency 782.0 MHz	Frequency 784.5 MHz	
5 MHz	QPSK	1	0	24.06	24.08	24.02	0
		1	12	24.03	24.05	23.99	0
		1	24	23.99	24.01	23.95	0
		12	0	23.04	23.06	23.00	1
		12	6	23.00	23.02	22.96	1
		12	13	22.96	22.98	22.92	1
		25	0	23.03	23.05	22.99	1
	16QAM	1	0	23.02	23.04	22.98	1
		1	12	22.99	23.01	22.95	1
		1	24	22.94	22.96	22.90	1
		12	0	22.12	22.14	22.08	2
		12	6	22.07	22.09	22.03	2
		12	13	22.02	22.04	21.98	2
		25	0	22.06	22.08	22.02	2
BW	Modulation	RB Size	RB Offset	CH	CH 23230	CH	MPR
				Frequency MHz	Frequency 782.0 MHz	Frequency MHz	
10 MHz	QPSK	1	0	-	24.15	-	0
		1	24	-	24.12	-	0
		1	49	-	24.00	-	0
		25	0	-	23.14	-	1
		25	12	-	23.11	-	1
		25	25	-	23.08	-	1
		50	0	-	23.12	-	1
	16QAM	1	0	-	23.12	-	1
		1	24	-	23.09	-	1
		1	49	-	23.04	-	1
		25	0	-	22.21	-	2
		25	12	-	22.17	-	2
		25	25	-	22.14	-	2
		50	0	-	22.19	-	2



Test Report No.: RF170330W002-5

EIRP

LTE BAND 4

CHANNEL BANDWIDTH: 1.4MHz QPSK

Channel	Frequency (MHz)	SPA LVL (dBm)	Correction Factor(dB)	EIRP(dBm)	EIRP(mW)	Polarization (H/V)	LIMIT (W)
19957	1710.7	-20.03	41.29	21.26	133.78	H	1
20175	1732.5	-19.05	41.36	22.31	170.22	H	1
20393	1754.3	-19.70	42.74	23.04	201.28	H	1
19957	1710.7	-17.40	44.25	26.85	483.62	V	1
20175	1732.5	-16.48	44.20	27.72	591.56	V	1
20393	1754.3	-16.32	44.09	27.77	597.72	V	1

CHANNEL BANDWIDTH: 1.4MHz 16QAM

Channel	Frequency (MHz)	SPA LVL (dBm)	Correction Factor(dB)	EIRP(dBm)	EIRP(mW)	Polarization (H/V)	LIMIT (W)
19957	1710.7	-20.90	41.29	20.39	109.50	H	1
20175	1732.5	-19.98	41.36	21.38	137.40	H	1
20393	1754.3	-20.66	42.74	22.08	161.36	H	1
19957	1710.7	-18.27	44.25	25.98	395.82	V	1
20175	1732.5	-17.41	44.20	26.79	477.53	V	1
20393	1754.3	-17.28	44.09	26.81	479.18	V	1

LTE BAND 4

CHANNEL BANDWIDTH: 3MHz QPSK

Channel	Frequency (MHz)	SPA LVL (dBm)	Correction Factor(dB)	EIRP(dBm)	EIRP(mW)	Polarization (H/V)	LIMIT (W)
19965	1711.5	-20.01	41.27	21.26	133.57	H	1
20175	1732.5	-19.11	41.36	22.25	167.88	H	1
20385	1753.5	-19.65	42.76	23.11	204.50	H	1
19965	1711.5	-17.38	44.26	26.88	487.75	V	1
20175	1732.5	-16.54	44.20	27.66	583.45	V	1
20385	1753.5	-16.27	44.23	27.96	625.46	V	1



Test Report No.: RF170330W002-5

CHANNEL BANDWIDTH: 3MHz 16QAM

Channel	Frequency (MHz)	SPA LVL (dBm)	Correction Factor(dB)	EIRP(dBm)	EIRP(mW)	Polarization (H/V)	LIMIT (W)
19965	1711.5	-21.08	41.27	20.19	104.40	H	1
20175	1732.5	-20.00	41.36	21.36	136.77	H	1
20385	1753.5	-20.64	42.76	22.12	162.82	H	1
19965	1711.5	-18.45	44.26	25.81	381.24	V	1
20175	1732.5	-17.43	44.20	26.77	475.34	V	1
20385	1753.5	-17.26	44.23	26.97	497.97	V	1

LTE BAND 4

CHANNEL BANDWIDTH: 5MHz QPSK

Channel	Frequency (MHz)	SPA LVL (dBm)	Correction Factor(dB)	EIRP(dBm)	EIRP(mW)	Polarization (H/V)	LIMIT (W)
19975	1712.5	-20.07	41.39	21.32	135.49	H	1
20175	1732.5	-19.06	41.36	22.30	169.82	H	1
20375	1752.5	-19.60	42.63	23.03	200.86	H	1
19975	1712.5	-17.44	44.17	26.73	470.54	V	1
20175	1732.5	-16.49	44.20	27.71	590.20	V	1
20375	1752.5	-16.22	44.35	28.13	649.38	V	1

CHANNEL BANDWIDTH: 5MHz 16QAM

Channel	Frequency (MHz)	SPA LVL (dBm)	Correction Factor(dB)	EIRP(dBm)	EIRP(mW)	Polarization (H/V)	LIMIT (W)
19975	1712.5	-20.90	41.39	20.49	111.92	H	1
20175	1732.5	-20.08	41.36	21.28	134.28	H	1
20375	1752.5	-20.70	42.63	21.93	155.92	H	1
19975	1712.5	-18.27	44.17	25.90	388.69	V	1
20175	1732.5	-17.51	44.20	26.69	466.66	V	1
20375	1752.5	-17.32	44.35	27.03	504.08	V	1



Test Report No.: RF170330W002-5

LTE BAND 4

CHANNEL BANDWIDTH: 10MHz QPSK

Channel	Frequency (MHz)	SPA LVL (dBm)	Correction Factor(dB)	EIRP(dBm)	EIRP(mW)	Polarization (H/V)	LIMIT (W)
20000	1715.0	-19.88	41.49	21.61	144.74	H	1
20175	1732.5	-19.00	41.36	22.36	172.19	H	1
20350	1750.0	-19.47	42.28	22.81	191.12	H	1
20000	1715.0	-17.25	44.06	26.81	480.06	V	1
20175	1732.5	-16.43	44.20	27.77	598.41	V	1
20350	1750.0	-16.09	44.43	28.34	682.34	V	1

CHANNEL BANDWIDTH: 10MHz 16QAM

Channel	Frequency (MHz)	SPA LVL (dBm)	Correction Factor(dB)	EIRP(dBm)	EIRP(mW)	Polarization (H/V)	LIMIT (W)
20000	1715.0	-21.03	41.49	20.46	111.07	H	1
20175	1732.5	-20.10	41.36	21.26	133.66	H	1
20350	1750.0	-20.63	42.28	21.65	146.32	H	1
20000	1715.0	-18.40	44.06	25.66	368.38	V	1
20175	1732.5	-17.53	44.20	26.67	464.52	V	1
20350	1750.0	-17.25	44.43	27.18	522.40	V	1

LTE BAND 4

CHANNEL BANDWIDTH: 15MHz QPSK

Channel	Frequency (MHz)	SPA LVL (dBm)	Correction Factor(dB)	EIRP(dBm)	EIRP(mW)	Polarization (H/V)	LIMIT (W)
20025	1717.5	-19.89	41.34	21.45	139.57	H	1
20175	1732.5	-19.07	41.36	22.29	169.43	H	1
20325	1747.5	-19.54	42.09	22.55	179.72	H	1
20025	1717.5	-17.26	44.04	26.78	476.87	V	1
20175	1732.5	-16.50	44.20	27.70	588.84	V	1
20325	1747.5	-16.16	44.22	28.06	639.00	V	1



Test Report No.: RF170330W002-5

CHANNEL BANDWIDTH: 15MHz 16QAM

Channel	Frequency (MHz)	SPA LVL (dBm)	Correction Factor(dB)	EIRP(dBm)	EIRP(mW)	Polarization (H/V)	LIMIT (W)
20025	1717.5	-20.75	41.34	20.59	114.50	H	1
20175	1732.5	-19.94	41.36	21.42	138.68	H	1
20325	1747.5	-20.39	42.09	21.70	147.77	H	1
20025	1717.5	-18.12	44.04	25.92	391.20	V	1
20175	1732.5	-17.37	44.20	26.83	481.95	V	1
20325	1747.5	-17.01	44.22	27.21	525.41	V	1

LTE BAND 4

CHANNEL BANDWIDTH: 20MHz QPSK

Channel	Frequency (MHz)	SPA LVL (dBm)	Correction Factor(dB)	EIRP(dBm)	EIRP(mW)	Polarization (H/V)	LIMIT (W)
20050	1720.0	-20.47	41.28	20.81	120.53	H	1
20175	1732.5	-19.52	41.36	21.84	152.79	H	1
20300	1745.0	-20.12	41.96	21.84	152.65	H	1
20050	1720.0	-17.84	44.14	26.30	426.09	V	1
20175	1732.5	-16.95	44.20	27.25	530.40	V	1
20300	1745.0	-16.74	43.88	27.14	517.85	V	1

CHANNEL BANDWIDTH: 20MHz 16QAM

Channel	Frequency (MHz)	SPA LVL (dBm)	Correction Factor(dB)	EIRP(dBm)	EIRP(mW)	Polarization (H/V)	LIMIT (W)
20050	1720.0	-21.40	41.28	19.88	97.30	H	1
20175	1732.5	-20.59	41.36	20.77	119.43	H	1
20300	1745.0	-20.95	41.96	21.01	126.10	H	1
20050	1720.0	-18.77	44.14	25.37	343.95	V	1
20175	1732.5	-18.02	44.20	26.18	414.57	V	1
20300	1745.0	-17.57	43.88	26.31	427.76	V	1

REMARKS: 1. EIRP Output Power (dBm) = SPA LVL (dBm) + Correction Factor (dB).
 2. Correction factor (dB) = Free Space Loss + Antenna Factor + Cable Loss



Test Report No.: RF170330W002-5

LTE BAND 12

CHANNEL BANDWIDTH: 1.4MHz QPSK

Channel	Frequency (MHz)	SPA LVL (dBm)	Correction Factor(dB)	ERP(dBm)	ERP(mW)	Polarization (H/V)	LIMIT (W)
23017	699.7	-7.61	32.77	23.01	199.99	H	3
23095	707.5	-7.41	33.23	23.67	232.81	H	3
23173	715.3	-7.95	33.14	23.04	201.28	H	3
23017	699.7	-14.48	32.42	15.79	37.90	V	3
23095	707.5	-14.65	32.60	15.80	38.02	V	3
23173	715.3	-15.12	32.19	14.92	31.02	V	3

CHANNEL BANDWIDTH: 1.4MHz 16QAM

Channel	Frequency (MHz)	SPA LVL (dBm)	Correction Factor(dB)	ERP(dBm)	ERP(mW)	Polarization (H/V)	LIMIT (W)
23017	699.7	-8.44	32.77	22.18	165.20	H	3
23095	707.5	-8.43	33.23	22.65	184.08	H	3
23173	715.3	-9.05	33.14	21.94	156.24	H	3
23017	699.7	-15.31	32.42	14.96	31.30	V	3
23095	707.5	-15.67	32.60	14.78	30.06	V	3
23173	715.3	-16.22	32.19	13.82	24.08	V	3

LTE BAND 12

CHANNEL BANDWIDTH: 3MHz QPSK

Channel	Frequency (MHz)	SPA LVL (dBm)	Correction Factor(dB)	ERP(dBm)	ERP(mW)	Polarization (H/V)	LIMIT (W)
23025	700.5	-7.42	32.63	23.06	202.35	H	3
23095	707.5	-7.35	33.23	23.73	236.05	H	3
23165	714.5	-7.82	33.21	23.24	210.62	H	3
23025	700.5	-14.29	32.33	15.89	38.79	V	3
23095	707.5	-14.59	32.60	15.86	38.55	V	3
23165	714.5	-14.99	32.30	15.16	32.82	V	3



Test Report No.: RF170330W002-5

CHANNEL BANDWIDTH: 3MHz 16QAM

Channel	Frequency (MHz)	SPA LVL (dBm)	Correction Factor(dB)	ERP(dBm)	ERP(mW)	Polarization (H/V)	LIMIT (W)
23025	700.5	-8.57	32.63	21.91	155.27	H	3
23095	707.5	-8.45	33.23	22.63	183.23	H	3
23165	714.5	-8.98	33.21	22.08	161.25	H	3
23025	700.5	-15.44	32.33	14.74	29.76	V	3
23095	707.5	-15.69	32.60	14.76	29.92	V	3
23165	714.5	-16.15	32.30	14.00	25.12	V	3

LTE BAND 12

CHANNEL BANDWIDTH: 5MHz QPSK

Channel	Frequency (MHz)	SPA LVL (dBm)	Correction Factor(dB)	ERP(dBm)	ERP(mW)	Polarization (H/V)	LIMIT (W)
23035	701.5	-7.43	32.53	22.95	197.02	H	3
23095	707.5	-7.42	33.23	23.66	232.17	H	3
23155	713.5	-7.89	33.29	23.25	211.20	H	3
23035	701.5	-14.30	32.25	15.80	38.05	V	3
23095	707.5	-14.66	32.60	15.79	37.93	V	3
23155	713.5	-15.06	32.39	15.18	32.93	V	3

CHANNEL BANDWIDTH: 5MHz 16QAM

Channel	Frequency (MHz)	SPA LVL (dBm)	Correction Factor(dB)	ERP(dBm)	ERP(mW)	Polarization (H/V)	LIMIT (W)
23035	701.5	-8.29	32.53	22.09	161.62	H	3
23095	707.5	-8.29	33.23	22.79	190.02	H	3
23155	713.5	-8.74	33.29	22.40	173.66	H	3
23035	701.5	-15.16	32.25	14.94	31.22	V	3
23095	707.5	-15.53	32.60	14.92	31.05	V	3
23155	713.5	-15.91	32.39	14.33	27.08	V	3



Test Report No.: RF170330W002-5

LTE BAND 12

CHANNEL BANDWIDTH: 10MHz QPSK

Channel	Frequency (MHz)	SPA LVL (dBm)	Correction Factor(dB)	ERP(dBm)	ERP(mW)	Polarization (H/V)	LIMIT (W)
23060	704.0	-8.01	32.68	22.52	178.77	H	3
23095	707.5	-7.87	33.23	23.21	209.41	H	3
23130	711.0	-8.47	33.39	22.77	189.10	H	3
23060	704.0	-14.88	32.37	15.34	34.18	V	3
23095	707.5	-15.11	32.60	15.34	34.20	V	3
23130	711.0	-15.64	32.56	14.77	29.96	V	3

CHANNEL BANDWIDTH: 10MHz 16QAM

Channel	Frequency (MHz)	SPA LVL (dBm)	Correction Factor(dB)	ERP(dBm)	ERP(mW)	Polarization (H/V)	LIMIT (W)
23060	704.0	-8.94	32.68	21.59	144.31	H	3
23095	707.5	-8.94	33.23	22.14	163.68	H	3
23130	711.0	-9.30	33.39	21.94	156.21	H	3
23060	704.0	-15.81	32.37	14.41	27.59	V	3
23095	707.5	-16.18	32.60	14.27	26.73	V	3
23130	711.0	-16.47	32.56	13.94	24.75	V	3

REMARKS: 1. ERP Output Power (dBm) = SPA LVL (dBm) + Correction Factor (dB) -2.15(dB).
 2. Correction factor (dB) = Free Space Loss + Antenna Factor + Cable Loss

LTE BAND 13

CHANNEL BANDWIDTH: 5MHz QPSK

Channel	Frequency (MHz)	SPA LVL (dBm)	Correction Factor(dB)	ERP(dBm)	ERP(mW)	Polarization (H/V)	LIMIT (W)
23205	779.5	-8.26	32.60	22.19	165.58	H	3
23230	782.0	-7.28	32.75	23.32	214.78	H	3
23255	784.5	-6.96	33.08	23.97	249.46	H	3
23205	779.5	-18.32	31.54	11.07	12.79	V	3
23230	782.0	-17.37	31.70	12.18	16.52	V	3
23255	784.5	-16.98	31.97	12.84	19.23	V	3



Test Report No.: RF170330W002-5

CHANNEL BANDWIDTH: 5MHz 16QAM

Channel	Frequency (MHz)	SPA LVL (dBm)	Correction Factor(dB)	ERP(dBm)	ERP(mW)	Polarization (H/V)	LIMIT (W)
23205	779.5	-9.22	32.60	21.23	132.74	H	3
23230	782.0	-8.34	32.75	22.26	168.27	H	3
23255	784.5	-7.87	33.08	23.06	202.30	H	3
23205	779.5	-19.25	31.54	10.14	10.33	V	3
23230	782.0	-18.19	31.70	11.36	13.68	V	3
23255	784.5	-17.79	31.97	12.03	15.96	V	3

LTE BAND 13

CHANNEL BANDWIDTH: 10MHz QPSK

Channel	Frequency (MHz)	SPA LVL (dBm)	Correction Factor(dB)	ERP(dBm)	ERP(mW)	Polarization (H/V)	LIMIT (W)
23230	782.0	-8.34	32.75	22.26	168.27	H	3
23230	782.0	-18.66	31.70	10.89	12.27	V	3

CHANNEL BANDWIDTH: 10MHz 16QAM

Channel	Frequency (MHz)	SPA LVL (dBm)	Correction Factor(dB)	ERP(dBm)	ERP(mW)	Polarization (H/V)	LIMIT (W)
23230	782.0	-9.21	32.75	21.39	137.72	H	3
23230	782.0	-19.56	31.70	9.99	9.98	V	3

REMARKS: 1. ERP Output Power (dBm) = SPA LVL (dBm) + Correction Factor (dB) -2.15(dB).
2. Correction factor (dB) = Free Space Loss + Antenna Factor + Cable Loss

4.2 FREQUENCY STABILITY MEASUREMENT

4.2.1 LIMITS OF FREQUENCY STABILITY MEASUREMENT

The frequency stability shall be sufficient to ensure that the fundamental emissions stay within the authorized bands of operation.

4.2.2 TEST PROCEDURE

- a. Device is placed at the oven room. The oven room could control the temperatures and humidity. Power warm up is at least 15 min and power applied should perform before recording frequency error.
- b. EUT is connected the external power supply to control the DC input power. The test voltage range is from minimum to maximum working voltage. Each step shall be record the frequency error rate.
- c. The temperature range step is 10 degrees in this test items. All temperature levels shall be hold the $\pm 0.5^{\circ}\text{C}$ during the measurement testing. The each temperature step shall be at least 0.5 hours, consider the EUT could be test under the stability condition.

NOTE: The frequency error was recorded frequency error from the communication simulator.

4.2.3 TEST SETUP

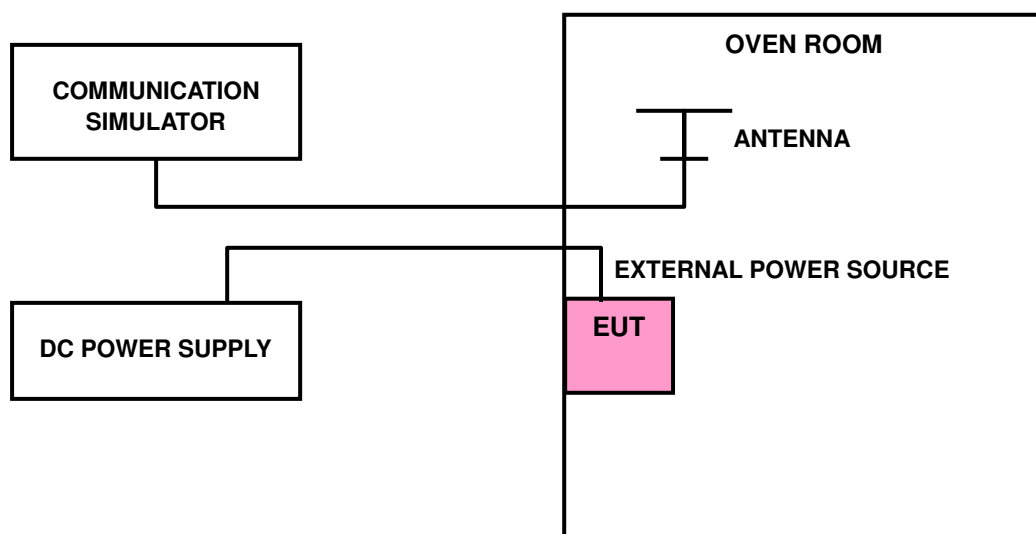



Test Report No.: RF170330W002-5

4.2.4 TEST RESULTS

LTE BAND 4

FREQUENCY ERROR VS. VOLTAGE

VOLTAGE (Volts)	1.4MHz		LIMIT (ppm)
	FREQUENCY ERROR (ppm)		
	Low Channel	High Channel	
3.85	0.0013	0.0012	2.5
3.4	-0.0015	-0.0014	2.5
4.4	0.0014	0.0013	2.5

NOTE: The applicant defined the normal working voltage of the battery is from 3.4Vdc to 4.4Vdc.

FREQUENCY ERROR vs. TEMPERATURE.

TEMP. (°C)	1.4MHz		LIMIT (ppm)
	FREQUENCY ERROR (ppm)		
	Low Channel	High Channel	
-30	-0.0058	-0.0057	2.5
-20	-0.0051	-0.0051	2.5
-10	-0.0044	-0.0044	2.5
0	-0.0038	-0.0037	2.5
10	-0.0031	-0.0031	2.5
20	-0.0025	-0.0025	2.5
30	-0.0018	-0.0019	2.5
40	-0.0012	-0.0012	2.5
50	-0.0005	-0.0006	2.5
60	0.0002	0.0001	2.5



Test Report No.: RF170330W002-5

FREQUENCY ERROR VS. VOLTAGE

VOLTAGE (Volts)	3MHz		LIMIT (ppm)
	FREQUENCY ERROR (ppm)		
	Low Channel	High Channel	
3.85	0.0013	0.0012	2.5
3.4	-0.0015	-0.0013	2.5
4.4	0.0013	0.0012	2.5

NOTE: The applicant defined the normal working voltage of the battery is from 3.4Vdc to 4.4Vdc.

FREQUENCY ERROR vs. TEMPERATURE.

TEMP. (°C)	3MHz		LIMIT (ppm)
	FREQUENCY ERROR (ppm)		
	Low Channel	High Channel	
-30	-0.0057	-0.0058	2.5
-20	-0.0051	-0.0052	2.5
-10	-0.0044	-0.0046	2.5
0	-0.0038	-0.0039	2.5
10	-0.0031	-0.0033	2.5
20	-0.0024	-0.0026	2.5
30	-0.0018	-0.0020	2.5
40	-0.0011	-0.0013	2.5
50	-0.0004	-0.0009	2.5
60	0.0002	-0.0001	2.5



Test Report No.: RF170330W002-5

FREQUENCY ERROR VS. VOLTAGE

VOLTAGE (Volts)	5MHz		LIMIT (ppm)
	FREQUENCY ERROR (ppm)		
	Low Channel	High Channel	
3.85	0.0012	0.0011	2.5
3.4	-0.0014	-0.0013	2.5
4.4	0.0013	0.0011	2.5

NOTE: The applicant defined the normal working voltage of the battery is from 3.4Vdc to 4.4Vdc.

FREQUENCY ERROR vs. TEMPERATURE.

TEMP. (°C)	5MHz		LIMIT (ppm)
	FREQUENCY ERROR (ppm)		
	Low Channel	High Channel	
-30	-0.0056	-0.0057	2.5
-20	-0.0050	-0.0050	2.5
-10	-0.0043	-0.0044	2.5
0	-0.0037	-0.0037	2.5
10	-0.0031	-0.0031	2.5
20	-0.0024	-0.0024	2.5
30	-0.0018	-0.0017	2.5
40	-0.0012	-0.0011	2.5
50	-0.0005	-0.0005	2.5
60	0.0001	0.0001	2.5



Test Report No.: RF170330W002-5

FREQUENCY ERROR VS. VOLTAGE

VOLTAGE (Volts)	10MHz		LIMIT (ppm)
	FREQUENCY ERROR (ppm)		
	Low Channel	High Channel	
3.85	0.0010	0.0010	2.5
3.4	-0.0013	-0.0012	2.5
4.4	0.0011	0.0011	2.5

NOTE: The applicant defined the normal working voltage of the battery is from 3.4Vdc to 4.4Vdc.

FREQUENCY ERROR vs. TEMPERATURE.

TEMP. (°C)	10MHz		LIMIT (ppm)
	FREQUENCY ERROR (ppm)		
	Low Channel	High Channel	
-30	-0.0059	-0.0057	2.5
-20	-0.0053	-0.0051	2.5
-10	-0.0046	-0.0044	2.5
0	-0.0039	-0.0038	2.5
10	-0.0032	-0.0032	2.5
20	-0.0025	-0.0025	2.5
30	-0.0018	-0.0019	2.5
40	-0.0012	-0.0013	2.5
50	-0.0005	-0.0007	2.5
60	0.0001	-0.0001	2.5



Test Report No.: RF170330W002-5

FREQUENCY ERROR VS. VOLTAGE

VOLTAGE (Volts)	15MHz		LIMIT (ppm)
	FREQUENCY ERROR (ppm)		
	Low Channel	High Channel	
3.85	0.0010	0.0009	2.5
3.4	-0.0013	-0.0012	2.5
4.4	0.0011	0.0010	2.5

NOTE: The applicant defined the normal working voltage of the battery is from 3.4Vdc to 4.4Vdc.

FREQUENCY ERROR vs. TEMPERATURE.

TEMP. (°C)	15MHz		LIMIT (ppm)
	FREQUENCY ERROR (ppm)		
	Low Channel	High Channel	
-30	-0.0060	-0.0058	2.5
-20	-0.0053	-0.0052	2.5
-10	-0.0047	-0.0044	2.5
0	-0.0040	-0.0038	2.5
10	-0.0033	-0.0031	2.5
20	-0.0025	-0.0025	2.5
30	-0.0019	-0.0018	2.5
40	-0.0013	-0.0012	2.5
50	-0.0006	-0.0005	2.5
60	-0.0001	0.0001	2.5



Test Report No.: RF170330W002-5

FREQUENCY ERROR VS. VOLTAGE

VOLTAGE (Volts)	20MHz		LIMIT (ppm)
	FREQUENCY ERROR (ppm)		
	Low Channel	High Channel	
3.85	0.0010	0.0008	2.5
3.4	-0.0012	-0.0011	2.5
4.4	0.0011	0.0009	2.5

NOTE: The applicant defined the normal working voltage of the battery is from 3.4Vdc to 4.4Vdc.

FREQUENCY ERROR vs. TEMPERATURE.

TEMP. (°C)	20MHz		LIMIT (ppm)
	FREQUENCY ERROR (ppm)		
	Low Channel	High Channel	
-30	-0.0060	-0.0058	2.5
-20	-0.0054	-0.0052	2.5
-10	-0.0047	-0.0045	2.5
0	-0.0041	-0.0037	2.5
10	-0.0034	-0.0031	2.5
20	-0.0025	-0.0024	2.5
30	-0.0019	-0.0017	2.5
40	-0.0013	-0.0010	2.5
50	-0.0006	-0.0003	2.5
60	0.0001	0.0002	2.5



Test Report No.: RF170330W002-5

LTE BAND 12

FREQUENCY ERROR VS. VOLTAGE

VOLTAGE (Volts)	1.4MHz		LIMIT (ppm)
	FREQUENCY ERROR (ppm)		
	Low Channel	High Channel	
3.85	0.0028	0.0030	2.5
3.4	-0.0032	-0.0032	2.5
4.4	0.0030	0.0031	2.5

NOTE: The applicant defined the normal working voltage of the battery is from 3.4Vdc to 4.4Vdc.

FREQUENCY ERROR vs. TEMPERATURE.

TEMP. (°C)	1.4MHz		LIMIT (ppm)
	FREQUENCY ERROR (ppm)		
	Low Channel	High Channel	
-30	-0.0148	-0.0147	2.5
-20	-0.0132	-0.0132	2.5
-10	-0.0115	-0.0113	2.5
0	-0.0098	-0.0096	2.5
10	-0.0080	-0.0077	2.5
20	-0.0063	-0.0061	2.5
30	-0.0048	-0.0045	2.5
40	-0.0031	-0.0027	2.5
50	-0.0015	-0.0012	2.5
60	0.0002	0.0004	2.5



Test Report No.: RF170330W002-5

FREQUENCY ERROR VS. VOLTAGE

VOLTAGE (Volts)	3MHz		LIMIT (ppm)
	FREQUENCY ERROR (ppm)		
	Low Channel	High Channel	
3.85	0.0029	0.0028	2.5
3.4	-0.0034	-0.0030	2.5
4.4	0.0031	0.0029	2.5

NOTE: The applicant defined the normal working voltage of the battery is from 3.4Vdc to 4.4Vdc.

FREQUENCY ERROR vs. TEMPERATURE.

TEMP. (°C)	3MHz		LIMIT (ppm)
	FREQUENCY ERROR (ppm)		
	Low Channel	High Channel	
-30	-0.0147	-0.0146	2.5
-20	-0.0131	-0.0130	2.5
-10	-0.0114	-0.0115	2.5
0	-0.0098	-0.0100	2.5
10	-0.0081	-0.0082	2.5
20	-0.0062	-0.0066	2.5
30	-0.0045	-0.0047	2.5
40	-0.0029	-0.0031	2.5
50	-0.0014	-0.0016	2.5
60	0.0003	0.0002	2.5



Test Report No.: RF170330W002-5

FREQUENCY ERROR VS. VOLTAGE

VOLTAGE (Volts)	5MHz		LIMIT (ppm)
	FREQUENCY ERROR (ppm)		
	Low Channel	High Channel	
3.85	0.0031	0.0029	2.5
3.4	-0.0035	-0.0033	2.5
4.4	0.0032	0.0030	2.5

NOTE: The applicant defined the normal working voltage of the battery is from 3.4Vdc to 4.4Vdc.

FREQUENCY ERROR vs. TEMPERATURE.

TEMP. (°C)	5MHz		LIMIT (ppm)
	FREQUENCY ERROR (ppm)		
	Low Channel	High Channel	
-30	-0.0145	-0.0141	2.5
-20	-0.0128	-0.0125	2.5
-10	-0.0112	-0.0108	2.5
0	-0.0095	-0.0092	2.5
10	-0.0078	-0.0076	2.5
20	-0.0062	-0.0061	2.5
30	-0.0044	-0.0044	2.5
40	-0.0028	-0.0029	2.5
50	-0.0012	-0.0013	2.5
60	0.0005	0.0003	2.5



Test Report No.: RF170330W002-5

FREQUENCY ERROR VS. VOLTAGE

VOLTAGE (Volts)	10MHz		LIMIT (ppm)
	FREQUENCY ERROR (ppm)		
	Low Channel	High Channel	
3.85	0.0033	0.0032	2.5
3.4	-0.0039	-0.0036	2.5
4.4	0.0036	0.0033	2.5

NOTE: The applicant defined the normal working voltage of the battery is from 3.4Vdc to 4.4Vdc.

FREQUENCY ERROR vs. TEMPERATURE.

TEMP. (°C)	10MHz		LIMIT (ppm)
	FREQUENCY ERROR (ppm)		
	Low Channel	High Channel	
-30	-0.0140	-0.0136	2.5
-20	-0.0122	-0.0122	2.5
-10	-0.0104	-0.0105	2.5
0	-0.0087	-0.0086	2.5
10	-0.0072	-0.0069	2.5
20	-0.0055	-0.0051	2.5
30	-0.0038	-0.0036	2.5
40	-0.0022	-0.0019	2.5
50	-0.0007	-0.0009	2.5
60	0.0007	0.0005	2.5



LTE BAND 13

FREQUENCY ERROR VS. VOLTAGE

VOLTAGE (Volts)	5MHz		LIMIT (ppm)
	FREQUENCY ERROR (ppm)		
	Low Channel	High Channel	
3.85	0.0021	0.0026	2.5
3.4	-0.0028	-0.0030	2.5
4.4	0.0026	0.0027	2.5

NOTE: The applicant defined the normal working voltage of the battery is from 3.4Vdc to 4.4Vdc.

FREQUENCY ERROR vs. TEMPERATURE.

TEMP. (°C)	5MHz		LIMIT (ppm)
	FREQUENCY ERROR (ppm)		
	Low Channel	High Channel	
-30	-0.0140	-0.0137	2.5
-20	-0.0124	-0.0118	2.5
-10	-0.0110	-0.0103	2.5
0	-0.0094	-0.0087	2.5
10	-0.0078	-0.0071	2.5
20	-0.0063	-0.0056	2.5
30	-0.0046	-0.0040	2.5
40	-0.0031	-0.0024	2.5
50	-0.0016	-0.0009	2.5
60	0.0001	0.0004	2.5



Test Report No.: RF170330W002-5

FREQUENCY ERROR VS. VOLTAGE

VOLTAGE (Volts)	10MHz	LIMIT (ppm)
	FREQUENCY ERROR (ppm)	
	Channel 23230	
3.85	0.0022	2.5
3.4	-0.0028	2.5
4.4	0.0026	2.5

NOTE: The applicant defined the normal working voltage of the battery is from 3.4Vdc to 4.4Vdc.

FREQUENCY ERROR vs. TEMPERATURE.

TEMP. (°C)	10MHz	LIMIT (ppm)
	FREQUENCY ERROR (ppm)	
	Channel 23230	
-30	-0.0135	2.5
-20	-0.0121	2.5
-10	-0.0104	2.5
0	-0.0090	2.5
10	-0.0075	2.5
20	-0.0059	2.5
30	-0.0043	2.5
40	-0.0028	2.5
50	-0.0015	2.5
60	0.0002	2.5

4.3 OCCUPIED BANDWIDTH MEASUREMENT

4.3.1 LIMITS OF OCCUPIED BANDWIDTH MEASUREMENT

The width of a frequency band such that, below the lower and above the upper frequency limits, the mean powers emitted are each equal to a specified percentage 0.5 %of the total mean power of a given emission.

4.3.2 TEST SETUP

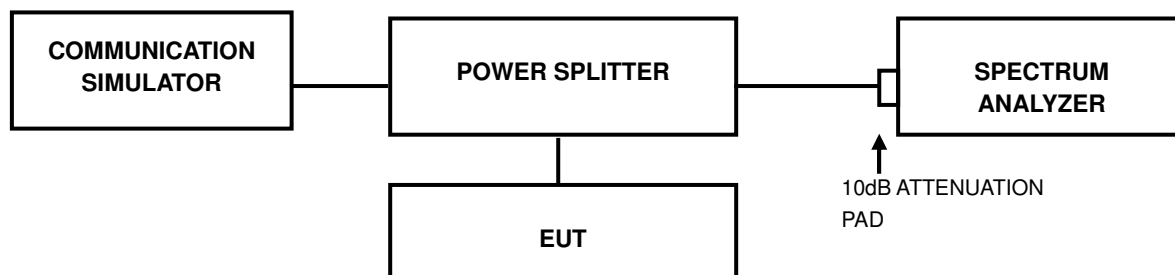

4.3.3 TEST PROCEDURES

- The conducted occupied bandwidth used the power splitter via EUT RF power connector between simulation base station and spectrum analyzer.
- Use OBW measurement function of Spectrum analyzer to measure 99 % occupied bandwidth.



4.3.4 TEST RESULTS

LTE BAND 4

CHANNEL BANDWIDTH: 1.4MHz				CHANNEL BANDWIDTH: 3MHz			
CHANNEL	Frequency (MHz)	99% OCCUPIED Bandwidth (MHz)		CHANNEL	Frequency (MHz)	99% OCCUPIED Bandwidth (MHz)	
		QPSK	16QAM			QPSK	16QAM
19957	1710.7	1.08	1.09	19965	1711.5	2.68	2.68
20175	1732.5	1.09	1.08	20175	1732.5	2.68	2.68
20393	1754.3	1.09	1.08	20385	1753.5	2.68	2.68

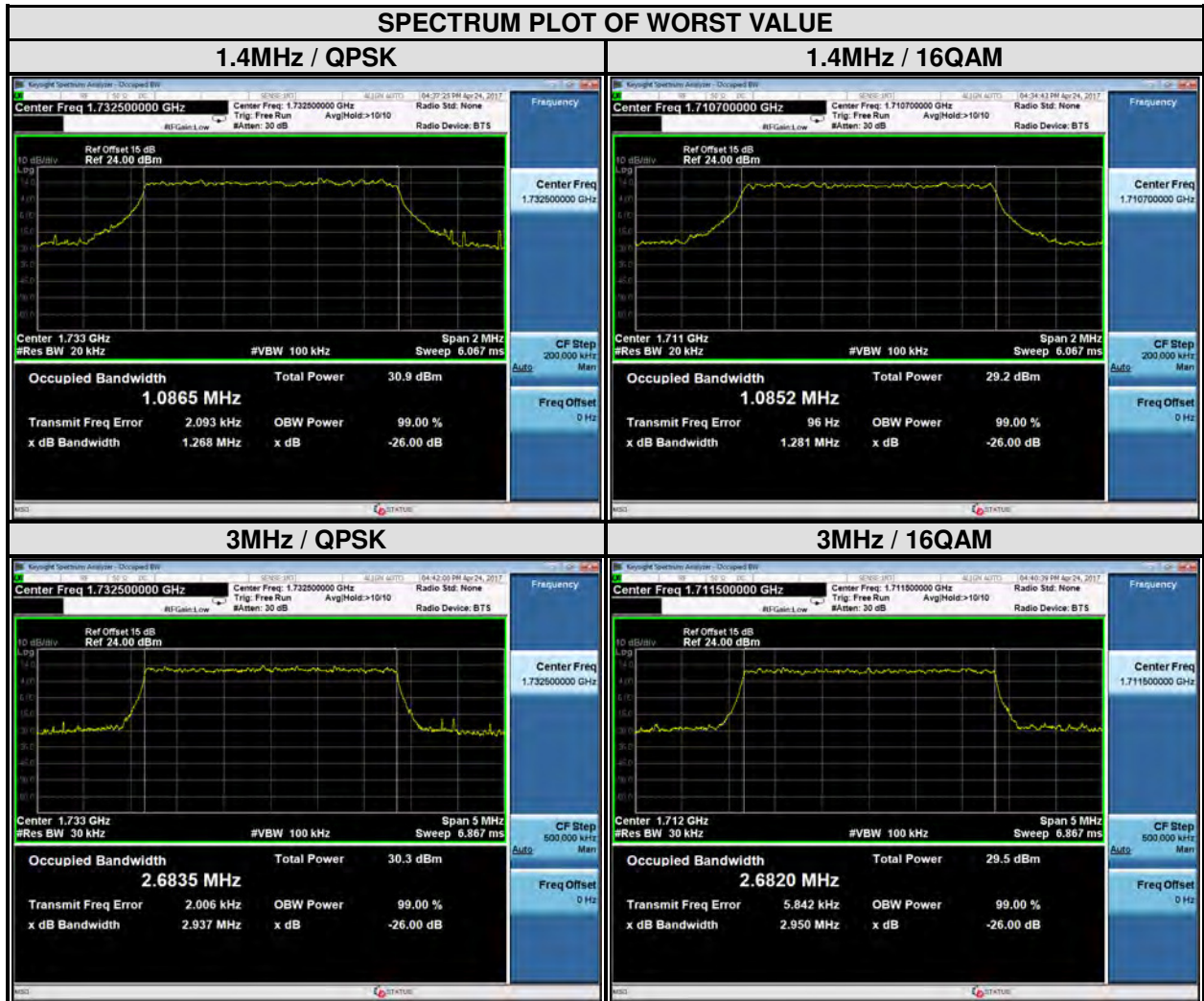



LTE BAND 4

CHANNEL BANDWIDTH: 5MHz				CHANNEL BANDWIDTH: 10MHz			
CHANNEL	Frequency (MHz)	99% OCCUPIED Bandwidth (MHz)		CHANNEL	Frequency (MHz)	99% OCCUPIED Bandwidth (MHz)	
		QPSK	16QAM			QPSK	16QAM
19975	1712.5	4.48	4.46	20000	1715	8.91	8.90
20175	1732.5	4.47	4.46	20175	1732.5	8.92	8.93
20375	1752.5	4.47	4.47	20350	1750	8.92	8.92





Test Report No.: RF170330W002-5

LTE BAND 4

CHANNEL BANDWIDTH: 15MHz				CHANNEL BANDWIDTH: 20MHz			
CHANNEL	FREQUENCY (MHz)	99% OCCUPIED BANDWIDTH (MHz)		CHANNEL	FREQUENCY (MHz)	99% OCCUPIED BANDWIDTH (MHz)	
		QPSK	16QAM			QPSK	16QAM
20025	1717.5	13.37	13.33	20050	1720	17.83	17.80
20175	1732.5	13.36	13.35	20175	1732.5	17.88	17.80
20325	1747.5	13.34	13.35	20300	1745	17.85	17.79





Test Report No.: RF170330W002-5

LTE BAND 12

CHANNEL BANDWIDTH: 1.4MHz				CHANNEL BANDWIDTH: 3MHz			
CHANNEL	FREQUENCY (MHz)	99% OCCUPIED BANDWIDTH (MHz)		CHANNEL	FREQUENCY (MHz)	99% OCCUPIED BANDWIDTH (MHz)	
		QPSK	16QAM			QPSK	16QAM
23017	699.7	1.08	1.08	23025	700.5	2.68	2.68
23095	707.5	1.09	1.08	23095	707.5	2.68	2.68
23173	715.3	1.09	1.08	23165	714.5	2.68	2.68

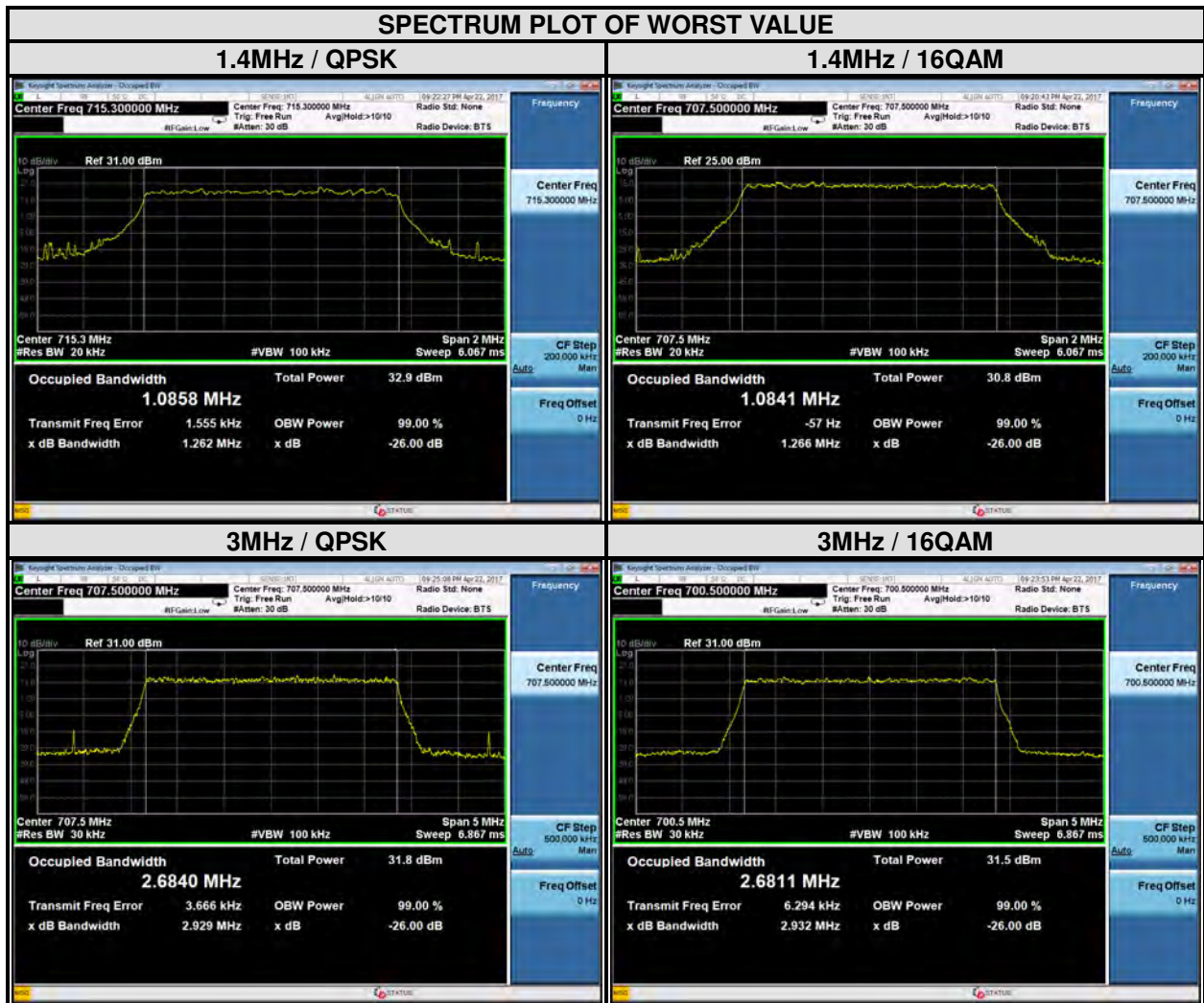

LTE BAND 12

CHANNEL BANDWIDTH: 5MHz				CHANNEL BANDWIDTH: 10MHz			
CHANNEL	Frequency (MHz)	99% OCCUPIED Bandwidth (MHz)		CHANNEL	Frequency (MHz)	99% OCCUPIED Bandwidth (MHz)	
		QPSK	16QAM			QPSK	16QAM
23035	701.5	4.47	4.46	23060	704	8.91	8.88
23095	707.5	4.47	4.46	23095	707.5	8.92	8.94
23155	713.5	4.46	4.45	23130	711	8.93	8.92

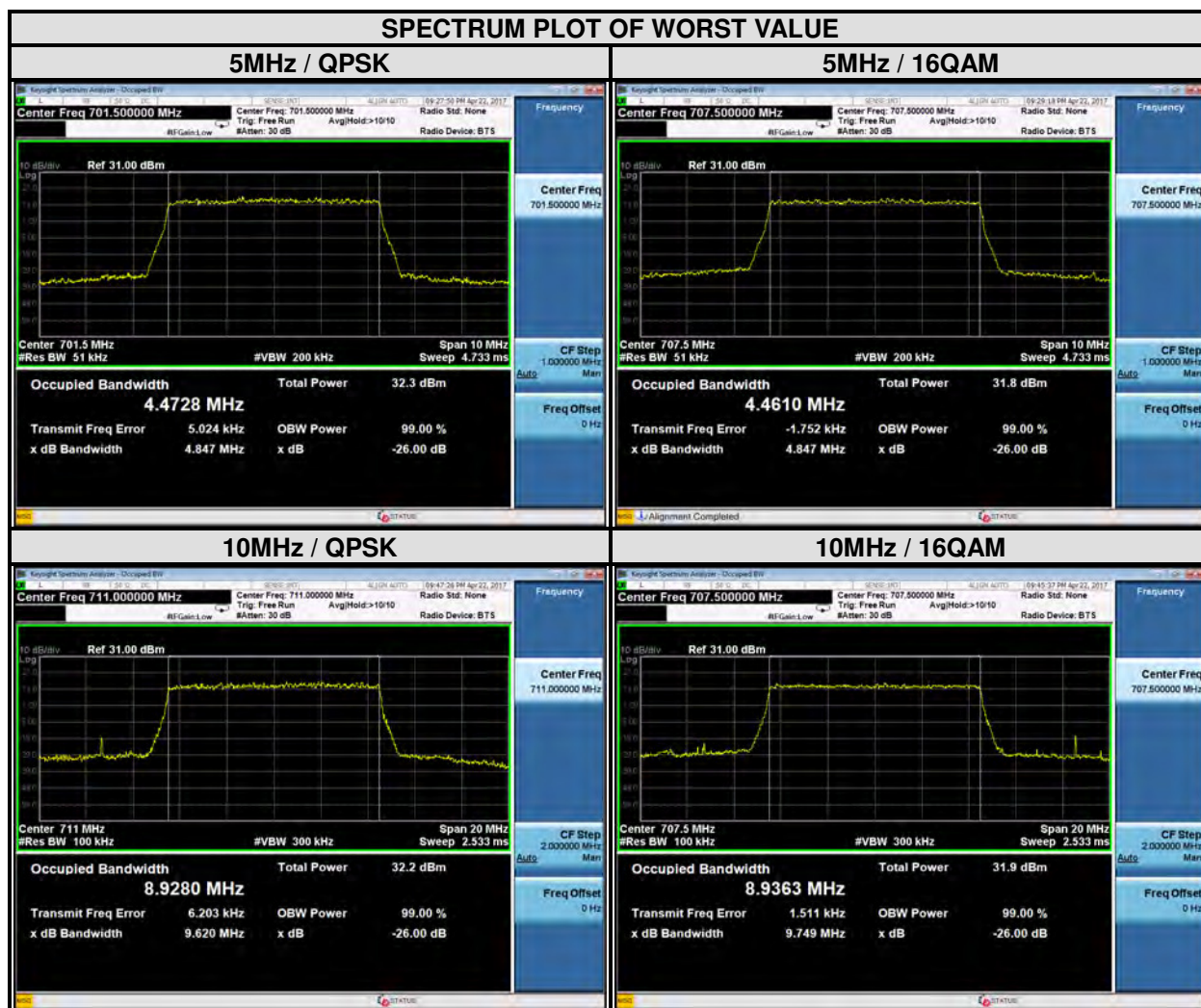



LTE BAND 13

CHANNEL BANDWIDTH: 5MHz				CHANNEL BANDWIDTH: 10MHz			
CHANNEL	Frequency (MHz)	99% OCCUPIED Bandwidth (MHz)		CHANNEL	Frequency (MHz)	99% OCCUPIED Bandwidth (MHz)	
		QPSK	16QAM			QPSK	16QAM
23205	779.5	4.47	4.45	-	-	-	-
23230	782	4.47	4.46	23230	782	8.90	8.88
23255	784.5	4.46	4.46	-	-	-	-



4.4 PEAK TO AVERAGE RATIO

4.4.1 LIMITS OF PEAK TO AVERAGE RATIO MEASUREMENT

In measuring transmissions in this band using an average power technique, the peak to-average ratio (PAR) of the transmission may not exceed 13 dB

4.4.2 TEST SETUP

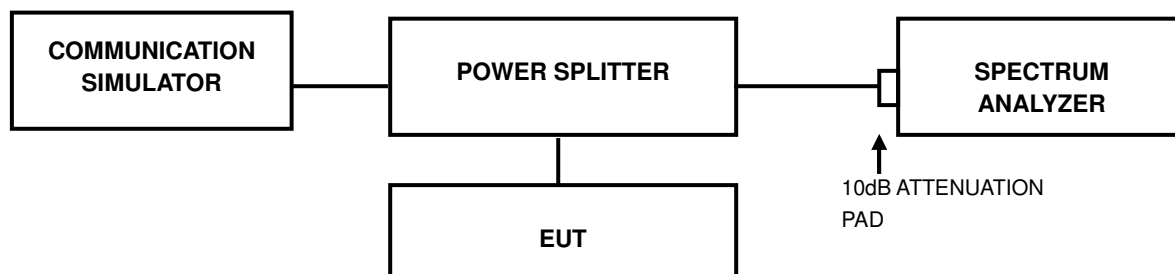

4.4.3 TEST PROCEDURES

1. Set resolution/measurement bandwidth \geq signal's occupied bandwidth;
2. Set the number of counts to a value that stabilizes the measured CCDF curve;
3. Record the maximum PAPR level associated with a probability of 0.1%.



4.4.4 TEST RESULTS

LTE BAND 4

CHANNEL BANDWIDTH: 1.4MHz				CHANNEL BANDWIDTH: 3MHz			
CHANNEL	FREQUENCY (MHz)	PEAK TO AVERAGE RATIO (dB)		CHANNEL	FREQUENCY (MHz)	PEAK TO AVERAGE RATIO (dB)	
		QPSK	16QAM			QPSK	16QAM
19957	1710.7	5.17	6.12	19965	1711.5	5.29	6.21
20175	1732.5	5.48	6.38	20175	1732.5	5.60	6.41
20393	1754.3	5.08	5.89	20385	1753.5	5.27	6.11

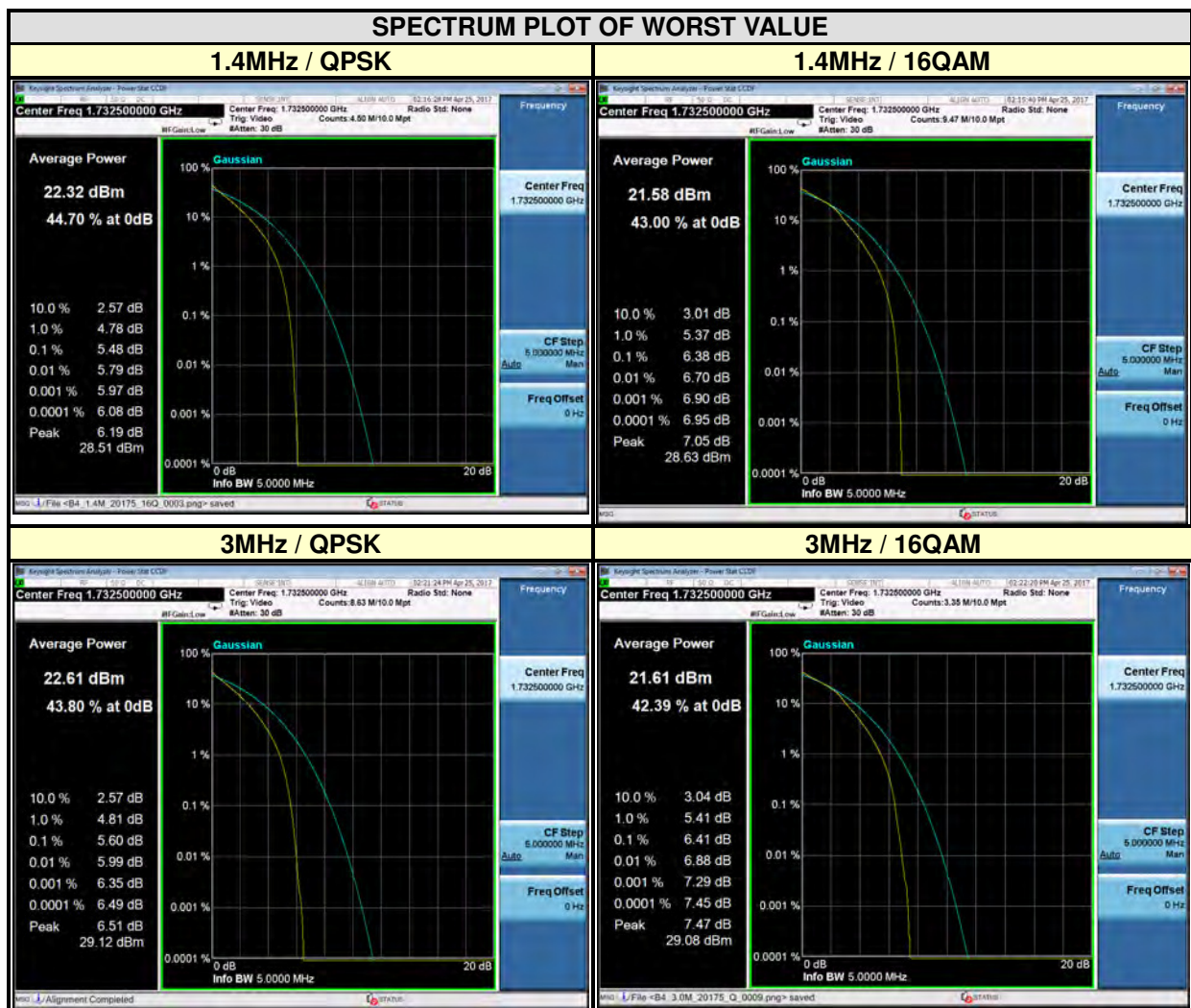



Test Report No.: RF170330W002-5

CHANNEL BANDWIDTH: 5MHz				CHANNEL BANDWIDTH: 10MHz			
CHANNEL	FREQUENCY (MHz)	PEAK TO AVERAGE RATIO (dB)		CHANNEL	FREQUENCY (MHz)	PEAK TO AVERAGE RATIO (dB)	
		QPSK	16QAM			QPSK	16QAM
19975	1712.5	5.28	6.15	20000	1715	5.33	6.16
20175	1732.5	5.41	6.28	20175	1732.5	5.59	6.34
20375	1752.5	5.18	6.05	20350	1750	5.24	6.07

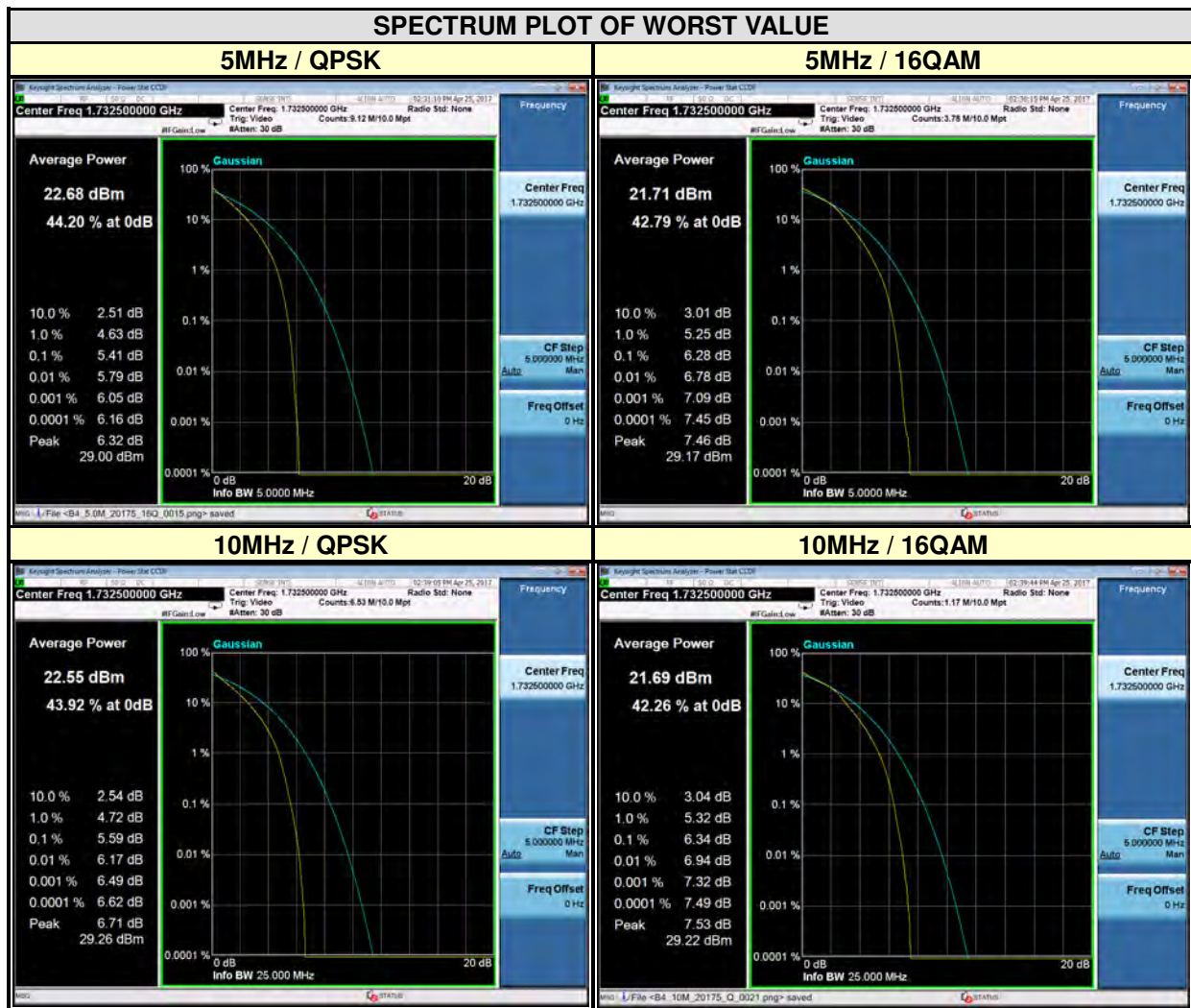



Test Report No.: RF170330W002-5

CHANNEL BANDWIDTH: 15MHz				CHANNEL BANDWIDTH: 20MHz			
CHANNEL	FREQUENCY (MHz)	PEAK TO AVERAGE RATIO (dB)		CHANNEL	FREQUENCY (MHz)	PEAK TO AVERAGE RATIO (dB)	
		QPSK	16QAM			QPSK	16QAM
20025	1717.5	5.23	6.17	20050	1720	5.26	6.13
20175	1732.5	5.44	6.29	20175	1732.5	5.45	6.25
20325	1747.5	5.26	6.15	20300	1745	5.34	6.16

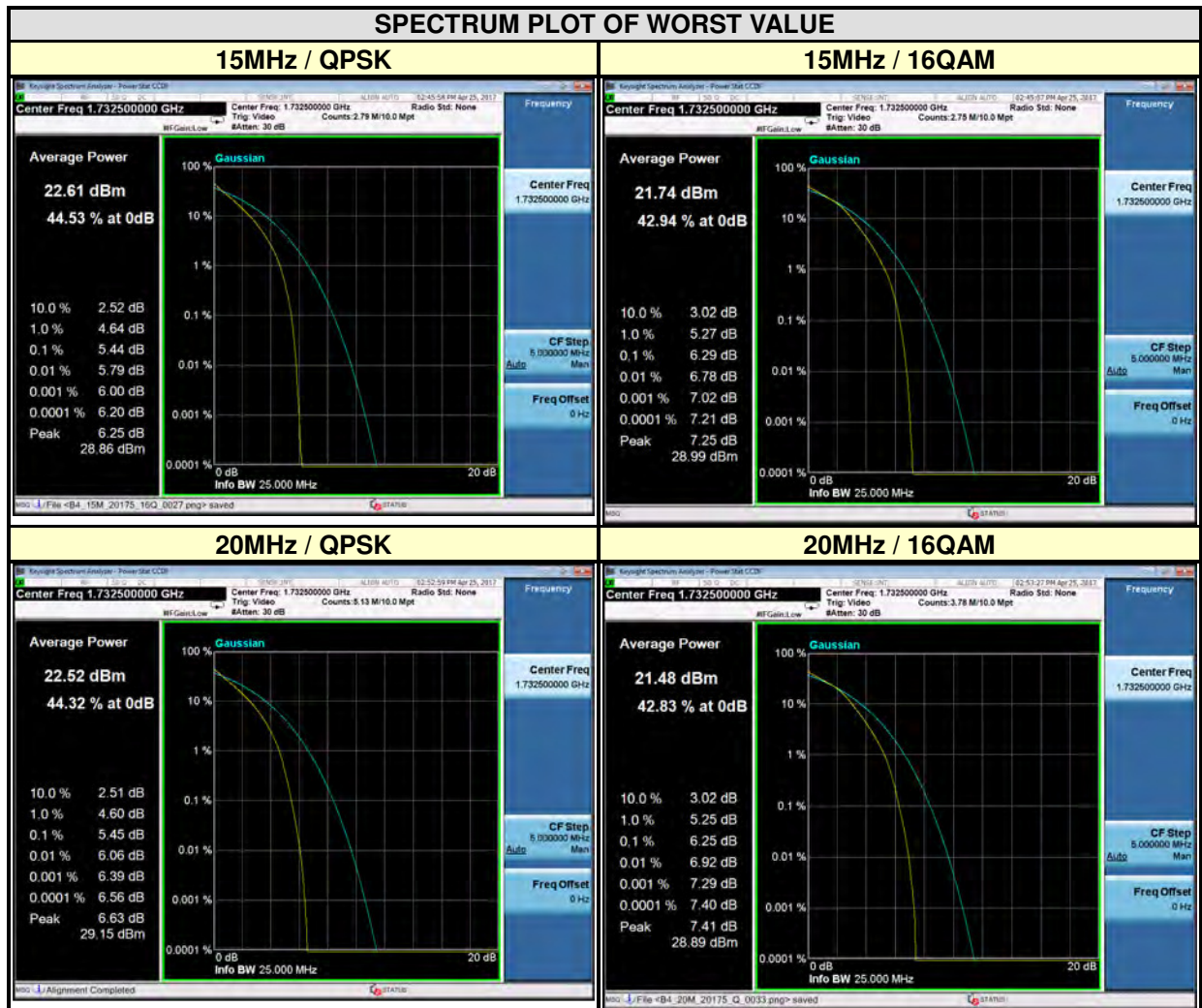



LTE BAND 12

CHANNEL BANDWIDTH: 1.4MHz				CHANNEL BANDWIDTH: 3MHz			
CHANNEL	FREQUENCY (MHz)	PEAK TO AVERAGE RATIO (dB)		CHANNEL	FREQUENCY (MHz)	PEAK TO AVERAGE RATIO (dB)	
		QPSK	16QAM			QPSK	16QAM
23017	699.7	5.08	5.94	23025	700.5	5.20	6.02
23095	707.5	5.23	6.07	23095	707.5	5.36	6.13
23173	715.3	4.72	5.59	23165	714.5	4.90	5.63

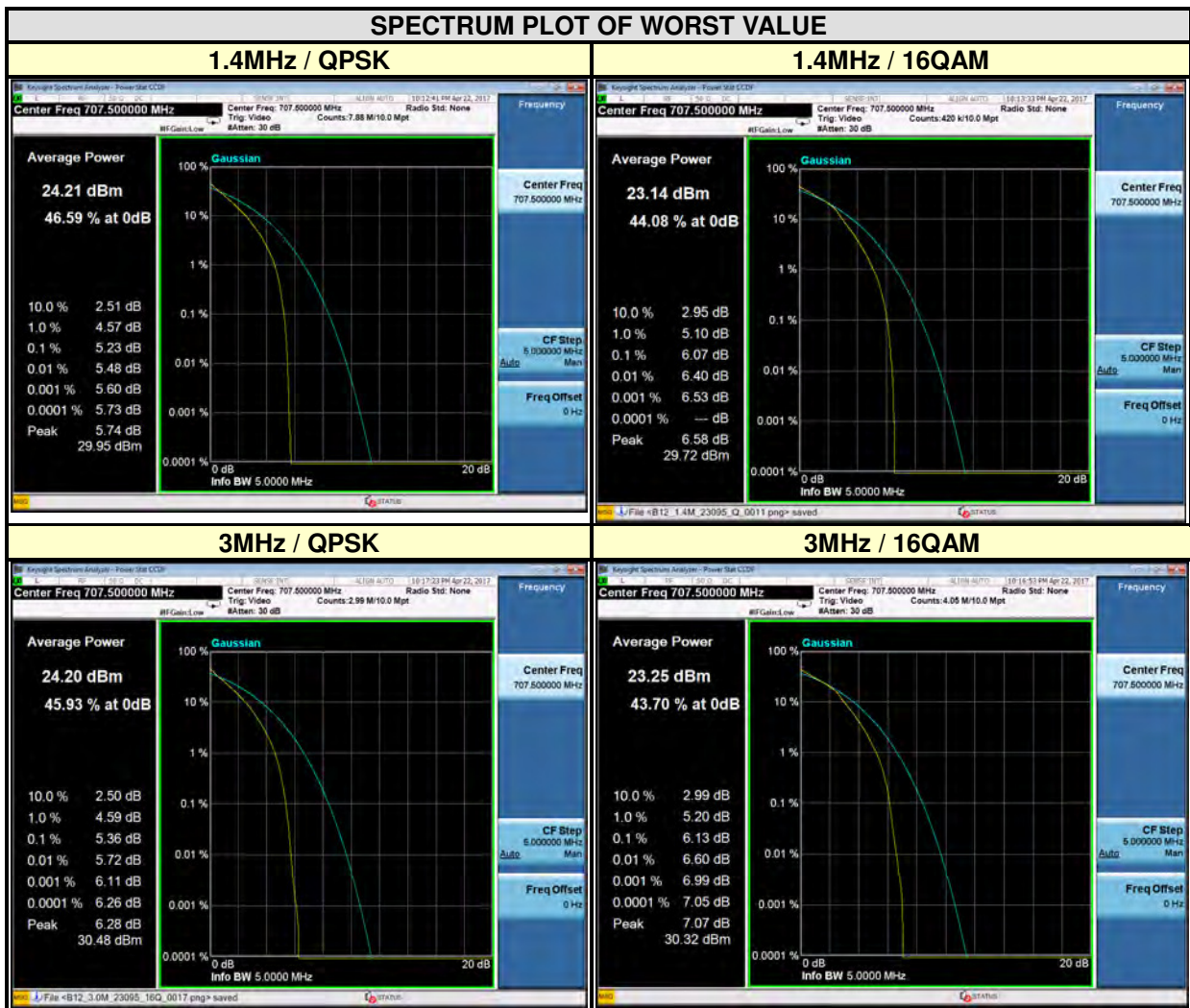



Test Report No.: RF170330W002-5

CHANNEL BANDWIDTH: 5MHz				CHANNEL BANDWIDTH: 10MHz			
CHANNEL	FREQUENCY (MHz)	PEAK TO AVERAGE RATIO (dB)		CHANNEL	FREQUENCY (MHz)	PEAK TO AVERAGE RATIO (dB)	
		QPSK	16QAM			QPSK	16QAM
23035	701.5	5.06	5.93	23060	704	5.18	5.92
23095	707.5	5.25	6.04	23095	707.5	5.33	6.07
23155	713.5	5.02	5.85	23130	711	5.18	5.98

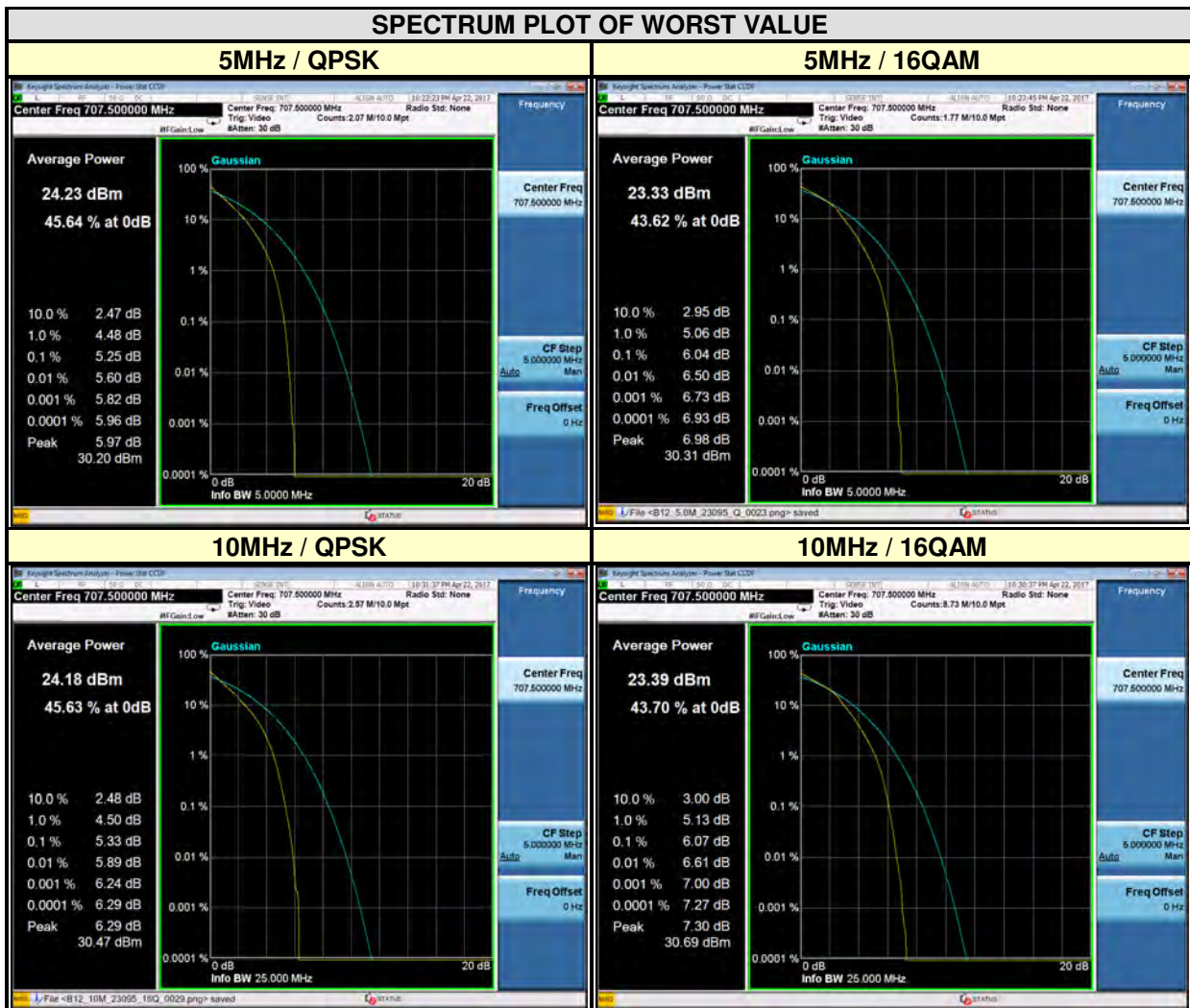

LTE BAND 13

CHANNEL BANDWIDTH: 5MHz				CHANNEL BANDWIDTH: 10MHz			
CHANNEL	FREQUENCY (MHz)	PEAK TO AVERAGE RATIO (dB)		CHANNEL	FREQUENCY (MHz)	PEAK TO AVERAGE RATIO (dB)	
		QPSK	16QAM			QPSK	16QAM
23205	779.5	4.63	5.35	-	-	-	-
23230	782	4.94	5.71	23230	782	4.81	5.58
23255	784.5	4.75	5.62	-	-	-	-

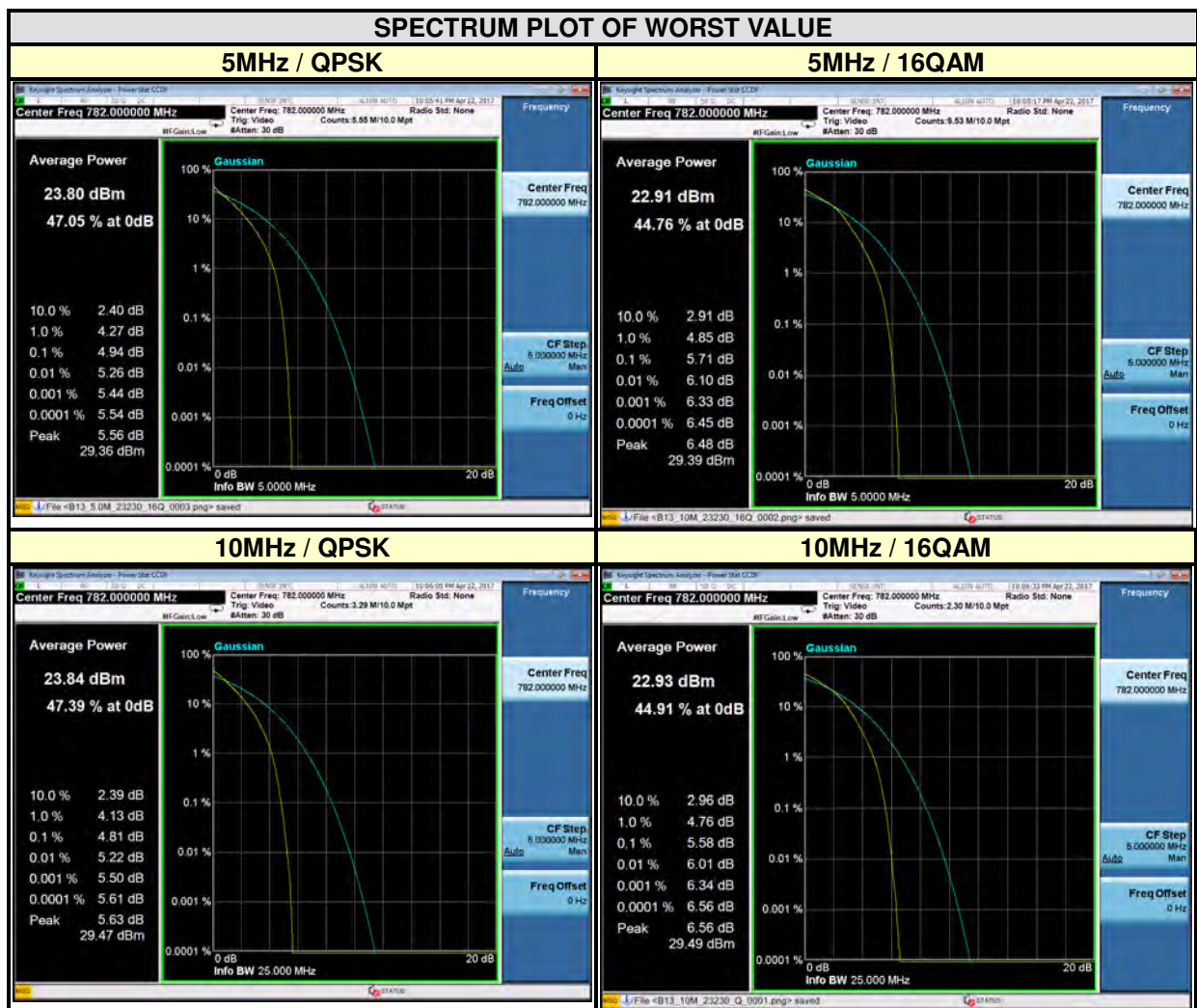

4.5 BAND EDGE MEASUREMENT

4.5.1 LIMITS OF BAND EDGE MEASUREMENT

The power of any emission outside a licensee's frequency band(s) of operation shall be attenuated below the transmitter power (P) within the licensed band(s) of operation, measured in watts, by at least $43 + 10 \log (P)$ dB. Compliance with this provision is based on the use of measurement instrumentation employing a resolution bandwidth of 100 kilohertz or greater.

However, in the 100 kilohertz bands immediately outside and adjacent to a licensee's frequency block, a resolution bandwidth of at least 30 kHz may be employed.

4.5.2 TEST SETUP

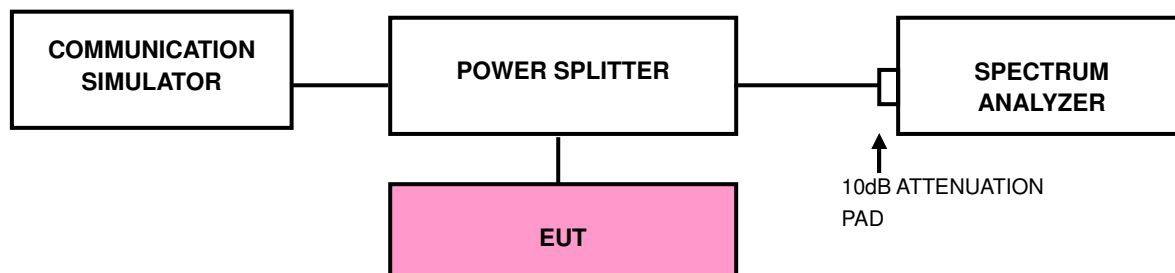



Test Report No.: RF170330W002-5

4.5.3 TEST PROCEDURES

- a. The EUT was set up for the maximum peak power with LTE link data modulation. The power was measured with R&S Spectrum Analyzer. All measurements were done at 2 channels (low and high operational frequency range.).
- b. The band edge measurement used the power splitter via EUT RF power connector between simulation base station and spectrum analyzer.
- c. The center frequency of spectrum is the band edge frequency and span is 1~5 MHz. RBW of the spectrum is 20kHz and VBW of the spectrum is 100 kHz. (LTE bandwidth 1.4MHz)
- d. The center frequency of spectrum is the band edge frequency and span is 1~5 MHz. RBW of the spectrum is 30kHz and VBW of the spectrum is 100kHz. (LTE bandwidth 3MHz)
- e. The center frequency of spectrum is the band edge frequency and span is 1~5 MHz. RBW of the spectrum is 50kHz and VBW of the spectrum is 200kHz. (LTE bandwidth 5MHz)
- f. The center frequency of spectrum is the band edge frequency and span is 1~5 MHz. RBW of the spectrum is 100kHz and VBW of the spectrum is 300kHz. (LTE bandwidth 10MHz)
- g. The center frequency of spectrum is the band edge frequency and span is 1~5 MHz. RBW of the spectrum is 200kHz and VBW of the spectrum is 1MHz. (LTE bandwidth 15MHz)
- h. The center frequency of spectrum is the band edge frequency and span is 1~5 MHz. RBW of the spectrum is 200kHz and VBW of the spectrum is 1MHz. (LTE bandwidth 20MHz)
- i. Record the max trace plot into the test report.



4.5.4 TEST RESULTS

LTE BAND 4

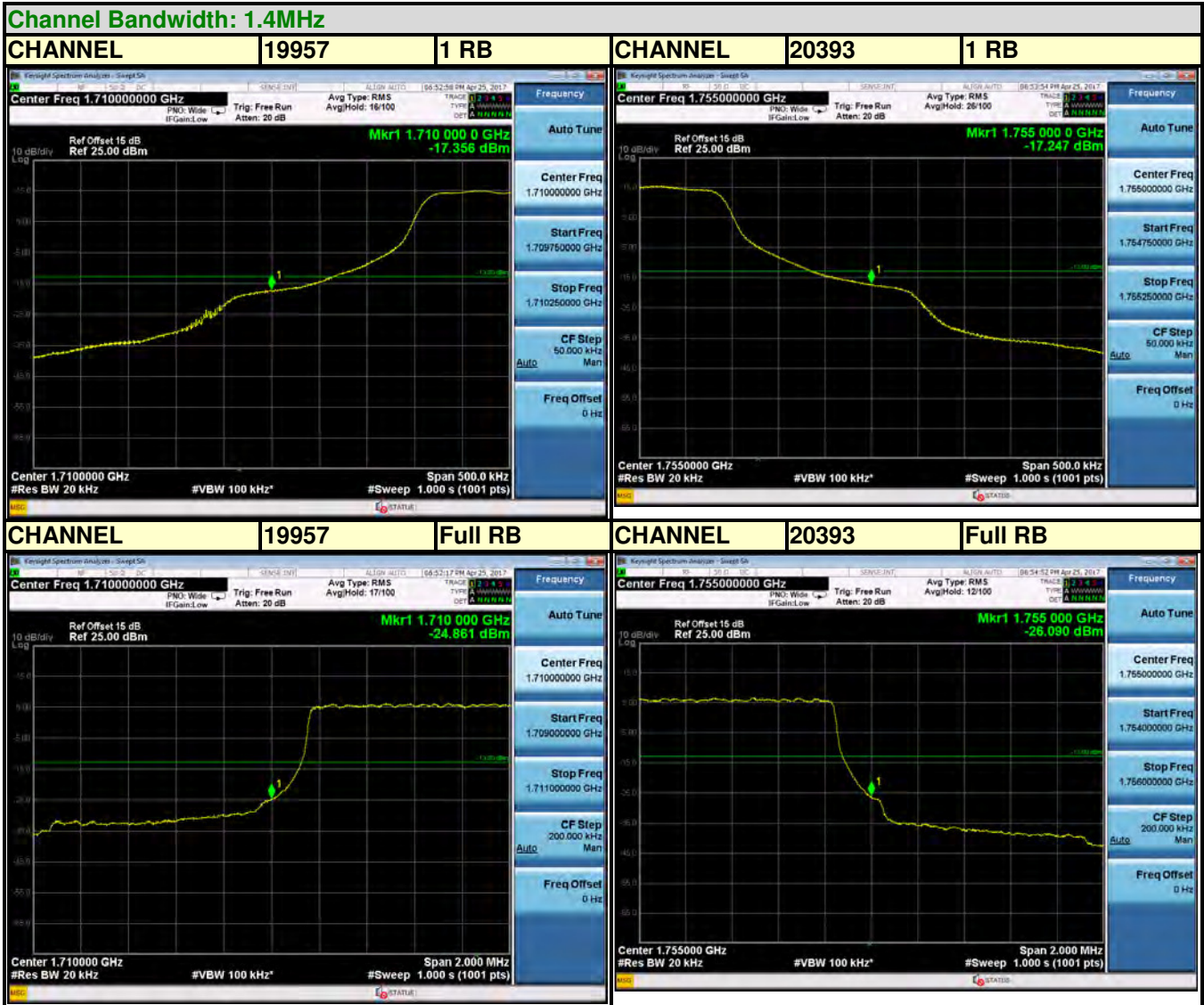



Test Report No.: RF170330W002-5

LTE BAND 4



Bureau Veritas Shenzhen Co., Ltd.
Dongguan Branch

No. 34, Chenwulu Section, Guantai Rd., Houjie Town,
Dongguan City, Guangdong 523942, China

Tel: +86 769 8593 5656
Fax: +86 769 8593 1080
Email: customerservice.dg@cn.bureauveritas.com



Test Report No.: RF170330W002-5

LTE BAND 4

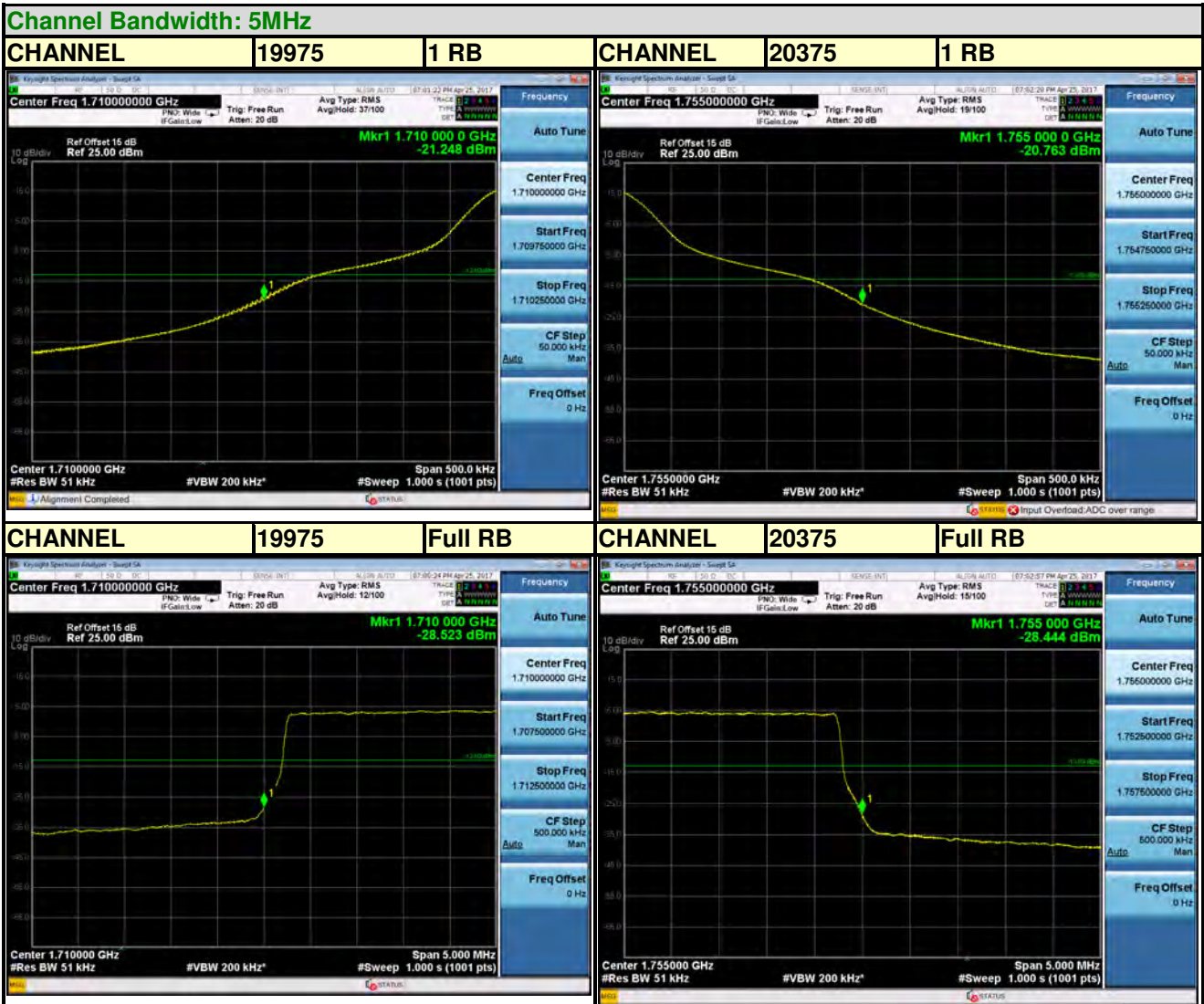

Bureau Veritas Shenzhen Co., Ltd.
Dongguan Branch

No. 34, Chenwulu Section, Guantai Rd., Houjie Town,
Dongguan City, Guangdong 523942, China

Tel: +86 769 8593 5656
Fax: +86 769 8593 1080
Email: customerservice.dg@cn.bureauveritas.com



Test Report No.: RF170330W002-5

LTE BAND 4



Bureau Veritas Shenzhen Co., Ltd.
Dongguan Branch

No. 34, Chenwulu Section, Guantai Rd., Houjie Town,
Dongguan City, Guangdong 523942, China

Tel: +86 769 8593 5656
Fax: +86 769 8593 1080
Email: customerservice.dg@cn.bureauveritas.com



Test Report No.: RF170330W002-5

LTE BAND 4



Bureau Veritas Shenzhen Co., Ltd.
Dongguan Branch

No. 34, Chenwulu Section, Guantai Rd., Houjie Town,
Dongguan City, Guangdong 523942, China

Tel: +86 769 8593 5656
Fax: +86 769 8593 1080
Email: customerservice.dg@cn.bureauveritas.com



Test Report No.: RF170330W002-5

LTE BAND 4



Bureau Veritas Shenzhen Co., Ltd.
Dongguan Branch

No. 34, Chenwulu Section, Guantai Rd., Houjie Town,
Dongguan City, Guangdong 523942, China

Tel: +86 769 8593 5656
Fax: +86 769 8593 1080
Email: customerservice.dg@cn.bureauveritas.com



LTE BAND 12





Test Report No.: RF170330W002-5

LTE BAND 12



Bureau Veritas Shenzhen Co., Ltd.
Dongguan Branch

No. 34, Chenwulu Section, Guantai Rd., Houjie Town,
Dongguan City, Guangdong 523942, China

Tel: +86 769 8593 5656
Fax: +86 769 8593 1080
Email: customerservice.dg@cn.bureauveritas.com



LTE BAND 12





LTE BAND 12





Test Report No.: RF170330W002-5

LTE BAND 13



Bureau Veritas Shenzhen Co., Ltd.
Dongguan Branch

No. 34, Chenwulu Section, Guantai Rd., Houjie Town,
Dongguan City, Guangdong 523942, China

Tel: +86 769 8593 5656
Fax: +86 769 8593 1080
Email: customerservice.dg@cn.bureauveritas.com



Test Report No.: RF170330W002-5

LTE BAND 13



Bureau Veritas Shenzhen Co., Ltd.
Dongguan Branch

No. 34, Chenwulu Section, Guantai Rd., Houjie Town,
Dongguan City, Guangdong 523942, China

Tel: +86 769 8593 5656
Fax: +86 769 8593 1080
Email: customerservice.dg@cn.bureauveritas.com

4.6 CONDUCTED SPURIOUS EMISSIONS

4.6.1 LIMITS OF CONDUCTED SPURIOUS EMISSIONS MEASUREMENT

The power of any emission outside a licensee's frequency block shall be attenuated below the transmitter power (P) by at least $43 + 10 \log_{10}(P)$ dB. The limit of emission equal to -13dBm

4.6.2 TEST PROCEDURE

- a. The EUT makes a phone call to the communication simulator. All measurements were done at middle operational frequency range.
- b. Measuring frequency range is from 30 MHz to 17.55GHz for LTE Band 4 and 30 MHz to 8GHz for LTE Band 12 & LTE Band 13. 10dB attenuation pad is connected with spectrum. RBW=1MHz and VBW=3MHz are used for conducted emission measurement.

4.6.3 TEST SETUP

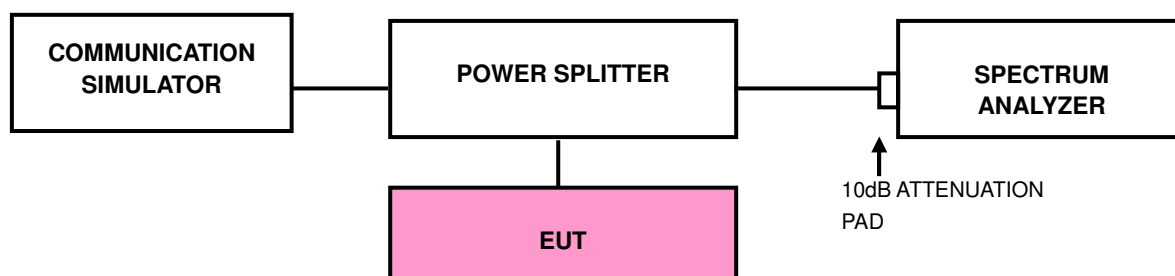



4.6.4 TEST RESULTS

LTE BAND 4

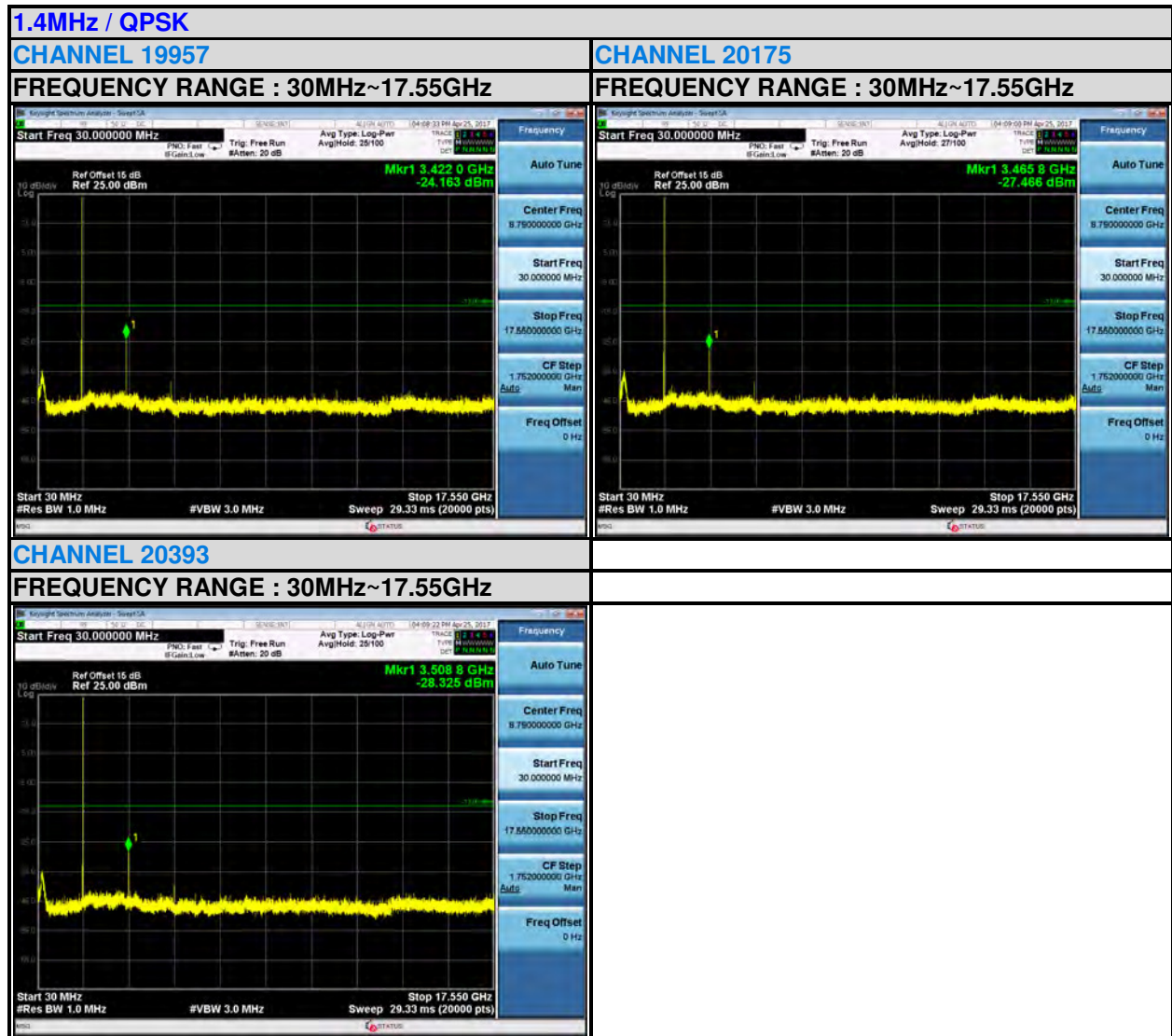



Test Report No.: RF170330W002-5

3MHz / QPSK

CHANNEL 19965

FREQUENCY RANGE : 30MHz~17.55GHz

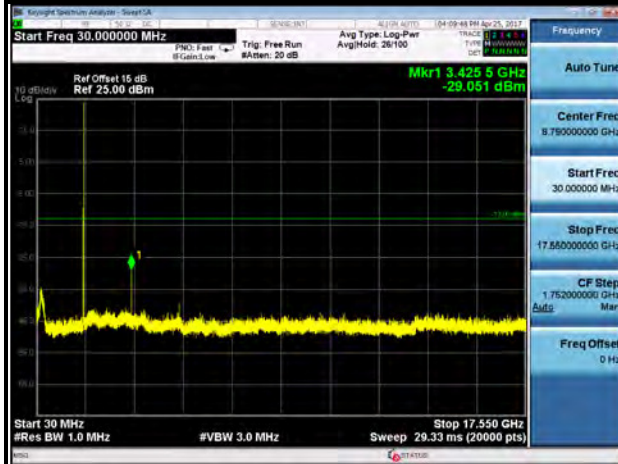

CHANNEL 20175

FREQUENCY RANGE : 30MHz~17.55GHz

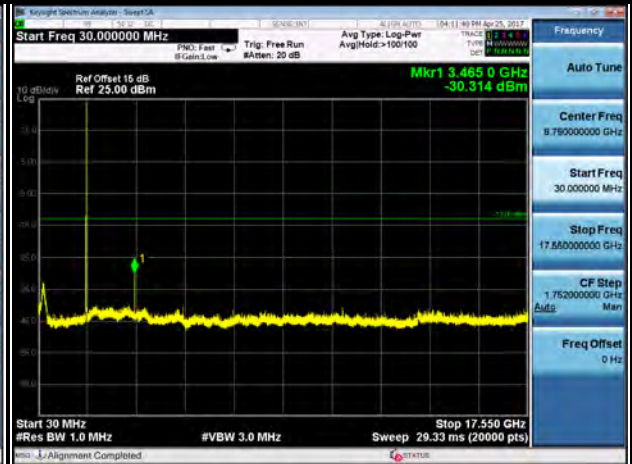

CHANNEL 20385

FREQUENCY RANGE : 30MHz~17.55GHz

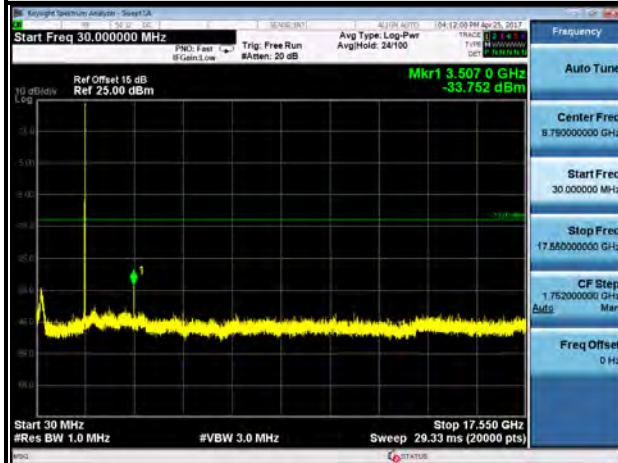



Test Report No.: RF170330W002-5

5MHz / QPSK

CHANNEL 19975

FREQUENCY RANGE : 30MHz~17.55GHz

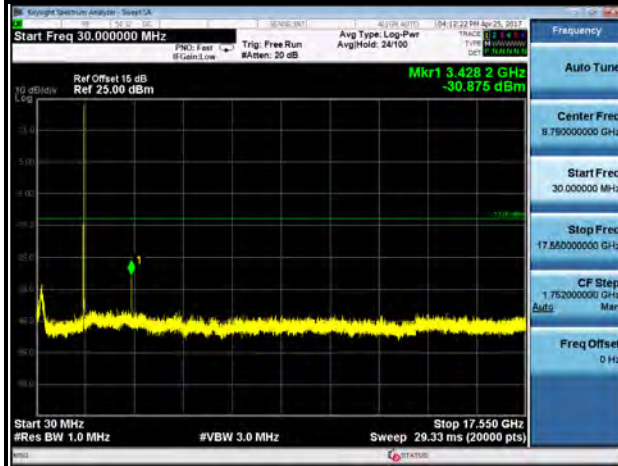

CHANNEL 20175

FREQUENCY RANGE : 30MHz~17.55GHz

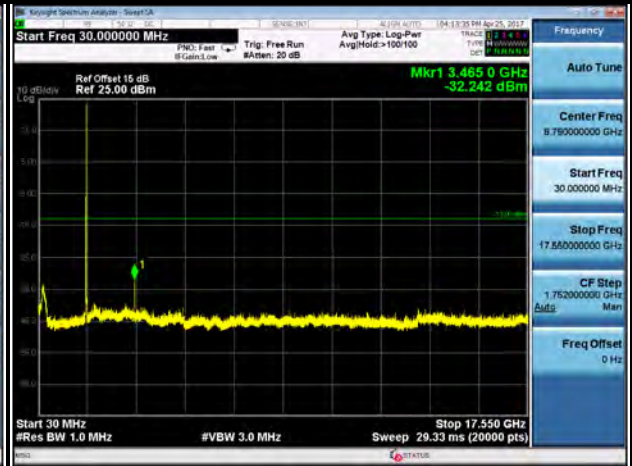

CHANNEL 20375

FREQUENCY RANGE : 30MHz~17.55GHz

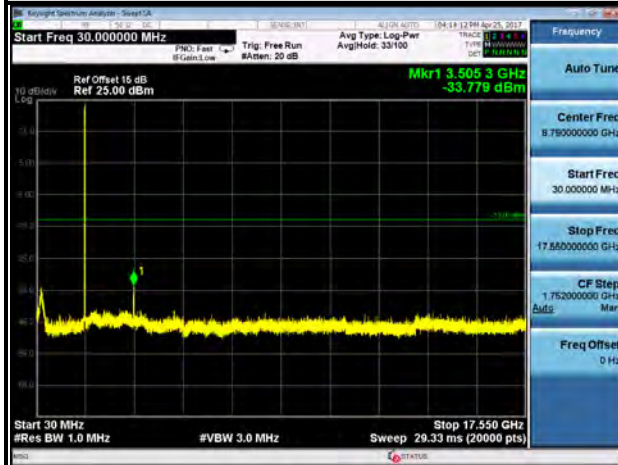



Test Report No.: RF170330W002-5

10MHz / QPSK

CHANNEL 20000

FREQUENCY RANGE : 30MHz~17.55GHz

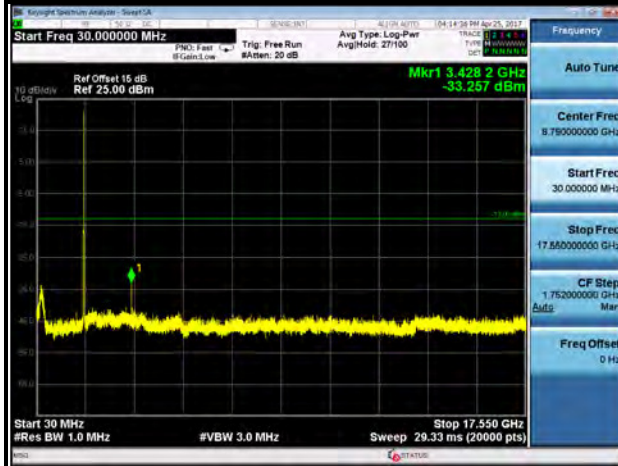

CHANNEL 20175

FREQUENCY RANGE : 30MHz~17.55GHz

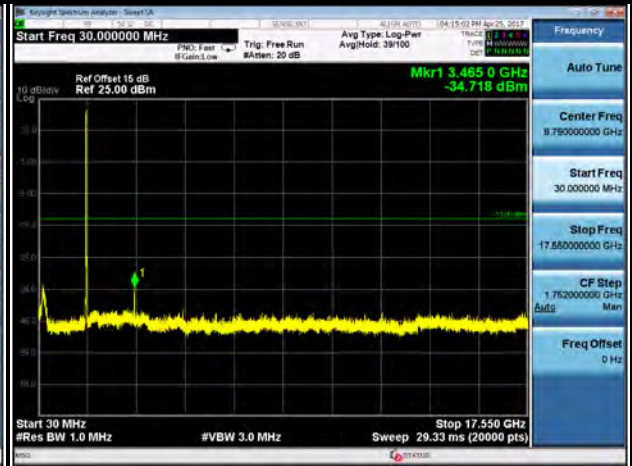

CHANNEL 20350

FREQUENCY RANGE : 30MHz~17.55GHz

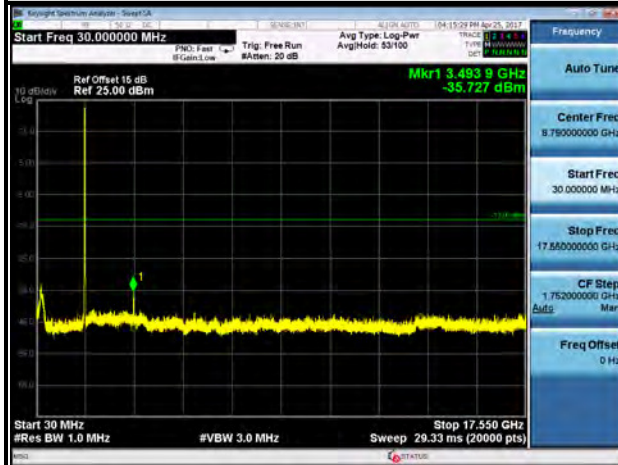



Test Report No.: RF170330W002-5

15MHz / QPSK

CHANNEL 20025

FREQUENCY RANGE : 30MHz~17.55GHz

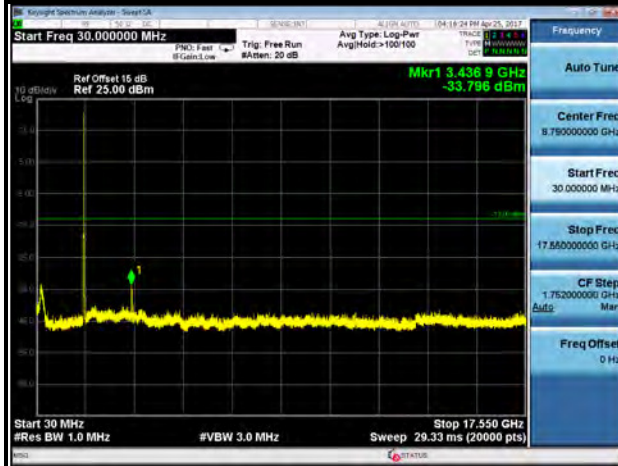

CHANNEL 20175

FREQUENCY RANGE : 30MHz~17.55GHz

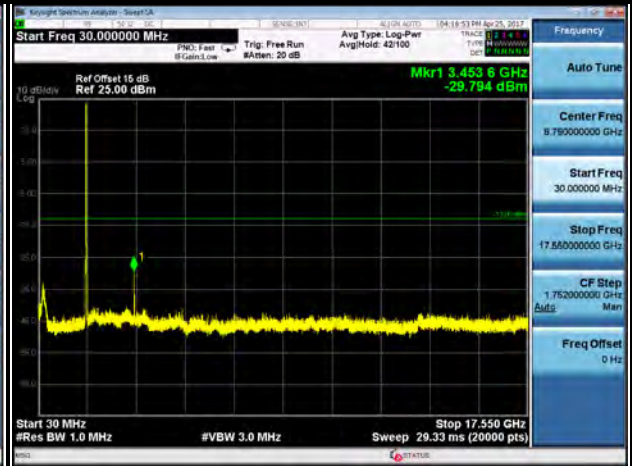

CHANNEL 20325

FREQUENCY RANGE : 30MHz~17.55GHz

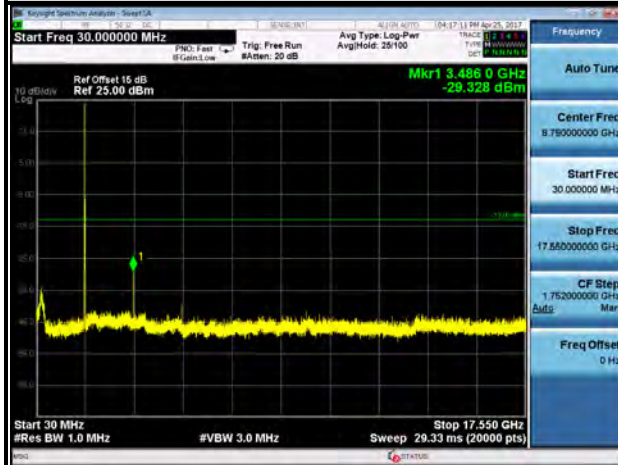



Test Report No.: RF170330W002-5

20MHz / QPSK

CHANNEL 20050

FREQUENCY RANGE : 30MHz~17.55GHz

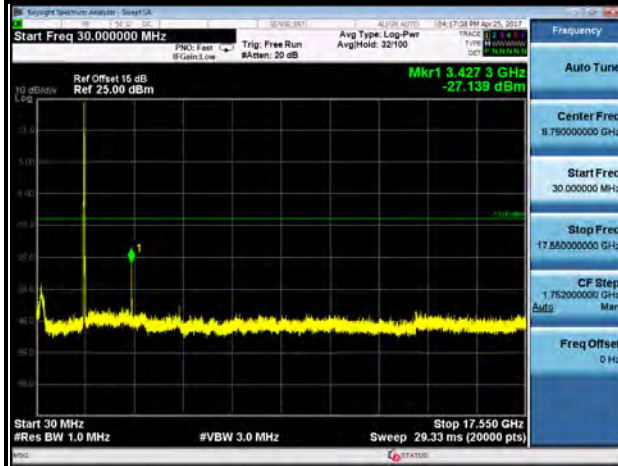

CHANNEL 20175

FREQUENCY RANGE : 30MHz~17.55GHz

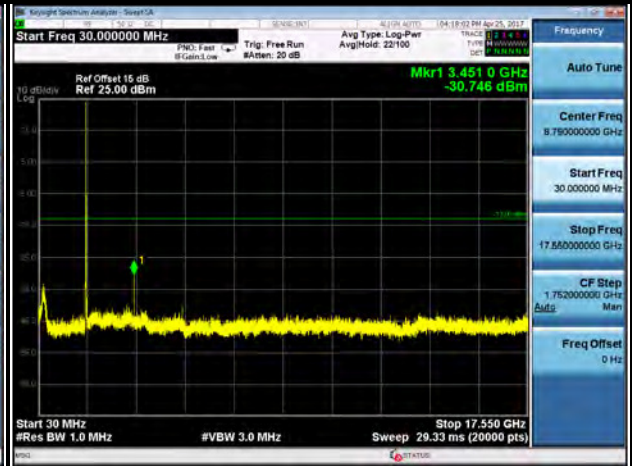

CHANNEL 20300

FREQUENCY RANGE : 30MHz~17.55GHz

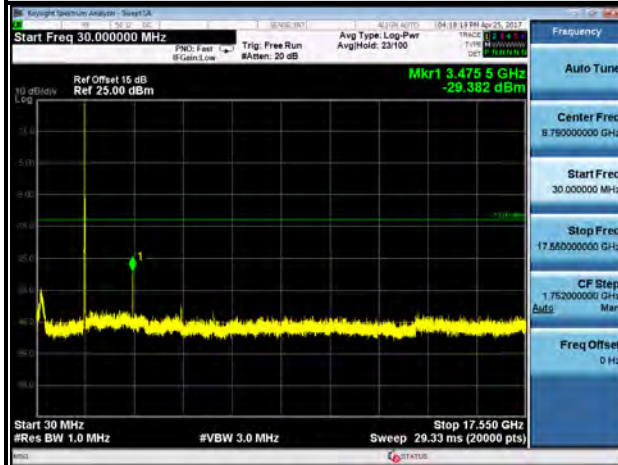



LTE BAND 12

1.4MHz / QPSK

CHANNEL 23017

FREQUENCY RANGE : 30MHz~8GHz

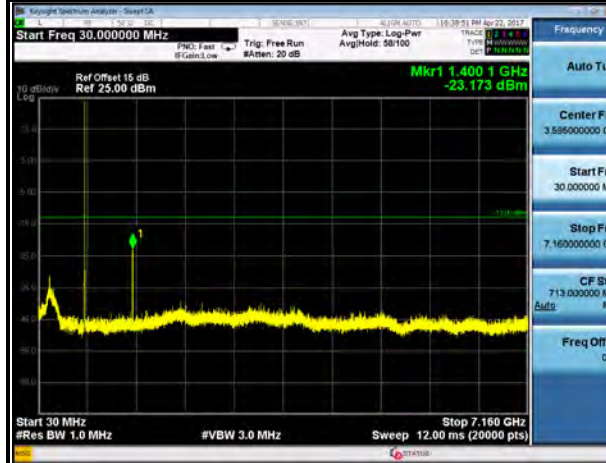

CHANNEL 23095

FREQUENCY RANGE : 30MHz~8GHz

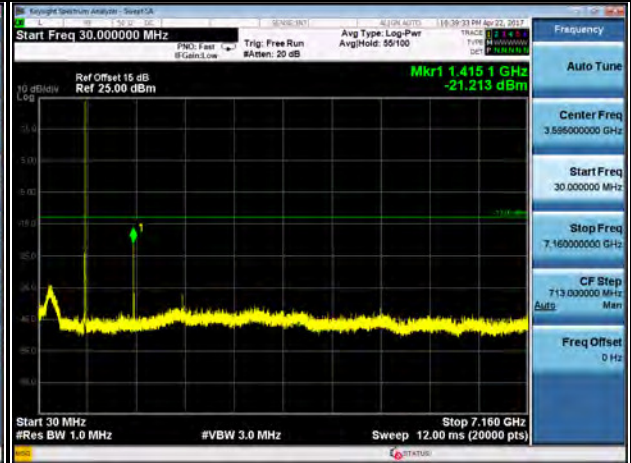

CHANNEL 23173

FREQUENCY RANGE : 30MHz~8GHz

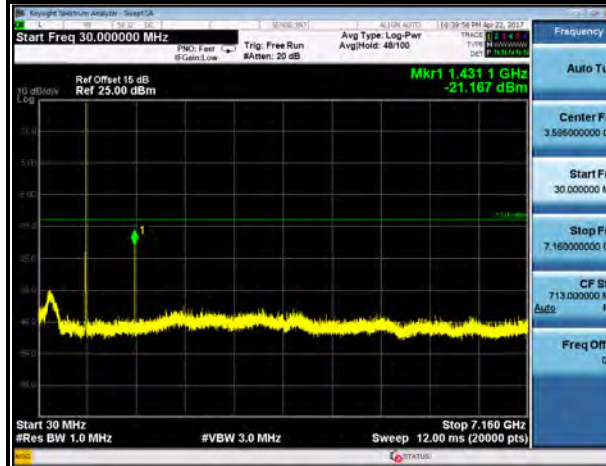



Test Report No.: RF170330W002-5

3MHz / QPSK

CHANNEL 23025

FREQUENCY RANGE : 30MHz~8GHz

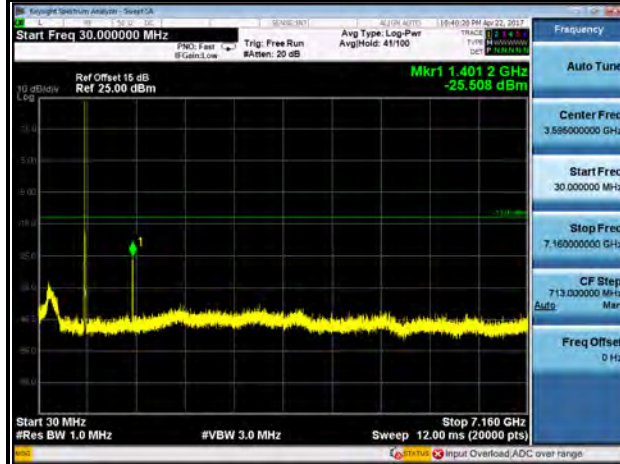

CHANNEL 23095

FREQUENCY RANGE : 30MHz~8GHz

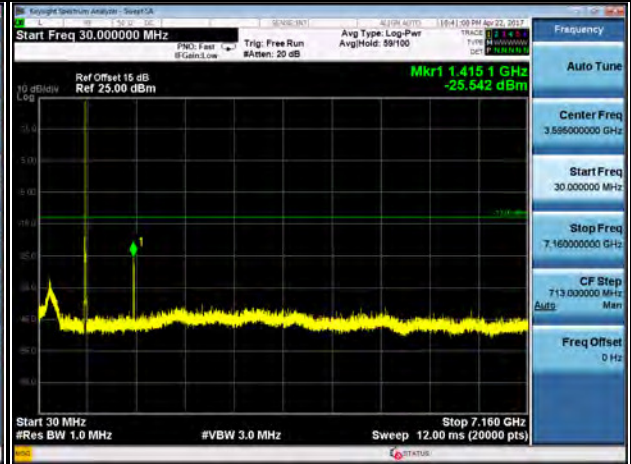

CHANNEL 23165

FREQUENCY RANGE : 30MHz~8GHz

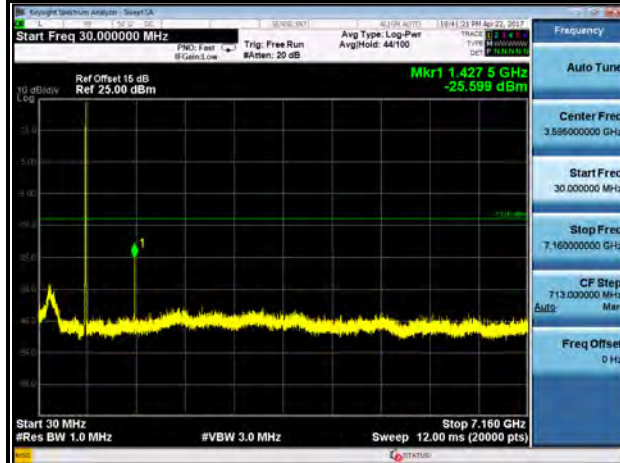



Test Report No.: RF170330W002-5

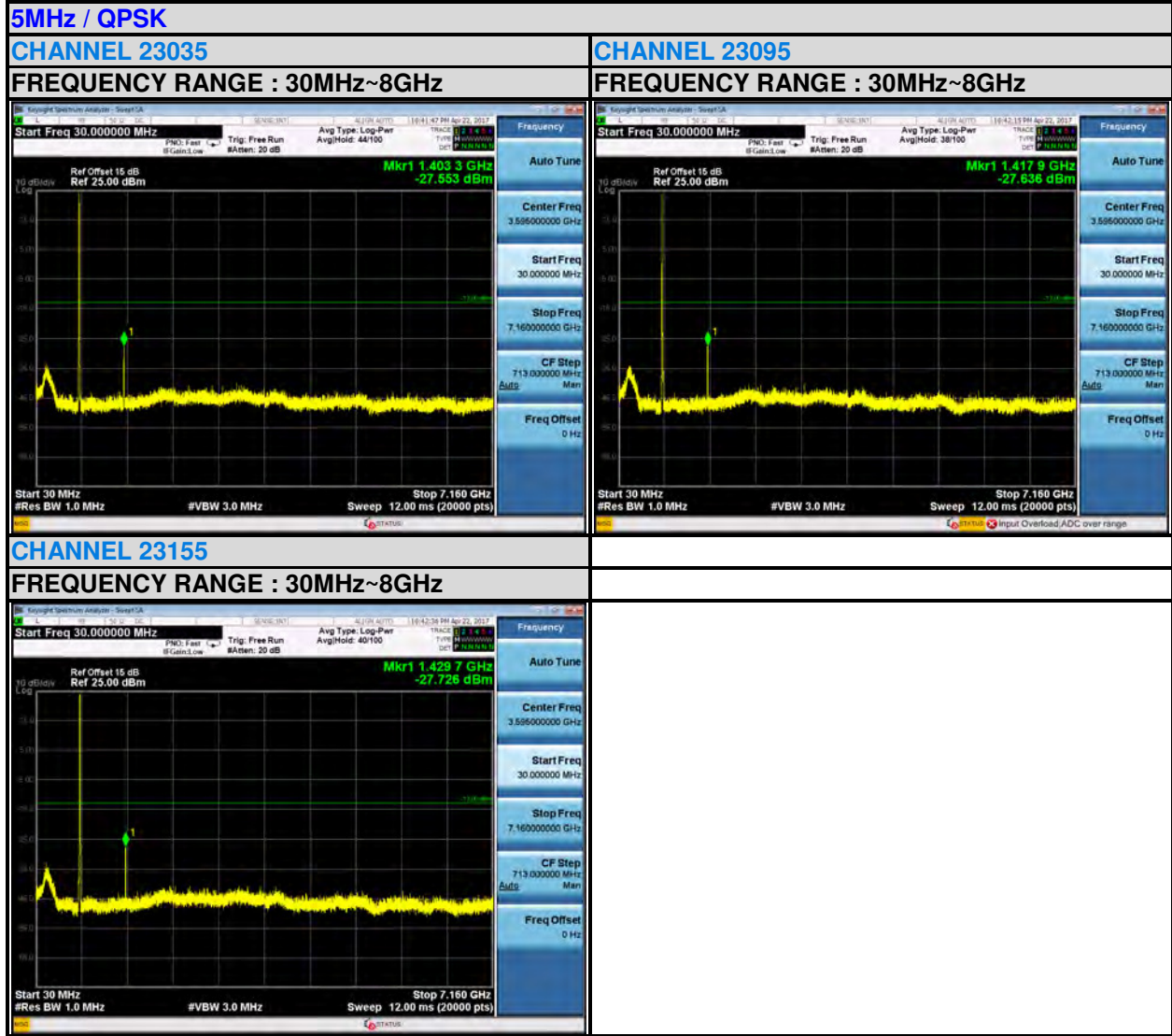

Bureau Veritas Shenzhen Co., Ltd.
Dongguan Branch

No. 34, Chenwulu Section, Guantai Rd., Houjie Town,
Dongguan City, Guangdong 523942, China

Tel: +86 769 8593 5656
Fax: +86 769 8593 1080
Email: customerservice.dg@cn.bureauveritas.com



Test Report No.: RF170330W002-5

10MHz / QPSK

CHANNEL 23060

FREQUENCY RANGE : 30MHz~8GHz

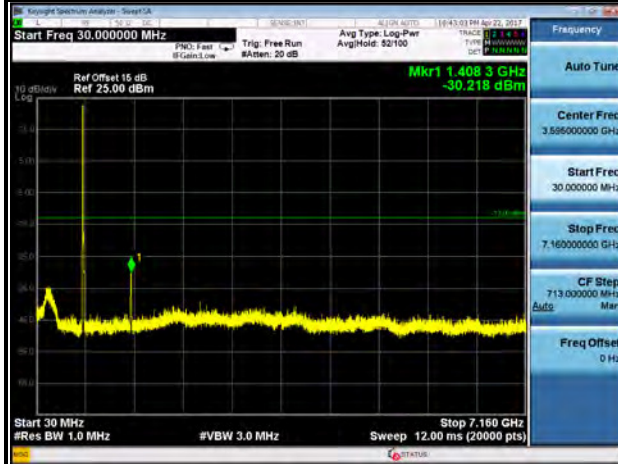

CHANNEL 23095

FREQUENCY RANGE : 30MHz~8GHz

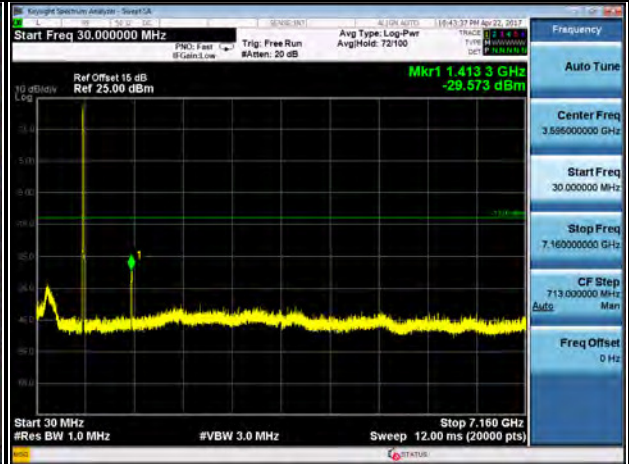

CHANNEL 23130

FREQUENCY RANGE : 30MHz~8GHz

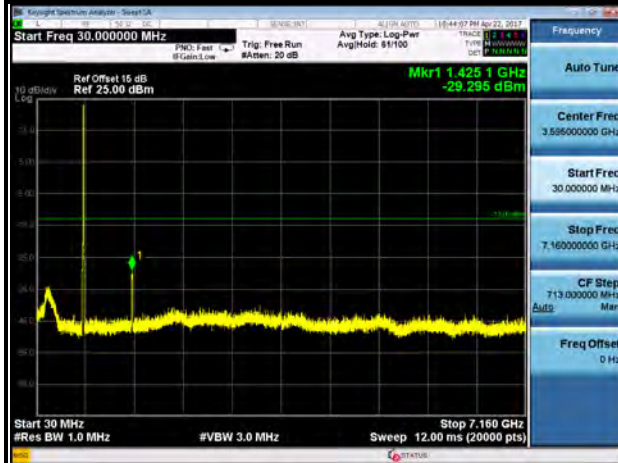



LTE Band 13

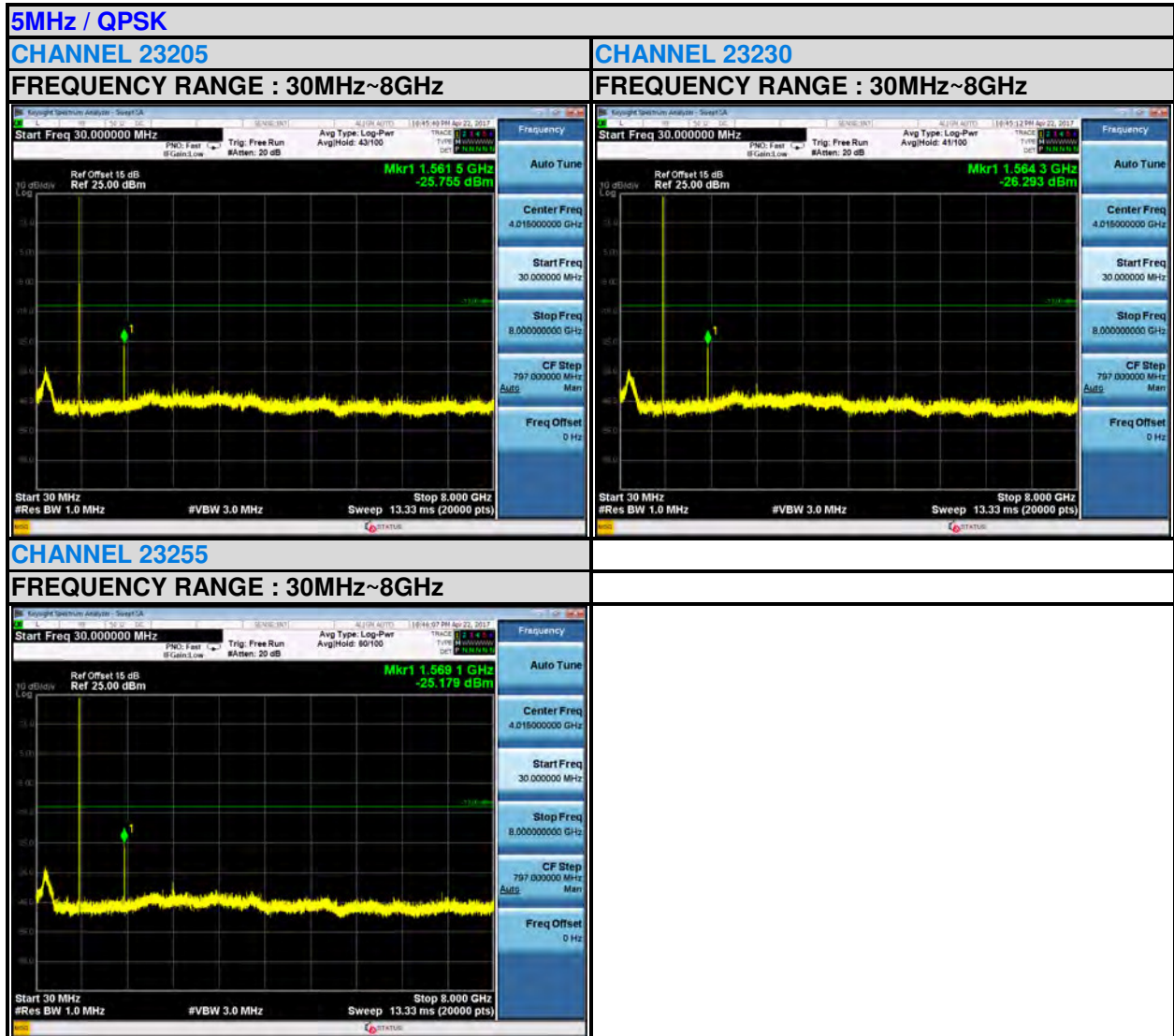



Test Report No.: RF170330W002-5

10MHz / QPSK

CHANNEL 23230

FREQUENCY RANGE : 30MHz~8GHz

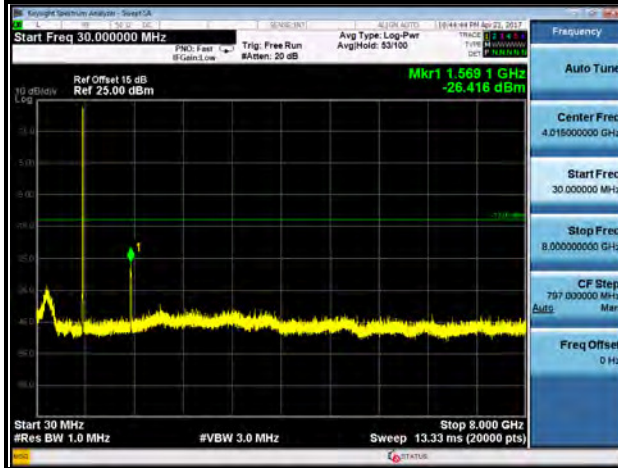

Bureau Veritas Shenzhen Co., Ltd.
Dongguan Branch

No. 34, Chenwulu Section, Guantai Rd., Houjie Town,
Dongguan City, Guangdong 523942, China

Tel: +86 769 8593 5656
Fax: +86 769 8593 1080
Email: customerservice.dg@cn.bureauveritas.com



4.7 RADIATED EMISSION MEASUREMENT

4.7.1 LIMITS OF RADIATED EMISSION MEASUREMENT

The power of any emission outside a licensee's frequency block shall be attenuated below the transmitter power (P) by at least $43 + 10 \log_{10}(P)$ dB. The limit of emission equal to -13dBm

4.7.2 TEST PROCEDURES

- a. Substitution method is used for E.I.R.P measurement. In the semi-anechoic chamber, EUT placed on the 0.8m height of Turn Table, rotated the table around 360 degrees to search the maximum radiation power and receiver antenna shall be rotated vertical and horizontal polarization and moved height from 1m to 4m to find the maximum polar radiated power. The "Read Value" is the spectrum reading the maximum power value.
- b. The substitution horn antenna is substituted for EUT at the same position and signals generator export the CW signal to the substitution antenna via a TX cable. Rotated the Turn Table and moved receiving antenna to find the maximum radiation power. Adjust output power level of S.G to get a Value of spectrum reading equal to "Read Value" of step a. Record the power level of S.G
- c. $\text{EIRP} = \text{Output power level of S.G} - \text{TX cable loss} + \text{Antenna gain of substitution horn.}$
- d. E.R.P power can be calculated form E.I.R.P power by subtracting the gain of dipole, $\text{E.R.P power} = \text{E.I.P.R power} - 2.15\text{dBi.}$

NOTE: The resolution bandwidth of spectrum analyzer is 1 MHz and the video bandwidth is 3 MHz.

4.7.3 DEVIATION FROM TEST STANDARD

No deviation

4.7.4 TEST SETUP

<Below 30MHz>

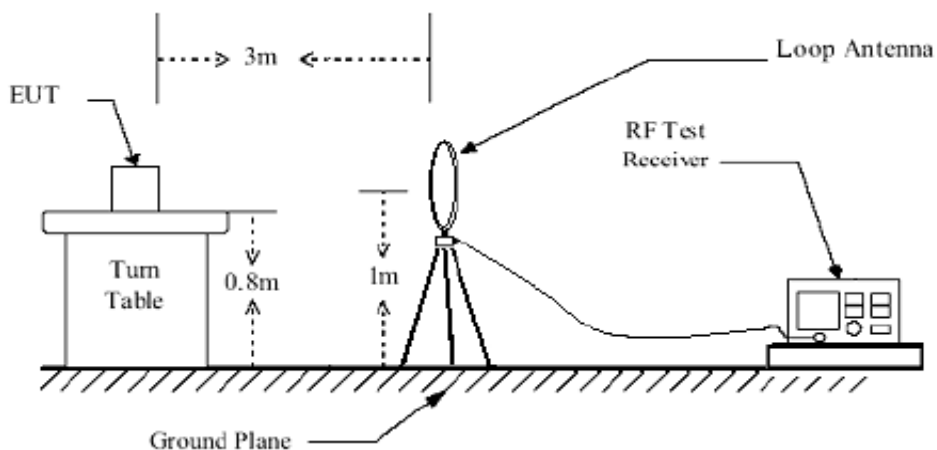

<Above 30MHz>

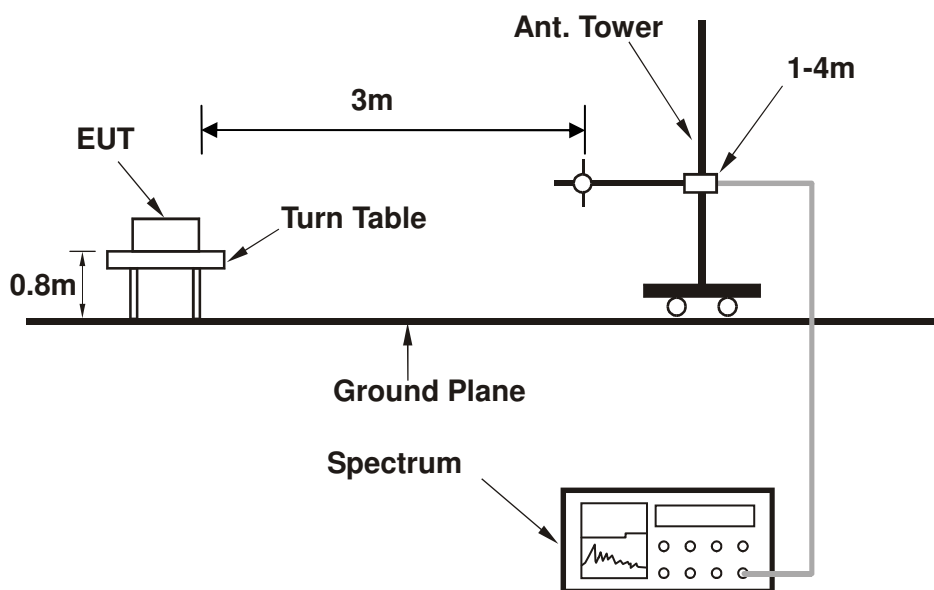

For the actual test configuration, please refer to the attached file (Test Setup Photo).



4.7.5 TEST RESULTS

BELOW 1GHz WORST-CASE DATA

9 KHz – 30 KHz data: the amplitude of spurious emissions attenuated more than 20 dB below the permissible value is not required in the report.

30 MHz – 1GHz data:

LTE Band 13:

MODE	TX channel 23230	FREQUENCY RANGE	Below 1000MHz
ENVIRONMENTAL CONDITIONS	26deg. C, 56%RH	INPUT POWER	DC 5.2V from adapter
TESTED BY	Tony Zou		
ANTENNA POLARITY & TEST DISTANCE: HORIZONTAL AT 3 M			

	Freq	Level	Read Level	Limit Line	Over Limit	Factor	Remark	Pol/Phase
	MHz	dBm/m	dBm	dBm/m	dB	dB/m		
1 PP	31.940	-29.07	-45.74	-13.00	-16.07	16.67	Peak	Horizontal
2	43.580	-35.74	-44.68	-13.00	-22.74	8.94	Peak	Horizontal
3	53.280	-48.36	-48.10	-13.00	-35.36	-0.26	Peak	Horizontal
4	81.410	-64.48	-56.64	-13.00	-51.48	-7.84	Peak	Horizontal
5	132.820	-60.98	-43.86	-13.00	-47.98	-17.12	Peak	Horizontal
6	167.740	-67.15	-48.95	-13.00	-54.15	-18.20	Peak	Horizontal

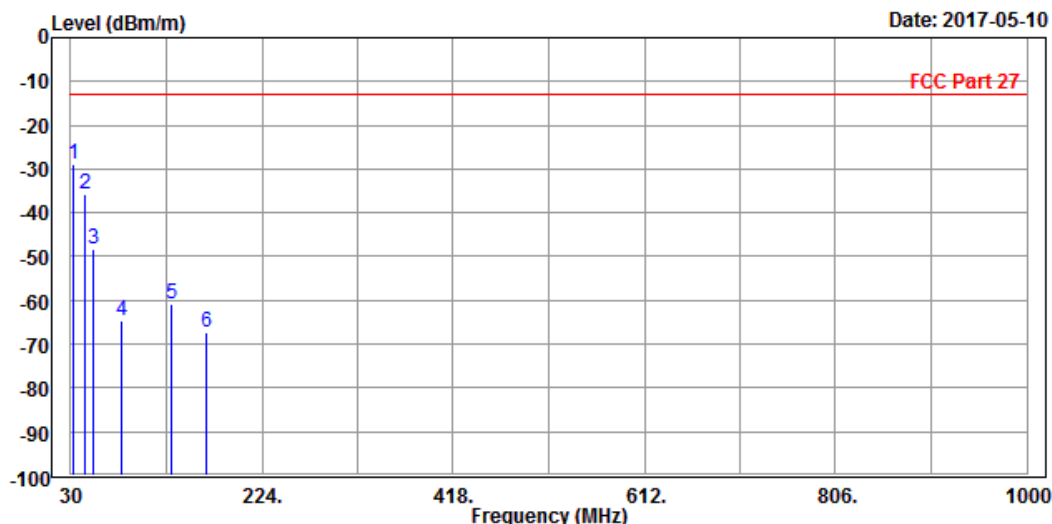



Test Report No.: RF170330W002-5

MODE	TX channel 23230	FREQUENCY RANGE	Below 1000MHz
ENVIRONMENTAL CONDITIONS	26deg. C, 56%RH	INPUT POWER	DC 5.2V from adapter
TESTED BY	Tony Zou		
ANTENNA POLARITY & TEST DISTANCE: VERTICAL AT 3 M			

	Freq	Level	Read Level	Limit Line	Over Limit	Factor	Remark	Pol/Phase
	MHz	dBm/m	dBm	dBm/m	dB	dB/m		
1	PP	42.610	-34.05	-31.78	-13.00	-21.05	-2.27 Peak	Vertical
2		79.470	-55.22	-44.69	-13.00	-42.22	-10.53 Peak	Vertical
3		133.790	-56.87	-43.91	-13.00	-43.87	-12.96 Peak	Vertical
4		183.260	-66.27	-53.51	-13.00	-53.27	-12.76 Peak	Vertical
5		244.370	-69.83	-58.41	-13.00	-56.83	-11.42 Peak	Vertical
6		315.180	-73.59	-62.35	-13.00	-60.59	-11.24 Peak	Vertical

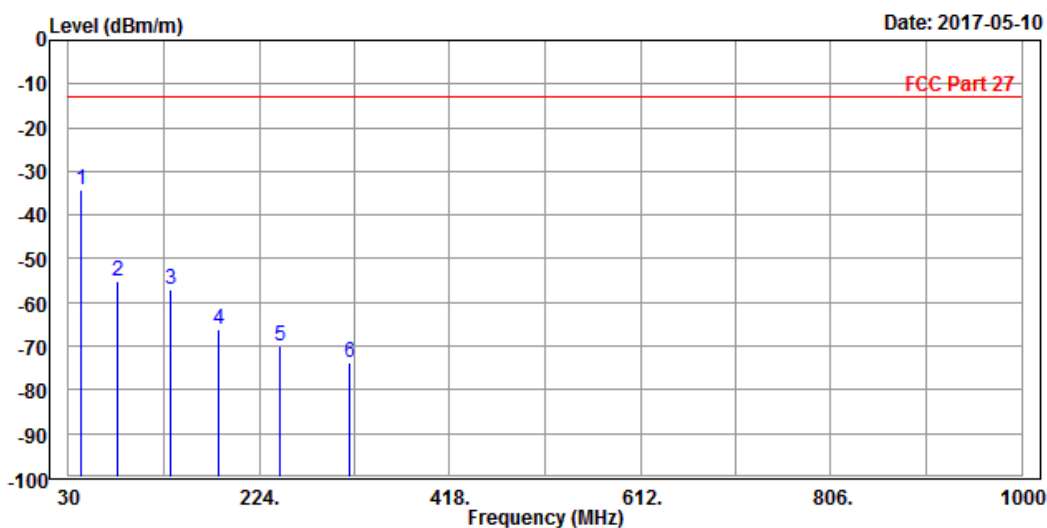



Test Report No.: RF170330W002-5

ABOVE 1GHz

Note: For higher frequency, the emission is too low to be detected.

LTE BAND 4

CHANNEL BANDWIDTH: 1.4MHz / QPSK

MODE	TX channel 20175	FREQUENCY RANGE	Above 1000MHz
ENVIRONMENTAL CONDITIONS	26deg. C, 56%RH	INPUT POWER	DC 5.2V from adapter
TESTED BY	Tony Zou		
ANTENNA POLARITY & TEST DISTANCE: HORIZONTAL AT 3 M			

	Freq	Level	Read Level	Limit Line	Over Limit	Factor	Remark	Pol/Phase
	MHz	dBm/m	dBm	dBm/m	dB	dB/m		
1	3444.000	-53.93	-55.88	-13.00	-40.93	1.95	Peak	Horizontal
2 PP	5186.000	-45.39	-53.98	-13.00	-32.39	8.59	Peak	Horizontal

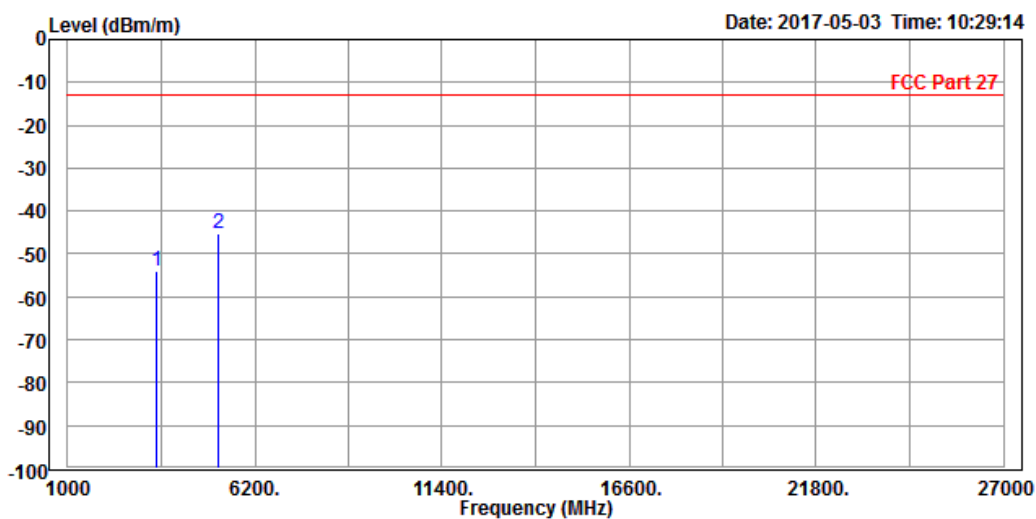



Test Report No.: RF170330W002-5

MODE	TX channel 20175	FREQUENCY RANGE	Above 1000MHz
ENVIRONMENTAL CONDITIONS	26deg. C, 56%RH	INPUT POWER	DC 5.2V from adapter
TESTED BY	Tony Zou		
ANTENNA POLARITY & TEST DISTANCE: VERTICAL AT 3 M			

	Freq	Level	Read Level	Limit Line	Over Limit	Factor	Remark	Pol/Phase
	MHz	dBm/m	dBm	dBm/m	dB	dB/m		
1	3444.000	-52.81	-55.31	-13.00	-39.81	2.50	Peak	Vertical
2 PP	5186.000	-46.95	-54.93	-13.00	-33.95	7.98	Peak	Vertical

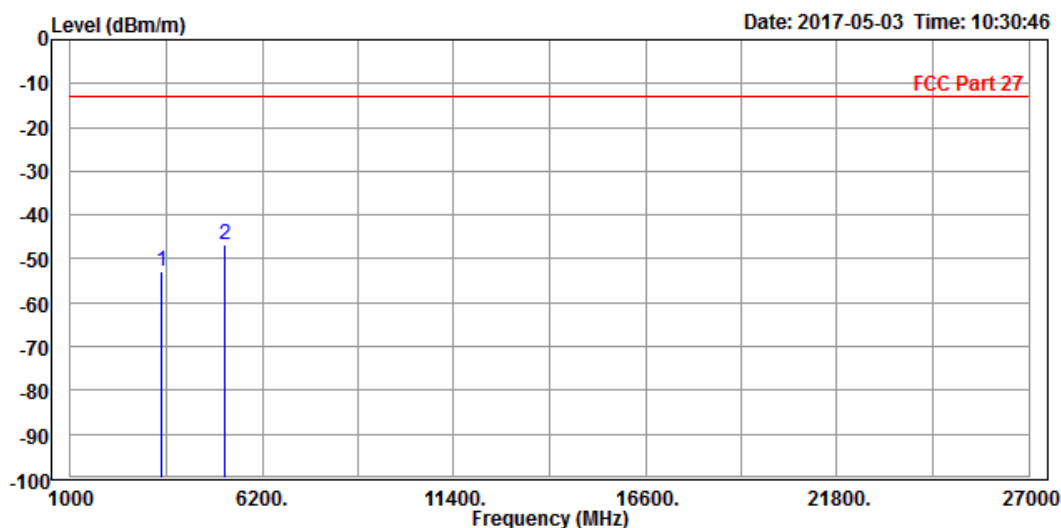



Test Report No.: RF170330W002-5

CHANNEL BANDWIDTH: 3MHz / QPSK

MODE	TX channel 20175	FREQUENCY RANGE	Above 1000MHz
ENVIRONMENTAL CONDITIONS	26deg. C, 56%RH	INPUT POWER	DC 5.2V from adapter
TESTED BY	Tony Zou		
ANTENNA POLARITY & TEST DISTANCE: HORIZONTAL AT 3 M			

	Freq	Level	Read Level	Limit Line	Over Limit	Factor	Remark	Pol/Phase
	MHz	dBm/m	dBm	dBm/m	dB	dB/m		
1	3444.000	-53.68	-55.63	-13.00	-40.68	1.95	Peak	Horizontal
2 PP	5186.000	-46.70	-55.29	-13.00	-33.70	8.59	Peak	Horizontal

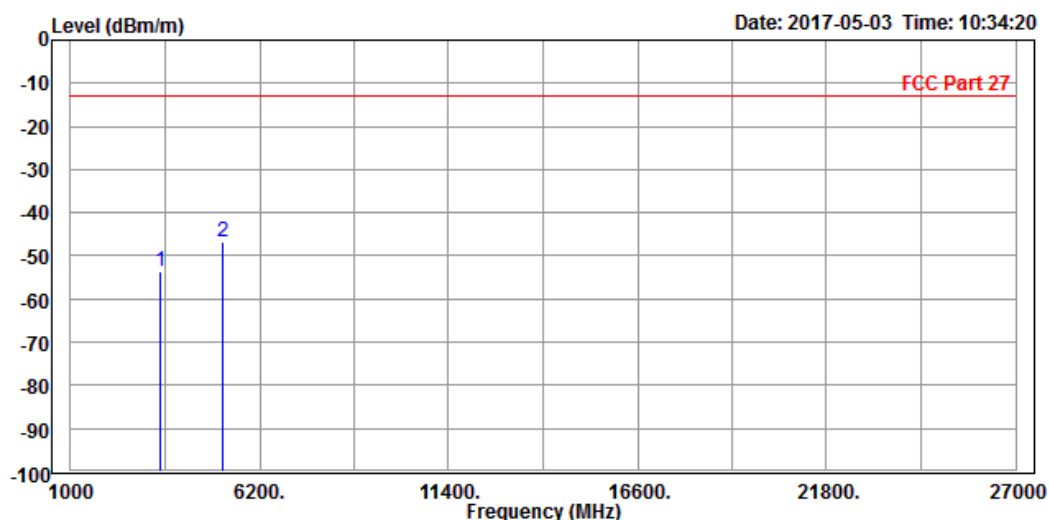



Test Report No.: RF170330W002-5

MODE	TX channel 20175	FREQUENCY RANGE	Above 1000MHz
ENVIRONMENTAL CONDITIONS	26deg. C, 56%RH	INPUT POWER	DC 5.2V from adapter
TESTED BY	Tony Zou		
ANTENNA POLARITY & TEST DISTANCE: VERTICAL AT 3 M			

	Freq	Level	Read Level	Limit Line	Over Limit	Factor	Remark	Pol/Phase
	MHz	dBm/m	dBm	dBm/m	dB	dB/m		
1	3444.000	-52.21	-54.71	-13.00	-39.21	2.50	Peak	Vertical
2 PP	5186.000	-47.66	-55.64	-13.00	-34.66	7.98	Peak	Vertical

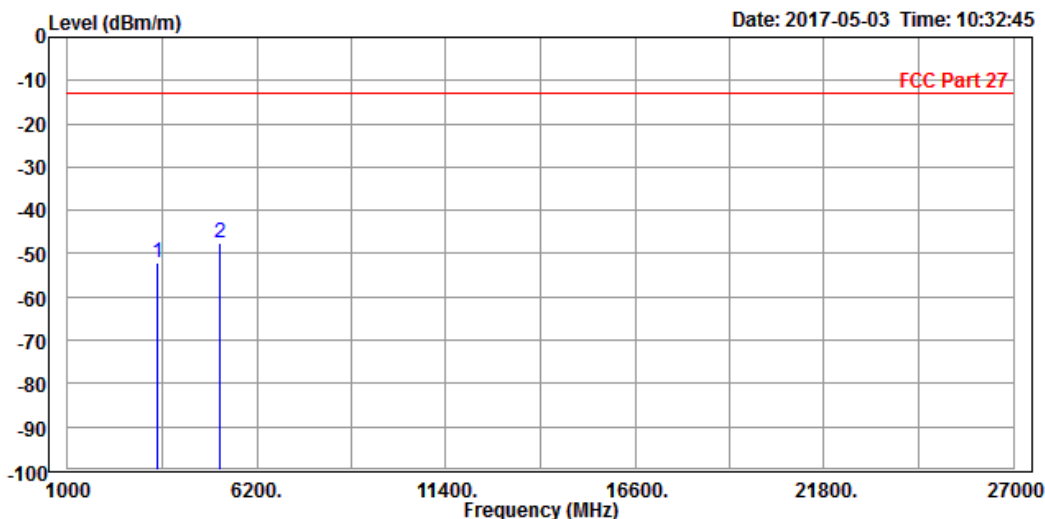



Test Report No.: RF170330W002-5

CHANNEL BANDWIDTH: 5MHz / QPSK

MODE	TX channel 20175	FREQUENCY RANGE	Above 1000MHz
ENVIRONMENTAL CONDITIONS	26deg. C, 56%RH	INPUT POWER	DC 5.2V from adapter
TESTED BY	Tony Zou		
ANTENNA POLARITY & TEST DISTANCE: HORIZONTAL AT 3 M			

	Freq	Level	Read Level	Limit Line	Over Limit	Factor	Remark	Pol/Phase
	MHz	dBm/m	dBm	dBm/m	dB	dB/m		
1	3444.000	-53.47	-55.42	-13.00	-40.47	1.95	Peak	Horizontal
2 PP	5186.000	-45.99	-54.58	-13.00	-32.99	8.59	Peak	Horizontal

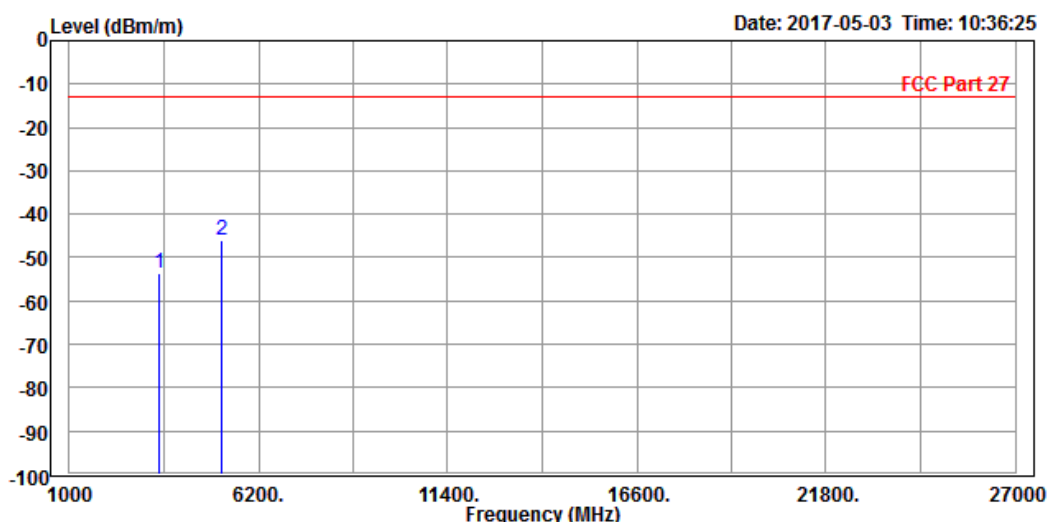



Test Report No.: RF170330W002-5

MODE	TX channel 20175	FREQUENCY RANGE	Above 1000MHz
ENVIRONMENTAL CONDITIONS	26deg. C, 56%RH	INPUT POWER	DC 5.2V from adapter
TESTED BY	Tony Zou		
ANTENNA POLARITY & TEST DISTANCE: VERTICAL AT 3 M			

	Freq	Level	Read Level	Limit Line	Over Limit	Factor	Remark	Pol/Phase
	MHz	dBm/m	dBm	dBm/m	dB	dB/m		
1	3444.000	-51.93	-54.43	-13.00	-38.93	2.50	Peak	Vertical
2 PP	5186.000	-46.54	-54.52	-13.00	-33.54	7.98	Peak	Vertical

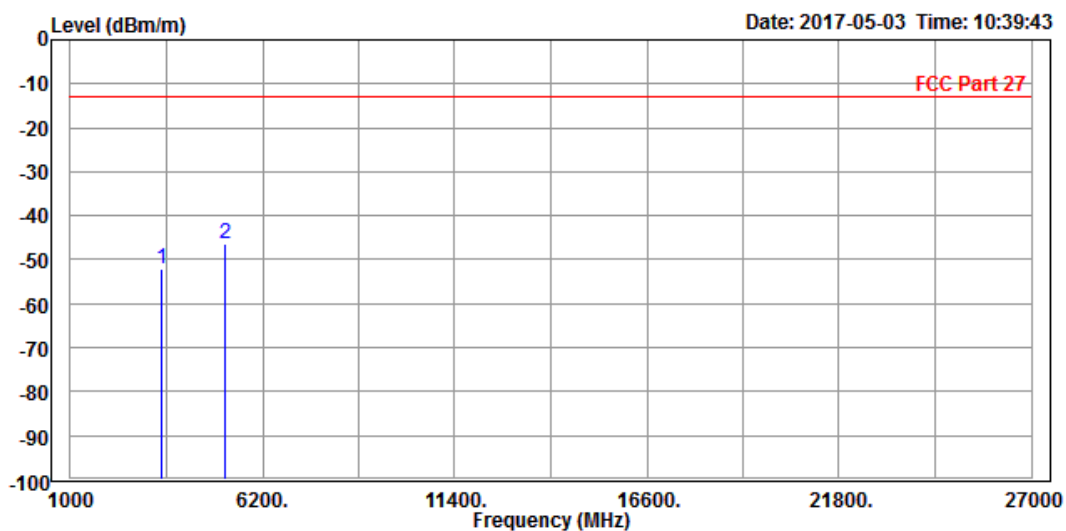



Test Report No.: RF170330W002-5

CHANNEL BANDWIDTH: 10MHz / QPSK

CH 20000

MODE	TX channel 20000	FREQUENCY RANGE	Above 1000MHz
ENVIRONMENTAL CONDITIONS	23deg. C, 66%RH	INPUT POWER	DC 5.2V from adapter
TESTED BY	Tony Zou		
ANTENNA POLARITY & TEST DISTANCE: HORIZONTAL AT 3 M			

	Freq	Level	Read Level	Limit Line	Over Limit	Factor	Remark	Pol/Phase
	MHz	dBm/m	dBm	dBm/m	dB	dB/m		
1	3418.000	-53.65	-55.50	-13.00	-40.65	1.85	Peak	Horizontal
2 PP	5130.000	-47.32	-55.85	-13.00	-34.32	8.53	Peak	Horizontal

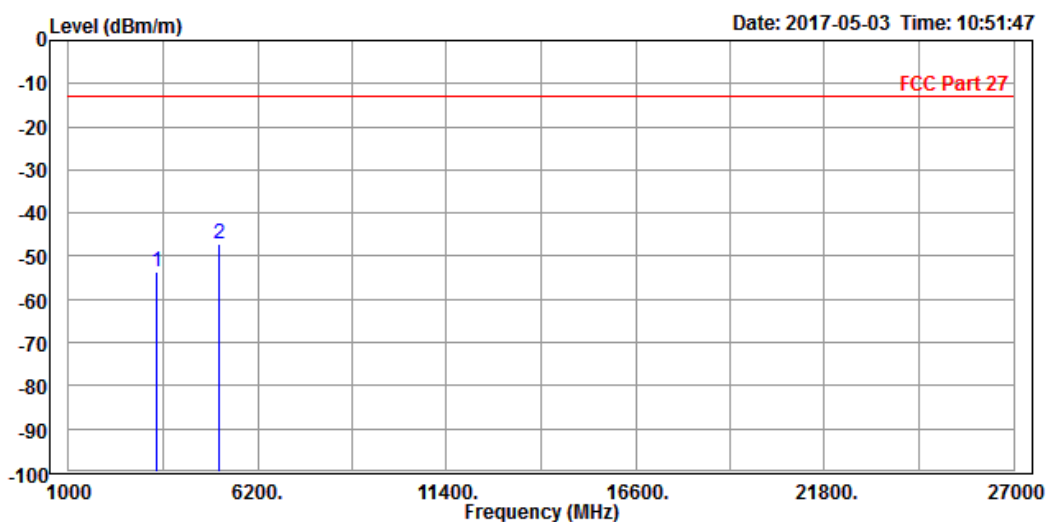



Test Report No.: RF170330W002-5

MODE	TX channel 20000	FREQUENCY RANGE	Above 1000MHz
ENVIRONMENTAL CONDITIONS	23deg. C, 66%RH	INPUT POWER	DC 5.2V from adapter
TESTED BY	Tony Zou		
ANTENNA POLARITY & TEST DISTANCE: VERTICAL AT 3 M			

	Freq	Level	Read Level	Limit Line	Over Limit	Factor	Remark	Pol/Phase
	MHz	dBm/m	dBm	dBm/m	dB	dB/m		
1	3418.000	-53.32	-55.79	-13.00	-40.32	2.47	Peak	Vertical
2	PP 5130.000	-47.84	-55.83	-13.00	-34.84	7.99	Peak	Vertical

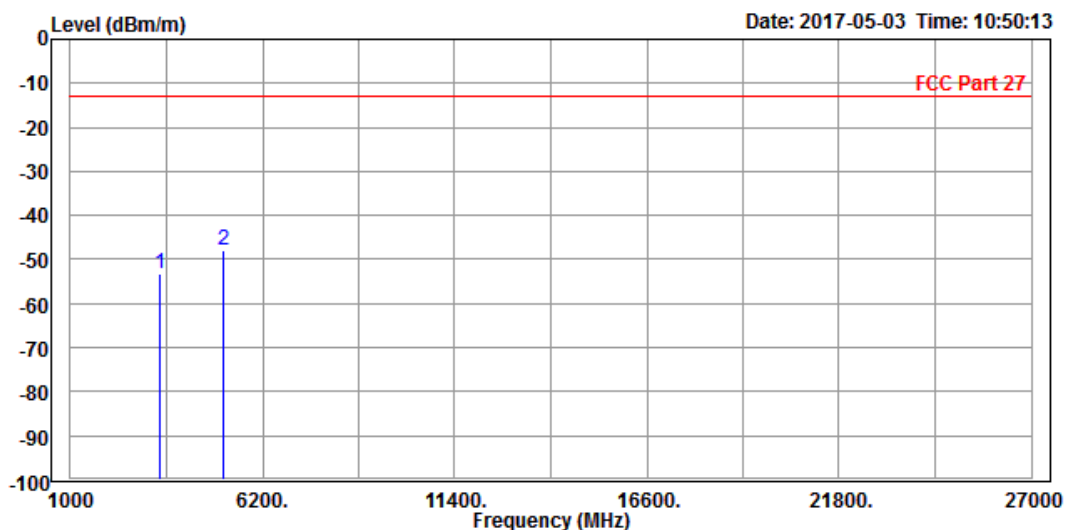



Test Report No.: RF170330W002-5

CH 20175

MODE	TX channel 20175	FREQUENCY RANGE	Above 1000MHz
ENVIRONMENTAL CONDITIONS	23deg. C, 66%RH	INPUT POWER	DC 5.2V from adapter
TESTED BY	Tony Zou		
ANTENNA POLARITY & TEST DISTANCE: HORIZONTAL AT 3 M			

	Freq	Level	Read Level	Limit Line	Over Limit	Factor	Remark	Pol/Phase
	MHz	dBm/m	dBm	dBm/m	dB	dB/m		
1	3444.000	-53.14	-55.09	-13.00	-40.14	1.95	Peak	Horizontal
2 PP	5186.000	-46.23	-54.82	-13.00	-33.23	8.59	Peak	Horizontal

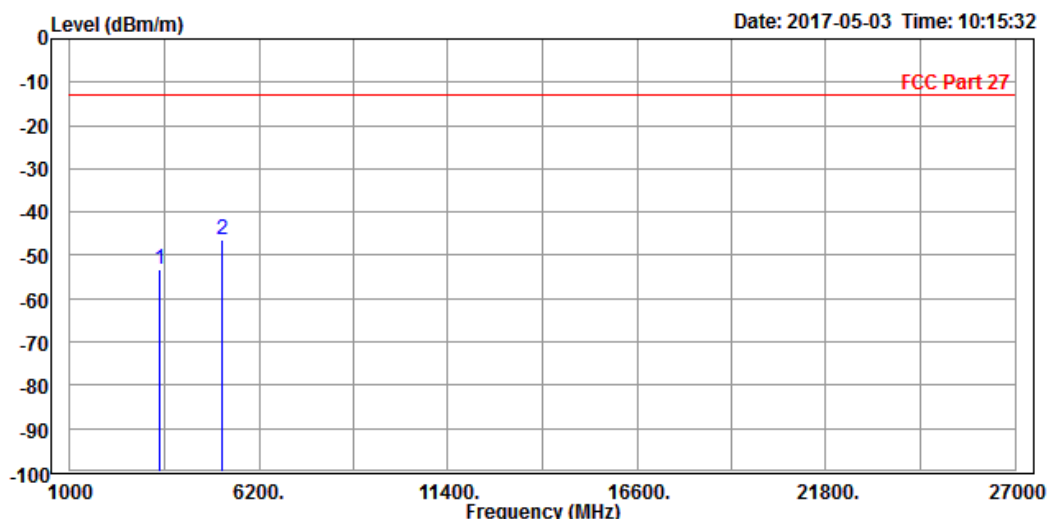



Test Report No.: RF170330W002-5

MODE	TX channel 20175	FREQUENCY RANGE	Above 1000MHz
ENVIRONMENTAL CONDITIONS	23deg. C, 66%RH	INPUT POWER	DC 5.2V from adapter
TESTED BY	Tony Zou		
ANTENNA POLARITY & TEST DISTANCE: VERTICAL AT 3 M			

	Freq	Level	Read Level	Limit Line	Over Limit	Factor	Remark	Pol/Phase
	MHz	dBm/m	dBm	dBm/m	dB	dB/m		
1	3444.000	-52.47	-54.97	-13.00	-39.47	2.50	Peak	Vertical
2 PP	5186.000	-46.24	-54.22	-13.00	-33.24	7.98	Peak	Vertical

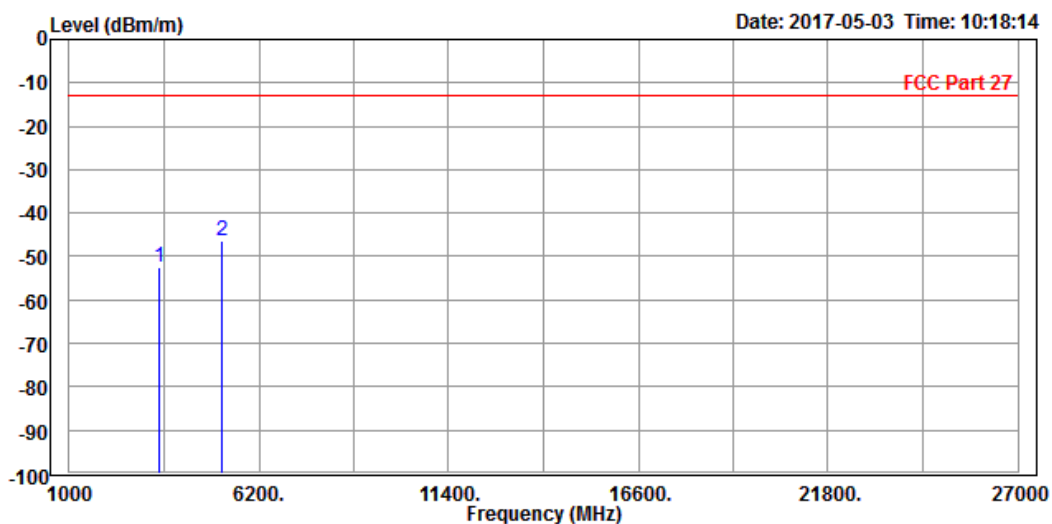



Test Report No.: RF170330W002-5

CH 20350

MODE	TX channel 20350	FREQUENCY RANGE	Above 1000MHz
ENVIRONMENTAL CONDITIONS	23deg. C, 66%RH	INPUT POWER	DC 5.2V from adapter
TESTED BY	Tony Zou		
ANTENNA POLARITY & TEST DISTANCE: HORIZONTAL AT 3 M			

	Freq	Level	Read Level	Limit Line	Over Limit	Factor	Remark	Pol/Phase
	MHz	dBm/m	dBm	dBm/m	dB	dB/m		
1	3496.000	-53.19	-55.34	-13.00	-40.19	2.15	Peak	Horizontal
2	PP 5250.000	-45.90	-54.57	-13.00	-32.90	8.67	Peak	Horizontal

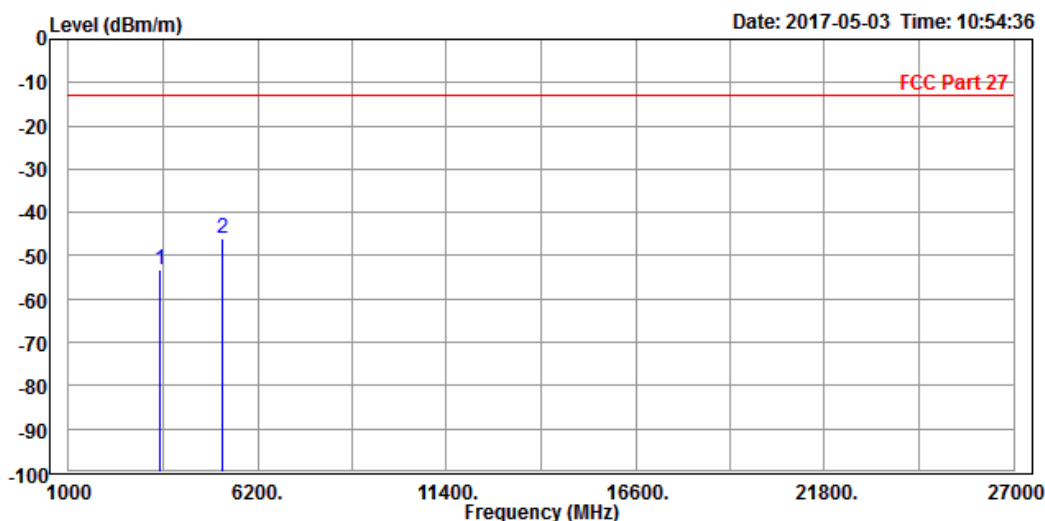



Test Report No.: RF170330W002-5

MODE	TX channel 20350	FREQUENCY RANGE	Above 1000MHz
ENVIRONMENTAL CONDITIONS	23deg. C, 66%RH	INPUT POWER	DC 5.2V from adapter
TESTED BY	Tony Zou		
ANTENNA POLARITY & TEST DISTANCE: VERTICAL AT 3 M			

	Freq	Level	Read Level	Limit Line	Over Limit	Factor	Remark	Pol/Phase
	MHz	dBm/m	dBm	dBm/m	dB	dB/m		
1	3496.000	-52.47	-55.03	-13.00	-39.47	2.56	Peak	Vertical
2 PP	5250.000	-46.14	-54.12	-13.00	-33.14	7.98	Peak	Vertical

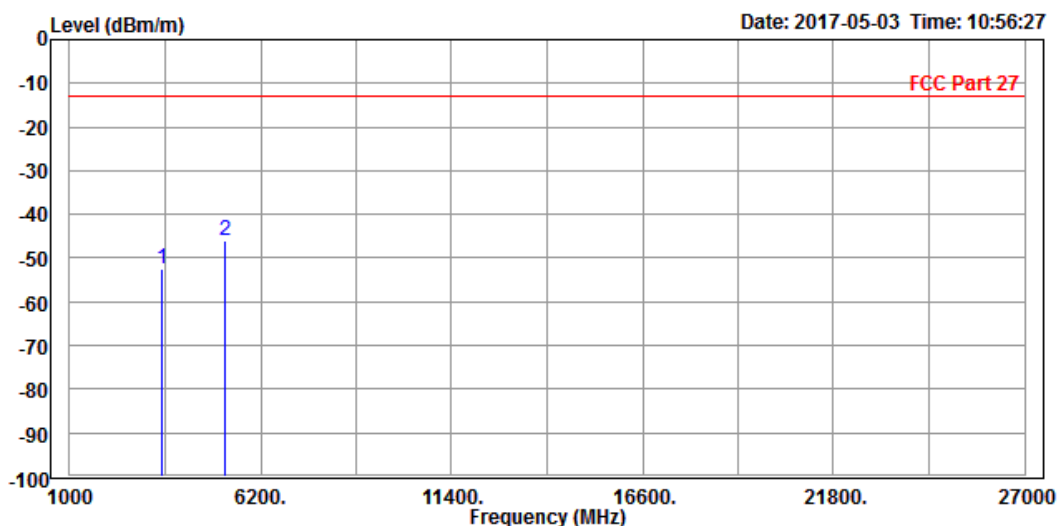



Test Report No.: RF170330W002-5

CHANNEL BANDWIDTH: 15MHz / QPSK

MODE	TX channel 20175	FREQUENCY RANGE	Above 1000MHz
ENVIRONMENTAL CONDITIONS	26deg. C, 56%RH	INPUT POWER	DC 5.2V from adapter
TESTED BY	Tony Zou		
ANTENNA POLARITY & TEST DISTANCE: HORIZONTAL AT 3 M			

	Freq	Level	Read Level	Limit Line	Over Limit	Factor	Remark	Pol/Phase
	MHz	dBm/m	dBm	dBm/m	dB	dB/m		
1	3444.000	-53.72	-55.67	-13.00	-40.72	1.95	Peak	Horizontal
2 PP	5186.000	-45.98	-54.57	-13.00	-32.98	8.59	Peak	Horizontal

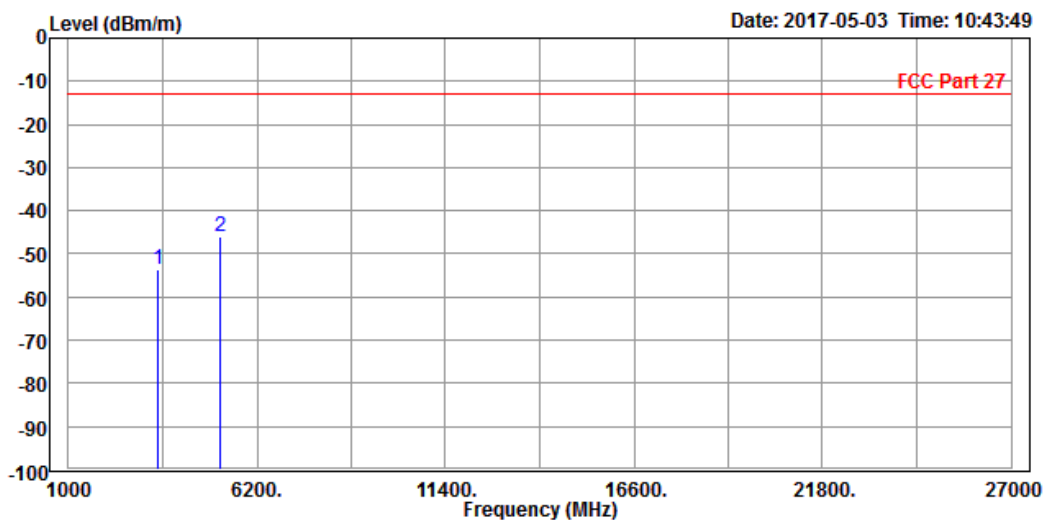



Test Report No.: RF170330W002-5

MODE	TX channel 20175	FREQUENCY RANGE	Above 1000MHz
ENVIRONMENTAL CONDITIONS	26deg. C, 56%RH	INPUT POWER	DC 5.2V from adapter
TESTED BY	Tony Zou		
ANTENNA POLARITY & TEST DISTANCE: VERTICAL AT 3 M			

	Freq	Level	Read Level	Limit Line	Over Limit	Factor	Remark	Pol/Phase
	MHz	dBm/m	dBm	dBm/m	dB	dB/m		
1	3444.000	-52.20	-54.70	-13.00	-39.20	2.50	Peak	Vertical
2 PP	5186.000	-46.63	-54.61	-13.00	-33.63	7.98	Peak	Vertical

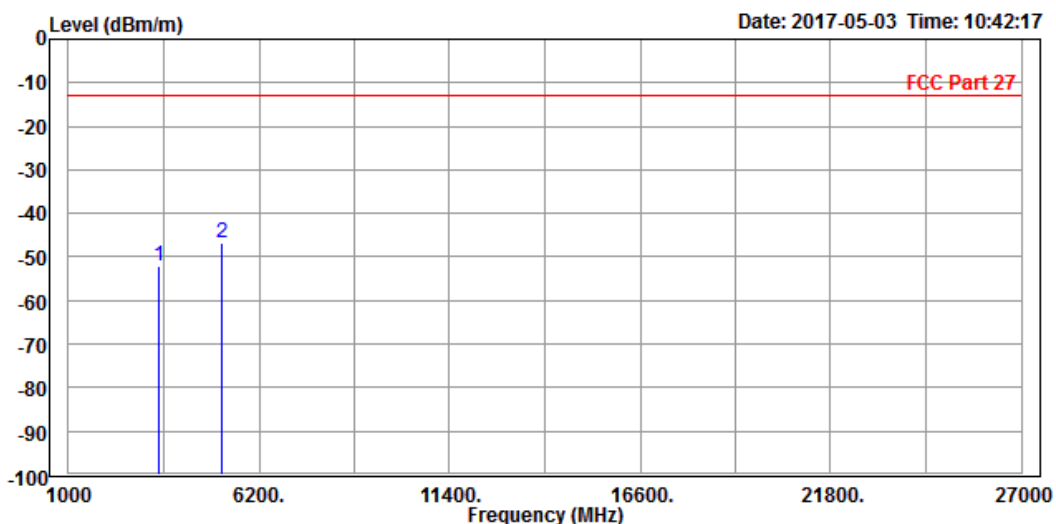



Test Report No.: RF170330W002-5

CHANNEL BANDWIDTH: 20MHz / QPSK

MODE	TX channel 20175	FREQUENCY RANGE	Above 1000MHz
ENVIRONMENTAL CONDITIONS	26deg. C, 56%RH	INPUT POWER	DC 5.2V from adapter
TESTED BY	Tony Zou		
ANTENNA POLARITY & TEST DISTANCE: HORIZONTAL AT 3 M			

	Freq	Level	Read Level	Limit Line	Over Limit	Factor	Remark	Pol/Phase
	MHz	dBm/m	dBm	dBm/m	dB	dB/m		
1	3444.000	-54.20	-56.15	-13.00	-41.20	1.95	Peak	Horizontal
2 PP	5186.000	-46.71	-55.30	-13.00	-33.71	8.59	Peak	Horizontal

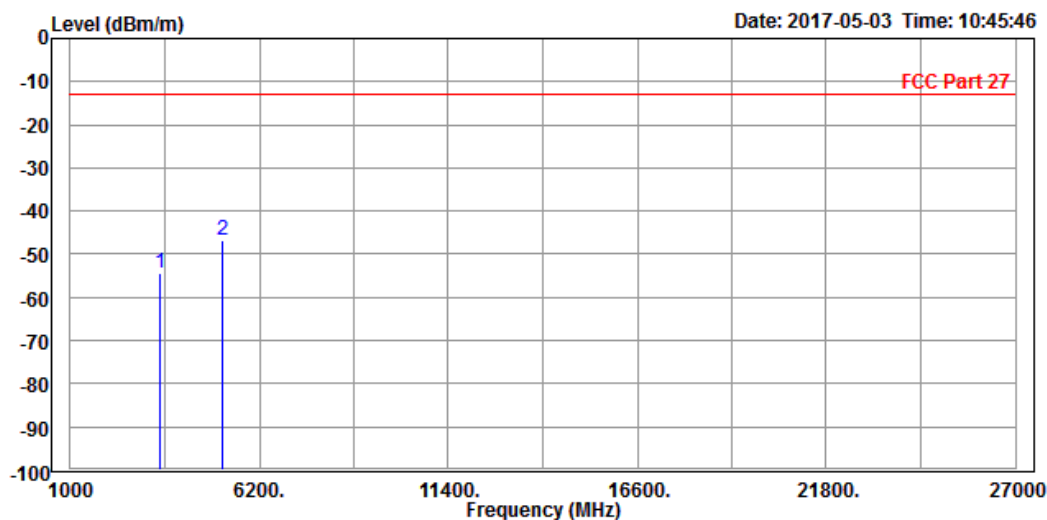



Test Report No.: RF170330W002-5

MODE	TX channel 20175	FREQUENCY RANGE	Above 1000MHz
ENVIRONMENTAL CONDITIONS	26deg. C, 56%RH	INPUT POWER	DC 5.2V from adapter
TESTED BY	Tony Zou		
ANTENNA POLARITY & TEST DISTANCE: VERTICAL AT 3 M			

	Freq	Level	Read Level	Limit Line	Over Limit	Factor	Remark	Pol/Phase
	MHz	dBm/m	dBm	dBm/m	dB	dB/m		
1	3444.000	-53.06	-55.56	-13.00	-40.06	2.50	Peak	Vertical
2 PP	5186.000	-47.40	-55.38	-13.00	-34.40	7.98	Peak	Vertical

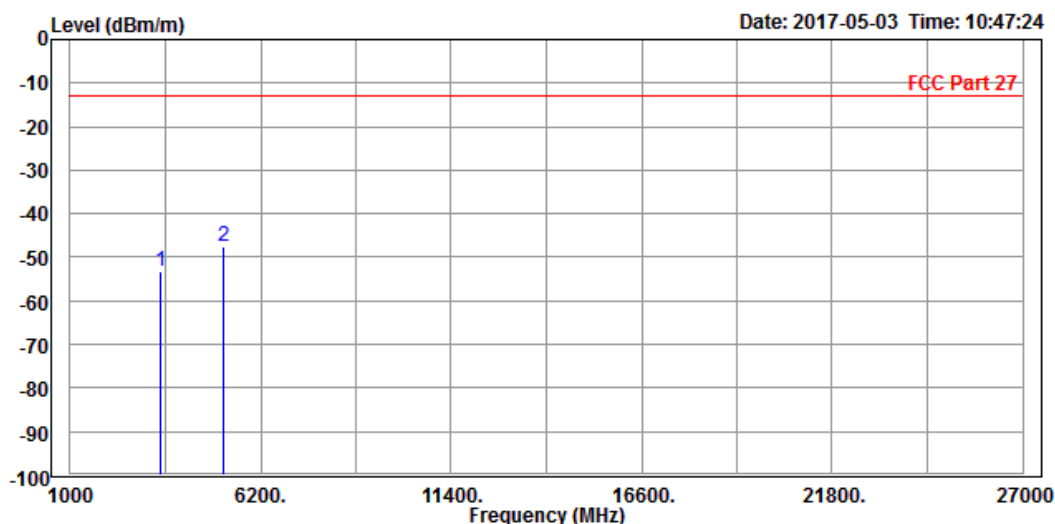



Test Report No.: RF170330W002-5

LTE BAND 12

CHANNEL BANDWIDTH: 1.4MHz / QPSK

MODE	TX channel 23095	FREQUENCY RANGE	Above 1000MHz
ENVIRONMENTAL CONDITIONS	26deg. C, 56%RH	INPUT POWER	DC 5.2V from adapter
TESTED BY	Tony Zou		
ANTENNA POLARITY & TEST DISTANCE: HORIZONTAL AT 3 M			

	Freq	Level	Read Level	Limit Line	Over Limit	Factor	Remark	Pol/Phase
	MHz	dBm/m	dBm	dBm/m	dB	dB/m		
1	1416.000	-56.89	-50.17	-13.00	-43.89	-6.72	Peak	Horizontal
2 PP	2122.500	-51.68	-49.75	-13.00	-38.68	-1.93	Peak	Horizontal

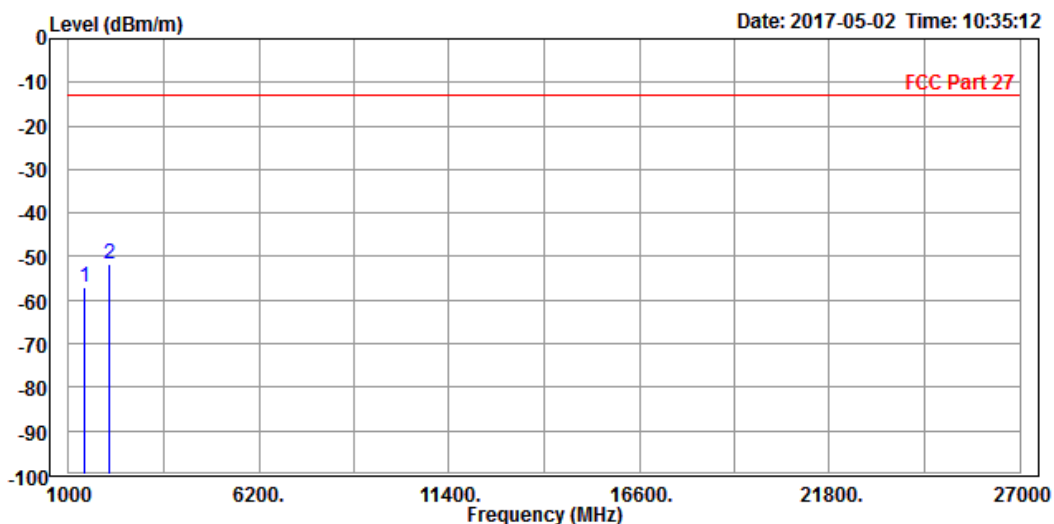



Test Report No.: RF170330W002-5

MODE	TX channel 23095	FREQUENCY RANGE	Above 1000MHz
ENVIRONMENTAL CONDITIONS	26deg. C, 56%RH	INPUT POWER	DC 5.2V from adapter
TESTED BY	Tony Zou		
ANTENNA POLARITY & TEST DISTANCE: VERTICAL AT 3 M			

	Freq	Level	Read Level	Limit Line	Over Limit	Factor	Remark	Pol/Phase
	MHz	dBm/m	dBm	dBm/m	dB	dB/m		
1	1416.000	-57.20	-51.76	-13.00	-44.20	-5.44	Peak	Vertical
2	PP 2122.500	-48.21	-47.97	-13.00	-35.21	-0.24	Peak	Vertical

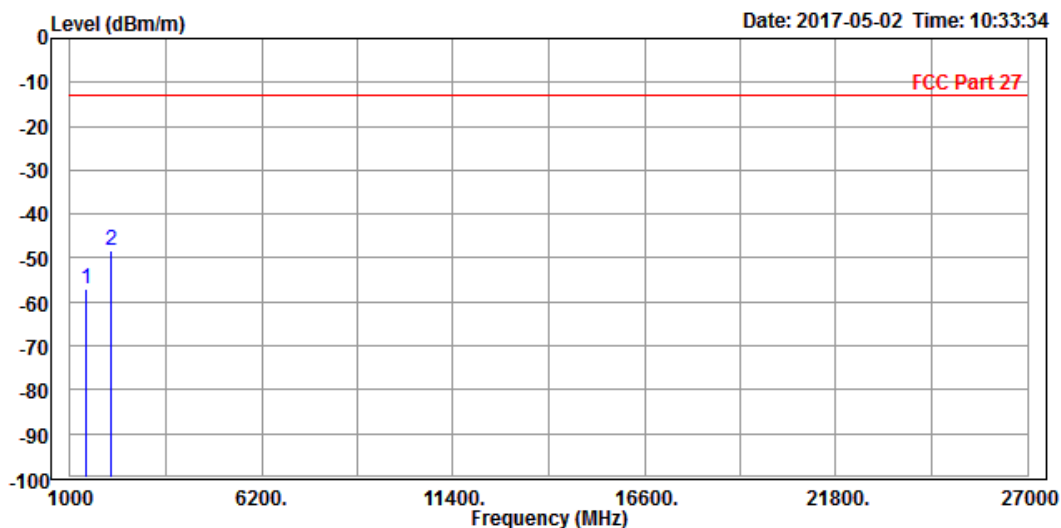



Test Report No.: RF170330W002-5

CHANNEL BANDWIDTH: 3MHz / QPSK

MODE	TX channel 23095	FREQUENCY RANGE	Above 1000MHz
ENVIRONMENTAL CONDITIONS	26deg. C, 56%RH	INPUT POWER	DC 5.2V from adapter
TESTED BY	Tony Zou		
ANTENNA POLARITY & TEST DISTANCE: HORIZONTAL AT 3 M			

	Freq	Level	Read Level	Limit Line	Over Limit	Factor	Remark	Pol/Phase
	MHz	dBm/m	dBm	dBm/m	dB	dB/m		
1	1416.000	-54.78	-48.06	-13.00	-41.78	-6.72	Peak	Horizontal
2	PP 2122.500	-52.15	-50.22	-13.00	-39.15	-1.93	Peak	Horizontal

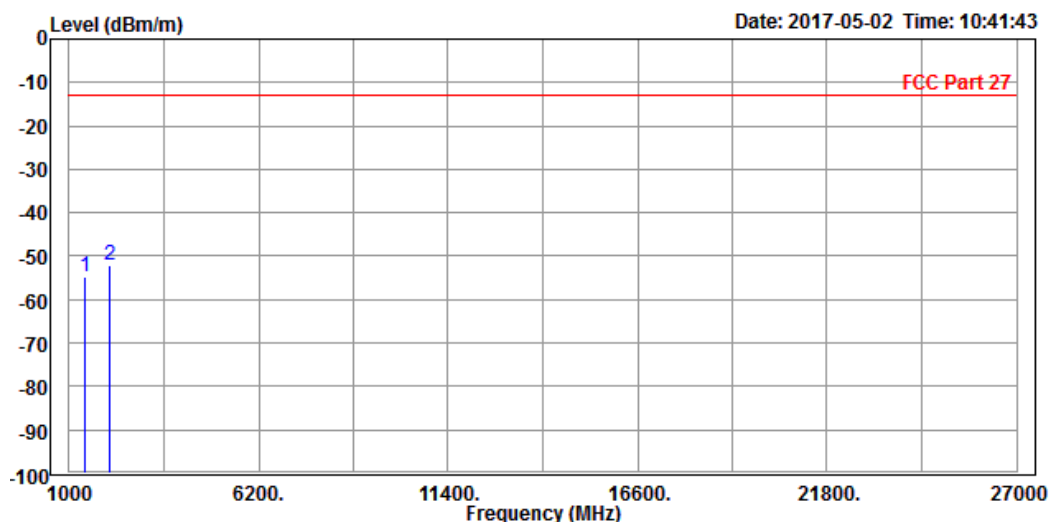



Test Report No.: RF170330W002-5

MODE	TX channel 23095	FREQUENCY RANGE	Above 1000MHz
ENVIRONMENTAL CONDITIONS	26deg. C, 56%RH	INPUT POWER	DC 5.2V from adapter
TESTED BY	Tony Zou		
ANTENNA POLARITY & TEST DISTANCE: VERTICAL AT 3 M			

	Freq	Level	Read Level	Limit Line	Over Limit	Factor	Remark	Pol/Phase
	MHz	dBm/m	dBm	dBm/m	dB	dB/m		
1	1416.000	-58.32	-52.88	-13.00	-45.32	-5.44	Peak	Vertical
2	PP 2122.500	-47.28	-47.04	-13.00	-34.28	-0.24	Peak	Vertical

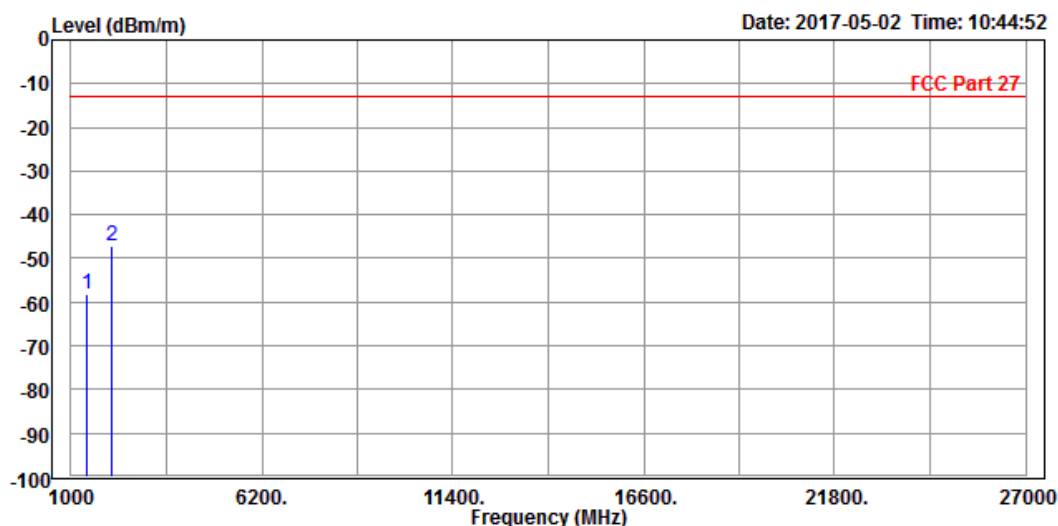



Test Report No.: RF170330W002-5

CHANNEL BANDWIDTH: 5MHz / QPSK

MODE	TX channel 23095	FREQUENCY RANGE	Above 1000MHz
ENVIRONMENTAL CONDITIONS	26deg. C, 56%RH	INPUT POWER	DC 5.2V from adapter
TESTED BY	Tony Zou		
ANTENNA POLARITY & TEST DISTANCE: HORIZONTAL AT 3 M			

	Freq	Level	Read Level	Limit Line	Over Limit	Factor	Remark	Pol/Phase
	MHz	dBm/m	dBm	dBm/m	dB	dB/m		
1	1416.000	-57.31	-50.59	-13.00	-44.31	-6.72	Peak	Horizontal
2 PP	2122.500	-52.40	-50.47	-13.00	-39.40	-1.93	Peak	Horizontal

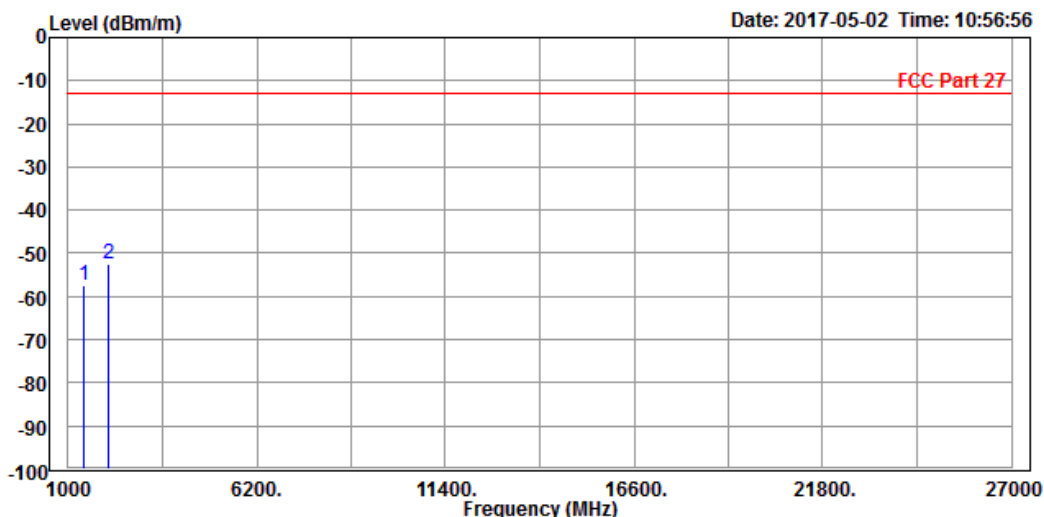



Test Report No.: RF170330W002-5

MODE	TX channel 23095	FREQUENCY RANGE	Above 1000MHz
ENVIRONMENTAL CONDITIONS	26deg. C, 56%RH	INPUT POWER	DC 5.2V from adapter
TESTED BY	Tony Zou		
ANTENNA POLARITY & TEST DISTANCE: VERTICAL AT 3 M			

	Freq	Level	Read Level	Limit Line	Over Limit	Factor	Remark	Pol/Phase
	MHz	dBm/m	dBm	dBm/m	dB	dB/m		
1	1416.000	-56.50	-51.06	-13.00	-43.50	-5.44	Peak	Vertical
2 PP	2122.500	-46.95	-46.71	-13.00	-33.95	-0.24	Peak	Vertical

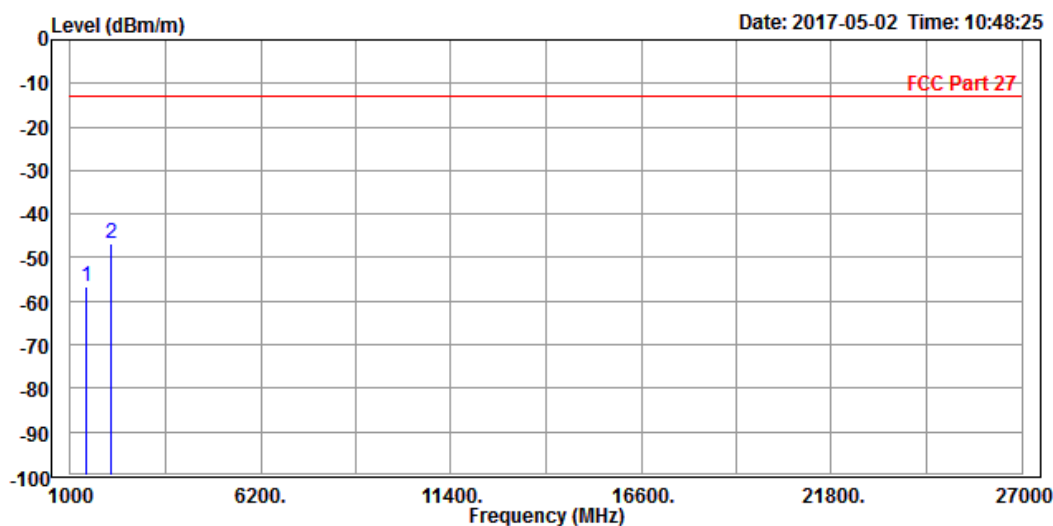



Test Report No.: RF170330W002-5

CHANNEL BANDWIDTH: 10MHz / QPSK

CH 23060

MODE	TX channel 23060	FREQUENCY RANGE	Above 1000MHz
ENVIRONMENTAL CONDITIONS	23deg. C, 66%RH	INPUT POWER	DC 5.2V from adapter
TESTED BY	Tony Zou		
ANTENNA POLARITY & TEST DISTANCE: HORIZONTAL AT 3 M			

	Freq	Level	Read Level	Limit Line	Over Limit	Factor	Remark	Pol/Phase
	MHz	dBm/m	dBm	dBm/m	dB	dB/m		
1	1416.000	-55.72	-49.00	-13.00	-42.72	-6.72	Peak	Horizontal
2 PP	2118.000	-51.50	-49.56	-13.00	-38.50	-1.94	Peak	Horizontal

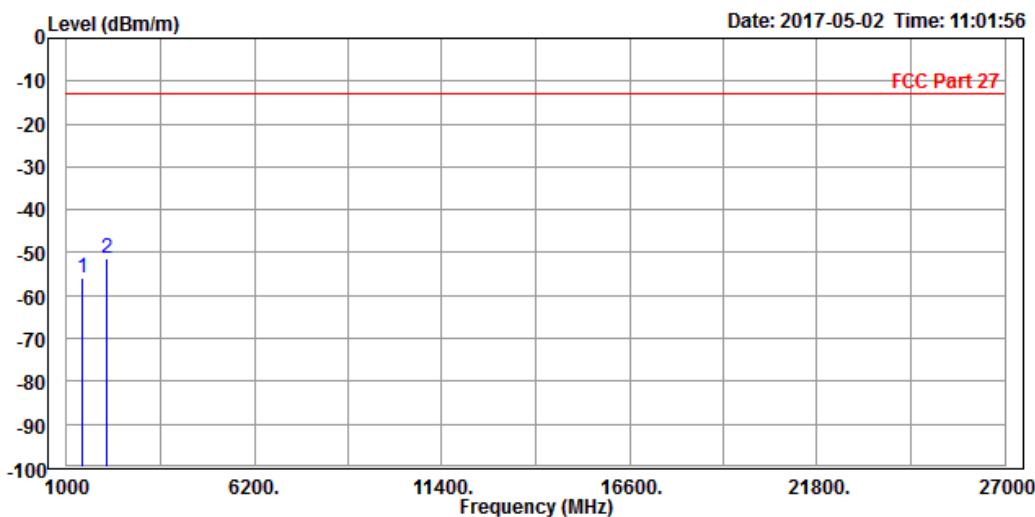



Test Report No.: RF170330W002-5

MODE	TX channel 23060	FREQUENCY RANGE	Above 1000MHz
ENVIRONMENTAL CONDITIONS	23deg. C, 66%RH	INPUT POWER	DC 5.2V from adapter
TESTED BY	Tony Zou		
ANTENNA POLARITY & TEST DISTANCE: VERTICAL AT 3 M			

	Freq	Level	Read Level	Limit Line	Over Limit	Factor	Remark	Pol/Phase
	MHz	dBm/m	dBm	dBm/m	dB	dB/m		
1	1416.000	-58.67	-53.23	-13.00	-45.67	-5.44	Peak	Vertical
2	PP 2118.000	-49.45	-49.21	-13.00	-36.45	-0.24	Peak	Vertical

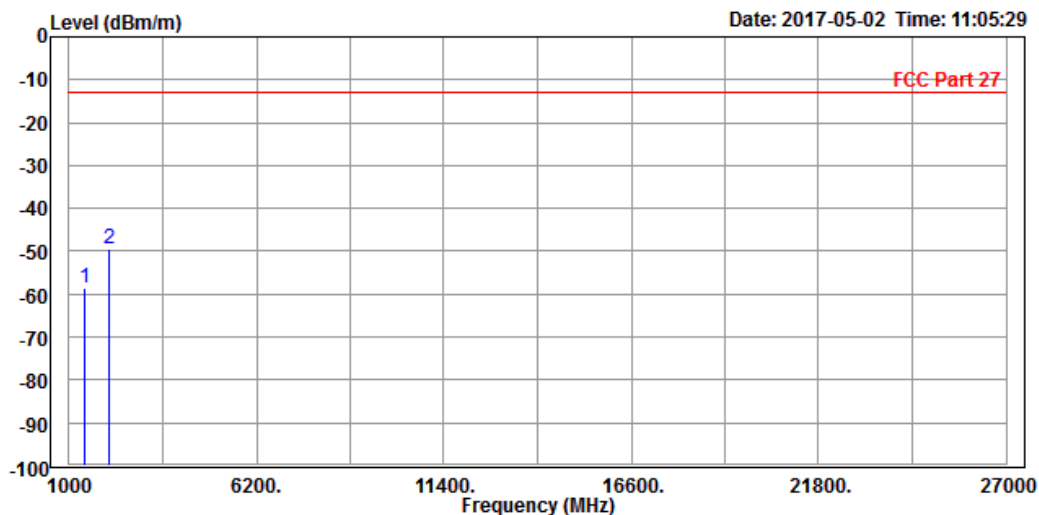



Test Report No.: RF170330W002-5

CH 23095

MODE	TX channel 23095	FREQUENCY RANGE	Above 1000MHz
ENVIRONMENTAL CONDITIONS	23deg. C, 66%RH	INPUT POWER	DC 5.2V from adapter
TESTED BY	Tony Zou		
ANTENNA POLARITY & TEST DISTANCE: HORIZONTAL AT 3 M			

	Freq	Level	Read Level	Limit Line	Over Limit	Factor	Remark	Pol/Phase
	MHz	dBm/m	dBm	dBm/m	dB	dB/m		
1	1416.000	-59.56	-52.84	-13.00	-46.56	-6.72	Peak	Horizontal
2	PP 2122.500	-44.93	-43.00	-13.00	-31.93	-1.93	Peak	Horizontal

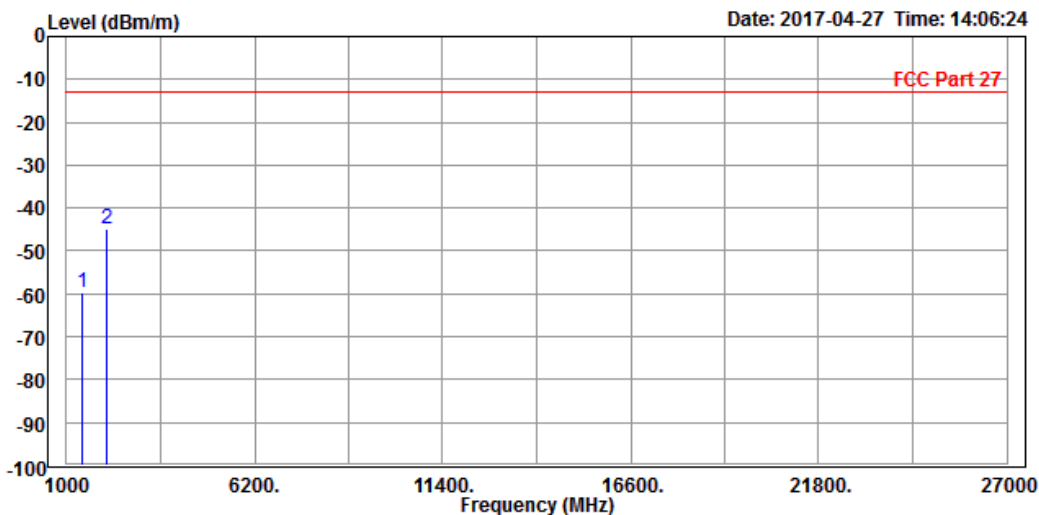



Test Report No.: RF170330W002-5

MODE	TX channel 23095	FREQUENCY RANGE	Above 1000MHz
ENVIRONMENTAL CONDITIONS	23deg. C, 66%RH	INPUT POWER	DC 5.2V from adapter
TESTED BY	Tony Zou		
ANTENNA POLARITY & TEST DISTANCE: VERTICAL AT 3 M			

	Freq	Level	Read Level	Limit Line	Over Limit	Factor	Remark	Pol/Phase
	MHz	dBm/m	dBm	dBm/m	dB	dB/m		
1	1416.000	-58.53	-53.09	-13.00	-45.53	-5.44	Peak	Vertical
2 PP	2122.500	-50.03	-49.79	-13.00	-37.03	-0.24	Peak	Vertical

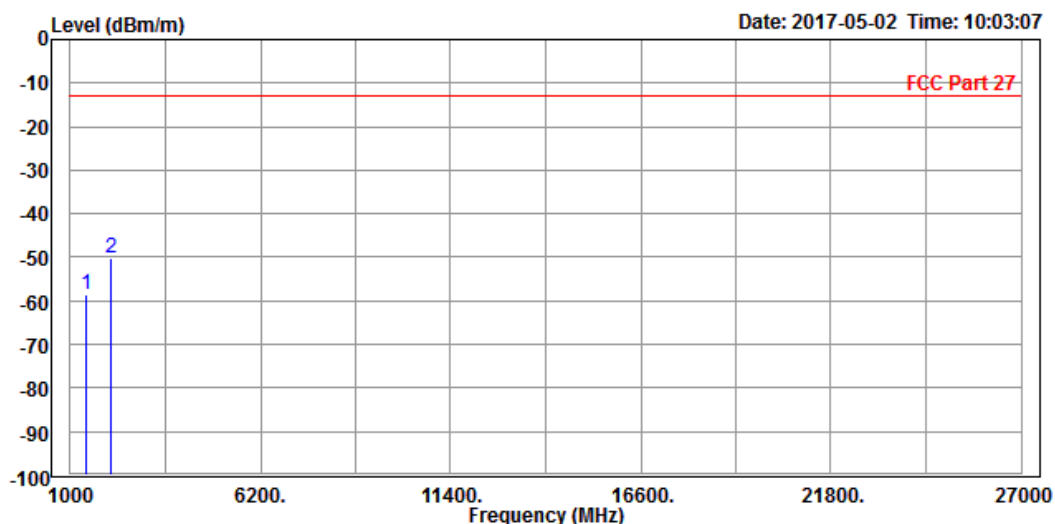



Test Report No.: RF170330W002-5

CH 23130

MODE	TX channel 23130	FREQUENCY RANGE	Above 1000MHz
ENVIRONMENTAL CONDITIONS	23deg. C, 66%RH	INPUT POWER	DC 5.2V from adapter
TESTED BY	Tony Zou		
ANTENNA POLARITY & TEST DISTANCE: HORIZONTAL AT 3 M			

	Freq	Level	Read Level	Limit Line	Over Limit	Factor	Remark	Pol/Phase
	MHz	dBm/m	dBm	dBm/m	dB	dB/m		
1	1416.000	-55.06	-48.34	-13.00	-42.06	-6.72	Peak	Horizontal
2 PP	2130.000	-52.64	-50.71	-13.00	-39.64	-1.93	Peak	Horizontal

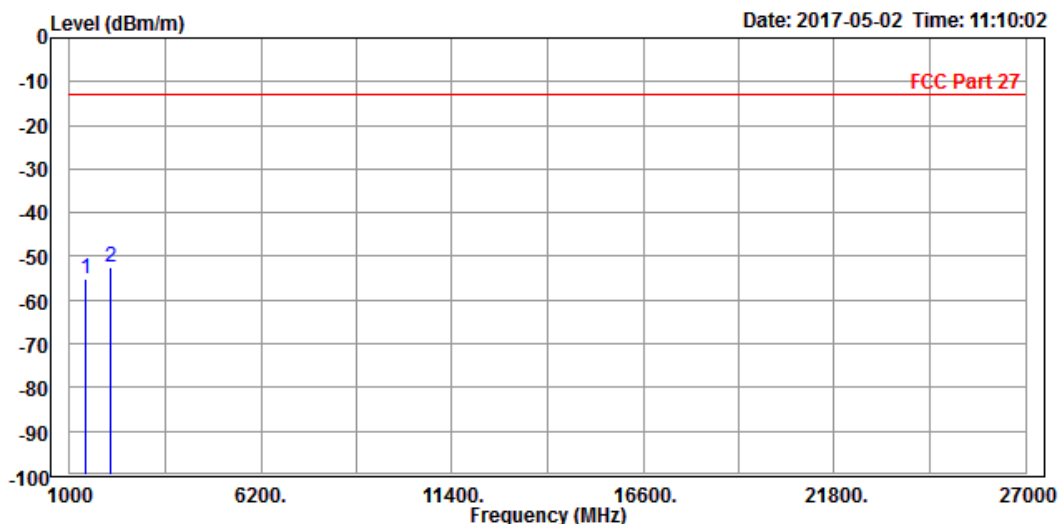



Test Report No.: RF170330W002-5

MODE	TX channel 23130	FREQUENCY RANGE	Above 1000MHz
ENVIRONMENTAL CONDITIONS	23deg. C, 66%RH	INPUT POWER	DC 5.2V from adapter
TESTED BY	Tony Zou		
ANTENNA POLARITY & TEST DISTANCE: VERTICAL AT 3 M			

	Freq	Level	Read Level	Limit Line	Over Limit	Factor	Remark	Pol/Phase
	MHz	dBm/m	dBm	dBm/m	dB	dB/m		
1	1416.000	-58.56	-53.12	-13.00	-45.56	-5.44	Peak	Vertical
2 PP	2130.000	-47.71	-47.47	-13.00	-34.71	-0.24	Peak	Vertical

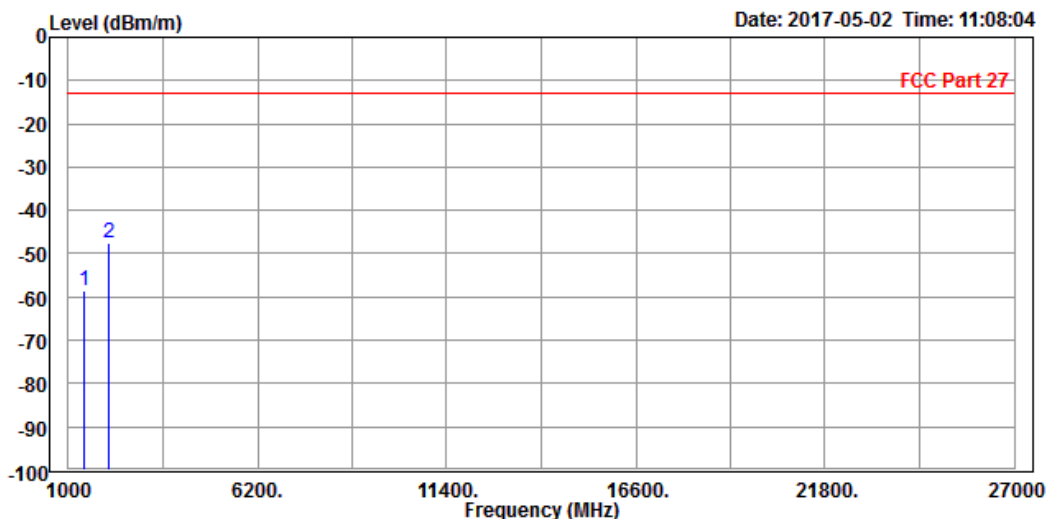



Test Report No.: RF170330W002-5

LTE BAND 13

CHANNEL BANDWIDTH: 5MHz / QPSK

CH 23205

MODE	TX channel 23205	FREQUENCY RANGE	Above 1000MHz
ENVIRONMENTAL CONDITIONS	23deg. C, 66%RH	INPUT POWER	DC 5.2V from adapter
TESTED BY	Tony Zou		
ANTENNA POLARITY & TEST DISTANCE: HORIZONTAL AT 3 M			

	Freq	Level	Read Level	Limit Line	Over Limit	Factor	Remark	Pol/Phase
	MHz	dBm/m	dBm	dBm/m	dB	dB/m		
1	PP 1546.000	-55.42	-49.60	-13.00	-42.42	-5.82	Peak	Horizontal
2	2326.000	-56.23	-54.46	-13.00	-43.23	-1.77	Peak	Horizontal

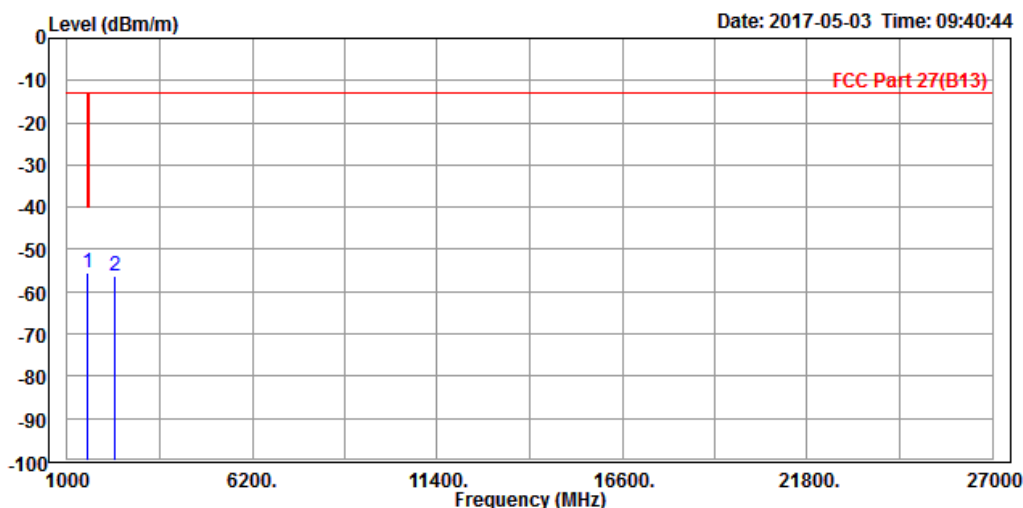



Test Report No.: RF170330W002-5

MODE	TX channel 23205	FREQUENCY RANGE	Above 1000MHz
ENVIRONMENTAL CONDITIONS	23deg. C, 66%RH	INPUT POWER	DC 5.2V from adapter
TESTED BY	Tony Zou		
ANTENNA POLARITY & TEST DISTANCE: VERTICAL AT 3 M			

	Freq	Level	Read Level	Limit Line	Over Limit	Factor	Remark	Pol/Phase
	MHz	dBm/m	dBm	dBm/m	dB	dB/m		
1	1546.000	-56.87	-52.37	-13.00	-43.87	-4.50	Peak	Vertical
2	PP 2326.000	-48.77	-48.57	-13.00	-35.77	-0.20	Peak	Vertical

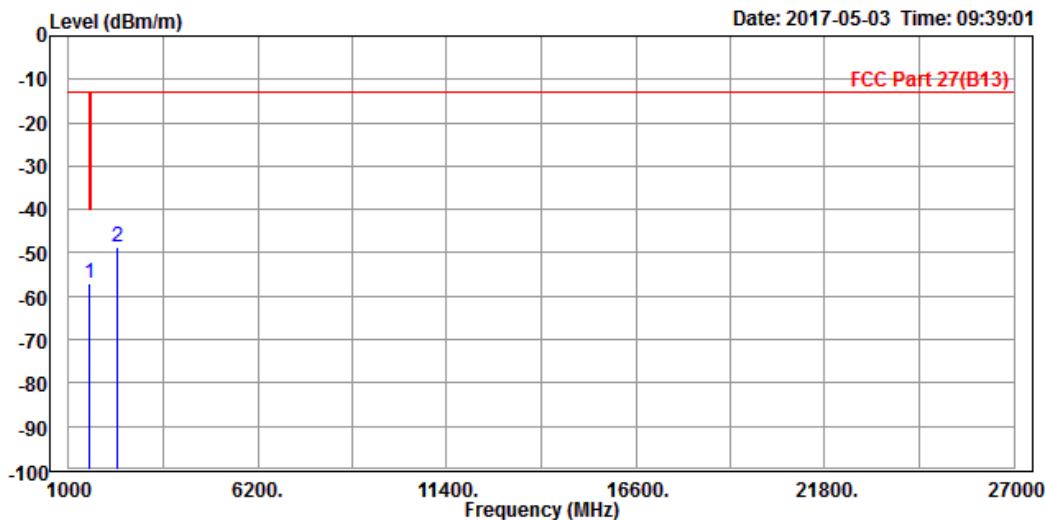



Test Report No.: RF170330W002-5

CH 23230

MODE	TX channel 23230	FREQUENCY RANGE	Above 1000MHz
ENVIRONMENTAL CONDITIONS	23deg. C, 66%RH	INPUT POWER	DC 5.2V from adapter
TESTED BY	Tony Zou		
ANTENNA POLARITY & TEST DISTANCE: HORIZONTAL AT 3 M			

	Freq	Level	Read Level	Limit Line	Over Limit	Factor	Remark	Pol/Phase
	MHz	dBm/m	dBm	dBm/m	dB	dB/m		
1	1546.000	-55.25	-49.43	-13.00	-42.25	-5.82	Peak	Horizontal
2	PP 2326.000	-50.87	-49.10	-13.00	-37.87	-1.77	Peak	Horizontal

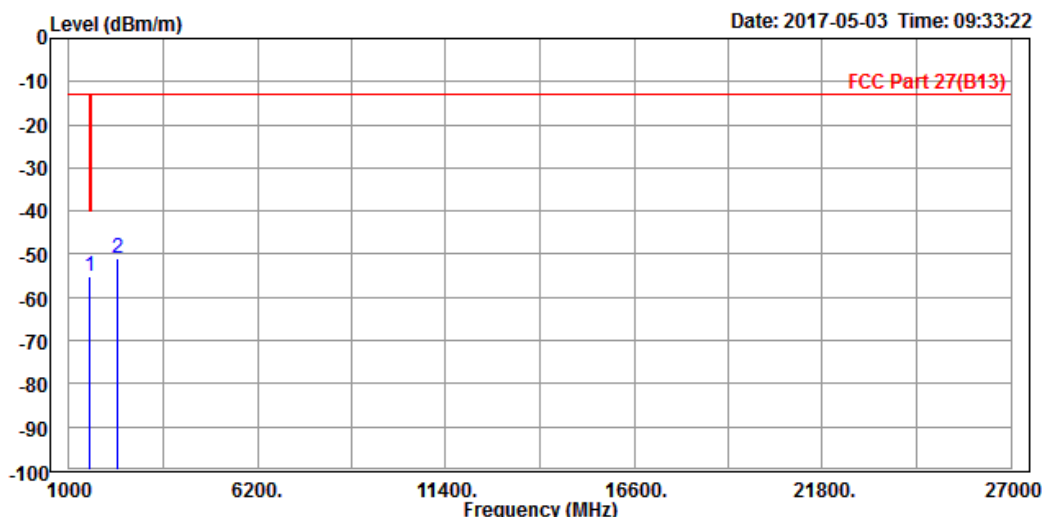



Test Report No.: RF170330W002-5

MODE	TX channel 23230	FREQUENCY RANGE	Above 1000MHz
ENVIRONMENTAL CONDITIONS	23deg. C, 66%RH	INPUT POWER	DC 5.2V from adapter
TESTED BY	Tony Zou		
ANTENNA POLARITY & TEST DISTANCE: VERTICAL AT 3 M			

	Freq	Level	Read Level	Limit Line	Over Limit	Factor	Remark	Pol/Phase
	MHz	dBm/m	dBm	dBm/m	dB	dB/m		
1	1546.000	-55.74	-51.24	-13.00	-42.74	-4.50	Peak	Vertical
2 PP	2326.000	-49.50	-49.30	-13.00	-36.50	-0.20	Peak	Vertical

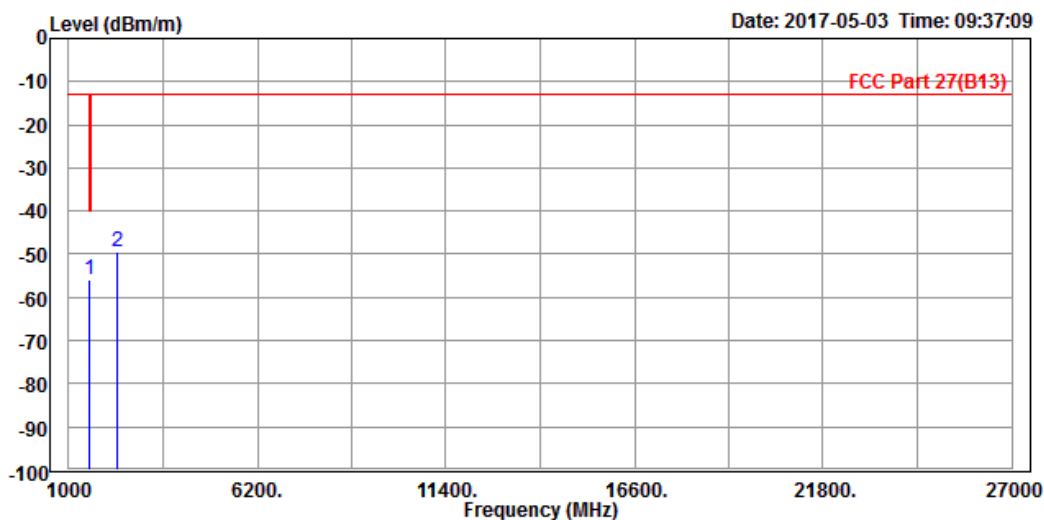



Test Report No.: RF170330W002-5

CH 23255

MODE	TX channel 23255	FREQUENCY RANGE	Above 1000MHz
ENVIRONMENTAL CONDITIONS	23deg. C, 66%RH	INPUT POWER	DC 5.2V from adapter
TESTED BY	Tony Zou		
ANTENNA POLARITY & TEST DISTANCE: HORIZONTAL AT 3 M			

	Freq	Level	Read Level	Limit	Over Limit	Factor	Remark	Pol/Phase
	MHz	dBm/m	dBm	dBm/m	dB	dB/m		
1	PP 1572.000	-53.57	-47.97	-40.00	-13.57	-5.60	Peak	Horizontal
2	2352.000	-51.29	-49.54	-13.00	-38.29	-1.75	Peak	Horizontal

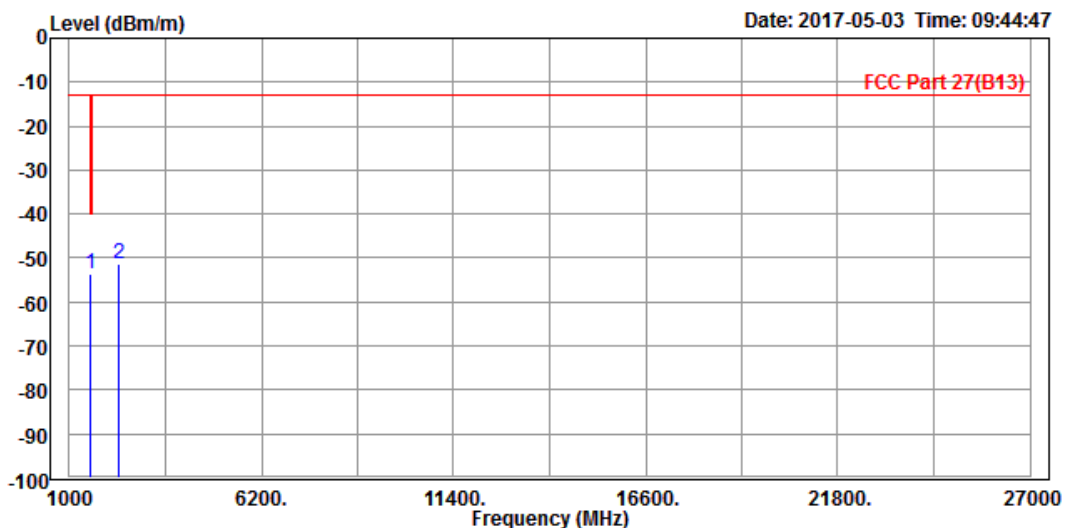



Test Report No.: RF170330W002-5

MODE	TX channel 23255	FREQUENCY RANGE	Above 1000MHz
ENVIRONMENTAL CONDITIONS	23deg. C, 66%RH	INPUT POWER	DC 5.2V from adapter
TESTED BY	Tony Zou		
ANTENNA POLARITY & TEST DISTANCE: VERTICAL AT 3 M			

		Read	Limit	Over				
	Freq	Level	Level	Line	Limit	Factor	Remark	Pol/Phase
	MHz	dBm/m	dBm	dBm/m	dB	dB/m		
1	PP 1572.000	-55.66	-51.40	-40.00	-15.66	-4.26	Peak	Vertical
2	2352.000	-45.87	-45.67	-13.00	-32.87	-0.20	Peak	Vertical

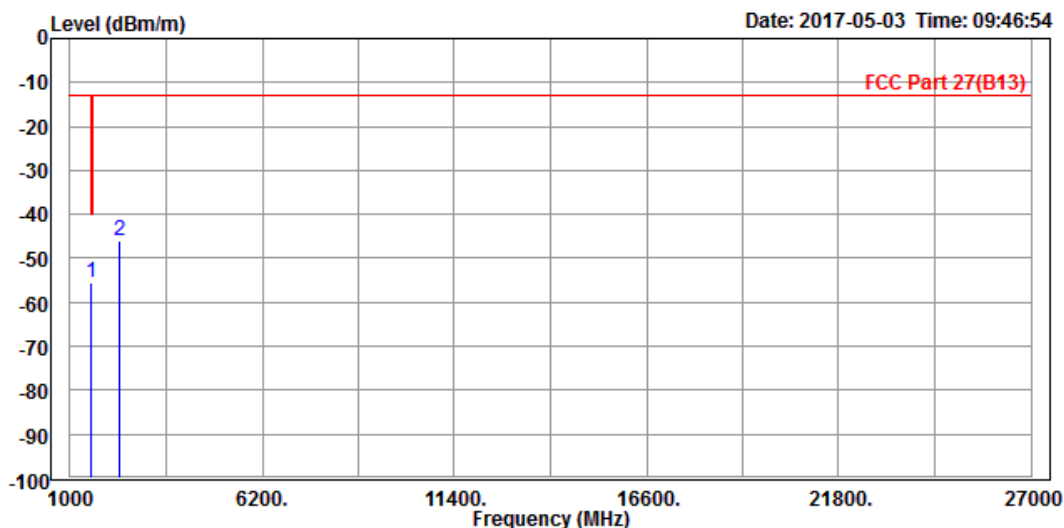



Test Report No.: RF170330W002-5

CHANNEL BANDWIDTH: 10MHz / QPSK

MODE	TX channel 23230	FREQUENCY RANGE	Above 1000MHz
ENVIRONMENTAL CONDITIONS	23deg. C, 66%RH	INPUT POWER	DC 5.2V from adapter
TESTED BY	Tony Zou		
ANTENNA POLARITY & TEST DISTANCE: HORIZONTAL AT 3 M			

	Freq	Level	Read Level	Limit Line	Over Limit	Factor	Remark	Pol/Phase
	MHz	dBm/m	dBm	dBm/m	dB	dB/m		
1	1546.000	-54.34	-48.52	-13.00	-41.34	-5.82	Peak	Horizontal
2 PP	2326.000	-46.95	-45.18	-13.00	-33.95	-1.77	Peak	Horizontal

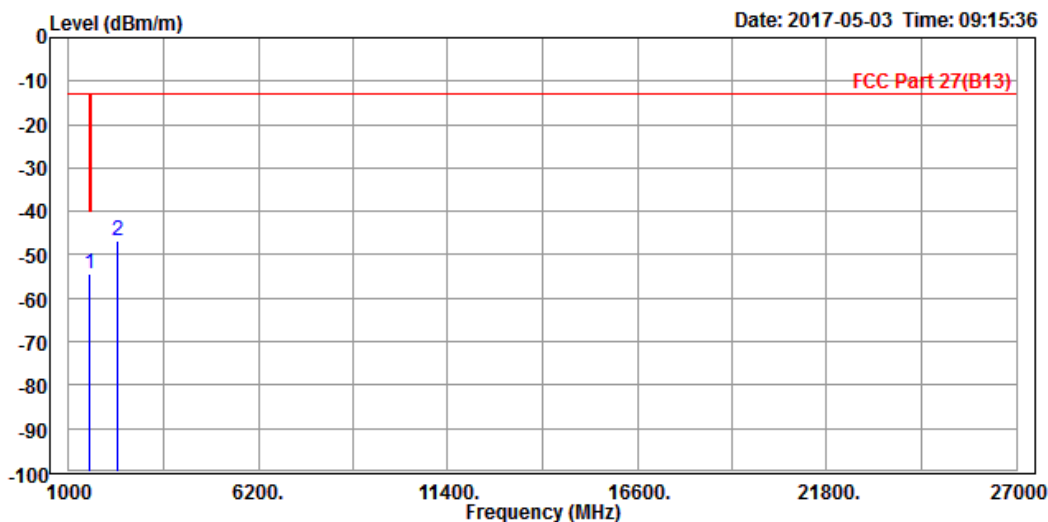



Test Report No.: RF170330W002-5

MODE	TX channel 23230	FREQUENCY RANGE	Above 1000MHz
ENVIRONMENTAL CONDITIONS	23deg. C, 66%RH	INPUT POWER	DC 5.2V from adapter
TESTED BY	Tony Zou		
ANTENNA POLARITY & TEST DISTANCE: VERTICAL AT 3 M			

	Freq	Level	Read Level	Limit Line	Over Limit	Factor	Remark	Pol/Phase
	MHz	dBm/m	dBm	dBm/m	dB	dB/m		
1	1546.000	-56.57	-52.07	-13.00	-43.57	-4.50	Peak	Vertical
2 PP	2326.000	-42.53	-42.33	-13.00	-29.53	-0.20	Peak	Vertical

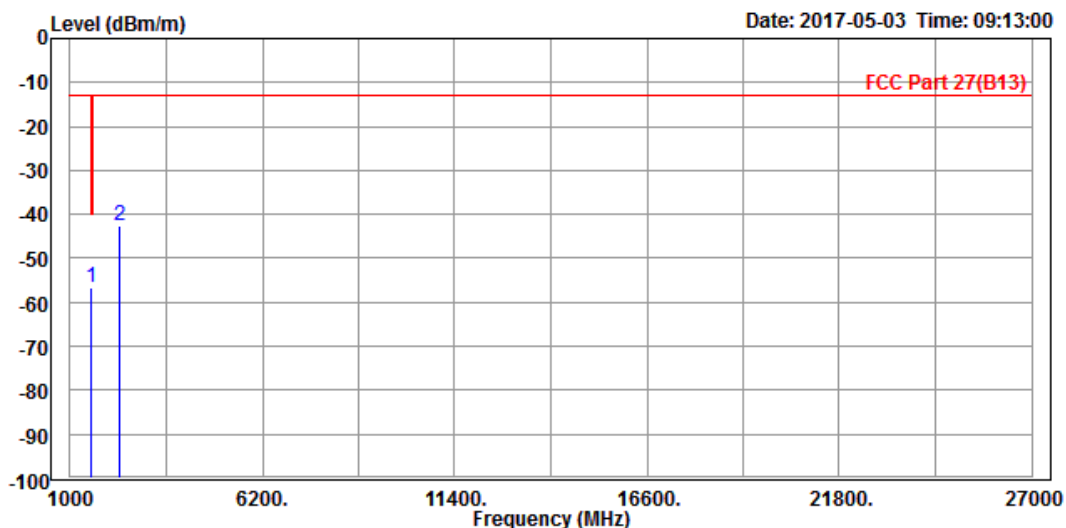



Test Report No.: RF170330W002-5

5 INFORMATION ON THE TESTING LABORATORIES

We, Bureau Veritas Shenzhen Co., Ltd. Dongguan Branch, were founded in 2002 to provide our best service in EMC, Radio, Telecom and Safety consultation. Our laboratories are accredited and approved according to ISO/IEC 17025.

If you have any comments, please feel free to contact us at the following:

Dongguan EMC/RF Lab:

Tel: +86-769-85935656

Fax: +86-769-85931080

Email: customerservice.dg@cn.bureauveritas.com

Web Site: www.adt.com.tw

The address and road map of all our labs can be found in our web site also.



Test Report No.: RF170330W002-5

6 APPENDIX A – MODIFICATIONS RECORDERS FOR ENGINEERING CHANGES TO THE EUT BY THE LAB

No modifications were made to the EUT by the lab during the test.

---END---