



FCC RF Test Report

APPLICANT : Lenovo(Shanghai) Electronics Technology Co., Ltd.
EQUIPMENT : Portable Tablet Computer
BRAND NAME : Lenovo
MODEL NAME : Lenovo TB-8506X
FCC ID : O57TB8506X
STANDARD : 47 CFR Part 2, 22(H), 24(E), 27(L), 27(M)
CLASSIFICATION : PCS Licensed Transmitter (PCB)

The product was received on Feb. 24, 2021 and completely tested on Mar. 16, 2021. We, Sporton International (Kunshan) Inc., would like to declare that the tested sample has been evaluated in accordance with the procedures given in ANSI C63.26-2015 and shown compliance with the applicable technical standards.

The test results in this report apply exclusively to the tested model / sample. Without written approval of Sporton International (Kunshan) Inc., the test report shall not be reproduced except in full.

Reviewed by: Jason Jia / Supervisor

Approved by: Alex Wang / Manager



Sporton International (Kunshan) Inc.

**No. 1098, Pengxi North Road, Kunshan Economic Development Zone Jiangsu Province 215300
People's Republic of China**



TABLE OF CONTENTS

REVISION HISTORY...3
SUMMARY OF TEST RESULT...4
1 GENERAL DESCRIPTION...5
1.1 Applicant...5
1.2 Manufacturer...5
1.3 Product Feature of Equipment Under Test...5
1.4 Product Specification of Equipment Under Test...6
1.5 Modification of EUT...6
1.6 Maximum ERP/EIRP, Frequency Tolerance, and Emission Designator...7
1.7 Testing Location...8
1.8 Test Software...8
1.9 Applicable Standards...8
2 TEST CONFIGURATION OF EQUIPMENT UNDER TEST...9
2.1 Test Mode...9
2.2 Connection Diagram of Test System...11
2.3 Support Unit used in test configuration and system...11
2.4 Measurement Results Explanation Example...11
2.5 Frequency List of Low/Middle/High Channels...12
3 CONDUCTED TEST ITEMS...15
3.1 Measuring Instruments...15
3.2 Test Setup...15
3.3 Test Result of Conducted Test...15
3.4 Conducted Output Power and ERP/EIRP...16
3.5 Peak-to-Average Ratio...17
3.6 Occupied Bandwidth...18
3.7 Conducted Band Edge...19
3.8 Conducted Spurious Emission...21
3.9 Frequency Stability...22
4 RADIATED TEST ITEMS...23
4.1 Measuring Instruments...23
4.2 Test Setup...23
4.3 Test Result of Radiated Test...23
4.4 Radiated Spurious Emission...24
5 LIST OF MEASURING EQUIPMENT...25
6 UNCERTAINTY OF EVALUATION...26
APPENDIX A. TEST RESULTS OF CONDUCTED TEST
APPENDIX B. TEST RESULTS OF RADIATED TEST
APPENDIX C. TEST SETUP PHOTOGRAPHS



REVISION HISTORY

REPORT NO.	VERSION	DESCRIPTION	ISSUED DATE
FG120606-01B	Rev. 01	Initial issue of report	Apr. 16, 2021



SUMMARY OF TEST RESULT

Report Section	FCC Rule	Description	Limit	Result	Remark
3.4	§2.1046	Conducted Output Power	Reporting Only	PASS	-
	§22.913(a)(5)	Effective Radiated Power (Band 5) (Band 26)	ERP < 7 Watt	PASS	-
	§24.232(c) §27.50(h)(2)	Equivalent Isotropic Radiated Power (Band 2) (Band 7) (Band 38) (Band 41)	EIRP < 2Watt	PASS	-
	§27.50(d)(4)	Equivalent Isotropic Radiated Power (Band 4)	EIRP < 1Watt	PASS	-
3.5	§24.232(d)	Peak-to-Average Ratio	<13 dB	PASS	-
3.6	§2.1049	Occupied Bandwidth	Reporting Only	PASS	-
3.7	§2.1051 §22.917(a) §24.238(a) §27.53(h)	Conducted Band Edge Measurement (Band 2) (Band 4) (Band 5) (Band 26)	< 43+10log ₁₀ (P[Watts])	PASS	-
	§27.53(m)(4)	Conducted Band Edge Measurement (Band 7) (Band 38) (Band 41)	§27.53(m)(4)		
3.8	§2.1051 §22.917(a) §24.238(a) §27.53(h)	Conducted Spurious Emission (Band 2) (Band 4) (Band 5) (Band 26)	< 43+10log ₁₀ (P[Watts])	PASS	-
	§2.1051 §27.53(m)(4)	Conducted Spurious Emission (Band 7) (Band 38) (Band 41)	< 55+10log ₁₀ (P[Watts])		
3.9	§2.1055 §22.355	Frequency Stability Temperature & Voltage	< 2.5 ppm for Part 22	PASS	-
	§2.1055 §24.235 §27.54		Within Authorized Band		
4.4	§2.1053 §22.917(a) §24.238(a) §27.53(h)	Radiated Spurious Emission (Band 2) (Band 4) (Band 5) (Band 26)	< 43+10log ₁₀ (P[Watts])	PASS	Under limit 26.72 dB at 12920.000 MHz
	§2.1053 §27.53(m)(4)	Radiated Spurious Emission (Band 7) (Band 38) (Band 41)	< 55+10log ₁₀ (P[Watts])		

Declaration of Conformity:

The test results with all measurement uncertainty excluded are presented in accordance with the regulation limits or requirements declared by manufacturers.

Comments and Explanations:

The declared of product specification for EUT presented in the report are provided by the manufacturer, and the manufacturer takes all the responsibilities for the accuracy of product specification.



1 General Description

1.1 Applicant

Lenovo(Shanghai) Electronics Technology Co., Ltd.

Section 304-305, Building No. 4, # 222, Meiyue Road, China (Shanghai) Pilot Free Trade Zone

1.2 Manufacturer

Lenovo PC HK Limited

23/F, Lincoln House, Taikoo Place 979 King's Road, Quarry Bay, Hong Kong, P.R.China

1.3 Product Feature of Equipment Under Test

Product Feature	
Equipment	Portable Tablet Computer
Brand Name	Lenovo
Model Name	Lenovo TB-8506X
FCC ID	O57TB8506X
EUT supports Radios application	GSM/WCDMA/LTE, WLAN 2.4GHz 802.11b/g/n HT20/HT40 WLAN 5GHz 802.11a/n HT20/HT40 WLAN 5GHz 802.11ac VHT20/VHT40/VHT80 Bluetooth BR/EDR/LE FM Receiver and GNSS
IMEI Code	Conducted: 868869050009165 Radiation: 868869050005346
HW Version	Lenovo TB-8506X
SW Version	Lenovo TB-8506X_RF01_210305
EUT Stage	Identical Prototype



1.4 Product Specification of Equipment Under Test

Standards-related Product Specification	
Tx Frequency	LTE Band 2 : 1850 MHz ~ 1910 MHz LTE Band 4 : 1710 MHz ~ 1755 MHz LTE Band 5 : 824 MHz ~ 849 MHz LTE Band 7 : 2500 MHz ~ 2570 MHz LTE Band 26 : 824 MHz ~ 849 MHz LTE Band 38 : 2570 MHz ~ 2620 MHz LTE Band 41 : 2496 MHz ~ 2690 MHz
Rx Frequency	LTE Band 2 : 1930 MHz ~ 1990 MHz LTE Band 4 : 2110 MHz ~ 2155 MHz LTE Band 5 : 869 MHz ~ 894 MHz LTE Band 7 : 2620 MHz ~ 2690 MHz LTE Band 26 : 869 MHz ~ 894 MHz LTE Band 38 : 2570 MHz ~ 2620 MHz LTE Band 41 : 2496 MHz ~ 2690 MHz
Bandwidth	LTE Band 2 : 1.4MHz / 3MHz / 5MHz / 10MHz / 15MHz / 20MHz LTE Band 4 : 1.4MHz / 3MHz / 5MHz / 10MHz / 15MHz / 20MHz LTE Band 5 : 1.4MHz / 3MHz / 5MHz / 10MHz LTE Band 7 : 5MHz / 10MHz / 15MHz / 20MHz LTE Band 26 : 1.4MHz / 3MHz / 5MHz / 10MHz / 15MHz LTE Band 38 : 5MHz / 10MHz / 15MHz / 20MHz LTE Band 41 : 5MHz / 10MHz / 15MHz / 20MHz
Maximum Output Power to Antenna	LTE Band 2 : 23.16 dBm LTE Band 4 : 23.10 dBm LTE Band 5 : 23.36 dBm LTE Band 7 : 23.18 dBm LTE Band 26 : 23.38 dBm LTE Band 38 : 22.94 dBm LTE Band 41 : 23.04 dBm
Antenna Gain	LTE Band 2 : -2.51 dBi LTE Band 4 : 0.36 dBi LTE Band 5 : -1.98 dBi LTE Band 7 : 0.24 dBi LTE Band 26 : -1.98 dBi LTE Band 38 : 0.25 dBi LTE Band 41 : 0.25 dBi
Type of Modulation	QPSK / 16QAM

1.5 Modification of EUT

No modifications are made to the EUT during all test items.



1.6 Maximum ERP/EIRP, Frequency Tolerance, and Emission Designator

LTE Band 2		QPSK			16QAM		
BW (MHz)	Frequency Range (MHz)	Emission Designator (99%OBW)	Frequency Tolerance (ppm)	Maximum EIRP(W)	Emission Designator (99%OBW)	Frequency Tolerance (ppm)	Maximum EIRP(W)
20	1860.0 ~ 1900.0	18M3G7D	0.0026	0.1161	18M2W7D	-	0.0953
LTE Band 4		QPSK			16QAM		
BW (MHz)	Frequency Range (MHz)	Emission Designator (99%OBW)	Frequency Tolerance (ppm)	Maximum EIRP(W)	Emission Designator (99%OBW)	Frequency Tolerance (ppm)	Maximum EIRP(W)
20	1720.0 ~ 1745.0	17M9G7D	0.0031	0.2218	17M9W7D	-	0.1897
LTE Band 5		QPSK			16QAM		
BW (MHz)	Frequency Range (MHz)	Emission Designator (99%OBW)	Frequency Tolerance (ppm)	Maximum ERP(W)	Emission Designator (99%OBW)	Frequency Tolerance (ppm)	Maximum ERP(W)
10	829.0 ~ 844.0	8M99G7D	0.0073	0.0838	8M97W7D	-	0.0692
LTE Band 26		QPSK			16QAM		
BW (MHz)	Frequency Range (MHz)	Emission Designator (99%OBW)	Frequency Tolerance (ppm)	Maximum ERP(W)	Emission Designator (99%OBW)	Frequency Tolerance (ppm)	Maximum ERP(W)
15	831.5 ~ 841.5	13M5G7D	0.0073	0.0841	13M4W7D	-	0.0678
CH26765	821.5	13M4G7D	-	0.0800	13M4W7D	-	0.0678
LTE Band 7		QPSK			16QAM		
BW (MHz)	Frequency Range (MHz)	Emission Designator (99%OBW)	Frequency Tolerance (ppm)	Maximum EIRP(W)	Emission Designator (99%OBW)	Frequency Tolerance (ppm)	Maximum EIRP(W)
20	2510.0 ~ 2560.0	18M1G7D	0.0016	0.2198	18M3W7D	-	0.1648
LTE Band 38		QPSK			16QAM		
BW (MHz)	Frequency Range (MHz)	Emission Designator (99%OBW)	Frequency Tolerance (ppm)	Maximum EIRP(W)	Emission Designator (99%OBW)	Frequency Tolerance (ppm)	Maximum EIRP(W)
20	2580.0 ~ 2610.0	17M9G7D	0.0012	0.2084	17M9W7D	-	0.1633
LTE Band 41		QPSK			16QAM		
BW (MHz)	Frequency Range (MHz)	Emission Designator (99%OBW)	Frequency Tolerance (ppm)	Maximum EIRP(W)	Emission Designator (99%OBW)	Frequency Tolerance (ppm)	Maximum EIRP(W)
20	2506.0 ~ 2680.0	17M9G7D	0.0012	0.2133	17M9W7D	-	0.1762

Note:

1. LTE Band 26 overlaps the entire frequency range of LTE Band 5. Therefore, the test results provided in this report covers Band 26 as well as Band 5.
2. LTE Band 41 overlaps the entire frequency range of LTE Band 38. Therefore, the test results provided in



this report covers Band 41 as well as Band 38.

- 3. Based on engineering evaluation, only the maximum bandwidth and the worst modulation test results are shown in the report.

1.7 Testing Location

Sporton International (Kunshan) Inc. is accredited to ISO/IEC 17025:2017 by American Association for Laboratory Accreditation with Certificate Number 5145.02.

Test Firm	Sporton International (Kunshan) Inc.		
Test Site Location	No. 1098, Pengxi North Road, Kunshan Economic Development Zone Jiangsu Province 215300 People's Republic of China TEL : +86-512-57900158 FAX : +86-512-57900958		
Test Site No.	Sporton Site No.	FCC Designation No.	FCC Test Firm Registration No.
	03CH04-KS TH01-KS	CN1257	314309

1.8 Test Software

Item	Site	Manufacturer	Name	Version
1.	03CH04-KS	AUDIX	E3	6.2009-8-24a

1.9 Applicable Standards

According to the specifications of the manufacturer, the EUT must comply with the requirements of the following standards:

- 47 CFR Part 2, 22(H), 24(E), 27(L), 27(M),
- ANSI C63.26-2015
- FCC KDB 971168 D01 Power Meas License Digital Systems v03r01
- FCC KDB 412172 D01 Determining ERP and EIRP v01r01

Remark:

1. All test items were verified and recorded according to the standards and without any deviation during the test.
2. This EUT has also been tested and complied with the requirements of FCC Part 15, Subpart B, recorded in a separate test report.



2 Test Configuration of Equipment Under Test

2.1 Test Mode

Antenna port conducted and radiated test items listed below are performed according to KDB 971168 D01 Power Meas License Digital Systems v03r01 with maximum output power.

Radiated measurements are performed by rotating the EUT in three different orthogonal test planes to find the maximum emission.

Test Items	Band	Bandwidth (MHz)						Modulation			RB #			Test Channel		
		1.4	3	5	10	15	20	QPSK	16QAM	64QAM	1	Half	Full	L	M	H
Max. Output Power	2	v	v	v	v	v	v	v	v		v	v	v	v	v	v
	4	v	v	v	v	v	v	v	v		v	v	v	v	v	v
	5	v	v	v	v	-	-	v	v		v	v	v	v	v	v
	7	-	-	v	v	v	v	v	v		v	v	v	v	v	v
	26	v	v	v	v	v	-	v	v		v	v	v	v	v	v
	38	-	-	v	v	v	v	v	v		v	v	v	v	v	v
	41	-	-	v	v	v	v	v	v		v	v	v	v	v	v
Peak-to-Average Ratio	2						v	v	v				v		v	
	4						v	v	v				v		v	
	7	-	-				v	v	v				v		v	
	26					v	-	v	v				v		v	
	41	-	-				v	v	v				v		v	
26dB and 99% Bandwidth	2						v	v	v				v		v	
	4						v	v	v				v		v	
	7	-	-				v	v	v				v		v	
	26					v	-	v	v				v		v	
	41	-	-				v	v	v				v		v	
Conducted Band Edge	2	v	v	v	v	v	v	v	v		v		v	v		v
	4	v	v	v	v	v	v	v	v		v		v	v		v
	7	-	-	v	v	v	v	v	v		v		v	v		v
	26	v	v	v	v	v	-	v	v		v		v	v		v
	41	-	-	v	v	v	v	v	v		v		v	v		v



Test Items	Band	Bandwidth (MHz)						Modulation			RB #			Test Channel		
		1.4	3	5	10	15	20	QPSK	16QAM	64QAM	1	Half	Full	L	M	H
Conducted Spurious Emission	2	v	v	v	v	v	v	v			v			v	v	v
	4	v	v	v	v	v	v	v			v			v	v	v
	7	-	-	v	v	v	v	v			v			v	v	v
	26	v	v	v	v	v	-	v			v			v	v	v
	41	-	-	v	v	v	v	v			v			v	v	v
Frequency Stability	2						v	v					v		v	
	4						v	v					v		v	
	7	-	-				v	v					v		v	
	26					v	-	v					v		v	
	41	-	-				v	v					v		v	
E.R.P / E.I.R.P	2	v	v	v	v	v	v	v	v		v			v	v	v
	4	v	v	v	v	v	v	v	v		v			v	v	v
	7	-	-	v	v	v	v	v	v		v			v	v	v
	26	v	v	v	v	v	-	v	v		v			v	v	v
	41	-	-	v	v	v	v	v	v		v			v	v	v
Radiated Spurious Emission	2	Worst Case												v		
	4	Worst Case												v		
	7	Worst Case												v		
	26	Worst Case												v		
	41	Worst Case												v		
Note	<ol style="list-style-type: none"> The mark "v" means that this configuration is chosen for testing The mark "-" means that this bandwidth is not supported. The device is investigated from 30MHz to 10 times of fundamental signal for radiated spurious emission test under different RB size/offset and modulations in exploratory test. Subsequently, only the worst case emissions are reported. All test items are based on engineering evaluation. 															

2.2 Connection Diagram of Test System

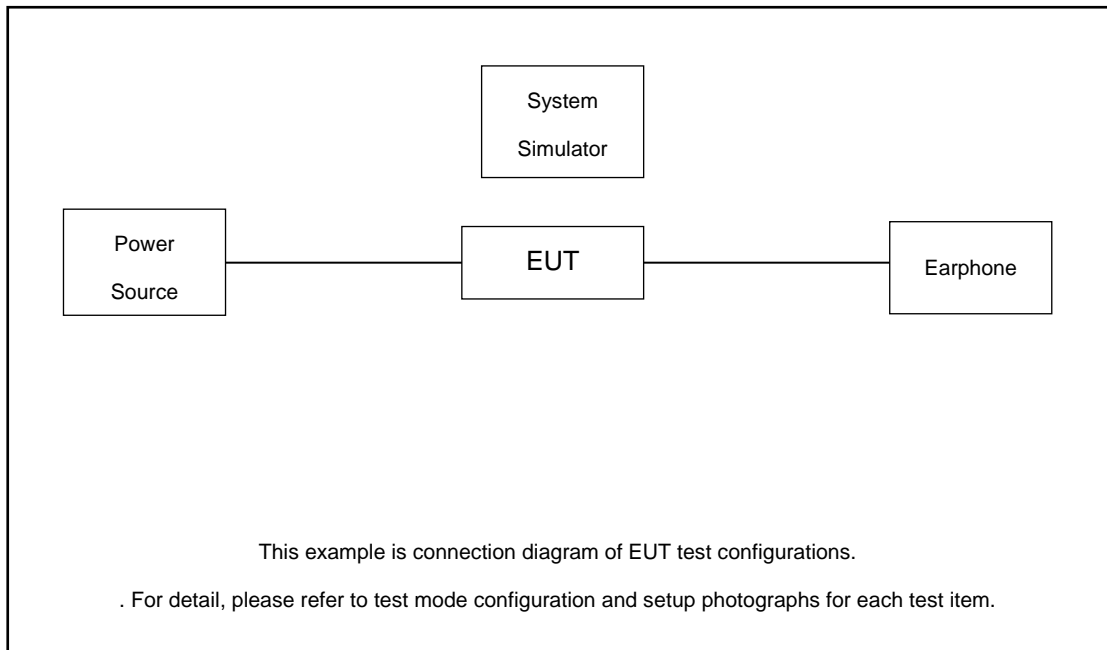

2.3 Support Unit used in test configuration and system

Item	Equipment	Trade Name	Model No.	FCC ID	Data Cable	Power Cord
1.	DC Power Supply	GW INSTEK	GPS-3030D	N/A	N/A	Unshielded, 1.8 m
2.	LTE Base Station	Anritsu	MT8820C	N/A	N/A	Unshielded, 1.8 m
3.	Earphone	Lenovo	SH100	N/A	Unshielded,1.2m	N/A

2.4 Measurement Results Explanation Example

For all conducted test items:

The offset level is set in the spectrum analyzer to compensate the RF cable loss between EUT conducted output port and spectrum analyzer. With the offset compensation, the spectrum analyzer reading level is exactly the EUT RF output level.

The spectrum analyzer offset is derived from RF cable loss.

Offset = RF cable loss.

Following shows an offset computation example with cable loss 5.6 dB.

Example :

$$\begin{aligned} \text{Offset(dB)} &= \text{RF cable loss(dB)} \\ &= 5.6 \text{ (dB)} \end{aligned}$$



2.5 Frequency List of Low/Middle/High Channels

LTE Band 2 Channel and Frequency List				
BW [MHz]	Channel/Frequency(MHz)	Lowest	Middle	Highest
20	Channel	18700	18900	19100
	Frequency	1860	1880	1900
15	Channel	18675	18900	19125
	Frequency	1857.5	1880	1902.5
10	Channel	18650	18900	19150
	Frequency	1855	1880	1905
5	Channel	18625	18900	19175
	Frequency	1852.5	1880	1907.5
3	Channel	18615	18900	19185
	Frequency	1851.5	1880	1908.5
1.4	Channel	18607	18900	19193
	Frequency	1850.7	1880	1909.3

LTE Band 4 Channel and Frequency List				
BW [MHz]	Channel/Frequency(MHz)	Lowest	Middle	Highest
20	Channel	20050	20175	20300
	Frequency	1720	1732.5	1745
15	Channel	20025	20175	20325
	Frequency	1717.5	1732.5	1747.5
10	Channel	20000	20175	20350
	Frequency	1715	1732.5	1750
5	Channel	19975	20175	20375
	Frequency	1712.5	1732.5	1752.5
3	Channel	19965	20175	20385
	Frequency	1711.5	1732.5	1753.5
1.4	Channel	19957	20175	20393
	Frequency	1710.7	1732.5	1754.3



LTE Band 5 Channel and Frequency List				
BW [MHz]	Channel/Frequency(MHz)	Lowest	Middle	Highest
10	Channel	20450	20525	20600
	Frequency	829	836.5	844
5	Channel	20425	20525	20625
	Frequency	826.5	836.5	846.5
3	Channel	20415	20525	20635
	Frequency	825.5	836.5	847.5
1.4	Channel	20407	20525	20643
	Frequency	824.7	836.5	848.3

LTE Band 7 Channel and Frequency List				
BW [MHz]	Channel/Frequency(MHz)	Lowest	Middle	Highest
20	Channel	20850	21100	21350
	Frequency	2510	2535	2560
15	Channel	20825	21100	21375
	Frequency	2507.5	2535	2562.5
10	Channel	20800	21100	21400
	Frequency	2505	2535	2565
5	Channel	20775	21100	21425
	Frequency	2502.5	2535	2567.5



LTE Band 26 Channel and Frequency List				
BW [MHz]	Channel/Frequency(MHz)	Lowest	Middle	Highest
15	Channel	26865	26915	26965
	Frequency	831.5	836.5	841.5
10	Channel	26840	26915	26990
	Frequency	829	836.5	844
5	Channel	26815	26915	27015
	Frequency	826.5	836.5	846.5
3	Channel	26805	26915	27025
	Frequency	825.5	836.5	847.5
1.4	Channel	26797	26915	27033
	Frequency	824.7	836.5	848.3

LTE Band 38 Channel and Frequency List				
BW [MHz]	Channel/Frequency(MHz)	Lowest	Middle	Highest
20	Channel	37850	38000	38150
	Frequency	2580	2595	2610
15	Channel	37825	38000	38175
	Frequency	2577.5	2595	2612.5
10	Channel	37800	38000	38200
	Frequency	2575	2595	2615
5	Channel	37775	38000	38225
	Frequency	2572.5	2595	2617.5

LTE Band 41 Channel and Frequency List				
BW [MHz]	Channel/Frequency(MHz)	Lowest	Middle	Highest
20	Channel	39750	40620	41490
	Frequency	2506	2593	2680
15	Channel	39725	40620	41515
	Frequency	2503.5	2593	2682.5
10	Channel	39700	40620	41540
	Frequency	2501	2593	2685
5	Channel	39675	40620	41565
	Frequency	2498.5	2593	2687.5

3 Conducted Test Items

3.1 Measuring Instruments

See list of measuring instruments of this test report.

3.2 Test Setup

3.2.1 Conducted Output Power



3.2.2 Peak-to-Average Ratio, Occupied Bandwidth ,Conducted Band-Edge and Conducted Spurious Emission



3.2.3 Frequency Stability

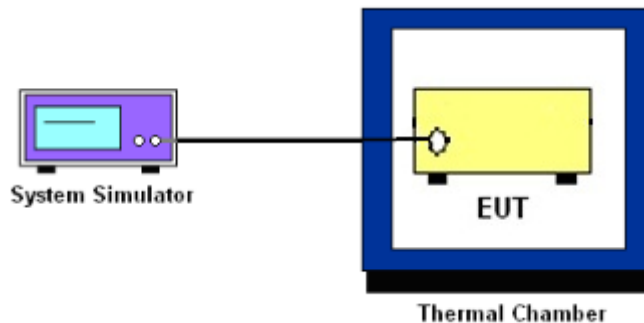

3.3 Test Result of Conducted Test

Please refer to Appendix A.



3.4 Conducted Output Power and ERP/EIRP

3.4.1 Description of the Conducted Output Power Measurement and ERP/EIRP Measurement

A system simulator was used to establish communication with the EUT. Its parameters were set to force the EUT transmitting at maximum output power. The measured power in the radio frequency on the transmitter output terminals shall be reported.

The ERP of mobile transmitters must not exceed 7 Watts for LTE Band 5 and Band 26.

The EIRP of mobile transmitters must not exceed 2 Watts for LTE Band 2 and Band 7 and Band 38 and Band 41.

The EIRP of mobile transmitters must not exceed 1 Watts for LTE Band 4.

According to KDB 412172 D01 Power Approach,

$EIRP = P_T + G_T - L_C$, $ERP = EIRP - 2.15$, where

P_T = transmitter output power in dBm

G_T = gain of the transmitting antenna in dBi

L_C = signal attenuation in the connecting cable between the transmitter and antenna in dB

3.4.2 Test Procedures

1. The testing follows ANSI C63.26 Section 5.2
2. The transmitter output port was connected to the system simulator.
3. Set EUT at maximum power through the system simulator.
4. Select lowest, middle, and highest channels for each band and different modulation.
5. Measure and record the power level from the system simulator.



3.5 Peak-to-Average Ratio

3.5.1 Description of the PAR Measurement

Power Complementary Cumulative Distribution Function (CCDF) curves provide a means for characterizing the power peaks of a digitally modulated signal on a statistical basis. A CCDF curve depicts the probability of the peak signal amplitude exceeding the average power level. Most contemporary measurement instrumentation include the capability to produce CCDF curves for an input signal provided that the instrument's resolution bandwidth can be set wide enough to accommodate the entire input signal bandwidth. In measuring transmissions in this band using an average power technique, the peak-to-average ratio (PAR) of the transmission may not exceed 13 dB.

3.5.2 Test Procedures

1. The testing follows ANSI C63.26 Section 5.2.3.4 (CCDF).
2. The EUT was connected to spectrum and system simulator via a power divider.
3. Set the CCDF (Complementary Cumulative Distribution Function) option in spectrum analyzer.
4. The highest RF powers were measured and recorded the maximum PAPR level associated with a probability of 0.1 %.
5. Record the deviation as Peak to Average Ratio.



3.6 Occupied Bandwidth

3.6.1 Description of Occupied Bandwidth Measurement

The occupied bandwidth is the width of a frequency band such that, below the lower and above the upper frequency limits, the mean powers emitted are each equal to a specified percentage 0.5% of the total mean transmitted power.

The 26 dB emission bandwidth is defined as the frequency range between two points, one above and one below the carrier frequency, at which the spectral density of the emission is attenuated 26 dB below the maximum in-band spectral density of the modulated signal. Spectral density (power per unit bandwidth) is to be measured with a detector of resolution bandwidth equal to approximately 1.0% of the emission bandwidth.

3.6.2 Test Procedures

1. The testing follows ANSI C63.26 Section 5.4
2. The EUT was connected to spectrum analyzer and system simulator via a power divider.
3. The spectrum analyzer center frequency is set to the nominal EUT channel center frequency. The span range for the spectrum analyzer shall be between two and five times the anticipated OBW.
4. The nominal resolution bandwidth (RBW) shall be in the range of 1 to 5 % of the anticipated OBW, and the VBW shall be at least 3 times the RBW.
5. Set the detection mode to peak, and the trace mode to max hold.
6. Determine the reference value: Set the EUT to transmit a modulated signal. Allow the trace to stabilize. Set the spectrum analyzer marker to the highest level of the displayed trace.
(this is the reference value)
7. Determine the “-26 dB down amplitude” as equal to (Reference Value – X).
8. Place two markers, one at the lowest and the other at the highest frequency of the envelope of the spectral display such that each marker is at or slightly below the “-X dB down amplitude” determined in step 6. If a marker is below this “-X dB down amplitude” value it shall be placed as close as possible to this value. The OBW is the positive frequency difference between the two markers.
9. Use the 99 % power bandwidth function of the spectrum analyzer and report the measured bandwidth.



3.7 Conducted Band Edge

3.7.1 Description of Conducted Band Edge Measurement

22.917(a)

For operations in the 824 – 849 MHz band, the FCC limit is $43 + 10\log_{10}(P[\text{Watts}])$ dB below the transmitter power $P(\text{Watts})$ in a 100kHz bandwidth. However, in the 1MHz bands immediately outside and adjacent to the licensee's frequency block, a resolution bandwidth of at least one percent of the emission bandwidth of the fundamental emission of the transmitter may be employed.

24.238 (a)

For operations in the 1850-1910 and 1930-1990 MHz band, the FCC limit is $43 + 10\log_{10}(P[\text{Watts}])$ dB below the transmitter power $P(\text{Watts})$ in a 1MHz bandwidth. However, in the 1 MHz bands immediately outside and adjacent to the frequency block a resolution bandwidth of at least one percent of the emission bandwidth of the fundamental emission of the transmitter may be employed.

27.53 (h)

For operations in the 1710 – 1755 MHz band, the FCC limit is $43 + 10\log_{10}(P[\text{Watts}])$ dB below the transmitter power $P(\text{Watts})$ in a 1 MHz bandwidth. However, in the 1MHz bands immediately outside and adjacent to the licensee's frequency block, a resolution bandwidth of at least one percent of the emission bandwidth of the fundamental emission of the transmitter may be employed.

27.53(m)(4)

For mobile digital stations, the attenuation factor shall be not less than $40 + 10 \log (P)$ dB on all frequencies between the channel edge and 5 megahertz from the channel edge, $43 + 10 \log (P)$ dB on all frequencies between 5 megahertz and X megahertz from the channel edge, and $55 + 10 \log (P)$ dB on all frequencies more than X megahertz from the channel edge, where X is the greater of 6 megahertz or the actual emission bandwidth as defined in paragraph (m)(6) of this section. In addition, the attenuation factor shall not be less that $43 + 10 \log (P)$ dB on all frequencies between 2490.5 MHz and 2496 MHz and $55 + 10 \log (P)$ dB at or below 2490.5 MHz. Mobile Satellite Service licensees operating on frequencies below 2495 MHz may also submit a documented interference complaint against BRS licensees operating on channel BRS Channel 1 on the same terms and conditions as adjacent channel BRS or EBS licensees.



3.7.2 Test Procedures

1. The testing follows ANSI C63.26 section 5.7
2. The EUT was connected to spectrum analyzer and system simulator via a power divider.
3. The band edges of low and high channels for the highest RF powers were measured.
4. Set RBW \geq 1% EBW in the 1MHz band immediately outside and adjacent to the band edge.
5. Beyond the 1 MHz band from the band edge, RBW=1MHz was used or a narrower RBW was used and the measured power was integrated over the full required measurement bandwidth of 1 MHz.
6. Set spectrum analyzer with RMS detector.
7. The RF fundamental frequency should be excluded against the limit line in the operating frequency band.
8. Checked that all the results comply with the emission limit line.

Example:

The limit line is derived from $43 + 10\log(P)$ dB below the transmitter power P(Watts)

$$= P(W) - [43 + 10\log(P)] \text{ (dB)}$$

$$= [30 + 10\log(P)] \text{ (dBm)} - [43 + 10\log(P)] \text{ (dB)} = -13\text{dBm}.$$

9. For LTE Band 7, 38, 41, the other 40 dB, and 55 dB have additionally applied same calculation above.



3.8 Conducted Spurious Emission

3.8.1 Description of Conducted Spurious Emission Measurement

The power of any emission outside of the authorized operating frequency ranges must be lower than the transmitter power (P) by a factor of at least $43 + 10 \log (P)$ dB.

For Band 7,38,41:

The power of any emission outside of the authorized operating frequency ranges must be lower than the transmitter power (P) by a factor of at least $55 + 10 \log (P)$ dB.

It is measured by means of a calibrated spectrum analyzer and scanned from 30 MHz up to a frequency including its 10th harmonic.

3.8.2 Test Procedures

1. The testing follows ANSI C63.26 section 5.7
2. The EUT was connected to spectrum analyzer and system simulator via a power divider.
3. The RF output of EUT was connected to the spectrum analyzer by RF cable and attenuator. The path loss was compensated to the results for each measurement.
4. The middle channel for the highest RF power within the transmitting frequency was measured.
5. The conducted spurious emission for the whole frequency range was taken.
6. Make the measurement with the spectrum analyzer's RBW = 1MHz, VBW = 3MHz.
7. Set spectrum analyzer with RMS detector.
8. Taking the record of maximum spurious emission.
9. The RF fundamental frequency should be excluded against the limit line in the operating frequency band.
10. The limit line is derived from $43 + 10\log(P)$ dB below the transmitter power P(Watts)
 $= P(W) - [43 + 10\log(P)]$ (dB)
 $= [30 + 10\log(P)]$ (dBm) - $[43 + 10\log(P)]$ (dB)
 $= -13$ dBm.
11. For Band 7, 38, 41
The limit line is derived from $55 + 10\log(P)$ dB below the transmitter power P(Watts)
 $= P(W) - [55 + 10\log(P)]$ (dB)
 $= [30 + 10\log(P)]$ (dBm) - $[55 + 10\log(P)]$ (dB)
 $= -25$ dBm.



3.9 Frequency Stability

3.9.1 Description of Frequency Stability Measurement

The frequency stability shall be measured by variation of ambient temperature and variation of primary supply voltage to ensure that the fundamental emission stays within the authorized frequency block. The frequency stability of the transmitter shall be maintained within $\pm 0.00025\%$ ($\pm 2.5\text{ppm}$) of the center frequency.

3.9.2 Test Procedures for Temperature Variation

1. The testing follows ANSI C63.26 section 5.6.4
2. The EUT was set up in the thermal chamber and connected with the system simulator.
3. With power OFF, the temperature was decreased to -30°C and the EUT was stabilized before testing. Power was applied and the maximum change in frequency was recorded within one minute.
4. With power OFF, the temperature was raised in 10°C step up to 50°C . The EUT was stabilized at each step for at least half an hour. Power was applied and the maximum frequency change was recorded within one minute.

3.9.3 Test Procedures for Voltage Variation

1. The testing follows ANSI C63.26 section 5.6.5
2. The EUT was placed in a temperature chamber at $20\pm 5^{\circ}\text{C}$ and connected with the system simulator.
3. The power supply voltage to the EUT was varied from 85% to 115% of the nominal value for other than hand carried battery equipment.
4. For hand carried, battery powered equipment, reduce the primary ac or dc supply voltage to the battery operating end point, which shall be specified by the manufacturer.
5. The variation in frequency was measured for the worst case.

4 Radiated Test Items

4.1 Measuring Instruments

See list of measuring instruments of this test report.

4.2 Test Setup

4.2.1 For radiated test from 30MHz to 1GHz

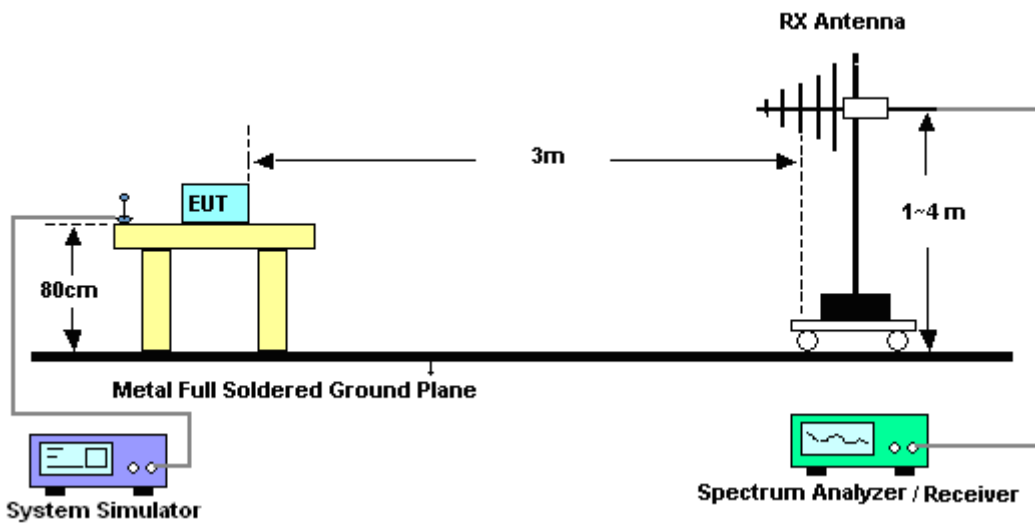

4.2.2 For radiated test above 1GHz

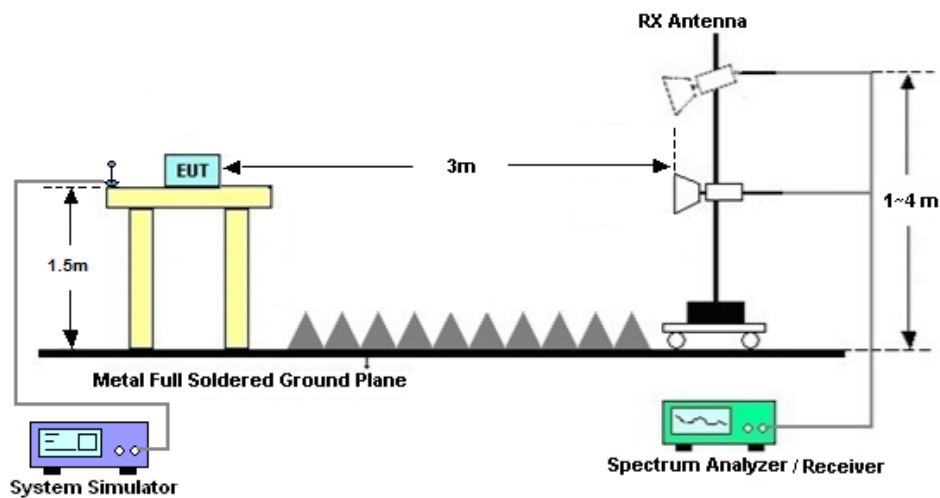

4.3 Test Result of Radiated Test

Please refer to Appendix B.



4.4 Radiated Spurious Emission

4.4.1 Description of Radiated Spurious Emission

The radiated spurious emission was measured by substitution method according to ANSI C63.26. The power of any emission outside of the authorized operating frequency ranges must be attenuated below the transmitter power (P) by a factor of at least $43 + 10 \log (P)$ dB.

For Band 7, 38, 41

The power of any emission outside of the authorized operating frequency ranges must be attenuated below the transmitter power (P) by a factor of at least $55 + 10 \log (P)$ dB.

The spectrum is scanned from 30 MHz up to a frequency including its 10th harmonic.

4.4.2 Test Procedures

1. The testing follows ANSI C63.26 Section 5.5
2. The EUT was placed on a turntable with 0.8 meter height for frequency below 1GHz and 1.5 meter height for frequency above 1GHz respectively above ground.
3. The EUT was set 3 meters from the receiving antenna mounted on the antenna tower.
4. The table was rotated 360 degrees to determine the position of the highest spurious emission.
5. The height of the receiving antenna is varied between 1m to 4m to search the maximum spurious emission for both horizontal and vertical polarizations.
6. During the measurement, the system simulator parameters were set to force the EUT transmitting at maximum output power.
7. Make the measurement with the spectrum analyzer's RBW = 1MHz, VBW = 3MHz, taking the record of maximum spurious emission.
8. A horn antenna was substituted in place of the EUT and was driven by a signal generator.
9. Tune the output power of signal generator to the same emission level with EUT maximum spurious emission.
10. $EIRP (dBm) = S.G. Power - Tx Cable Loss + Tx Antenna Gain$
11. $ERP (dBm) = EIRP - 2.15$
12. The RF fundamental frequency should be excluded against the limit line in the operating frequency band.

The limit line is derived from $43 + 10\log(P)$ dB below the transmitter power P(Watts)
 $= P(W) - [43 + 10\log(P)] (dB)$
 $= [30 + 10\log(P)] (dBm) - [43 + 10\log(P)] (dB)$
 $= -13dBm.$

13. For Band 7, 38, 41:

The limit line is derived from $55 + 10\log(P)$ dB below the transmitter power P(Watts)



5 List of Measuring Equipment

Instrument	Manufacturer	Model No.	Serial No.	Characteristics	Calibration Date	Test Date	Due Date	Remark
Spectrum Analyzer	R&S	FSV40	101040	10Hz~40GHz	Nov. 01, 2020	Mar. 03, 2021~ Mar. 10, 2021	Oct. 31, 2021	Conducted (TH01-KS)
Temperature & humidity chamber	Hongzhan	LP-150U	H2014011440	-40~+150°C 20%~95%RH	Jul. 03, 2020	Mar. 03, 2021~ Mar. 10, 2021	Jul. 02, 2021	Conducted (TH01-KS)
EXA Spectrum Analyzer	Keysight	N9010A	MY55150244	10Hz-44G,MAX 30dB	Apr. 15, 2020	Mar. 16, 2021	Apr. 14, 2021	Radiation (03CH04-KS)
Bilog Antenna	TeseQ	CBL6111D	49922	30MHz-1GHz	Jun. 08, 2020	Mar. 16, 2021	Jun. 07, 2021	Radiation (03CH04-KS)
Horn Antenna	Schwarzbeck	BBHA9120D	1356	1GHz~18GHz	Apr. 20, 2020	Mar. 16, 2021	Apr. 19, 2021	Radiation (03CH04-KS)
SHF-EHF Horn	Com-power	AH-840	101115	18GHz~40GHz	Jan. 06, 2021	Mar. 16, 2021	Jan. 05, 2022	Radiation (03CH04-KS)
Amplifier	SONOMA	310N	187289	9KHz-1GHz	Jan. 06, 2021	Mar. 16, 2021	Jan. 05, 2022	Radiation (03CH04-KS)
Amplifier	MITEQ	EM18G40G GA	060728	18~40GHz	Jan. 07, 2021	Mar. 16, 2021	Jan. 06, 2022	Radiation (03CH04-KS)
high gain Amplifier	MITEQ	AMF-7D-00 101800-30-1 0P	2025788	1Ghz-18Ghz	Jan. 06, 2021	Mar. 16, 2021	Jan. 05, 2022	Radiation (03CH04-KS)
Amplifier	Keysight	83017A	MY57280106	500MHz~26.5GHz	Oct. 14, 2020	Mar. 16, 2021	Oct. 13, 2021	Radiation (03CH04-KS)
AC Power Source	Chroma	61601	F104090004	N/A	NCR	Mar. 16, 2021	NCR	Radiation (03CH04-KS)
Turn Table	ChamPro	EM 1000-T	060762-T	0~360 degree	NCR	Mar. 16, 2021	NCR	Radiation (03CH04-KS)
Antenna Mast	ChamPro	EM 1000-A	060762-A	1 m~4 m	NCR	Mar. 16, 2021	NCR	Radiation (03CH04-KS)

NCR: No Calibration Required



6 Uncertainty of Evaluation

The measurement uncertainties shown below were calculated in accordance with the requirements of ANSI 63.26-2015. All the measurement uncertainty value were shown with a coverage K=2 to indicate 95% level of confidence. The measurement data show herein meets or exceeds the CISPR measurement uncertainty values specified in CISPR 16-4-2 and can be compared directly to specified limit to determine compliance.

Uncertainty of Radiated Emission Measurement (30 MHz ~ 1000 MHz)

Measuring Uncertainty for a Level of Confidence of 95% (U = 2Uc(y))	3.3dB
---	-------

Uncertainty of Radiated Emission Measurement (1 GHz ~ 40 GHz)

Measuring Uncertainty for a Level of Confidence of 95% (U = 2Uc(y))	2.8dB
---	-------



Appendix A. Test Results of Conducted Test

Conducted Output Power(Average power) and ERP/EIRP

LTE Band 2									
BW [MHz]	Modulation	RB Size	RB Offset	Power Low Ch. / Freq.	Power Middle Ch. / Freq.	Power High Ch. / Freq.	EIRP		
Channel				18700	18900	19100			
Frequency (MHz)				1860	1880	1900	L	M	H
20	QPSK	1	0	23.06	23.16	22.96	0.1135	0.1161	0.1109
20	QPSK	1	49	23.07	22.95	23.12	0.1138	0.1107	0.1151
20	QPSK	1	99	22.75	22.89	22.87	0.1057	0.1091	0.1086
20	QPSK	50	0	22.24	22.26	22.07	0.0940	0.0944	0.0904
20	QPSK	50	24	22.25	22.15	22.16	0.0942	0.0920	0.0923
20	QPSK	50	50	22.19	22.07	22.05	0.0929	0.0904	0.0899
20	QPSK	100	0	22.13	22.18	22.10	0.0916	0.0927	0.0910
20	16QAM	1	0	22.30	22.09	22.18	0.0953	0.0908	0.0927
Channel				18675	18900	19125	EIRP		
Frequency (MHz)				1857.5	1880	1902.5	L	M	H
15	QPSK	1	0	23.02	23.07	22.86	0.1125	0.1138	0.1084
15	16QAM	1	0	22.28	21.95	22.08	0.0948	0.0879	0.0906
Channel				18650	18900	19150	EIRP		
Frequency (MHz)				1855	1880	1905	L	M	H
10	QPSK	1	0	22.94	22.95	23.13	0.1104	0.1107	0.1153
10	16QAM	1	0	22.21	22.01	22.10	0.0933	0.0891	0.0910
Channel				18625	18900	19175	EIRP		
Frequency (MHz)				1852.5	1880	1907.5	L	M	H
5	QPSK	1	0	22.98	22.89	23.13	0.1114	0.1091	0.1153
5	16QAM	1	0	22.17	22.04	22.16	0.0925	0.0897	0.0923
Channel				18615	18900	19185	EIRP		
Frequency (MHz)				1851.5	1880	1908.5	L	M	H
3	QPSK	1	0	22.95	23.01	22.86	0.1107	0.1122	0.1084
3	16QAM	1	0	22.23	22.01	22.06	0.0938	0.0891	0.0902
Channel				18607	18900	19193	EIRP		
Frequency (MHz)				1850.7	1880	1909.3	L	M	H
1.4	QPSK	1	0	22.94	22.99	22.76	0.1104	0.1117	0.1059
1.4	16QAM	1	0	21.99	21.89	22.11	0.0887	0.0867	0.0912



LTE Band 4									
BW [MHz]	Modulation	RB Size	RB Offset	Power Low Ch. / Freq.	Power Middle Ch. / Freq.	Power High Ch. / Freq.	EIRP		
Channel				20050	20175	20300			
Frequency (MHz)				1720	1732.5	1745	L	M	H
20	QPSK	1	0	22.96	23.10	22.94	0.2148	0.2218	0.2138
20	QPSK	1	49	23.07	23.01	23.00	0.2203	0.2173	0.2168
20	QPSK	1	99	22.79	22.92	22.92	0.2065	0.2128	0.2128
20	QPSK	50	0	22.16	22.38	22.37	0.1786	0.1879	0.1875
20	QPSK	50	24	22.24	22.33	22.32	0.1820	0.1858	0.1854
20	QPSK	50	50	22.20	22.23	22.18	0.1803	0.1816	0.1795
20	QPSK	100	0	22.22	22.28	22.23	0.1811	0.1837	0.1816
20	16QAM	1	0	22.10	22.26	22.42	0.1762	0.1828	0.1897
Channel				20025	20175	20325	EIRP		
Frequency (MHz)				1717.5	1732.5	1747.5	L	M	H
15	QPSK	1	0	23.00	22.93	22.93	0.2168	0.2133	0.2133
15	16QAM	1	0	21.98	22.17	22.34	0.1714	0.1791	0.1862
Channel				20000	20175	20350	EIRP		
Frequency (MHz)				1715	1732.5	1750	L	M	H
10	QPSK	1	0	23.04	22.95	22.85	0.2188	0.2143	0.2094
10	16QAM	1	0	22.11	22.09	22.42	0.1766	0.1758	0.1897
Channel				19975	20175	20375	EIRP		
Frequency (MHz)				1712.5	1732.5	1752.5	L	M	H
5	QPSK	1	0	22.84	23.04	22.78	0.2089	0.2188	0.2061
5	16QAM	1	0	21.95	22.22	22.28	0.1702	0.1811	0.1837
Channel				19965	20175	20385	EIRP		
Frequency (MHz)				1711.5	1732.5	1753.5	L	M	H
3	QPSK	1	0	23.00	23.00	22.85	0.2168	0.2168	0.2094
3	16QAM	1	0	22.09	22.17	22.30	0.1758	0.1791	0.1845
Channel				19950	20175	20393	EIRP		
Frequency (MHz)				1710	1732.5	1754.3	L	M	H
1.4	QPSK	1	0	22.98	22.78	22.85	0.2158	0.2061	0.2094
1.4	16QAM	1	0	21.91	22.14	22.19	0.1687	0.1778	0.1799



LTE Band 5									
BW [MHz]	Modulation	RB Size	RB Offset	Power Low Ch. / Freq.	Power Middle Ch. / Freq.	Power High Ch. / Freq.	ERP		
Channel				20450	20525	20600			
Frequency (MHz)				829	836.5	844	L	M	H
10	QPSK	1	0	23.11	23.36	23.18	0.0791	0.0838	0.0804
10	QPSK	1	25	23.30	23.22	23.22	0.0826	0.0811	0.0811
10	QPSK	1	49	23.01	23.07	23.10	0.0773	0.0783	0.0789
10	QPSK	25	0	22.28	22.33	22.30	0.0653	0.0661	0.0656
10	QPSK	25	12	22.29	22.32	22.29	0.0655	0.0659	0.0655
10	QPSK	25	25	22.24	22.29	22.16	0.0647	0.0655	0.0635
10	QPSK	50	0	22.25	22.32	22.28	0.0649	0.0659	0.0653
10	16QAM	1	0	22.51	22.50	22.53	0.0689	0.0687	0.0692
Channel				20425	20525	20625	ERP		
Frequency (MHz)				826.5	836.5	846.5	L	M	H
5	QPSK	1	0	23.14	23.16	23.05	0.0796	0.0800	0.0780
5	16QAM	1	0	22.32	22.39	22.35	0.0659	0.0670	0.0664
Channel				20415	20525	20635	ERP		
Frequency (MHz)				825.5	836.5	847.5	L	M	H
3	QPSK	1	0	22.98	23.24	23.11	0.0767	0.0815	0.0791
3	16QAM	1	0	22.28	22.41	22.07	0.0653	0.0673	0.0622
Channel				20407	20525	20643	ERP		
Frequency (MHz)				824.7	836.5	848.3	L	M	H
1.4	QPSK	1	0	23.22	23.04	22.99	0.0811	0.0778	0.0769
1.4	16QAM	1	0	22.30	22.38	22.38	0.0656	0.0668	0.0668



LTE Band 7									
BW [MHz]	Modulation	RB Size	RB Offset	Power Low Ch. / Freq.	Power Middle Ch. / Freq.	Power High Ch. / Freq.	EIRP		
Channel				20850	20850	21350			
Frequency (MHz)				2510	2535	2560	L	M	H
20	QPSK	1	0	23.05	23.18	22.79	0.2133	0.2198	0.2009
20	QPSK	1	49	23.11	22.98	23.12	0.2163	0.2099	0.2168
20	QPSK	1	99	22.95	22.87	22.85	0.2084	0.2046	0.2037
20	QPSK	50	0	21.93	22.05	21.72	0.1648	0.1694	0.1570
20	QPSK	50	24	22.04	22.01	21.81	0.1690	0.1679	0.1603
20	QPSK	50	50	21.97	21.80	21.68	0.1663	0.1600	0.1556
20	QPSK	100	0	21.92	21.95	21.70	0.1644	0.1656	0.1563
20	16QAM	1	0	21.90	21.93	21.76	0.1637	0.1648	0.1585
Channel				20825	21100	21375	EIRP		
Frequency (MHz)				2507.5	2535	2562.5	L	M	H
15	QPSK	1	0	23.04	22.84	23.00	0.2128	0.2032	0.2109
15	16QAM	1	0	21.83	21.82	21.55	0.1611	0.1607	0.1510
Channel				20800	21100	21400	EIRP		
Frequency (MHz)				2505	2535	2565	L	M	H
10	QPSK	1	0	23.00	22.76	22.93	0.2109	0.1995	0.2075
10	16QAM	1	0	21.83	21.74	21.72	0.1611	0.1578	0.1570
Channel				20775	21100	21425	EIRP		
Frequency (MHz)				2502.5	2535	2567.5	L	M	H
5	QPSK	1	0	22.82	23.04	22.71	0.2023	0.2128	0.1972
5	16QAM	1	0	21.82	21.79	21.63	0.1607	0.1596	0.1538



LTE Band 26									
BW [MHz]	Modulation	RB Size	RB Offset	Power Low Ch. / Freq.	Power Middle Ch. / Freq.	Power High Ch. / Freq.	ERP		
Channel				26865	26915	26965			
Frequency (MHz)				831.5	836.5	841.5	L	M	H
15	QPSK	1	0	23.12	23.38	23.21	0.0793	0.0841	0.0809
15	QPSK	1	37	23.16	23.09	23.07	0.0800	0.0787	0.0783
15	QPSK	1	74	22.88	23.10	23.20	0.0750	0.0789	0.0807
15	QPSK	36	0	22.17	22.26	22.15	0.0637	0.0650	0.0634
15	QPSK	36	20	22.17	22.25	22.21	0.0637	0.0649	0.0643
15	QPSK	36	39	22.14	22.14	22.05	0.0632	0.0632	0.0619
15	QPSK	75	0	22.12	22.20	22.19	0.0630	0.0641	0.0640
15	16QAM	1	0	22.44	22.35	22.43	0.0678	0.0664	0.0676
Channel				26840	26915	26990	ERP		
Frequency (MHz)				829	836.5	844	L	M	H
10	QPSK	1	0	23.06	23.18	23.01	0.0782	0.0804	0.0773
10	16QAM	1	0	22.31	22.41	22.43	0.0658	0.0673	0.0676
Channel				26815	26915	27015	ERP		
Frequency (MHz)				826.5	836.5	846.5	L	M	H
5	QPSK	1	0	23.09	22.90	22.92	0.0787	0.0753	0.0757
5	16QAM	1	0	22.16	22.33	22.19	0.0635	0.0661	0.0640
Channel				26815	26915	27025	ERP		
Frequency (MHz)				825.5	836.5	847.5	L	M	H
3	QPSK	1	0	22.81	23.15	23.03	0.0738	0.0798	0.0776
3	16QAM	1	0	22.15	22.28	22.28	0.0634	0.0653	0.0653
Channel				26797	26915	27033	ERP		
Frequency (MHz)				824.7	836.5	848.3	L	M	H
1.4	QPSK	1	0	22.80	23.15	22.90	0.0736	0.0798	0.0753
1.4	16QAM	1	0	22.15	22.23	22.25	0.0634	0.0646	0.0649



LTE Band 38									
BW [MHz]	Modulation	RB Size	RB Offset	Power Low Ch. / Freq.	Power Middle Ch. / Freq.	Power High Ch. / Freq.	EIRP		
Channel				37850	38000	38150			
Frequency (MHz)				2580	2595	2610	L	M	H
20	QPSK	1	0	22.72	22.94	22.54	0.1982	0.2084	0.1901
20	QPSK	1	49	22.68	22.76	22.55	0.1963	0.2000	0.1905
20	QPSK	1	99	22.56	22.61	22.58	0.1910	0.1932	0.1919
20	QPSK	50	0	21.69	21.86	21.39	0.1563	0.1626	0.1459
20	QPSK	50	24	21.68	21.60	21.44	0.1560	0.1531	0.1476
20	QPSK	50	50	21.69	21.49	21.40	0.1563	0.1493	0.1462
20	QPSK	100	0	21.80	21.82	21.41	0.1603	0.1611	0.1466
20	16QAM	1	0	21.78	21.88	21.63	0.1596	0.1633	0.1542
Channel				37825	38000	38175	EIRP		
Frequency (MHz)				2577.5	2595	2612.5	L	M	H
15	QPSK	1	0	22.74	22.77	22.54	0.1991	0.2004	0.1901
15	16QAM	1	0	21.81	21.80	21.60	0.1607	0.1603	0.1531
Channel				37800	38000	38200	EIRP		
Frequency (MHz)				2575	2595	2615	L	M	H
10	QPSK	1	0	22.76	22.58	22.37	0.2000	0.1919	0.1828
10	16QAM	1	0	21.88	21.57	21.67	0.1633	0.1521	0.1556
Channel				37775	38000	38225	EIRP		
Frequency (MHz)				2572.5	2595	2617.5	L	M	H
5	QPSK	1	0	22.69	22.75	22.52	0.1968	0.1995	0.1892
5	16QAM	1	0	21.87	21.56	21.57	0.1629	0.1517	0.1521



LTE Band 41									
BW [MHz]	Modulation	RB Size	RB Offset	Power Low Ch. / Freq.	Power Middle Ch. / Freq.	Power High Ch. / Freq.	EIRP		
Channel				39750	40620	41490			
Frequency (MHz)				2506	2593	2680	L	M	H
20	QPSK	1	0	22.96	23.04	22.66	0.2094	0.2133	0.1954
20	QPSK	1	49	22.95	22.96	22.90	0.2089	0.2094	0.2065
20	QPSK	1	99	23.04	22.66	22.68	0.2133	0.1954	0.1963
20	QPSK	50	0	21.96	21.73	21.75	0.1663	0.1578	0.1585
20	QPSK	50	24	22.04	21.67	21.60	0.1694	0.1556	0.1531
20	QPSK	50	50	21.97	21.76	21.74	0.1667	0.1589	0.1581
20	QPSK	100	0	22.04	21.66	21.64	0.1694	0.1552	0.1545
20	16QAM	1	0	22.21	21.71	21.67	0.1762	0.1570	0.1556
Channel				39725	40620	41515	EIRP		
Frequency (MHz)				2503.5	2593	2682.5	L	M	H
15	QPSK	1	0	23.02	22.75	22.58	0.2123	0.1995	0.1919
15	16QAM	1	0	22.17	21.82	21.83	0.1746	0.1611	0.1614
Channel				39700	40620	41540	EIRP		
Frequency (MHz)				2501	2593	2685	L	M	H
10	QPSK	1	0	22.97	22.80	22.66	0.2099	0.2018	0.1954
10	16QAM	1	0	21.97	21.91	21.91	0.1667	0.1644	0.1644
Channel				39675	40620	41565	EIRP		
Frequency (MHz)				2498.5	2593	2687.5	L	M	H
5	QPSK	1	0	23.04	22.68	22.76	0.2133	0.1963	0.2000
5	16QAM	1	0	22.17	21.79	21.91	0.1746	0.1600	0.1644



LTE Band 2

Peak-to-Average Ratio

Mode	LTE Band 2 / 20MHz			
Mod.	QPSK	16QAM	-	Limit: 13dB
RB Size	Full RB	Full RB	-	Result
Middle CH	4.99	6	-	PASS

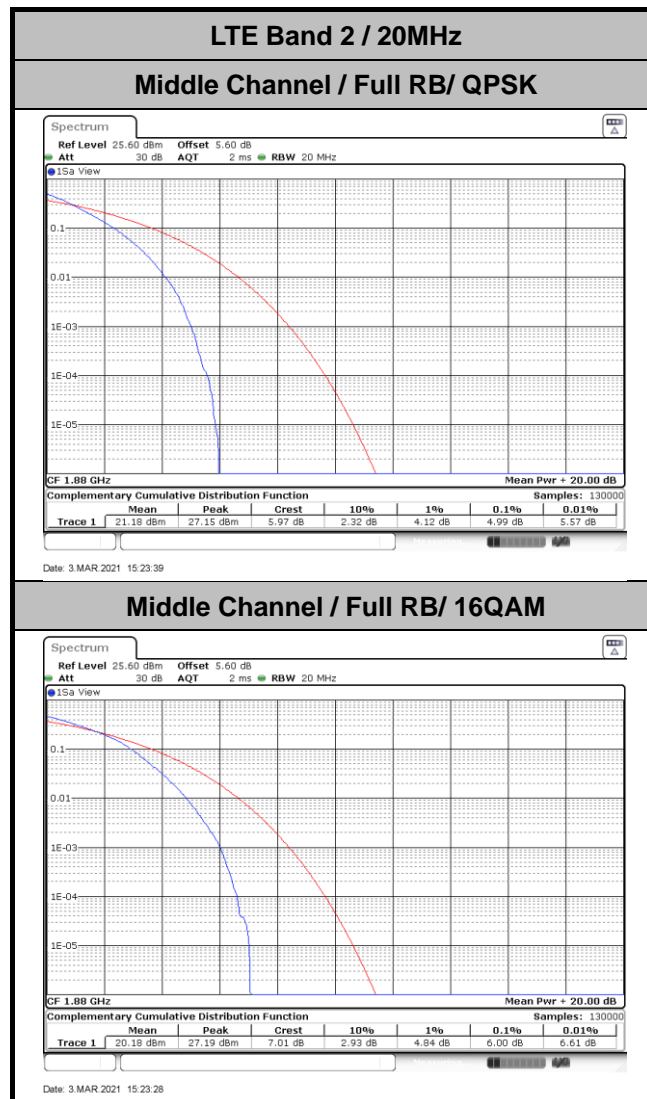



26dB Bandwidth

Mode	LTE Band 2 : 26dB BW(MHz)	
BW	20MHz	
Mod.	QPSK	16QAM
Middle CH	20.18	20.1

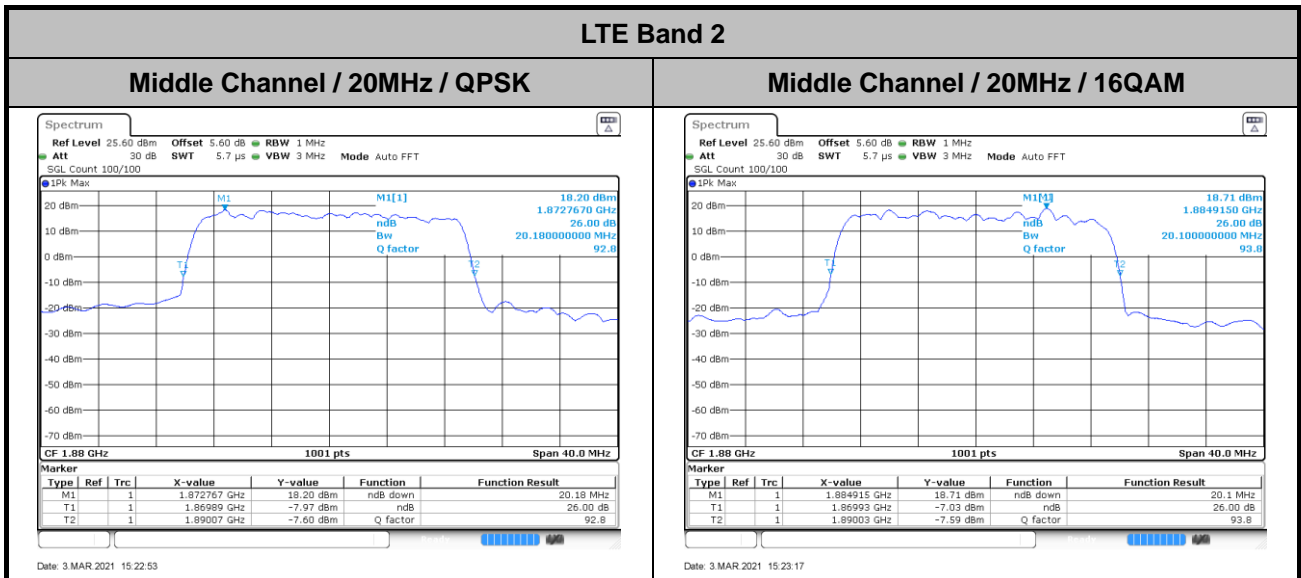



Occupied Bandwidth

Mode	LTE Band 2 : 99%OBW(MHz)	
BW	20MHz	
Mod.	QPSK	16QAM
Middle CH	18.34	18.18

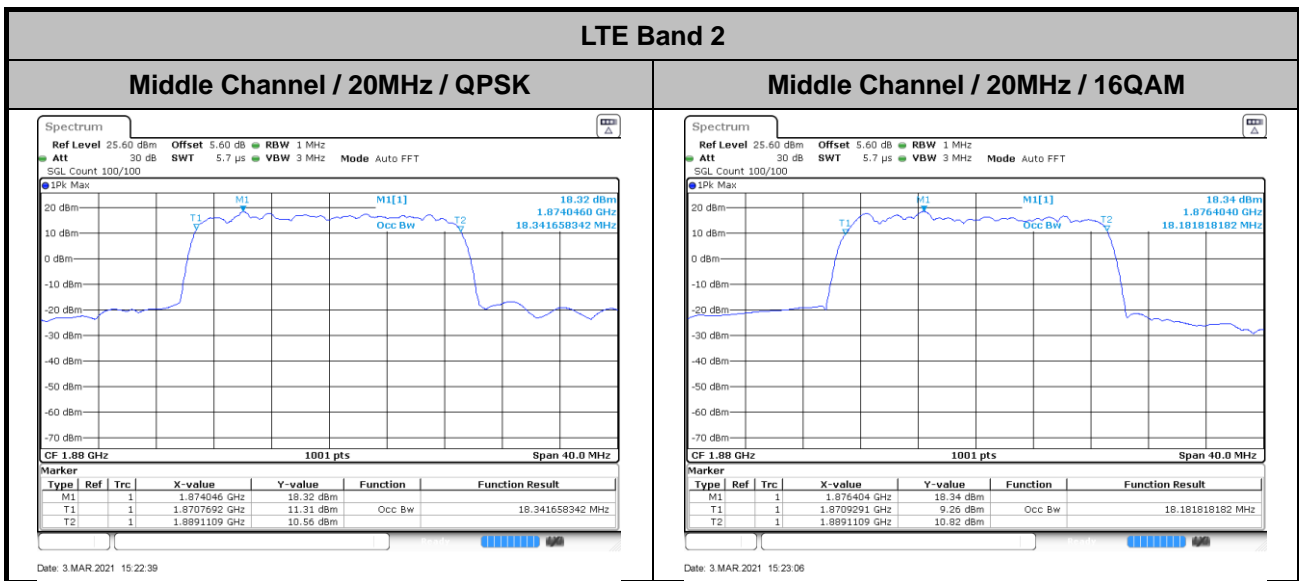



Conducted Band Edge

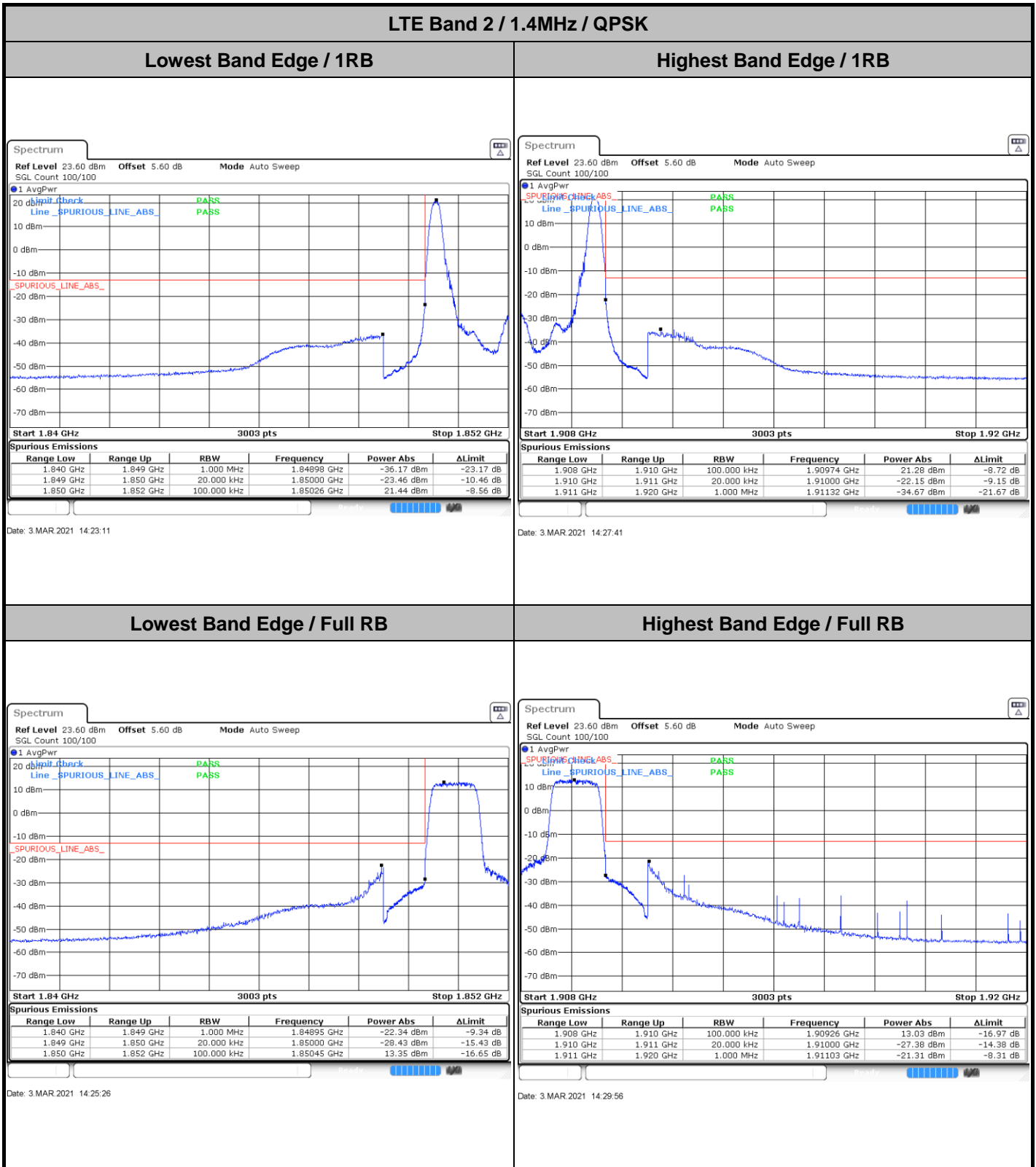



LTE Band 2 / 1.4MHz / 16QAM

Lowest Band Edge / 1 RB

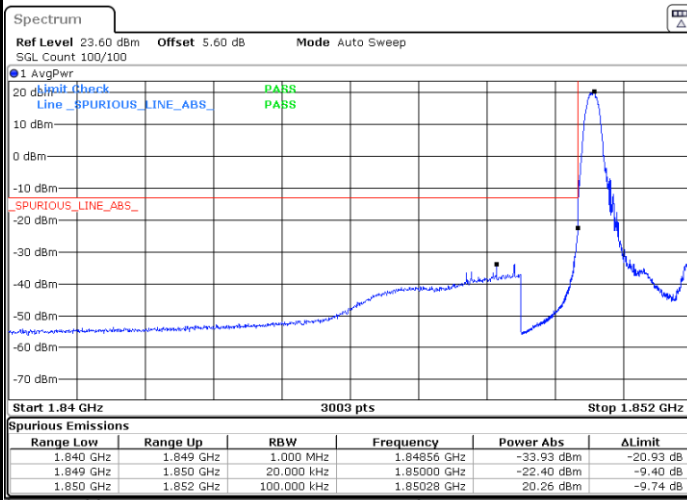

Date: 3.MAR.2021 14:24:19

Highest Band Edge / 1 RB

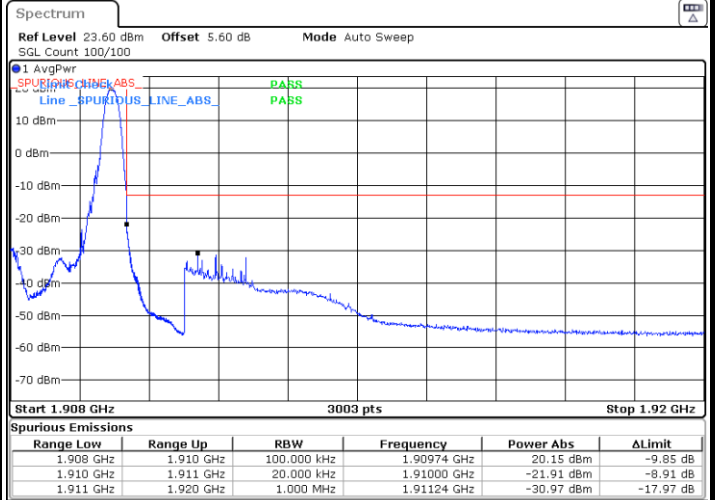

Date: 3.MAR.2021 14:28:49

Lowest Band Edge / Full RB

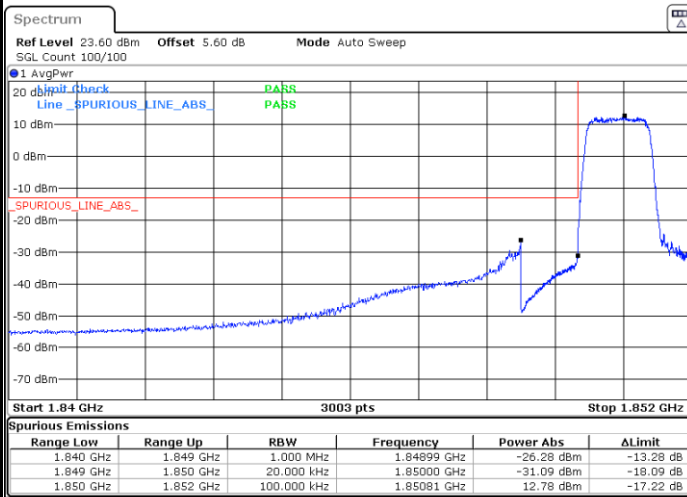

Date: 3.MAR.2021 14:26:34

Highest Band Edge / Full RB



Date: 3.MAR.2021 14:31:04



LTE Band 2 / 3MHz / QPSK

Lowest Band Edge / 1RB

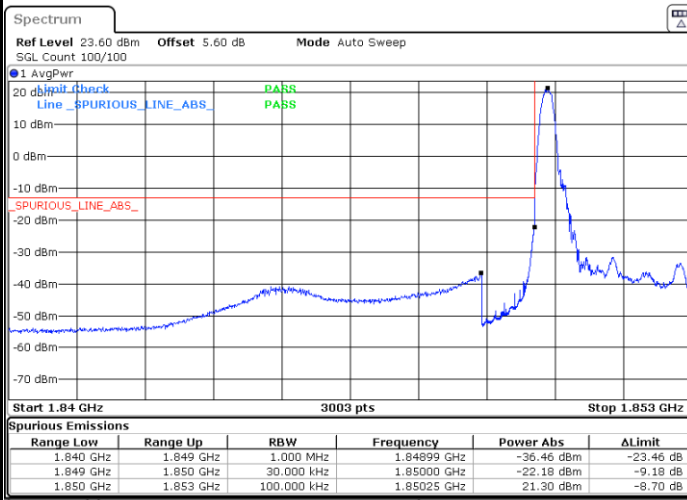

Date: 3.MAR.2021 14:32:11

Highest Band Edge / 1 RB

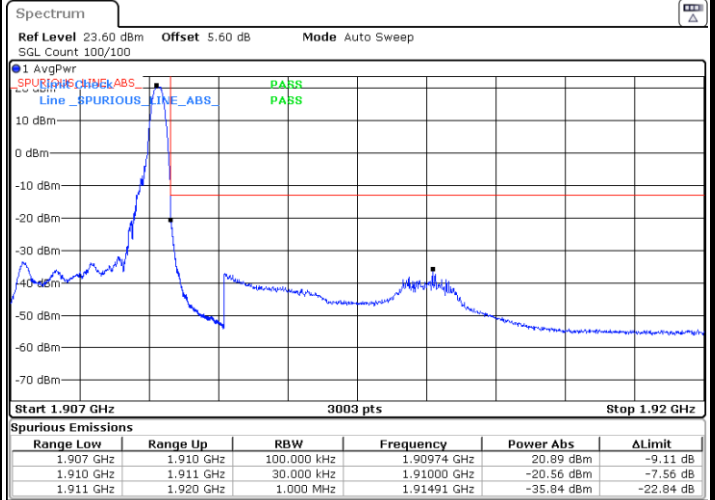

Date: 3.MAR.2021 14:36:41

Lowest Band Edge / Full RB

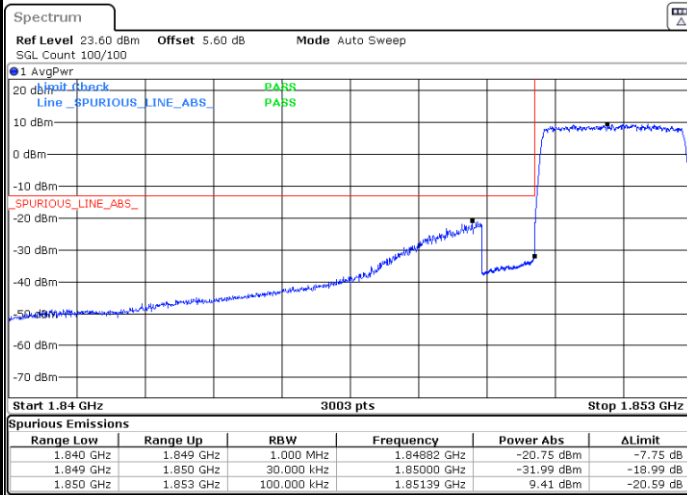

Date: 3.MAR.2021 14:34:26

Highest Band Edge / Full RB

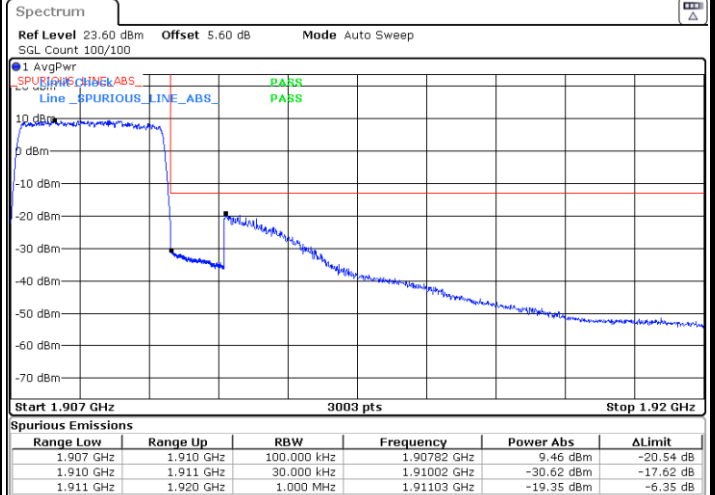

Date: 3.MAR.2021 14:38:56



LTE Band 2 / 3MHz / 16QAM

Lowest Band Edge / 1 RB

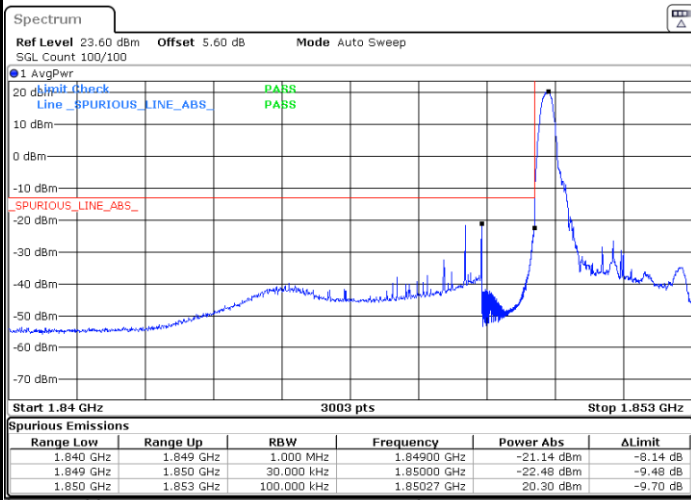

Date: 3.MAR.2021 14:33:19

Highest Band Edge / 1 RB

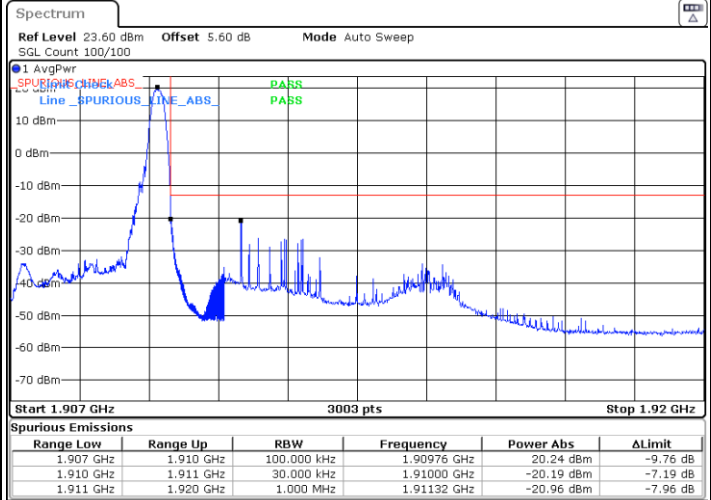

Date: 3.MAR.2021 14:37:49

Lowest Band Edge / Full RB

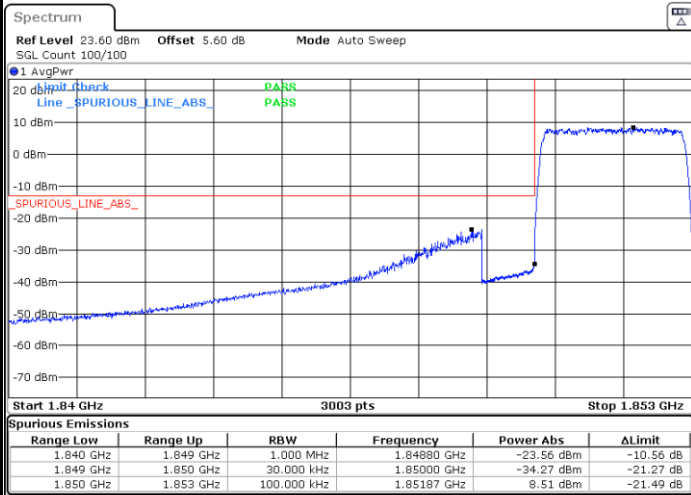

Date: 3.MAR.2021 14:35:34

Highest Band Edge / Full RB

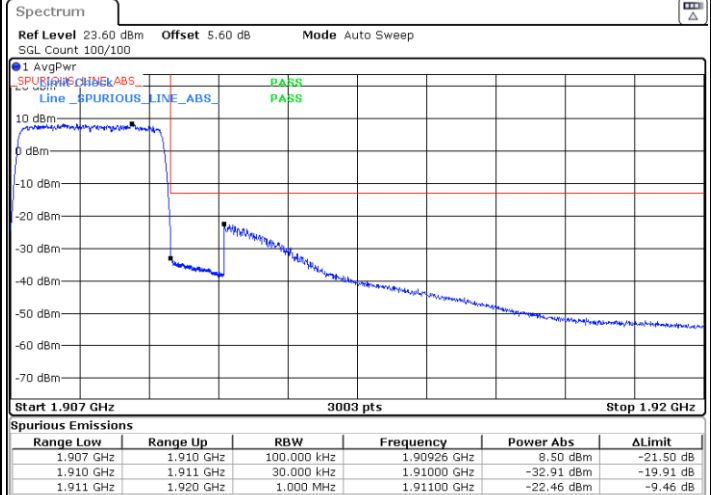

Date: 3.MAR.2021 14:40:04



LTE Band 2 / 5MHz / QPSK

Lowest Band Edge / 1 RB

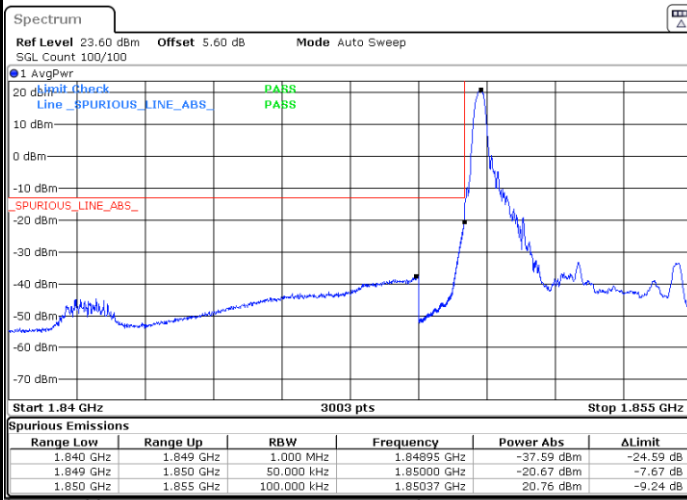

Date: 3.MAR.2021 14:41:11

Highest Band Edge / 1 RB

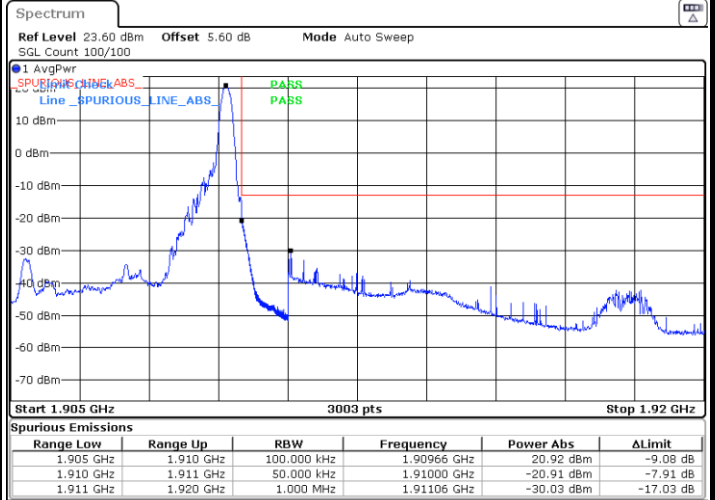

Date: 3.MAR.2021 14:45:41

Lowest Band Edge / Full RB

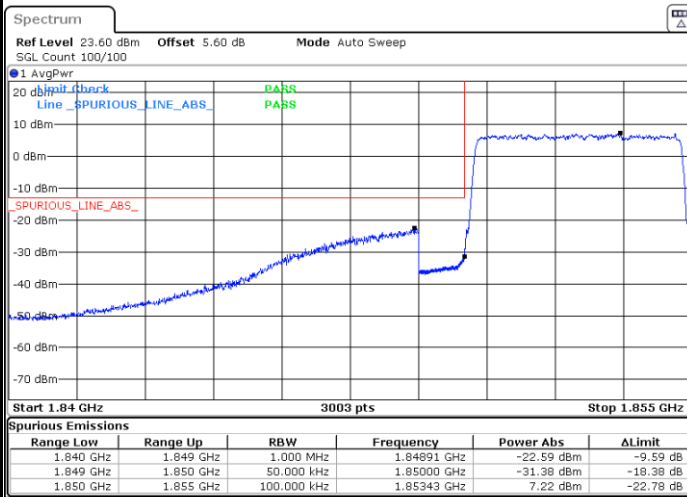

Date: 3.MAR.2021 14:43:26

Highest Band Edge / Full RB

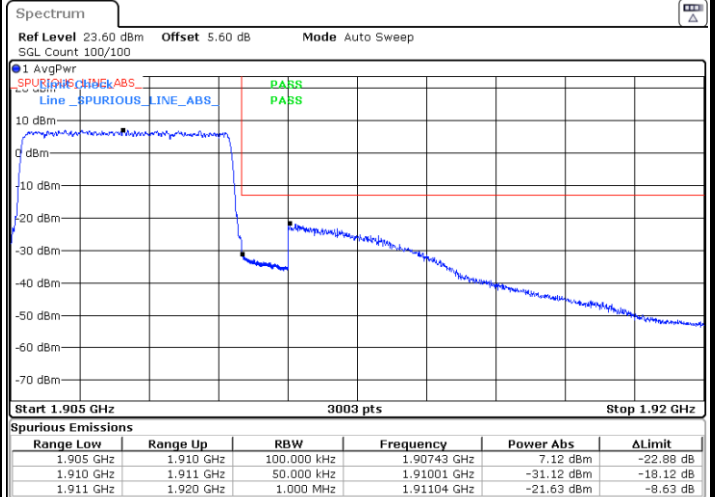

Date: 3.MAR.2021 14:47:56



LTE Band 2 / 5MHz / 16QAM

Lowest Band Edge / 1RB

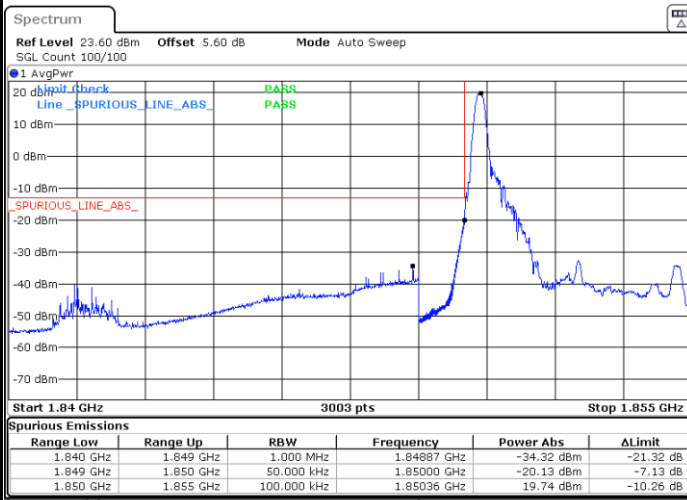

Date: 3.MAR.2021 14:42:19

Highest Band Edge / 1 RB

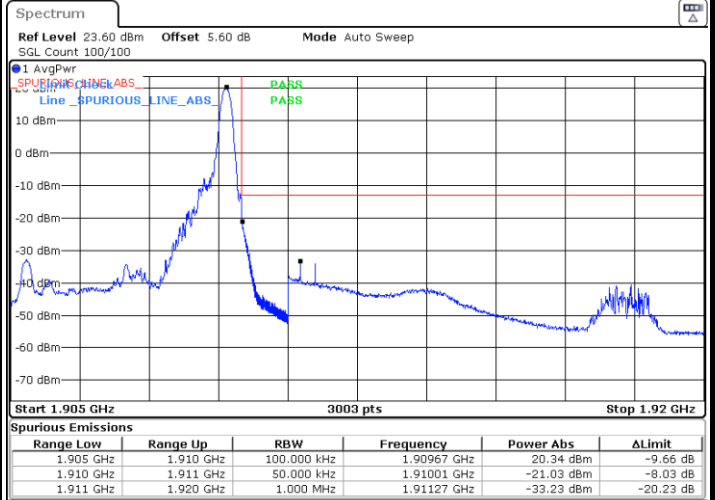

Date: 3.MAR.2021 14:46:49

Lowest Band Edge / Full RB

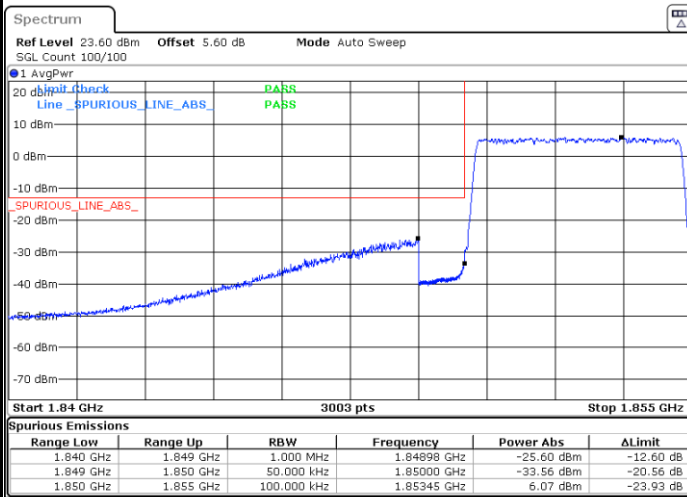

Date: 3.MAR.2021 14:44:34

Highest Band Edge / Full RB



Date: 3.MAR.2021 14:49:04



LTE Band 2 / 10MHz / QPSK

Lowest Band Edge / 1 RB

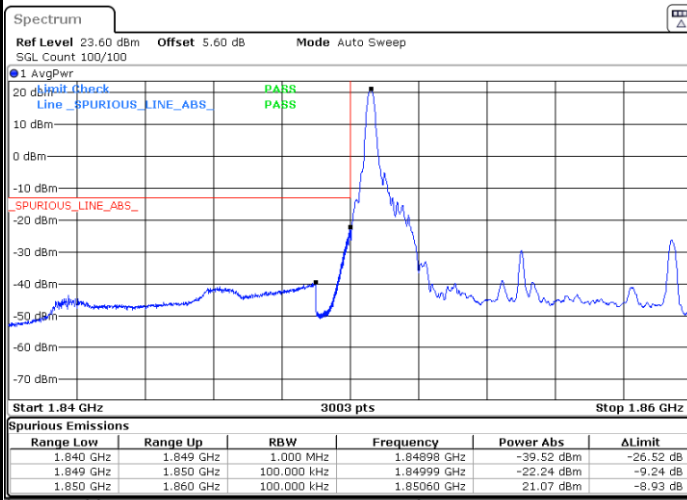

Date: 3.MAR.2021 14:50:11

Highest Band Edge / 1 RB

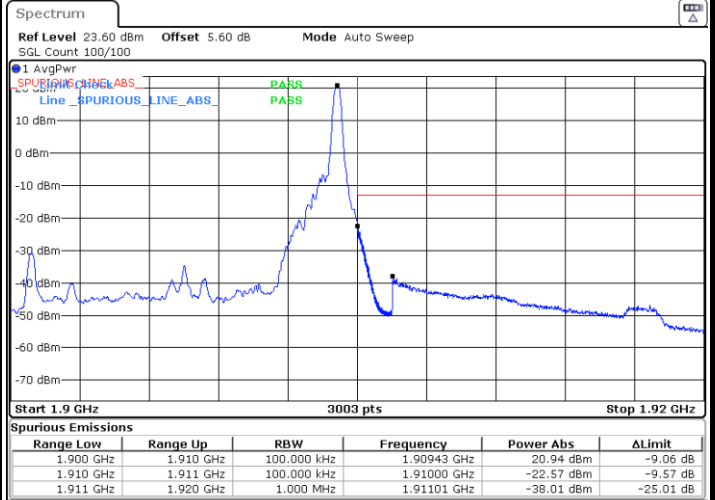

Date: 3.MAR.2021 14:54:41

Lowest Band Edge / Full RB

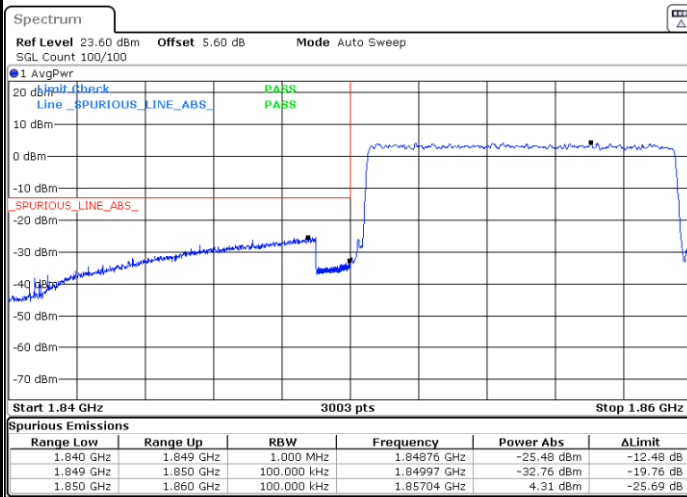

Date: 3.MAR.2021 14:52:26

Highest Band Edge / Full RB



Date: 3.MAR.2021 14:56:58



LTE Band 2 / 10MHz / 16QAM

Lowest Band Edge / 1 RB

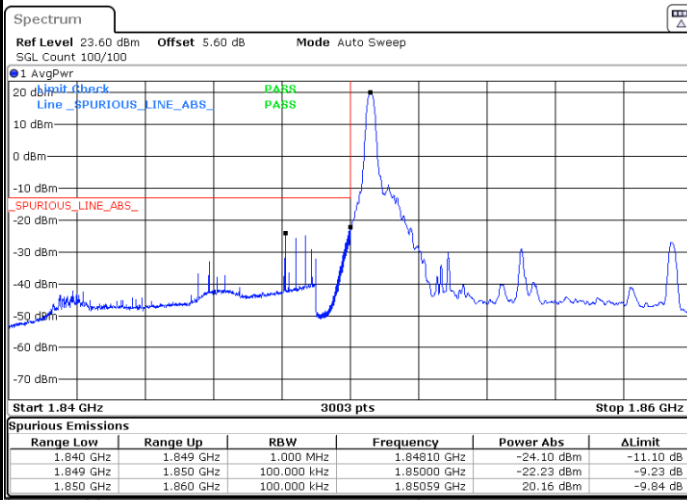

Date: 3.MAR.2021 14:51:19

Highest Band Edge / 1 RB

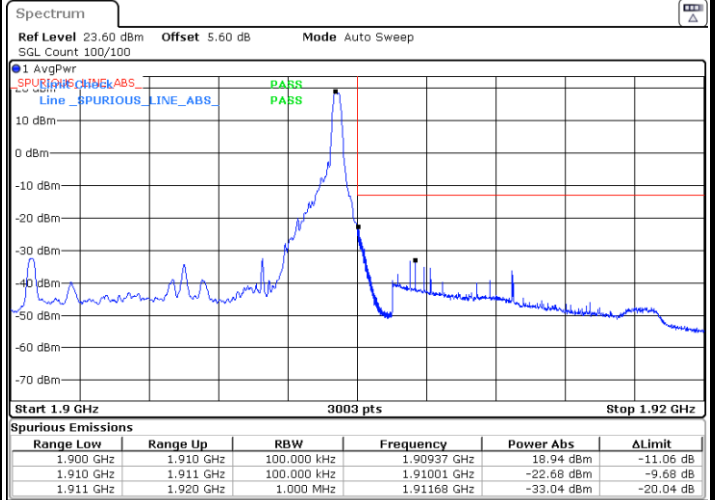

Date: 3.MAR.2021 14:55:49

Lowest Band Edge / Full RB

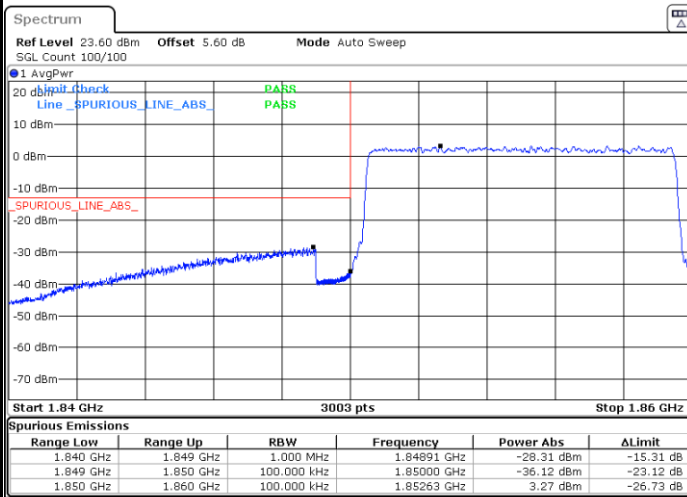

Date: 3.MAR.2021 14:53:34

Highest Band Edge / Full RB

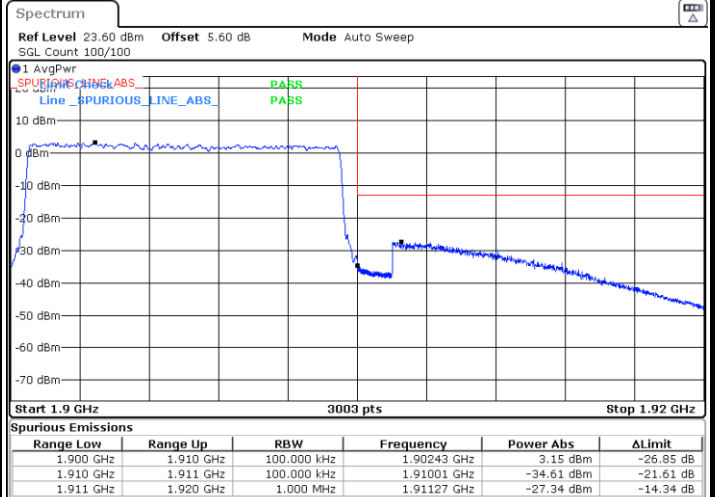

Date: 3.MAR.2021 14:58:04



LTE Band 2 / 15MHz / QPSK

Lowest Band Edge / 1 RB

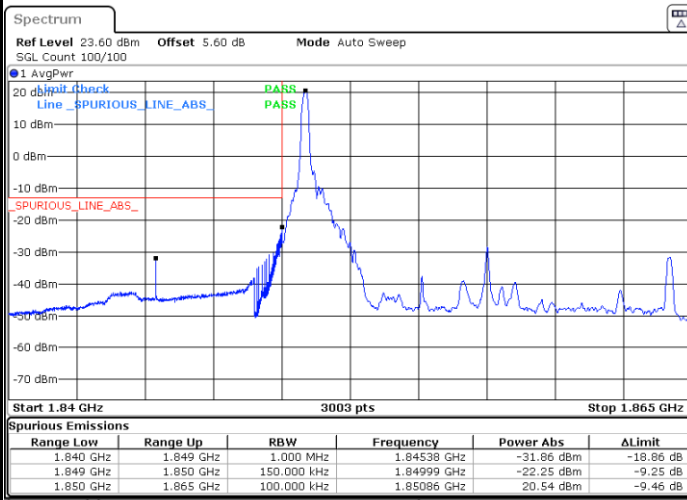

Date: 3.MAR.2021 14:59:11

Highest Band Edge / 1 RB

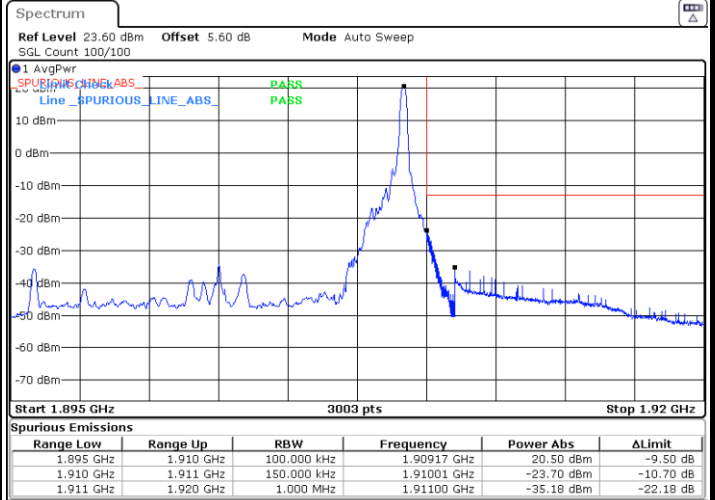

Date: 3.MAR.2021 15:03:41

Lowest Band Edge / Full RB

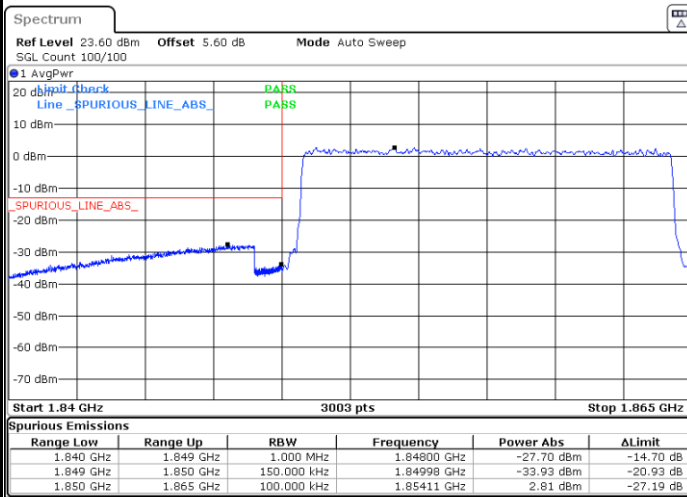

Date: 3.MAR.2021 15:01:26

Highest Band Edge / Full RB

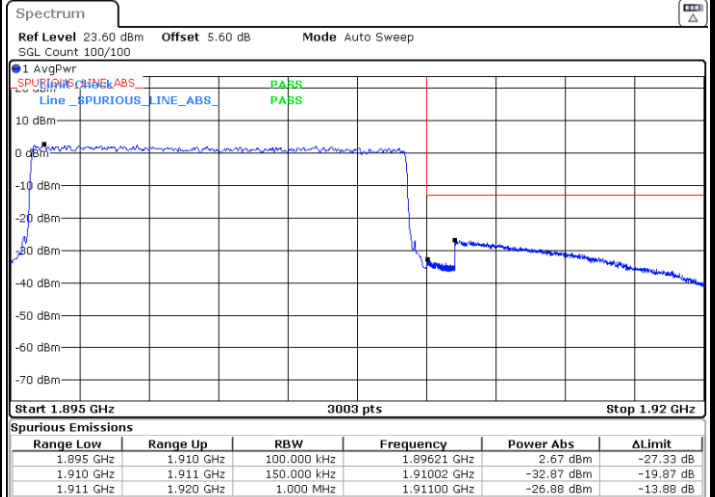

Date: 3.MAR.2021 15:05:58



LTE Band 2 / 15MHz / 16QAM

Lowest Band Edge / 1 RB

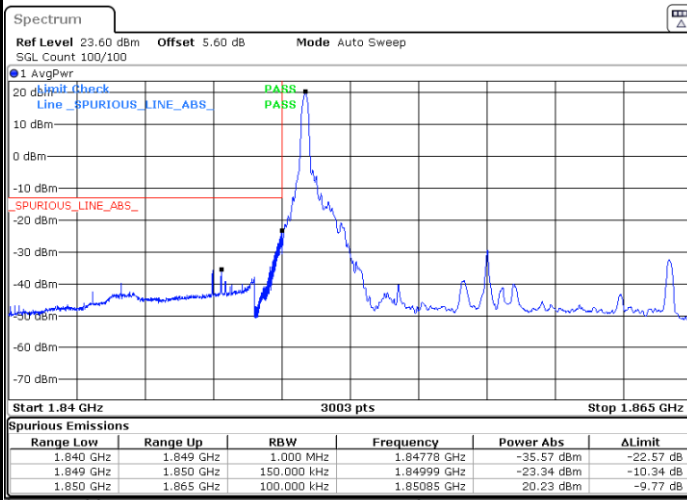

Date: 3.MAR.2021 15:00:19

Highest Band Edge / 1 RB

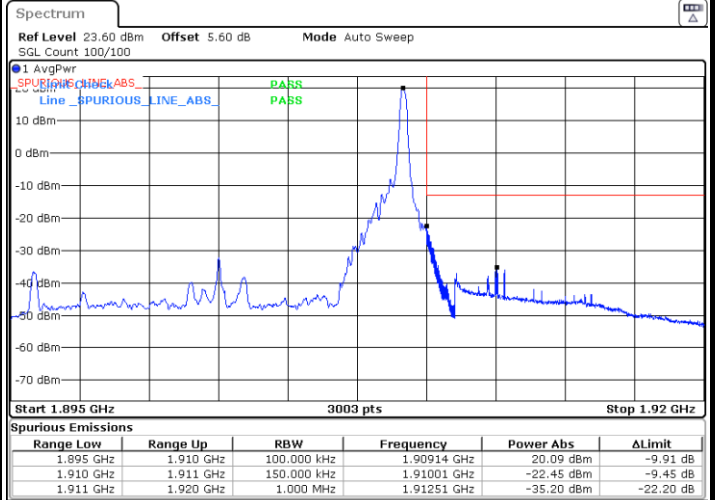

Date: 3.MAR.2021 15:04:49

Lowest Band Edge / Full RB

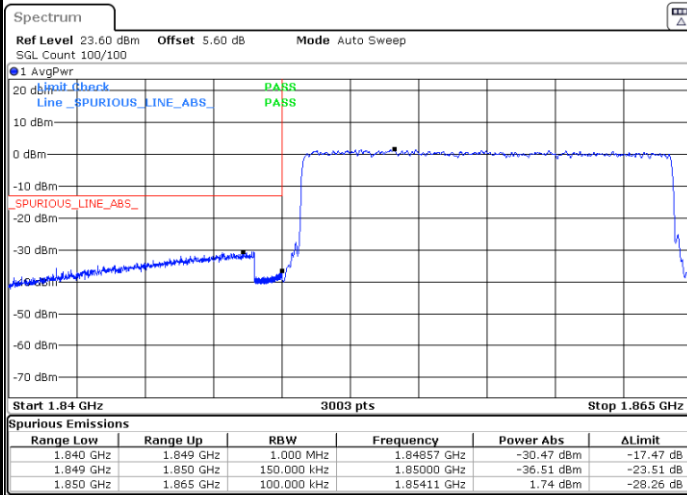

Date: 3.MAR.2021 15:02:34

Highest Band Edge / Full RB

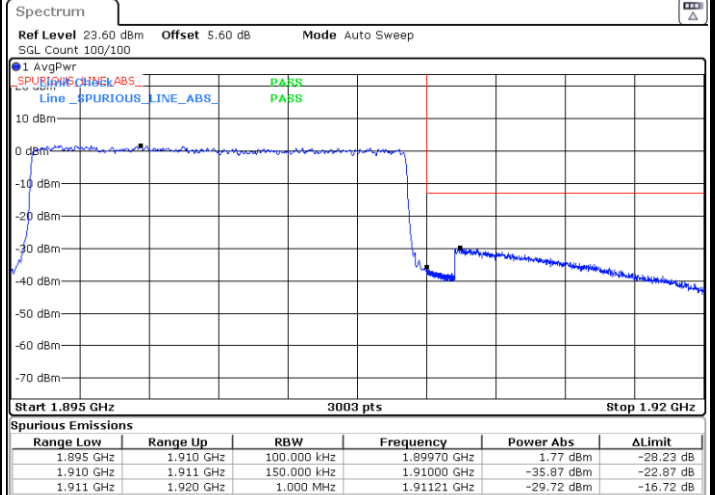

Date: 3.MAR.2021 15:07:04



LTE Band 2 / 20MHz / QPSK

Lowest Band Edge / 1 RB

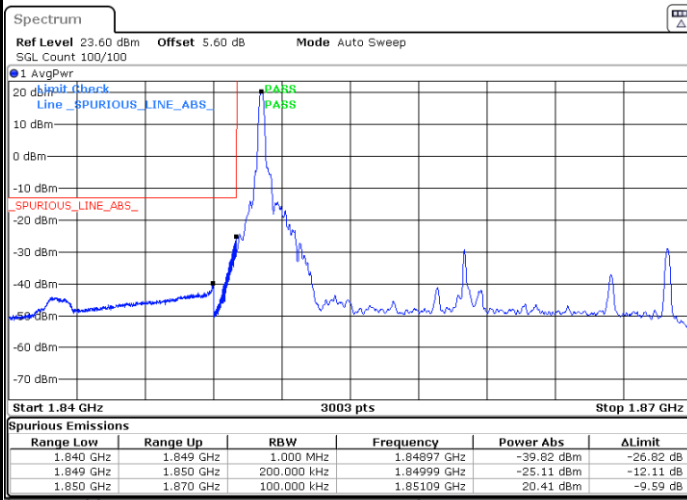

Date: 3.MAR.2021 15:08:11

Highest Band Edge / 1 RB

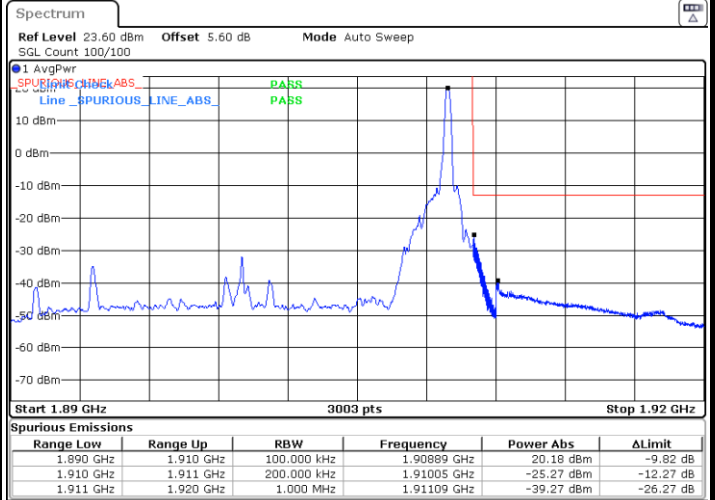

Date: 3.MAR.2021 15:12:41

Lowest Band Edge / Full RB

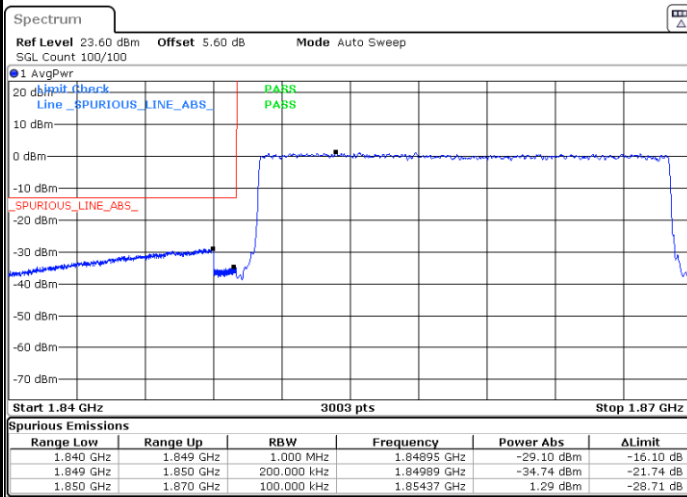

Date: 3.MAR.2021 15:10:26

Highest Band Edge / Full RB

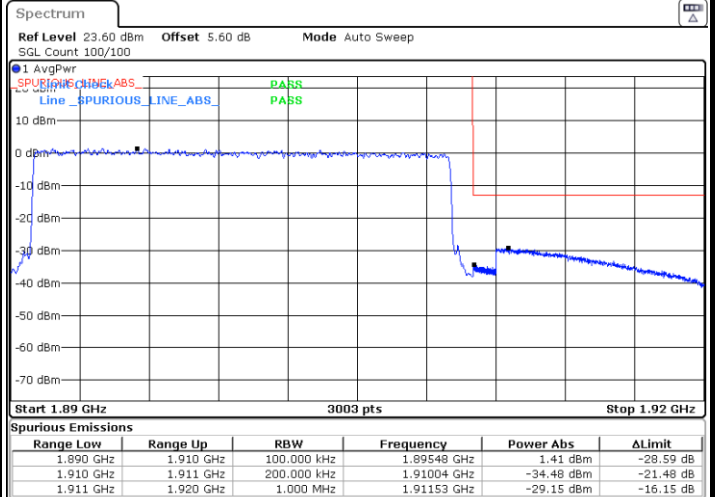

Date: 3.MAR.2021 15:14:58



LTE Band 2 / 20MHz / 16QAM

Lowest Band Edge / 1 RB

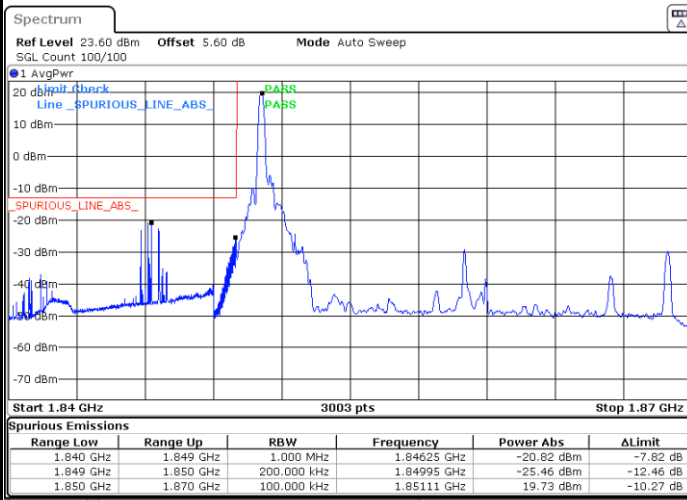

Date: 3.MAR.2021 15:09:19

Highest Band Edge / 1 RB

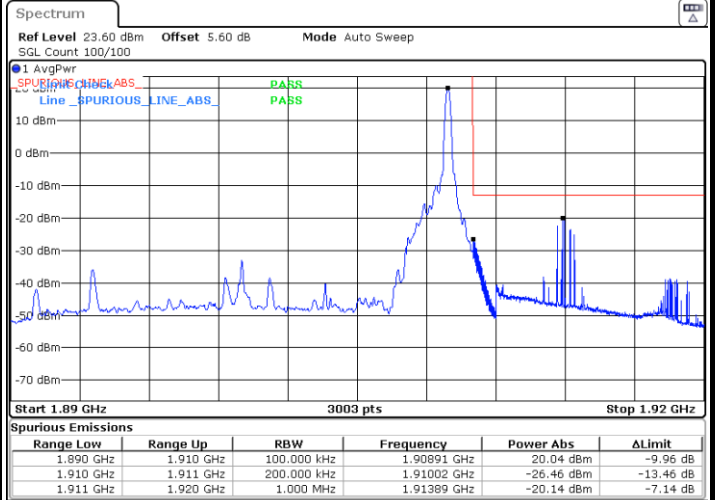

Date: 3.MAR.2021 15:13:49

Lowest Band Edge / Full RB

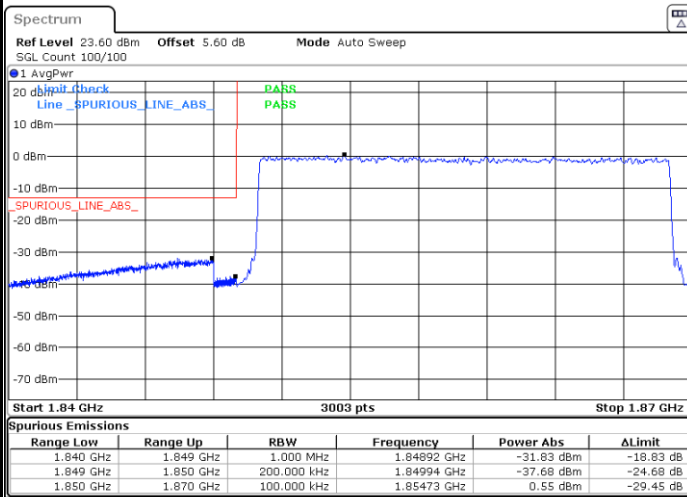

Date: 3.MAR.2021 15:11:34

Highest Band Edge / Full RB

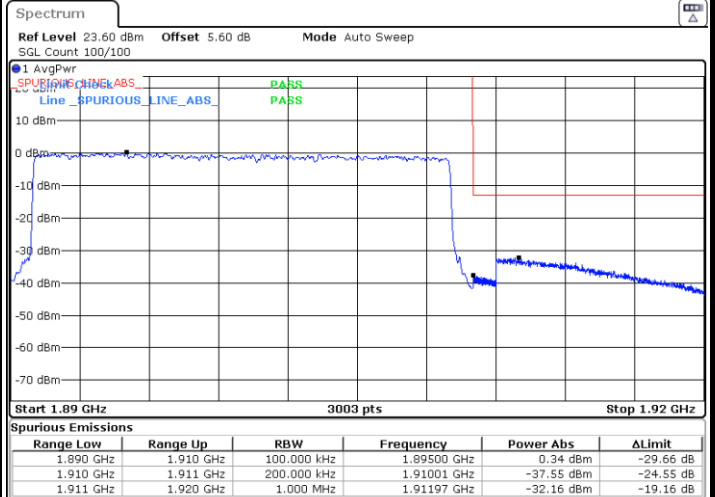

Date: 3.MAR.2021 15:16:04



Conducted Spurious Emission

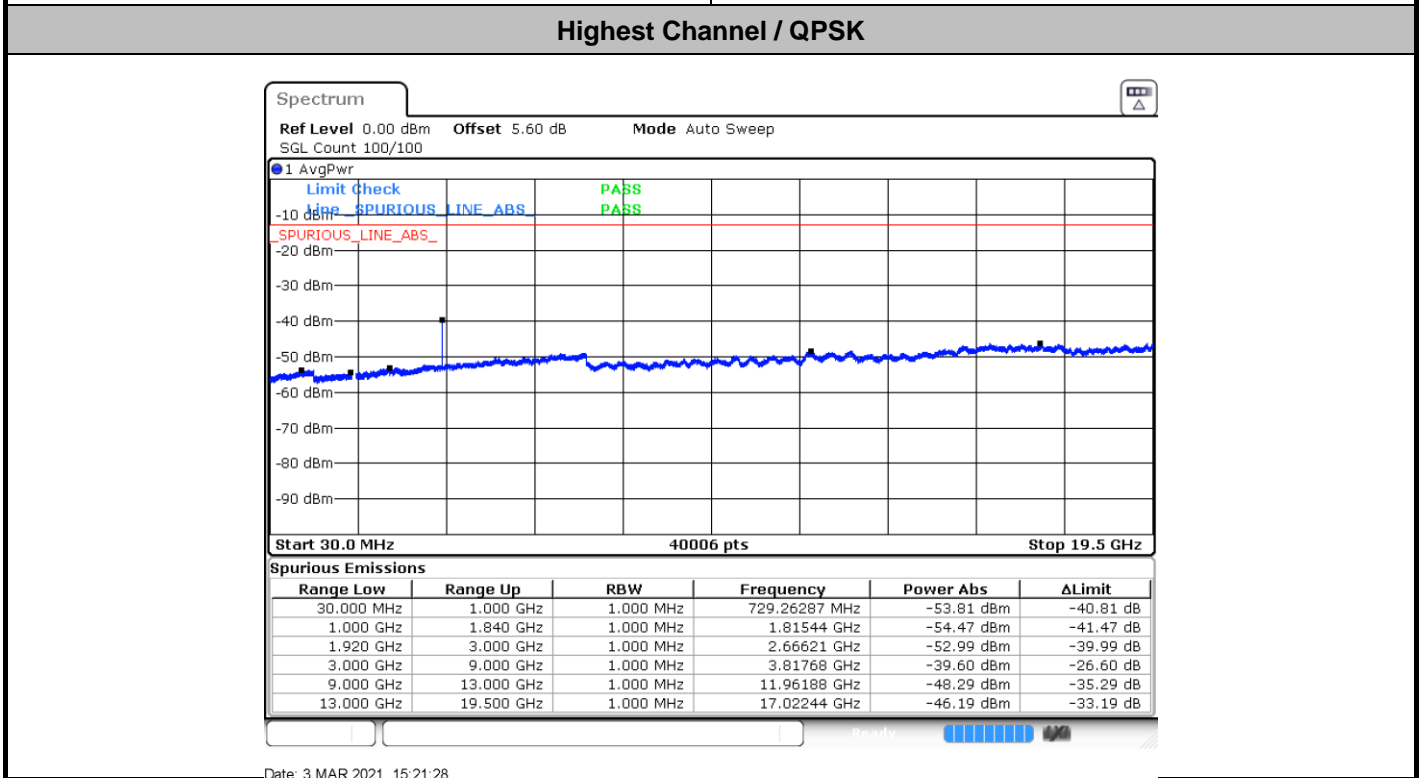
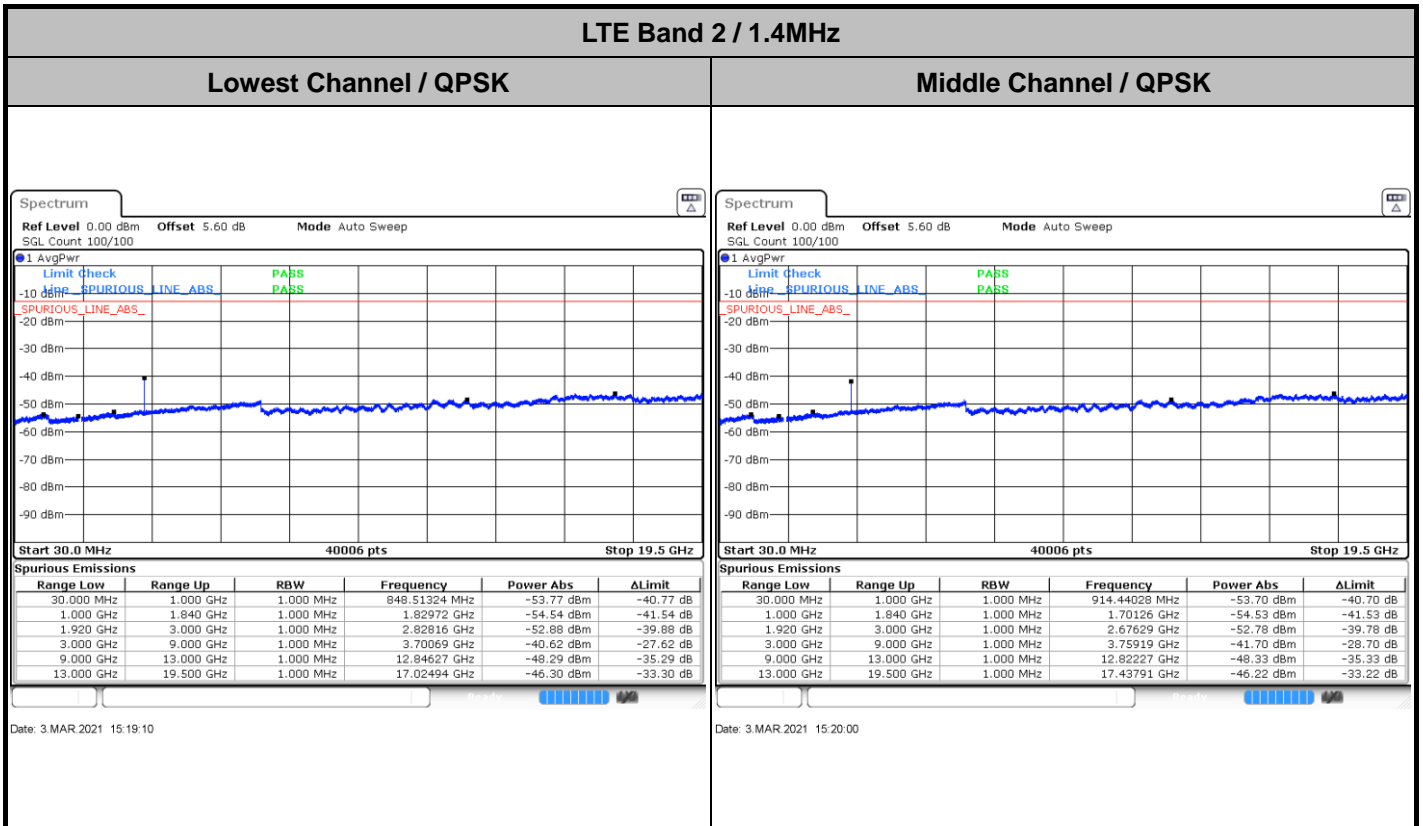



LTE Band 2 / 3MHz

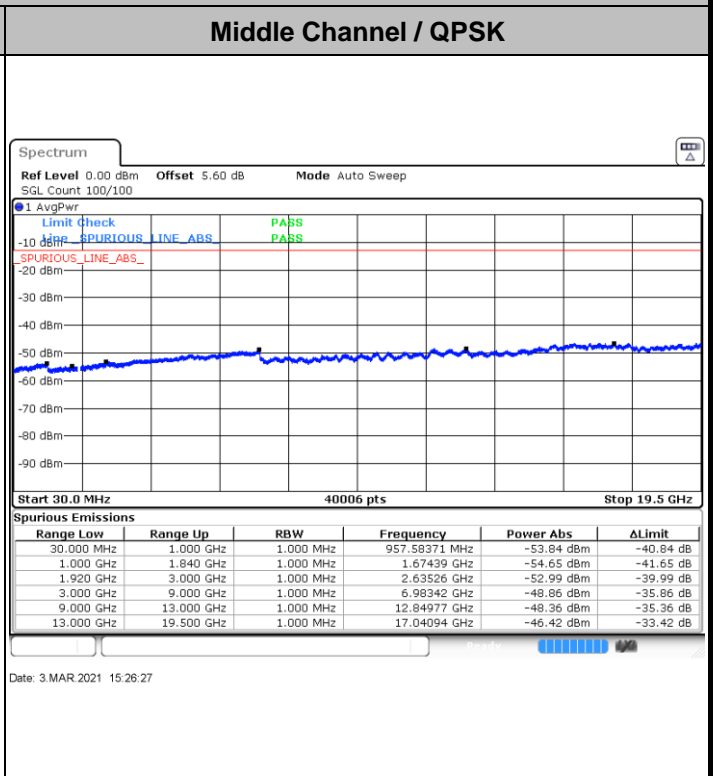
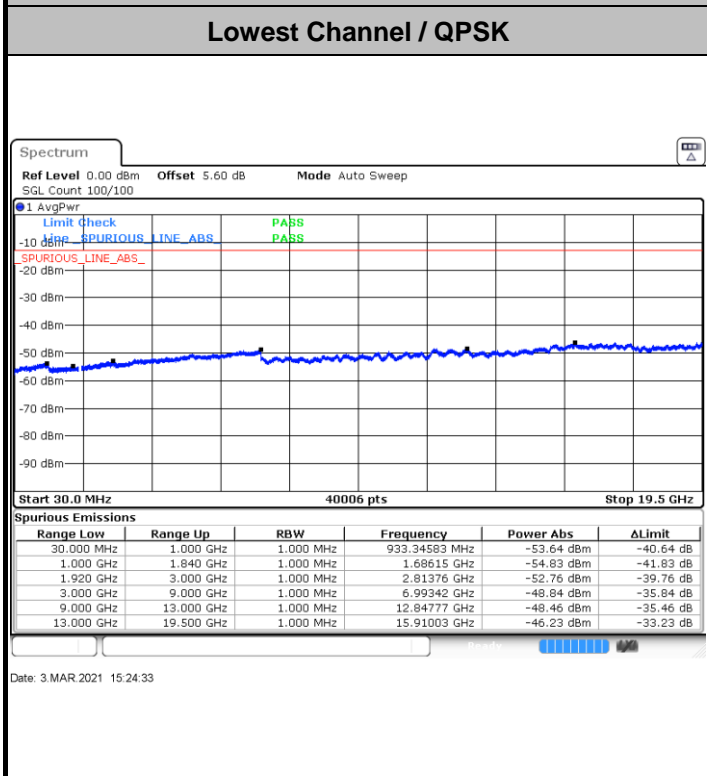

Highest Channel / QPSK

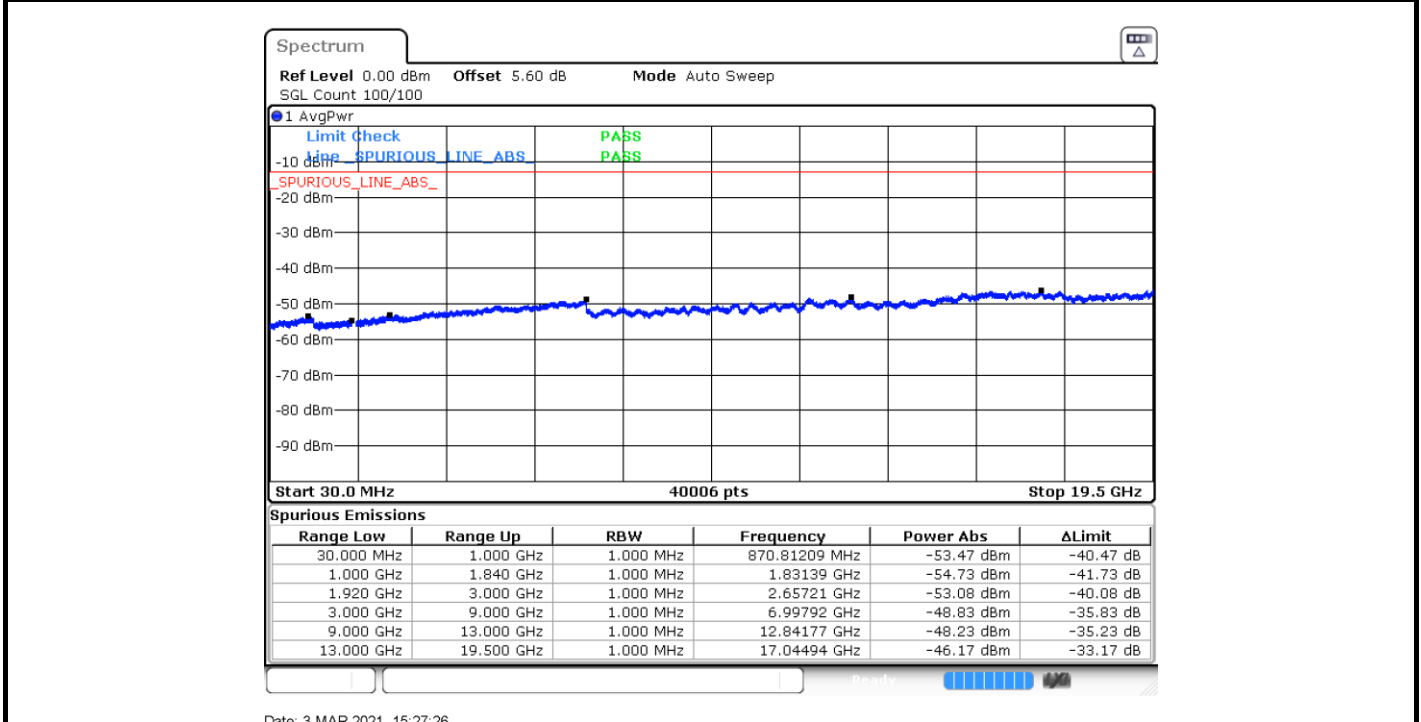



LTE Band 2 / 5MHz

Lowest Channel / QPSK

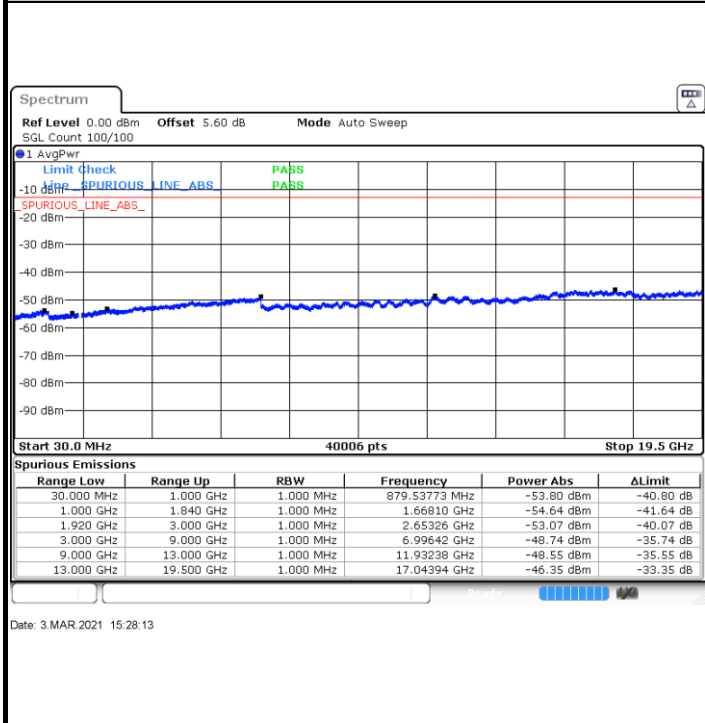

Middle Channel / QPSK

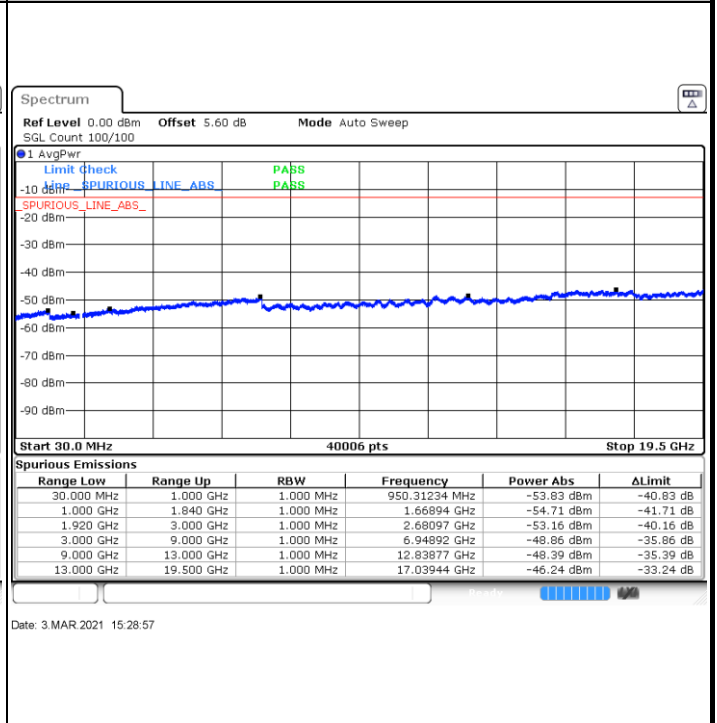

Highest Channel / QPSK

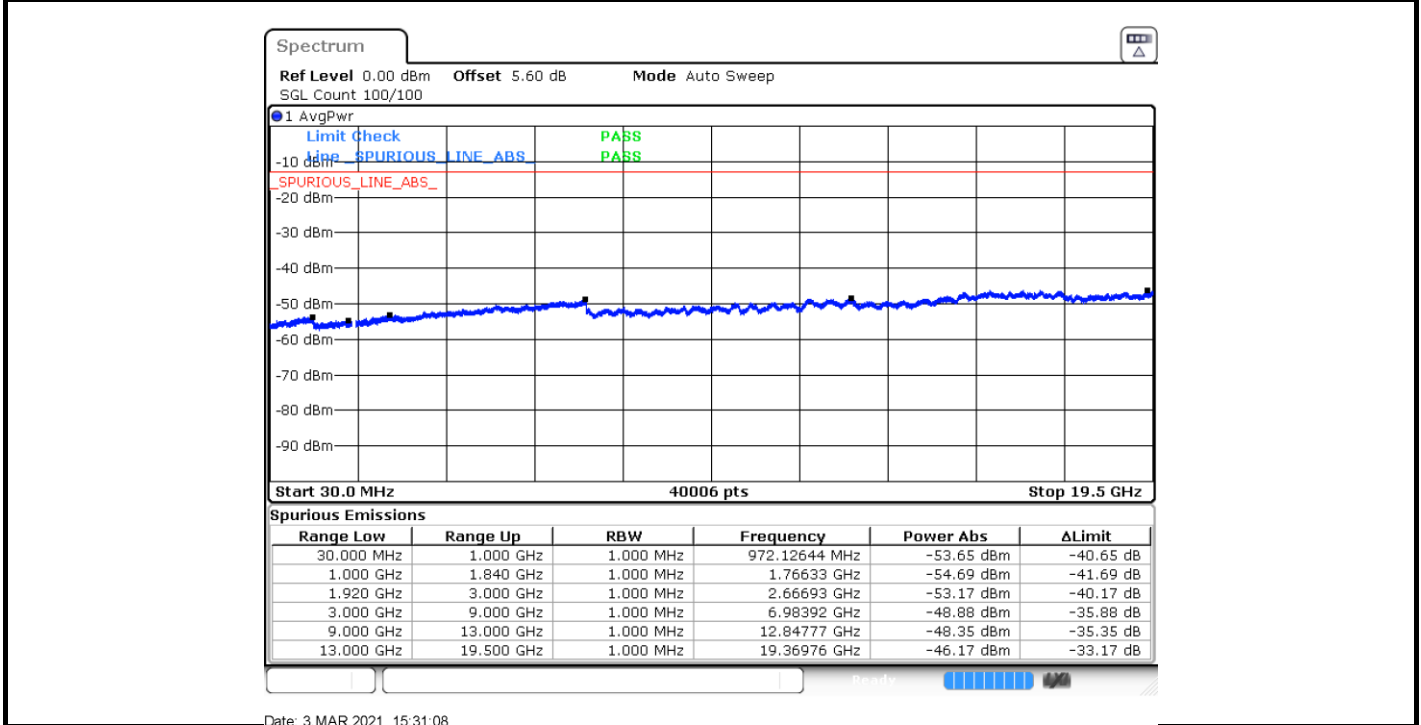



LTE Band 2 / 10MHz

Lowest Channel / QPSK

Middle Channel / QPSK

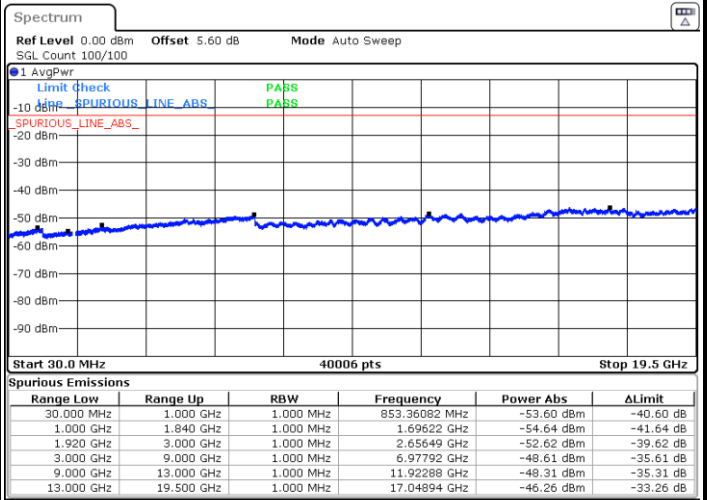
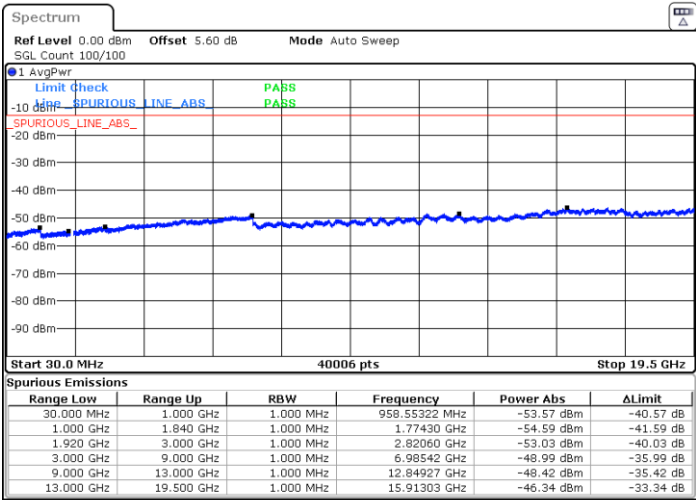

Date: 3.MAR.2021 15:32:33

Date: 3.MAR.2021 15:33:50

Highest Channel / QPSK

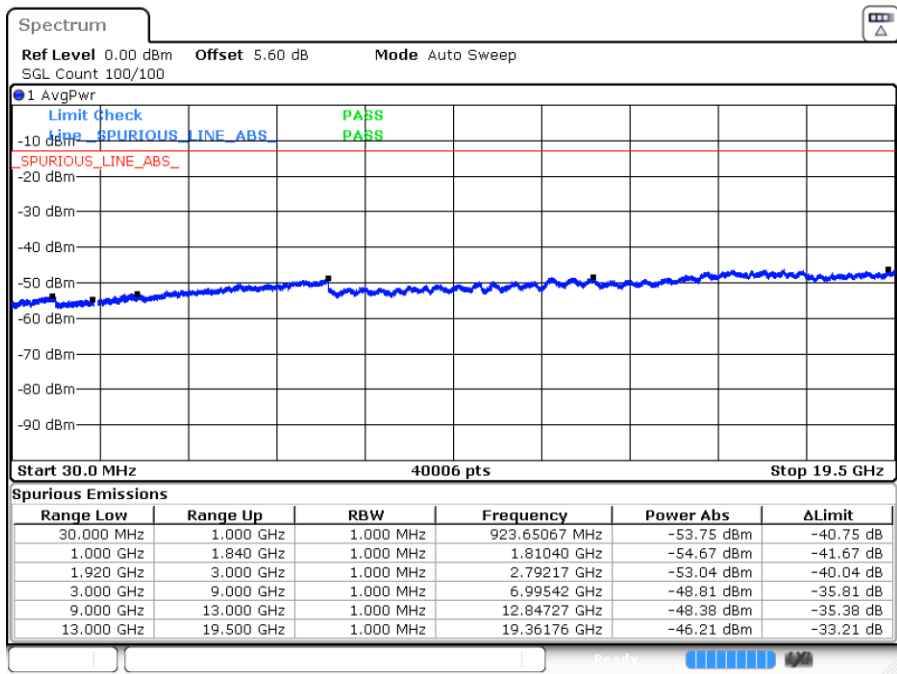

Date: 3.MAR.2021 15:34:36



LTE Band 2 / 15MHz

Lowest Channel / QPSK

Middle Channel / QPSK

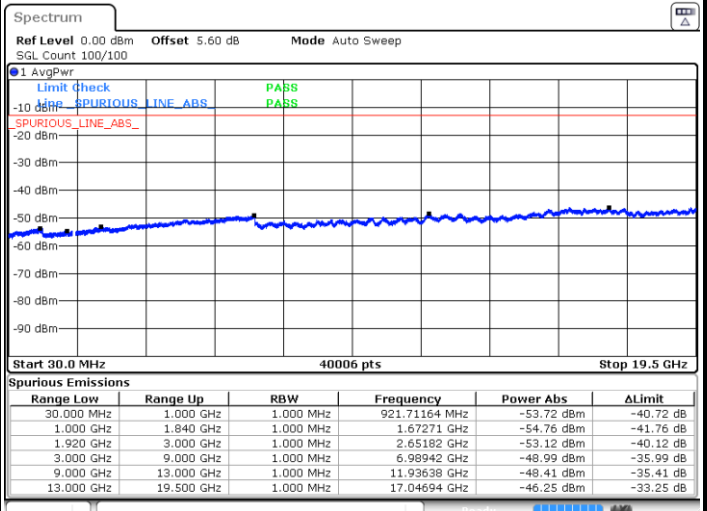
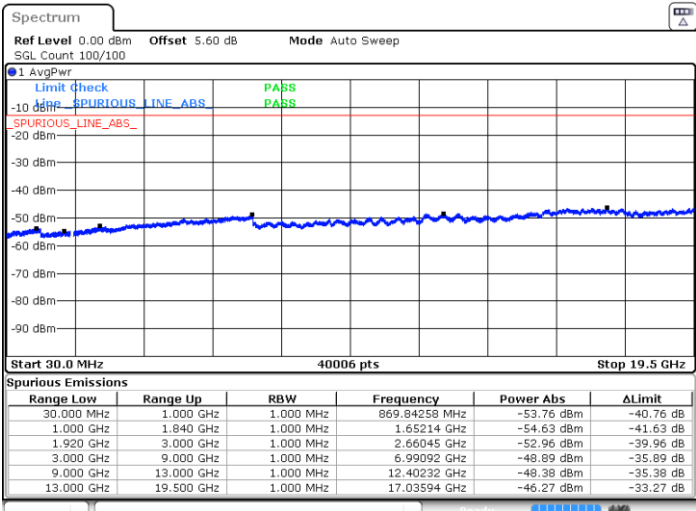

Date: 3.MAR.2021 15:35:36

Date: 3.MAR.2021 15:36:18

Highest Channel / QPSK

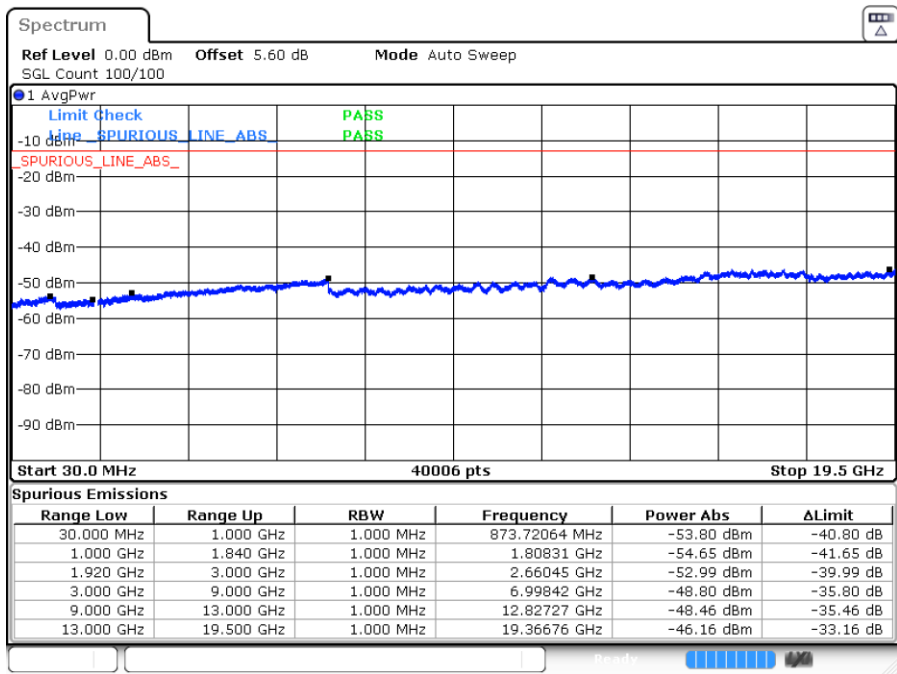

Date: 3.MAR.2021 15:37:01



LTE Band 2 / 20MHz

Lowest Channel / QPSK

Middle Channel / QPSK

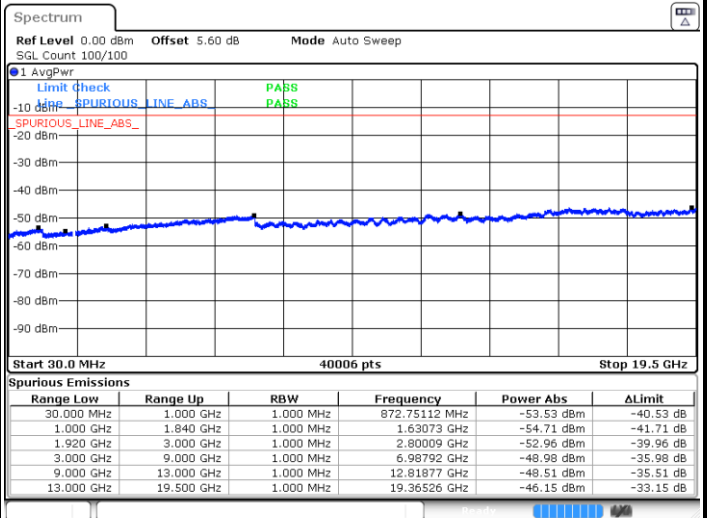
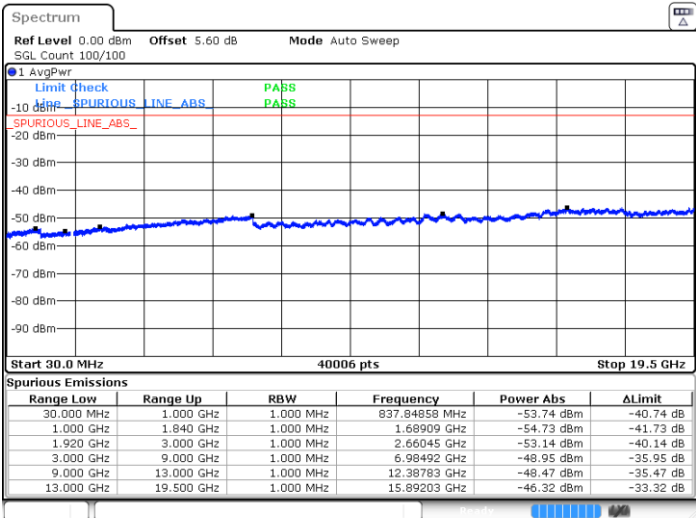

Date: 3.MAR.2021 15:37:48

Date: 3.MAR.2021 15:38:30

Highest Channel / QPSK

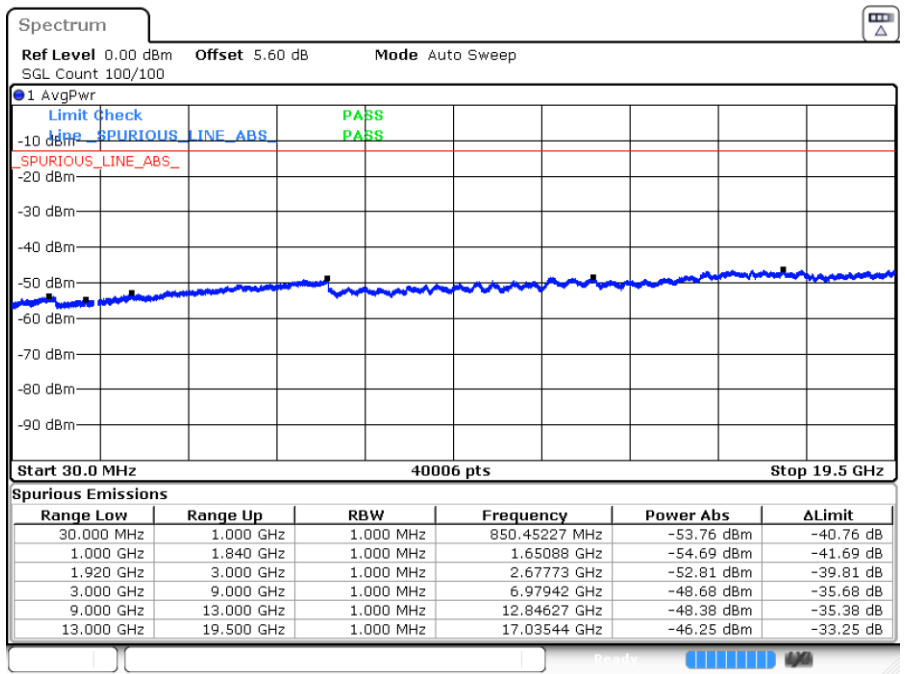

Date: 3.MAR.2021 15:39:20



Frequency Stability

Test Conditions		LTE Band 2 (QPSK) / Middle Channel	Limit
Temperature (°C)	Voltage (Volt)	BW 20MHz	Note 2.
		Deviation (ppm)	Result
50	Normal Voltage	0.0003	PASS
40	Normal Voltage	0.0022	
30	Normal Voltage	0.0001	
20(Ref.)	Normal Voltage	0.0000	
10	Normal Voltage	0.0013	
0	Normal Voltage	0.0007	
-10	Normal Voltage	0.0011	
-20	Normal Voltage	0.0026	
-30	Normal Voltage	0.0022	
20	Maximum Voltage	0.0001	
20	Normal Voltage	0.0000	
20	Battery End Point	0.0013	

Note:

1. Normal Voltage =3.86 V. ; Battery End Point (BEP) =3.5 V. ; Maximum Voltage =4.43 V.
2. Note: The frequency fundamental emissions stay within the authorized frequency block.



LTE Band 4

Peak-to-Average Ratio

Mode	LTE Band 4 / 20MHz			
Mod.	QPSK	16QAM	-	Limit: 13dB
RB Size	Full RB	Full RB	-	Result
Middle CH	5.1	5.94	-	PASS

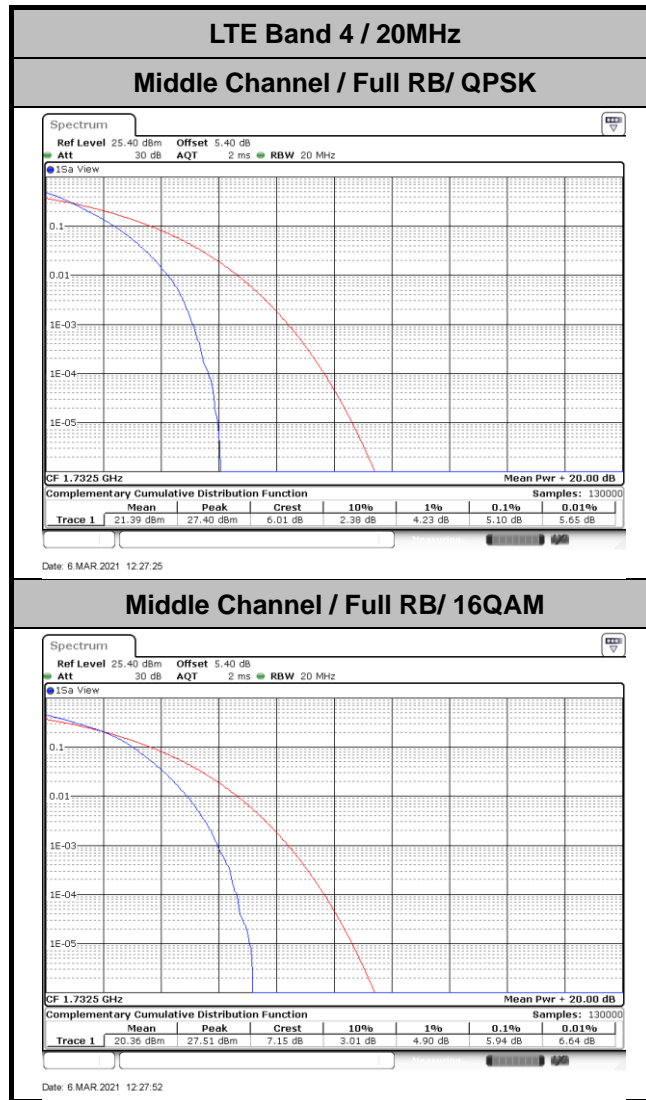



26dB Bandwidth

Mode	LTE Band 4 : 26dB BW(MHz)	
BW	20MHz	
Mod.	QPSK	16QAM
Middle CH	18.74	18.86

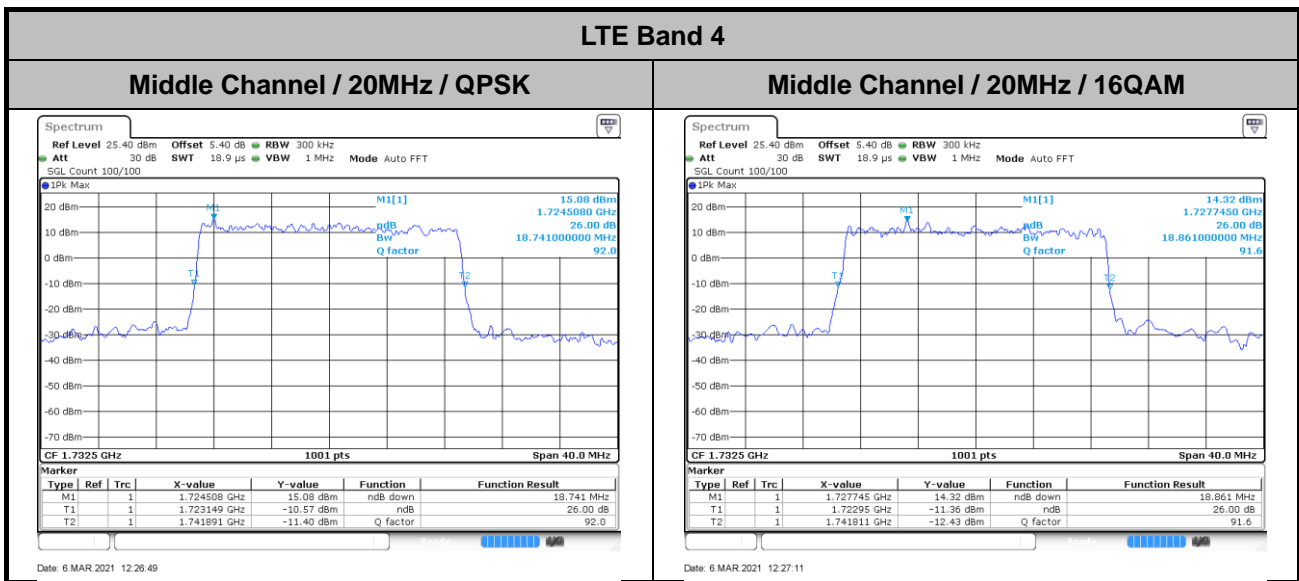



Occupied Bandwidth

Mode	LTE Band 4 : 99%OBW(MHz)	
BW	20MHz	
Mod.	QPSK	16QAM
Middle CH	17.86	17.94

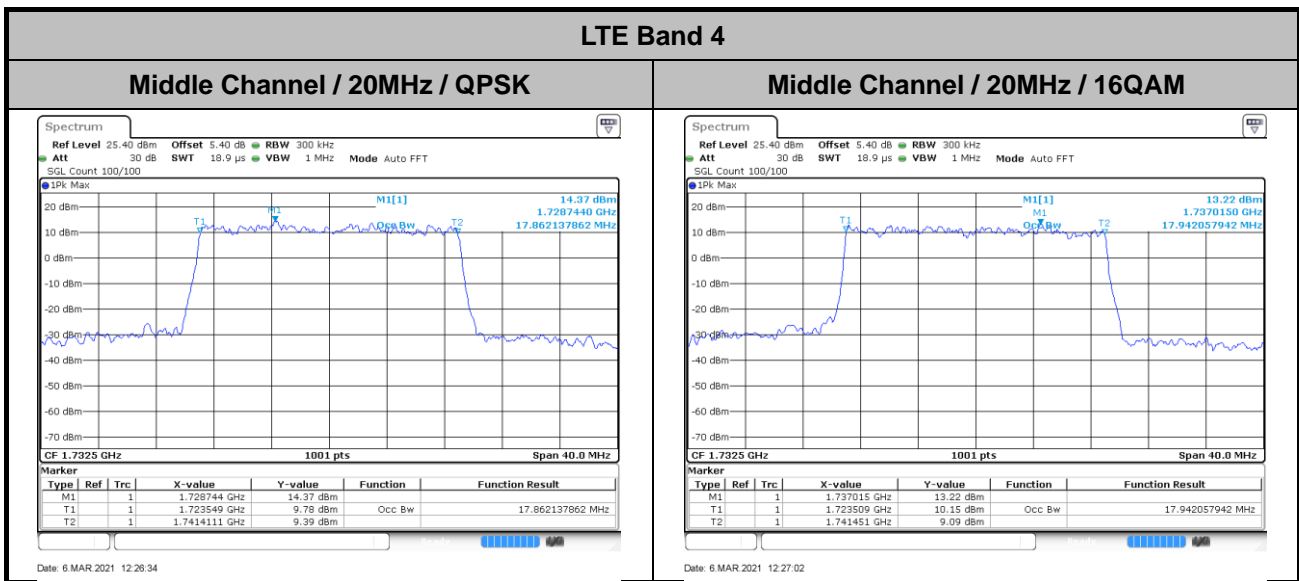



Conducted Band Edge

