

FCC SAR TEST REPORT

APPLICANT : Lenovo (Shanghai) Electronics Technology Co., Ltd.
EQUIPMENT : Portable Tablet Computer
BRAND NAME : Lenovo
Model Name : Lenovo TB-8505X
FCC ID : O57TB8505X
STANDARD : FCC 47 CFR PART 2 (2.1093)

We, Sporton International Inc. (Kunshan), would like to declare that the tested sample has been evaluated in accordance with the test procedures given in 47 CFR Part 2.1093 and FCC KDB and has been in compliance with the applicable technical standards.

The test results in this report apply exclusively to the tested model / sample. Without written approval of Sporton International Inc. (Kunshan), the test report shall not be reproduced except in full.



Approved by: Si Zhang

Sporton International Inc. (Kunshan)

**No. 1098, Pengxi North Road, Kunshan Economic Development Zone Jiangsu Province 215300
People's Republic of China**



Table of Contents

1. Statement of Compliance 4
2. Administration Data 5
3. Guidance Applied..... 5
4. Equipment Under Test (EUT) Information..... 6
4.1 General Information 6
4.2 General LTE SAR Test and Reporting Considerations 7
5. Proximity Sensor Triggering Test..... 9
6. RF Exposure Limits.....19
6.1 Uncontrolled Environment.....19
6.2 Controlled Environment.....19
7. Specific Absorption Rate (SAR).....20
7.1 Introduction20
7.2 SAR Definition.....20
8. System Description and Setup21
8.1 E-Field Probe22
8.2 Data Acquisition Electronics (DAE)22
8.3 Phantom.....23
8.4 Device Holder.....24
9. Measurement Procedures25
9.1 Spatial Peak SAR Evaluation.....25
9.2 Power Reference Measurement.....26
9.3 Area Scan26
9.4 Zoom Scan.....27
9.5 Volume Scan Procedures.....27
9.6 Power Drift Monitoring.....27
10. Test Equipment List.....28
11. System Verification29
11.1 Tissue Simulating Liquids.....29
11.2 Tissue Verification30
11.3 System Performance Check Results31
12. RF Exposure Positions32
12.1 SAR Testing for Tablet.....32
13. Conducted RF Output Power (Unit: dBm).....33
14. SAR Test Results41
14.1 Body SAR41
14.2 Repeated SAR Measurement42
15. Uncertainty Assessment43
16. References44
Appendix A. Plots of System Performance Check
Appendix B. Plots of High SAR Measurement
Appendix C. DASy Calibration Certificate
Appendix D. Test Setup Photos
Appendix E. Conducted RF Output Power Table



History of this test report

Report No.	Version	Description	Issued Date
FA981204-22	01	Initial issue of report	Jun. 19, 2022



1. Statement of Compliance

The maximum results of Specific Absorption Rate (SAR) found during testing for **Lenovo (Shanghai) Electronics Technology Co., Ltd., Portable Tablet Computer, Lenovo TB-8505X**, are as follows.

Highest Standalone 1g SAR Summary			
Equipment Class	Frequency Band		Body
			1g SAR (W/kg)
Licensed	GSM	GSM850	0.94
		GSM1900	1.09
	WCDMA	Band V	0.90
		Band II	0.85
	LTE	Band 2	0.88
		Band 4	0.79
		Band 5	0.93
		Band 7	0.73
		Band 38	0.85
		DTS	WLAN
NII	5GHz WLAN	0.72	
DSS	Bluetooth	Bluetooth	0.24
Date of Testing:		2022/5/18~2022/6/2	

Remark: This is a variant report for Lenovo TB-8505X. The difference between them could be referred to the Lenovo TB-8505X_Class II Permissive Change letter which is exhibited separately. According to the change, reduced some WWAN bands conducted power by software, so re-measured all WWAN bands conducted power, and the worse cases from original report (Sporton Report Number FA981204-21) were verified for difference.

Declaration of Conformity:
The test results with all measurement uncertainty excluded are presented in accordance with the regulation limits or requirements declared by manufacturers.
Comments and Explanations:
The declared of product specification for EUT presented in the report are provided by the manufacturer, and the manufacturer takes all the responsibilities for the accuracy of product specification.

This device is in compliance with Specific Absorption Rate (SAR) for general population/uncontrolled exposure limits (1.6 W/kg for Partial-Body 1g SAR) specified in FCC 47 CFR part 2 (2.1093) and ANSI/IEEE C95.1-1992, and had been tested in accordance with the measurement methods and procedures specified in IEEE 1528-2013 and FCC KDB publications



2. Administration Data

Sporton International Inc. (Kunshan) is accredited to ISO/IEC 17025:2017 by American Association for Laboratory Accreditation with Certificate Number 5145.02.

Testing Laboratory			
Test Firm	Sporton International Inc. (Kunshan)		
Test Site Location	No. 1098, Pengxi North Road, Kunshan Economic Development Zone Jiangsu Province 215300 People's Republic of China TEL : +86-512-57900158 FAX : +86-512-57900958		
Test Site No.	Sporton Site No.	FCC Designation No.	FCC Test Firm Registration No.
	SAR05-KS	CN1257	314309

Applicant	
Company Name	Lenovo (Shanghai) Electronics Technology Co., Ltd.
Address	Section 304-305, Building No. 4, # 222, Meiyue Road, China (Shanghai) Pilot Free Trade Zone

Manufacturer	
Company Name	Lenovo PC HK Limited
Address	23/F, Lincoln House, Taikoo Place 979 King's Road, Quarry Bay, Hong Kong, China

3. Guidance Applied

The Specific Absorption Rate (SAR) testing specification, method, and procedure for this device is in accordance with the following standards:

- FCC 47 CFR Part 2 (2.1093)
- ANSI/IEEE C95.1-1992
- IEEE 1528-2013
- FCC KDB 865664 D01 SAR Measurement 100 MHz to 6 GHz v01r04
- FCC KDB 865664 D02 SAR Reporting v01r02
- FCC KDB 447498 D01 General RF Exposure Guidance v06
- FCC KDB 248227 D01 802.11 Wi-Fi SAR v02r02
- FCC KDB 616217 D04 SAR for laptop and tablets v01r02
- FCC KDB 941225 D01 3G SAR Procedures v03r01
- FCC KDB 941225 D05 SAR for LTE Devices v02r05

4. Equipment Under Test (EUT) Information

4.1 General Information

Product Feature & Specification	
Equipment Name	Portable Tablet Computer
Brand Name	Lenovo
Model Name	Lenovo TB-8505X
FCC ID	O57TB8505X
IMEI Code	862854054460768
Wireless Technology and Frequency Range	GSM850: 824.2 MHz ~ 848.8 MHz GSM1900: 1850.2 MHz ~ 1909.8 MHz WCDMA Band II: 1852.4 MHz ~ 1907.6 MHz WCDMA Band V: 826.4 MHz ~ 846.6 MHz LTE Band 2: 1850.7 MHz ~ 1909.3 MHz LTE Band 4: 1710.7 MHz ~ 1754.3 MHz LTE Band 5: 824.7 MHz ~ 848.3 MHz LTE Band 7: 2502.5 MHz ~ 2567.5 MHz LTE Band 38: 2572.5 MHz ~ 2617.5 MHz WLAN 2.4GHz Band: 2412 MHz ~ 2462 MHz WLAN 5.2GHz Band: 5180 MHz ~ 5240 MHz WLAN 5.3GHz Band: 5260 MHz ~ 5320 MHz WLAN 5.5GHz Band: 5500 MHz ~ 5700 MHz WLAN 5.8GHz Band: 5745 MHz ~ 5825 MHz Bluetooth: 2402 MHz ~ 2480 MHz
Mode	GSM/GPRS/EGPRS RMC/AMR 12.2Kbps HSDPA HSUPA DC-HSDPA HSPA+ (16QAM uplink is not supported) LTE: QPSK, 16QAM, 64QAM WLAN 2.4GHz 802.11b/g/n HT20/HT40 WLAN 5GHz 802.11a/n HT20/HT40 WLAN 5GHz 802.11ac VHT20/VHT40/VHT80 Bluetooth BR/EDR/LE
HW Version	Lenovo TB-8505X
SW Version	TB-8505X_RF01_220408
EUT Stage	Identical Prototype
Remark: <ol style="list-style-type: none"> This device has voice function, but limited to speakerphone mode. This device does not support DTM operation and supports GRPS/EGRPS mode up to multi-slot class 12. The device employs proximity sensors that detect the presence of the user's body also a finger or hand near the bottom face, edge 1 or edge 4 of the device, reduced power will be active for all WWAN bands. The device employs proximity sensors that detect the presence of the user's body also a finger or hand near the bottom face, edge 1 or edge 2 of the device, reduced power will be active for all WLAN bands. 	



4.2 General LTE SAR Test and Reporting Considerations

Summarized necessary items addressed in KDB 941225 D05 v02r05																																																															
FCC ID	O57TB8505X																																																														
Equipment Name	Portable Tablet Computer																																																														
Operating Frequency Range of each LTE transmission band	LTE Band 2: 1850.7 MHz ~ 1909.3 MHz LTE Band 4: 1710.7 MHz ~ 1754.3 MHz LTE Band 5: 824.7 MHz ~ 848.3 MHz LTE Band 7: 2502.5 MHz ~ 2567.5 MHz LTE Band 38: 2572.5 MHz ~ 2617.5 MHz																																																														
Channel Bandwidth	LTE Band 2: 1.4MHz, 3MHz, 5MHz, 10MHz, 15MHz, 20MHz LTE Band 4: 1.4MHz, 3MHz, 5MHz, 10MHz, 15MHz, 20MHz LTE Band 5: 1.4MHz, 3MHz, 5MHz, 10MHz LTE Band 7: 5MHz, 10MHz, 15MHz, 20MHz LTE Band 38: 5MHz, 10MHz, 15MHz, 20MHz																																																														
uplink modulations used	QPSK / 16QAM / 64QAM																																																														
LTE release	R10, Cat 4																																																														
CA support	No																																																														
LTE Voice / Data requirements	Voice and Data																																																														
LTE MPR permanently built-in by design	<p>Table 6.2.3-1: Maximum Power Reduction (MPR) for Power Class 1, 2 and 3</p> <table border="1"> <thead> <tr> <th rowspan="2">Modulation</th> <th colspan="6">Channel bandwidth / Transmission bandwidth (N_{RB})</th> <th rowspan="2">MPR (dB)</th> </tr> <tr> <th>1.4 MHz</th> <th>3.0 MHz</th> <th>5 MHz</th> <th>10 MHz</th> <th>15 MHz</th> <th>20 MHz</th> </tr> </thead> <tbody> <tr> <td>QPSK</td> <td>> 5</td> <td>> 4</td> <td>> 8</td> <td>> 12</td> <td>> 16</td> <td>> 18</td> <td>≤ 1</td> </tr> <tr> <td>16 QAM</td> <td>≤ 5</td> <td>≤ 4</td> <td>≤ 8</td> <td>≤ 12</td> <td>≤ 16</td> <td>≤ 18</td> <td>≤ 1</td> </tr> <tr> <td>16 QAM</td> <td>> 5</td> <td>> 4</td> <td>> 8</td> <td>> 12</td> <td>> 16</td> <td>> 18</td> <td>≤ 2</td> </tr> <tr> <td>64 QAM</td> <td>≤ 5</td> <td>≤ 4</td> <td>≤ 8</td> <td>≤ 12</td> <td>≤ 16</td> <td>≤ 18</td> <td>≤ 2</td> </tr> <tr> <td>64 QAM</td> <td>> 5</td> <td>> 4</td> <td>> 8</td> <td>> 12</td> <td>> 16</td> <td>> 18</td> <td>≤ 3</td> </tr> <tr> <td>256 QAM</td> <td colspan="6">≥ 1</td> <td>≤ 5</td> </tr> </tbody> </table>	Modulation	Channel bandwidth / Transmission bandwidth (N _{RB})						MPR (dB)	1.4 MHz	3.0 MHz	5 MHz	10 MHz	15 MHz	20 MHz	QPSK	> 5	> 4	> 8	> 12	> 16	> 18	≤ 1	16 QAM	≤ 5	≤ 4	≤ 8	≤ 12	≤ 16	≤ 18	≤ 1	16 QAM	> 5	> 4	> 8	> 12	> 16	> 18	≤ 2	64 QAM	≤ 5	≤ 4	≤ 8	≤ 12	≤ 16	≤ 18	≤ 2	64 QAM	> 5	> 4	> 8	> 12	> 16	> 18	≤ 3	256 QAM	≥ 1						≤ 5
Modulation	Channel bandwidth / Transmission bandwidth (N _{RB})						MPR (dB)																																																								
	1.4 MHz	3.0 MHz	5 MHz	10 MHz	15 MHz	20 MHz																																																									
QPSK	> 5	> 4	> 8	> 12	> 16	> 18	≤ 1																																																								
16 QAM	≤ 5	≤ 4	≤ 8	≤ 12	≤ 16	≤ 18	≤ 1																																																								
16 QAM	> 5	> 4	> 8	> 12	> 16	> 18	≤ 2																																																								
64 QAM	≤ 5	≤ 4	≤ 8	≤ 12	≤ 16	≤ 18	≤ 2																																																								
64 QAM	> 5	> 4	> 8	> 12	> 16	> 18	≤ 3																																																								
256 QAM	≥ 1						≤ 5																																																								
LTE A-MPR	In the base station simulator configuration, Network Setting value is set to NS_01 to disable A-MPR during SAR testing and the LTE SAR tests was transmitting on all TTI frames (Maximum TTI)																																																														
Spectrum plots for RB configuration	A properly configured base station simulator was used for the SAR and power measurement; therefore, spectrum plots for each RB allocation and offset configuration are not included in the SAR report.																																																														
Power reduction applied to satisfy SAR compliance	Yes, Proximity Sensor. Power reduction will be active at bottom face , edge 1 and edge 4 for all WWAN bands.																																																														



Transmission (H, M, L) channel numbers and frequencies in each LTE band												
LTE Band 2												
	Bandwidth 1.4 MHz		Bandwidth 3 MHz		Bandwidth 5 MHz		Bandwidth 10 MHz		Bandwidth 15 MHz		Bandwidth 20 MHz	
	Ch. #	Freq. (MHz)	Ch. #	Freq. (MHz)	Ch. #	Freq. (MHz)	Ch. #	Freq. (MHz)	Ch. #	Freq. (MHz)	Ch. #	Freq. (MHz)
L	18607	1850.7	18615	1851.5	18625	1852.5	18650	1855	18675	1857.5	18700	1860
M	18900	1880	18900	1880	18900	1880	18900	1880	18900	1880	18900	1880
H	19193	1909.3	19185	1908.5	19175	1907.5	19150	1905	19125	1902.5	19100	1900
LTE Band 4												
	Bandwidth 1.4 MHz		Bandwidth 3 MHz		Bandwidth 5 MHz		Bandwidth 10 MHz		Bandwidth 15 MHz		Bandwidth 20 MHz	
	Ch. #	Freq. (MHz)	Ch. #	Freq. (MHz)	Ch. #	Freq. (MHz)	Ch. #	Freq. (MHz)	Ch. #	Freq. (MHz)	Ch. #	Freq. (MHz)
L	19957	1710.7	19965	1711.5	19975	1712.5	20000	1715	20025	1717.5	20050	1720
M	20175	1732.5	20175	1732.5	20175	1732.5	20175	1732.5	20175	1732.5	20175	1732.5
H	20393	1754.3	20385	1753.5	20375	1752.5	20350	1750	20325	1747.5	20300	1745
LTE Band 5												
	Bandwidth 1.4 MHz		Bandwidth 3 MHz		Bandwidth 5 MHz		Bandwidth 10 MHz					
	Ch. #	Freq. (MHz)	Ch. #	Freq. (MHz)	Ch. #	Freq. (MHz)	Ch. #	Freq. (MHz)	Ch. #	Freq. (MHz)	Ch. #	Freq. (MHz)
L	20407	824.7	20415	825.5	20425	826.5	20450	829				
M	20525	836.5	20525	836.5	20525	836.5	20525	836.5				
H	20643	848.3	20635	847.5	20625	846.5	20600	844				
LTE Band 7												
	Bandwidth 5 MHz		Bandwidth 10 MHz		Bandwidth 15 MHz		Bandwidth 20 MHz					
	Ch. #	Freq. (MHz)	Ch. #	Freq. (MHz)	Ch. #	Freq. (MHz)	Ch. #	Freq. (MHz)	Ch. #	Freq. (MHz)	Ch. #	Freq. (MHz)
L	20775	2502.5	20800	2505	20825	2507.5	20850	2510				
M	21100	2535	21100	2535	21100	2535	21100	2535				
H	21425	2567.5	21400	2565	21375	2562.5	21350	2560				
LTE Band 38												
	Bandwidth 5 MHz		Bandwidth 10 MHz		Bandwidth 15 MHz		Bandwidth 20 MHz					
	Ch. #	Freq. (MHz)	Ch. #	Freq. (MHz)	Ch. #	Freq. (MHz)	Ch. #	Freq. (MHz)	Ch. #	Freq. (MHz)	Ch. #	Freq. (MHz)
L	37775	2572.5	37800	2575	37825	2577.5	37850	2580				
M	38000	2595	38000	2595	38000	2595	38000	2595				
H	38225	2617.5	38200	2615	38175	2612.5	38150	2610				

5. Proximity Sensor Triggering Test

<Proximity Sensor Triggering Distance (KDB 616217 D04 section 6.2)>:

1. Proximity sensor triggering distance testing was performed according to the procedures outlined in KDB 616217 D04 section 6.2, and EUT moving further away from the flat phantom and EUT moving toward the flat phantom were both assessed and the tissue-equivalent medium for highest frequency 5850MHz and lowest 850MHz frequency was used for proximity sensor triggering testing.
2. Capacitive proximity sensor placed coincident with antenna elements at the Bottom Face, Edge 1 and Edge 4 of the device are utilized to determine when the device comes in proximity of the user’s body at the Bottom Face, Edge 1 or Edge 4 side of the device for WWAN. There is no need to do sensor coverage testing for the proximity sensor is designed to support sufficient detection range and sensitivity to cover regions of the sensors in all applicable directions since the proximity sensor entirely covers the antenna.
3. Capacitive proximity sensor placed coincident with antenna elements at the Bottom Face, Edge 1 and Edge 2 of the device are utilized to determine when the device comes in proximity of the user’s body at the Bottom Face, Edge 1 or Edge 2 side of the device for WLAN. There is no need to do sensor coverage testing for the proximity sensor is designed to support sufficient detection range and sensitivity to cover regions of the sensors in all applicable directions since the proximity sensor entirely covers the antenna.
4. When the sensor is active, WLAN 2.4GHz / WLAN 5.2GHz / WLAN 5.3GHz / WLAN 5.5GHz / WLAN 5.8GHz reduced power will be active.
5. When the sensor is active, GSM850/1900, WCDMA Band II/V, LTE Band 2/4/5/7/38 reduced power will be active.
6. The sensors used to detect the proximity of the user’s body at the Bottom Face, Edge 4, Edge 2 or Edge 1 side of the device use a detection threshold distance. The data shown in the sections below shows the distance(s).

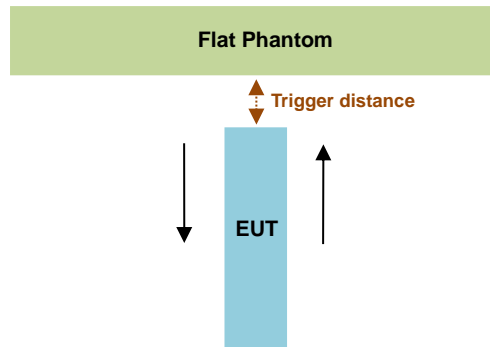

WWAN						
Proximity Sensor Triggering Distance (mm)						
Position	Bottom Face		Edge 1		Edge 4	
	Moving towards	Moving away	Moving towards	Moving away	Moving towards	Moving away
Minimum	12	16	20	21	10	12

WLAN						
Proximity Sensor Triggering Distance (mm)						
Position	Bottom Face		Edge 1		Edge 2	
	Moving towards	Moving away	Moving towards	Moving away	Moving towards	Moving away
Minimum	12	16	19	20	6	6

<Proximity Sensor Triggering Coverage (KDB 616217 D04 section 6.3)>:

If a sensor is spatially offset from the antenna(s), it is necessary to verify sensor triggering for conditions where the antenna is next to the user but the sensor is laterally further away to ensure sensor coverage is sufficient for reducing the power to maintain compliance. For p-sensor coverage testing, the device is moved and “along the direction of maximum antenna and sensor offset”.

Illustrated in the internal photo exhibit, although the sensor is spatially offset, there is no trigger condition where the antenna is next to the user but the sensor is laterally further away, therefore proximity sensor coverage testing is not required.

This procedure is not required because antenna and sensor are collocated and the peak SAR location is overlapping with the sensor.

<Tablet Tilt angle influences to proximity sensor triggering (KDB 616217 D04 section 6.4)>:

The influence of table tilt angles to proximity sensor triggering was determined by positioning each tablet edge that contains a transmitting antenna, perpendicular to the flat phantom, at 20mm for Edge 1 and 10 mm for Edge 4 separation for WWAN bands and at 19mm for Edge 1 and 6 mm for Edge 2 separation for WLAN bands.

Rotating the tablet around the edge next to the phantom in $\leq 10^\circ$ increments until the tablet is $\pm 45^\circ$ from the vertical position at 0° , and the maximum output power remains in the reduced mode.

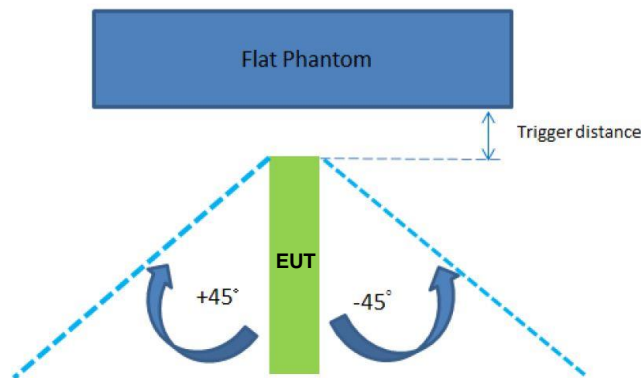

The Sensor Trigger Distance (mm)						
WWAN	Position	Edge 1	Edge 4	WLAN	Edge 1	Edge 2
	Minimum	20	10		19	6

Proximity sensor power reduction for WWAN bands

Exposure Position / wireless mode	Bottom Face ⁽¹⁾	Edge 1 ⁽¹⁾	Edge 2	Edge 3	Edge 4 ⁽¹⁾
GSM850 GPRS 4Tx slots	9.0 dB	9.0 dB	0 dB	0 dB	9.0 dB
GSM1900 GPRS 4Tx slots	9.5 dB	9.5 dB	0 dB	0 dB	9.5 dB
WCDMA Band V	5.5 dB	5.5 dB	0 dB	0 dB	5.5 dB
WCDMA Band II	8.5 dB	8.5 dB	0 dB	0 dB	8.5 dB
LTE Band 2	9.5 dB	9.5 dB	0 dB	0 dB	9.5 dB
LTE Band 4	7.0 dB	7.0 dB	0 dB	0 dB	7.0 dB
LTE Band 5	6.0 dB	6.0 dB	0 dB	0 dB	6.0 dB
LTE Band 7	9.5 dB	9.5 dB	0 dB	0 dB	9.5 dB
LTE Band 38	6.5 dB	6.5 dB	0 dB	0 dB	6.5 dB

Remark:

- ⁽¹⁾: Reduced maximum limit applied by activation of proximity sensor.
- Tests were performed in accordance with KDB 616217 D04 section 6.1, 6.2, 6.3, 6.4 and 6.5 and compliant results are shown and described in exhibit "P-Sensor operational description"
- For verification of compliance of power reduction scheme, additional SAR testing with EUT transmitting at full RF power at a conservative trigger distance was performed:
 - Bottom Face: 10 mm(manufacturer declared)
 - Edge 4: 8 mm(manufacturer declared)
 - Edge 1: 17 mm(manufacturer declared)

Proximity sensor power reduction for WLAN bands

Exposure Position / wireless mode	Bottom Face ⁽¹⁾	Edge 1 ⁽¹⁾	Edge 2 ⁽¹⁾	Edge 3	Edge 4
WLAN 2.4GHz	2.0 dB	2.0 dB	2.0 dB	0 dB	0 dB
WLAN 5.2GHz	4.0 dB	4.0 dB	4.0 dB	0 dB	0 dB
WLAN 5.3GHz	4.0 dB	4.0 dB	4.0 dB	0 dB	0 dB
WLAN 5.5GHz	4.0 dB	4.0 dB	4.0 dB	0 dB	0 dB
WLAN 5.8GHz	4.0 dB	4.0 dB	4.0 dB	0 dB	0 dB

Remark:

- ⁽¹⁾: Reduced maximum limit applied by activation of proximity sensor.
- Power reduction is not applicable for Bluetooth.
- Tests were performed in accordance with KDB 616217 D04 section 6.1, 6.2, 6.3, 6.4 and 6.5 and compliant results are shown and described in exhibit "P-Sensor operational description"
- For verification of compliance of power reduction scheme, additional SAR testing with EUT transmitting at full RF power at a conservative trigger distance was performed:
 - Bottom Face: 10 mm(manufacturer declared)
 - Edge 2: 17 mm(manufacturer declared)
 - Edge 1: 5 mm



Power Measurement during Sensor Trigger distance testing

Band/Mode	Measured power reduction (dBm)		Reduction Levels (dB)
	w/o power back-off	w/ power back-off	
GSM850 GPRS 4 Tx slots	30.00	21.00	9.00
GSM1900 GPRS 4 Tx slots	27.00	17.50	9.50
WCDMA Band V	24.50	19.00	5.50
WCDMA Band II	24.50	16.00	8.50
LTE Band 2	24.50	15.00	9.50
LTE Band 4	24.50	17.50	7.00
LTE Band 5	24.50	18.50	6.00
LTE Band 7	24.50	15.00	9.50
LTE Band 38	24.50	18.00	6.50
WLAN 2.4GHz	18.00	16.00	2.00
WLAN 5.2GHz	18.50	14.50	4.00
WLAN 5.3GHz	18.50	14.50	4.00
WLAN 5.5GHz	18.50	14.50	4.00
WLAN 5.8GHz	18.50	14.50	4.00

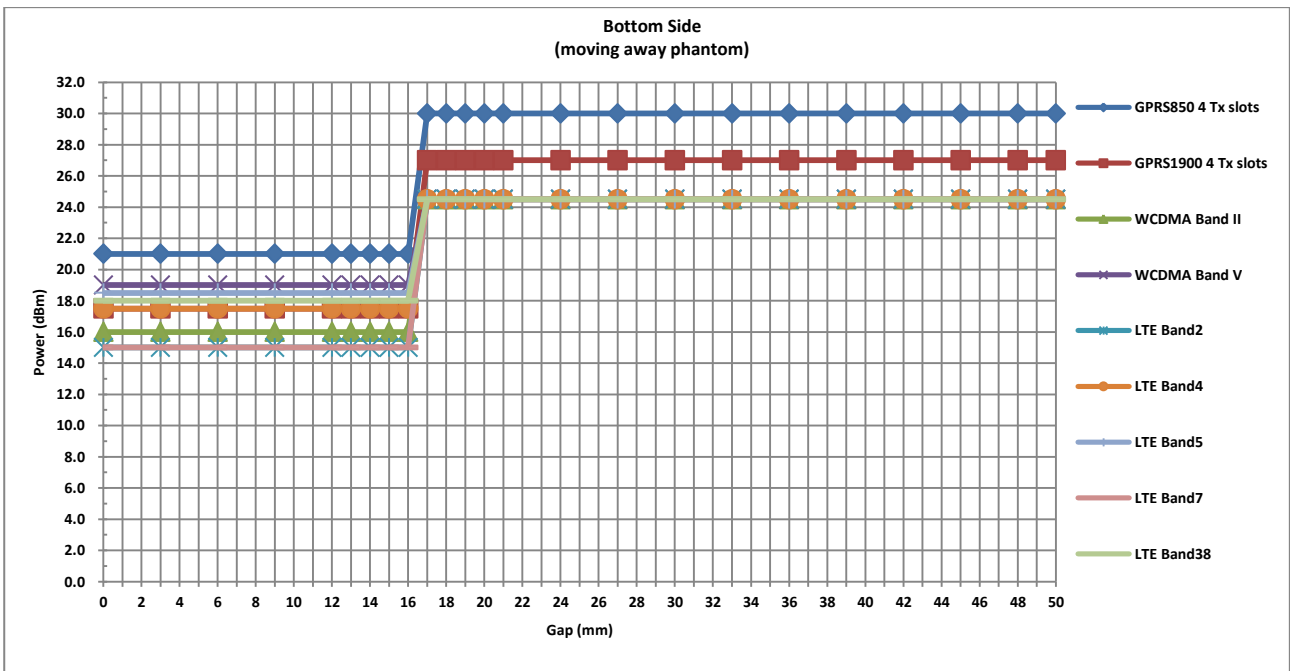
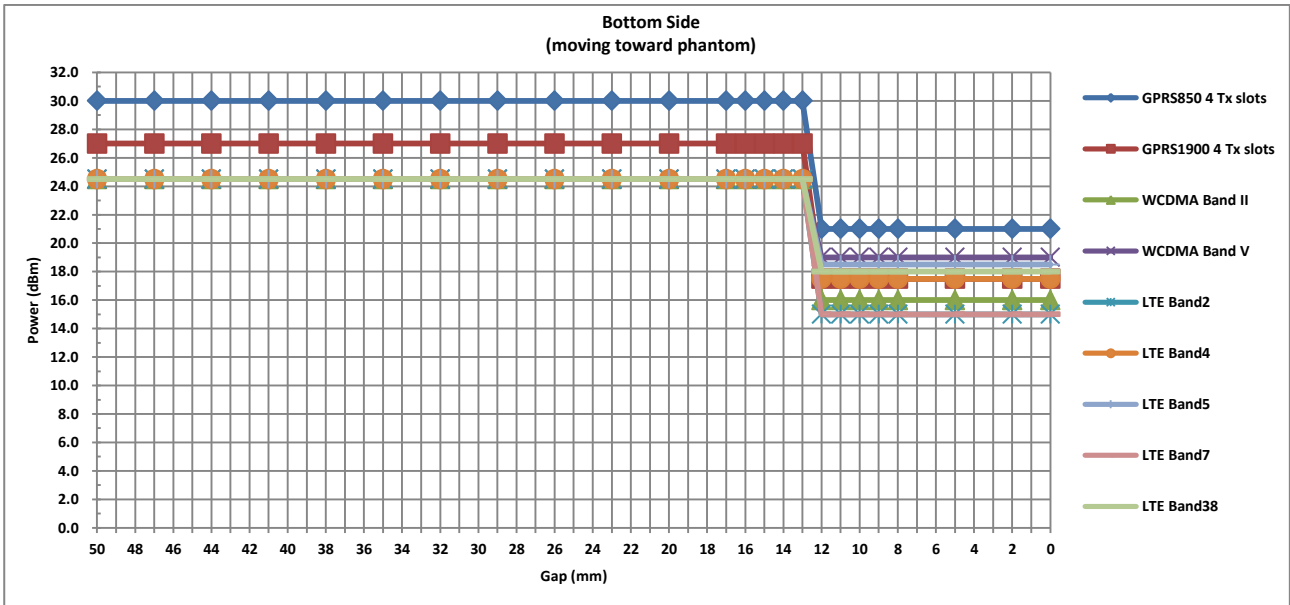

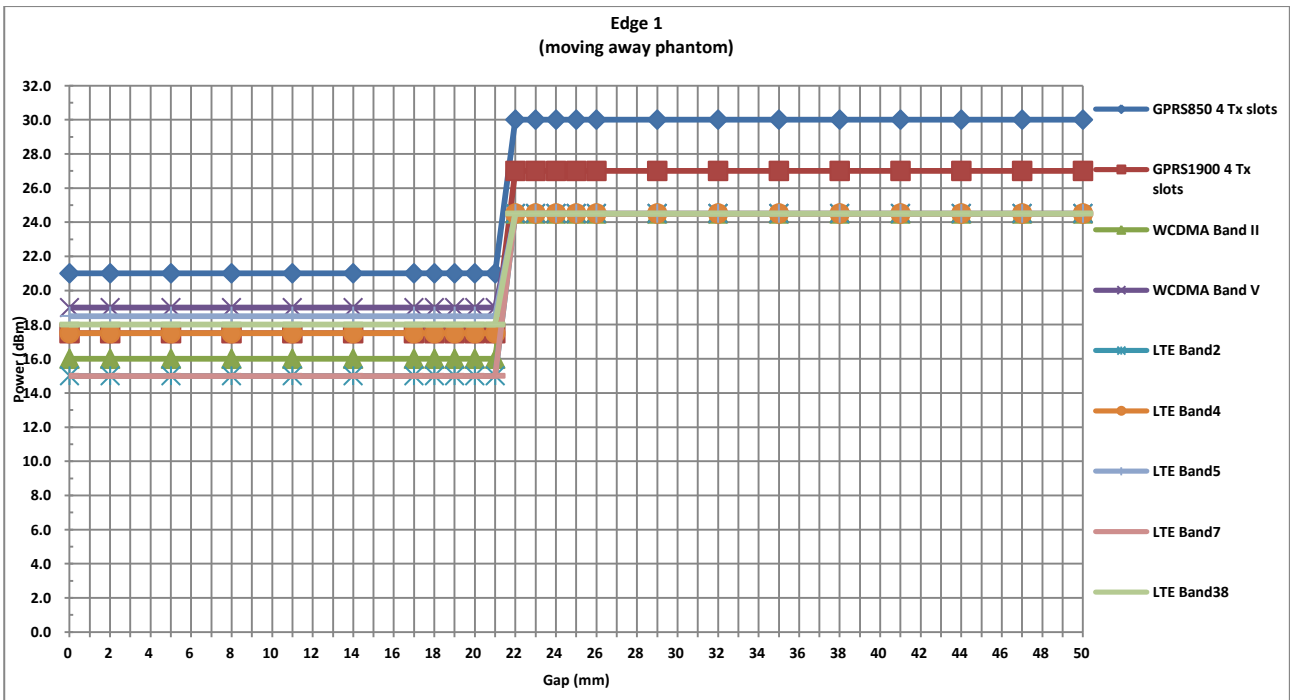
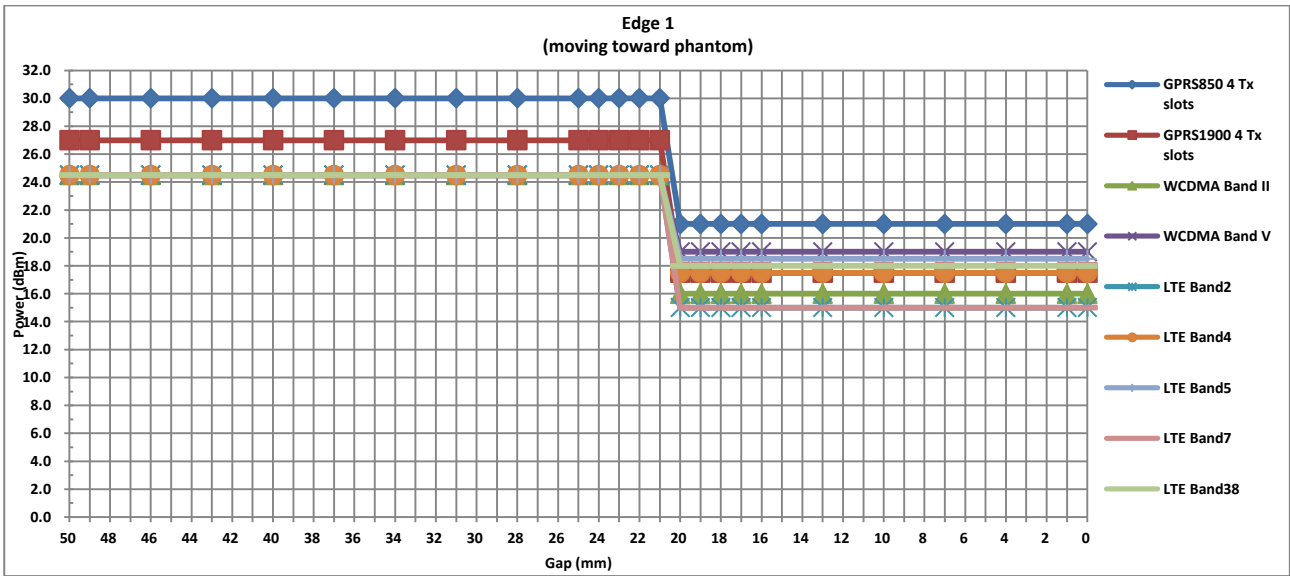

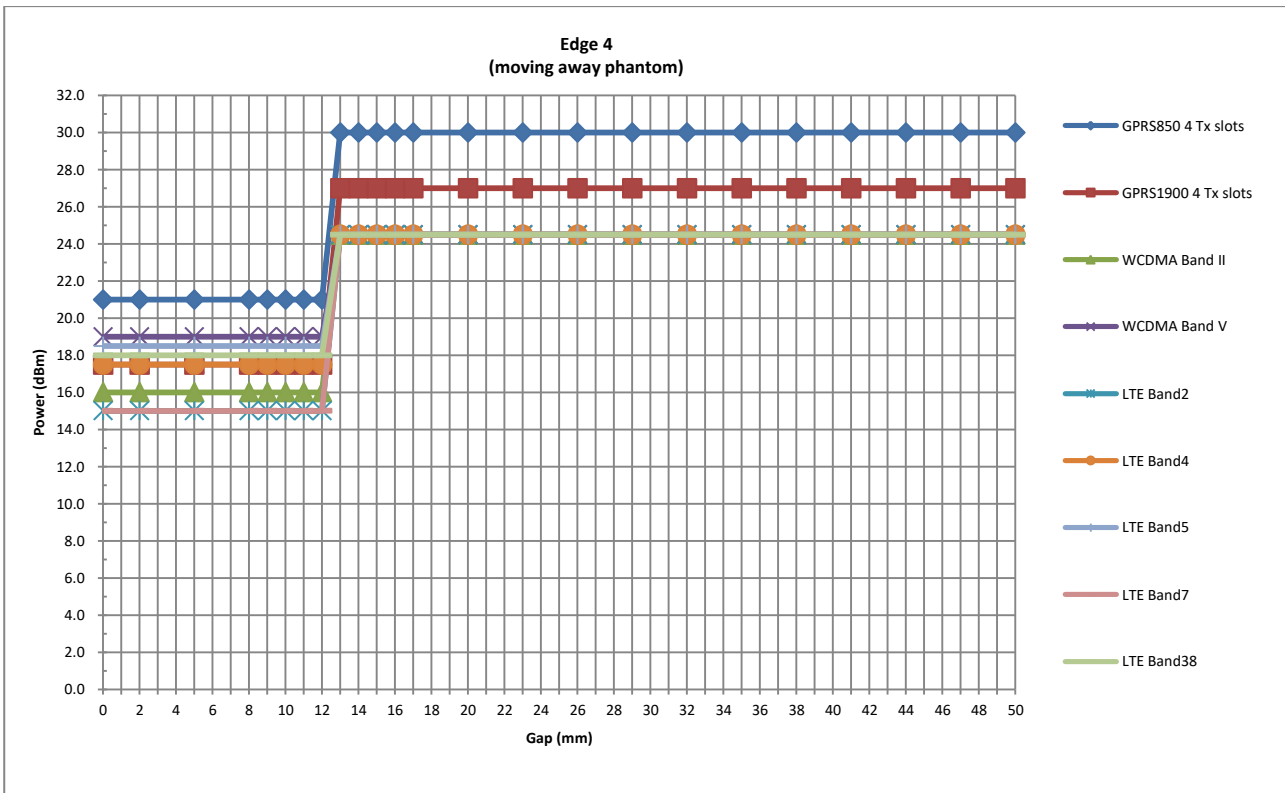
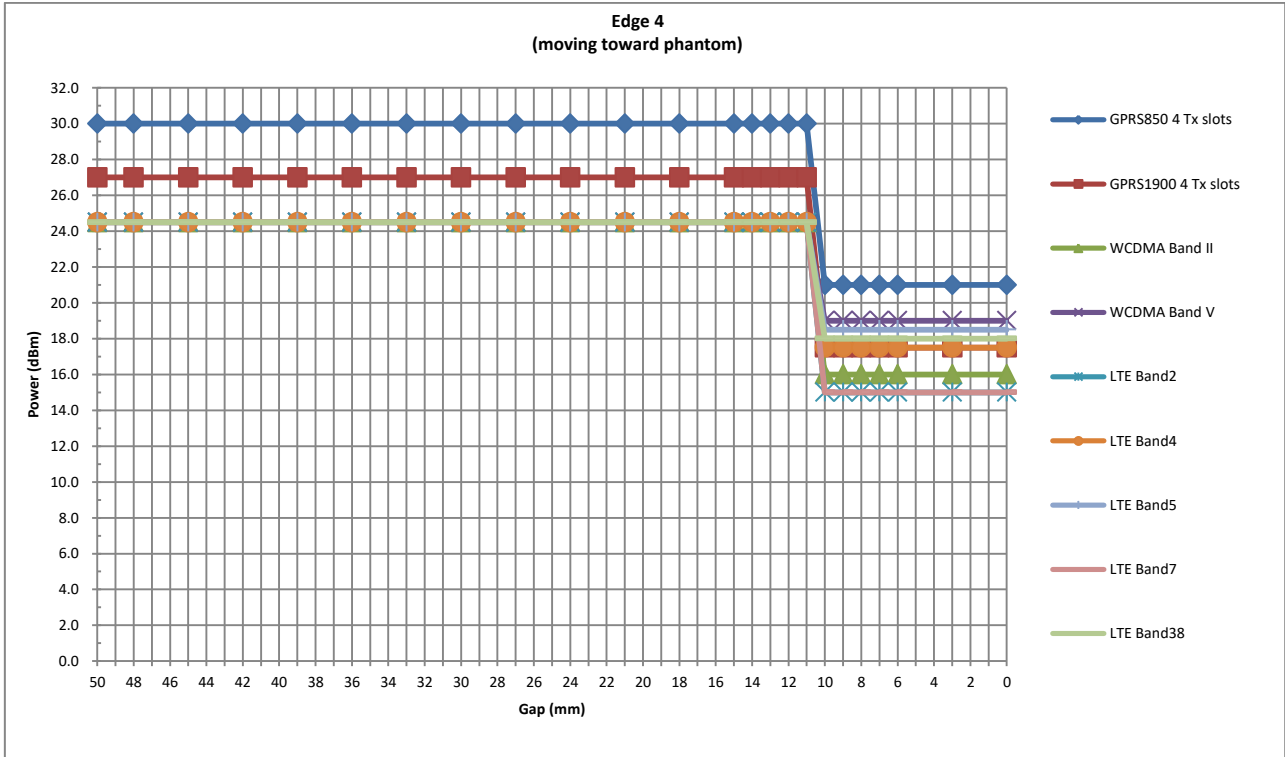

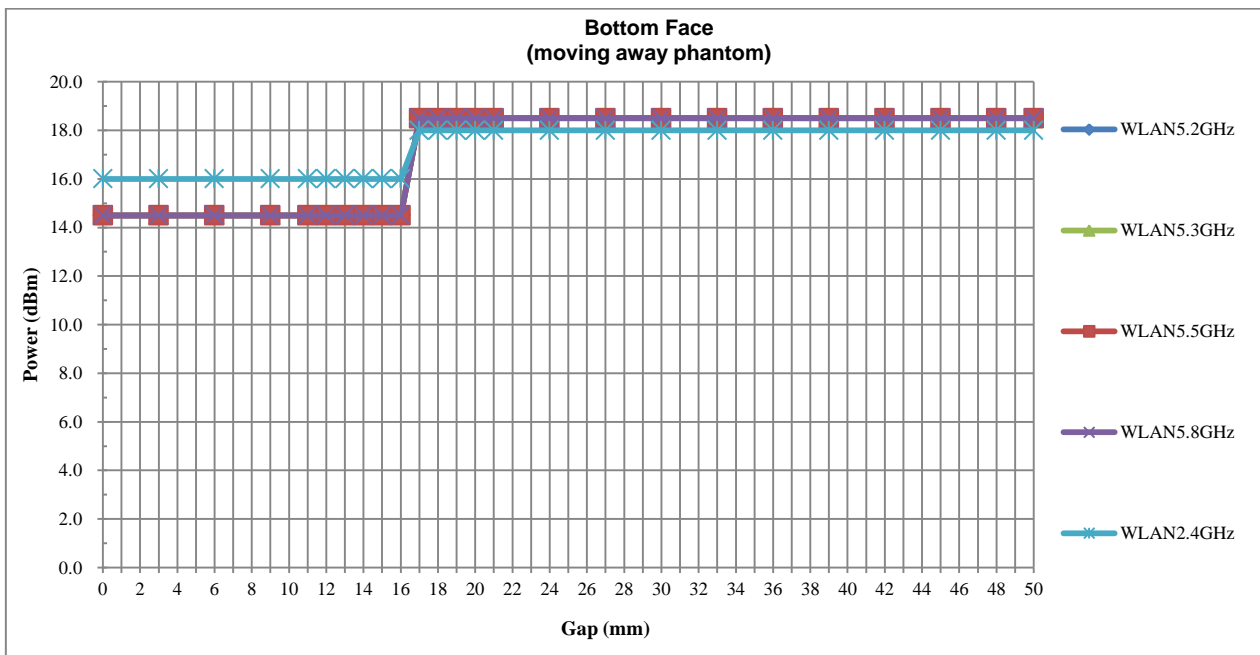
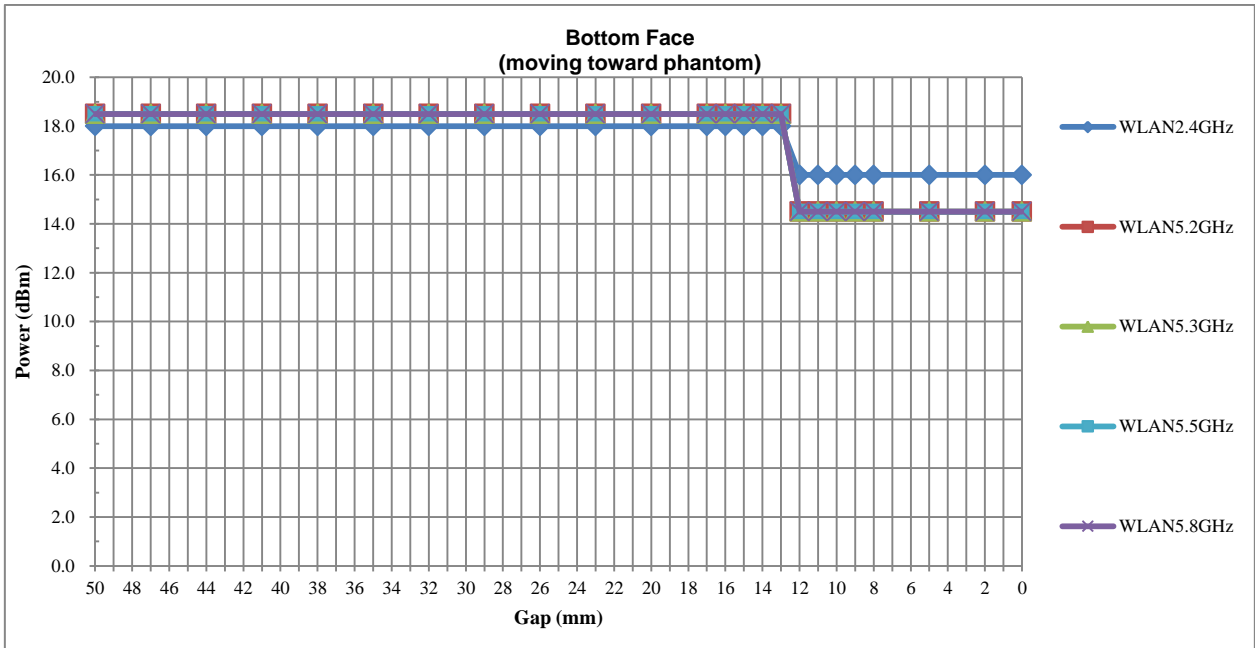

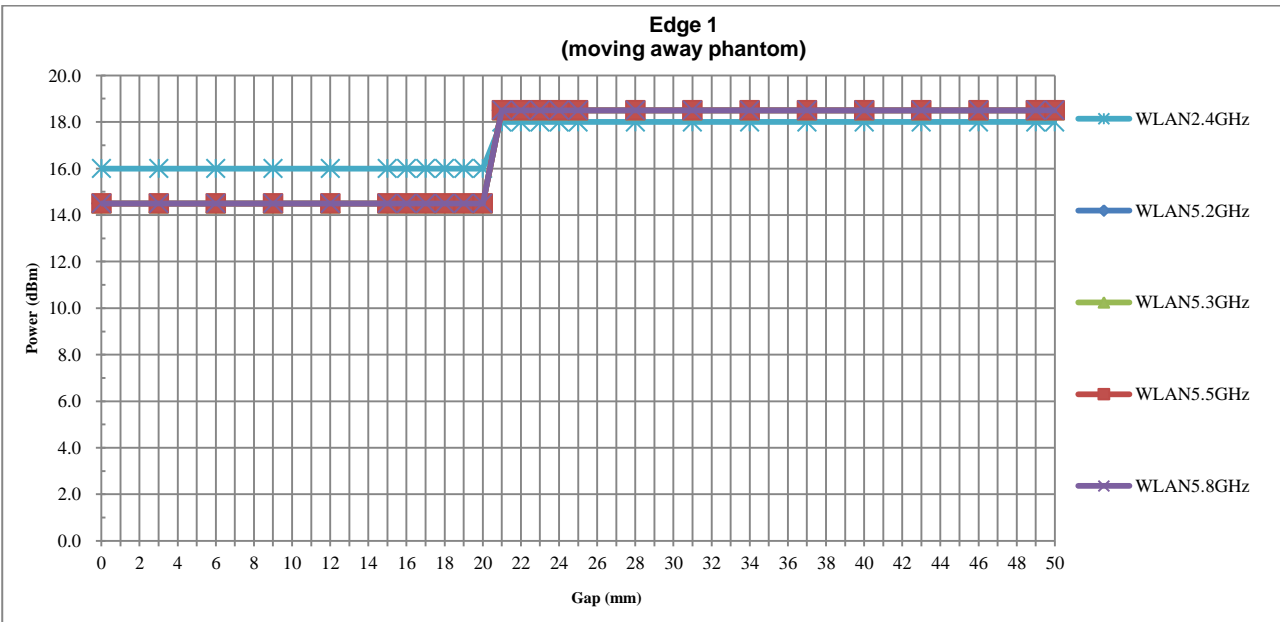
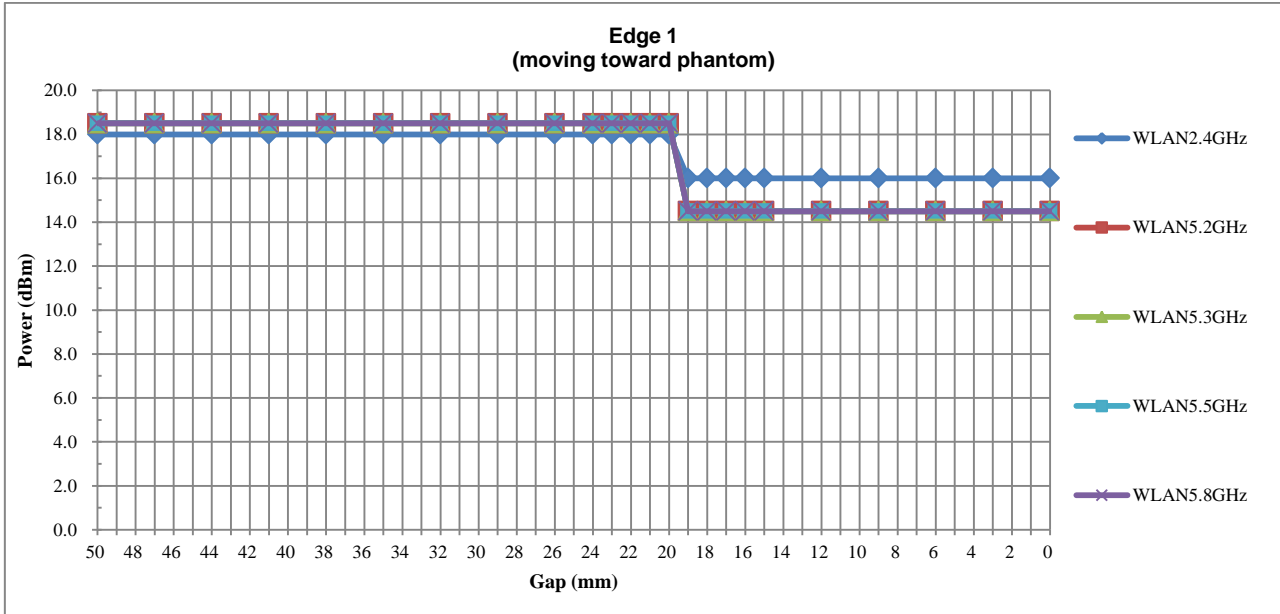

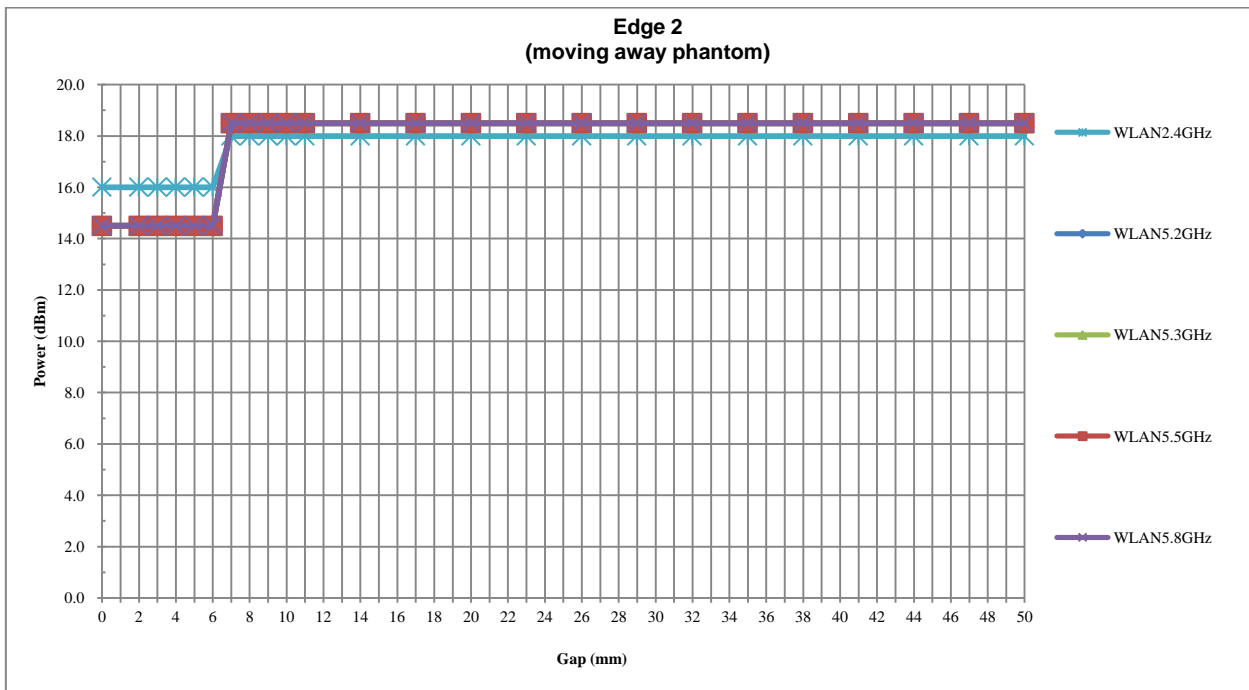
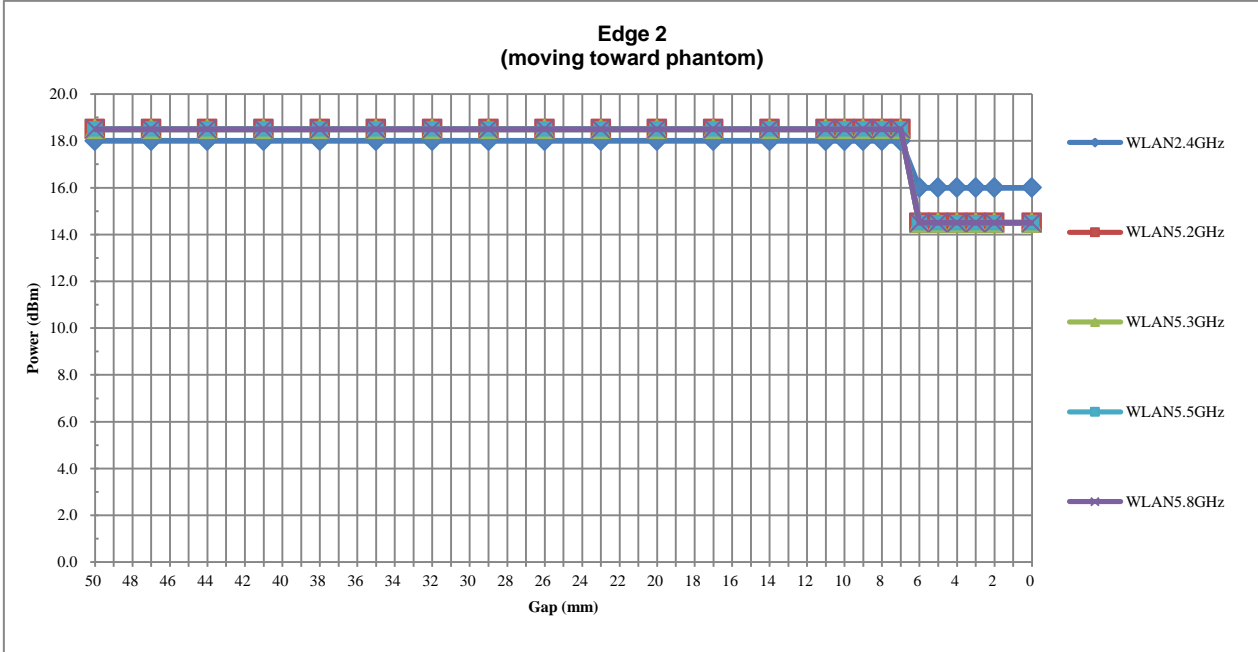



6. RF Exposure Limits

6.1 Uncontrolled Environment

Uncontrolled Environments are defined as locations where there is the exposure of individuals who have no knowledge or control of their exposure. The general population/uncontrolled exposure limits are applicable to situations in which the general public may be exposed or in which persons who are exposed as a consequence of their employment may not be made fully aware of the potential for exposure or cannot exercise control over their exposure. Members of the general public would come under this category when exposure is not employment-related; for example, in the case of a wireless transmitter that exposes persons in its vicinity.

6.2 Controlled Environment

Controlled Environments are defined as locations where there is exposure that may be incurred by persons who are aware of the potential for exposure, (i.e. as a result of employment or occupation). In general, occupational/controlled exposure limits are applicable to situations in which persons are exposed as a consequence of their employment, who have been made fully aware of the potential for exposure and can exercise control over their exposure. The exposure category is also applicable when the exposure is of a transient nature due to incidental passage through a location where the exposure levels may be higher than the general population/uncontrolled limits, but the exposed person is fully aware of the potential for exposure and can exercise control over his or her exposure by leaving the area or by some other appropriate means.

Limits for Occupational/Controlled Exposure (W/kg)

Table with 3 columns: Whole-Body, Partial-Body, Hands, Wrists, Feet and Ankles. Values: 0.4, 8.0, 20.0

Limits for General Population/Uncontrolled Exposure (W/kg)

Table with 3 columns: Whole-Body, Partial-Body, Hands, Wrists, Feet and Ankles. Values: 0.08, 1.6, 4.0

Whole-Body SAR is averaged over the entire body, partial-body SAR is averaged over any 1gram of tissue defined as a tissue volume in the shape of a cube. SAR for hands, wrists, feet and ankles is averaged over any 10 grams of tissue defined as a tissue volume in the shape of a cube.

7. Specific Absorption Rate (SAR)

7.1 Introduction

SAR is related to the rate at which energy is absorbed per unit mass in an object exposed to a radio field. The SAR distribution in a biological body is complicated and is usually carried out by experimental techniques or numerical modeling. The standard recommends limits for two tiers of groups, occupational/controlled and general population/uncontrolled, based on a person's awareness and ability to exercise control over his or her exposure. In general, occupational/controlled exposure limits are higher than the limits for general population/uncontrolled.

7.2 SAR Definition

The SAR definition is the time derivative (rate) of the incremental energy (dW) absorbed by (dissipated in) an incremental mass (dm) contained in a volume element (dv) of a given density (ρ). The equation description is as below:

$$SAR = \frac{d}{dt} \left(\frac{dW}{dm} \right) = \frac{d}{dt} \left(\frac{dW}{\rho dv} \right)$$

SAR is expressed in units of Watts per kilogram (W/kg)

$$SAR = \frac{\sigma |E|^2}{\rho}$$

Where: σ is the conductivity of the tissue, ρ is the mass density of the tissue and E is the RMS electrical field strength.

8. System Description and Setup

The DASY system used for performing compliance tests consists of the following items:

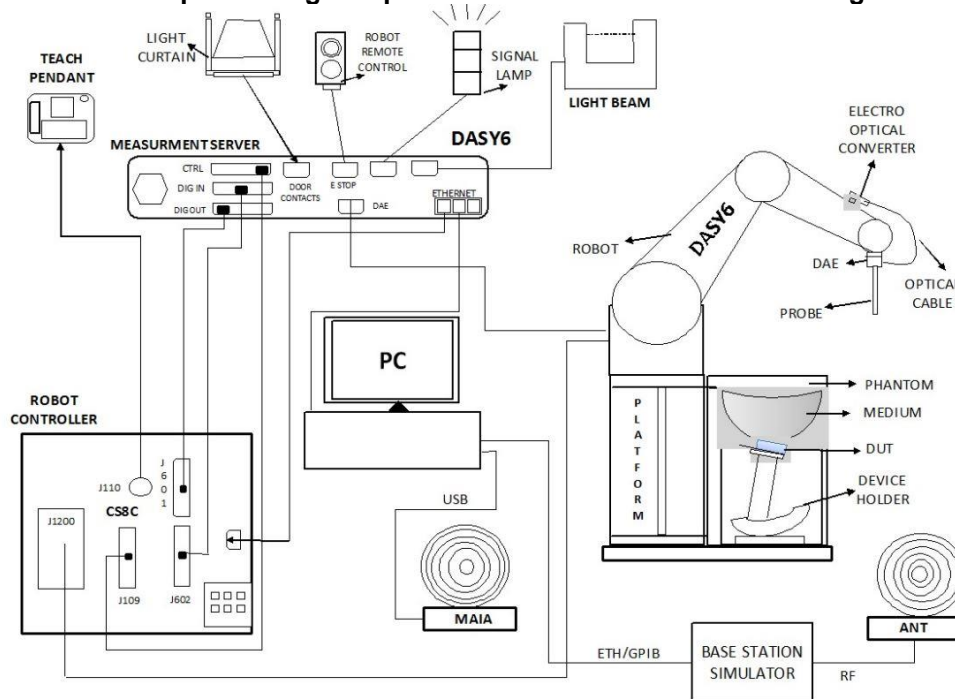

- A standard high precision 6-axis robot with controller, teach pendant and software. An arm extension for accommodating the data acquisition electronics (DAE).
- An isotropic Field probe optimized and calibrated for the targeted measurement.
- A data acquisition electronics (DAE) which performs the signal amplification, signal multiplexing, AD-conversion, offset measurements, mechanical surface detection, collision detection, etc. The unit is battery powered with standard or rechargeable batteries. The signal is optically transmitted to the EOC.
- The Electro-optical converter (EOC) performs the conversion from optical to electrical signals for the digital communication to the DAE. To use optical surface detection, a special version of the EOC is required. The EOC signal is transmitted to the measurement server.
- The function of the measurement server is to perform the time critical tasks such as signal filtering, control of the robot operation and fast movement interrupts.
- The Light Beam used is for probe alignment. This improves the (absolute) accuracy of the probe positioning.
- A computer running Win7 or Win10 and the DASY5 or DASY6 software.
- Remote control and teach pendant as well as additional circuitry for robot safety such as warning lamps, etc.
- The phantom, the device holder and other accessories according to the targeted measurement.

8.1 E-Field Probe

The SAR measurement is conducted with the dosimetric probe (manufactured by SPEAG).The probe is specially designed and calibrated for use in liquid with high permittivity. The dosimetric probe has special calibration in liquid at different frequency. This probe has a built in optical surface detection system to prevent from collision with phantom.

<EX3DV4 Probe>

Construction	Symmetric design with triangular core Built-in shielding against static charges PEEK enclosure material (resistant to organic solvents, e.g., DGBE)	
Frequency	10 MHz – >6 GHz Linearity: ±0.2 dB (30 MHz – 6 GHz)	
Directivity	±0.3 dB in TSL (rotation around probe axis) ±0.5 dB in TSL (rotation normal to probe axis)	
Dynamic Range	10 µW/g – >100 mW/g Linearity: ±0.2 dB (noise: typically <1 µW/g)	
Dimensions	Overall length: 337 mm (tip: 20 mm) Tip diameter: 2.5 mm (body: 12 mm) Typical distance from probe tip to dipole centers: 1 mm	

8.2 Data Acquisition Electronics (DAE)

The data acquisition electronics (DAE) consists of a highly sensitive electrometer-grade preamplifier with auto-zeroing, a channel and gain-switching multiplexer, a fast 16 bit AD-converter and a command decoder and control logic unit. Transmission to the measurement server is accomplished through an optical downlink for data and status information as well as an optical uplink for commands and the clock.

The input impedance of the DAE is 200 MOhm; the inputs are symmetrical and floating. Common mode rejection is above 80 dB.



Photo of DAE

8.3 Phantom

<SAM Twin Phantom>

Shell Thickness	2 ± 0.2 mm; Center ear point: 6 ± 0.2 mm
Filling Volume	Approx. 25 liters
Dimensions	Length: 1000 mm; Width: 500 mm; Height: adjustable feet
Measurement Areas	Left Hand, Right Hand, Flat Phantom



The bottom plate contains three pair of bolts for locking the device holder. The device holder positions are adjusted to the standard measurement positions in the three sections. A white cover is provided to tap the phantom during off-periods to prevent water evaporation and changes in the liquid parameters. On the phantom top, three reference markers are provided to identify the phantom position with respect to the robot.

<ELI Phantom>

Shell Thickness	2 ± 0.2 mm (sagging: <1%)
Filling Volume	Approx. 30 liters
Dimensions	Major ellipse axis: 600 mm Minor axis: 400 mm



The ELI phantom is intended for compliance testing of handheld and body-mounted wireless devices in the frequency range of 30 MHz to 6 GHz. ELI4 is fully compatible with standard and all known tissue simulating liquids.

8.4 Device Holder

<Mounting Device for Hand-Held Transmitter>

In combination with the Twin SAM V5.0/V5.0c or ELI phantoms, the Mounting Device for Hand-Held Transmitters enables rotation of the mounted transmitter device to specified spherical coordinates. At the heads, the rotation axis is at the ear opening. Transmitter devices can be easily and accurately positioned according to IEC 62209-1, IEEE 1528, FCC, or other specifications. The device holder can be locked for positioning at different phantom sections (left head, right head, flat). And upgrade kit to Mounting Device to enable easy mounting of wider devices like big smart-phones, e-books, small tablets, etc. It holds devices with width up to 140 mm.



Mounting Device for Hand-Held Transmitters



Mounting Device Adaptor for Wide-Phones

<Mounting Device for Laptops and other Body-Worn Transmitters>

The extension is lightweight and made of POM, acrylic glass and foam. It fits easily on the upper part of the mounting device in place of the phone positioned. The extension is fully compatible with the SAM Twin and ELI phantoms.



Mounting Device for Laptops

9. Measurement Procedures

The measurement procedures are as follows:

<Conducted power measurement>

- (a) For WWAN power measurement, use base station simulator to configure EUT WWAN transmission in conducted connection with RF cable, at maximum power in each supported wireless interface and frequency band.
- (b) Read the WWAN RF power level from the base station simulator.
- (c) For WLAN/BT power measurement, use engineering software to configure EUT WLAN/BT continuously transmission, at maximum RF power in each supported wireless interface and frequency band
- (d) Connect EUT RF port through RF cable to the power meter, and measure WLAN/BT output power

<SAR measurement>

- (a) Use base station simulator to configure EUT WWAN transmission in radiated connection, and engineering software to configure EUT WLAN/BT continuously transmission, at maximum RF power, in the highest power channel.
- (b) Place the EUT in the positions as Appendix D demonstrates.
- (c) Set scan area, grid size and other setting on the DASY software.
- (d) Measure SAR results for the highest power channel on each testing position.
- (e) Find out the largest SAR result on these testing positions of each band
- (f) Measure SAR results for other channels in worst SAR testing position if the reported SAR of highest power channel is larger than 0.8 W/kg

According to the test standard, the recommended procedure for assessing the peak spatial-average SAR value consists of the following steps:

- (a) Power reference measurement
- (b) Area scan
- (c) Zoom scan
- (d) Power drift measurement

9.1 Spatial Peak SAR Evaluation

The procedure for spatial peak SAR evaluation has been implemented according to the test standard. It can be conducted for 1g and 10g, as well as for user-specific masses. The DASY software includes all numerical procedures necessary to evaluate the spatial peak SAR value.

The base for the evaluation is a "cube" measurement. The measured volume must include the 1g and 10g cubes with the highest averaged SAR values. For that purpose, the center of the measured volume is aligned to the interpolated peak SAR value of a previously performed area scan.

The entire evaluation of the spatial peak values is performed within the post-processing engine (SEMCAD). The system always gives the maximum values for the 1g and 10g cubes. The algorithm to find the cube with highest averaged SAR is divided into the following stages:

- (a) Extraction of the measured data (grid and values) from the Zoom Scan
- (b) Calculation of the SAR value at every measurement point based on all stored data (A/D values and measurement parameters)
- (c) Generation of a high-resolution mesh within the measured volume
- (d) Interpolation of all measured values from the measurement grid to the high-resolution grid
- (e) Extrapolation of the entire 3-D field distribution to the phantom surface over the distance from sensor to surface
- (f) Calculation of the averaged SAR within masses of 1g and 10g

9.2 Power Reference Measurement

The Power Reference Measurement and Power Drift Measurements are for monitoring the power drift of the device under test in the batch process. The minimum distance of probe sensors to surface determines the closest measurement point to phantom surface. This distance cannot be smaller than the distance of sensor calibration points to probe tip as defined in the probe properties.

9.3 Area Scan

The area scan is used as a fast scan in two dimensions to find the area of high field values, before doing a fine measurement around the hot spot. The sophisticated interpolation routines implemented in DASY software can find the maximum found in the scanned area, within a range of the global maximum. The range (in dB0) is specified in the standards for compliance testing. For example, a 2 dB range is required in IEEE standard 1528 and IEC 62209 standards, whereby 3 dB is a requirement when compliance is assessed in accordance with the ARIB standard (Japan), if only one zoom scan follows the area scan, then only the absolute maximum will be taken as reference. For cases where multiple maximums are detected, the number of zoom scans has to be increased accordingly.

Area scan parameters extracted from FCC KDB 865664 D01v01r04 SAR measurement 100 MHz to 6 GHz.

	≤ 3 GHz	> 3 GHz
Maximum distance from closest measurement point (geometric center of probe sensors) to phantom surface	5 ± 1 mm	$\frac{1}{2} \cdot \delta \cdot \ln(2) \pm 0.5$ mm
Maximum probe angle from probe axis to phantom surface normal at the measurement location	30° ± 1°	20° ± 1°
Maximum area scan spatial resolution: Δx_{Area} , Δy_{Area}	≤ 2 GHz: ≤ 15 mm 2 – 3 GHz: ≤ 12 mm	3 – 4 GHz: ≤ 12 mm 4 – 6 GHz: ≤ 10 mm
	When the x or y dimension of the test device, in the measurement plane orientation, is smaller than the above, the measurement resolution must be ≤ the corresponding x or y dimension of the test device with at least one measurement point on the test device.	

9.4 Zoom Scan

Zoom scans are used assess the peak spatial SAR values within a cubic averaging volume containing 1 gram and 10 gram of simulated tissue. The zoom scan measures points (refer to table below) within a cube shoes base faces are centered on the maxima found in a preceding area scan job within the same procedure. When the measurement is done, the zoom scan evaluates the averaged SAR for 1 gram and 10 gram and displays these values next to the job's label.

Zoom scan parameters extracted from FCC KDB 865664 D01v01r04 SAR measurement 100 MHz to 6 GHz.

		≤ 3 GHz	> 3 GHz	
Maximum zoom scan spatial resolution: Δx_{Zoom} , Δy_{Zoom}		≤ 2 GHz: ≤ 8 mm 2 – 3 GHz: ≤ 5 mm*	3 – 4 GHz: ≤ 5 mm* 4 – 6 GHz: ≤ 4 mm*	
Maximum zoom scan spatial resolution, normal to phantom surface	uniform grid: $\Delta z_{Zoom}(n)$	≤ 5 mm	3 – 4 GHz: ≤ 4 mm 4 – 5 GHz: ≤ 3 mm 5 – 6 GHz: ≤ 2 mm	
	graded grid	$\Delta z_{Zoom}(1)$: between 1 st two points closest to phantom surface	≤ 4 mm	3 – 4 GHz: ≤ 3 mm 4 – 5 GHz: ≤ 2.5 mm 5 – 6 GHz: ≤ 2 mm
		$\Delta z_{Zoom}(n>1)$: between subsequent points	$\leq 1.5 \cdot \Delta z_{Zoom}(n-1)$	
Minimum zoom scan volume	x, y, z	≥ 30 mm	3 – 4 GHz: ≥ 28 mm 4 – 5 GHz: ≥ 25 mm 5 – 6 GHz: ≥ 22 mm	
Note: δ is the penetration depth of a plane-wave at normal incidence to the tissue medium; see draft standard IEEE P1528-2011 for details. * When zoom scan is required and the <i>reported</i> SAR from the <i>area scan based 1-g SAR estimation</i> procedures of KDB 447498 is ≤ 1.4 W/kg, ≤ 8 mm, ≤ 7 mm and ≤ 5 mm zoom scan resolution may be applied, respectively, for 2 GHz to 3 GHz, 3 GHz to 4 GHz and 4 GHz to 6 GHz.				

9.5 Volume Scan Procedures

The volume scan is used for assess overlapping SAR distributions for antennas transmitting in different frequency bands. It is equivalent to an oversized zoom scan used in standalone measurements. The measurement volume will be used to enclose all the simultaneous transmitting antennas. For antennas transmitting simultaneously in different frequency bands, the volume scan is measured separately in each frequency band. In order to sum correctly to compute the 1g aggregate SAR, the EUT remain in the same test position for all measurements and all volume scan use the same spatial resolution and grid spacing. When all volume scan were completed, the software, SEMCAD postprocessor can combine and subsequently superpose these measurement data to calculating the multiband SAR.

9.6 Power Drift Monitoring

All SAR testing is under the EUT install full charged battery and transmit maximum output power. In DASYS measurement software, the power reference measurement and power drift measurement procedures are used for monitoring the power drift of EUT during SAR test. Both these procedures measure the field at a specified reference position before and after the SAR testing. The software will calculate the field difference in dB. If the power drifts more than 5%, the SAR will be retested.



10. Test Equipment List

Manufacturer	Name of Equipment	Type/Model	Serial Number	Calibration	
				Last Cal.	Due Date
SPEAG	835MHz System Validation Kit	D835V2	4d162	2021/12/17	2022/12/16
SPEAG	1750MHz System Validation Kit	D1750V2	1090	2022/2/24	2023/2/23
SPEAG	1900MHz System Validation Kit	D1900V2	5d182	2021/12/20	2022/12/19
SPEAG	2450MHz System Validation Kit	D2450V2	924	2020/9/2	2023/9/1
SPEAG	2600MHz System Validation Kit	D2600V2	1061	2020/11/26	2023/11/25
SPEAG	5000MHz System Validation Kit	D5GHzV2	1113	2019/9/24	2022/9/22
SPEAG	Data Acquisition Electronics	DAE4	1691	2021/10/4	2022/10/3
SPEAG	Data Acquisition Electronics	DAE4	1279	2021/9/21	2022/9/20
SPEAG	Dosimetric E-Field Probe	EX3DV4	7630	2022/3/4	2023/3/3
SPEAG	Dosimetric E-Field Probe	EX3DV4	7706	2022/1/20	2023/1/19
SPEAG	ELI4 Phantom	ELI 5.0	TP-2151	NCR	NCR
SPEAG	ELI4 Phantom	ELI V8.0	TP-2135	NCR	NCR
SPEAG	Phone Positioner	N/A	N/A	NCR	NCR
Anritsu	Radio Communication Analyzer	MT8821C	6262306173	2021/7/15	2022/7/14
Agilent	ENA Series Network Analyzer	E5071C	MY46106933	2021/7/31	2022/7/30
SPEAG	Dielectric Probe Kit	DAK-3.5	1138	2021/6/9	2022/6/8
Anritsu	Vector Signal Generator	MG3710A	6201682672	2022/1/6	2023/1/5
R&S	Power Meter	NRVD	102081	2021/8/12	2022/8/11
R&S	Power Sensor	NRV-Z5	100538	2021/8/12	2022/8/11
R&S	Power Sensor	NRV-Z5	100539	2021/8/12	2022/8/11
R&S	CBT BLUETOOTH TESTER	CBT	100641	2022/1/5	2023/1/4
EXA	Spectrum Analyzer	FSV7	101631	2021/10/14	2022/10/13
Testo	Thermo-Hyrometer	608-H1	1241332126	2022/1/6	2023/1/5
FLUKE	DIGITAC THERMOMETER	51II	97240029	2021/10/23	2022/10/22
ARRA	Power Divider	A3200-2	N/A		Note
SPEAG	Phone Positioner	N/A	N/A		Note
MCL	Attenuation1	BW-S10W5+	N/A		Note
MCL	Attenuation2	BW-S10W5+	N/A		Note
MCL	Attenuation3	BW-S10W5+	N/A		Note
Agilent	Dual Directional Coupler	778D	20500		Note
Agilent	Dual Directional Coupler	11691D	MY48151020		Note
BONN	POWER AMPLIFIER	BLMA 0830-3	087193A		Note
BONN	POWER AMPLIFIER	BLMA 2060-2	087193B		Note

Note:

1. Prior to system verification and validation, the path loss from the signal generator to the system check source and the power meter, which includes the amplifier, cable, attenuator and directional coupler, was measured by the network analyzer. The reading of the power meter was offset by the path loss difference between the path to the power meter and the path to the system check source to monitor the actual power level fed to the system check source.
2. Referring to KDB 865664 D01v01r04, the dipole calibration interval can be extended to 3 years with justification. The dipoles are also not physically damaged, or repaired during the interval.
3. The justification data of dipole can be found in appendix C. The return loss is < -20dB, within 20% of prior calibration, the impedance is within 5 ohm of prior calibration.

11. System Verification

11.1 Tissue Simulating Liquids

For the measurement of the field distribution inside the SAM phantom with DASY, the phantom must be filled with around 25 liters of homogeneous body tissue simulating liquid. For body SAR testing, the liquid height from the center of the flat phantom to the liquid top surface is larger than 15 cm, which is shown in Fig. 11.1.

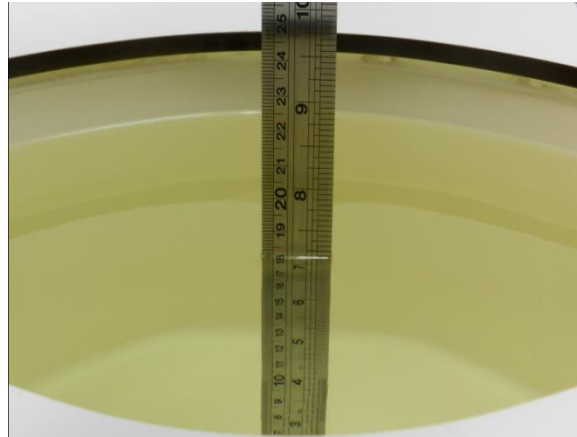

Fig 11.1 Photo of Liquid Height for Body SAR

11.2 Tissue Verification

The following tissue formulations are provided for reference only as some of the parameters have not been thoroughly verified. The composition of ingredients may be modified accordingly to achieve the desired target tissue parameters required for routine SAR evaluation.

Frequency (MHz)	Water (%)	Sugar (%)	Cellulose (%)	Salt (%)	Preventol (%)	DGBE (%)	Conductivity (σ)	Permittivity (ε _r)
For Head								
835	40.3	57.9	0.2	1.4	0.2	0	0.90	41.5
1800, 1900, 2000	55.2	0	0	0.3	0	44.5	1.40	40.0
2450	55.0	0	0	0	0	45.0	1.80	39.2
2600	54.8	0	0	0.1	0	45.1	1.96	39.0

Simulating Liquid for 5GHz, Manufactured by SPEAG

Ingredients	(% by weight)
Water	64~78%
Mineral oil	11~18%
Emulsifiers	9~15%
Additives and Salt	2~3%

<Tissue Dielectric Parameter Check Results>

Frequency (MHz)	Tissue Type	Liquid Temp. (°C)	Conductivity (σ)	Permittivity (ε _r)	Conductivity Target (σ)	Permittivity Target (ε _r)	Delta (σ) (%)	Delta (ε _r) (%)	Limit (%)	Date
835	Head	22.9	0.929	40.900	0.90	41.50	3.22	-1.45	±5	2022/5/19
1750	Head	22.9	1.390	40.500	1.37	40.10	1.46	1.00	±5	2022/5/22
1900	Head	22.7	1.450	40.300	1.40	40.00	3.57	0.75	±5	2022/5/24
2450	Head	22.6	1.831	37.486	1.80	39.20	1.72	-4.37	±5	2022/5/18
2600	Head	22.6	1.930	38.200	1.96	39.00	-1.53	-2.05	±5	2022/5/28
5250	Head	22.8	4.663	36.653	4.71	35.90	-1.00	2.10	±5	2022/5/31
5600	Head	22.8	5.07	36.008	5.07	35.50	0.00	1.43	±5	2022/6/1
5750	Head	22.9	5.241	35.762	5.22	35.40	0.40	1.02	±5	2022/6/2

11.3 System Performance Check Results

Comparing to the original SAR value provided by SPEAG, the verification data should be within its specification of 10 %. Below table shows the target SAR and measured SAR after normalized to 1W input power. The table below indicates the system performance check can meet the variation criterion and the plots can be referred to Appendix A of this report.

Date	Frequency (MHz)	Tissue Type	Input Power (mW)	Dipole S/N	Probe S/N	DAE S/N	Measured 1g SAR (W/kg)	Targeted 1g SAR (W/kg)	Normalized 1g SAR (W/kg)	Deviation (%)
2022/5/19	835	Head	50	4d162	7630	1691	0.479	9.64	9.58	-0.62
2022/5/22	1750	Head	50	1090	7630	1691	1.840	37.00	36.8	-0.54
2022/5/24	1900	Head	50	5d182	7630	1691	1.950	39.60	39	-1.52
2022/5/18	2450	Head	50	924	7706	1279	2.410	51.40	48.2	-6.23
2022/5/28	2600	Head	50	1061	7630	1691	2.630	56.60	52.6	-7.07
2022/5/31	5250	Head	50	1113	7706	1279	4.290	80.50	85.8	6.58
2022/6/1	5600	Head	50	1113	7706	1279	4.390	83.40	87.8	5.28
2022/6/2	5750	Head	50	1113	7706	1279	4.240	80.00	84.8	6.00

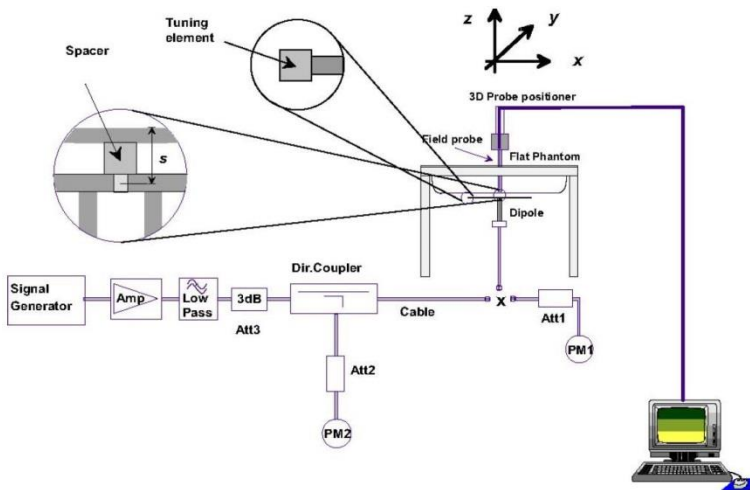

Fig 8.3.1 System Performance Check Setup



Fig 8.3.2 Setup Photo



12. RF Exposure Positions

12.1 SAR Testing for Tablet

This device can be used also in full sized tablet exposure conditions, due to its size. Per FCC KDB 616217, the back surface and edges of the tablet should be tested for SAR compliance with the tablet touching the phantom. The SAR exclusion threshold in KDB 447498 D01v06 can be applied to determine SAR test exclusion for adjacent edge configurations. The closest distance from the antenna to an adjacent tablet edge is used to determine if SAR testing is required for the adjacent edges, with the adjacent edge positioned against the phantom and the edge containing the antenna positioned perpendicular to the phantom.

<EUT Setup Photos>

Please refer to Appendix D for the test setup photos.



13. Conducted RF Output Power (Unit: dBm)

The detailed conducted power table can refer to Appendix E.

<GSM Conducted Power>

General Note:

1. Per KDB 447498 D01v06, the maximum output power channel is used for SAR testing and for further SAR test reduction.
2. Per KDB 941225 D01v03r01, for SAR test reduction for GSM / GPRS / EDGE modes is determined by the source-based time-averaged output power including tune-up tolerance. The mode with highest specified time-averaged output power should be tested for SAR compliance in the applicable exposure conditions. For modes with the same specified maximum output power and tolerance, the higher number time-slot configuration should be tested. Therefore, the GPRS (4Tx slots) for GSM850/GSM1900 is considered as the primary mode.
3. Other configurations of GSM / GPRS / EDGE are considered as secondary modes. The 3G SAR test reduction procedure is applied, when the maximum output power and tune-up tolerance specified for production units in a secondary mode is $\leq \frac{1}{4}$ dB higher than the primary mode, SAR measurement is not required for the secondary mode.

<WCDMA Conducted Power>

1. The following tests were conducted according to the test requirements outlines in 3GPP TS 34.121 specification.
2. The procedures in KDB 941225 D01v03r01 are applied for 3GPP Rel. 6 HSPA to configure the device in the required sub-test mode(s) to determine SAR test exclusion.
3. For HSPA+ devices supporting 16 QAM in the uplink, power measurements procedure is according to the configurations in Table C.11.1.4 of 3GPP TS 34.121-1.
4. For DC-HSDPA, the device was configured according to the H-Set 12, Fixed Reference Channel (FRC) configuration in Table C.8.1.12 of 3GPP TS 34.121-1, with the primary and the secondary serving HS-DSCH Cell enabled during the power measurement.

A summary of these settings are illustrated below:

HSDPA Setup Configuration:

- a. The EUT was connected to Base Station Agilent E5515C referred to the Setup Configuration.
- b. The RF path losses were compensated into the measurements.
- c. A call was established between EUT and Base Station with following setting:
 - i. Set Gain Factors (β_c and β_d) and parameters were set according to each
 - ii. Specific sub-test in the following table, C10.1.4, quoted from the TS 34.121
 - iii. Set RMC 12.2Kbps + HSDPA mode.
 - iv. Set Cell Power = -86 dBm
 - v. Set HS-DSCH Configuration Type to FRC (H-set 1, QPSK)
 - vi. Select HSDPA Uplink Parameters
 - vii. Set Delta ACK, Delta NACK and Delta CQI = 8
 - viii. Set Ack-Nack Repetition Factor to 3
 - ix. Set CQI Feedback Cycle (k) to 4 ms
 - x. Set CQI Repetition Factor to 2
 - xi. Power Ctrl Mode = All Up bits
- d. The transmitted maximum output power was recorded.

Table C.10.1.4: β values for transmitter characteristics tests with HS-DPCCH

Sub-test	β_c	β_d	β_d (SF)	β_c/β_d	β_{HS} (Note 1, Note 2)	CM (dB) (Note 3)	MPR (dB) (Note 3)
1	2/15	15/15	64	2/15	4/15	0.0	0.0
2	12/15 (Note 4)	15/15 (Note 4)	64	12/15 (Note 4)	24/15	1.0	0.0
3	15/15	8/15	64	15/8	30/15	1.5	0.5
4	15/15	4/15	64	15/4	30/15	1.5	0.5

Note 1: Δ_{ACK} , Δ_{NACK} and $\Delta_{CQI} = 30/15$ with $\beta_{HS} = 30/15 * \beta_c$.

Note 2: For the HS-DPCCH power mask requirement test in clause 5.2C, 5.7A, and the Error Vector Magnitude (EVM) with HS-DPCCH test in clause 5.13.1A, and HSDPA EVM with phase discontinuity in clause 5.13.1AA, Δ_{ACK} and $\Delta_{NACK} = 30/15$ with $\beta_{HS} = 30/15 * \beta_c$, and $\Delta_{CQI} = 24/15$ with $\beta_{HS} = 24/15 * \beta_c$.

Note 3: CM = 1 for $\beta_c/\beta_d = 12/15$, $\beta_{HS}/\beta_c = 24/15$. For all other combinations of DPDCH, DPCCH and HS-DPCCH the MPR is based on the relative CM difference. This is applicable for only UEs that support HSDPA in release 6 and later releases.

Note 4: For subtest 2 the β_c/β_d ratio of 12/15 for the TFC during the measurement period (TF1, TF0) is achieved by setting the signalled gain factors for the reference TFC (TF1, TF1) to $\beta_c = 11/15$ and $\beta_d = 15/15$.

Setup Configuration

HSUPA Setup Configuration:

- a. The EUT was connected to Base Station Agilent E5515C referred to the Setup Configuration.
- b. The RF path losses were compensated into the measurements.
- c. A call was established between EUT and Base Station with following setting * :
 - i. Call Configs = 5.2B, 5.9B, 5.10B, and 5.13.2B with QPSK
 - ii. Set the Gain Factors (β_c and β_d) and parameters (AG Index) were set according to each specific sub-test in the following table, C11.1.3, quoted from the TS 34.121
 - iii. Set Cell Power = -86 dBm
 - iv. Set Channel Type = 12.2k + HSPA
 - v. Set UE Target Power
 - vi. Power Ctrl Mode= Alternating bits
 - vii. Set and observe the E-TFCl
 - viii. Confirm that E-TFCl is equal to the target E-TFCl of 75 for sub-test 1, and other subtest's E-TFCl
- d. The transmitted maximum output power was recorded.

Table C.11.1.3: β values for transmitter characteristics tests with HS-DPCCH and E-DCH

Sub-test	β_c	β_d	β_d (SF)	β_c/β_d	β_{HS} (Note1)	β_{ec}	β_{ed} (Note 4) (Note 5)	β_{ed} (SF)	β_{ed} (Codes)	CM (dB) (Note 2)	MPR (dB) (Note 2) (Note 6)	AG Index (Note 5)	E-TFCl
1	11/15 (Note 3)	15/15 (Note 3)	64	11/15 (Note 3)	22/15	209/25	1309/225	4	1	1.0	0.0	20	75
2	6/15	15/15	64	6/15	12/15	12/15	94/75	4	1	3.0	2.0	12	67
3	15/15	9/15	64	15/9	30/15	30/15	$\beta_{ed1}: 47/15$ $\beta_{ed2}: 47/15$	4 4	2	2.0	1.0	15	92
4	2/15	15/15	64	2/15	4/15	2/15	56/75	4	1	3.0	2.0	17	71
5	15/15	0	-	-	5/15	5/15	47/15	4	1	1.0	0.0	12	67

Note 1: For sub-test 1 to 4, Δ_{ACK} , Δ_{NACK} and $\Delta_{CQI} = 30/15$ with $\beta_{hs} = 30/15 * \beta_c$. For sub-test 5, Δ_{ACK} , Δ_{NACK} and $\Delta_{CQI} = 5/15$ with $\beta_{hs} = 5/15 * \beta_c$.

Note 2: CM = 1 for $\beta_c/\beta_d = 12/15$, $\beta_{hs}/\beta_c = 24/15$. For all other combinations of DPDCCH, DPCCH, HS-DPCCH, E-DPDCCH and E-DPCCH the MPR is based on the relative CM difference.

Note 3: For subtest 1 the β_c/β_d ratio of 11/15 for the TFC during the measurement period (TF1, TF0) is achieved by setting the signalled gain factors for the reference TFC (TF1, TF1) to $\beta_c = 10/15$ and $\beta_d = 15/15$.

Note 4: In case of testing by UE using E-DPDCCH Physical Layer category 1, Sub-test 3 is omitted according to TS25.306 Table 5.1g.

Note 5: β_{ed} can not be set directly; it is set by Absolute Grant Value.

Note 6: For subtests 2, 3 and 4, UE may perform E-DPDCCH power scaling at max power which could results in slightly smaller MPR values.

Setup Configuration

DC-HSDPA 3GPP release 8 Setup Configuration:

- a. The EUT was connected to Base Station Agilent E5515C referred to the Setup Configuration below
- b. The RF path losses were compensated into the measurements.
- c. A call was established between EUT and Base Station with following setting:
 - i. Set RMC 12.2Kbps + HSDPA mode.
 - ii. Set Cell Power = -25 dBm
 - iii. Set HS-DSCH Configuration Type to FRC (H-set 12, QPSK)
 - iv. Select HSDPA Uplink Parameters
 - v. Set Gain Factors (β_c and β_d) and parameters were set according to each Specific sub-test in the following table, C10.1.4, quoted from the TS 34.121
 - a). Subtest 1: $\beta_c/\beta_d=2/15$
 - b). Subtest 2: $\beta_c/\beta_d=12/15$
 - c). Subtest 3: $\beta_c/\beta_d=15/8$
 - d). Subtest 4: $\beta_c/\beta_d=15/4$
 - vi. Set Delta ACK, Delta NACK and Delta CQI = 8
 - vii. Set Ack-Nack Repetition Factor to 3
 - viii. Set CQI Feedback Cycle (k) to 4 ms
 - ix. Set CQI Repetition Factor to 2
 - x. Power Ctrl Mode = All Up bits
- d. The transmitted maximum output power was recorded.

The following tests were conducted according to the test requirements outlines in 3GPP TS 34.121 specification. A summary of these settings are illustrated below:

C.8.1.12 Fixed Reference Channel Definition H-Set 12

Table C.8.1.12: Fixed Reference Channel H-Set 12

Parameter	Unit	Value
Nominal Avg. Inf. Bit Rate	kbps	60
Inter-TTI Distance	TTI's	1
Number of HARQ Processes	Processes	6
Information Bit Payload (N_{INF})	Bits	120
Number Code Blocks	Blocks	1
Binary Channel Bits Per TTI	Bits	960
Total Available SML's in UE	SML's	19200
Number of SML's per HARQ Proc.	SML's	3200
Coding Rate		0.15
Number of Physical Channel Codes	Codes	1
Modulation		QPSK
Note 1: The RMC is intended to be used for DC-HSDPA mode and both cells shall transmit with identical parameters as listed in the table. Note 2: Maximum number of transmission is limited to 1, i.e., retransmission is not allowed. The redundancy and constellation version 0 shall be used.		

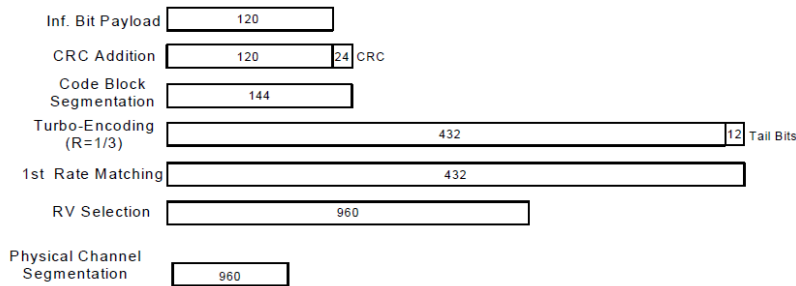

Figure C.8.19: Coding rate for Fixed reference Channel H-Set 12 (QPSK)

Setup Configuration

**<WCDMA Conducted Power>****General Note:**

1. Per KDB 941225 D01v03r01, for SAR testing is measured using a 12.2 kbps RMC with TPC bits configured to all "1's".
2. Per KDB 941225 D01v03r01, RMC 12.2kbps setting is used to evaluate SAR. The maximum output power and tune-up tolerance specified for production units in HSDPA / HSUPA / DC-HSDPA is $\leq \frac{1}{4}$ dB higher than RMC 12.2Kbps or when the highest reported SAR of the RMC12.2Kbps is scaled by the ratio of specified maximum output power and tune-up tolerance of HSDPA / HSUPA / DC-HSDPA to RMC12.2Kbps and the adjusted SAR is ≤ 1.2 W/kg, SAR measurement is not required for HSDPA / HSUPA / DC-HSDPA, and according to the following RF output power, the output power results of the secondary modes (HSUPA, HSDPA, DC-HSDPA) are less than $\frac{1}{4}$ dB higher than the primary modes; therefore, SAR measurement is not required for HSDPA / HSUPA / DC-HSDPA.

<LTE Conducted Power>

General Note:

1. Anritsu MT8821C base station simulator was used to setup the connection with EUT; the frequency band, channel bandwidth, RB allocation configuration, modulation type are set in the base station simulator to configure EUT transmitting at maximum power and at different configurations which are requested to be reported to FCC, for conducted power measurement and SAR testing.
2. Per KDB 941225 D05v02r05, when a properly configured base station simulator is used for the SAR and power measurements, spectrum plots for each RB allocation and offset configuration is not required.
3. Per KDB 941225 D05v02r05, start with the largest channel bandwidth and measure SAR for QPSK with 1 RB allocation, using the RB offset and required test channel combination with the highest maximum output power for RB offsets at the upper edge, middle and lower edge of each required test channel.
4. Per KDB 941225 D05v02r05, 50% RB allocation for QPSK SAR testing follows 1RB QPSK allocation procedure.
5. Per KDB 941225 D05v02r05, For QPSK with 100% RB allocation, SAR is not required when the highest maximum output power for 100 % RB allocation is less than the highest maximum output power in 50% and 1 RB allocations and the highest reported SAR for 1 RB and 50% RB allocation are ≤ 0.8 W/kg. Otherwise, SAR is measured for the highest output power channel; and if the reported SAR is > 1.45 W/kg, the remaining required test channels must also be tested.
6. Per KDB 941225 D05v02r05, 16QAM output power for each RB allocation configuration is $>$ not $\frac{1}{2}$ dB higher than the same configuration in QPSK and the reported SAR for the QPSK configuration is ≤ 1.45 W/kg; Per KDB 941225 D05v02r05, 16QAM SAR testing is not required.
7. Per KDB 941225 D05v02r05, Smaller bandwidth output power for each RB allocation configuration is $>$ not $\frac{1}{2}$ dB higher than the same configuration in the largest supported bandwidth, and the reported SAR for the largest supported bandwidth is ≤ 1.45 W/kg; Per KDB 941225 D05v02r05, smaller bandwidth SAR testing is not required.
8. For LTE B4 / B5 / B38 the maximum bandwidth does not support three non-overlapping channels, per KDB 941225 D05v02r05, when a device supports overlapping channel assignment in a channel bandwidth configuration, the middle channel of the group of overlapping channels should be selected for testing.
9. According to 2017 TCB workshop, for 64QAM and 16QAM should be verified by checking the signal constellation with a call box to avoid incorrect maximum power levels due to MPR and other requirements associated with signal modulation, and the following figure is taken from the "Fundamental Measurement >> Modulation Analysis >> constellation" mode of the device connect to the MT8821C base station, therefore, the device 64QAM and 16QAM signal modulation are correct.

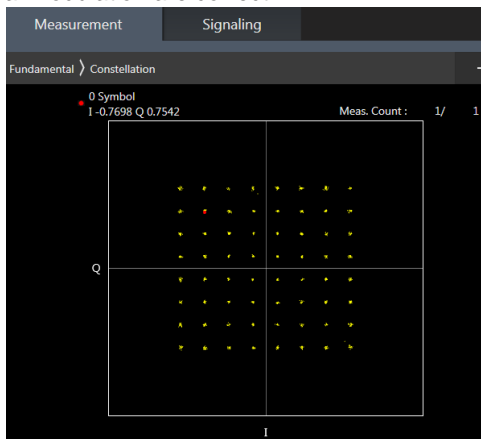

64QAM

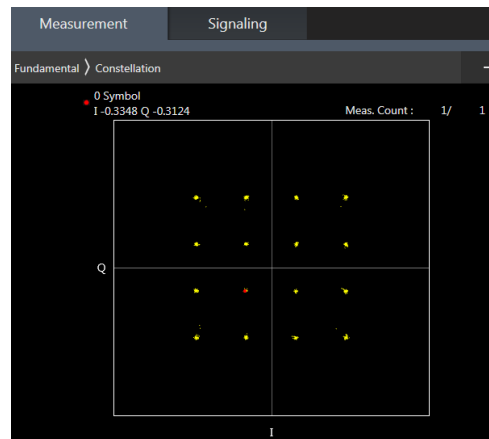

16QAM

<TDD LTE SAR Measurement>

TDD LTE configuration setup for SAR measurement

SAR was tested with a fixed periodic duty factor according to the highest transmission duty factor implemented for the device and supported by 3GPP.

- a. 3GPP TS 36.211 section 4.2 for Type 2 Frame Structure and Table 4.2-2 for uplink-downlink configurations
- b. "special subframe S" contains both uplink and downlink transmissions, it has been taken into consideration to determine the transmission duty factor according to the worst case uplink and downlink cyclic prefix requirements for UpPTS
- c. Establishing connections with base station simulators ensure a consistent means for testing SAR and recommended for evaluating SAR. The Anritsu MT8820C (firmware: #22.52#004) was used for LTE output power measurements and SAR testing.

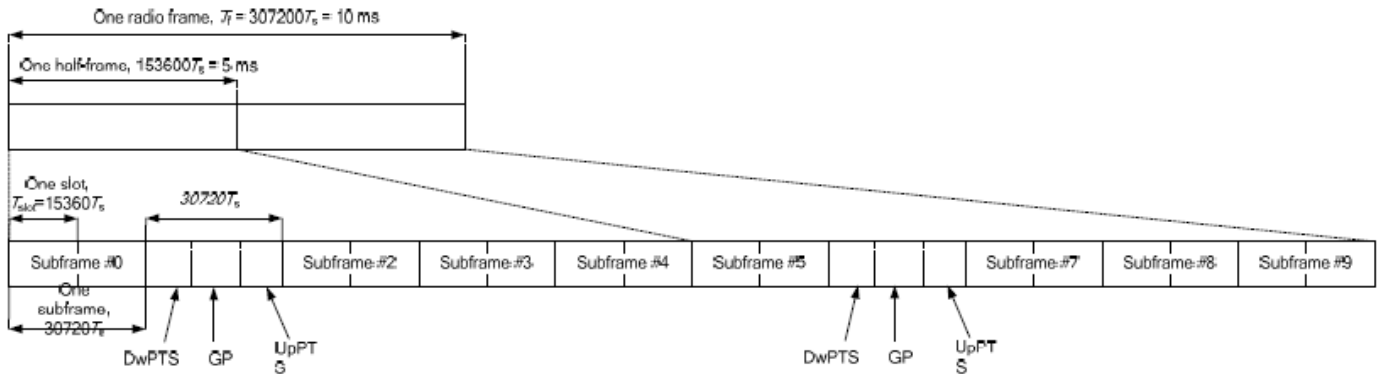

Figure 4.2-1: Frame structure type 2 (for 5 ms switch-point periodicity).

Table 4.2-2: Uplink-downlink configurations.

Uplink-downlink configuration	Downlink-to-Uplink Switch-point periodicity	Subframe number									
		0	1	2	3	4	5	6	7	8	9
0	5 ms	D	S	U	U	U	D	S	U	U	U
1	5 ms	D	S	U	U	D	D	S	U	U	D
2	5 ms	D	S	U	D	D	D	S	U	D	D
3	10 ms	D	S	U	U	U	D	D	D	D	D
4	10 ms	D	S	U	U	D	D	D	D	D	D
5	10 ms	D	S	U	D	D	D	D	D	D	D
6	5 ms	D	S	U	U	U	D	S	U	U	D

Table 4.2-1: Configuration of special subframe (lengths of DwPTS/GP/UpPTS).

Special subframe configuration	Normal cyclic prefix in downlink			Extended cyclic prefix in downlink				
	DwPTS	UpPTS		DwPTS	UpPTS			
		Normal cyclic prefix in uplink	Extended cyclic prefix in uplink		Normal cyclic prefix in uplink	Extended cyclic prefix in uplink		
0	6592 · Ts	2192 · Ts	2560 · Ts	7680 · Ts	2192 · Ts	2560 · Ts		
1	19760 · Ts			20480 · Ts				
2	21952 · Ts			23040 · Ts				
3	24144 · Ts			25600 · Ts				
4	26336 · Ts			7680 · Ts				
5	6592 · Ts	4384 · Ts	5120 · Ts	20480 · Ts	4384 · Ts	5120 · Ts		
6	19760 · Ts			23040 · Ts				
7	21952 · Ts			12800 · Ts				
8	24144 · Ts			-			-	-
9	13168 · Ts			-			-	-

Special subframe (30720·T _s): Normal cyclic prefix in downlink (UpPTS)			
	Special subframe configuration	Normal cyclic prefix in uplink	Extended cyclic prefix in uplink
Uplink duty factor in one special subframe	0~4	7.13%	8.33%
	5~9	14.3%	16.7%

Special subframe(30720·T _s): Extended cyclic prefix in downlink (UpPTS)			
	Special subframe configuration	Normal cyclic prefix in uplink	Extended cyclic prefix in uplink
Uplink duty factor in one special subframe	0~3	7.13%	8.33%
	4~7	14.3%	16.7%

The highest duty factor is resulted from:

- i. Uplink-downlink configuration: 0. In a half-frame consisted of 5 subframes, uplink operation is in 3 uplink subframes and 1 special subframe.
- ii. special subframe configuration: 5-9 for normal cyclic prefix in downlink, 4-7 for extended cyclic prefix in downlink
- iii. for special subframe with extended cyclic prefix in uplink, the total uplink duty factor in one half-frame is:
 $(3+0.167)/5 = 63.3\%$
- iv. for special subframe with normal cyclic prefix in uplink, the total uplink duty factor in one half-frame is:
 $(3+0.143)/5 = 62.9\%$
- v. For TDD LTE SAR measurement, the duty cycle 1:1.59 (62.9 %) was used perform testing and considering the theoretical duty cycle of 63.3% for extended cyclic prefix in the uplink, and the theoretical duty cycle of 62.9% for normal cyclic prefix in uplink, a scaling factor of extended cyclic prefix $63.3\%/62.9\% = 1.006$ is applied to scale-up the measured SAR result. The scaled TDD LTE SAR = measured SAR (W/kg)* Tune-up Scaling Factor* scaling factor for extended cyclic prefix.



14. SAR Test Results

14.1 Body SAR

<GSM SAR>

Plot No.	Band	Mode	Test Position	Gap (mm)	Power Mode	Ch.	Freq. (MHz)	Average Power (dBm)	Tune-Up Limit (dBm)	Tune-up Scaling Factor	Power Drift (dB)	Measured 1g SAR (W/kg)	Reported 1g SAR (W/kg)
01	GSM850	GPRS 4 Tx slots	Edge 1	0	Reduced	189	836.4	19.76	21.00	1.330	0.02	0.708	0.942
02	GSM1900	GPRS 4 Tx slots	Edge 1	0	Reduced	810	1909.8	16.98	17.50	1.127	0.06	0.970	1.093

<WCDMA SAR>

Plot No.	Band	Mode	Test Position	Gap (mm)	Power Mode	Ch.	Freq. (MHz)	Average Power (dBm)	Tune-Up Limit (dBm)	Tune-up Scaling Factor	Power Drift (dB)	Measured 1g SAR (W/kg)	Reported 1g SAR (W/kg)
03	WCDMA V	RMC 12.2Kbps	Edge 1	0	Reduced	4182	836.4	18.43	19.00	1.140	0.01	0.791	0.902
04	WCDMA II	RMC 12.2Kbps	Edge 1	0	Reduced	9538	1907.6	15.24	16.00	1.191	-0.01	0.711	0.847

<FDD LTE SAR>

Plot No.	Band	BW (MHz)	Modulation	RB Size	RB Offset	Test Position	Gap (mm)	Power Mode	Ch.	Freq. (MHz)	Average Power (dBm)	Tune-Up Limit (dBm)	Tune-up Scaling Factor	Power Drift (dB)	Measured 1g SAR (W/kg)	Reported 1g SAR (W/kg)
05	LTE Band 2	20M	QPSK	50	24	Edge 1	0	Reduced	19100	1900	14.05	15.00	1.245	-0.06	0.710	0.884
06	LTE Band 4	20M	QPSK	50	24	Bottom Face	0	Reduced	20175	1732.5	16.33	17.50	1.309	-0.03	0.604	0.791
07	LTE Band 5	10M	QPSK	50	0	Edge 1	0	Reduced	20525	836.5	17.55	18.50	1.245	-0.02	0.748	0.931
08	LTE Band 7	20M	QPSK	1	49	Edge 4	8	Full	21350	2560	23.10	24.50	1.380	-0.09	0.525	0.725

<TDD LTE SAR>

Plot No.	Band	BW (MHz)	Modulation	RB Size	RB Offset	Test Position	Gap (mm)	Power Mode	Ch.	Freq. (MHz)	Average Power (dBm)	Tune-Up Limit (dBm)	Tune-up Scaling Factor	Duty Cycle %	Duty Cycle Scaling Factor	Power Drift (dB)	Measured 1g SAR (W/kg)	Reported 1g SAR (W/kg)
09	LTE Band 38	20M	QPSK	50	0	Bottom Face	0	Reduced	38000	2595	17.02	18.00	1.253	62.9	1.006	0.03	0.674	0.850



<WLAN 2.4GHz SAR>

Plot No.	Band	Mode	Test Position	Gap (mm)	Power Mode	Ch.	Freq. (MHz)	Average Power (dBm)	Tune-Up Limit (dBm)	Tune-up Scaling Factor	Duty Cycle %	Duty Cycle Scaling Factor	Power Drift (dB)	Measured 1g SAR (W/kg)	Reported 1g SAR (W/kg)
10	WLAN 2.4GHz	802.11b 1Mbps	Bottom Face	0	Reduced	6	2437	14.48	16.00	1.419	100	1.000	0.01	0.762	1.081

<WLAN5G SAR>

Plot No.	Band	Mode	Test Position	Gap (mm)	Power Mode	Ch.	Freq. (MHz)	Average Power (dBm)	Tune-Up Limit (dBm)	Tune-up Scaling Factor	Duty Cycle %	Duty Cycle Scaling Factor	Power Drift (dB)	Measured 1g SAR (W/kg)	Reported 1g SAR (W/kg)
11	WLAN5.3GHz	802.11a 6Mbps	Edge 1	0	Reduced	60	5300	12.79	14.50	1.483	96.97	1.031	-0.03	0.469	0.717
12	WLAN5.5GHz	802.11a 6Mbps	Edge 1	0	Reduced	100	5500	13.09	14.50	1.384	96.97	1.031	-0.06	0.381	0.543
13	WLAN5.8GHz	802.11a 6Mbps	Edge 1	0	Reduced	157	5785	13.02	14.50	1.406	96.97	1.031	-0.05	0.449	0.651

<Bluetooth SAR>

Plot No.	Band	Mode	Test Position	Gap (mm)	Power Mode	Ch.	Freq. (MHz)	Average Power (dBm)	Tune-Up Limit (dBm)	Tune-up Scaling Factor	Duty Cycle %	Duty Cycle Scaling Factor	Power Drift (dB)	Measured 1g SAR (W/kg)	Reported 1g SAR (W/kg)
14	Bluetooth	1Mbps	Bottom Face	0	Full	78	2480	8.60	10.00	1.380	76.72	1.086	-0.01	0.158	0.237

Note: The verified maximum SAR chapter 14.1 are most less than original report, so no need to consider co-located SAR for original report has been performed conservatively.

14.2 Repeated SAR Measurement

<1g>

Plot No.	Band	BW (MHz)	Modulation	RB Size	RB offset	Mode	Test Position	Gap (mm)	Power State	Ch.	Freq. (MHz)	Average Power (dBm)	Tune-Up Limit (dBm)	Tune-up Scaling Factor	Duty Cycle %	Duty Cycle Scaling Factor	Power Drift (dB)	Measured 1g SAR (W/kg)	Ratio	Reported 1g SAR (W/kg)
1st	GSM1900	-	-	-	-	GPRS 4 Tx slots	Edge 1	0mm	Reduced	810	1909.8	16.98	17.50	1.127	-	-	0.06	0.970	1	1.093
2nd	GSM1900	-	-	-	-	GPRS 4 Tx slots	Edge 1	0mm	Reduced	810	1909.8	16.98	17.50	1.127	-	-	0.02	0.911	1.065	1.027

General Note:

1. Per KDB 865664 D01v01r04, for each frequency band, repeated SAR measurement is required only when the measured SAR is ≥ 0.8 W/kg.
2. Per KDB 865664 D01v01r04, if the ratio among the repeated measurement is ≤ 1.2 and the measured SAR < 1.45 W/kg, only one repeated measurement is required.
3. The ratio is the difference in percentage between original and repeated *measured SAR*.
4. All measurement SAR result is scaled-up to account for tune-up tolerance and is compliant.

Test Engineer : Martin Li, Varus Wang, Ricky Gu, Light Wang, Damon Zhu



15. Uncertainty Assessment

Per KDB 865664 D01 SAR measurement 100MHz to 6GHz, when the highest measured 1-g SAR within a frequency band is < 1.5 W/kg and the measured 10-g SAR within a frequency band is < 3.75 W/kg. The expanded SAR measurement uncertainty must be $\leq 30\%$, for a confidence interval of $k = 2$. If these conditions are met, extensive SAR measurement uncertainty analysis described in IEEE Std 1528-2013 is not required in SAR reports submitted for equipment approval. For this device, the highest measured 1-g SAR is less 1.5W/kg. Therefore, the measurement uncertainty table is not required in this report.



16. References

- [1] FCC 47 CFR Part 2 “Frequency Allocations and Radio Treaty Matters; General Rules and Regulations”
- [2] ANSI/IEEE Std. C95.1-1992, “IEEE Standard for Safety Levels with Respect to Human Exposure to Radio Frequency Electromagnetic Fields, 3 kHz to 300 GHz”, September 1992
- [3] IEEE Std. 1528-2013, “IEEE Recommended Practice for Determining the Peak Spatial-Average Specific Absorption Rate (SAR) in the Human Head from Wireless Communications Devices: Measurement Techniques”, Sep 2013
- [4] SPEAG DASY System Handbook
- [5] FCC KDB 865664 D01 v01r04, "SAR Measurement Requirements for 100 MHz to 6 GHz", Aug 2015.
- [6] FCC KDB 865664 D02 v01r02, “RF Exposure Compliance Reporting and Documentation Considerations” Oct 2015.
- [7] FCC KDB 447498 D01 v06, “Mobile and Portable Device RF Exposure Procedures and Equipment Authorization Policies”, Oct 2015
- [8] FCC KDB 248227 D01 v02r02, “SAR Guidance for IEEE 802.11 (WiFi) Transmitters”, Oct 2015.
- [9] FCC KDB 616217 D04 v01r02, “SAR Evaluation Considerations for Laptop, Notebook, Netbook and Tablet Computers”, Oct 2015
- [10] FCC KDB 941225 D01 v03r01, “3G SAR MEAUREMENT PROCEDURES”, Oct 2015
- [11] FCC KDB 941225 D05 v02r05, “SAR Evaluation Considerations for LTE Devices”, Dec 2015

-----THE END-----



Appendix A. Plots of System Performance Check

The plots are shown as follows.

System Check_Head_835MHz

DUT: D835V2-SN:4d162

Communication System: ; Frequency: 835.0

Medium: HSL. Medium parameters used: $f= 835.0$ MHz; $\sigma= 0.929$ S/m; $\epsilon_r = 40.9$

Ambient Temperature: 23.2°C; Liquid Temperature: 22.9°C

DASY6 Configuration:

- Probe: EX3DV4 - SN7630; ConvF(10.05, 10.05, 10.05); Calibrated: 2022-03-04
- Sensor-Surface: 1.4 mm
- Electronics: DAE4 Sn1691; Calibrated: 2021-10-04
- Phantom: ELI V8.0 (20deg probe tilt); Serial: 2151; Section: Flat
- Measurement Software: cDASY6 V6.6.0.13926

Area Scan (40.0 mm x 90.0 mm): Measurement Grid: 15.0 mm x 15.0 mm

SAR (1g) = 0.479 W/kg; SAR (10g) = 0.316 W/kg;

Zoom Scan (32.0 mm x 32.0 mm x 30.0 mm): Measurement Grid: 8.0 mm x 8.0 mm x 5.0 mm

Power Drift = 0.03 dB

SAR (1g) = 0.479 W/kg; SAR (10g) = 0.314 W/kg;

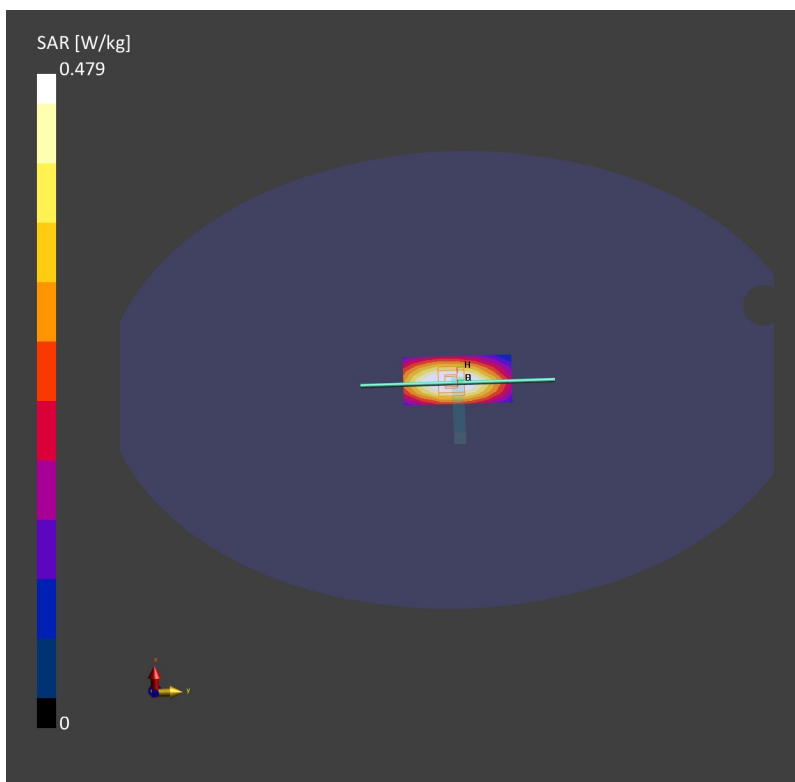

System Check_Head_1750MHz

DUT: D1750V2-SN:1090

Communication System: ; Frequency: 1750.0

Medium: HSL. Medium parameters used: $f= 1750.0$ MHz; $\sigma= 1.39$ S/m; $\epsilon_r = 40.5$

Ambient Temperature: 23.2°C; Liquid Temperature: 22.9°C

DASY6 Configuration:

- Probe: EX3DV4 - SN7630; ConvF(8.97, 8.97, 8.97); Calibrated: 2022-03-04
- Sensor-Surface: 1.4 mm
- Electronics: DAE4 Sn1691; Calibrated: 2021-10-04
- Phantom: ELI V8.0 (20deg probe tilt); Serial: 2151; Section: Flat
- Measurement Software: cDASY6 V6.6.0.13926

Area Scan (40.0 mm x 90.0 mm): Measurement Grid: 15.0 mm x 15.0 mm

SAR (1g) = 1.81 W/kg; SAR (10g) = 0.974 W/kg;

Zoom Scan (32.0 mm x 32.0 mm x 30.0 mm): Measurement Grid: 8.0 mm x 8.0 mm x 5.0 mm

Power Drift = -0.04 dB

SAR (1g) = 1.84 W/kg; SAR (10g) = 0.978 W/kg;

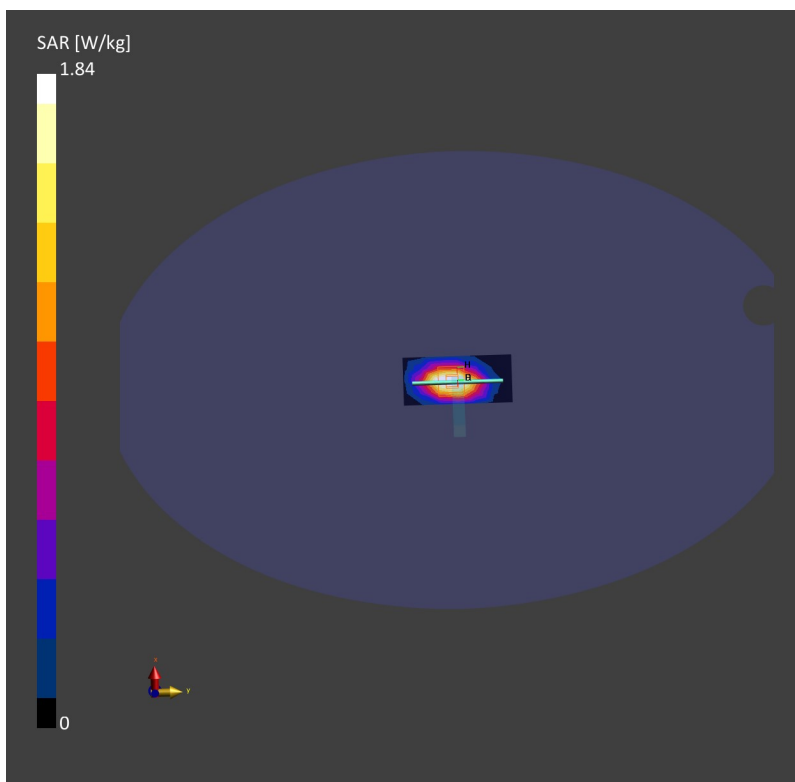

System Check_Head_1900MHz

DUT: D1900V2-SN:5d182

Communication System: ; Frequency: 1900.0

Medium: HSL. Medium parameters used: $f= 1900.0$ MHz; $\sigma= 1.45$ S/m; $\epsilon_r = 40.3$

Ambient Temperature: 23.2°C; Liquid Temperature: 22.7°C

DASY6 Configuration:

- Probe: EX3DV4 - SN7630; ConvF(8.51, 8.51, 8.51); Calibrated: 2022-03-04
- Sensor-Surface: 1.4 mm
- Electronics: DAE4 Sn1691; Calibrated: 2021-10-04
- Phantom: ELI V8.0 (20deg probe tilt); Serial: 2151; Section: Flat
- Measurement Software: cDASY6 V6.6.0.13926

Area Scan (40.0 mm x 90.0 mm): Measurement Grid: 15.0 mm x 15.0 mm

SAR (1g) = 1.86 W/kg; SAR (10g) = 0.981 W/kg;

Zoom Scan (32.0 mm x 32.0 mm x 30.0 mm): Measurement Grid: 8.0 mm x 8.0 mm x 5.0 mm

Power Drift = 0.04 dB

SAR (1g) = 1.95 W/kg; SAR (10g) = 0.993 W/kg;

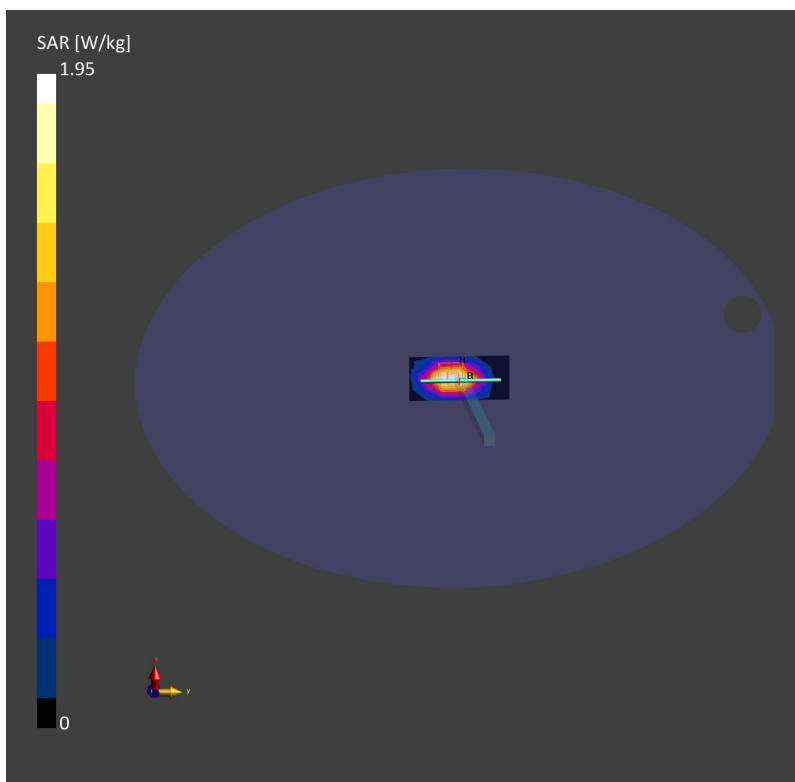

System Check_Head_2450MHz

DUT: D2450V2 - SN:924

Communication System: UID 0, CW (0); Frequency: 2450 MHz; Duty Cycle: 1:1
Medium: HSL_2450 Medium parameters used: $f = 2450$ MHz; $\sigma = 1.831$ S/m; $\epsilon_r = 37.486$; $\rho = 1000$ kg/m³

Ambient Temperature : 23.4 °C; Liquid Temperature : 22.6 °C

DASY5 Configuration:

- Probe: EX3DV4 - SN7706; ConvF(8.29, 8.29, 8.29); Calibrated: 2022/1/20
- Sensor-Surface: 1.4mm (Mechanical Surface Detection)
- Electronics: DAE4 Sn1279; Calibrated: 2021/9/21
- Phantom: ELI Phantom; Type: ELI V8.0; Serial: TP-2135
- Measurement SW: DASY52, Version 52.10 (4); SEMCAD X Version 14.6.14 (7483)

Pin=50mW/Area Scan (71x71x1): Interpolated grid: dx=1.200 mm, dy=1.200 mm
Maximum value of SAR (interpolated) = 4.00 W/kg

Pin=50mW/Zoom Scan (7x7x7)/Cube 0: Measurement grid: dx=5mm, dy=5mm, dz=5mm
Reference Value = 47.60 V/m; Power Drift = 0.03 dB
Peak SAR (extrapolated) = 4.94 W/kg
SAR(1 g) = 2.41 W/kg; SAR(10 g) = 1.13 W/kg
Maximum value of SAR (measured) = 4.01 W/kg

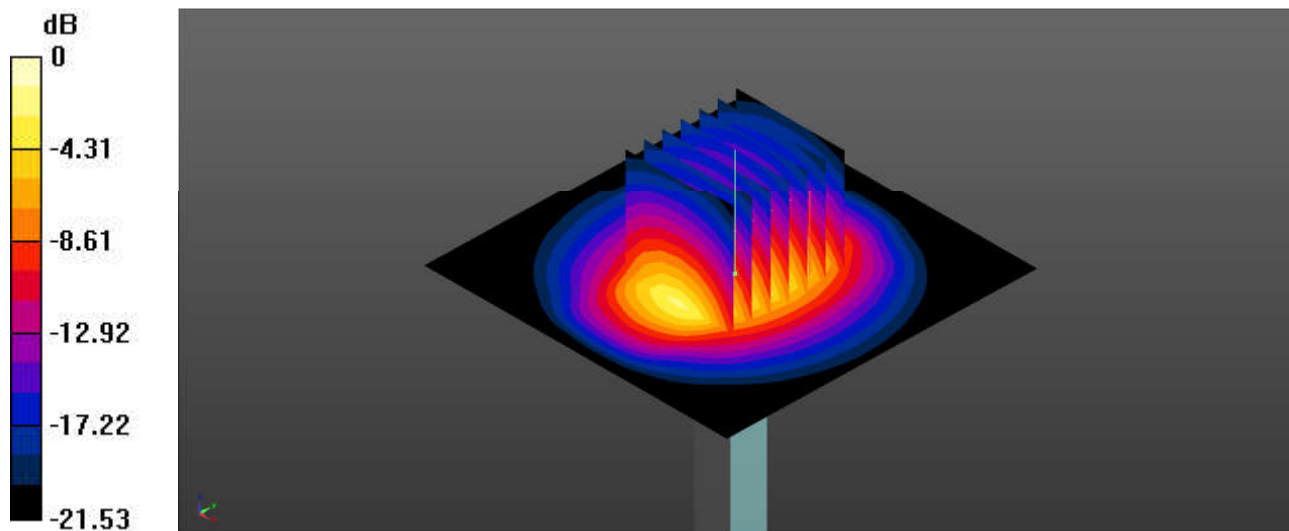

0 dB = 4.01 W/kg = 6.03 dBW/kg

System Check_Head_2600MHz

DUT: D2600V2-SN:1061

Communication System: ; Frequency: 2600.0

Medium: HSL. Medium parameters used: $f= 2600.0$ MHz; $\sigma= 1.93$ S/m; $\epsilon_r = 38.2$

Ambient Temperature: 23.2°C; Liquid Temperature: 22.6°C

DASY6 Configuration:

- Probe: EX3DV4 - SN7630; ConvF(7.82, 7.82, 7.82); Calibrated: 2022-03-04
- Sensor-Surface: 1.4 mm
- Electronics: DAE4 Sn1691; Calibrated: 2021-10-04
- Phantom: ELI V8.0 (20deg probe tilt); Serial: 2151; Section: Flat
- Measurement Software: cDASY6 V6.6.0.13926

Area Scan (40.0 mm x 96.0 mm): Measurement Grid: 12.0 mm x 12.0 mm

SAR (1g) = 2.50 W/kg; SAR (10g) = 1.12 W/kg;

Zoom Scan (30.0 mm x 30.0 mm x 30.0 mm): Measurement Grid: 5.0 mm x 5.0 mm x 5.0 mm

Power Drift = -0.02 dB

SAR (1g) = 2.63 W/kg; SAR (10g) = 1.18 W/kg;

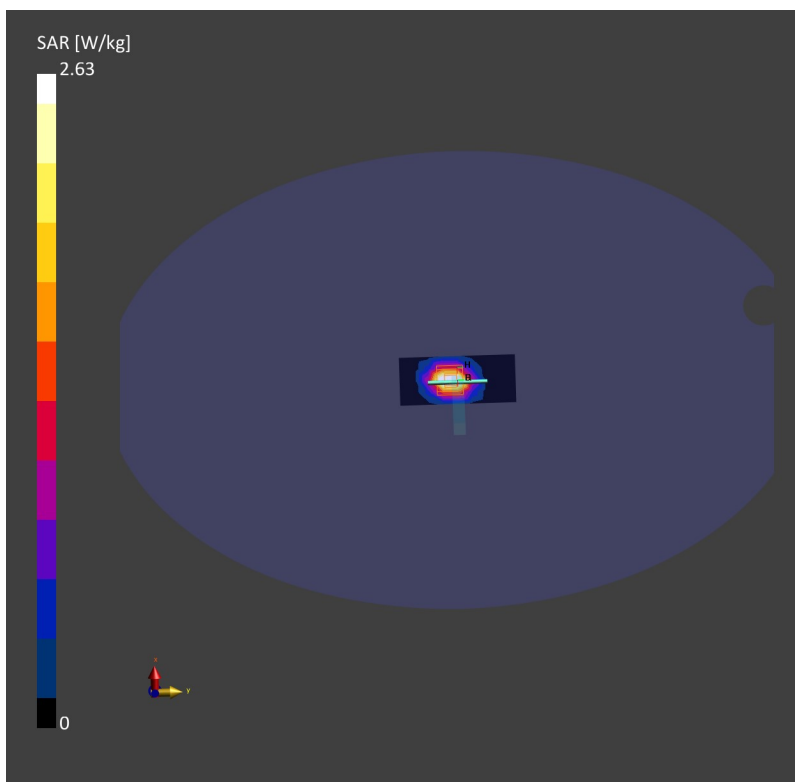

System Check_Head_5250MHz

DUT: D5GHzV2 - SN:1113

Communication System: UID 0, CW (0); Frequency: 5250 MHz; Duty Cycle: 1:1

Medium: HSL_5000 Medium parameters used: $f = 5250$ MHz; $\sigma = 4.663$ S/m; $\epsilon_r = 36.653$; $\rho = 1000$ kg/m³

Ambient Temperature : 23.1 °C; Liquid Temperature : 22.8 °C

DASY5 Configuration:

- Probe: EX3DV4 - SN7706; ConvF(6.07, 6.07, 6.07); Calibrated: 2022/1/20
- Sensor-Surface: 1.4mm (Mechanical Surface Detection)
- Electronics: DAE4 Sn1279; Calibrated: 2021/9/21
- Phantom: ELI Phantom; Type: ELI V8.0; Serial: TP-2135
- Measurement SW: DASY52, Version 52.10 (4); SEMCAD X Version 14.6.14 (7483)

Pin=50mW/Area Scan (91x91x1): Interpolated grid: dx=1.000 mm, dy=1.000 mm

Maximum value of SAR (interpolated) = 11.8 W/kg

Pin=50mW/Zoom Scan (7x7x7)/Cube 0: Measurement grid: dx=4mm, dy=4mm, dz=1.4mm

Reference Value = 49.13 V/m; Power Drift = 0.08 dB

Peak SAR (extrapolated) = 19.2 W/kg

SAR(1 g) = 4.29 W/kg; SAR(10 g) = 1.13 W/kg

Maximum value of SAR (measured) = 12.2 W/kg

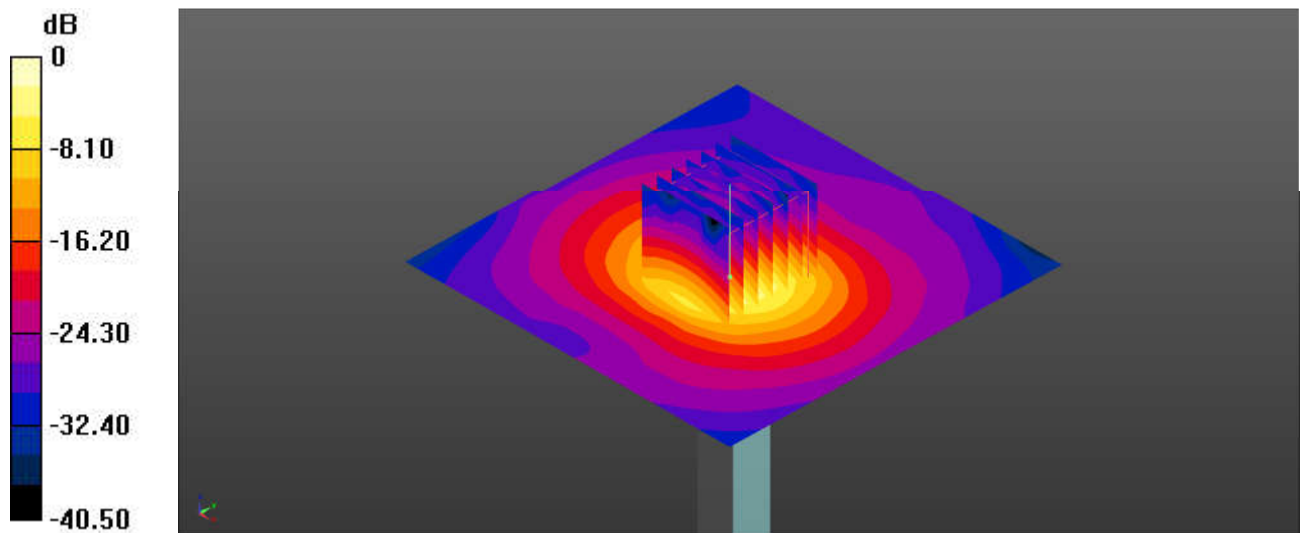

0 dB = 12.2 W/kg = 10.86 dBW/kg

System Check_Head_5600MHz

DUT: D5GHzV2 - SN:1113

Communication System: UID 0, CW (0); Frequency: 5600 MHz; Duty Cycle: 1:1

Medium: HSL_5000 Medium parameters used: $f = 5600$ MHz; $\sigma = 5.07$ S/m; $\epsilon_r = 36.008$; $\rho = 1000$ kg/m³

Ambient Temperature : 23.1 °C; Liquid Temperature : 22.8 °C

DASY5 Configuration:

- Probe: EX3DV4 - SN7706; ConvF(5.3, 5.3, 5.3); Calibrated: 2022/1/20
- Sensor-Surface: 1.4mm (Mechanical Surface Detection)
- Electronics: DAE4 Sn1279; Calibrated: 2021/9/21
- Phantom: ELI Phantom; Type: ELI V8.0; Serial: TP-2135
- Measurement SW: DASY52, Version 52.10 (4); SEMCAD X Version 14.6.14 (7483)

Pin=50mW/Area Scan (91x91x1): Interpolated grid: dx=1.000 mm, dy=1.000 mm
Maximum value of SAR (interpolated) = 10.6 W/kg

Pin=50mW/Zoom Scan (7x7x7)/Cube 0: Measurement grid: dx=4mm, dy=4mm, dz=1.4mm

Reference Value = 38.65 V/m; Power Drift = 0.05 dB

Peak SAR (extrapolated) = 20.0 W/kg

SAR(1 g) = 4.39 W/kg; SAR(10 g) = 1.17 W/kg

Maximum value of SAR (measured) = 10.2 W/kg

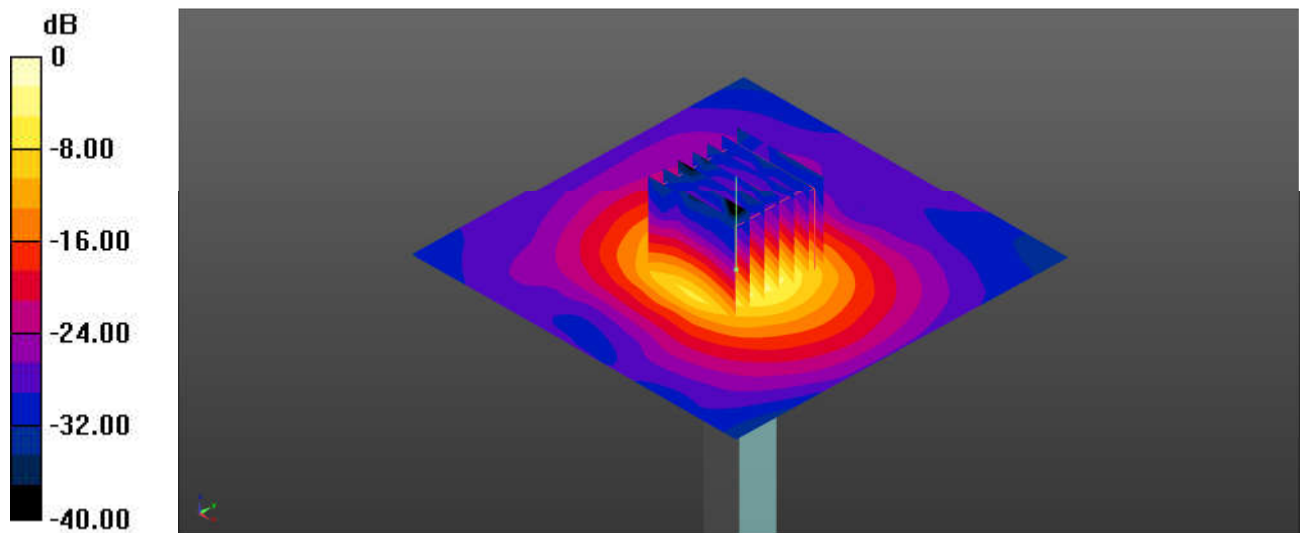

0 dB = 10.2 W/kg = 11.21 dBW/kg

System Check_Head_5750MHz

DUT: D5GHzV2 - SN:1113

Communication System: UID 0, CW (0); Frequency: 5750 MHz; Duty Cycle: 1:1
Medium: HSL_5000 Medium parameters used: $f = 5750$ MHz; $\sigma = 5.241$ S/m; $\epsilon_r = 35.762$; $\rho = 1000$ kg/m³

Ambient Temperature : 23.1 °C; Liquid Temperature : 22.9 °C

DASY5 Configuration:

- Probe: EX3DV4 - SN7706; ConvF(5.49, 5.49, 5.49); Calibrated: 2022/1/20
- Sensor-Surface: 1.4mm (Mechanical Surface Detection)
- Electronics: DAE4 Sn1279; Calibrated: 2021/9/21
- Phantom: ELI Phantom; Type: ELI V8.0; Serial: TP-2135
- Measurement SW: DASY52, Version 52.10 (4); SEMCAD X Version 14.6.14 (7483)

Pin=50mW/Area Scan (91x91x1): Interpolated grid: dx=1.000 mm, dy=1.000 mm
Maximum value of SAR (interpolated) = 12.0 W/kg

Pin=50mW/Zoom Scan (7x7x7)/Cube 0: Measurement grid: dx=4mm, dy=4mm, dz=1.4mm
Reference Value = 46.72 V/m; Power Drift = -0.08 dB
Peak SAR (extrapolated) = 21.5 W/kg
SAR(1 g) = 4.24 W/kg; SAR(10 g) = 1.21 W/kg
Maximum value of SAR (measured) = 12.6 W/kg

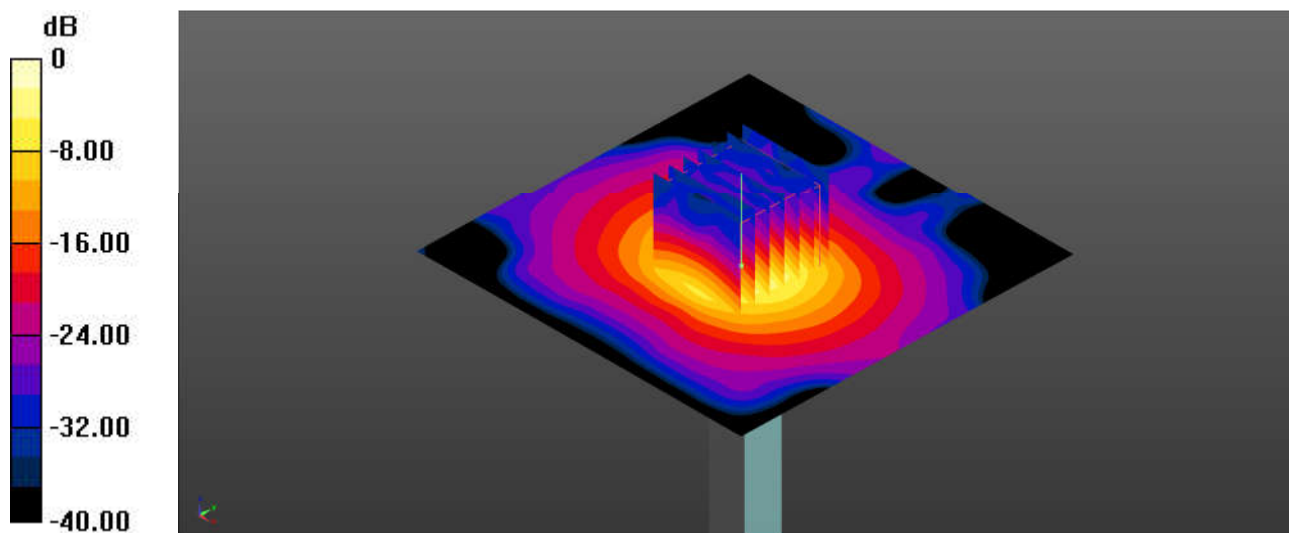

0 dB = 12.6 W/kg = 11.00 dBW/kg



Appendix B. Plots of SAR Measurement

The plots are shown as follows.

01_GSM850_GPRS (4 Tx slots)_Edge1_0mm_Ch189

Communication System: GSM 850; Frequency: 836.4

Medium: HSL. Medium parameters used: $f= 836.4$ MHz; $\sigma= 0.930$ S/m; $\epsilon_r = 40.9$

Ambient Temperature: 23.2°C; Liquid Temperature: 22.9°C

DASY6 Configuration:

- Probe: EX3DV4 - SN7630; ConvF(10.05, 10.05, 10.05); Calibrated: 2022-03-04
- Sensor-Surface: 1.4 mm
- Electronics: DAE4 Sn1691; Calibrated: 2021-10-04
- Phantom: ELI V8.0 (20deg probe tilt); Serial: 2151; Section: Flat
- Measurement Software: cDASY6 V6.6.0.13926

Area Scan (32.0 mm x 180.0 mm): Measurement Grid: 15.0 mm x 15.0 mm

SAR (1g) = 0.649 W/kg; SAR (10g) = 0.354 W/kg;

Zoom Scan (32.0 mm x 32.0 mm x 30.0 mm): Measurement Grid: 8.0 mm x 8.0 mm x 5.0 mm

Power Drift = 0.02 dB

SAR (1g) = 0.708 W/kg; SAR (10g) = 0.374 W/kg;

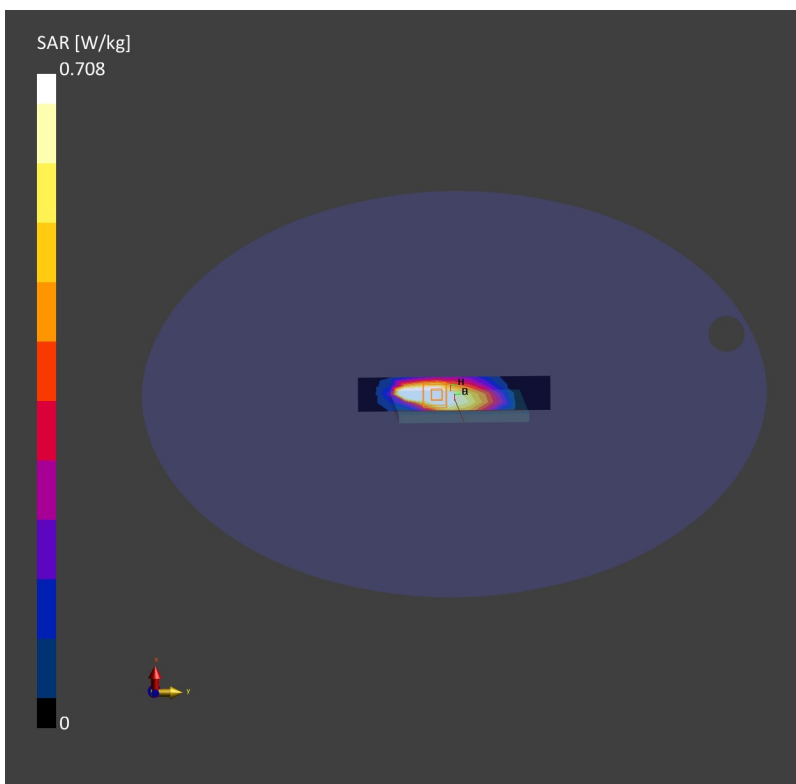

02_GSM1900_GPRS (4 Tx slots)_Edge 1_0mm_Ch810

Communication System: PCS 1900; Frequency: 1909.8

Medium: HSL. Medium parameters used: $f= 1909.8$ MHz; $\sigma= 1.48$ S/m; $\epsilon_r = 40.3$

Ambient Temperature: 23.2°C; Liquid Temperature: 22.7°C

DASY6 Configuration:

- Probe: EX3DV4 - SN7630; ConvF(8.51, 8.51, 8.51); Calibrated: 2022-03-04
- Sensor-Surface: 1.4 mm
- Electronics: DAE4 Sn1691; Calibrated: 2021-10-04
- Phantom: ELI V8.0 (20deg probe tilt); Serial: 2151; Section: Flat
- Measurement Software: cDASY6 V6.6.0.13926

Area Scan (48.0 mm x 180.0 mm): Measurement Grid: 15.0 mm x 15.0 mm

SAR (1g) = 0.939 W/kg; SAR (10g) = 0.407 W/kg;

Zoom Scan (32.0 mm x 32.0 mm x 30.0 mm): Measurement Grid: 8.0 mm x 8.0 mm x 5.0 mm

Power Drift = 0.06 dB

SAR (1g) = 0.970 W/kg; SAR (10g) = 0.402 W/kg;

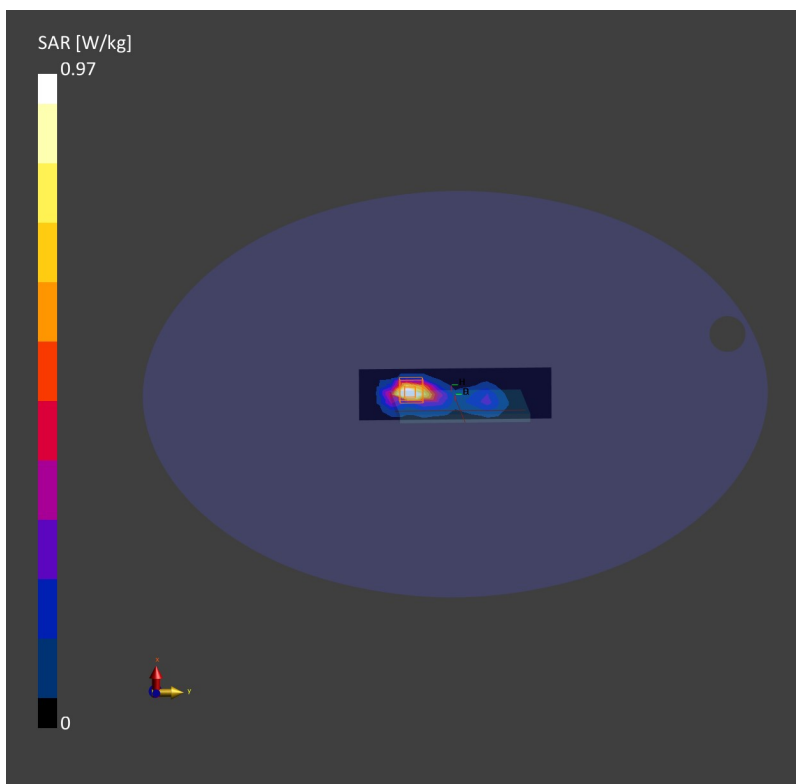

03_WCDMA V_RMC 12.2Kbps_Edge 1_0mm_Ch4182

Communication System: Band 5, UTRA/FDD; Frequency: 836.4
Medium: HSL. Medium parameters used: $f = 836.4$ MHz; $\sigma = 0.930$ S/m; $\epsilon_r = 40.9$
Ambient Temperature: 23.2°C; Liquid Temperature: 22.9°C

DASY6 Configuration:

- Probe: EX3DV4 - SN7630; ConvF(10.05, 10.05, 10.05); Calibrated: 2022-03-04
- Sensor-Surface: 1.4 mm
- Electronics: DAE4 Sn1691; Calibrated: 2021-10-04
- Phantom: ELI V8.0 (20deg probe tilt); Serial: 2151; Section: Flat
- Measurement Software: cDASY6 V6.6.0.13926

Area Scan (32.0 mm x 150.0 mm): Measurement Grid: 15.0 mm x 15.0 mm
SAR (1g) = 0.740 W/kg; SAR (10g) = 0.441 W/kg;

Zoom Scan (32.0 mm x 32.0 mm x 30.0 mm): Measurement Grid: 8.0 mm x 8.0 mm x 5.0 mm
Power Drift = 0.01 dB
SAR (1g) = 0.791 W/kg; SAR (10g) = 0.420 W/kg;

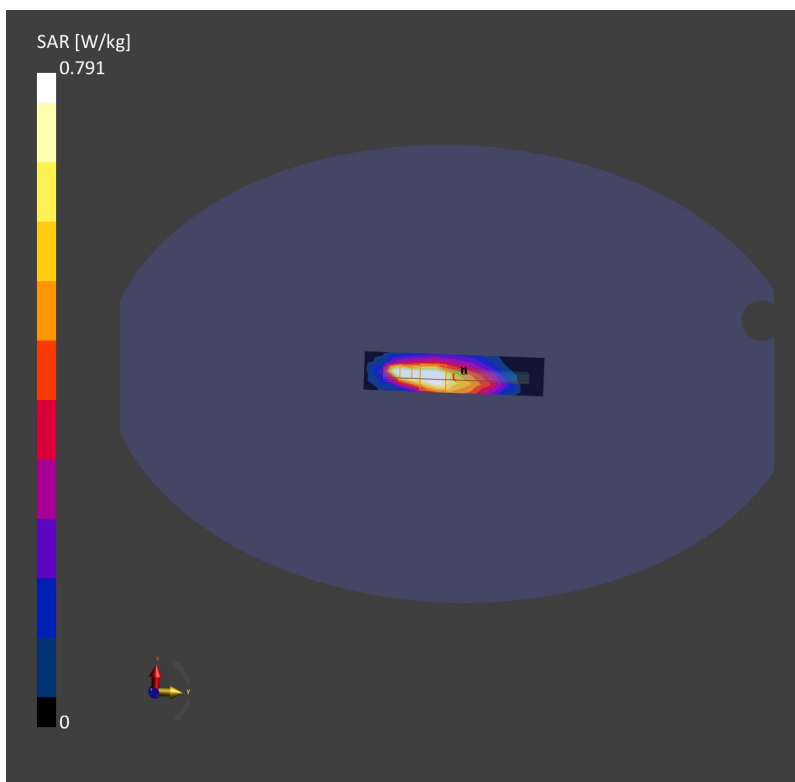

04_WCDMA II_RMC 12.2Kbps_Edge 1_0mm_Ch9538

Communication System: Band 2, UTRA/FDD; Frequency: 1907.6
Medium: HSL. Medium parameters used: $f=1907.6$ MHz; $\sigma=1.48$ S/m; $\epsilon_r=40.3$
Ambient Temperature: 23.2°C; Liquid Temperature: 22.7°C

DASY6 Configuration:

- Probe: EX3DV4 - SN7630; ConvF(8.51, 8.51, 8.51); Calibrated: 2022-03-04
- Sensor-Surface: 1.4 mm
- Electronics: DAE4 Sn1691; Calibrated: 2021-10-04
- Phantom: ELI V8.0 (20deg probe tilt); Serial: 2151; Section: Flat
- Measurement Software: cDASY6 V6.6.0.13926

Area Scan (32.0 mm x 180.0 mm): Measurement Grid: 15.0 mm x 15.0 mm
SAR (1g) = 0.688 W/kg; SAR (10g) = 0.227 W/kg;

Zoom Scan (32.0 mm x 32.0 mm x 30.0 mm): Measurement Grid: 8.0 mm x 8.0 mm x 5.0 mm
Power Drift = -0.01 dB
SAR (1g) = 0.711 W/kg; SAR (10g) = 0.265 W/kg;

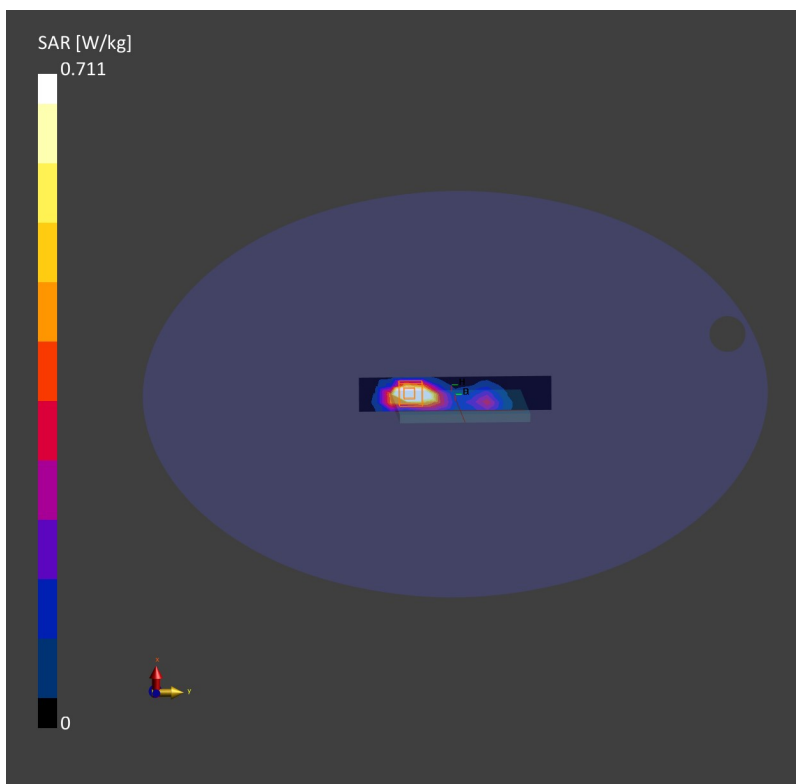

05_LTE Band 2_20M_QPSK_50RB_24Offset_Edge 1_0mm_Ch19100

Communication System: Band 2, E-UTRA/FDD; Frequency: 1900.0

Medium: HSL. Medium parameters used: $f=1900.0$ MHz; $\sigma=1.48$ S/m; $\epsilon_r=40.3$

Ambient Temperature: 23.2°C; Liquid Temperature: 22.7°C

DASY6 Configuration:

- Probe: EX3DV4 - SN7630; ConvF(8.51, 8.51, 8.51); Calibrated: 2022-03-04
- Sensor-Surface: 1.4 mm
- Electronics: DAE4 Sn1691; Calibrated: 2021-10-04
- Phantom: ELI V8.0 (20deg probe tilt); Serial: 2151; Section: Flat
- Measurement Software: cDASY6 V6.6.0.13926

Area Scan (48.0 mm x 180.0 mm): Measurement Grid: 15.0 mm x 15.0 mm

SAR (1g) = 0.708 W/kg; SAR (10g) = 0.306 W/kg;

Zoom Scan (32.0 mm x 32.0 mm x 30.0 mm): Measurement Grid: 8.0 mm x 8.0 mm x 5.0 mm

Power Drift = -0.06 dB

SAR (1g) = 0.710 W/kg; SAR (10g) = 0.299 W/kg;

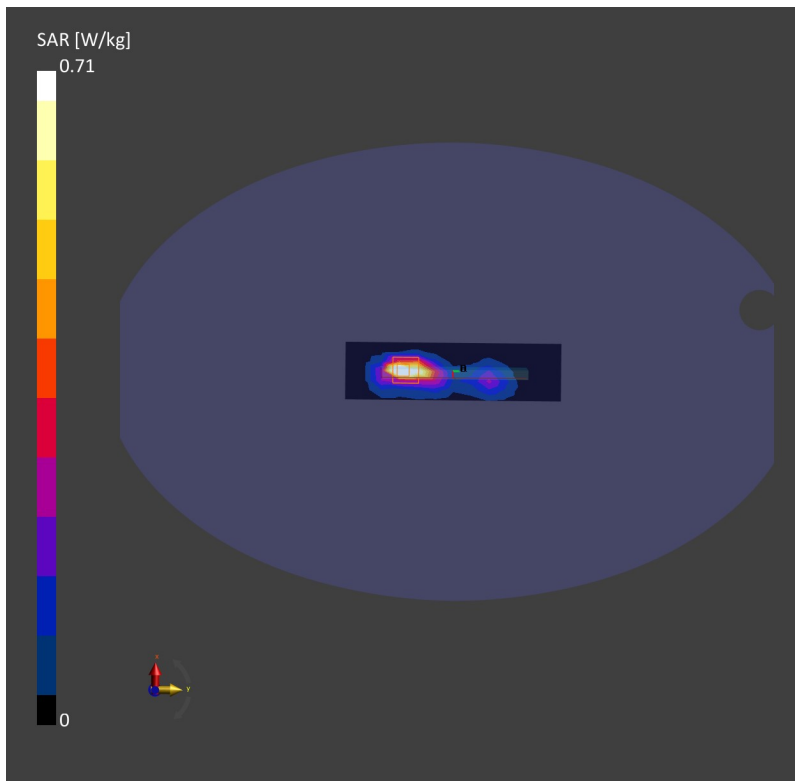

06_LTE Band 4_20M_QPSK_50RB_24Offset_Bottom Face_0mm_Ch20175

Communication System: Band 4, E-UTRA/FDD; Frequency: 1732.5

Medium: HSL. Medium parameters used: $f=1732.5$ MHz; $\sigma=1.38$ S/m; $\epsilon_r=40.6$

Ambient Temperature: 23.2°C; Liquid Temperature: 22.9°C

DASY6 Configuration:

- Probe: EX3DV4 - SN7630; ConvF(8.97, 8.97, 8.97); Calibrated: 2022-03-04
- Sensor-Surface: 1.4 mm
- Electronics: DAE4 Sn1691; Calibrated: 2021-10-04
- Phantom: ELI V8.0 (20deg probe tilt); Serial: 2151; Section: Flat
- Measurement Software: cDASY6 V6.6.0.13926

Area Scan (60.0 mm x 90.0 mm): Measurement Grid: 15.0 mm x 15.0 mm

SAR (1g) = 0.546 W/kg; SAR (10g) = 0.288 W/kg;

Zoom Scan (32.0 mm x 32.0 mm x 30.0 mm): Measurement Grid: 8.0 mm x 8.0 mm x 5.0 mm

Power Drift = -0.03 dB

SAR (1g) = 0.604 W/kg; SAR (10g) = 0.276 W/kg;

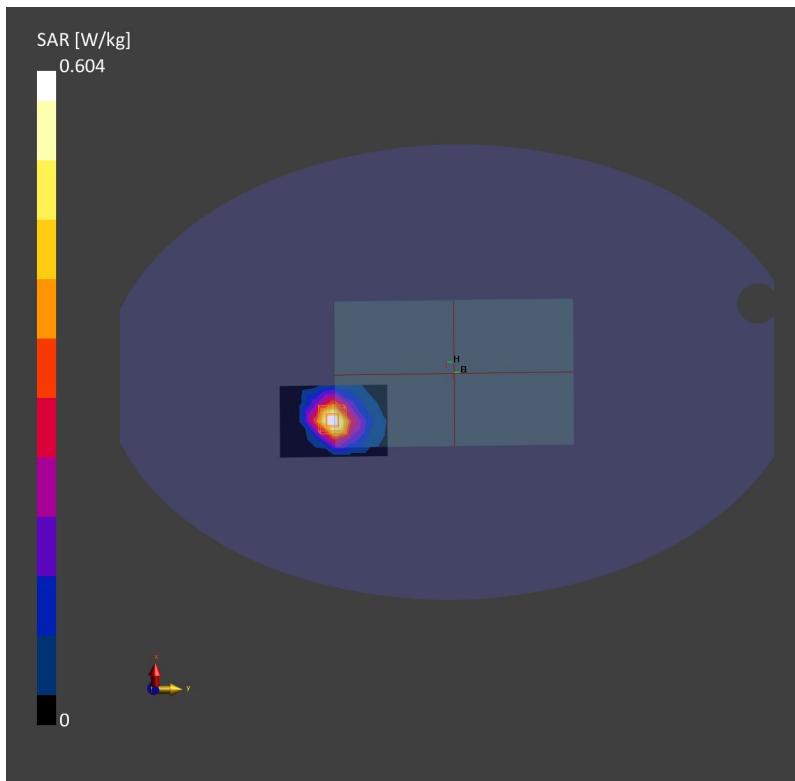

07_LTE Band 5_10M_QPSK_50RB_0Offset_Edge 1_0mm_Ch20525

Communication System: Band 5, E-UTRA/FDD; Frequency: 836.5
Medium: HSL. Medium parameters used: $f = 836.5$ MHz; $\sigma = 0.930$ S/m; $\epsilon_r = 40.9$
Ambient Temperature: 23.2°C; Liquid Temperature: 22.9°C

DASY6 Configuration:

- Probe: EX3DV4 - SN7630; ConvF(10.05, 10.05, 10.05); Calibrated: 2022-03-04
- Sensor-Surface: 1.4 mm
- Electronics: DAE4 Sn1691; Calibrated: 2021-10-04
- Phantom: ELI V8.0 (20deg probe tilt); Serial: 2151; Section: Flat
- Measurement Software: cDASY6 V6.6.0.13926

Area Scan (48.0 mm x 180.0 mm): Measurement Grid: 15.0 mm x 15.0 mm
SAR (1g) = 0.744 W/kg; SAR (10g) = 0.424 W/kg;

Zoom Scan (32.0 mm x 32.0 mm x 30.0 mm): Measurement Grid: 8.0 mm x 8.0 mm x 5.0 mm
Power Drift = -0.02 dB
SAR (1g) = 0.748 W/kg; SAR (10g) = 0.388 W/kg;

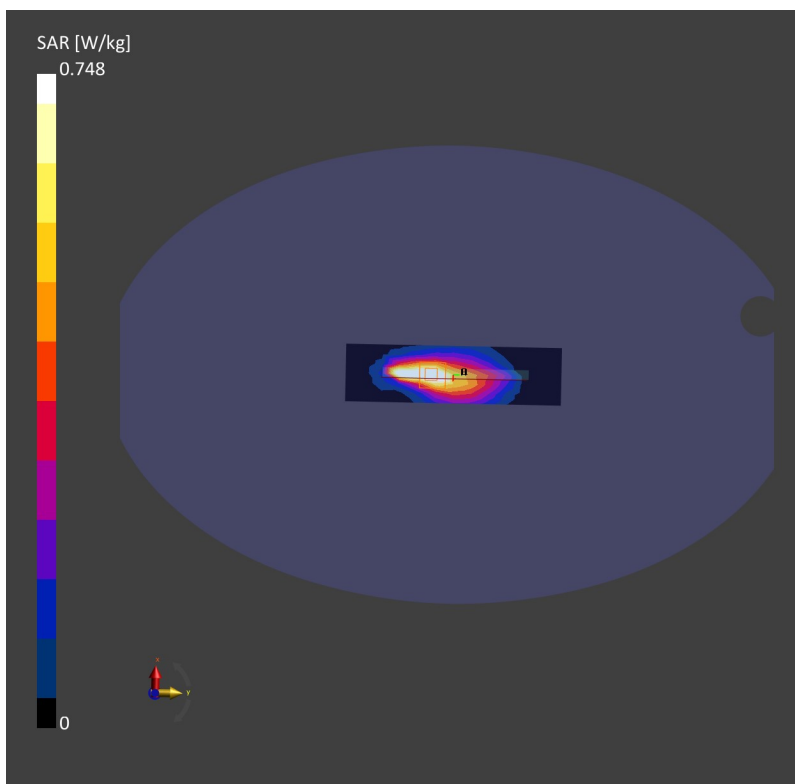

08_LTE Band 7_20M_QPSK_1RB_49Offset_Edge 4_8mm_Ch21350

Communication System: Band 7, E-UTRA/FDD; Frequency: 2560.0
Medium: HSL. Medium parameters used: $f= 2560.0$ MHz; $\sigma= 1.88$ S/m; $\epsilon_r = 38.4$
Ambient Temperature: 23.2°C; Liquid Temperature: 22.6°C

DASY6 Configuration:

- Probe: EX3DV4 - SN7630; ConvF(7.82, 7.82, 7.82); Calibrated: 2022-03-04
- Sensor-Surface: 1.4 mm
- Electronics: DAE4 Sn1691; Calibrated: 2021-10-04
- Phantom: ELI V8.0 (20deg probe tilt); Serial: 2151; Section: Flat
- Measurement Software: cDASY6 V6.6.0.13926

Area Scan (48.0 mm x 240.0 mm): Measurement Grid: 12.0 mm x 12.0 mm
SAR (1g) = 0.505 W/kg; SAR (10g) = 0.257 W/kg;

Zoom Scan (30.0 mm x 30.0 mm x 30.0 mm): Measurement Grid: 5.0 mm x 5.0 mm x 5.0 mm
Power Drift = -0.09 dB
SAR (1g) = 0.525 W/kg; SAR (10g) = 0.261 W/kg;

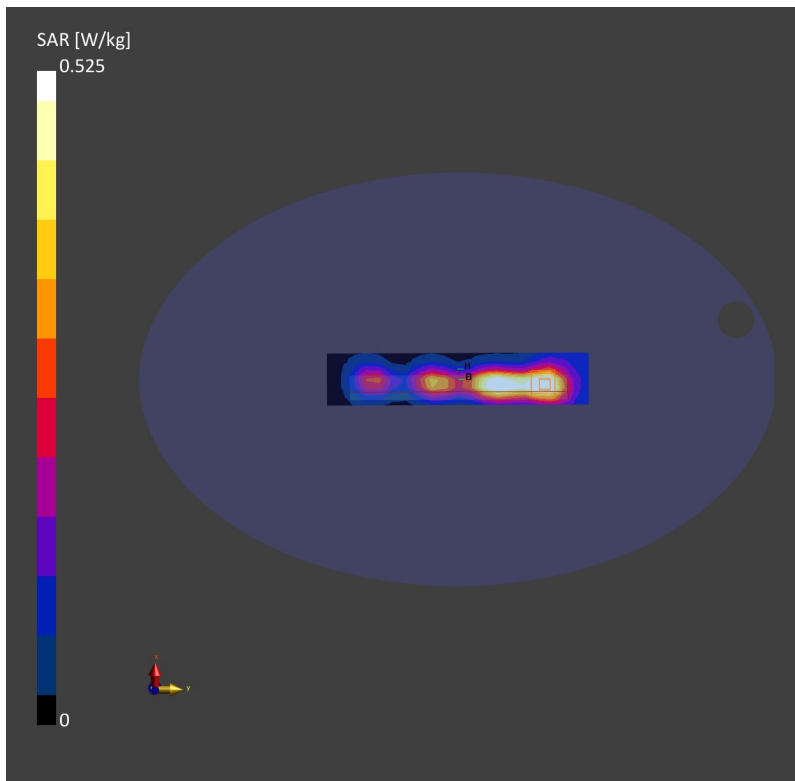

09_LTE Band 38_20M_QPSK_50RB_0Offset_Bottom Face_0mm_Ch38000

Communication System: Band 38, E-UTRA/TDD; Frequency: 2595.0
Medium: HSL. Medium parameters used: $f= 2595.0$ MHz; $\sigma= 1.92$ S/m; $\epsilon_r = 38.2$
Ambient Temperature: 23.2°C; Liquid Temperature: 22.6°C

DASY6 Configuration:

- Probe: EX3DV4 - SN7630; ConvF(7.82, 7.82, 7.82); Calibrated: 2022-03-04
- Sensor-Surface: 1.4 mm
- Electronics: DAE4 Sn1691; Calibrated: 2021-10-04
- Phantom: ELI V8.0 (20deg probe tilt); Serial: 2151; Section: Flat
- Measurement Software: cDASY6 V6.6.0.13926

Area Scan (96.0 mm x 96.0 mm): Measurement Grid: 12.0 mm x 12.0 mm
SAR (1g) = 0.609 W/kg; SAR (10g) = 0.283 W/kg;

Zoom Scan (30.0 mm x 30.0 mm x 30.0 mm): Measurement Grid: 5.0 mm x 5.0 mm x 5.0 mm
Power Drift = 0.03 dB
SAR (1g) = 0.674 W/kg; SAR (10g) = 0.298 W/kg;

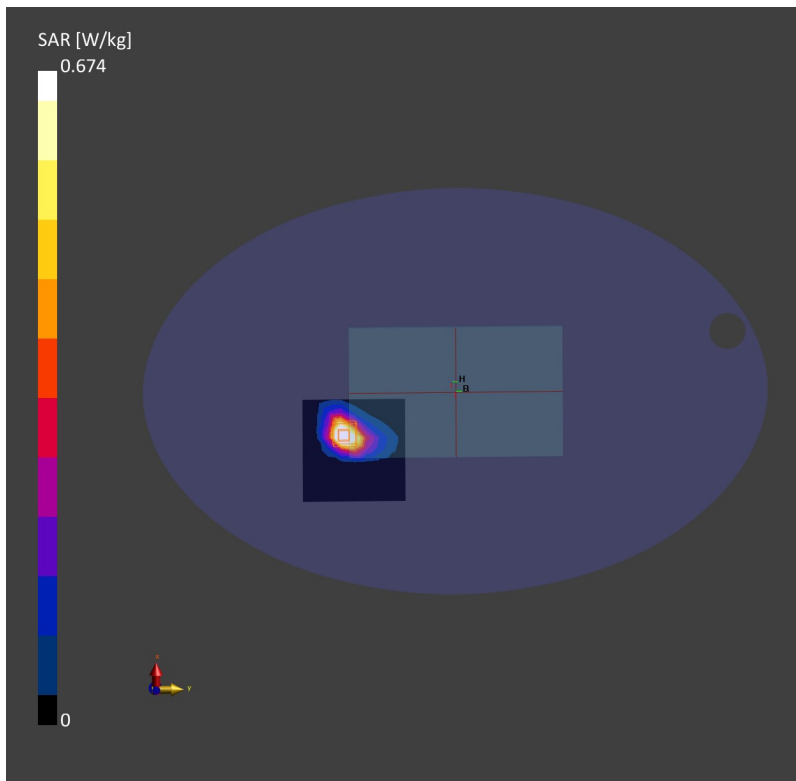

10_WLAN2.4GHz_802.11b 1Mbps_Bottom Face_0mm_Ch6

Communication System: UID 0, WLAN2.4GHz (0); Frequency: 2437 MHz; Duty Cycle: 1:1
Medium: HSL_2450 Medium parameters used: $f = 2437$ MHz; $\sigma = 1.823$ S/m; $\epsilon_r = 37.487$; $\rho = 1000$ kg/m³

Ambient Temperature : 23.4 °C; Liquid Temperature : 22.6 °C

DASY5 Configuration:

- Probe: EX3DV4 - SN7706; ConvF(8.29, 8.29, 8.29); Calibrated: 2022/1/20
- Sensor-Surface: 1.4mm (Mechanical Surface Detection)
- Electronics: DAE4 Sn1279; Calibrated: 2021/9/21
- Phantom: ELI Phantom; Type: ELI V8.0; Serial: TP-2135
- Measurement SW: DASY52, Version 52.10 (4); SEMCAD X Version 14.6.14 (7483)

Area Scan (141x111x1): Interpolated grid: dx=1.200 mm, dy=1.200 mm

Maximum value of SAR (interpolated) = 1.72 W/kg

Zoom Scan (7x7x7)/Cube 0: Measurement grid: dx=5mm, dy=5mm, dz=5mm

Reference Value = 0 V/m; Power Drift = 0.01 dB

Peak SAR (extrapolated) = 2.21 W/kg

SAR(1 g) = 0.762 W/kg; SAR(10 g) = 0.298 W/kg

Maximum value of SAR (measured) = 1.55 W/kg

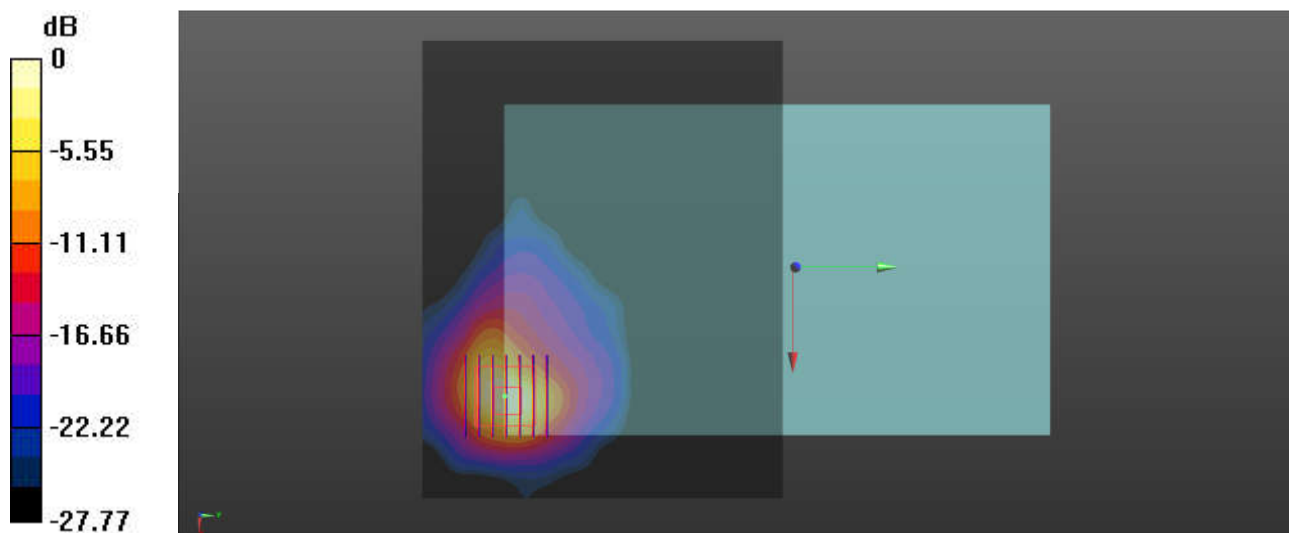

0 dB = 1.55 W/kg = 1.90 dBW/kg

11_WLAN5GHz_802.11a 6Mbps_Edge 1_0mm_Ch60

Communication System: UID 0, WLAN5GHz (0); Frequency: 5300 MHz; Duty Cycle: 1:1.031
Medium: HSL_5000 Medium parameters used: $f = 5300$ MHz; $\sigma = 4.734$ S/m; $\epsilon_r = 36.559$; $\rho = 1000$ kg/m³

Ambient Temperature : 23.1 °C; Liquid Temperature : 22.8 °C

DASY5 Configuration:

- Probe: EX3DV4 - SN7706; ConvF(6.07, 6.07, 6.07); Calibrated: 2022/1/20
- Sensor-Surface: 1.4mm (Mechanical Surface Detection)
- Electronics: DAE4 Sn1279; Calibrated: 2021/9/21
- Phantom: ELI Phantom; Type: ELI V8.0; Serial: TP-2135
- Measurement SW: DASY52, Version 52.10 (4); SEMCAD X Version 14.6.14 (7483)

Area Scan (61x161x1): Interpolated grid: dx=1.000 mm, dy=1.000 mm

Maximum value of SAR (interpolated) = 1.34 W/kg

Zoom Scan (9x9x7)/Cube 0: Measurement grid: dx=4mm, dy=4mm, dz=1.4mm

Reference Value = 18.98 V/m; Power Drift = -0.03 dB

Peak SAR (extrapolated) = 2.85 W/kg

SAR(1 g) = 0.469 W/kg; SAR(10 g) = 0.144 W/kg

Maximum value of SAR (measured) = 1.35 W/kg

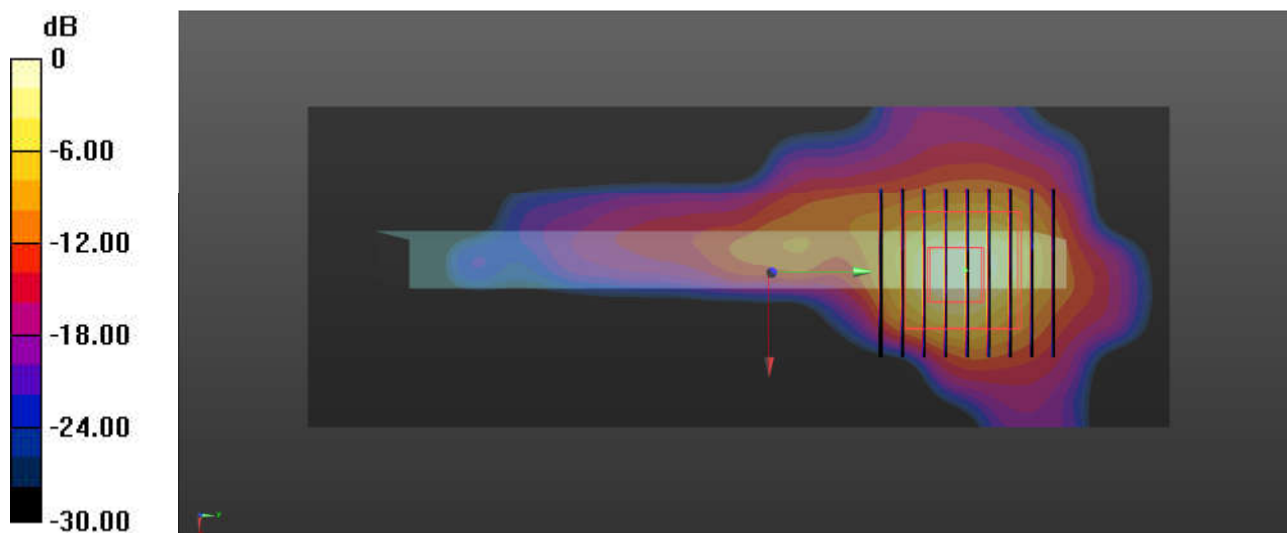

0 dB = 1.35 W/kg = 1.30 dBW/kg

12_WLAN5GHz_802.11a 6Mbps_Edge 1_0mm_Ch100

Communication System: UID 0, WLAN5GHz (0); Frequency: 5500 MHz; Duty Cycle: 1:1.031
Medium: HSL_5000 Medium parameters used: $f = 5500$ MHz; $\sigma = 4.958$ S/m; $\epsilon_r = 36.202$; $\rho = 1000$ kg/m³

Ambient Temperature : 23.1 °C; Liquid Temperature : 22.8 °C

DASY5 Configuration:

- Probe: EX3DV4 - SN7706; ConvF(5.3, 5.3, 5.3); Calibrated: 2022/1/20
- Sensor-Surface: 1.4mm (Mechanical Surface Detection)
- Electronics: DAE4 Sn1279; Calibrated: 2021/9/21
- Phantom: ELI Phantom; Type: ELI V8.0; Serial: TP-2135
- Measurement SW: DASY52, Version 52.10 (4); SEMCAD X Version 14.6.14 (7483)

Area Scan (61x161x1): Interpolated grid: dx=1.000 mm, dy=1.000 mm

Maximum value of SAR (interpolated) = 1.19 W/kg

Zoom Scan (9x9x7)/Cube 0: Measurement grid: dx=4mm, dy=4mm, dz=1.4mm

Reference Value = 18.11 V/m; Power Drift = -0.06 dB

Peak SAR (extrapolated) = 2.72 W/kg

SAR(1 g) = 0.381 W/kg; SAR(10 g) = 0.139 W/kg

Maximum value of SAR (measured) = 1.12 W/kg

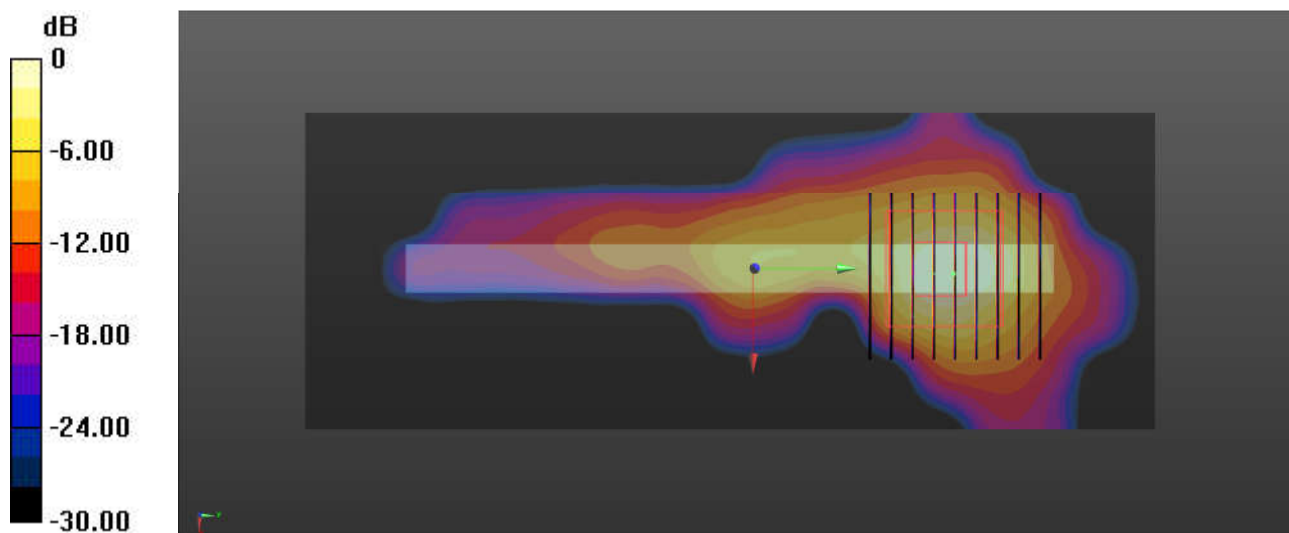

0 dB = 1.12 W/kg = 0.49 dBW/kg

13_WLAN5GHz_802.11a 6Mbps_Edge 1_0mm_Ch157

Communication System: UID 0, WLAN5GHz (0); Frequency: 5785 MHz; Duty Cycle: 1:1.031
Medium: HSL_5000 Medium parameters used: $f = 5785 \text{ MHz}$; $\sigma = 5.292 \text{ S/m}$; $\epsilon_r = 35.692$; $\rho = 1000 \text{ kg/m}^3$

Ambient Temperature : 23.1 °C; Liquid Temperature : 22.9 °C

DASY5 Configuration:

- Probe: EX3DV4 - SN7706; ConvF(5.49, 5.49, 5.49); Calibrated: 2022/1/20
- Sensor-Surface: 1.4mm (Mechanical Surface Detection)
- Electronics: DAE4 Sn1279; Calibrated: 2021/9/21
- Phantom: ELI Phantom; Type: ELI V8.0; Serial: TP-2135
- Measurement SW: DASY52, Version 52.10 (4); SEMCAD X Version 14.6.14 (7483)

Area Scan (61x161x1): Interpolated grid: $dx=1.000 \text{ mm}$, $dy=1.000 \text{ mm}$
Maximum value of SAR (interpolated) = 1.20 W/kg

Zoom Scan (9x10x7)/Cube 0: Measurement grid: $dx=4\text{mm}$, $dy=4\text{mm}$, $dz=1.4\text{mm}$
Reference Value = 17.75 V/m; Power Drift = -0.05 dB
Peak SAR (extrapolated) = 2.33 W/kg
SAR(1 g) = 0.449 W/kg; SAR(10 g) = 0.136 W/kg
Maximum value of SAR (measured) = 1.31 W/kg

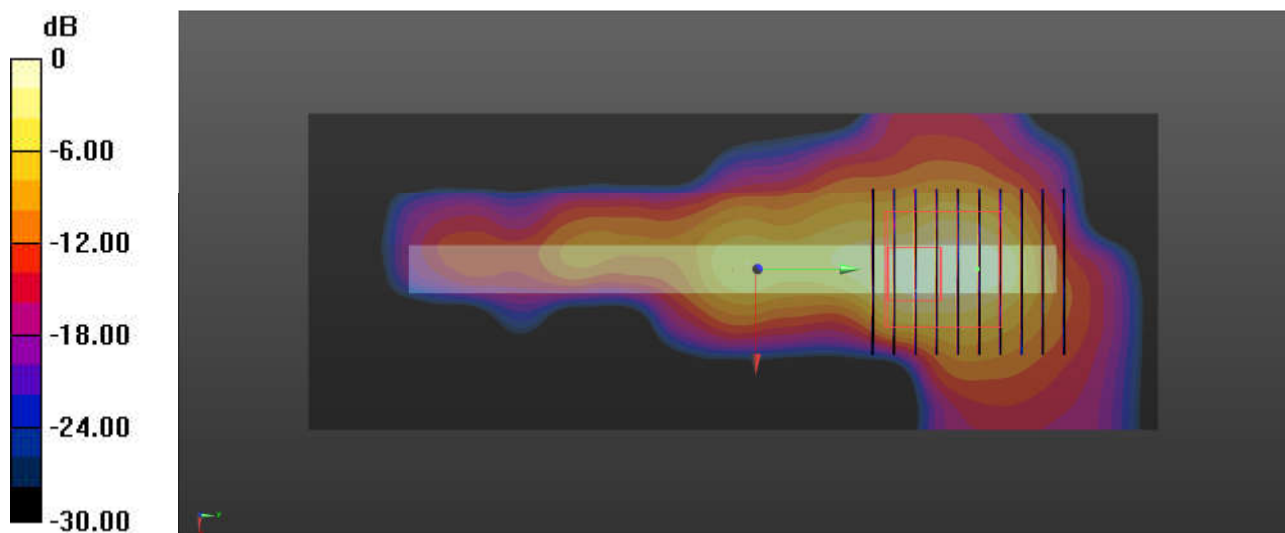

0 dB = 1.31 W/kg = 1.17 dBW/kg

14_Bluetooth_1Mbps_Bottom Face_0mm_Ch78

Communication System: UID 0, Bluetooth (0); Frequency: 2480 MHz; Duty Cycle: 1:1.086
Medium: HSL_2450 Medium parameters used: $f = 2480$ MHz; $\sigma = 1.847$ S/m; $\epsilon_r = 37.444$; $\rho = 1000$ kg/m³

Ambient Temperature : 23.4 °C; Liquid Temperature : 22.6 °C

DASY5 Configuration:

- Probe: EX3DV4 - SN7706; ConvF(8.29, 8.29, 8.29); Calibrated: 2022/1/20
- Sensor-Surface: 1.4mm (Mechanical Surface Detection)
- Electronics: DAE4 Sn1279; Calibrated: 2021/9/21
- Phantom: ELI Phantom; Type: ELI V8.0; Serial: TP-2135
- Measurement SW: DASY52, Version 52.10 (4); SEMCAD X Version 14.6.14 (7483)

Area Scan (141x111x1): Interpolated grid: dx=1.200 mm, dy=1.200 mm
Maximum value of SAR (interpolated) = 0.434 W/kg

Zoom Scan (7x7x7)/Cube 0: Measurement grid: dx=5mm, dy=5mm, dz=5mm
Reference Value = 0 V/m; Power Drift = -0.01 dB
Peak SAR (extrapolated) = 0.571 W/kg
SAR(1 g) = 0.158 W/kg; SAR(10 g) = 0.074 W/kg
Maximum value of SAR (measured) = 0.406 W/kg

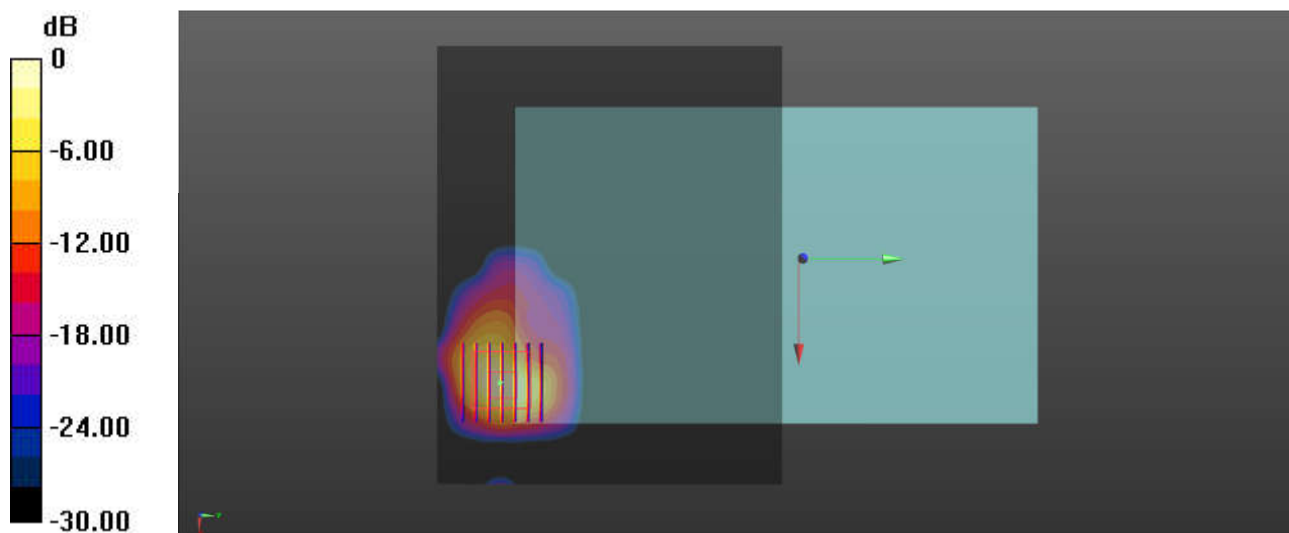

0 dB = 0.406 W/kg = -3.91 dBW/kg



Appendix C. DASYS Calibration Certificate

The DASYS calibration certificates are shown as follows.