

FCC SAR TEST REPORT

APPLICANT : Lenovo(Shanghai) Electronics
Technology Co., Ltd.

EQUIPMENT : Portable Tablet Computer

BRAND NAME : Lenovo

Model Name : Lenovo TB-8505FS

FCC ID : O57TB8505FS

STANDARD : FCC 47 CFR Part 2 (2.1093)
ANSI/IEEE C95.1-1992
IEEE 1528-2013

The product was received on Aug. 12, 2019 and testing was started from Aug. 29, 2019 and completed on Sep. 15, 2019. We, Sporton International (Kunshan) Inc., would like to declare that the tested sample has been evaluated in accordance with the test procedures and has been in compliance with the applicable technical standards.

The test results in this report apply exclusively to the tested model / sample. Without written approval of Sporton International (Kunshan) Inc., the test report shall not be reproduced except in full.

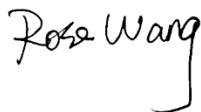

Reviewed by: Rose Wang / Supervisor



Approved by: Kat Yin / Manager



Sporton International (Kunshan) Inc.

No. 1098, Pengxi North Road, Kunshan Economic Development Zone Jiangsu Province 215300
People's Republic of China



Table of Contents

1. Statement of Compliance 4
2. Administration Data 5
3. Guidance Applied..... 5
4. Equipment Under Test (EUT) Information..... 6
4.1 General Information 6
5. Proximity Sensor Triggering Test..... 7
6. RF Exposure Limits.....13
6.1 Uncontrolled Environment.....13
6.2 Controlled Environment.....13
7. Specific Absorption Rate (SAR).....14
7.1 Introduction14
7.2 SAR Definition.....14
8. System Description and Setup15
8.1 E-Field Probe16
8.2 Data Acquisition Electronics (DAE)16
8.3 Phantom.....17
8.4 Device Holder.....18
9. Measurement Procedures19
9.1 Spatial Peak SAR Evaluation19
9.2 Power Reference Measurement.....20
9.3 Area Scan20
9.4 Zoom Scan.....21
9.5 Volume Scan Procedures.....21
9.6 Power Drift Monitoring.....21
10. Test Equipment List.....22
11. System Verification23
11.1 Tissue Simulating Liquids.....23
11.2 Tissue Verification24
11.3 System Performance Check Results25
12. RF Exposure Positions26
12.1 SAR Testing for Tablet.....26
13. Conducted RF Output Power (Unit: dBm).....27
14. Antenna Location39
15. SAR Test Results41
15.1 Body SAR42
15.2 Repeated SAR Measurement44
16. Simultaneous Transmission Analysis.....45
17. Uncertainty Assessment46
18. References.....47
Appendix A. Plots of System Performance Check
Appendix B. Plots of High SAR Measurement
Appendix C. DASy Calibration Certificate
Appendix D. Test Setup Photos



History of this test report

Report No.	Version	Description	Issued Date
FA981204-03	01	Initial issue of report	Sep. 16, 2019



1. Statement of Compliance

The maximum results of Specific Absorption Rate (SAR) found during testing for **Lenovo(Shanghai) Electronics Technology Co., Ltd., Portable Tablet Computer, Lenovo TB-8505FS**, are as follows.

Highest Standalone 1g SAR Summary			
Equipment Class	Frequency Band		Body
			1g SAR (W/kg)
DTS	WLAN	2.4GHz WLAN	1.15
NII		5GHz WLAN	1.00
DSS	Bluetooth	Bluetooth	<0.10
Date of Testing:		2019/8/29~2019/9/15	

Declaration of Conformity:
The test results with all measurement uncertainty excluded are presented in accordance with the regulation limits or requirements declared by manufacturers.
Comments and Explanations:
The declared of product specification for EUT presented in the report are provided by the manufacturer, and the manufacturer takes all the responsibilities for the accuracy of product specification.

This device is in compliance with Specific Absorption Rate (SAR) for general population/uncontrolled exposure limits (1.6 W/kg for Partial-Body 1g SAR) specified in FCC 47 CFR part 2 (2.1093) and ANSI/IEEE C95.1-1992, and had been tested in accordance with the measurement methods and procedures specified in IEEE 1528-2013 and FCC KDB publications



2. Administration Data

Sporton International (Kunshan) Inc. is accredited to ISO/IEC 17025:2017 by American Association for Laboratory Accreditation with Certificate Number 5145.02.

Testing Laboratory		
Test Firm	Sporton International (Kunshan) Inc.	
Test Site Location	No. 1098, Pengxi North Road, Kunshan Economic Development Zone Jiangsu Province 215300 People's Republic of China TEL : +86-512-57900158 FAX : +86-512-57900958	
Test Site No.	FCC Designation No.	FCC Test Firm Registration No.
	CN1257	314309

Applicant	
Company Name	Lenovo (Shanghai) Electronics Technology Co., Ltd.
Address	Section 304-305, Building No. 4, # 222, Meiyue Road, China (Shanghai) Pilot Free Trade Zone

Manufacturer	
Company Name	Lenovo PC HK Limited
Address	23/F, Lincoln House, Taikoo Place 979 King's Road, Quarry Bay, Hong Kong P.R.CHINA

3. Guidance Applied

The Specific Absorption Rate (SAR) testing specification, method, and procedure for this device is in accordance with the following standards:

- FCC 47 CFR Part 2 (2.1093)
- ANSI/IEEE C95.1-1992
- IEEE 1528-2013
- FCC KDB 865664 D01 SAR Measurement 100 MHz to 6 GHz v01r04
- FCC KDB 865664 D02 SAR Reporting v01r02
- FCC KDB 447498 D01 General RF Exposure Guidance v06
- FCC KDB 248227 D01 802.11 Wi-Fi SAR v02r02
- FCC KDB 616217 D04 SAR for laptop and tablets v01r02



4. Equipment Under Test (EUT) Information

4.1 General Information

Product Feature & Specification	
Equipment Name	Portable Tablet Computer
Brand Name	Lenovo
Model Name	Lenovo TB-8505FS
FCC ID	O57TB8505FS
Wireless Technology and Frequency Range	WLAN 2.4GHz Band: 2412 MHz ~ 2462 MHz WLAN 5.2GHz Band: 5180 MHz ~ 5240 MHz WLAN 5.3GHz Band: 5260 MHz ~ 5320 MHz WLAN 5.5GHz Band: 5500 MHz ~ 5700 MHz WLAN 5.8GHz Band: 5745 MHz ~ 5825 MHz Bluetooth: 2402 MHz ~ 2480 MHz
Mode	WLAN 2.4GHz 802.11b/g/n HT20/ HT40 WLAN 5GHz 802.11a/n HT20/HT40 WLAN 5GHz 802.11ac VHT20/VHT40/VHT80 Bluetooth BR/EDR/LE
HW Version	Lenovo TB-8505FS
SW Version	TB-8505FS_RF01_190817
EUT Stage	Identical Prototype
Remark:	
<ol style="list-style-type: none"> This device has no voice function. The device employs proximity sensors that detect the presence of the user's body also a finger or hand near the bottom face, edge 2 or edge 1 of the device, reduced power will be active for all WLAN5GHz bands. (P-sensor can't work at detecting presence of the user's body at other edges of the device.) There are two types of EUT, the differences between two samples is different suppliers for memory. The sample 1 is 3+32GB capacity and sample 2 is 2+16GB capacity. According to the difference, we only evaluate the sample 1 to full test. 	

5. Proximity Sensor Triggering Test

<Proximity Sensor Triggering Distance (KDB 616217 D04 section 6.2)>:

1. Proximity sensor triggering distance testing was performed according to the procedures outlined in KDB 616217 D04 section 6.2, and EUT moving further away from the flat phantom and EUT moving toward the flat phantom were both assessed and the tissue-equivalent medium for highest frequency 5850MHz and lowest 5180MHz frequency was used for proximity sensor triggering testing.
2. Capacitive proximity sensor placed coincident with antenna elements at the Bottom Face, Edge 2 and Edge 1 of the device are utilized to determine when the device comes in proximity of the user's body at the Bottom Face Edge 2 or Edge 1 side of the device. There is no need to do sensor coverage testing for the proximity sensor is designed to support sufficient detection range and sensitivity to cover regions of the sensors in all applicable directions since the proximity sensor entirely covers the antenna.
3. When the sensor is active, WLAN 5.2GHz / WLAN 5.3GHz / WLAN 5.5GHz / WLAN 5.8GHz reduced power will be active.
4. The sensors used to detect the proximity of the user's body at the Bottom Face, Edge 2 or Edge 1 side of the device use a detection threshold distance. The data shown in the sections below shows the distance(s).

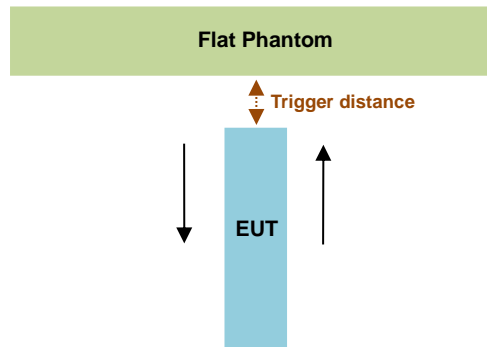

Proximity Sensor Triggering Distance (mm)						
Position	Bottom Face		Edge 1		Edge 2	
	Moving towards	Moving away	Moving towards	Moving away	Moving towards	Moving away
Minimum	12	16	19	20	6	6

<Proximity Sensor Triggering Coverage (KDB 616217 D04 section 6.3)>:

If a sensor is spatially offset from the antenna(s), it is necessary to verify sensor triggering for conditions where the antenna is next to the user but the sensor is laterally further away to ensure sensor coverage is sufficient for reducing the power to maintain compliance. For p-sensor coverage testing, the device is moved and "along the direction of maximum antenna and sensor offset".

Illustrated in the internal photo exhibit, although the sensor is spatially offset, there is no trigger condition where the antenna is next to the user but the sensor is laterally further away, therefore proximity sensor coverage testing is not required.

This procedure is not required because antenna and sensor are collocated and the peak SAR location is overlapping with the sensor.

<Tablet Tilt angle influences to proximity sensor triggering (KDB 616217 D04 section 6.4)>:

The influence of table tilt angles to proximity sensor triggering was determined by positioning each tablet edge that contains a transmitting antenna, perpendicular to the flat phantom, at 19mm for Edge 1 and 6 mm for Edge 2 separation for WLAN bands.

Rotating the tablet around the edge next to the phantom in $\leq 10^\circ$ increments until the tablet is $\pm 45^\circ$ from the vertical position at 0° , and the maximum output power remains in the reduced mode.

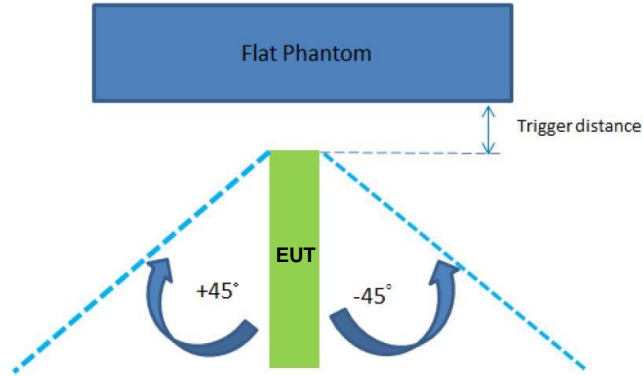

The Sensor Trigger Distance (mm)		
Position	Edge 1	Edge 2
Minimum	19	6

Proximity sensor power reduction

Exposure Position / wireless mode	Bottom Face ⁽¹⁾	Edge 1 ⁽¹⁾	Edge 2 ⁽¹⁾	Edge 3	Edge 4
WLAN 5.2GHz	4.0 dB	4.0 dB	4.0 dB	0 dB	0 dB
WLAN 5.3GHz	4.0 dB	4.0 dB	4.0 dB	0 dB	0 dB
WLAN 5.5GHz	4.0 dB	4.0 dB	4.0 dB	0 dB	0 dB
WLAN 5.8GHz	4.0 dB	4.0 dB	4.0 dB	0 dB	0 dB

Remark:

1. ⁽¹⁾: Reduced maximum limit applied by activation of proximity sensor.
2. Tests were performed in accordance with KDB 616217 D04 section 6.1, 6.2, 6.3, 6.4 and 6.5 and compliant results are shown and described in exhibit "P-Sensor operational description"
3. For verification of compliance of power reduction scheme, additional SAR testing with EUT transmitting at full RF power at a conservative trigger distance was performed:
 - Bottom Face: 5 mm(manufacturer declared)
 - Edge 2: 5 mm
 - Edge 1: 8 mm(manufacturer declared)
 -

Power Measurement during Sensor Trigger distance testing

Band/Mode	Ch #	Measured power reduction (dBm)		Reduction Levels (dB)
		w/o power back-off	w/ power back-off	
WLAN 5.2GHz	48	17.28	12.89	4.39
WLAN 5.3GHz	60	17.24	12.79	4.45
WLAN 5.5GHz	140	17.07	13.09	3.98
WLAN 5.8GHz	157	17.18	13.02	4.16

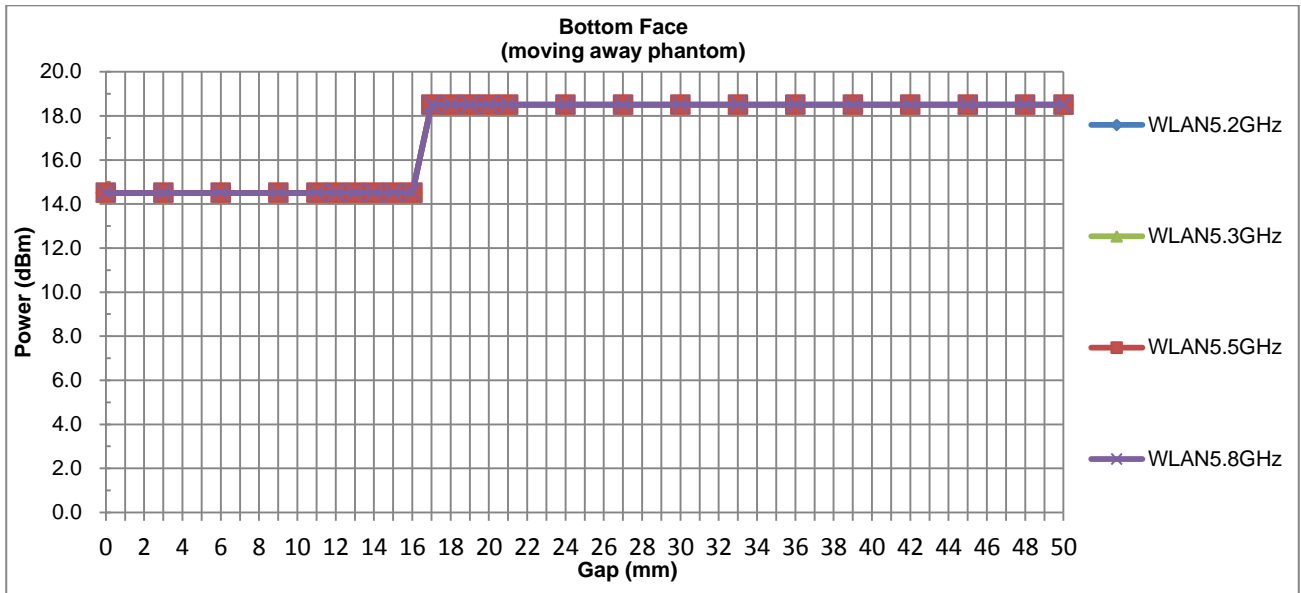
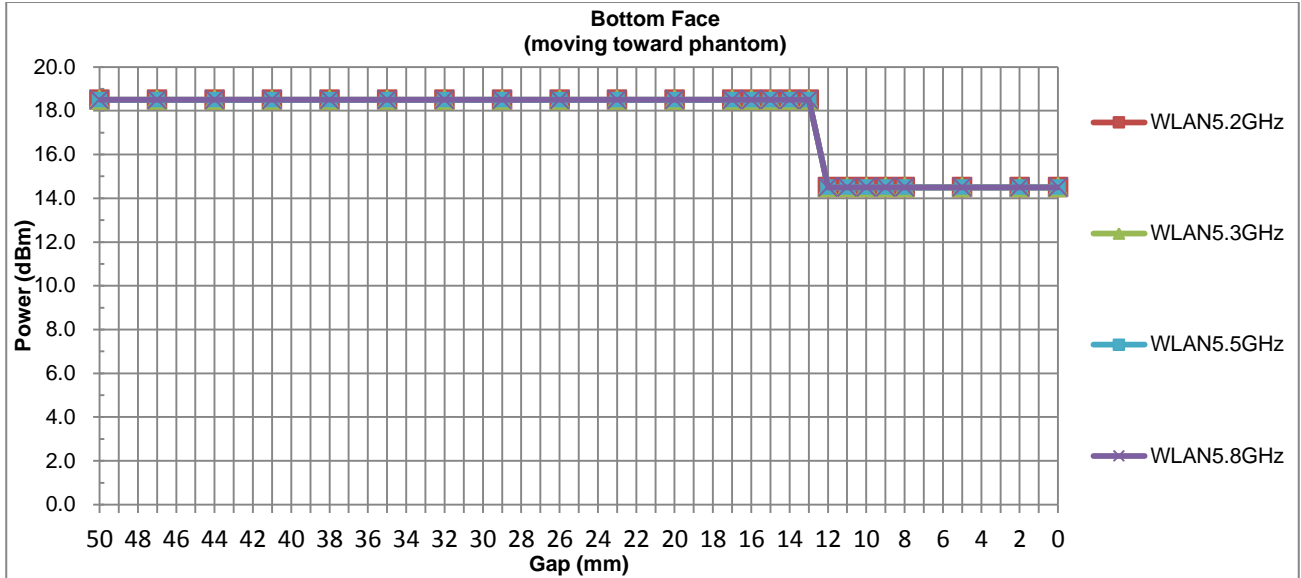

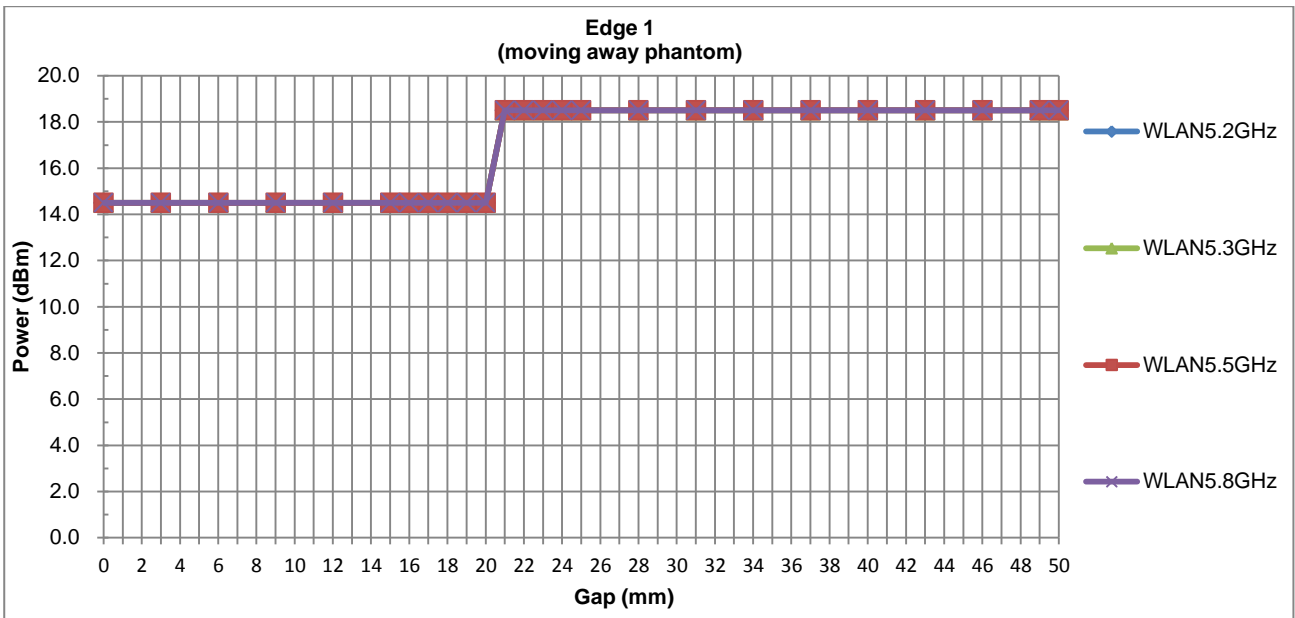
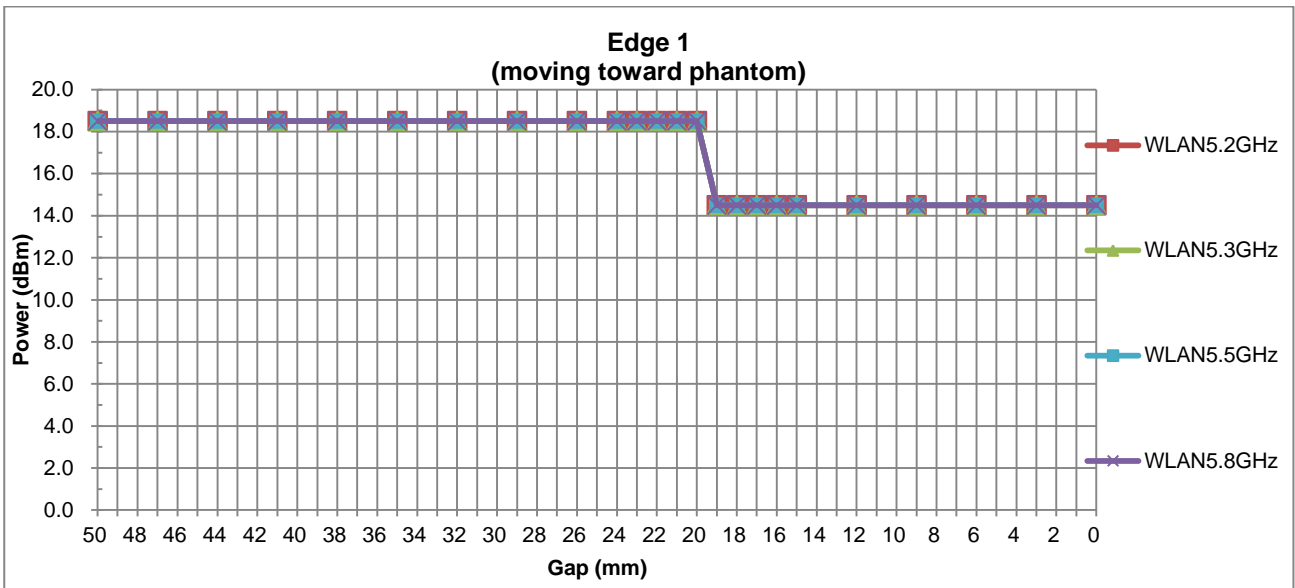

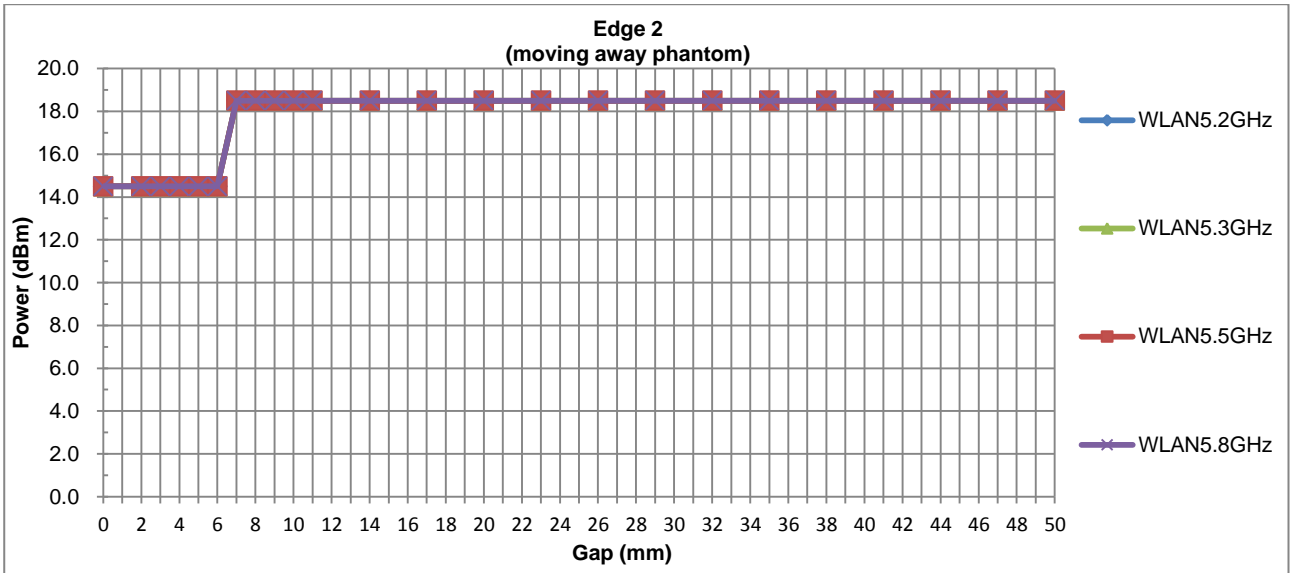
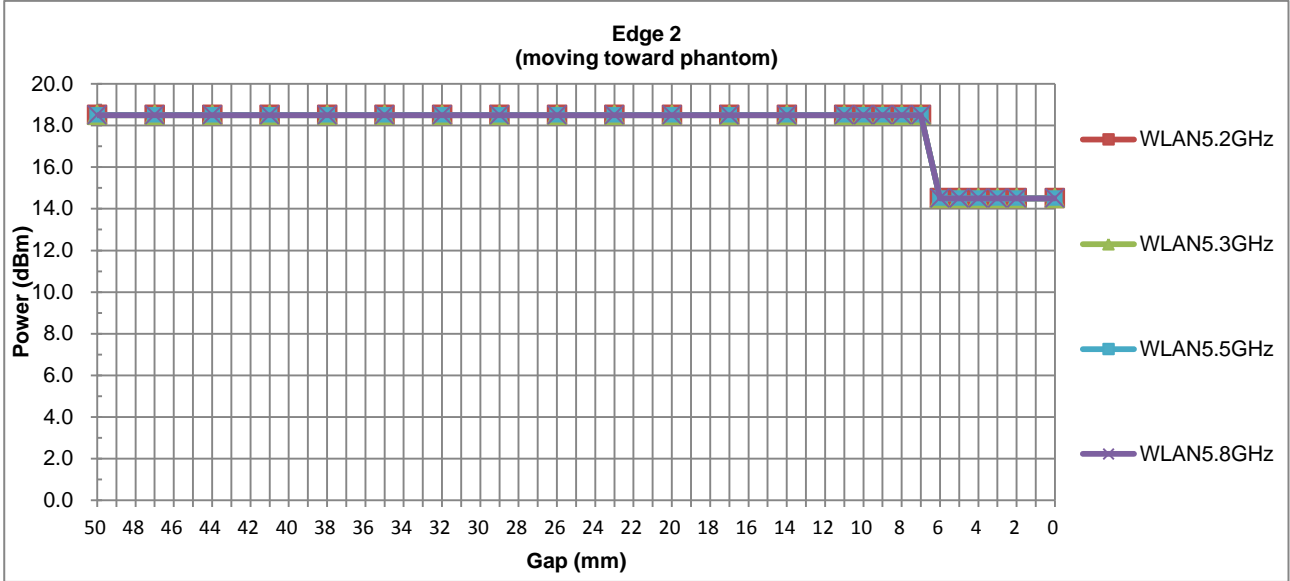

6. RF Exposure Limits

6.1 Uncontrolled Environment

Uncontrolled Environments are defined as locations where there is the exposure of individuals who have no knowledge or control of their exposure. The general population/uncontrolled exposure limits are applicable to situations in which the general public may be exposed or in which persons who are exposed as a consequence of their employment may not be made fully aware of the potential for exposure or cannot exercise control over their exposure. Members of the general public would come under this category when exposure is not employment-related; for example, in the case of a wireless transmitter that exposes persons in its vicinity.

6.2 Controlled Environment

Controlled Environments are defined as locations where there is exposure that may be incurred by persons who are aware of the potential for exposure, (i.e. as a result of employment or occupation). In general, occupational/controlled exposure limits are applicable to situations in which persons are exposed as a consequence of their employment, who have been made fully aware of the potential for exposure and can exercise control over their exposure. The exposure category is also applicable when the exposure is of a transient nature due to incidental passage through a location where the exposure levels may be higher than the general population/uncontrolled limits, but the exposed person is fully aware of the potential for exposure and can exercise control over his or her exposure by leaving the area or by some other appropriate means.

Limits for Occupational/Controlled Exposure (W/kg)

Whole-Body	Partial-Body	Hands, Wrists, Feet and Ankles
0.4	8.0	20.0

Limits for General Population/Uncontrolled Exposure (W/kg)

Whole-Body	Partial-Body	Hands, Wrists, Feet and Ankles
0.08	1.6	4.0

Whole-Body SAR is averaged over the entire body, partial-body SAR is averaged over any 1gram of tissue defined as a tissue volume in the shape of a cube. SAR for hands, wrists, feet and ankles is averaged over any 10 grams of tissue defined as a tissue volume in the shape of a cube.

7. Specific Absorption Rate (SAR)

7.1 Introduction

SAR is related to the rate at which energy is absorbed per unit mass in an object exposed to a radio field. The SAR distribution in a biological body is complicated and is usually carried out by experimental techniques or numerical modeling. The standard recommends limits for two tiers of groups, occupational/controlled and general population/uncontrolled, based on a person's awareness and ability to exercise control over his or her exposure. In general, occupational/controlled exposure limits are higher than the limits for general population/uncontrolled.

7.2 SAR Definition

The SAR definition is the time derivative (rate) of the incremental energy (dW) absorbed by (dissipated in) an incremental mass (dm) contained in a volume element (dv) of a given density (ρ). The equation description is as below:

$$\text{SAR} = \frac{d}{dt} \left(\frac{dW}{dm} \right) = \frac{d}{dt} \left(\frac{dW}{\rho dv} \right)$$

SAR is expressed in units of Watts per kilogram (W/kg)

$$\text{SAR} = \frac{\sigma |E|^2}{\rho}$$

Where: σ is the conductivity of the tissue, ρ is the mass density of the tissue and E is the RMS electrical field strength.

8. System Description and Setup

The DASY system used for performing compliance tests consists of the following items:

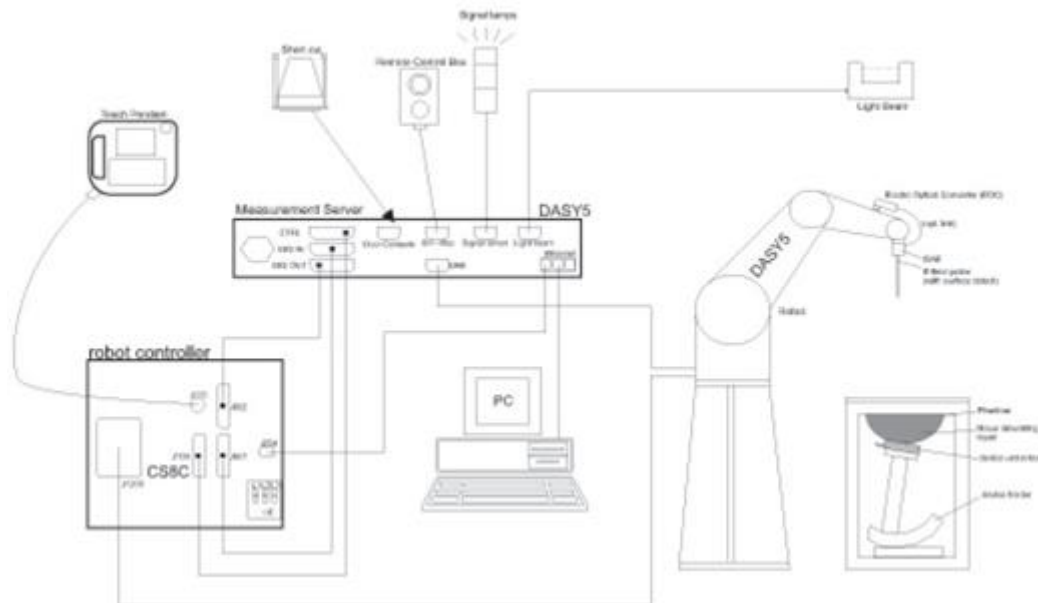

- A standard high precision 6-axis robot with controller, teach pendant and software. An arm extension for accommodating the data acquisition electronics (DAE).
- An isotropic Field probe optimized and calibrated for the targeted measurement.
- A data acquisition electronics (DAE) which performs the signal amplification, signal multiplexing, AD-conversion, offset measurements, mechanical surface detection, collision detection, etc. The unit is battery powered with standard or rechargeable batteries. The signal is optically transmitted to the EOC.
- The Electro-optical converter (EOC) performs the conversion from optical to electrical signals for the digital communication to the DAE. To use optical surface detection, a special version of the EOC is required. The EOC signal is transmitted to the measurement server.
- The function of the measurement server is to perform the time critical tasks such as signal filtering, control of the robot operation and fast movement interrupts.
- The Light Beam used is for probe alignment. This improves the (absolute) accuracy of the probe positioning.
- A computer running WinXP or Win7 and the DASY5 software.
- Remote control and teach pendant as well as additional circuitry for robot safety such as warning lamps, etc.
- The phantom, the device holder and other accessories according to the targeted measurement.

8.1 E-Field Probe

The SAR measurement is conducted with the dosimetric probe (manufactured by SPEAG).The probe is specially designed and calibrated for use in liquid with high permittivity. The dosimetric probe has special calibration in liquid at different frequency. This probe has a built in optical surface detection system to prevent from collision with phantom.

<EX3DV4 Probe>

Construction	Symmetric design with triangular core Built-in shielding against static charges PEEK enclosure material (resistant to organic solvents, e.g., DGBE)	
Frequency	10 MHz – >6 GHz Linearity: ±0.2 dB (30 MHz – 6 GHz)	
Directivity	±0.3 dB in TSL (rotation around probe axis) ±0.5 dB in TSL (rotation normal to probe axis)	
Dynamic Range	10 µW/g – >100 mW/g Linearity: ±0.2 dB (noise: typically <1 µW/g)	
Dimensions	Overall length: 337 mm (tip: 20 mm) Tip diameter: 2.5 mm (body: 12 mm) Typical distance from probe tip to dipole centers: 1 mm	

8.2 Data Acquisition Electronics (DAE)

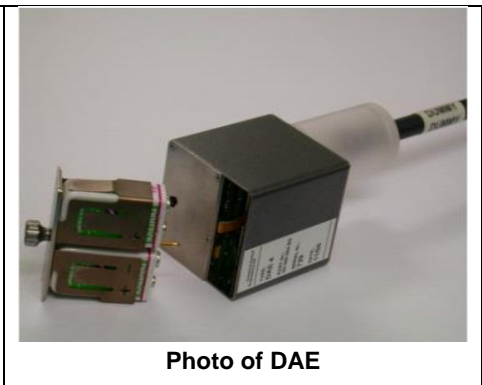
<p>The data acquisition electronics (DAE) consists of a highly sensitive electrometer-grade preamplifier with auto-zeroing, a channel and gain-switching multiplexer, a fast 16 bit AD-converter and a command decoder and control logic unit. Transmission to the measurement server is accomplished through an optical downlink for data and status information as well as an optical uplink for commands and the clock.</p> <p>The input impedance of the DAE is 200 MOhm; the inputs are symmetrical and floating. Common mode rejection is above 80 dB.</p>	 <p style="text-align: center;">Photo of DAE</p>
--	--

8.3 Phantom

<SAM Twin Phantom>

Shell Thickness	2 ± 0.2 mm; Center ear point: 6 ± 0.2 mm	
Filling Volume	Approx. 25 liters	
Dimensions	Length: 1000 mm; Width: 500 mm; Height: adjustable feet	
Measurement Areas	Left Hand, Right Hand, Flat Phantom	

The bottom plate contains three pair of bolts for locking the device holder. The device holder positions are adjusted to the standard measurement positions in the three sections. A white cover is provided to tap the phantom during off-periods to prevent water evaporation and changes in the liquid parameters. On the phantom top, three reference markers are provided to identify the phantom position with respect to the robot.

<ELI Phantom>

Shell Thickness	2 ± 0.2 mm (sagging: <1%)	
Filling Volume	Approx. 30 liters	
Dimensions	Major ellipse axis: 600 mm Minor axis: 400 mm	

The ELI phantom is intended for compliance testing of handheld and body-mounted wireless devices in the frequency range of 30 MHz to 6 GHz. ELI4 is fully compatible with standard and all known tissue simulating liquids.

8.4 Device Holder

<Mounting Device for Hand-Held Transmitter>

In combination with the Twin SAM V5.0/V5.0c or ELI phantoms, the Mounting Device for Hand-Held Transmitters enables rotation of the mounted transmitter device to specified spherical coordinates. At the heads, the rotation axis is at the ear opening. Transmitter devices can be easily and accurately positioned according to IEC 62209-1, IEEE 1528, FCC, or other specifications. The device holder can be locked for positioning at different phantom sections (left head, right head, flat). And upgrade kit to Mounting Device to enable easy mounting of wider devices like big smart-phones, e-books, small tablets, etc. It holds devices with width up to 140 mm.



Mounting Device for Hand-Held Transmitters



Mounting Device Adaptor for Wide-Phones

<Mounting Device for Laptops and other Body-Worn Transmitters>

The extension is lightweight and made of POM, acrylic glass and foam. It fits easily on the upper part of the mounting device in place of the phone positioned. The extension is fully compatible with the SAM Twin and ELI phantoms.



Mounting Device for Laptops

9. Measurement Procedures

The measurement procedures are as follows:

<Conducted power measurement>

- (a) For WWAN power measurement, use base station simulator to configure EUT WWAN transmission in conducted connection with RF cable, at maximum power in each supported wireless interface and frequency band.
- (b) Read the WWAN RF power level from the base station simulator.
- (c) For WLAN/BT power measurement, use engineering software to configure EUT WLAN/BT continuously transmission, at maximum RF power in each supported wireless interface and frequency band
- (d) Connect EUT RF port through RF cable to the power meter, and measure WLAN/BT output power

<SAR measurement>

- (a) Use base station simulator to configure EUT WWAN transmission in radiated connection, and engineering software to configure EUT WLAN/BT continuously transmission, at maximum RF power, in the highest power channel.
- (b) Place the EUT in the positions as Appendix D demonstrates.
- (c) Set scan area, grid size and other setting on the DASY software.
- (d) Measure SAR results for the highest power channel on each testing position.
- (e) Find out the largest SAR result on these testing positions of each band
- (f) Measure SAR results for other channels in worst SAR testing position if the reported SAR of highest power channel is larger than 0.8 W/kg

According to the test standard, the recommended procedure for assessing the peak spatial-average SAR value consists of the following steps:

- (a) Power reference measurement
- (b) Area scan
- (c) Zoom scan
- (d) Power drift measurement

9.1 Spatial Peak SAR Evaluation

The procedure for spatial peak SAR evaluation has been implemented according to the test standard. It can be conducted for 1g and 10g, as well as for user-specific masses. The DASY software includes all numerical procedures necessary to evaluate the spatial peak SAR value.

The base for the evaluation is a "cube" measurement. The measured volume must include the 1g and 10g cubes with the highest averaged SAR values. For that purpose, the center of the measured volume is aligned to the interpolated peak SAR value of a previously performed area scan.

The entire evaluation of the spatial peak values is performed within the post-processing engine (SEMCAD). The system always gives the maximum values for the 1g and 10g cubes. The algorithm to find the cube with highest averaged SAR is divided into the following stages:

- (a) Extraction of the measured data (grid and values) from the Zoom Scan
- (b) Calculation of the SAR value at every measurement point based on all stored data (A/D values and measurement parameters)
- (c) Generation of a high-resolution mesh within the measured volume
- (d) Interpolation of all measured values from the measurement grid to the high-resolution grid
- (e) Extrapolation of the entire 3-D field distribution to the phantom surface over the distance from sensor to surface
- (f) Calculation of the averaged SAR within masses of 1g and 10g

9.2 Power Reference Measurement

The Power Reference Measurement and Power Drift Measurements are for monitoring the power drift of the device under test in the batch process. The minimum distance of probe sensors to surface determines the closest measurement point to phantom surface. This distance cannot be smaller than the distance of sensor calibration points to probe tip as defined in the probe properties.

9.3 Area Scan

The area scan is used as a fast scan in two dimensions to find the area of high field values, before doing a fine measurement around the hot spot. The sophisticated interpolation routines implemented in DASY software can find the maximum found in the scanned area, within a range of the global maximum. The range (in dB0) is specified in the standards for compliance testing. For example, a 2 dB range is required in IEEE standard 1528 and IEC 62209 standards, whereby 3 dB is a requirement when compliance is assessed in accordance with the ARIB standard (Japan), if only one zoom scan follows the area scan, then only the absolute maximum will be taken as reference. For cases where multiple maximums are detected, the number of zoom scans has to be increased accordingly.

Area scan parameters extracted from FCC KDB 865664 D01v01r04 SAR measurement 100 MHz to 6 GHz.

	≤ 3 GHz	> 3 GHz
Maximum distance from closest measurement point (geometric center of probe sensors) to phantom surface	5 ± 1 mm	$\frac{1}{2} \cdot \delta \cdot \ln(2) \pm 0.5$ mm
Maximum probe angle from probe axis to phantom surface normal at the measurement location	30° ± 1°	20° ± 1°
Maximum area scan spatial resolution: Δx_{Area} , Δy_{Area}	≤ 2 GHz: ≤ 15 mm 2 – 3 GHz: ≤ 12 mm	3 – 4 GHz: ≤ 12 mm 4 – 6 GHz: ≤ 10 mm
	When the x or y dimension of the test device, in the measurement plane orientation, is smaller than the above, the measurement resolution must be ≤ the corresponding x or y dimension of the test device with at least one measurement point on the test device.	

9.4 Zoom Scan

Zoom scans are used assess the peak spatial SAR values within a cubic averaging volume containing 1 gram and 10 gram of simulated tissue. The zoom scan measures points (refer to table below) within a cube shoes base faces are centered on the maxima found in a preceding area scan job within the same procedure. When the measurement is done, the zoom scan evaluates the averaged SAR for 1 gram and 10 gram and displays these values next to the job's label.

Zoom scan parameters extracted from FCC KDB 865664 D01v01r04 SAR measurement 100 MHz to 6 GHz.

		≤ 3 GHz	> 3 GHz	
Maximum zoom scan spatial resolution: $\Delta x_{Zoom}, \Delta y_{Zoom}$		≤ 2 GHz: ≤ 8 mm 2 – 3 GHz: ≤ 5 mm*	3 – 4 GHz: ≤ 5 mm* 4 – 6 GHz: ≤ 4 mm*	
Maximum zoom scan spatial resolution, normal to phantom surface	uniform grid: $\Delta z_{Zoom}(n)$	≤ 5 mm	3 – 4 GHz: ≤ 4 mm 4 – 5 GHz: ≤ 3 mm 5 – 6 GHz: ≤ 2 mm	
	graded grid	$\Delta z_{Zoom}(1)$: between 1 st two points closest to phantom surface	≤ 4 mm	3 – 4 GHz: ≤ 3 mm 4 – 5 GHz: ≤ 2.5 mm 5 – 6 GHz: ≤ 2 mm
		$\Delta z_{Zoom}(n>1)$: between subsequent points	$\leq 1.5 \cdot \Delta z_{Zoom}(n-1)$	
Minimum zoom scan volume	x, y, z	≥ 30 mm	3 – 4 GHz: ≥ 28 mm 4 – 5 GHz: ≥ 25 mm 5 – 6 GHz: ≥ 22 mm	
Note: δ is the penetration depth of a plane-wave at normal incidence to the tissue medium; see draft standard IEEE P1528-2011 for details. * When zoom scan is required and the <i>reported</i> SAR from the <i>area scan based 1-g SAR estimation</i> procedures of KDB 447498 is ≤ 1.4 W/kg, ≤ 8 mm, ≤ 7 mm and ≤ 5 mm zoom scan resolution may be applied, respectively, for 2 GHz to 3 GHz, 3 GHz to 4 GHz and 4 GHz to 6 GHz.				

9.5 Volume Scan Procedures

The volume scan is used for assess overlapping SAR distributions for antennas transmitting in different frequency bands. It is equivalent to an oversized zoom scan used in standalone measurements. The measurement volume will be used to enclose all the simultaneous transmitting antennas. For antennas transmitting simultaneously in different frequency bands, the volume scan is measured separately in each frequency band. In order to sum correctly to compute the 1g aggregate SAR, the EUT remain in the same test position for all measurements and all volume scan use the same spatial resolution and grid spacing. When all volume scan were completed, the software, SEMCAD postprocessor can combine and subsequently superpose these measurement data to calculating the multiband SAR.

9.6 Power Drift Monitoring

All SAR testing is under the EUT install full charged battery and transmit maximum output power. In DASy measurement software, the power reference measurement and power drift measurement procedures are used for monitoring the power drift of EUT during SAR test. Both these procedures measure the field at a specified reference position before and after the SAR testing. The software will calculate the field difference in dB. If the power drifts more than 5%, the SAR will be retested.



10. Test Equipment List

Manufacturer	Name of Equipment	Type/Model	Serial Number	Calibration	
				Last Cal.	Due Date
SPEAG	2450MHz System Validation Kit	D2450V2	908	2019/3/25	2020/3/24
SPEAG	5000MHz System Validation Kit	D5GHzV2	1006	2018/9/27	2019/9/26
SPEAG	Data Acquisition Electronics	DAE4	1338	2018/12/3	2019/12/2
SPEAG	Dosimetric E-Field Probe	EX3DV4	3857	2019/5/27	2020/5/26
SPEAG	ELI4 Phantom	QD 0VA 001 BB	TP-1201	NCR	NCR
SPEAG	Phone Positioner	N/A	N/A	NCR	NCR
Agilent	ENA Series Network Analyzer	E5071C	MY46111157	2019/4/17	2020/4/16
SPEAG	Dielectric Probe Kit	DAK-3.5	1138	2018/11/20	2019/11/19
Anritsu	Vector Signal Generator	MG3710A	6201682672	2019/1/14	2020/1/13
Rohde & Schwarz	Power Meter	NRVD	102081	2019/8/19	2020/8/18
Rohde & Schwarz	Power Sensor	NRV-Z5	100538	2019/8/19	2020/8/18
Rohde & Schwarz	Power Sensor	NRV-Z5	100539	2019/8/19	2020/8/18
R&S	CBT BLUETOOTH TESTER	CBT	101641	2019/1/14	2020/1/13
EXA	Spectrum Analyzer	FSV7	101631	2019/1/14	2020/1/13
Testo	Hygrometer	608-H1	1241332126	2019/8/20	2020/8/19
FLUKE	DIGITAC THERMOMETER	51II	97240029	2019/8/7	2020/8/6
ARRA	Power Divider	A3200-2	N/A	Note	
MCL	Attenuation1	BW-S10W5+	N/A	Note	
MCL	Attenuation2	BW-S10W5+	N/A	Note	
MCL	Attenuation3	BW-S10W5+	N/A	Note	
Agilent	Dual Directional Coupler	778D	20500	Note	
Agilent	Dual Directional Coupler	11691D	MY48151020	Note	
BONN	POWER AMPLIFIER	BLMA 0830-3	087193A	Note	
BONN	POWER AMPLIFIER	BLMA 2060-2	087193B	Note	

Note: Prior to system verification and validation, the path loss from the signal generator to the system check source and the power meter, which includes the amplifier, cable, attenuator and directional coupler, was measured by the network analyzer. The reading of the power meter was offset by the path loss difference between the path to the power meter and the path to the system check source to monitor the actual power level fed to the system check source.

11. System Verification

11.1 Tissue Simulating Liquids

For the measurement of the field distribution inside the SAM phantom with DASY, the phantom must be filled with around 25 liters of homogeneous body tissue simulating liquid. For body SAR testing, the liquid height from the center of the flat phantom to the liquid top surface is larger than 15 cm, which is shown in Fig. 11.1.

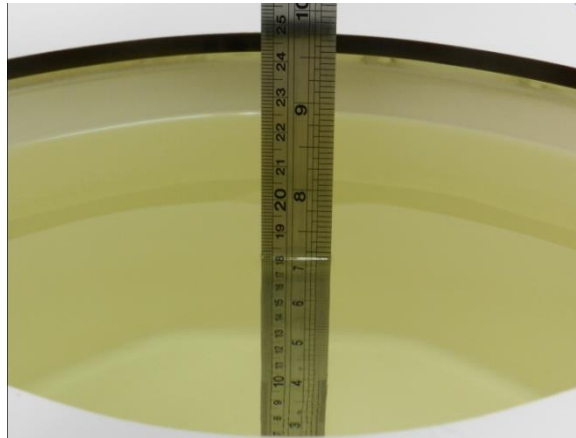

Fig 11.1 Photo of Liquid Height for Body SAR

11.2 Tissue Verification

The following tissue formulations are provided for reference only as some of the parameters have not been thoroughly verified. The composition of ingredients may be modified accordingly to achieve the desired target tissue parameters required for routine SAR evaluation.

Frequency (MHz)	Water (%)	Sugar (%)	Cellulose (%)	Salt (%)	Preventol (%)	DGBE (%)	Conductivity (σ)	Permittivity (ϵ_r)
For Head								
2450	55.0	0	0	0	0	45.0	1.80	39.2

Simulating Liquid for 5GHz, Manufactured by SPEAG

Ingredients	(% by weight)
Water	64~78%
Mineral oil	11~18%
Emulsifiers	9~15%
Additives and Salt	2~3%

<Tissue Dielectric Parameter Check Results>

Frequency (MHz)	Tissue Type	Liquid Temp. (°C)	Conductivity (σ)	Permittivity (ϵ_r)	Conductivity Target (σ)	Permittivity Target (ϵ_r)	Delta (σ) (%)	Delta (ϵ_r) (%)	Limit (%)	Date
2450	Head	22.6	1.779	40.667	1.80	39.20	-1.17	3.74	±5	2019/9/15
5250	Head	22.8	4.555	34.768	4.71	35.90	-3.29	-3.15	±5	2019/8/31
5600	Head	22.9	4.897	34.294	5.07	35.50	-3.41	-3.40	±5	2019/8/30
5750	Head	22.7	5.048	34.066	5.22	35.40	-3.30	-3.77	±5	2019/8/29

11.3 System Performance Check Results

Comparing to the original SAR value provided by SPEAG, the verification data should be within its specification of 10 %. Below table shows the target SAR and measured SAR after normalized to 1W input power. The table below indicates the system performance check can meet the variation criterion and the plots can be referred to Appendix A of this report.

Date	Frequency (MHz)	Tissue Type	Input Power (mW)	Dipole S/N	Probe S/N	DAE S/N	Measured 1g SAR (W/kg)	Targeted 1g SAR (W/kg)	Normalized 1g SAR (W/kg)	Deviation (%)
2019/9/15	2450	Head	250	908	3857	1338	13.40	52.80	53.6	1.52
2019/8/31	5250	Head	100	1006	3857	1338	7.91	80.70	79.1	-1.98
2019/8/30	5600	Head	100	1006	3857	1338	8.50	83.30	85	2.04
2019/8/29	5750	Head	100	1006	3857	1338	7.86	80.40	78.6	-2.24

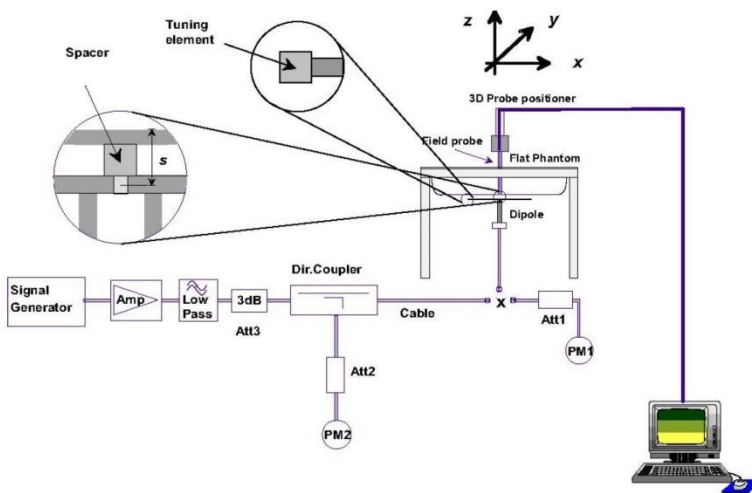

Fig 8.3.1 System Performance Check Setup



Fig 8.3.2 Setup Photo



12. RF Exposure Positions

12.1 SAR Testing for Tablet

This device can be used also in full sized tablet exposure conditions, due to its size. Per FCC KDB 616217, the back surface and edges of the tablet should be tested for SAR compliance with the tablet touching the phantom. The SAR exclusion threshold in KDB 447498 D01v06 can be applied to determine SAR test exclusion for adjacent edge configurations. The closest distance from the antenna to an adjacent tablet edge is used to determine if SAR testing is required for the adjacent edges, with the adjacent edge positioned against the phantom and the edge containing the antenna positioned perpendicular to the phantom.

<EUT Setup Photos>

Please refer to Appendix D for the test setup photos.



13. Conducted RF Output Power (Unit: dBm)

<WLAN Conducted Power>

General Note:

1. Per KDB 248227 D01v02r02, SAR test reduction is determined according to 802.11 transmission mode configurations and certain exposure conditions with multiple test positions. In the 2.4 GHz band, separate SAR procedures are applied to DSSS and OFDM configurations to simplify DSSS test requirements. For OFDM, in both 2.4 and 5 GHz bands, an initial test configuration must be determined for each standalone and aggregated frequency band, according to the transmission mode configuration with the highest maximum output power specified for production units to perform SAR measurements. If the same highest maximum output power applies to different combinations of channel bandwidths, modulations and data rates, additional procedures are applied to determine which test configurations require SAR measurement. When applicable, an initial test position may be applied to reduce the number of SAR measurements required for next to the ear, UMPC mini-tablet or hotspot mode configurations with multiple test positions.
2. For 2.4 GHz 802.11b DSSS, either the initial test position procedure for multiple exposure test positions or the DSSS procedure for fixed exposure position is applied; these are mutually exclusive. For 2.4 GHz and 5 GHz OFDM configurations, the initial test configuration is applied to measure SAR using either the initial test position procedure for multiple exposure test position configurations or the initial test configuration procedures for fixed exposure test conditions. Based on the reported SAR of the measured configurations and maximum output power of the transmission mode configurations that are not included in the initial test configuration, the subsequent test configuration and initial test position procedures are applied to determine if SAR measurements are required for the remaining OFDM transmission configurations. In general, the number of test channels that require SAR measurement is minimized based on maximum output power measured for the test sample(s).
3. For OFDM transmission configurations in the 2.4 GHz and 5 GHz bands, When the same maximum power is specified for multiple transmission modes in a frequency band, the largest channel bandwidth, lowest order modulation, lowest data rate and lowest order 802.11a/g/n/ac mode is used for SAR measurement, on the highest measured output power channel for each frequency band.
4. DSSS and OFDM configurations are considered separately according to the required SAR procedures. SAR is measured in the initial test position using the 802.11 transmission mode configuration required by the DSSS procedure or initial test configuration and subsequent test configuration(s) according to the OFDM procedures.¹⁸ The initial test position procedure is described in the following:
 - a. When the reported SAR of the initial test position is ≤ 0.4 W/kg, further SAR measurement is not required for the other test positions in that exposure configuration and 802.11 transmission mode combinations within the frequency band or aggregated band.
 - b. When the reported SAR of the test position is > 0.4 W/kg, SAR is repeated for the 802.11 transmission mode configuration tested in the initial test position to measure the subsequent next closet/smallest test separation distance and maximum coupling test position on the highest maximum output power channel, until the report SAR is ≤ 0.8 W/kg or all required test position are tested.
 - c. For all positions/configurations, when the reported SAR is > 0.8 W/kg, SAR is measured for these test positions/configurations on the subsequent next highest measured output power channel(s) until the reported SAR is ≤ 1.2 W/kg or all required channels are tested.

<Full Power Mode>

<2.4GHz WLAN>

	Mode	Channel	Frequency (MHz)	Average power (dBm)	Tune-Up Limit	Duty Cycle %
2.4GHz WLAN	802.11b 1Mbps	1	2412	12.43	14.00	100.00
		6	2437	16.59	18.00	
		11	2462	13.24	14.00	
	802.11g 6Mbps	1	2412	14.96	15.50	96.97
		6	2437	17.75	18.00	
		11	2462	15.33	15.50	
	802.11n-HT20 MCS0	1	2412	13.28	14.00	96.77
		6	2437	16.17	17.00	
		11	2462	12.74	14.00	
	802.11n-HT40 MCS0	3	2422	14.29	15.00	93.73
		6	2437	14.42	15.00	
		9	2452	14.15	15.00	



<5GHz WLAN>

	Mode	Channel	Frequency (MHz)	Average power (dBm)	Tune-Up Limit	Duty Cycle %
5.2GHz WLAN	802.11a 6Mbps	36	5180	17.00	18.50	96.97
		40	5200	17.04	18.50	
		44	5220	17.18	18.50	
		48	5240	17.28	18.50	
	802.11n-HT20 MCS0	36	5180	15.83	17.00	96.77
		40	5200	16.91	18.50	
		44	5220	17.30	18.50	
		48	5240	17.04	18.50	
	802.11n-HT40 MCS0	38	5190	14.24	15.50	93.75
		46	5230	15.37	16.50	
	802.11ac-VHT20 MCS0	36	5180	15.31	16.50	96.81
		40	5200	15.29	16.50	
		44	5220	15.96	16.50	
		48	5240	15.64	16.50	
	802.11ac-VHT40 MCS0	38	5190	14.16	15.00	93.75
		46	5230	15.09	16.50	
802.11ac-VHT80 MCS0	42	5210	12.52	13.50	88.19	



	Mode	Channel	Frequency (MHz)	Average power (dBm)	Tune-Up Limit	Duty Cycle %
5.3GHz WLAN	802.11a 6Mbps	52	5260	16.89	18.50	96.97
		56	5280	16.79	18.50	
		60	5300	17.24	18.50	
		64	5320	17.02	18.50	
	802.11n-HT20 MCS0	52	5260	17.06	18.00	96.77
		56	5280	17.08	18.50	
		60	5300	17.35	18.50	
		64	5320	17.11	18.50	
	802.11n-HT40 MCS0	54	5270	15.27	15.50	93.75
		62	5310	14.30	15.50	
	802.11ac-VHT20 MCS0	52	5260	15.17	16.50	96.81
		56	5280	15.48	16.50	
		60	5300	15.67	16.50	
		64	5320	15.61	16.50	
	802.11ac-VHT40 MCS0	54	5270	15.10	16.00	93.75
		62	5310	14.20	15.50	
802.11ac-VHT80 MCS0	58	5290	12.51	13.50	88.19	



5.5GHz WLAN	Mode	Channel	Frequency (MHz)	Average power (dBm)	Tune-Up Limit	Duty Cycle %
	802.11a 6Mbps	100	5500	16.52	18.50	96.97
		116	5580	16.85	18.50	
		124	5620	17.01	18.50	
		132	5660	16.75	18.50	
		140	5700	17.07	18.50	
	802.11n-HT20 MCS0	100	5500	16.41	18.00	96.77
		116	5580	17.38	18.50	
		124	5620	17.65	18.50	
		132	5660	17.32	18.50	
140		5700	15.29	17.00		
802.11n-HT40 MCS0	102	5510	13.77	15.50	93.75	
	110	5550	15.39	16.50		
	126	5630	15.36	16.50		
	134	5670	15.28	16.50		
802.11ac-VHT20 MCS0	100	5500	15.27	16.50	96.81	
	116	5580	15.86	16.50		
	124	5620	15.34	16.50		
	132	5660	15.14	16.50		
	140	5700	15.23	16.50		
802.11ac-VHT40 MCS0	102	5510	13.72	15.50	93.75	
	110	5550	14.92	16.50		
	126	5630	15.09	16.50		
	134	5670	15.13	16.50		
802.11ac-VHT80 MCS0	106	5530	12.33	13.50	88.19	
	122	5610	12.30	13.50		



5.8GHz WLAN	Mode	Channel	Frequency (MHz)	Average power (dBm)	Tune-Up Limit	Duty Cycle %
	802.11a 6Mbps	149	5745	16.94	18.50	96.97
		157	5785	17.18	18.50	
		165	5825	17.01	18.50	
	802.11n-HT20 MCS0	149	5745	16.94	18.50	96.77
		157	5785	17.59	18.50	
		165	5825	16.95	18.50	
	802.11n-HT40 MCS0	151	5755	15.17	16.50	93.75
		159	5795	15.37	16.50	
	802.11ac-VHT20 MCS0	149	5745	15.36	16.50	96.81
157		5785	15.95	16.50		
165		5825	15.77	16.50		
802.11ac-VHT40 MCS0	151	5755	14.85	16.50	93.75	
	159	5795	15.30	16.50		
802.11ac-VHT80 MCS0	155	5775	12.74	13.50	88.19	



<Reduced Power Mode for P-Sensor On>

<5GHz WLAN>

5.2GHz WLAN	Mode	Channel	Frequency (MHz)	Average power (dBm)	Tune-Up Limit	Duty Cycle %
	802.11a 6Mbps	36	5180	12.52	14.50	96.97
		40	5200	12.50	14.50	
		44	5220	12.54	14.50	
		48	5240	12.89	14.50	
	802.11n-HT20 MCS0	36	5180	12.25	13.50	96.77
		40	5200	12.23	13.50	
		44	5220	12.35	13.50	
		48	5240	12.37	13.50	
	802.11n-HT40 MCS0	38	5190	12.44	13.50	93.75
46		5230	12.30	13.50		
802.11ac-VHT20 MCS0	36	5180	12.29	13.50	96.81	
	40	5200	12.17	13.50		
	44	5220	12.36	13.50		
802.11ac-VHT40 MCS0	38	5190	12.39	13.50	93.75	
	46	5230	12.36	13.50		
802.11ac-VHT80 MCS0	42	5210	12.52	13.50	88.19	

5.3GHz WLAN	Mode	Channel	Frequency (MHz)	Average power (dBm)	Tune-Up Limit	Duty Cycle %
	802.11a 6Mbps	52	5260	12.68	14.50	96.97
		56	5280	12.61	14.50	
		60	5300	12.79	14.50	
		64	5320	12.69	14.50	
	802.11n-HT20 MCS0	52	5260	12.60	13.50	96.77
		56	5280	12.49	13.50	
		60	5300	12.49	13.50	
		64	5320	12.52	13.50	
	802.11n-HT40 MCS0	54	5270	12.46	13.50	93.75
62		5310	12.55	13.50		
802.11ac-VHT20 MCS0	52	5260	12.52	13.50	96.81	
	56	5280	12.56	13.50		



		60	5300	12.51	13.50	
		64	5320	12.46	13.50	
	802.11ac-VHT40 MCS0	54	5270	12.46	13.50	93.75
		62	5310	12.57	13.50	
	802.11ac-VHT80 MCS0	58	5290	12.51	13.50	88.19

	Mode	Channel	Frequency (MHz)	Average power (dBm)	Tune-Up Limit	Duty Cycle %
5.5GHz WLAN	802.11a 6Mbps	100	5500	13.09	14.50	96.97
		116	5580	13.06	14.50	
		124	5620	12.71	14.50	
		132	5660	12.78	14.50	
		140	5700	13.05	14.50	
	802.11n-HT20 MCS0	100	5500	12.17	13.50	96.77
		116	5580	13.09	13.50	
		124	5620	12.45	13.50	
		132	5660	12.18	13.50	
		140	5700	12.27	13.50	
	802.11n-HT40 MCS0	102	5510	12.30	13.50	93.75
		110	5550	12.53	13.50	
		126	5630	12.39	13.50	
		134	5670	12.09	13.50	
	802.11ac-VHT20 MCS0	100	5500	12.29	13.50	96.81
		116	5580	12.23	13.50	
		124	5620	12.34	13.50	
		132	5660	12.19	13.50	
		140	5700	12.37	13.50	
	802.11ac-VHT40 MCS0	102	5510	12.24	13.50	93.75
110		5550	12.48	13.50		
126		5630	12.39	13.50		
134		5670	12.16	13.50		
802.11ac-VHT80 MCS0	106	5530	12.33	13.50	88.19	
	122	5610	12.30	13.50		

	Mode	Channel	Frequency (MHz)	Average power (dBm)	Tune-Up Limit	Duty Cycle %
5.8GHz WLAN	802.11a 6Mbps	149	5745	12.90	14.50	96.97
		157	5785	13.02	14.50	
		165	5825	12.79	14.50	
	802.11n-HT20 MCS0	149	5745	12.16	13.50	96.77
		157	5785	12.33	13.50	
		165	5825	12.22	13.50	
	802.11n-HT40 MCS0	151	5755	12.37	13.50	93.75
		159	5795	12.42	13.50	
	802.11ac-VHT20 MCS0	149	5745	12.31	13.50	96.81
		157	5785	12.36	13.50	
		165	5825	12.31	13.50	
	802.11ac-VHT40 MCS0	151	5755	12.23	13.50	93.75
159		5795	12.43	13.50		
802.11ac-VHT80 MCS0	155	5775	12.74	13.50	88.19	

<2.4GHz Bluetooth>

General Note:

1. For 2.4GHz Bluetooth SAR testing was selected 1Mbps, due to its highest average power.
2. The Bluetooth duty cycle is 76.72 % as following figure, according to 2016 Oct. TCB workshop for Bluetooth SAR scaling need further consideration and the theoretical duty cycle is 83.3%, therefore the actual duty cycle will be scaled up to the theoretical value of Bluetooth reported SAR calculation

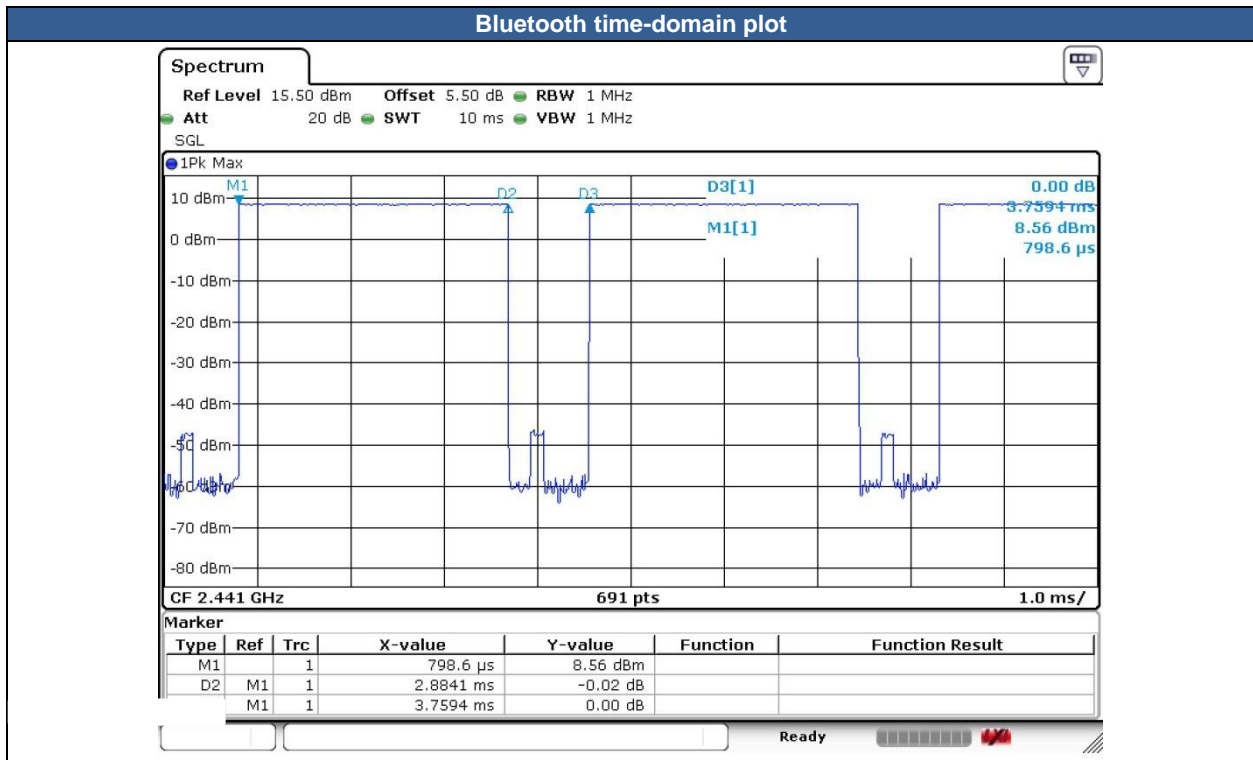

Mode	Channel	Frequency (MHz)	Average power (dBm)		Tune-up limit (dBm)
			1Mbps		
BR/EDR	CH 00	2402	8.58		10.00
	CH 39	2441	7.90		9.50
	CH 78	2480	8.60		10.00

Mode	Channel	Frequency (MHz)	Average power (dBm)	
			GFSK	
LE4.0	CH 00	2402	0.86	
	CH 19	2440	0.97	
	CH 39	2480	0.75	
Tune-up Limit			2.00	



Mode	Channel	Frequency (MHz)	Average power (dBm)
			GFSK
LE5.0	CH 00	2402	0.95
	CH 19	2440	1.05
	CH 39	2480	0.78
Tune-up Limit			2.00

14. Antenna Location

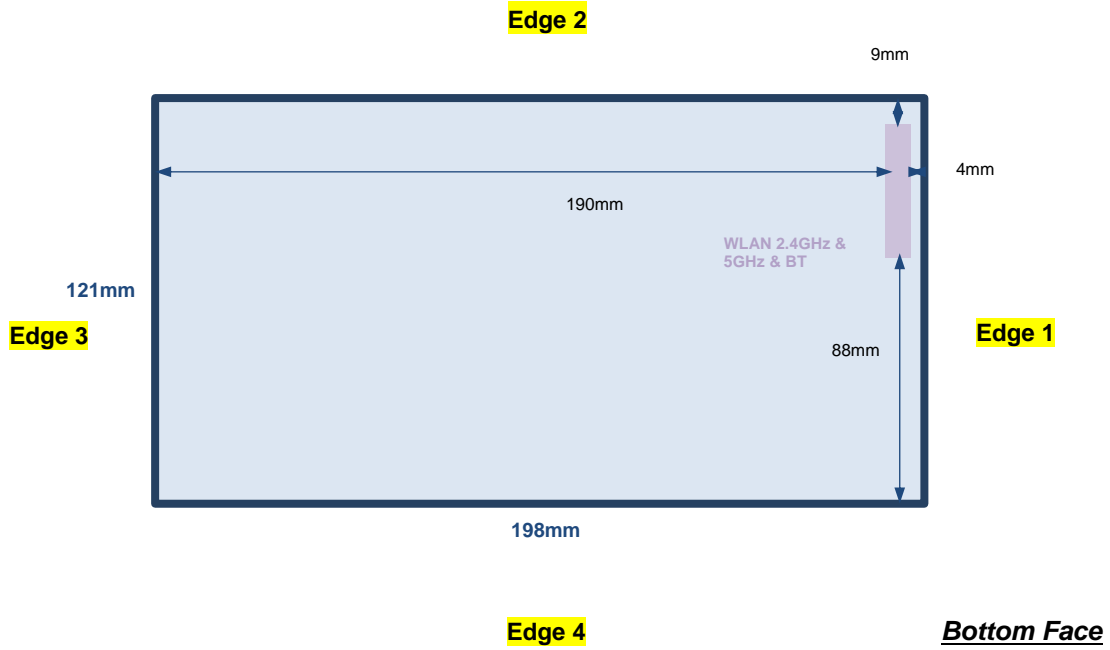

<SAR test exclusion table>

General Note:

1. The below table, when the distance is < 50 mm exclusion threshold is "Ratio", when the distance is > 50 mm exclusion threshold is "mW"
2. Maximum power is the source-based time-average power and represents the maximum RF output power among production units
3. Per KDB 447498 D01v06, for larger devices, the test separation distance of adjacent edge configuration is determined by the closest separation between the antenna and the user.
4. Per KDB 447498 D01v06, standalone SAR test exclusion threshold is applied; If the test separation distance is < 5mm, 5mm is used to determine SAR exclusion threshold.
5. Per KDB 447498 D01v06, the 1-g and 10-g SAR test exclusion thresholds for 100 MHz to 6 GHz at *test separation distances* ≤ 50 mm are determined by:
 - $[(max. power of channel, including tune-up tolerance, mW)/(min. test separation distance, mm)] \cdot \sqrt{f(GHz)} \leq 3.0$ for 1-g SAR and ≤ 7.5 for 10-g extremity SAR
 - f(GHz) is the RF channel transmit frequency in GHz
 - Power and distance are rounded to the nearest mW and mm before calculation
 - The result is rounded to one decimal place for comparison
6. Per KDB 447498 D01v06, at 100 MHz to 6 GHz and for *test separation distances* > 50 mm, the SAR test exclusion threshold is determined according to the following
 - a) [Threshold at 50 mm in step 1) + (test separation distance - 50 mm)·(f(MHz)/150)] mW, at 100 MHz to 1500 MHz
 - b) [Threshold at 50 mm in step 1) + (test separation distance - 50 mm)·10] mW at > 1500 MHz and ≤ 6 GHz

Exposure Position	Wireless Interface	BT	2.4GHz WLAN	5GHz WLAN
		Calculated Frequency	2480MHz	2462MHz
	Maximum power (dBm)	10	18	18.5
	Maximum rated power(mW)	10.0	63.0	71.0
Bottom Face	Separation distance(mm)	5.0	5.0	5.0
	exclusion threshold	3.2	19.8	34.3
	Testing required?	Yes	Yes	Yes
Edge 1	Separation distance(mm)	5.0	5.0	5.0
	exclusion threshold	3.2	19.8	34.3
	Testing required?	Yes	Yes	Yes
Edge 2	Separation distance(mm)	9.0	9.0	9.0
	exclusion threshold	1.8	11.0	19.0
	Testing required?	No	Yes	Yes
Edge 3	Separation distance(mm)	190.0	190.0	190.0
	exclusion threshold	1495.0	1496.0	1462.0
	Testing required?	No	No	No
Edge 4	Separation distance(mm)	88.0	88.0	88.0
	exclusion threshold	475.0	476.0	442.0
	Testing required?	No	No	No



15. SAR Test Results

General Note:

1. Per KDB 447498 D01v06, the reported SAR is the measured SAR value adjusted for maximum tune-up tolerance.
 - a. Tune-up scaling Factor = tune-up limit power (mW) / EUT RF power (mW), where tune-up limit is the maximum rated power among all production units.
 - b. For SAR testing of WLAN signal with non-100% duty cycle, the measured SAR is scaled-up by the duty cycle scaling factor which is equal to "1/(duty cycle)"
 - c. For WLAN/Bluetooth: Reported SAR(W/kg)= Measured SAR(W/kg)* Duty Cycle scaling factor * Tune-up scaling factor
2. Per KDB 447498 D01v06, for each exposure position, testing of other required channels within the operating mode of a frequency band is not required when the *reported* 1-g or 10-g SAR for the mid-band or highest output power channel is:
 - ≤ 0.8 W/kg or 2.0 W/kg, for 1-g or 10-g respectively, when the transmission band is ≤ 100 MHz
 - ≤ 0.6 W/kg or 1.5 W/kg, for 1-g or 10-g respectively, when the transmission band is between 100 MHz and 200 MHz
 - ≤ 0.4 W/kg or 1.0 W/kg, for 1-g or 10-g respectively, when the transmission band is ≥ 200 MHz
3. Per KDB 865664 D01v01r04, for each frequency band, repeated SAR measurement is required only when the measured SAR is ≥ 0.8 W/kg.

WLAN Note:

1. Per KDB 248227 D01v02r02, for 2.4GHz 802.11g/n SAR testing is not required when the highest reported SAR for DSSS is adjusted by the ratio of OFDM to DSSS specified maximum output power and the adjusted SAR is ≤ 1.2 W/kg.
2. Per KDB 248227 D01v02r02, U-NII-1 SAR testing is not required when the U-NII-2A band highest reported SAR for a test configuration is ≤ 1.2 W/kg, SAR is not required for U-NII-1 band.
3. When the reported SAR of the test position is > 0.4 W/kg, SAR is repeated for the 802.11 transmission mode configuration tested in the initial test position to measure the subsequent next closet/smallest test separation distance and maximum coupling test position on the highest maximum output power channel, until the report SAR is ≤ 0.8 W/kg or all required test position are tested.
4. For all positions / configurations, when the reported SAR is > 0.8 W/kg, SAR is measured for these test positions / configurations on the subsequent next highest measured output power channel(s) until the reported SAR is ≤ 1.2 W/kg or all required channels are tested.
5. During SAR testing the WLAN transmission was verified using a spectrum analyzer.



15.1 Body SAR

<WLAN 2.4GHz SAR>

Plot No.	Band	Mode	Test Position	Gap (mm)	Power Mode	Ch.	Freq. (MHz)	Average Power (dBm)	Tune-Up Limit (dBm)	Tune-up Scaling Factor	Duty Cycle %	Duty Cycle Scaling Factor	Power Drift (dB)	Measured 1g SAR (W/kg)	Reported 1g SAR (W/kg)
	WLAN2.4GHz	802.11b 1Mbps	Edge 1	0	Full	6	2437	16.59	18.00	1.384	100	1.000	-0.02	0.425	0.588
	WLAN2.4GHz	802.11b 1Mbps	Edge 2	0	Full	6	2437	16.59	18.00	1.384	100	1.000	0.03	0.258	0.357
01	WLAN2.4GHz	802.11b 1Mbps	Bottom Face	0	Full	6	2437	16.59	18.00	1.384	100	1.000	-0.04	0.831	1.150
	WLAN2.4GHz	802.11b 1Mbps	Bottom Face	0	Full	1	2412	12.43	14.00	1.435	100	1.000	0.05	0.380	0.545
	WLAN2.4GHz	802.11b 1Mbps	Bottom Face	0	Full	11	2462	13.24	14.00	1.191	100	1.000	0.04	0.370	0.441



<WLAN5G SAR>

Plot No.	Band	Mode	Test Position	Gap (mm)	Power Mode	Ch.	Freq. (MHz)	Average Power (dBm)	Tune-Up Limit (dBm)	Tune-up Scaling Factor	Duty Cycle %	Duty Cycle Scaling Factor	Power Drift (dB)	Measured 1g SAR (W/kg)	Reported 1g SAR (W/kg)
02	WLAN5.3GHz	802.11a 6Mbps	Edge 1	0	Reduced	60	5300	12.79	14.50	1.483	96.97	1.031	-0.02	0.657	1.004
	WLAN5.3GHz	802.11a 6Mbps	Edge 2	0	Reduced	60	5300	12.79	14.50	1.483	96.97	1.031	0.01	0.152	0.232
	WLAN5.3GHz	802.11a 6Mbps	Bottom Face	0	Reduced	60	5300	12.79	14.50	1.483	96.97	1.031	0.07	0.332	0.507
	WLAN5.3GHz	802.11a 6Mbps	Edge 1	0	Reduced	64	5320	12.69	14.50	1.517	96.97	1.031	-0.08	0.523	0.818
	WLAN5.3GHz	802.11a 6Mbps	Edge 1	0	Reduced	52	5260	12.68	14.50	1.521	96.97	1.031	0.02	0.616	0.966
	WLAN5.3GHz	802.11a 6Mbps	Bottom Face	5	Full	60	5300	17.24	18.50	1.335	96.97	1.031	0.01	0.332	0.457
	WLAN5.3GHz	802.11a 6Mbps	Edge 1	8	Full	60	5300	17.24	18.50	1.335	96.97	1.031	-0.01	0.348	0.479
	WLAN5.3GHz	802.11a 6Mbps	Edge 2	5	Full	60	5300	17.24	18.50	1.335	96.97	1.031	0.03	0.112	0.154
	WLAN5.5GHz	802.11a 6Mbps	Edge 1	0	Reduced	100	5500	13.09	14.50	1.384	96.97	1.031	-0.07	0.440	0.628
	WLAN5.5GHz	802.11a 6Mbps	Edge 2	0	Reduced	100	5500	13.09	14.50	1.384	96.97	1.031	0.05	0.156	0.223
	WLAN5.5GHz	802.11a 6Mbps	Bottom Face	0	Reduced	100	5500	13.09	14.50	1.384	96.97	1.031	-0.02	0.270	0.385
	WLAN5.5GHz	802.11a 6Mbps	Edge 1	0	Reduced	116	5580	13.06	14.50	1.393	96.97	1.031	0.06	0.410	0.589
	WLAN5.5GHz	802.11a 6Mbps	Edge 1	0	Reduced	140	5700	13.05	14.50	1.396	96.97	1.031	0.02	0.455	0.655
03	WLAN5.5GHz	802.11a 6Mbps	Edge 1	0	Reduced	132	5660	12.78	14.50	1.486	96.97	1.031	-0.01	0.582	0.892
	WLAN5.5GHz	802.11a 6Mbps	Bottom Face	5	Full	140	5700	17.07	18.50	1.389	96.97	1.031	0.01	0.252	0.361
	WLAN5.5GHz	802.11a 6Mbps	Edge 1	8	Full	140	5700	17.07	18.50	1.389	96.97	1.031	-0.02	0.356	0.510
	WLAN5.5GHz	802.11a 6Mbps	Edge 2	5	Full	140	5700	17.07	18.50	1.389	96.97	1.031	0.02	0.109	0.156
	WLAN5.8GHz	802.11a 6Mbps	Edge 1	0	Reduced	157	5785	13.02	14.50	1.406	96.97	1.031	-0.05	0.341	0.494
	WLAN5.8GHz	802.11a 6Mbps	Edge 2	0	Reduced	157	5785	13.02	14.50	1.406	96.97	1.031	-0.16	0.207	0.300
	WLAN5.8GHz	802.11a 6Mbps	Bottom Face	0	Reduced	157	5785	13.02	14.50	1.406	96.97	1.031	0.08	0.272	0.394
	WLAN5.8GHz	802.11a 6Mbps	Edge 1	0	Reduced	149	5745	12.90	14.50	1.445	96.97	1.031	-0.02	0.311	0.463
04	WLAN5.8GHz	802.11a 6Mbps	Edge 1	0	Reduced	165	5825	12.79	14.50	1.481	96.97	1.031	-0.07	0.345	0.527
	WLAN5.8GHz	802.11a 6Mbps	Bottom Face	5	Full	157	5785	17.18	18.50	1.354	96.97	1.031	0.01	0.297	0.415
	WLAN5.8GHz	802.11a 6Mbps	Edge 1	8	Full	157	5785	17.18	18.50	1.354	96.97	1.031	-0.03	0.333	0.465
	WLAN5.8GHz	802.11a 6Mbps	Edge 2	5	Full	157	5785	17.18	18.50	1.354	96.97	1.031	0.01	0.122	0.170

<Bluetooth SAR>

Plot No.	Band	Mode	Test Position	Gap (mm)	Power Mode	Ch.	Freq. (MHz)	Average Power (dBm)	Tune-Up Limit (dBm)	Tune-up Scaling Factor	Duty Cycle %	Duty Cycle Scaling Factor	Power Drift (dB)	Measured 1g SAR (W/kg)	Reported 1g SAR (W/kg)
	Bluetooth	1Mbps	Bottom Face	0	Full	78	2480	8.60	10.00	1.380	76.72	1.086	0.03	0.052	0.079
	Bluetooth	1Mbps	Edge 1	0	Full	78	2480	8.60	10.00	1.380	76.72	1.086	-0.02	0.056	0.084
	Bluetooth	1Mbps	Edge 2	0	Full	78	2480	8.60	10.00	1.380	76.72	1.086	0.01	0.044	0.065
	Bluetooth	1Mbps	Edge 1	0	Full	00	2402	8.58	10.00	1.387	76.72	1.086	-0.04	0.054	0.082
05	Bluetooth	1Mbps	Edge 1	0	Full	39	2441	7.90	9.50	1.445	76.72	1.086	-0.01	0.057	0.089



15.2 Repeated SAR Measurement

Table with 16 columns: No., Band, Modulation, Test Position, Gap (mm), Power Reduction, Ch., Freq. (MHz), Average Power (dBm), Tune-Up Limit (dBm), Tune-up Scaling Factor, Duty Cycle %, Duty Cycle Scaling Factor, Power Drift (dB), Measured 1g SAR (W/kg), Ratio, Reported 1g SAR (W/kg). It contains two rows of data for WLAN2.4GHz measurements.

General Note:

- 1. Per KDB 865664 D01v01r04, for each frequency band, repeated SAR measurement is required only when the measured SAR is ≥0.8W/kg.
2. Per KDB 865664 D01v01r04, if the ratio among the repeated measurement is ≤ 1.2 and the measured SAR <1.45W/kg, only one repeated measurement is required.
3. The ratio is the difference in percentage between original and repeated measured SAR.
4. All measurement SAR result is scaled-up to account for tune-up tolerance and is compliant.

16. Simultaneous Transmission Analysis

NO.	Simultaneous Transmission Configurations
1.	None

General Note:

1. EUT will choose either WLAN 2.4GHz or WLAN 5GHz according to the network signal condition; therefore, 2.4GHz WLAN and 5GHz WLAN will not operate simultaneously at any moment.
2. WLAN 2.4GHz and Bluetooth share the same antenna, so WLAN and Bluetooth cannot transmit simultaneously.
3. According to the EUT character, WLAN 5GHz and Bluetooth can't transmit simultaneously.

Test Engineer : Nick Hu, Yuan Zhao, Jiaxing Chang, Yuankai Kong



17. Uncertainty Assessment

Per KDB 865664 D01 SAR measurement 100MHz to 6GHz, when the highest measured 1-g SAR within a frequency band is < 1.5 W/kg and the measured 10-g SAR within a frequency band is < 3.75 W/kg. The expanded SAR measurement uncertainty must be $\leq 30\%$, for a confidence interval of $k = 2$. If these conditions are met, extensive SAR measurement uncertainty analysis described in IEEE Std 1528-2013 is not required in SAR reports submitted for equipment approval. For this device, the highest measured 1-g SAR is less 1.5W/kg. Therefore, the measurement uncertainty table is not required in this report.



18. References

- [1] FCC 47 CFR Part 2 “Frequency Allocations and Radio Treaty Matters; General Rules and Regulations”
- [2] ANSI/IEEE Std. C95.1-1992, “IEEE Standard for Safety Levels with Respect to Human Exposure to Radio Frequency Electromagnetic Fields, 3 kHz to 300 GHz”, September 1992
- [3] IEEE Std. 1528-2013, “IEEE Recommended Practice for Determining the Peak Spatial-Average Specific Absorption Rate (SAR) in the Human Head from Wireless Communications Devices: Measurement Techniques”, Sep 2013
- [4] SPEAG DASY System Handbook
- [5] FCC KDB 865664 D01 v01r04, "SAR Measurement Requirements for 100 MHz to 6 GHz", Aug 2015.
- [6] FCC KDB 865664 D02 v01r02, “RF Exposure Compliance Reporting and Documentation Considerations” Oct 2015.
- [7] FCC KDB 447498 D01 v06, “Mobile and Portable Device RF Exposure Procedures and Equipment Authorization Policies”, Oct 2015
- [8] FCC KDB 248227 D01 v02r02, “SAR Guidance for IEEE 802.11 (WiFi) Transmitters”, Oct 2015.
- [9] FCC KDB 616217 D04 v01r02, “SAR Evaluation Considerations for Laptop, Notebook, Netbook and Tablet Computers”, Oct 2015

-----THE END-----



Appendix A. Plots of System Performance Check

The plots are shown as follows.

System Check_Head_2450MHz

DUT: D2450V2 - SN:908

Communication System: UID 0, CW; Frequency: 2450 MHz; Duty Cycle: 1:1
Medium: HSL_2450 Medium parameters used: $f = 2450$ MHz; $\sigma = 1.779$ S/m; $\epsilon_r = 40.667$; $\rho = 1000$ kg/m³
Ambient Temperature : 23.2 °C; Liquid Temperature : 22.6 °C

DASY5 Configuration:

- Probe: EX3DV4 - SN3857; ConvF(7.5, 7.5, 7.5); Calibrated: 2019.5.27
- Sensor-Surface: 1.4mm (Mechanical Surface Detection)
- Electronics: DAE4 Sn1338; Calibrated: 2018.12.3
- Phantom: SAM3; Type: SAM; Serial: TP:1201
- Measurement SW: DASY52, Version 52.10 (1); SEMCAD X Version 14.6.11 (7439)

Pin=250mW/Area Scan (71x71x1): Interpolated grid: dx=1.200 mm, dy=1.200 mm
Maximum value of SAR (interpolated) = 22.7 W/kg

Pin=250mW/Zoom Scan (7x7x7)/Cube 0: Measurement grid: dx=5mm, dy=5mm, dz=5mm
Reference Value = 95.28 V/m; Power Drift = 0.10 dB
Peak SAR (extrapolated) = 26.0 W/kg
SAR(1 g) = 13.4 W/kg; SAR(10 g) = 6.43 W/kg
Maximum value of SAR (measured) = 21.6 W/kg

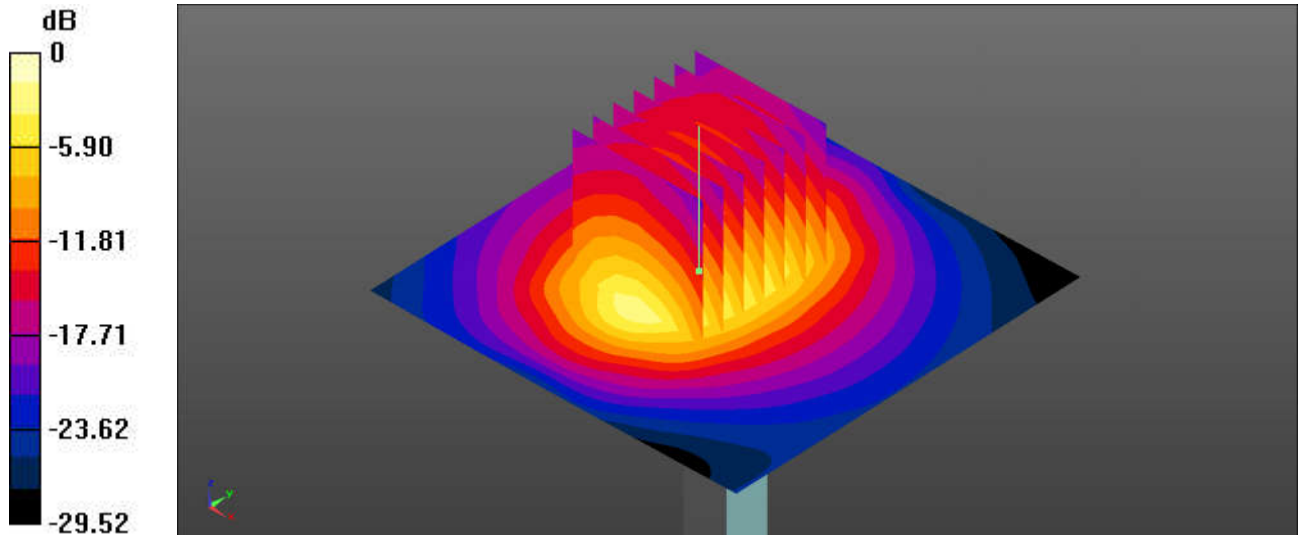

0 dB = 22.7 W/kg = 13.56 dBW/kg

System Check_Head_5250MHz

DUT: D5GHzV2 - SN:1006

Communication System: UID 0, CW (0); Frequency: 5250 MHz; Duty Cycle: 1:1

Medium: HSL_5000 Medium parameters used: $f = 5250$ MHz; $\sigma = 4.555$ S/m; $\epsilon_r = 34.768$; $\rho = 1000$ kg/m³

Ambient Temperature : 23.2 °C; Liquid Temperature : 22.8 °C

DASY5 Configuration:

- Probe: EX3DV4 - SN3857; ConvF(5.19, 5.19, 5.19); Calibrated: 2019.5.27
- Sensor-Surface: 1.4mm (Mechanical Surface Detection)
- Electronics: DAE4 Sn1338; Calibrated: 2018.12.3
- Phantom: SAM3; Type: SAM; Serial: TP:1201
- Measurement SW: DASY52, Version 52.10 (1); SEMCAD X Version 14.6.11 (7439)

Pin=100mW/Area Scan (71x71x1): Interpolated grid: dx=1.000 mm, dy=1.000 mm

Maximum value of SAR (interpolated) = 18.2 W/kg

Pin=100mW/Zoom Scan (8x8x7)/Cube 0: Measurement grid: dx=4mm, dy=4mm, dz=1.4mm

Reference Value = 63.91 V/m; Power Drift = 0.10 dB

Peak SAR (extrapolated) = 28.9 W/kg

SAR(1 g) = 7.91 W/kg; SAR(10 g) = 2.4 W/kg

Maximum value of SAR (measured) = 18.8 W/kg

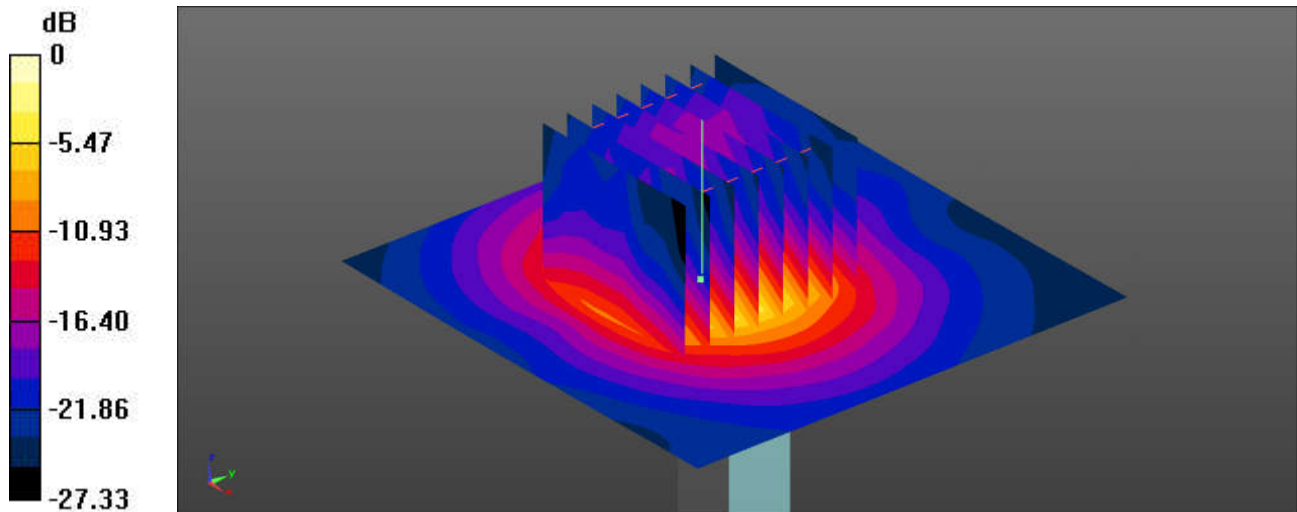

0 dB = 18.8 W/kg = 12.74 dBW/kg

System Check_Head_5600MHz

DUT: D5GHzV2 - SN:1006

Communication System: UID 0, CW (0); Frequency: 5600 MHz; Duty Cycle: 1:1

Medium: HSL_5000 Medium parameters used: $f = 5600$ MHz; $\sigma = 4.897$ S/m; $\epsilon_r = 34.294$; $\rho = 1000$ kg/m³

Ambient Temperature : 23.2 °C; Liquid Temperature : 22.9 °C

DASY5 Configuration:

- Probe: EX3DV4 - SN3857; ConvF(4.92, 4.92, 4.92); Calibrated: 2019.5.27
- Sensor-Surface: 1.4mm (Mechanical Surface Detection)
- Electronics: DAE4 Sn1338; Calibrated: 2018.12.3
- Phantom: SAM3; Type: SAM; Serial: TP:1201
- Measurement SW: DASY52, Version 52.10 (1); SEMCAD X Version 14.6.11 (7439)

Pin=100mW/Area Scan (71x71x1): Interpolated grid: dx=1.000 mm, dy=1.000 mm

Maximum value of SAR (interpolated) = 20.53 W/kg

Pin=100mW/Zoom Scan (8x8x7)/Cube 0: Measurement grid: dx=4mm, dy=4mm, dz=1.4mm

Reference Value = 65.07 V/m; Power Drift = 0.01 dB

Peak SAR (extrapolated) = 34.0 W/kg

SAR(1 g) = 8.5 W/kg; SAR(10 g) = 2.55 W/kg

Maximum value of SAR (measured) = 20.8 W/kg

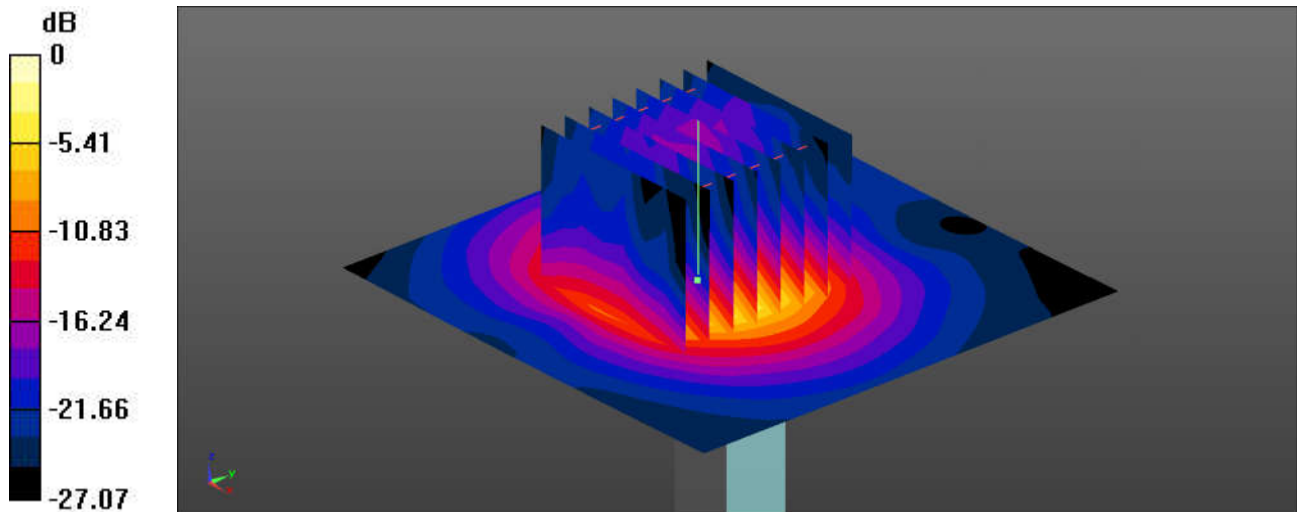

0 dB = 21.8 W/kg = 13.18 dBW/kg

System Check_Head_5750MHz

DUT: D5GHzV2 - SN:1006

Communication System: UID 0, CW (0); Frequency: 5750 MHz; Duty Cycle: 1:1

Medium: HSL_5000 Medium parameters used: $f = 5750$ MHz; $\sigma = 5.048$ S/m; $\epsilon_r = 34.066$; $\rho = 1000$ kg/m³

Ambient Temperature : 23.3 °C; Liquid Temperature : 22.7 °C

DASY5 Configuration:

- Probe: EX3DV4 - SN3857; ConvF(5.17, 5.17, 5.17); Calibrated: 2019.5.27
- Sensor-Surface: 1.4mm (Mechanical Surface Detection)
- Electronics: DAE4 Sn1338; Calibrated: 2018.12.3
- Phantom: SAM3; Type: SAM; Serial: TP:1201
- Measurement SW: DASY52, Version 52.10 (1); SEMCAD X Version 14.6.11 (7439)

Pin=100mW/Area Scan (71x71x1): Interpolated grid: dx=1.000 mm, dy=1.000 mm

Maximum value of SAR (interpolated) = 19.6 W/kg

Pin=100mW/Zoom Scan (8x8x7)/Cube 0: Measurement grid: dx=4mm, dy=4mm, dz=1.4mm

Reference Value = 62.62 V/m; Power Drift = -0.08 dB

Peak SAR (extrapolated) = 32.5 W/kg

SAR(1 g) = 7.86 W/kg; SAR(10 g) = 2.37 W/kg

Maximum value of SAR (measured) = 19.5 W/kg

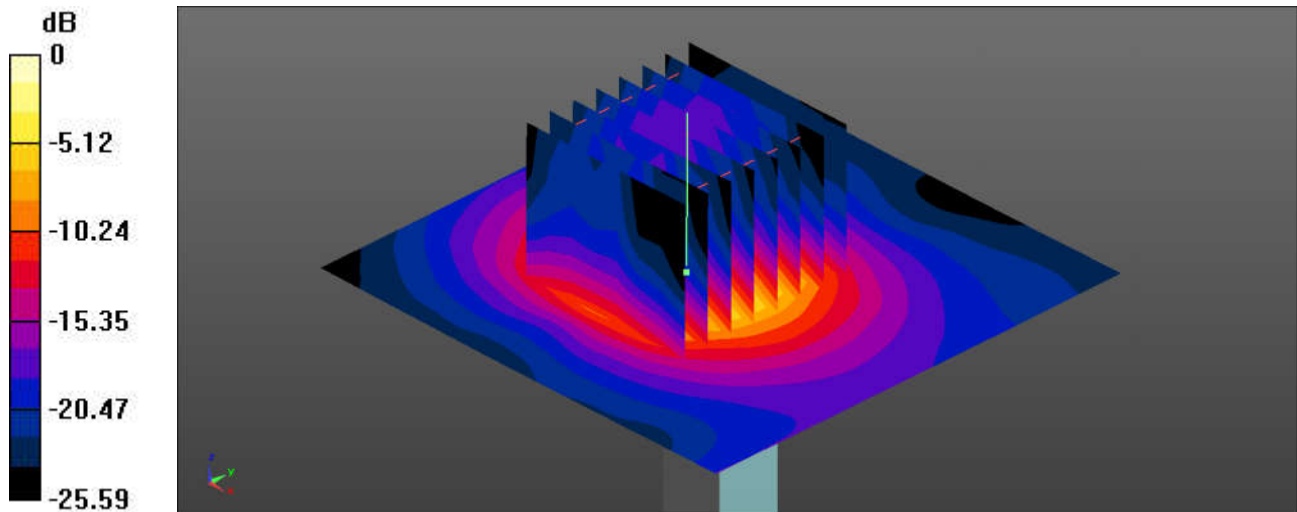

0 dB = 19.6 W/kg = 12.92 dBW/kg



Appendix B. Plots of SAR Measurement

The plots are shown as follows.

01_WLAN2.4GHz_802.11b 1Mbps_Bottom Face_0mm_Ch6

Communication System: UID 0, 802.11b (0); Frequency: 2437 MHz; Duty Cycle: 1:1
Medium: HSL_2450 Medium parameters used: $f = 2437$ MHz; $\sigma = 1.767$ S/m; $\epsilon_r = 40.709$; $\rho = 1000$ kg/m³
Ambient Temperature : 23.2 °C; Liquid Temperature : 22.6 °C

DASY5 Configuration:

- Probe: EX3DV4 - SN3857; ConvF(7.5, 7.5, 7.5); Calibrated: 2019.5.27
- Sensor-Surface: 1.4mm (Mechanical Surface Detection)
- Electronics: DAE4 Sn1338; Calibrated: 2018.12.3
- Phantom: SAM3; Type: SAM; Serial: TP:1201
- Measurement SW: DASY52, Version 52.10 (1); SEMCAD X Version 14.6.11 (7439)

Ch6/Area Scan (71x81x1): Interpolated grid: dx=1.200 mm, dy=1.200 mm

Maximum value of SAR (interpolated) = 1.07 W/kg

Ch6/Zoom Scan (7x7x7)/Cube 0: Measurement grid: dx=5mm, dy=5mm, dz=5mm

Reference Value = 1.606 V/m; Power Drift = -0.04 dB

Peak SAR (extrapolated) = 2.64 W/kg

SAR(1 g) = 0.831 W/kg; SAR(10 g) = 0.317 W/kg

Maximum value of SAR (measured) = 1.21 W/kg

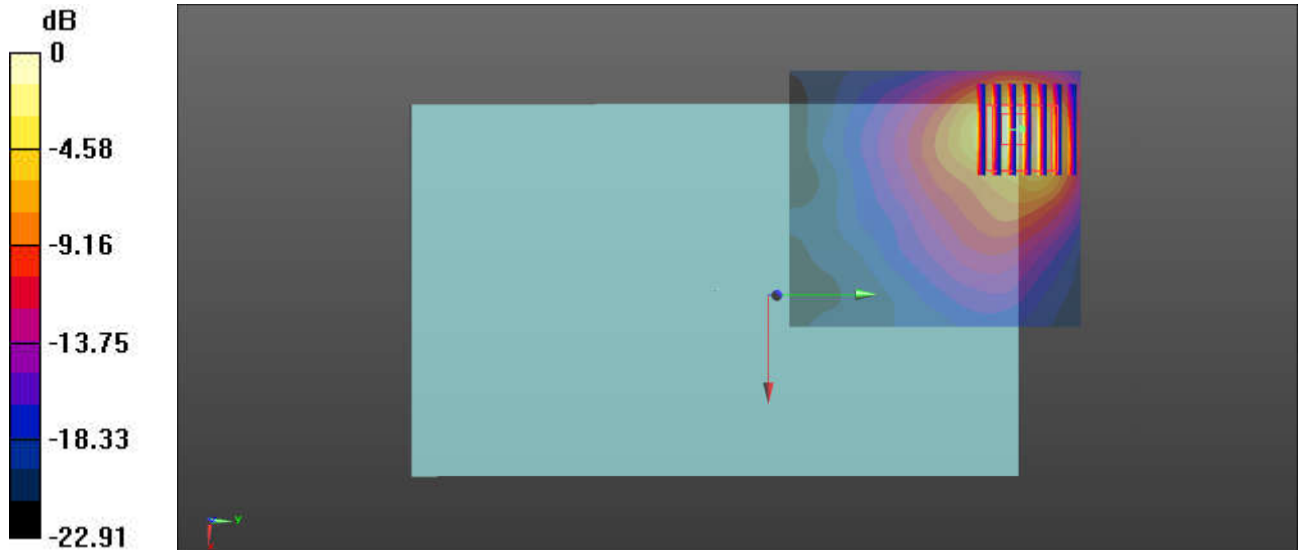

0 dB = 1.07 W/kg = 0.29 dBW/kg

02_WLAN5GHz_802.11a 6Mbps_Edge 1_0mm_Ch60

Communication System: UID 0, 802.11a (0); Frequency: 5300 MHz; Duty Cycle: 1:1.031
Medium: HSL_5000 Medium parameters used: $f = 5300$ MHz; $\sigma = 4.601$ S/m; $\epsilon_r = 34.704$; $\rho = 1000$ kg/m³
Ambient Temperature : 23.2 °C; Liquid Temperature : 22.8 °C

DASY5 Configuration:

- Probe: EX3DV4 - SN3857; ConvF(5.19, 5.19, 5.19); Calibrated: 2019.5.27
- Sensor-Surface: 1.4mm (Mechanical Surface Detection)
- Electronics: DAE4 Sn1338; Calibrated: 2018.12.3
- Phantom: SAM3; Type: SAM; Serial: TP:1201
- Measurement SW: DASY52, Version 52.10 (1); SEMCAD X Version 14.6.11 (7439)

Ch60/Area Scan (41x91x1): Interpolated grid: dx=1.000 mm, dy=1.000 mm

Maximum value of SAR (interpolated) = 1.49 W/kg

Ch60/Zoom Scan (7x7x7)/Cube 0: Measurement grid: dx=4mm, dy=4mm, dz=1.4mm

Reference Value = 5.183 V/m; Power Drift = -0.02 dB

Peak SAR (extrapolated) = 2.65 W/kg

SAR(1 g) = 0.657 W/kg; SAR(10 g) = 0.223 W/kg

Maximum value of SAR (measured) = 1.49 W/kg

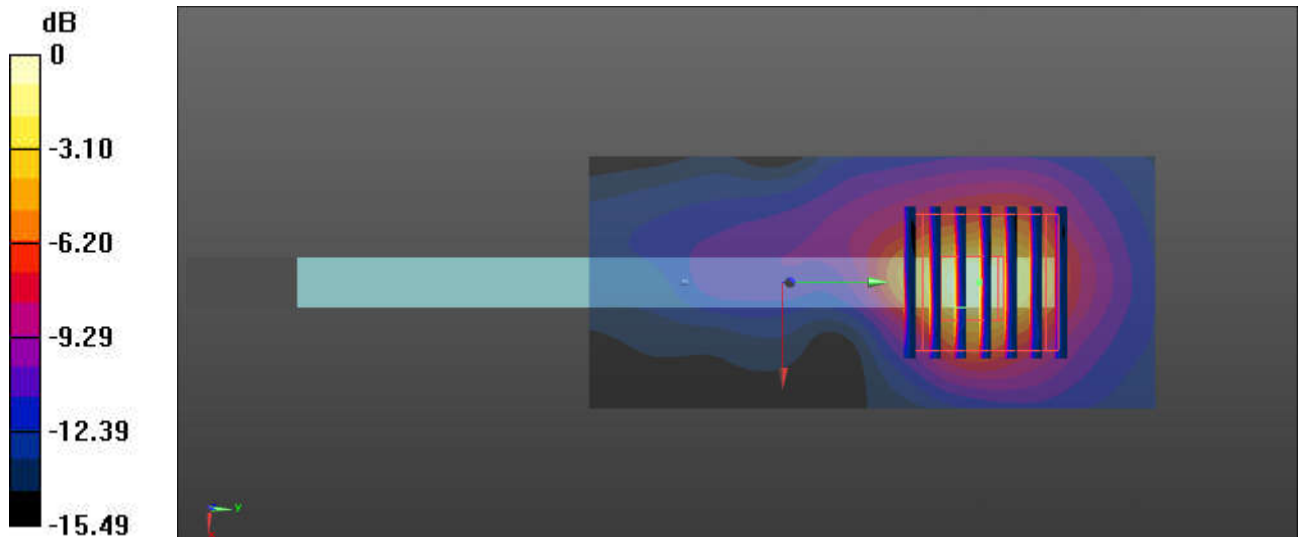

0 dB = 1.49 W/kg = 1.73 dBW/kg

03_WLAN 5.5GHz_802.11a 6Mbps_Edge 1_0mm_Ch132

Communication System: UID 0, 802.11a (0); Frequency: 5660 MHz; Duty Cycle: 1:1.031
Medium: HSL_5000 Medium parameters used: $f = 5660$ MHz; $\sigma = 4.964$ S/m; $\epsilon_r = 34.189$; $\rho = 1000$ kg/m³
Ambient Temperature : 23.2 °C; Liquid Temperature : 22.9 °C

DASY5 Configuration:

- Probe: EX3DV4 - SN3857; ConvF(4.92, 4.92, 4.92); Calibrated: 2019.5.27
- Sensor-Surface: 1.4mm (Mechanical Surface Detection)
- Electronics: DAE4 Sn1338; Calibrated: 2018.12.3
- Phantom: SAM3; Type: SAM; Serial: TP:1201
- Measurement SW: DASY52, Version 52.10 (1); SEMCAD X Version 14.6.11 (7439)

Ch132/Area Scan (41x91x1): Interpolated grid: dx=1.000 mm, dy=1.000 mm

Maximum value of SAR (interpolated) = 1.02 W/kg

Ch132/Zoom Scan (7x7x7)/Cube 0: Measurement grid: dx=4mm, dy=4mm, dz=1.4mm

Reference Value = 7.939 V/m; Power Drift = -0.01 dB

Peak SAR (extrapolated) = 1.31 W/kg

SAR(1 g) = 0.582 W/kg; SAR(10 g) = 0.341 W/kg

Maximum value of SAR (measured) = 1.03 W/kg

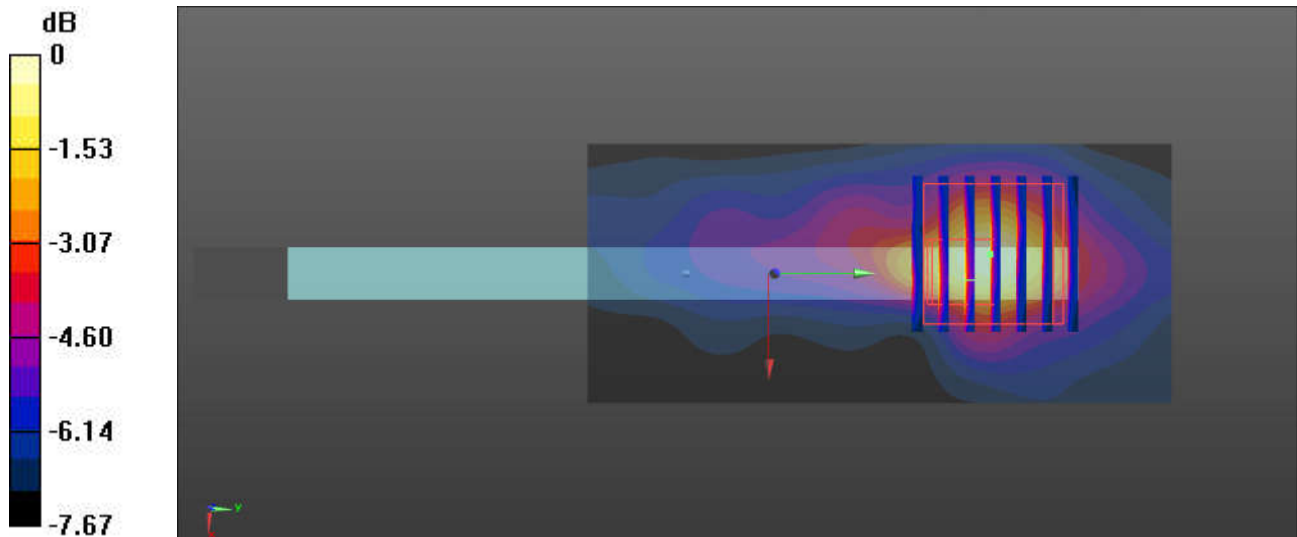

0 dB = 1.02 W/kg = 0.09 dBW/kg

04_WLAN 5.8GHz_802.11a 6Mbps_Edge 1_0mm_Ch165

Communication System: UID 0, 802.11a (0); Frequency: 5825 MHz; Duty Cycle: 1:1.031
Medium: HSL_5000 Medium parameters used: $f = 5825$ MHz; $\sigma = 5.126$ S/m; $\epsilon_r = 33.99$; $\rho = 1000$ kg/m³
Ambient Temperature : 23.3 °C ; Liquid Temperature : 22.7 °C

DASY5 Configuration:

- Probe: EX3DV4 - SN3857; ConvF(5.17, 5.17, 5.17); Calibrated: 2019.5.27
- Sensor-Surface: 1.4mm (Mechanical Surface Detection)
- Electronics: DAE4 Sn1338; Calibrated: 2018.12.3
- Phantom: SAM3; Type: SAM; Serial: TP:1201
- Measurement SW: DASY52, Version 52.10 (1); SEMCAD X Version 14.6.11 (7439)

Ch165/Area Scan (41x91x1): Interpolated grid: dx=1.000 mm, dy=1.000 mm

Maximum value of SAR (interpolated) = 0.800 W/kg

Ch165/Zoom Scan (7x7x7)/Cube 0: Measurement grid: dx=4mm, dy=4mm, dz=1.4mm

Reference Value = 5.367 V/m; Power Drift = -0.07 dB

Peak SAR (extrapolated) = 2.10 W/kg

SAR(1 g) = 0.345 W/kg; SAR(10 g) = 0.085 W/kg

Maximum value of SAR (measured) = 1.01 W/kg

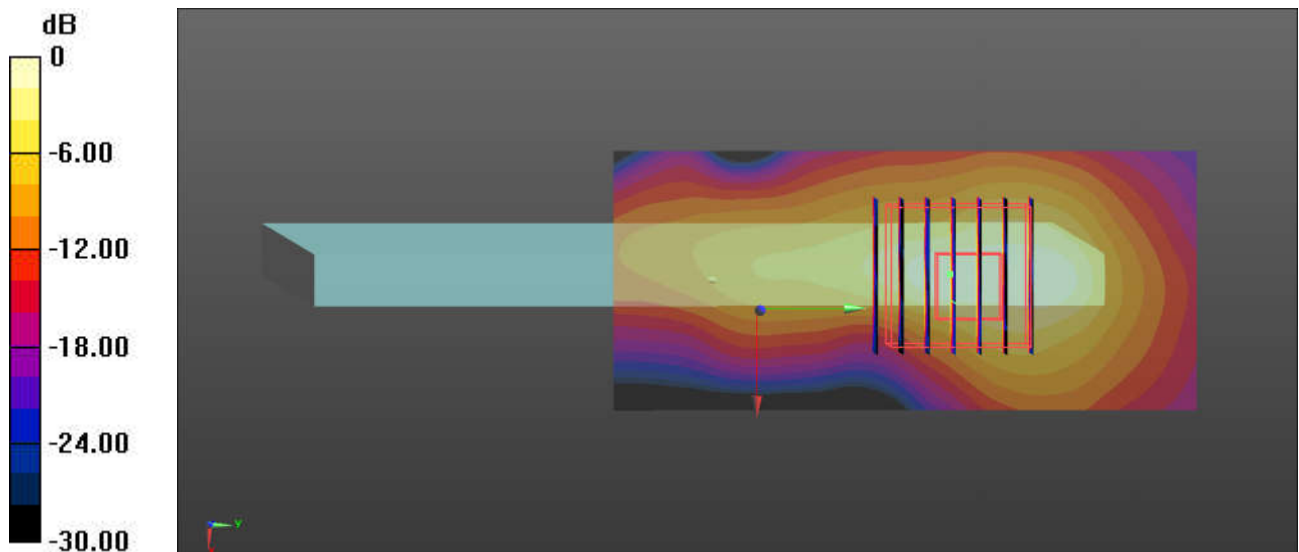

0 dB = 0.800 W/kg = -0.97 dBW/kg

05_Bluetooth_1Mbps_Edge 1_0mm_Ch39

Communication System: UID 0, Bluetooth (0); Frequency: 2441 MHz; Duty Cycle: 1:1.303
Medium: HSL_2450 Medium parameters used: $f = 2441$ MHz; $\sigma = 1.771$ S/m; $\epsilon_r = 40.697$; $\rho = 1000$ kg/m³
Ambient Temperature : 23.2 °C; Liquid Temperature : 22.6 °C

DASY5 Configuration:

- Probe: EX3DV4 - SN3857; ConvF(7.5, 7.5, 7.5); Calibrated: 2019.5.27
- Sensor-Surface: 1.4mm (Mechanical Surface Detection)
- Electronics: DAE4 Sn1338; Calibrated: 2018.12.3
- Phantom: SAM3; Type: SAM; Serial: TP:1201
- Measurement SW: DASY52, Version 52.10 (1); SEMCAD X Version 14.6.11 (7439)

Ch39/Area Scan (41x91x1): Interpolated grid: dx=1.200 mm, dy=1.200 mm

Maximum value of SAR (interpolated) = 0.0605 W/kg

Ch39/Zoom Scan (7x7x7)/Cube 0: Measurement grid: dx=5mm, dy=5mm, dz=5mm

Reference Value = 4.983 V/m; Power Drift = -0.01 dB

Peak SAR (extrapolated) = 0.182 W/kg

SAR(1 g) = 0.057 W/kg; SAR(10 g) = 0.040 W/kg

Maximum value of SAR (measured) = 0.0691 W/kg

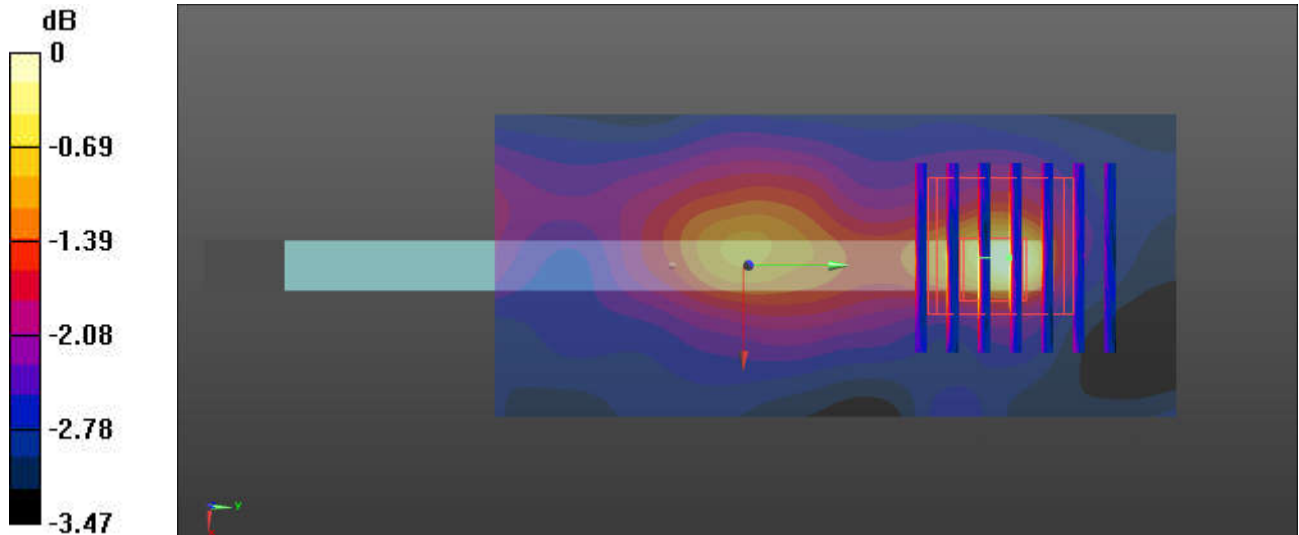

0 dB = 0.0605 W/kg = -12.18 dBW/kg



Appendix C. DAS Y Calibration Certificate

The DAS Y calibration certificates are shown as follows.



In Collaboration with
s p e a g
CALIBRATION LABORATORY



中国认可
国际互认
校准
CALIBRATION
CNAS L0570

Add: No.51 Xueyuan Road, Haidian District, Beijing, 100191, China
Tel: +86-10-62304633-2079 Fax: +86-10-62304633-2504
E-mail: cttl@chinattl.com http://www.chinattl.cn

Client **Sporton**

Certificate No: **Z19-60087**

CALIBRATION CERTIFICATE

Object **D2450V2 - SN: 908**

Calibration Procedure(s) **FF-Z11-003-01**
Calibration Procedures for dipole validation kits

Calibration date: **March 25, 2019**

This calibration Certificate documents the traceability to national standards, which realize the physical units of measurements(SI). The measurements and the uncertainties with confidence probability are given on the following pages and are part of the certificate.

All calibrations have been conducted in the closed laboratory facility: environment temperature(22±3)°C and humidity<70%.

Calibration Equipment used (M&TE critical for calibration)

Primary Standards	ID #	Cal Date(Calibrated by, Certificate No.)	Scheduled Calibration
Power Meter NRP2	106277	20-Aug-18 (CTTL, No.J18X06862)	Aug-19
Power sensor NRP8S	104291	20-Aug-18 (CTTL, No.J18X06862)	Aug-19
Reference Probe EX3DV4	SN 3617	31-Jan-19(SPEAG,No.EX3-3617_Jan19)	Jan-20
DAE4	SN 1331	06-Feb-19(SPEAG,No.DAE4-1331_Feb19)	Feb-20
Secondary Standards	ID #	Cal Date(Calibrated by, Certificate No.)	Scheduled Calibration
Signal Generator E4438C	MY49071430	23-Jan-19 (CTTL, No.J19X00336)	Jan-20
NetworkAnalyzer E5071C	MY46110673	24-Jan-19 (CTTL, No.J19X00547)	Jan-20

	Name	Function	Signature
Calibrated by:	Zhao Jing	SAR Test Engineer	
Reviewed by:	Lin Hao	SAR Test Engineer	
Approved by:	Qi Dianyuan	SAR Project Leader	

Issued: March 28, 2019

This calibration certificate shall not be reproduced except in full without written approval of the laboratory.



In Collaboration with

s p e a g

CALIBRATION LABORATORY

Add: No.51 Xueyuan Road, Haidian District, Beijing, 100191, China

Tel: +86-10-62304633-2079

Fax: +86-10-62304633-2504

E-mail: cttl@chinattl.com

http://www.chinattl.cn

Glossary:

TSL	tissue simulating liquid
ConvF	sensitivity in TSL / NORM _{x,y,z}
N/A	not applicable or not measured

Calibration is Performed According to the Following Standards:

- IEEE Std 1528-2013, "IEEE Recommended Practice for Determining the Peak Spatial-Averaged Specific Absorption Rate (SAR) in the Human Head from Wireless Communications Devices: Measurement Techniques", June 2013
- IEC 62209-1, "Measurement procedure for assessment of specific absorption rate of human exposure to radio frequency fields from hand-held and body-mounted wireless communication devices- Part 1: Device used next to the ear (Frequency range of 300MHz to 6GHz)", July 2016
- IEC 62209-2, "Procedure to measure the Specific Absorption Rate (SAR) For wireless communication devices used in close proximity to the human body (frequency range of 30MHz to 6GHz)", March 2010
- KDB865664, SAR Measurement Requirements for 100 MHz to 6 GHz

Additional Documentation:

- DASY4/5 System Handbook

Methods Applied and Interpretation of Parameters:

- Measurement Conditions:** Further details are available from the Validation Report at the end of the certificate. All figures stated in the certificate are valid at the frequency indicated.
- Antenna Parameters with TSL:** The dipole is mounted with the spacer to position its feed point exactly below the center marking of the flat phantom section, with the arms oriented parallel to the body axis.
- Feed Point Impedance and Return Loss:** These parameters are measured with the dipole positioned under the liquid filled phantom. The impedance stated is transformed from the measurement at the SMA connector to the feed point. The Return Loss ensures low reflected power. No uncertainty required.
- Electrical Delay:** One-way delay between the SMA connector and the antenna feed point. No uncertainty required.
- SAR measured:** SAR measured at the stated antenna input power.
- SAR normalized:** SAR as measured, normalized to an input power of 1 W at the antenna connector.
- SAR for nominal TSL parameters:** The measured TSL parameters are used to calculate the nominal SAR result.

The reported uncertainty of measurement is stated as the standard uncertainty of Measurement multiplied by the coverage factor $k=2$, which for a normal distribution Corresponds to a coverage probability of approximately 95%.



Measurement Conditions

DASY system configuration, as far as not given on page 1.

DASY Version	DASY52	52.10.2.1495
Extrapolation	Advanced Extrapolation	
Phantom	Triple Flat Phantom 5.1C	
Distance Dipole Center - TSL	10 mm	with Spacer
Zoom Scan Resolution	dx, dy, dz = 5 mm	
Frequency	2450 MHz ± 1 MHz	

Head TSL parameters

The following parameters and calculations were applied.

	Temperature	Permittivity	Conductivity
Nominal Head TSL parameters	22.0 °C	39.2	1.80 mho/m
Measured Head TSL parameters	(22.0 ± 0.2) °C	39.6 ± 6 %	1.84 mho/m ± 6 %
Head TSL temperature change during test	<1.0 °C	---	---

SAR result with Head TSL

SAR averaged over 1 cm ³ (1 g) of Head TSL	Condition	
SAR measured	250 mW input power	13.3 W/kg
SAR for nominal Head TSL parameters	normalized to 1W	52.8 W/kg ± 18.8 % (k=2)
SAR averaged over 10 cm ³ (10 g) of Head TSL	Condition	
SAR measured	250 mW input power	6.07 W/kg
SAR for nominal Head TSL parameters	normalized to 1W	24.2 W/kg ± 18.7 % (k=2)

Body TSL parameters

The following parameters and calculations were applied.

	Temperature	Permittivity	Conductivity
Nominal Body TSL parameters	22.0 °C	52.7	1.95 mho/m
Measured Body TSL parameters	(22.0 ± 0.2) °C	53.8 ± 6 %	2.00 mho/m ± 6 %
Body TSL temperature change during test	<1.0 °C	---	---

SAR result with Body TSL

SAR averaged over 1 cm ³ (1 g) of Body TSL	Condition	
SAR measured	250 mW input power	12.8 W/kg
SAR for nominal Body TSL parameters	normalized to 1W	50.8 W/kg ± 18.8 % (k=2)
SAR averaged over 10 cm ³ (10 g) of Body TSL	Condition	
SAR measured	250 mW input power	5.91 W/kg
SAR for nominal Body TSL parameters	normalized to 1W	23.6 W/kg ± 18.7 % (k=2)



Add: No.51 Xueyuan Road, Haidian District, Beijing, 100191, China
Tel: +86-10-62304633-2079 Fax: +86-10-62304633-2504
E-mail: cttl@chinattl.com http://www.chinattl.cn

Appendix (Additional assessments outside the scope of CNAS L0570)

Antenna Parameters with Head TSL

Impedance, transformed to feed point	$57.3\Omega + 5.18 j\Omega$
Return Loss	- 21.6dB

Antenna Parameters with Body TSL

Impedance, transformed to feed point	$52.6\Omega + 5.81 j\Omega$
Return Loss	- 24.1dB

General Antenna Parameters and Design

Electrical Delay (one direction)	1.020 ns
----------------------------------	----------

After long term use with 100W radiated power, only a slight warming of the dipole near the feedpoint can be measured.

The dipole is made of standard semirigid coaxial cable. The center conductor of the feeding line is directly connected to the second arm of the dipole. The antenna is therefore short-circuited for DC-signals. On some of the dipoles, small end caps are added to the dipole arms in order to improve matching when loaded according to the position as explained in the "Measurement Conditions" paragraph. The SAR data are not affected by this change. The overall dipole length is still according to the Standard.

No excessive force must be applied to the dipole arms, because they might bend or the soldered connections near the feedpoint may be damaged.

Additional EUT Data

Manufactured by	SPEAG
-----------------	-------



Add: No.51 Xueyuan Road, Haidian District, Beijing, 100191, China
Tel: +86-10-62304633-2079 Fax: +86-10-62304633-2504
E-mail: cttl@chinattl.com http://www.chinattl.cn

DASY5 Validation Report for Head TSL

Date: 03.25.2019

Test Laboratory: CTTL, Beijing, China

DUT: Dipole 2450 MHz; Type: D2450V2; Serial: D2450V2 - SN: 908

Communication System: UID 0, CW; Frequency: 2450 MHz; Duty Cycle: 1:1

Medium parameters used: $f = 2450$ MHz; $\sigma = 1.841$ S/m; $\epsilon_r = 39.63$; $\rho = 1000$ kg/m³

Phantom section: Right Section

DASY5 Configuration:

- Probe: EX3DV4 - SN3617; ConvF(7.62, 7.62, 7.62) @ 2450 MHz; Calibrated: 1/31/2019
- Sensor-Surface: 1.4mm (Mechanical Surface Detection)
- Electronics: DAE4 Sn1331; Calibrated: 2/6/2019
- Phantom: MFP_V5.1C ; Type: QD 000 P51CA; Serial: 1062
- Measurement SW: DASY52, Version 52.10 (2); SEMCAD X Version 14.6.12 (7450)

Dipole Calibration/Zoom Scan (7x7x7) (7x7x7)/Cube 0: Measurement grid: dx=5mm, dy=5mm, dz=5mm

Reference Value = 96.04 V/m; Power Drift = 0.04 dB

Peak SAR (extrapolated) = 28.3 W/kg

SAR(1 g) = 13.3 W/kg; SAR(10 g) = 6.07 W/kg

Maximum value of SAR (measured) = 22.4 W/kg

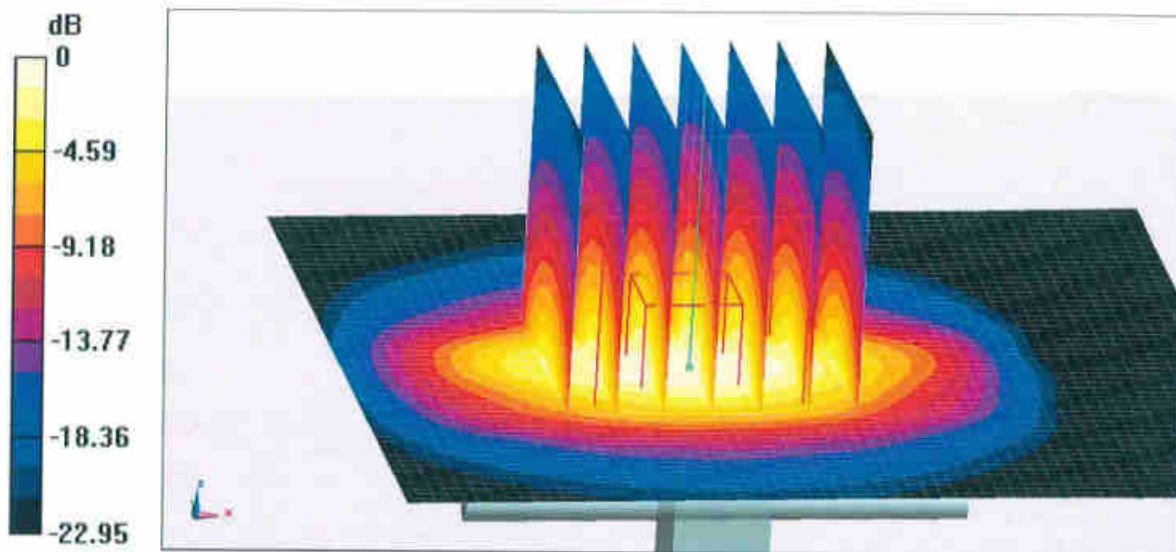

0 dB = 22.4 W/kg = 13.50 dBW/kg



Add: No.51 Xueyuan Road, Haidian District, Beijing, 100191, China
Tel: +86-10-62304633-2079 Fax: +86-10-62304633-2504
E-mail: cttl@chinattl.com http://www.chinattl.cn

Impedance Measurement Plot for Head TSL

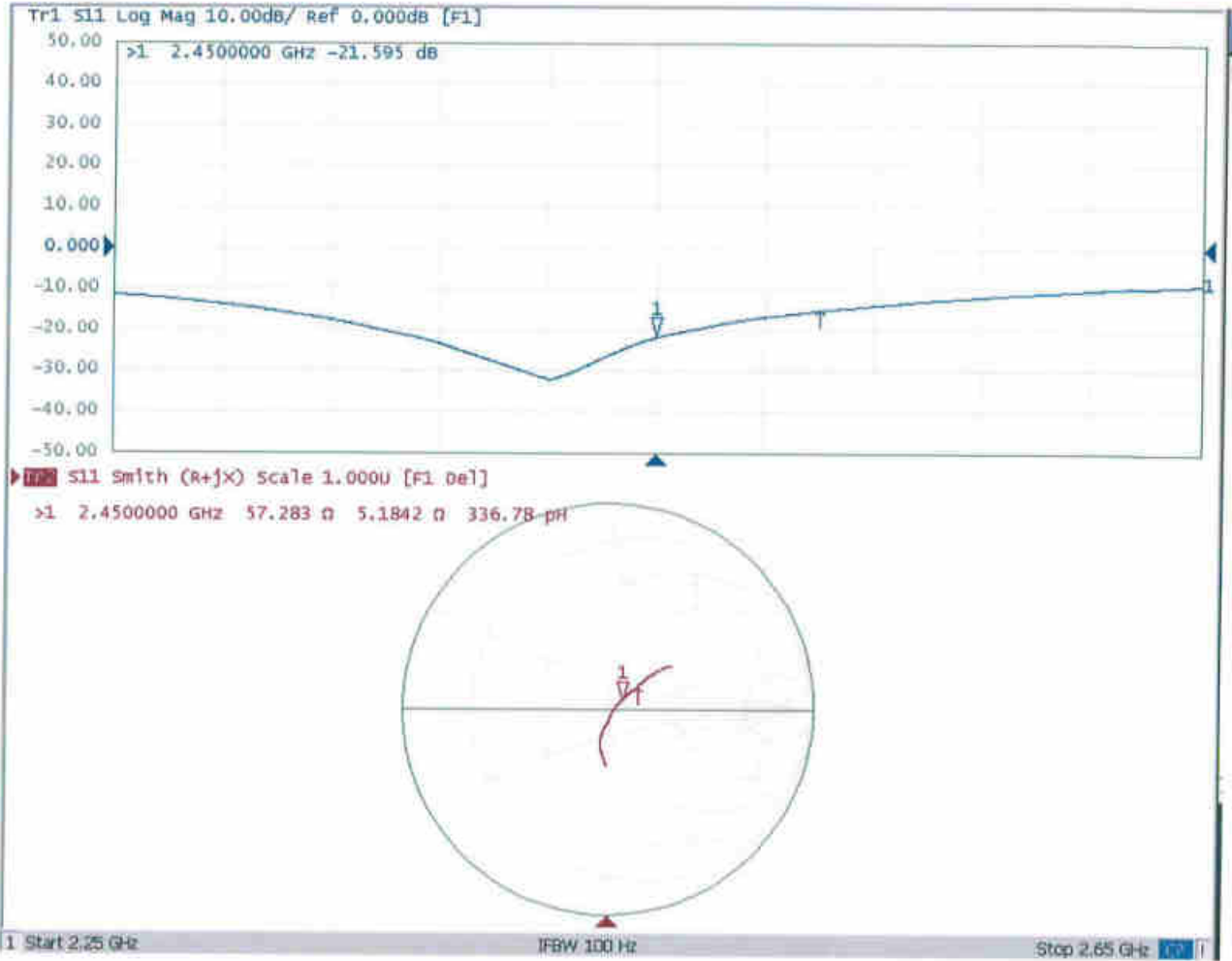



Add: No.51 Xueyuan Road, Haidian District, Beijing, 100191, China
Tel: +86-10-62304633-2079 Fax: +86-10-62304633-2504
E-mail: ettl@chinattl.com http://www.chinattl.cn

DASY5 Validation Report for Body TSL

Date: 03.25.2019

Test Laboratory: CTTL, Beijing, China

DUT: Dipole 2450 MHz; Type: D2450V2; Serial: D2450V2 - SN: 908

Communication System: UID 0, CW; Frequency: 2450 MHz; Duty Cycle: 1:1

Medium parameters used: $f = 2450$ MHz; $\sigma = 2.003$ S/m; $\epsilon_r = 53.78$; $\rho = 1000$ kg/m³

Phantom section: Center Section

DASY5 Configuration:

- Probe: EX3DV4 - SN3617; ConvF(7.79, 7.79, 7.79) @ 2450 MHz; Calibrated: 1/31/2019
- Sensor-Surface: 1.4mm (Mechanical Surface Detection)
- Electronics: DAE4 Sn1331; Calibrated: 2/6/2019
- Phantom: MFP_V5.1C ; Type: QD 000 P51CA; Serial: 1062
- Measurement SW: DASY52, Version 52.10 (2); SEMCAD X Version 14.6.12 (7450)

Dipole Calibration/Zoom Scan (7x7x7) (7x7x7)/Cube 0: Measurement grid: dx=5mm, dy=5mm, dz=5mm

Reference Value = 95.51 V/m; Power Drift = -0.02 dB

Peak SAR (extrapolated) = 27.1 W/kg

SAR(1 g) = 12.8 W/kg; SAR(10 g) = 5.91 W/kg

Maximum value of SAR (measured) = 21.4 W/kg

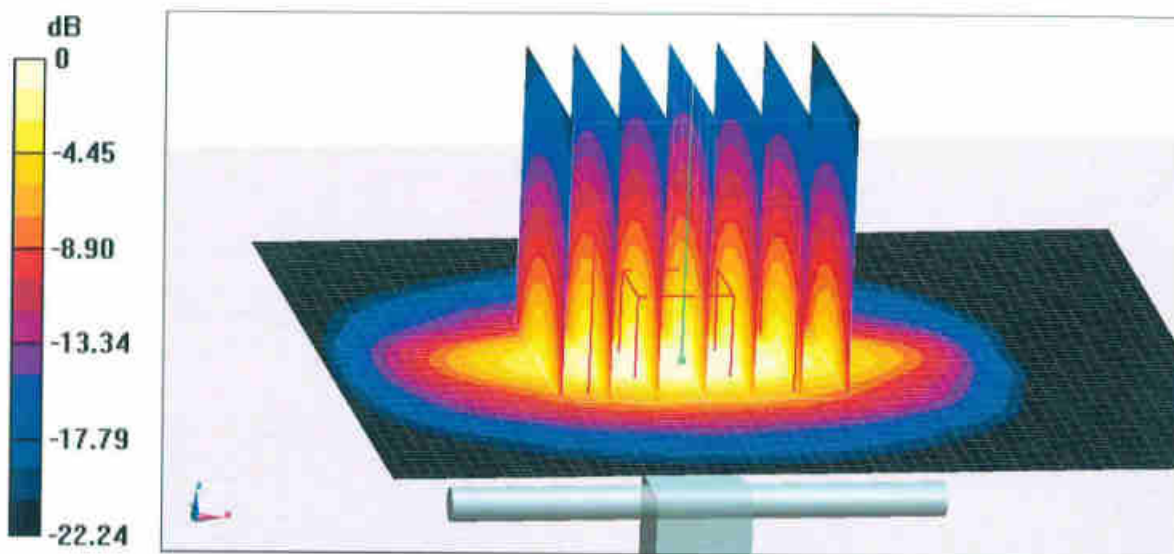

0 dB = 21.4 W/kg = 13.30 dBW/kg



Add: No.51 Xueyuan Road, Haidian District, Beijing, 100191, China
Tel: +86-10-62304633-2079 Fax: +86-10-62304633-2504
E-mail: cttl@chinattl.com http://www.chinattl.cn

Impedance Measurement Plot for Body TSL

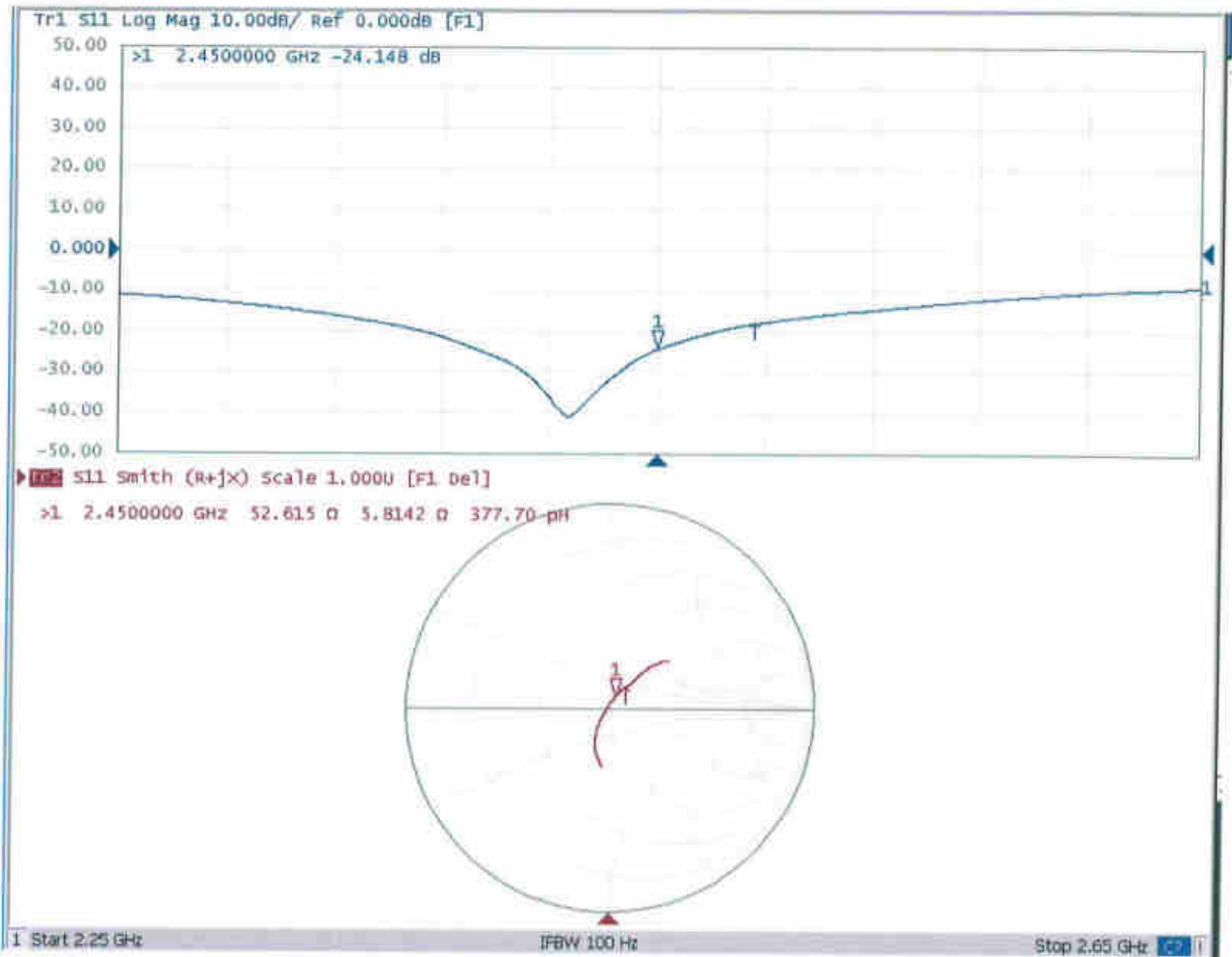



Accredited by the Swiss Accreditation Service (SAS)
The Swiss Accreditation Service is one of the signatories to the EA
Multilateral Agreement for the recognition of calibration certificates

Accreditation No.: **SCS 0108**

Client **Sporton**

Certificate No: **D5GHzV2-1006_Sep18**

CALIBRATION CERTIFICATE

Object **D5GHzV2 - SN:1006**

Calibration procedure(s) **QA CAL-22.v3
Calibration procedure for dipole validation kits between 3-6 GHz**

Calibration date: **September 27, 2018**

This calibration certificate documents the traceability to national standards, which realize the physical units of measurements (SI).
The measurements and the uncertainties with confidence probability are given on the following pages and are part of the certificate.

All calibrations have been conducted in the closed laboratory facility: environment temperature (22 ± 3)°C and humidity < 70%.

Calibration Equipment used (M&TE critical for calibration)

Primary Standards	ID #	Cal Date (Certificate No.)	Scheduled Calibration
Power meter NRP	SN: 104778	04-Apr-18 (No. 217-02672/02673)	Apr-19
Power sensor NRP-Z91	SN: 103244	04-Apr-18 (No. 217-02672)	Apr-19
Power sensor NRP-Z91	SN: 103245	04-Apr-18 (No. 217-02673)	Apr-19
Reference 20 dB Attenuator	SN: 5058 (20k)	04-Apr-18 (No. 217-02682)	Apr-19
Type-N mismatch combination	SN: 5047.2 / 06327	04-Apr-18 (No. 217-02683)	Apr-19
Reference Probe EX3DV4	SN: 3503	30-Dec-17 (No. EX3-3503_Dec17)	Dec-18
DAE4	SN: 601	26-Oct-17 (No. DAE4-601_Oct17)	Oct-18

Secondary Standards	ID #	Check Date (in house)	Scheduled Check
Power meter EPM-442A	SN: GB37480704	07-Oct-15 (in house check Oct-16)	In house check: Oct-18
Power sensor HP 8481A	SN: US37292783	07-Oct-15 (in house check Oct-16)	In house check: Oct-18
Power sensor HP 8481A	SN: MY41092317	07-Oct-15 (in house check Oct-16)	In house check: Oct-18
RF generator R&S SMT-06	SN: 100972	15-Jun-15 (in house check Oct-16)	In house check: Oct-18
Network Analyzer Agilent E8358A	SN: US41080477	31-Mar-14 (in house check Oct-17)	In house check: Oct-18

Calibrated by:	Name Jeton Kastrati	Function Laboratory Technician	Signature
Approved by:	Name Katja Pokovic	Function Technical Manager	Signature

Issued: September 28, 2018

This calibration certificate shall not be reproduced except in full without written approval of the laboratory.



Accredited by the Swiss Accreditation Service (SAS)
The Swiss Accreditation Service is one of the signatories to the EA
Multilateral Agreement for the recognition of calibration certificates

Accreditation No.: **SCS 0108**

Glossary:

TSL	tissue simulating liquid
ConvF	sensitivity in TSL / NORM x,y,z
N/A	not applicable or not measured

Calibration is Performed According to the Following Standards:

- IEEE Std 1528-2013, "IEEE Recommended Practice for Determining the Peak Spatial-Averaged Specific Absorption Rate (SAR) in the Human Head from Wireless Communications Devices: Measurement Techniques", June 2013
- IEC 62209-1, "Measurement procedure for the assessment of Specific Absorption Rate (SAR) from hand-held and body-mounted devices used next to the ear (frequency range of 300 MHz to 6 GHz)", July 2016
- IEC 62209-2, "Procedure to determine the Specific Absorption Rate (SAR) for wireless communication devices used in close proximity to the human body (frequency range of 30 MHz to 6 GHz)", March 2010
- KDB 865664, "SAR Measurement Requirements for 100 MHz to 6 GHz"

Additional Documentation:

- DASY4/5 System Handbook

Methods Applied and Interpretation of Parameters:

- Measurement Conditions:** Further details are available from the Validation Report at the end of the certificate. All figures stated in the certificate are valid at the frequency indicated.
- Antenna Parameters with TSL:** The dipole is mounted with the spacer to position its feed point exactly below the center marking of the flat phantom section, with the arms oriented parallel to the body axis.
- Feed Point Impedance and Return Loss:** These parameters are measured with the dipole positioned under the liquid filled phantom. The impedance stated is transformed from the measurement at the SMA connector to the feed point. The Return Loss ensures low reflected power. No uncertainty required.
- Electrical Delay:** One-way delay between the SMA connector and the antenna feed point. No uncertainty required.
- SAR measured:** SAR measured at the stated antenna input power.
- SAR normalized:** SAR as measured, normalized to an input power of 1 W at the antenna connector.
- SAR for nominal TSL parameters:** The measured TSL parameters are used to calculate the nominal SAR result.

The reported uncertainty of measurement is stated as the standard uncertainty of measurement multiplied by the coverage factor $k=2$, which for a normal distribution corresponds to a coverage probability of approximately 95%.

Measurement Conditions

DASY system configuration, as far as not given on page 1.

DASY Version	DASY5	V52.10.1
Extrapolation	Advanced Extrapolation	
Phantom	Modular Flat Phantom V5.0	
Distance Dipole Center - TSL	10 mm	with Spacer
Zoom Scan Resolution	dx, dy = 4.0 mm, dz = 1.4 mm	Graded Ratio = 1.4 (Z direction)
Frequency	5250 MHz ± 1 MHz 5600 MHz ± 1 MHz 5750 MHz ± 1 MHz	

Head TSL parameters at 5250 MHz

The following parameters and calculations were applied.

	Temperature	Permittivity	Conductivity
Nominal Head TSL parameters	22.0 °C	35.9	4.71 mho/m
Measured Head TSL parameters	(22.0 ± 0.2) °C	36.0 ± 6 %	4.61 mho/m ± 6 %
Head TSL temperature change during test	< 0.5 °C	----	----

SAR result with Head TSL at 5250 MHz

SAR averaged over 1 cm ³ (1 g) of Head TSL	Condition	
SAR measured	100 mW input power	8.07 W/kg
SAR for nominal Head TSL parameters	normalized to 1W	80.7 W/kg ± 19.9 % (k=2)

SAR averaged over 10 cm ³ (10 g) of Head TSL	condition	
SAR measured	100 mW input power	2.32 W/kg
SAR for nominal Head TSL parameters	normalized to 1W	23.2 W/kg ± 19.5 % (k=2)

Head TSL parameters at 5600 MHz

The following parameters and calculations were applied.

	Temperature	Permittivity	Conductivity
Nominal Head TSL parameters	22.0 °C	35.5	5.07 mho/m
Measured Head TSL parameters	(22.0 ± 0.2) °C	35.4 ± 6 %	4.98 mho/m ± 6 %
Head TSL temperature change during test	< 0.5 °C	----	----

SAR result with Head TSL at 5600 MHz

SAR averaged over 1 cm ³ (1 g) of Head TSL	Condition	
SAR measured	100 mW input power	8.34 W/kg
SAR for nominal Head TSL parameters	normalized to 1W	83.3 W / kg ± 19.9 % (k=2)

SAR averaged over 10 cm ³ (10 g) of Head TSL	condition	
SAR measured	100 mW input power	2.38 W/kg
SAR for nominal Head TSL parameters	normalized to 1W	23.8 W/kg ± 19.5 % (k=2)

Head TSL parameters at 5750 MHz

The following parameters and calculations were applied.

	Temperature	Permittivity	Conductivity
Nominal Head TSL parameters	22.0 °C	35.4	5.22 mho/m
Measured Head TSL parameters	(22.0 ± 0.2) °C	35.2 ± 6 %	5.14 mho/m ± 6 %
Head TSL temperature change during test	< 0.5 °C	----	----

SAR result with Head TSL at 5750 MHz

SAR averaged over 1 cm ³ (1 g) of Head TSL	Condition	
SAR measured	100 mW input power	8.05 W/kg
SAR for nominal Head TSL parameters	normalized to 1W	80.4 W/kg ± 19.9 % (k=2)

SAR averaged over 10 cm ³ (10 g) of Head TSL	condition	
SAR measured	100 mW input power	2.29 W/kg
SAR for nominal Head TSL parameters	normalized to 1W	22.9 W/kg ± 19.5 % (k=2)

Body TSL parameters at 5250 MHz

The following parameters and calculations were applied.

	Temperature	Permittivity	Conductivity
Nominal Body TSL parameters	22.0 °C	48.9	5.36 mho/m
Measured Body TSL parameters	(22.0 ± 0.2) °C	46.9 ± 6 %	5.46 mho/m ± 6 %
Body TSL temperature change during test	< 0.5 °C	----	----

SAR result with Body TSL at 5250 MHz

SAR averaged over 1 cm ³ (1 g) of Body TSL	Condition	
SAR measured	100 mW input power	7.89 W/kg
SAR for nominal Body TSL parameters	normalized to 1W	78.3 W/kg ± 19.9 % (k=2)

SAR averaged over 10 cm ³ (10 g) of Body TSL	condition	
SAR measured	100 mW input power	2.19 W/kg
SAR for nominal Body TSL parameters	normalized to 1W	21.7 W/kg ± 19.5 % (k=2)

Body TSL parameters at 5600 MHz

The following parameters and calculations were applied.

	Temperature	Permittivity	Conductivity
Nominal Body TSL parameters	22.0 °C	48.5	5.77 mho/m
Measured Body TSL parameters	(22.0 ± 0.2) °C	46.3 ± 6 %	5.93 mho/m ± 6 %
Body TSL temperature change during test	< 0.5 °C	----	----

SAR result with Body TSL at 5600 MHz

SAR averaged over 1 cm ³ (1 g) of Body TSL	Condition	
SAR measured	100 mW input power	8.17 W/kg
SAR for nominal Body TSL parameters	normalized to 1W	81.0 W/kg ± 19.9 % (k=2)

SAR averaged over 10 cm ³ (10 g) of Body TSL	condition	
SAR measured	100 mW input power	2.28 W/kg
SAR for nominal Body TSL parameters	normalized to 1W	22.5 W/kg ± 19.5 % (k=2)

Body TSL parameters at 5750 MHz

The following parameters and calculations were applied.

	Temperature	Permittivity	Conductivity
Nominal Body TSL parameters	22.0 °C	48.3	5.94 mho/m
Measured Body TSL parameters	(22.0 ± 0.2) °C	46.0 ± 6 %	6.14 mho/m ± 6 %
Body TSL temperature change during test	< 0.5 °C	----	----

SAR result with Body TSL at 5750 MHz

SAR averaged over 1 cm ³ (1 g) of Body TSL	Condition	
SAR measured	100 mW input power	7.81 W/kg
SAR for nominal Body TSL parameters	normalized to 1W	77.4 W/kg ± 19.9 % (k=2)

SAR averaged over 10 cm ³ (10 g) of Body TSL	condition	
SAR measured	100 mW input power	2.15 W/kg
SAR for nominal Body TSL parameters	normalized to 1W	21.3 W/kg ± 19.5 % (k=2)

Appendix (Additional assessments outside the scope of SCS 0108)

Antenna Parameters with Head TSL at 5250 MHz

Impedance, transformed to feed point	54.6 Ω - 7.6 j Ω
Return Loss	- 21.5 dB

Antenna Parameters with Head TSL at 5600 MHz

Impedance, transformed to feed point	57.2 Ω - 6.3 j Ω
Return Loss	- 21.0 dB

Antenna Parameters with Head TSL at 5750 MHz

Impedance, transformed to feed point	60.0 Ω + 4.5 j Ω
Return Loss	- 20.1 dB

Antenna Parameters with Body TSL at 5250 MHz

Impedance, transformed to feed point	54.2 Ω - 5.6 j Ω
Return Loss	- 23.5 dB

Antenna Parameters with Body TSL at 5600 MHz

Impedance, transformed to feed point	58.2 Ω - 5.3 j Ω
Return Loss	- 20.9 dB

Antenna Parameters with Body TSL at 5750 MHz

Impedance, transformed to feed point	59.6 Ω + 5.6 j Ω
Return Loss	- 19.9 dB

General Antenna Parameters and Design

Electrical Delay (one direction)	1.201 ns
----------------------------------	----------

After long term use with 100W radiated power, only a slight warming of the dipole near the feedpoint can be measured.

The dipole is made of standard semirigid coaxial cable. The center conductor of the feeding line is directly connected to the second arm of the dipole. The antenna is therefore short-circuited for DC-signals. On some of the dipoles, small end caps are added to the dipole arms in order to improve matching when loaded according to the position as explained in the "Measurement Conditions" paragraph. The SAR data are not affected by this change. The overall dipole length is still according to the Standard.

No excessive force must be applied to the dipole arms, because they might bend or the soldered connections near the feedpoint may be damaged.

Additional EUT Data

Manufactured by	SPEAG
Manufactured on	August 28, 2003

DASY5 Validation Report for Head TSL

Date: 27.09.2018

Test Laboratory: SPEAG, Zurich, Switzerland

DUT: Dipole D5GHzV2; Type: D5GHzV2; Serial: D5GHzV2 - SN:1006

Communication System: UID 0 - CW; Frequency: 5250 MHz, Frequency: 5600 MHz, Frequency: 5750 MHz
Medium parameters used: $f = 5250$ MHz; $\sigma = 4.61$ S/m; $\epsilon_r = 36$; $\rho = 1000$ kg/m³,
Medium parameters used: $f = 5600$ MHz; $\sigma = 4.98$ S/m; $\epsilon_r = 35.4$; $\rho = 1000$ kg/m³,
Medium parameters used: $f = 5750$ MHz; $\sigma = 5.14$ S/m; $\epsilon_r = 35.2$; $\rho = 1000$ kg/m³
Phantom section: Flat Section
Measurement Standard: DASY5 (IEEE/IEC/ANSI C63.19-2011)

DASY52 Configuration:

- Probe: EX3DV4 - SN3503; ConvF(5.51, 5.51, 5.51) @ 5250 MHz, ConvF(5.05, 5.05, 5.05) @ 5600 MHz, ConvF(4.98, 4.98, 4.98) @ 5750 MHz; Calibrated: 30.12.2017
- Sensor-Surface: 1.4mm (Mechanical Surface Detection)
- Electronics: DAE4 Sn601; Calibrated: 26.10.2017
- Phantom: Flat Phantom 5.0 (front); Type: QD 000 P50 AA; Serial: 1001
- DASY52 52.10.1(1476); SEMCAD X 14.6.11(7439)

Dipole Calibration for Head Tissue/Pin=100mW, dist=10mm, f=5250 MHz/Zoom Scan, dist=1.4mm (8x8x7)/Cube 0: Measurement grid: dx=4mm, dy=4mm, dz=1.4mm
Reference Value = 79.28 V/m; Power Drift = -0.04 dB
Peak SAR (extrapolated) = 26.7 W/kg
SAR(1 g) = 8.07 W/kg; SAR(10 g) = 2.32 W/kg
Maximum value of SAR (measured) = 18.1 W/kg

Dipole Calibration for Head Tissue/Pin=100mW, dist=10mm, f=5600 MHz/Zoom Scan, dist=1.4mm (8x8x7)/Cube 0: Measurement grid: dx=4mm, dy=4mm, dz=1.4mm
Reference Value = 76.15 V/m; Power Drift = -0.05 dB
Peak SAR (extrapolated) = 30.2 W/kg
SAR(1 g) = 8.34 W/kg; SAR(10 g) = 2.38 W/kg
Maximum value of SAR (measured) = 19.3 W/kg

Dipole Calibration for Head Tissue/Pin=100mW, dist=10mm, f=5750 MHz/Zoom Scan, dist=1.4mm (8x8x7)/Cube 0: Measurement grid: dx=4mm, dy=4mm, dz=1.4mm
Reference Value = 74.61 V/m; Power Drift = -0.03 dB
Peak SAR (extrapolated) = 29.8 W/kg
SAR(1 g) = 8.05 W/kg; SAR(10 g) = 2.29 W/kg
Maximum value of SAR (measured) = 18.9 W/kg

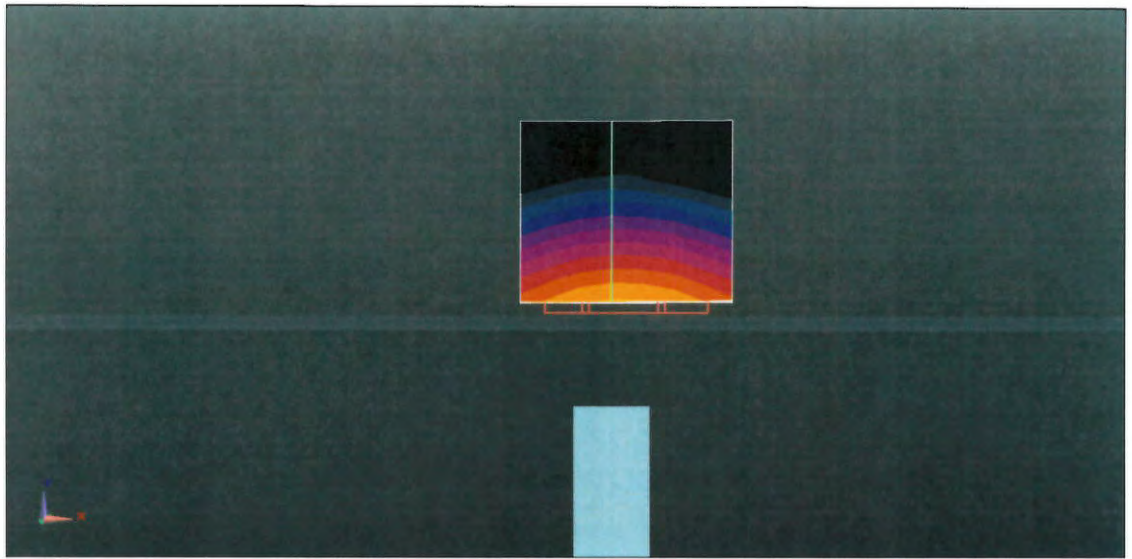
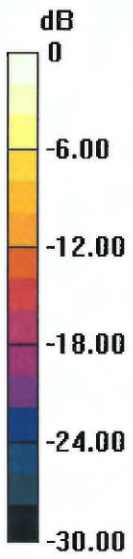

0 dB = 18.1 W/kg = 12.58 dBW/kg

Impedance Measurement Plot for Head TSL

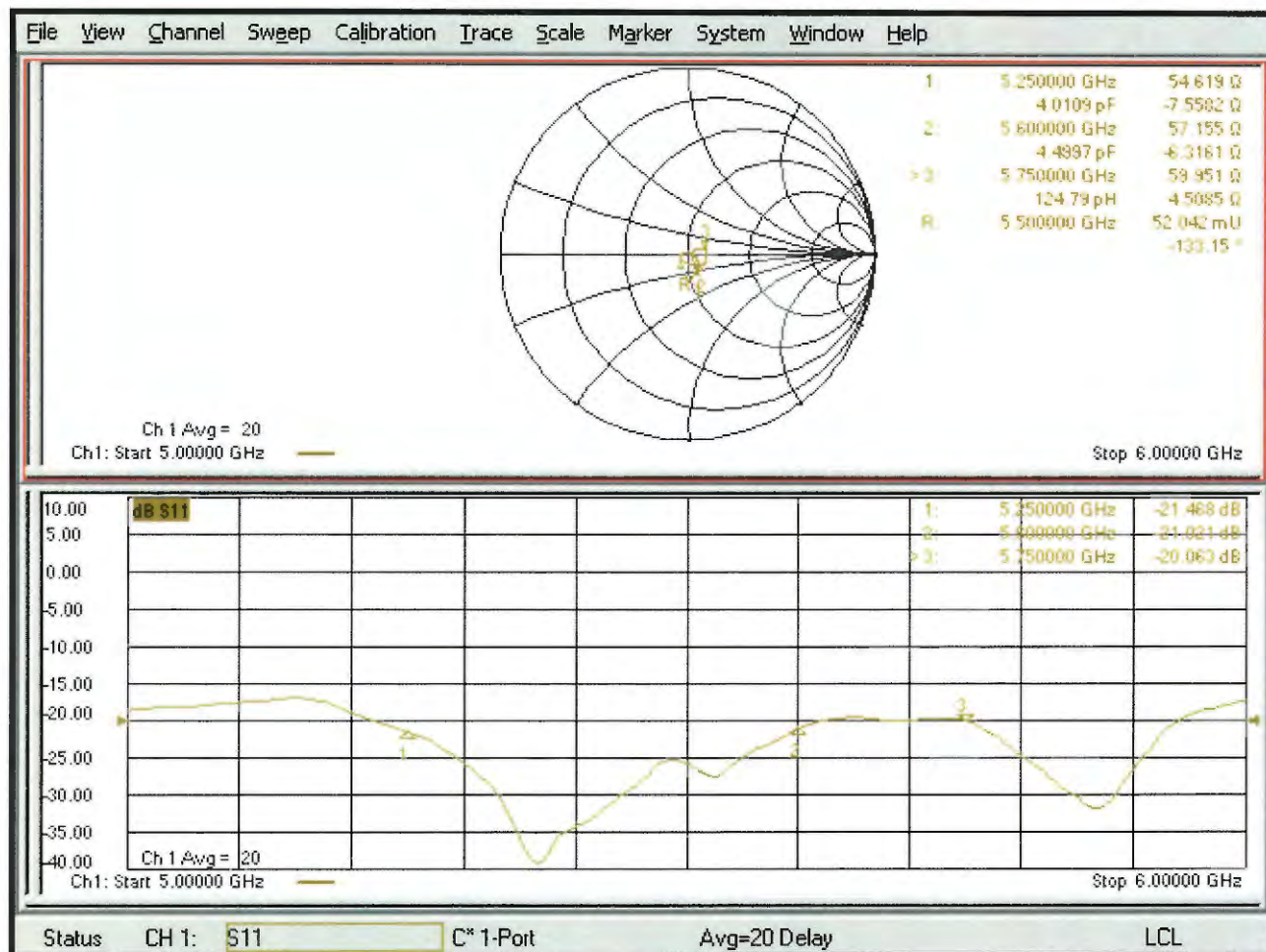

DASY5 Validation Report for Body TSL

Date: 25.09.2018

Test Laboratory: SPEAG, Zurich, Switzerland

DUT: Dipole D5GHzV2; Type: D5GHzV2; Serial: D5GHzV2 - SN:1006

Communication System: UID 0 - CW; Frequency: 5250 MHz, Frequency: 5600 MHz, Frequency: 5750 MHz

Medium parameters used: $f = 5250$ MHz; $\sigma = 5.46$ S/m; $\epsilon_r = 46.9$; $\rho = 1000$ kg/m³,

Medium parameters used: $f = 5600$ MHz; $\sigma = 5.93$ S/m; $\epsilon_r = 46.3$; $\rho = 1000$ kg/m³,

Medium parameters used: $f = 5750$ MHz; $\sigma = 6.14$ S/m; $\epsilon_r = 46$; $\rho = 1000$ kg/m³

Phantom section: Flat Section

Measurement Standard: DASY5 (IEEE/IEC/ANSI C63.19-2011)

DASY52 Configuration:

- Probe: EX3DV4 - SN3503; ConvF(5.26, 5.26, 5.26) @ 5250 MHz, ConvF(4.65, 4.65, 4.65) @ 5600 MHz, ConvF(4.57, 4.57, 4.57) @ 5750 MHz; Calibrated: 30.12.2017
- Sensor-Surface: 1.4mm (Mechanical Surface Detection)
- Electronics: DAE4 Sn601; Calibrated: 26.10.2017
- Phantom: Flat Phantom 5.0 (back); Type: QD 000 P50 AA; Serial: 1002
- DASY52 52.10.1(1476); SEMCAD X 14.6.11(7439)

Dipole Calibration for Body Tissue/Pin=100mW, dist=10mm, f=5250 MHz/Zoom Scan, dist=1.4mm (8x8x7)/Cube 0: Measurement grid: dx=4mm, dy=4mm, dz=1.4mm

Reference Value = 69.77 V/m; Power Drift = -0.08 dB

Peak SAR (extrapolated) = 30.6 W/kg

SAR(1 g) = 7.89 W/kg; SAR(10 g) = 2.19 W/kg

Maximum value of SAR (measured) = 18.6 W/kg

Dipole Calibration for Body Tissue/Pin=100mW, dist=10mm, f=5600 MHz/Zoom Scan, dist=1.4mm (8x8x7)/Cube 0: Measurement grid: dx=4mm, dy=4mm, dz=1.4mm

Reference Value = 69.30 V/m; Power Drift = -0.06 dB

Peak SAR (extrapolated) = 34.2 W/kg

SAR(1 g) = 8.17 W/kg; SAR(10 g) = 2.28 W/kg

Maximum value of SAR (measured) = 19.8 W/kg

Dipole Calibration for Body Tissue/Pin=100mW, dist=10mm, f=5750 MHz/Zoom Scan, dist=1.4mm (8x8x7)/Cube 0: Measurement grid: dx=4mm, dy=4mm, dz=1.4mm

Reference Value = 67.65 V/m; Power Drift = -0.07 dB

Peak SAR (extrapolated) = 34.0 W/kg

SAR(1 g) = 7.81 W/kg; SAR(10 g) = 2.15 W/kg

Maximum value of SAR (measured) = 19.3 W/kg

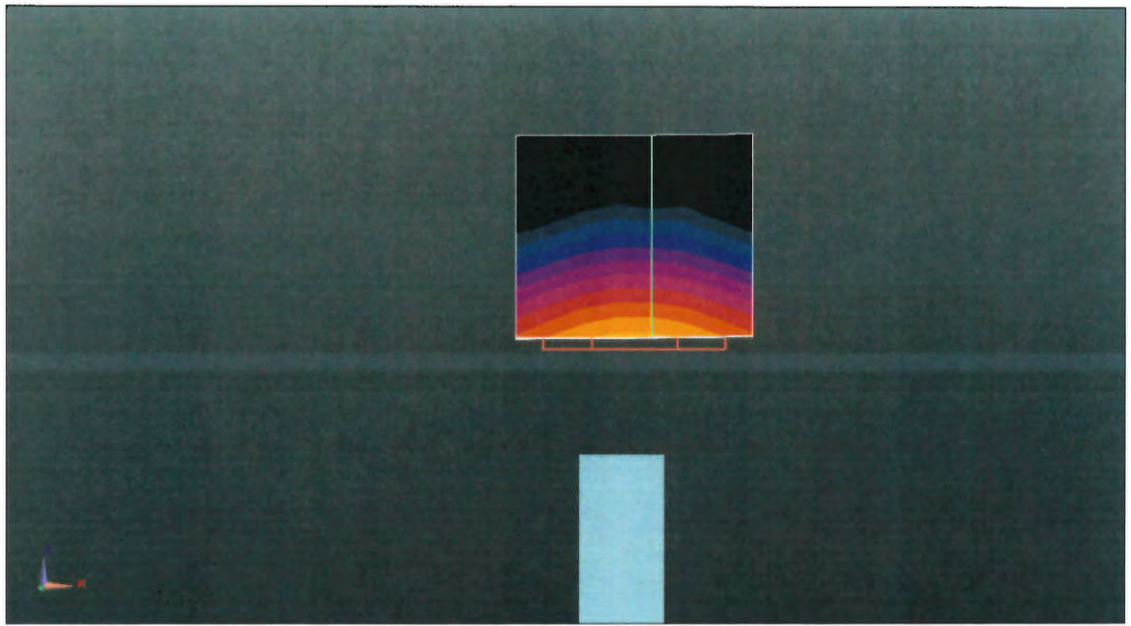
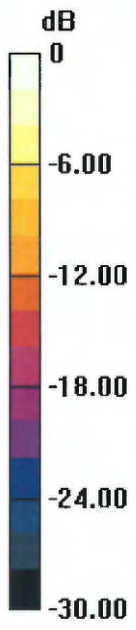

0 dB = 18.6 W/kg = 12.70 dBW/kg

Impedance Measurement Plot for Body TSL

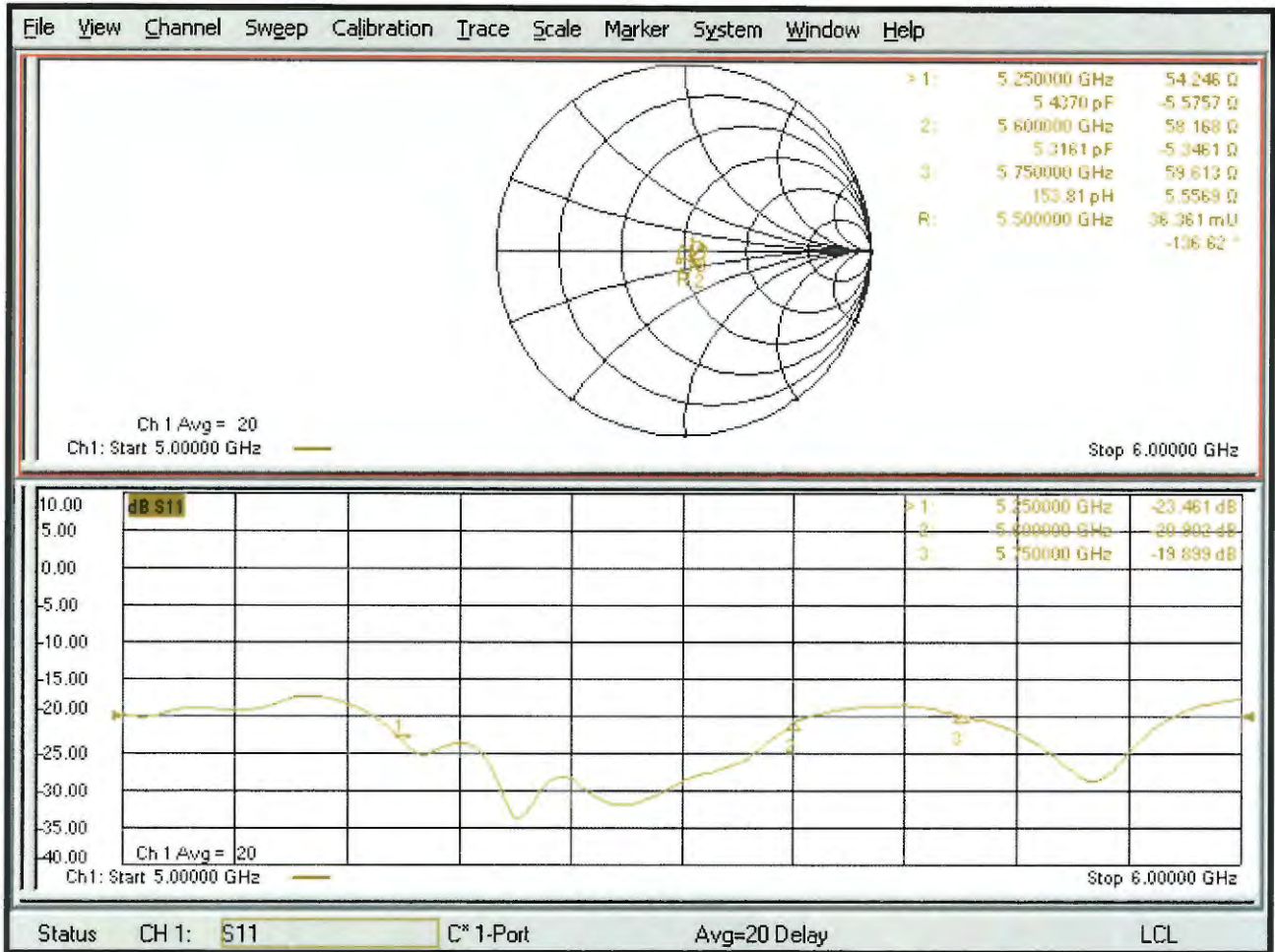



In Collaboration with
s p e a g
CALIBRATION LABORATORY



中国认可
国际互认
校准
CALIBRATION
CNAS L0570

Add: No.51 Xueyuan Road, Haidian District, Beijing, 100191, China
Tel: +86-10-62304633-2512 Fax: +86-10-62304633-2504
E-mail: cttl@chinattl.com [Http://www.chinattl.cn](http://www.chinattl.cn)

Client : **Sporton**

Certificate No: **Z18-60487**

CALIBRATION CERTIFICATE

Object: DAE4 - SN: 1338

Calibration Procedure(s): FF-Z11-002-01
Calibration Procedure for the Data Acquisition Electronics (DAEx)

Calibration date: December 03, 2018

This calibration Certificate documents the traceability to national standards, which realize the physical units of measurements(SI). The measurements and the uncertainties with confidence probability are given on the following pages and are part of the certificate.

All calibrations have been conducted in the closed laboratory facility: environment temperature(22±3)°C and humidity<70%.

Calibration Equipment used (M&TE critical for calibration)

Primary Standards	ID #	Cal Date(Calibrated by, Certificate No.)	Scheduled Calibration
Process Calibrator 753	1971018	20-Jun-18 (CTTL, No.J18X05034)	June-19

	Name	Function	Signature
Calibrated by:	Yu Zongying	SAR Test Engineer	
Reviewed by:	Lin Hao	SAR Test Engineer	
Approved by:	Qi Dianyuan	SAR Project Leader	

Issued: December 05, 2018

This calibration certificate shall not be reproduced except in full without written approval of the laboratory.



In Collaboration with

s p e a g
CALIBRATION LABORATORY

Add: No.51 Xueyuan Road, Haidian District, Beijing, 100191, China

Tel: +86-10-62304633-2512

Fax: +86-10-62304633-2504

E-mail: cttl@chinattl.com

Http://www.chinattl.cn

Glossary:

DAE data acquisition electronics
Connector angle information used in DASY system to align probe sensor X to the robot coordinate system.

Methods Applied and Interpretation of Parameters:

- *DC Voltage Measurement:* Calibration Factor assessed for use in DASY system by comparison with a calibrated instrument traceable to national standards. The figure given corresponds to the full scale range of the voltmeter in the respective range.
- *Connector angle:* The angle of the connector is assessed measuring the angle mechanically by a tool inserted. Uncertainty is not required.
- The report provide only calibration results for DAE, it does not contain other performance test results.



Add: No.51 Xueyuan Road, Haidian District, Beijing, 100191, China
Tel: +86-10-62304633-2512 Fax: +86-10-62304633-2504
E-mail: cttl@chinattl.com Http://www.chinattl.cn

DC Voltage Measurement

A/D - Converter Resolution nominal

High Range: 1LSB = 6.1 μ V, full range = -100...+300 mV

Low Range: 1LSB = 61nV, full range = -1.....+3mV

DASY measurement parameters: Auto Zero Time: 3 sec; Measuring time: 3 sec

Calibration Factors	X	Y	Z
High Range	403.662 \pm 0.15% (k=2)	404.235 \pm 0.15% (k=2)	404.194 \pm 0.15% (k=2)
Low Range	3.97131 \pm 0.7% (k=2)	3.97736 \pm 0.7% (k=2)	3.97366 \pm 0.7% (k=2)

Connector Angle

Connector Angle to be used in DASY system	63.5 $^{\circ}$ \pm 1 $^{\circ}$
---	------------------------------------



Accredited by the Swiss Accreditation Service (SAS)

Accreditation No.: **SCS 0108**

The Swiss Accreditation Service is one of the signatories to the EA
Multilateral Agreement for the recognition of calibration certificates

Client **Sporton**

Certificate No: **EX3-3857_May19**

CALIBRATION CERTIFICATE

Object **EX3DV4 - SN:3857**

Calibration procedure(s) **QA CAL-01.v9, QA CAL-14.v5, QA CAL-23.v5, QA CAL-25.v7
Calibration procedure for dosimetric E-field probes**

Calibration date: **May 27, 2019**

This calibration certificate documents the traceability to national standards, which realize the physical units of measurements (SI).
The measurements and the uncertainties with confidence probability are given on the following pages and are part of the certificate.

All calibrations have been conducted in the closed laboratory facility: environment temperature (22 ± 3)°C and humidity < 70%.

Calibration Equipment used (M&TE critical for calibration)

Primary Standards	ID	Cal Date (Certificate No.)	Scheduled Calibration
Power meter NRP	SN: 104778	03-Apr-19 (No. 217-02892/02893)	Apr-20
Power sensor NRP-Z91	SN: 103244	03-Apr-19 (No. 217-02892)	Apr-20
Power sensor NRP-Z91	SN: 103245	03-Apr-19 (No. 217-02893)	Apr-20
Reference 20 dB Attenuator	SN: S5277 (20x)	04-Apr-19 (No. 217-02894)	Apr-20
DAE4	SN: 660	19-Dec-18 (No. DAE4-660_Dec18)	Dec-19
Reference Probe ES3DV2	SN: 3013	31-Dec-18 (No. ES3-3013_Dec18)	Dec-19
Secondary Standards	ID	Check Date (in house)	Scheduled Check
Power meter E4419B	SN: GB41293874	06-Apr-16 (in house check Jun-18)	In house check: Jun-20
Power sensor E4412A	SN: MY41498087	06-Apr-16 (in house check Jun-18)	In house check: Jun-20
Power sensor E4412A	SN: 000110210	06-Apr-16 (in house check Jun-18)	In house check: Jun-20
RF generator HP 8648C	SN: US3642U01700	04-Aug-99 (in house check Jun-18)	In house check: Jun-20
Network Analyzer E8358A	SN: US41080477	31-Mar-14 (in house check Oct-18)	In house check: Oct-19

Calibrated by:	Name Jeton Kastrati	Function Laboratory Technician	Signature
Approved by:	Name Katja Pokovic	Function Technical Manager	Signature
			Issued: May 28, 2019
This calibration certificate shall not be reproduced except in full without written approval of the laboratory.			



Accredited by the Swiss Accreditation Service (SAS)

Accreditation No.: **SCS 0108**

The Swiss Accreditation Service is one of the signatories to the EA
Multilateral Agreement for the recognition of calibration certificates

Glossary:

TSL	tissue simulating liquid
NORM _{x,y,z}	sensitivity in free space
ConvF	sensitivity in TSL / NORM _{x,y,z}
DCP	diode compression point
CF	crest factor (1/duty_cycle) of the RF signal
A, B, C, D	modulation dependent linearization parameters
Polarization φ	φ rotation around probe axis
Polarization ϑ	ϑ rotation around an axis that is in the plane normal to probe axis (at measurement center), i.e., $\vartheta = 0$ is normal to probe axis
Connector Angle	information used in DASY system to align probe sensor X to the robot coordinate system

Calibration is Performed According to the Following Standards:

- IEEE Std 1528-2013, "IEEE Recommended Practice for Determining the Peak Spatial-Averaged Specific Absorption Rate (SAR) in the Human Head from Wireless Communications Devices: Measurement Techniques", June 2013
- IEC 62209-1, "Measurement procedure for the assessment of Specific Absorption Rate (SAR) from hand-held and body-mounted devices used next to the ear (frequency range of 300 MHz to 6 GHz)", July 2016
- IEC 62209-2, "Procedure to determine the Specific Absorption Rate (SAR) for wireless communication devices used in close proximity to the human body (frequency range of 30 MHz to 6 GHz)", March 2010
- KDB 865664, "SAR Measurement Requirements for 100 MHz to 6 GHz"

Methods Applied and Interpretation of Parameters:

- NORM_{x,y,z}**: Assessed for E-field polarization $\vartheta = 0$ ($f \leq 900$ MHz in TEM-cell; $f > 1800$ MHz: R22 waveguide). NORM_{x,y,z} are only intermediate values, i.e., the uncertainties of NORM_{x,y,z} does not affect the E²-field uncertainty inside TSL (see below ConvF).
- NORM(f)_{x,y,z}** = NORM_{x,y,z} * frequency_response (see Frequency Response Chart). This linearization is implemented in DASY4 software versions later than 4.2. The uncertainty of the frequency response is included in the stated uncertainty of ConvF.
- DCP_{x,y,z}**: DCP are numerical linearization parameters assessed based on the data of power sweep with CW signal (no uncertainty required). DCP does not depend on frequency nor media.
- PAR**: PAR is the Peak to Average Ratio that is not calibrated but determined based on the signal characteristics
- A_{x,y,z}; B_{x,y,z}; C_{x,y,z}; D_{x,y,z}; VR_{x,y,z}**: A, B, C, D are numerical linearization parameters assessed based on the data of power sweep for specific modulation signal. The parameters do not depend on frequency nor media. VR is the maximum calibration range expressed in RMS voltage across the diode.
- ConvF and Boundary Effect Parameters**: Assessed in flat phantom using E-field (or Temperature Transfer Standard for $f \leq 800$ MHz) and inside waveguide using analytical field distributions based on power measurements for $f > 800$ MHz. The same setups are used for assessment of the parameters applied for boundary compensation (alpha, depth) of which typical uncertainty values are given. These parameters are used in DASY4 software to improve probe accuracy close to the boundary. The sensitivity in TSL corresponds to NORM_{x,y,z} * ConvF whereby the uncertainty corresponds to that given for ConvF. A frequency dependent ConvF is used in DASY version 4.4 and higher which allows extending the validity from ± 50 MHz to ± 100 MHz.
- Spherical isotropy (3D deviation from isotropy)**: in a field of low gradients realized using a flat phantom exposed by a patch antenna.
- Sensor Offset**: The sensor offset corresponds to the offset of virtual measurement center from the probe tip (on probe axis). No tolerance required.
- Connector Angle**: The angle is assessed using the information gained by determining the NORM_x (no uncertainty required).

DASY/EASY - Parameters of Probe: EX3DV4 - SN:3857

Basic Calibration Parameters

	Sensor X	Sensor Y	Sensor Z	Unc (k=2)
Norm ($\mu\text{V}/(\text{V}/\text{m})^2$) ^A	0.17	0.43	0.45	$\pm 10.1 \%$
DCP (mV) ^B	102.0	100.4	103.0	

Calibration Results for Modulation Response

UID	Communication System Name		A dB	B dB $\sqrt{\mu\text{V}}$	C	D dB	VR mV	Max dev.	Max Unc ^E (k=2)
0	CW	X	0.00	0.00	1.00	0.00	149.1	$\pm 3.5 \%$	$\pm 4.7 \%$
		Y	0.00	0.00	1.00		142.5		
		Z	0.00	0.00	1.00		128.7		
10352-AAA	Pulse Waveform (200Hz, 10%)	X	5.02	71.79	14.46	10.00	60.0	$\pm 3.0 \%$	$\pm 9.6 \%$
		Y	15.00	85.65	19.05		60.0		
		Z	15.00	87.33	19.76		60.0		
10353-AAA	Pulse Waveform (200Hz, 20%)	X	4.86	73.94	13.94	6.99	80.0	$\pm 1.7 \%$	$\pm 9.6 \%$
		Y	15.00	86.82	18.12		80.0		
		Z	15.00	88.67	19.12		80.0		
10354-AAA	Pulse Waveform (200Hz, 40%)	X	7.38	78.94	13.73	3.98	95.0	$\pm 1.4 \%$	$\pm 9.6 \%$
		Y	15.00	86.36	16.11		95.0		
		Z	15.00	93.83	20.13		95.0		
10355-AAA	Pulse Waveform (200Hz, 60%)	X	0.64	63.16	6.75	2.22	120.0	$\pm 1.5 \%$	$\pm 9.6 \%$
		Y	13.05	81.68	12.64		120.0		
		Z	15.00	101.47	22.26		120.0		
10387-AAA	QPSK Waveform, 1 MHz	X	1.68	72.66	15.43	0.00	150.0	$\pm 2.7 \%$	$\pm 9.6 \%$
		Y	0.57	60.00	7.58		150.0		
		Z	0.99	66.12	11.92		150.0		
10388-AAA	QPSK Waveform, 10 MHz	X	3.08	73.93	18.74	0.00	150.0	$\pm 1.2 \%$	$\pm 9.6 \%$
		Y	2.07	67.07	15.14		150.0		
		Z	2.60	71.16	17.43		150.0		
10396-AAA	64-QAM Waveform, 100 kHz	X	3.51	72.69	19.87	3.01	150.0	$\pm 1.6 \%$	$\pm 9.6 \%$
		Y	2.69	68.94	18.38		150.0		
		Z	3.62	74.43	20.55		150.0		
10399-AAA	64-QAM Waveform, 40 MHz	X	3.84	69.00	17.04	0.00	150.0	$\pm 2.3 \%$	$\pm 9.6 \%$
		Y	3.40	66.62	15.52		150.0		
		Z	3.68	68.33	16.53		150.0		
10414-AAA	WLAN CCDF, 64-QAM, 40MHz	X	5.12	66.37	16.23	0.00	150.0	$\pm 4.3 \%$	$\pm 9.6 \%$
		Y	4.79	65.33	15.44		150.0		
		Z	4.99	66.28	15.97		150.0		

Note: For details on UID parameters see Appendix

The reported uncertainty of measurement is stated as the standard uncertainty of measurement multiplied by the coverage factor $k=2$, which for a normal distribution corresponds to a coverage probability of approximately 95%.

^A The uncertainties of Norm X,Y,Z do not affect the E^2 -field uncertainty inside TSL (see Page 5).

^B Numerical linearization parameter: uncertainty not required.

^E Uncertainty is determined using the max. deviation from linear response applying rectangular distribution and is expressed for the square of the field value.