



Test Report No.: RFA20210104W001-6



FCC TEST REPORT (PART 27)



Applicant:	Lenovo (Shanghai) Electronics Technology Co., Ltd.
Address:	Section 304-305, Building No. 4, # 222, Meiyue Road, China (Shanghai) Pilot Free Trade Zone

Manufacturer or Supplier:	Lenovo PC HK Limited
Address:	23/F, Lincoln House, Taikoo Place 979 King's Road, Quarry Bay, Hong Kong, P.R.China
Product:	Portable Tablet Computer
Brand Name:	Lenovo
Model Name:	Lenovo TB-7306X
FCC ID:	O57TB7306X
Date of tests:	Jan. 05, 2021 ~ Jan. 19, 2021

The tests have been carried out according to the requirements of the following standard:

- FCC Part 27, Subpart C, L ANSI/TIA/EIA-603- D
- FCC Part 2 ANSI/TIA/EIA-603-E ANSI C63.26-2015

CONCLUSION: The submitted sample was found to COMPLY with the test requirement

Prepared by Simon Wang Engineer / Mobile Department	Approved by Luke Lu Manager / Mobile Department
 Date: Jan. 20, 2021	 Date: Jan. 20, 2021

This report is governed by, and incorporates by reference, CPS Conditions of Service as posted at the date of issuance of this report at <http://www.bureauveritas.com/home/about-us/our-business/cps/about-us/terms-conditions> and is intended for your exclusive use. Any copying or replication of this report to or for any other person or entity, or use of our name or trademark, is permitted only with our prior written permission. This report sets forth our findings solely with respect to the test samples identified herein. The results set forth in this report are not indicative or representative of the quality or characteristics of the lot from which a test sample was taken or any similar or identical product unless specifically and expressly noted. Our report includes all of the tests requested by you and the results thereof based upon the information that you provided to us. Measurement uncertainty is only provided upon request for accredited tests. You have 60 days from date of issuance of this report to notify us of any material error or omission caused by our negligence or if you require measurement uncertainty; provided, however, that such notice shall be in writing and shall specifically address the issue you wish to raise. A failure to raise such issue within the prescribed time shall constitute your unqualified acceptance of the completeness of this report, the tests conducted and the correctness of the report contents.



TABLE OF CONTENTS

RELEASE CONTROL RECORD	4
1 SUMMARY OF TEST RESULTS	5
1.1 MEASUREMENT UNCERTAINTY	5
1.2 TEST SITE AND INSTRUMENTS	6
2 GENERAL INFORMATION.....	7
2.1 GENERAL DESCRIPTION OF EUT	7
2.2 CONFIGURATION OF SYSTEM UNDER TEST	9
2.3 DESCRIPTION OF SUPPORT UNITS	10
2.4 DESCRIPTION OF TEST MODES.....	10
2.5 GENERAL DESCRIPTION OF APPLIED STANDARDS	14
3 TEST TYPES AND RESULTS	15
3.1 OUTPUT POWER MEASUREMENT	15
3.1.1 LIMITS OF OUTPUT POWER MEASUREMENT	15
3.1.2 TEST PROCEDURES	15
3.1.3 TEST SETUP	16
3.1.4 TEST RESULTS	16
3.2 FREQUENCY STABILITY MEASUREMENT	28
3.2.1 LIMITS OF FREQUENCY STABILITY MEASUREMENT	28
3.2.2 TEST PROCEDURE	28
3.2.3 TEST SETUP	28
3.2.4 TEST RESULTS	29
3.3 OCCUPIED BANDWIDTH MEASUREMENT	35
3.3.1 LIMITS OF OCCUPIED BANDWIDTH MEASUREMENT	35
3.3.2 TEST SETUP	35
3.3.3 TEST PROCEDURES	35
3.3.4 TEST RESULTS	36
3.4 PEAK TO AVERAGE RATIO	42
3.4.1 LIMITS OF PEAK TO AVERAGE RATIO MEASUREMENT	42
3.4.2 TEST SETUP	42
3.4.3 TEST PROCEDURES	42
3.4.4 TEST RESULTS	43
3.5 BAND EDGE MEASUREMENT	49
3.5.1 LIMITS OF BAND EDGE MEASUREMENT	49
3.5.2 TEST SETUP	49
3.5.3 TEST PROCEDURES	50
3.5.4 TEST RESULTS	51
3.6 CONDUCTED SPURIOUS EMISSIONS.....	69
3.6.1 LIMITS OF CONDUCTED SPURIOUS EMISSIONS MEASUREMENT	69
3.6.2 TEST PROCEDURE	69
3.6.3 TEST SETUP	69
3.6.4 TEST RESULTS	70
3.7 RADIATED EMISSION MEASUREMENT	76
3.7.1 LIMITS OF RADIATED EMISSION MEASUREMENT	76
3.7.2 TEST PROCEDURES	76
3.7.3 DEVIATION FROM TEST STANDARD	76
3.7.4 TEST SETUP	77
3.7.5 TEST RESULTS	78



**BUREAU
VERITAS**

Test Report No.: RFA20210104W001-6

4	INFORMATION ON THE TESTING LABORATORIES	96
5	APPENDIX A – MODIFICATIONS RECORDERS FOR ENGINEERING CHANGES TO THE EUT BY THE LAB	97



Test Report No.: RFA20210104W001-6

RELEASE CONTROL RECORD

ISSUE NO.	REASON FOR CHANGE	DATE ISSUED
RFA20210104W001-6	Original release	Jan. 20, 2021

1 SUMMARY OF TEST RESULTS

The EUT has been tested according to the following specifications:

APPLIED STANDARD: FCC Part 27 & Part 2		
STANDARD SECTION	TEST TYPE AND LIMIT	RESULT
2.1046 27.50(d)(4)	Maximum Peak Output Power	Compliance
2.1055 27.54	Frequency Stability	Compliance
2.1049 27.53(h)	Occupied Bandwidth	Compliance
27.50(d)(5)	Peak to average ratio	Compliance
27.53(h)	Band Edge Measurements	Compliance
2.1051 27.53(h)	Conducted Spurious Emissions	Compliance
2.1053 27.53(h)	Radiated Spurious Emissions	Compliance

* Refer to KDB 971168 D01 Power Meas License Digital Systems v03r01.

1.1 MEASUREMENT UNCERTAINTY

Where relevant, the following measurement uncertainty levels have been estimated for tests performed on the EUT as specified in CISPR 16-4-2:

MEASUREMENT	UNCERTAINTY
Frequency Stability	$\pm 76.97\text{Hz}$
Radiated emissions & Radiated Power (30MHz~1GMHz)	$\pm 4.98\text{dB}$
Radiated emissions & Radiated Power (1GMHz ~6GMHz)	$\pm 4.70\text{dB}$
Radiated emissions (6GMHz ~18GMHz)	$\pm 4.60\text{dB}$
Radiated emissions (18GMHz ~40GMHz)	$\pm 4.12\text{dB}$
Conducted emissions	$\pm 4.01\text{dB}$
Occupied Channel Bandwidth	$\pm 43.58\text{KHz}$
Conducted Output power	$\pm 2.06\text{dB}$
Band Edge Measurements	$\pm 4.70\text{dB}$
Peak to average ratio	$\pm 0.76\text{dB}$

This uncertainty represents an expanded uncertainty expressed at approximately the 95% confidence level using a coverage factor of k=2.



1.2 TEST SITE AND INSTRUMENTS

Equipment	Manufacturer	Model No.	Serial No.	Last Cal.	Next Cal.
MXE EMI Receiver	KEYSIGHT	N9038A-544	MY54450026	Apr. 27,20	Apr. 26,21
EXA Signal Analyzer	KEYSIGHT	N9010A-526	MY54510322	Feb. 26,20	Feb. 25,21
Bilog Antenna	ETS-LINDGREN	3143B	00161965	Mar. 27,20	Mar. 26,21
Horn Antenna (1GHz-18GHz)	ETS-LINDGREN	3117	00168692	Mar. 27,20	Mar. 26,21
Horn Antenna (18GHz-40GHz)	N/A	QWH-SL-18-40-K-SG/QMS-00361	15433	Nov. 24, 20	Nov. 23, 21
Radio Communication Analyzer	ANRITSU	MT8820C	6201465426	Feb. 27,20	Feb. 26,21
Signal Pre-Amplifier	EMSI	EMC 9135	980249	Jun. 02,20	Jun. 01,21
Signal Pre-Amplifier	EMSI	EMC 012645B	980257	Jun. 02,20	Jun. 01,21
Signal Pre-Amplifier	EMSI	EMC 184045B	980259	Apr. 30,20	Apr. 29,21
3m Semi-anechoic Chamber	ETS-LINDGREN	9m*6m*6m	Euroshieldpn-CT0001143-1216	May. 19,20	May. 18,23
Test Software	E3	V 9.160323	N/A	N/A	N/A
Test Software	ADT	ADT_Radiated V7.6.15.9.2	N/A	N/A	N/A
10dB Attenuator	JFW/USA	50HF-010-SMA	1505	Jun. 03,20	Jun. 02,21
Power Meter	Anritsu	ML2495A	1506002	Feb. 26,20	Feb. 25,21
Power Sensor	Anritsu	MA2411B	1339352	Feb. 26,20	Feb. 25,21
Humid & Temp Programmable Tester	Juyi	ITH-120-45-CP-AR	IAA1504-001	Jun. 02,20	Jun. 01,21
MXG Analog Microwave Signal Generator	KEYSIGHT	N5183A	MY50143024	Mar. 11,20	Mar. 10,21
Power Divider	MCLI/USA	PS2-15	24880	N/A	N/A

- NOTE:**
1. The calibration interval of the above test instruments is 12 months or 36 months and the calibrations are traceable to CEPREI/CHINA, GRGT/CHINA and NIM/CHINA.
 2. The test was performed in 3m Semi-anechoic Chamber and RF Oven Room.
 3. The horn antenna is used only for the measurement of emission frequency above 1GHz if tested.
 4. The FCC Site Registration No. is 525120; The Designation No. is CN1171.

2 GENERAL INFORMATION

2.1 GENERAL DESCRIPTION OF EUT

PRODUCT	Portable Tablet Computer	
BRAND NAME	Lenovo	
MODEL NAME	Lenovo TB-7306X	
POWER SUPPLY	5.0Vdc (adapter or host equipment) 3.86Vdc (Li-ion, battery)	
MODULATION TECHNOLOGY	LTE	QPSK, 16QAM, 64QAM
FREQUENCY RANGE	LTE Band 4 Channel Bandwidth: 1.4MHz	1710.7MHz ~ 1754.3MHz
	LTE Band 4 Channel Bandwidth: 3MHz	1711.5MHz ~ 1753.5MHz
	LTE Band 4 Channel Bandwidth: 5MHz	1712.5MHz ~ 1752.5MHz
	LTE Band 4 Channel Bandwidth: 10MHz	1715.0MHz ~ 1750.0MHz
	LTE Band 4 Channel Bandwidth: 15MHz	1717.5MHz ~ 1747.5MHz
	LTE Band 4 Channel Bandwidth: 20MHz	1720.0MHz ~ 1745.0MHz
EMISSION DESIGNATOR	LTE Band 4 Channel Bandwidth: 1.4MHz	QPSK: 1M09G7D
		16QAM: 1M09W7D
		64QAM: 1M09W7D
	LTE Band 4 Channel Bandwidth: 3MHz	QPSK: 2M68G7D
		16QAM: 2M67W7D
		64QAM: 2M68W7D
	LTE Band 4 Channel Bandwidth: 5MHz	QPSK: 4M48G7D
		16QAM: 4M47W7D
		64QAM: 4M47W7D
	LTE Band 4 Channel Bandwidth: 10MHz	QPSK: 8M95G7D
		16QAM: 8M94W7D
		64QAM: 8M95W7D
	LTE Band 4 Channel Bandwidth: 15MHz	QPSK: 13M4G7D
		16QAM: 13M4W7D
		64QAM: 13M4W7D
	LTE Band 4 Channel Bandwidth: 20MHz	QPSK: 17M9G7D
		16QAM: 17M9W7D
		64QAM: 17M9W7D

MAX. ERP/EIRP POWER	LTE Band 4 Channel Bandwidth: 1.4MHz	126mW
	LTE Band 4 Channel Bandwidth: 3MHz	126mW
	LTE Band 4 Channel Bandwidth: 5MHz	126mW
	LTE Band 4 Channel Bandwidth: 10MHz	126mW
	LTE Band 4 Channel Bandwidth: 15MHz	125mW
	LTE Band 4 Channel Bandwidth: 20MHz	127mW
ANTENNA TYPE	PIFA Antenna with -1.5dBi gain for /LTE B4	
HW VERSION	Lenovo Tablet TB-7306X	
SW VERSION	TB-7306X_RF01_201218	
I/O PORTS	Refer to user's manual	
CABLE SUPPLIED	USB cable: shielded, detachable, 1meter	

NOTE:

1. For a more detailed features description, please refer to the manufacturer's specifications or the user's manual.
2. For the test results, the EUT had been tested with all conditions. But only the worst case was shown in test report.

List of Accessory:

ACCESSORIES	BRAND	MODEL	SPECIFICATION
Battery 1	Sunwoda	L20D1P32	Capacity : 3.86vdc 3750mAh
Battery 2	NAT	L20D1P32	Capacity : 3.86vdc 3750mAh
AC Adapter 1	Acbel	SC-41	I/P:100-240Vac, 0.3A O/P: 5Vdc, 2A
AC Adapter 2	Salom	SC-41	I/P:100-240Vac, 0.3A O/P: 5Vdc, 2A
USB Cable 1	liqi	L62B-052000100	Shielded, 1.0meter
USB Cable 2	saibao	S62B-052000100	Shielded, 1.0meter

2.2 CONFIGURATION OF SYSTEM UNDER TEST

FOR RADIATION EMISSION TEST

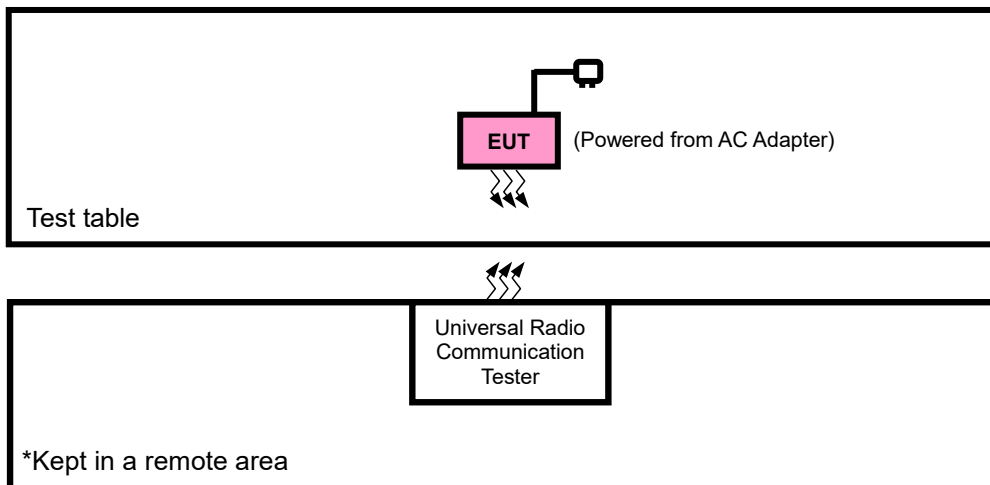



2.3 DESCRIPTION OF SUPPORT UNITS

The EUT has been tested as an independent unit together with other necessary accessories or support units. The following support units or accessories were used to form a representative test configuration during the tests.

NO.	PRODUCT	BRAND	MODEL NO.	SERIAL NO.	FCC ID
1	DC source	LONG WEI	PS-6403D	010934269	N/A

NO.	SIGNAL CABLE DESCRIPTION OF THE ABOVE SUPPORT UNITS
1	DC Line: Unshielded, Detachable 1.8m

NOTE:

1. All power cords of the above support units are non shielded.

2.4 DESCRIPTION OF TEST MODES

Pre-Scan has been conducted to determine the worst-case mode from all possible combinations between available modulations, data rates, XYZ axis and antenna ports. The worst case in ERP/EIRP and radiated emission was found when positioned on X-plane for LTE. Following channel(s) was (were) selected for the final test as listed below:

EUT CONFIGURE MODE	DESCRIPTION
A	EUT + Adapter + USB Cable with LTE link
B	EUT + Battery with LTE link



**BUREAU
VERITAS**

Test Report No.: RFA20210104W001-6

LTE BAND 4

EUT CONFIGURE MODE	TEST ITEM	AVAILABLE CHANNEL	TESTED CHANNEL	CHANNEL BANDWIDTH	MODULATION	MODE	
B	EIRP	19957 to 20393	19957, 20175, 20393	1.4MHz	QPSK, 16QAM, 64QAM	1 RB / 0 RB Offset	
		19965 to 20385	19965, 20175, 20385	3MHz	QPSK, 16QAM, 64QAM	1 RB / 0 RB Offset	
		19975 to 20375	19975, 20175, 20375	5MHz	QPSK, 16QAM, 64QAM	1 RB / 0 RB Offset	
		20000 to 20350	20000, 20175, 20350	10MHz	QPSK, 16QAM, 64QAM	1 RB / 0 RB Offset	
		20025 to 20325	20025, 20175, 20325	15MHz	QPSK, 16QAM, 64QAM	1 RB / 0 RB Offset	
		20050 to 20300	20050, 20175, 20300	20MHz	QPSK, 16QAM, 64QAM	1 RB / 0 RB Offset	
B	FREQUENCY STABILITY	19957 to 20393	19957, 20393	1.4MHz	QPSK	1 RB / 0 RB Offset	
		19965 to 20385	19965, 20385	3MHz	QPSK	1 RB / 0 RB Offset	
		19975 to 20375	19975, 20375	5MHz	QPSK	1 RB / 0 RB Offset	
		20000 to 20350	20000, 20350	10MHz	QPSK	1 RB / 0 RB Offset	
		20025 to 20325	20025, 20325	15MHz	QPSK	1 RB / 0 RB Offset	
		20050 to 20300	20050, 20300	20MHz	QPSK	1 RB / 0 RB Offset	
B	OCCUPIED BANDWIDTH	19957 to 20393	19957, 20175, 20393	1.4MHz	QPSK, 16QAM, 64QAM	6 RB / 0 RB Offset	
		19965 to 20385	19965, 20175, 20385	3MHz	QPSK, 16QAM, 64QAM	15 RB / 0 RB Offset	
		19975 to 20375	19975, 20175, 20375	5MHz	QPSK, 16QAM, 64QAM	25 RB / 0 RB Offset	
		20000 to 20350	20000, 20175, 20350	10MHz	QPSK, 16QAM, 64QAM	50 RB / 0 RB Offset	
		20025 to 20325	20025, 20175, 20325	15MHz	QPSK, 16QAM, 64QAM	75 RB / 0 RB Offset	
		20050 to 20300	20050, 20175, 20300	20MHz	QPSK, 16QAM, 64QAM	100 RB / 0 RB Offset	
B	PEAK TO AVERAGE RATIO	19957 to 20393	19957, 20175, 20393	1.4MHz	QPSK, 16QAM, 64QAM	1 RB / 0 RB Offset	
		19965 to 20385	19965, 20175, 20385	3MHz	QPSK, 16QAM, 64QAM	1 RB / 0 RB Offset	
		19975 to 20375	19975, 20175, 20375	5MHz	QPSK, 16QAM, 64QAM	1 RB / 0 RB Offset	
		20000 to 20350	20000, 20175, 20350	10MHz	QPSK, 16QAM, 64QAM	1 RB / 0 RB Offset	
		20025 to 20325	20025, 20175, 20325	15MHz	QPSK, 16QAM, 64QAM	1 RB / 0 RB Offset	
		20050 to 20300	20050, 20175, 20300	20MHz	QPSK, 16QAM, 64QAM	1 RB / 0 RB Offset	
B	BAND EDGE	19957 to 20393	19957	1.4MHz	QPSK, 16QAM, 64QAM	1 RB / 0 RB Offset	
			20393	1.4MHz	QPSK, 16QAM, 64QAM	6 RB / 0 RB Offset	
		19965 to 20385	19965	3MHz	QPSK, 16QAM, 64QAM	1 RB / 0 RB Offset	
			20385	3MHz	QPSK, 16QAM, 64QAM	15 RB / 0 RB Offset	
		19975 to 20375	19975	5MHz	QPSK, 16QAM, 64QAM	1 RB / 0 RB Offset	
			20375	5MHz	QPSK, 16QAM, 64QAM	25 RB / 0 RB Offset	
		20000 to 20350	20000	10MHz	QPSK, 16QAM, 64QAM	1 RB / 0 RB Offset	
			20350	10MHz	QPSK, 16QAM, 64QAM	50 RB / 0 RB Offset	
							1 RB / 14 RB Offset
							15 RB / 0 RB Offset
							1 RB / 24 RB Offset
							25 RB / 0 RB Offset
					1 RB / 49 RB Offset		
					50 RB / 0 RB Offset		

B	BAND EDGE	20025 to 20325	20025	15MHz	QPSK, 16QAM, 64QAM	1 RB / 0 RB Offset		
			20325	15MHz	QPSK, 16QAM, 64QAM	75 RB / 0 RB Offset		
		20050 to 20300	20050	20MHz	QPSK, 16QAM, 64QAM	1 RB / 74 RB Offset		
			20300	20MHz	QPSK, 16QAM, 64QAM	75 RB / 0 RB Offset		
		B	CONDCUDETED EMISSION	19957 to 20393	19957, 20175, 20393	1.4MHz	QPSK	1 RB / 0 RB Offset
				19965 to 20385	19965, 20175, 20385	3MHz	QPSK	1 RB / 0 RB Offset
19975 to 20375	19975, 20175, 20375			5MHz	QPSK	1 RB / 0 RB Offset		
20000 to 20350	20000, 20175, 20350			10MHz	QPSK	1 RB / 0 RB Offset		
20025 to 20325	20025, 20175, 20325			15MHz	QPSK	1 RB / 0 RB Offset		
20050 to 20300	20050, 20175, 20300			20MHz	QPSK	100 RB / 0 RB Offset		
A	RADIATED EMISSION	19957 to 20393	19957, 20175, 20393	1.4MHz	QPSK	1 RB / 0 RB Offset		
		19965 to 20385	20175	3MHz	QPSK	1 RB / 0 RB Offset		
		19975 to 20375	20175	5MHz	QPSK	1 RB / 0 RB Offset		
		20000 to 20350	20175	10MHz	QPSK	1 RB / 0 RB Offset		
		20025 to 20325	20175	15MHz	QPSK	1 RB / 0 RB Offset		
		20050 to 20300	20175	20MHz	QPSK	100 RB / 0 RB Offset		

Note: This device was tested under all bandwidths, RB configurations and modulations. The worst case was found in QPSK modulation.



Test Report No.: RFA20210104W001-6

TEST CONDITION:

TEST ITEM	ENVIRONMENTAL CONDITIONS	INPUT POWER	TESTED BY
ERP	23deg. C, 70%RH	DC 5V By Adapter	Jace Hu
FREQUENCY STABILITY	23deg. C, 70%RH	DC 3.6V/3.86V/4.4V	Chase Zhou
OCCUPIED BANDWIDTH	23deg. C, 70%RH	DC 3.86V By Battery	Chase Zhou
BAND EDGE	23deg. C, 70%RH	DC 3.86V By Battery	Chase Zhou
CONDCUDED EMISSION	23deg. C, 70%RH	DC 3.86V By Battery	Chase Zhou
RADIATED EMISSION	23deg. C, 70%RH	DC 5V By Adapter	Jace Hu
PEAK TO AVERAGE RATIO	23deg. C, 70%RH	DC 3.86V By Battery	Chase Zhou



Test Report No.: RFA20210104W001-6

2.5 GENERAL DESCRIPTION OF APPLIED STANDARDS

The EUT is a RF product. According to the specifications of the manufacturer, it must comply with the requirements of the following standards:

FCC 47 CFR Part 2

FCC 47 CFR Part 27

KDB 971168 D01 Power Meas License Digital Systems v03r01

ANSI/TIA/EIA-603-D

ANSI/TIA/EIA-603-E

ANSI C63.26-2015

NOTE: All test items have been performed and recorded as per the above standards.



3 TEST TYPES AND RESULTS

3.1 OUTPUT POWER MEASUREMENT

3.1.1 LIMITS OF OUTPUT POWER MEASUREMENT

27.50(b)(10) Portable stations (hand-held devices) transmitting in the 746-757 MHz, 776-788 MHz, and 805-806 MHz bands are limited to 3 watts ERP.

27.50(c)(10) Portable stations (hand-held devices) in the 600 MHz uplink band and the 698-746 MHz band, and fixed and mobile stations in the 600 MHz uplink band are limited to 3 watts ERP.

27.50(d)(4) Fixed, mobile, and portable (hand-held) stations operating in the 1710–1755 MHz band are limited to 1 watt EIRP.

3.1.2 TEST PROCEDURES

EIRP / ERP MEASUREMENT:

Per KDB 971168 D01 Power Meas License Digital Systems v03r01 or subclause 5.2.5.5 of ANSI C63.26-2015, the relevant equation for determining the ERP or EIRP from the conducted RF output power measured using the guidance provided above is:

$$\text{ERP or EIRP} = P_{\text{Meas}} + G_{\text{T}} - L_{\text{C}}$$

Where:

ERP or EIRP = effective radiated power or equivalent isotropically radiated power, respectively
(expressed in the same units as P_{Meas} , typically dBW or dBm);

P_{Meas} = measured transmitter output power or PSD, in dBm or dBW;

G_{T} = gain of the transmitting antenna, in dBd (ERP) or dBi (EIRP);

L_{C} = signal attenuation in the connecting cable between the transmitter and antenna, in dB.

CONDUCTED POWER MEASUREMENT:

- The EUT was set up for the maximum power with LTE link data modulation and link up with simulator.
- Set the EUT to transmit under low, middle and high channel and record the power level shown on simulator.

3.1.3 TEST SETUP

EIRP MEASUREMENT:

CONDUCTED POWER MEASUREMENT:

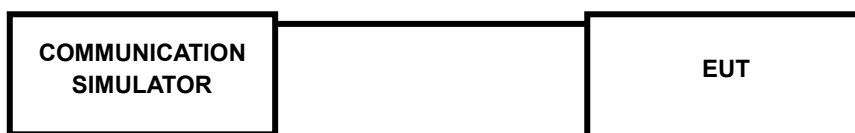

3.1.4 TEST RESULTS

AVERAGE CONDUCTED OUTPUT POWER (dBm)

LTE Band 4

Band/BW	Modulation	RB Size	RB Offset	Low CH 19957	Mid CH 20175	High CH 20393	MPR
				Frequency 1710.7 MHz	Frequency 1732.5 MHz	Frequency 1754.3 MHz	
4/ 1.4	QPSK	1	0	21.79	22.03	22.07	0
		1	2	22.25	22.42	22.51	0
		1	5	21.88	22.03	22.10	0
		3	0	22.14	22.32	22.43	0
		3	1	22.28	22.47	22.46	0
		3	3	22.23	22.40	22.47	0
		6	0	21.75	21.90	21.99	1
	16QAM	1	0	21.48	21.66	21.73	1
		1	2	21.80	21.94	22.05	1
		1	5	21.42	21.59	21.71	1
		3	0	21.68	21.87	21.92	1
		3	1	21.61	21.88	21.89	1
		3	3	21.77	21.96	22.05	1
		6	0	21.21	21.45	21.47	2
	64QAM	1	0	19.96	20.18	20.26	2
		1	2	20.15	20.41	20.43	2
		1	5	19.90	20.04	20.15	2
		3	0	19.60	19.82	19.85	2
		3	1	19.56	19.80	19.81	2
		3	3	19.62	19.79	19.91	2
		6	0	19.11	19.30	19.35	3



Test Report No.: RFA20210104W001-6

Band/BW	Modulation	RB Size	RB Offset	Low CH 19965	Mid CH 20175	High CH 20385	MPR
				Frequency 1711.5 MHz	Frequency 1732.5 MHz	Frequency 1753.5 MHz	
4/3	QPSK	1	0	21.81	22.05	22.06	0
		1	7	22.21	22.43	22.51	0
		1	14	21.84	22.03	22.10	0
		8	0	21.63	21.85	21.93	1
		8	3	21.71	21.97	21.98	1
		8	7	21.70	21.97	22.01	1
		15	0	21.72	21.91	21.93	1
	16QAM	1	0	21.45	21.72	21.76	1
		1	7	21.77	21.97	22.03	1
		1	14	21.45	21.59	21.71	1
		8	0	21.14	21.38	21.42	2
		8	3	21.16	21.33	21.42	2
		8	7	21.29	21.44	21.51	2
		15	0	21.21	21.39	21.50	2
	64QAM	1	0	20.02	20.21	20.20	2
		1	7	20.18	20.35	20.42	2
		1	14	19.91	20.06	20.15	2
		8	0	19.13	19.36	19.36	3
		8	3	19.10	19.24	19.36	3
		8	7	19.09	19.33	19.37	3
		15	0	19.13	19.27	19.39	3



Test Report No.: RFA20210104W001-6

Band/BW	Modulation	RB Size	RB Offset	Low CH 19975	Mid CH 20175	High CH 20375	MPR
				Frequency 1712.5 MHz	Frequency 1732.5 MHz	Frequency 1752.5 MHz	
4/ 5	QPSK	1	0	21.82	22.00	22.07	0
		1	12	22.26	22.40	22.51	0
		1	24	21.85	22.02	22.14	0
		12	0	21.66	21.85	21.90	1
		12	6	21.71	21.98	21.99	1
		12	13	21.74	21.93	22.02	1
		25	0	21.70	21.94	21.96	1
	16QAM	1	0	21.46	21.68	21.76	1
		1	12	21.74	22.00	22.02	1
		1	24	21.45	21.59	21.70	1
		12	0	21.14	21.36	21.39	2
		12	6	21.13	21.37	21.38	2
		12	13	21.24	21.46	21.54	2
		25	0	21.21	21.40	21.47	2
	64QAM	1	0	19.96	20.18	20.26	2
		1	12	20.15	20.41	20.42	2
		1	24	19.84	20.11	20.15	2
		12	0	19.14	19.33	19.35	3
		12	6	19.04	19.31	19.35	3
		12	13	19.13	19.32	19.34	3
		25	0	19.09	19.33	19.37	3



Test Report No.: RFA20210104W001-6

Band/BW	Modulation	RB Size	RB Offset	Low CH 20000	Mid CH 20175	High CH 20350	MPR
				Frequency 1715 MHz	Frequency 1732.5 MHz	Frequency 1750 MHz	
4/ 10	QPSK	1	0	21.79	22.03	22.07	0
		1	24	22.26	22.40	22.52	0
		1	49	21.82	22.06	22.10	0
		25	0	21.67	21.84	21.93	1
		25	12	21.77	21.92	21.99	1
		25	25	21.72	21.90	22.01	1
		50	0	21.75	21.94	21.93	1
	16QAM	1	0	21.46	21.65	21.72	1
		1	24	21.79	21.96	22.05	1
		1	49	21.45	21.60	21.67	1
		25	0	21.16	21.34	21.45	2
		25	12	21.17	21.31	21.43	2
		25	25	21.23	21.47	21.51	2
		50	0	21.25	21.39	21.51	2
	64QAM	1	0	19.95	20.19	20.23	2
		1	24	20.20	20.37	20.46	2
		1	49	19.90	20.05	20.12	2
		25	0	19.12	19.30	19.41	3
		25	12	19.11	19.30	19.29	3
		25	25	19.12	19.29	19.36	3
		50	0	19.14	19.29	19.38	3



Test Report No.: RFA20210104W001-6

Band/BW	Modulation	RB Size	RB Offset	Low CH 20025	Mid CH 20175	High CH 20325	MPR
				Frequency 1717.5 MHz	Frequency 1732.5 MHz	Frequency 1747.5 MHz	
4/ 15	QPSK	1	0	21.86	22.03	22.04	0
		1	37	22.24	22.45	22.47	0
		1	74	21.88	22.09	22.11	0
		36	0	21.64	21.85	21.94	1
		36	19	21.78	21.97	21.99	1
		36	39	21.70	21.91	22.01	1
		75	0	21.75	21.92	21.98	1
	16QAM	1	0	21.50	21.72	21.72	1
		1	37	21.78	21.97	22.05	1
		1	74	21.41	21.65	21.69	1
		36	0	21.20	21.34	21.46	2
		36	19	21.11	21.35	21.39	2
		36	39	21.28	21.45	21.54	2
		75	0	21.26	21.42	21.44	2
	64QAM	1	0	19.97	20.20	20.24	2
		1	37	20.21	20.36	20.43	2
		1	74	19.86	20.04	20.15	2
		36	0	19.17	19.36	19.35	3
		36	19	19.05	19.24	19.31	3
		36	39	19.15	19.36	19.38	3
		75	0	19.13	19.27	19.39	3



Test Report No.: RFA20210104W001-6

Band/BW	Modulation	RB Size	RB Offset	Low CH 20050	Mid CH 20175	High CH 20300	MPR
				Frequency 1720 MHz	Frequency 1732.5 MHz	Frequency 1745 MHz	
4/ 20	QPSK	1	0	21.87	22.07	22.12	0
		1	50	22.28	22.48	22.53	0
		1	99	21.90	22.10	22.15	0
		50	0	21.70	21.90	21.95	1
		50	25	21.79	21.99	22.04	1
		50	50	21.78	21.98	22.03	1
		100	0	21.76	21.96	22.01	1
	16QAM	1	0	21.53	21.73	21.78	1
		1	50	21.82	22.02	22.07	1
		1	99	21.47	21.67	21.72	1
		50	0	21.22	21.42	21.47	2
		50	25	21.19	21.39	21.44	2
		50	50	21.31	21.51	21.56	2
		100	0	21.27	21.47	21.52	2
	64QAM	1	0	20.03	20.23	20.28	2
		1	50	20.23	20.43	20.48	2
		1	99	19.92	20.12	20.17	2
		50	0	19.18	19.38	19.43	3
		50	25	19.12	19.32	19.37	3
		50	50	19.17	19.37	19.42	3
		100	0	19.15	19.35	19.40	3



BUREAU
VERITAS

Test Report No.: RFA20210104W001-6

EIRP

LTE BAND 4

CHANNEL BANDWIDTH: 1.4MHz QPSK

Channel	Frequency (MHz)	Conducted Power (dBm)	G _T -L _c (dB)	EIRP (dBm)	EIRP (mW)	Limit (W)
19957	1710.7	22.25	-1.50	20.75	118.85	1
20175	1732.5	22.42	-1.50	20.92	123.59	1
20393	1754.3	22.51	-1.50	21.01	126.18	1

CHANNEL BANDWIDTH: 1.4MHz 16QAM

Channel	Frequency (MHz)	Conducted Power (dBm)	G _T -L _c (dB)	EIRP (dBm)	EIRP (mW)	Limit (W)
19957	1710.7	21.80	-1.50	20.30	107.15	1
20175	1732.5	21.94	-1.50	20.44	110.66	1
20393	1754.3	22.05	-1.50	20.55	113.50	1

CHANNEL BANDWIDTH: 1.4MHz 64QAM

Channel	Frequency (MHz)	Conducted Power (dBm)	G _T -L _c (dB)	EIRP (dBm)	EIRP (mW)	Limit (W)
19957	1710.7	20.15	-1.50	18.65	73.28	1
20175	1732.5	20.41	-1.50	18.91	77.80	1
20393	1754.3	20.43	-1.50	18.93	78.16	1



Test Report No.: RFA20210104W001-6

CHANNEL BANDWIDTH: 3MHz QPSK

Channel	Frequency (MHz)	Conducted Power (dBm)	G _T -L _c (dB)	EIRP (dBm)	EIRP (mW)	Limit (W)
19965	1711.5	22.21	-1.50	20.71	117.76	1
20175	1732.5	22.43	-1.50	20.93	123.88	1
20385	1753.5	22.51	-1.50	21.01	126.18	1

CHANNEL BANDWIDTH: 3MHz 16QAM

Channel	Frequency (MHz)	Conducted Power (dBm)	G _T -L _c (dB)	EIRP (dBm)	EIRP (mW)	Limit (W)
19965	1711.5	21.77	-1.50	20.27	106.41	1
20175	1732.5	21.97	-1.50	20.47	111.43	1
20385	1753.5	22.03	-1.50	20.53	112.98	1

CHANNEL BANDWIDTH: 3MHz 64QAM

Channel	Frequency (MHz)	Conducted Power (dBm)	G _T -L _c (dB)	EIRP (dBm)	EIRP (mW)	Limit (W)
19965	1711.5	20.18	-1.50	18.68	73.79	1
20175	1732.5	20.35	-1.50	18.85	76.74	1
20385	1753.5	20.42	-1.50	18.92	77.98	1



BUREAU
VERITAS

Test Report No.: RFA20210104W001-6

CHANNEL BANDWIDTH: 5MHz QPSK

Channel	Frequency (MHz)	Conducted Power (dBm)	G _{T-Lc} (dB)	EIRP (dBm)	EIRP (mW)	Limit (W)
19975	1712.5	22.26	-1.50	20.76	119.12	1
20175	1732.5	22.40	-1.50	20.90	123.03	1
20375	1752.5	22.51	-1.50	21.01	126.18	1

CHANNEL BANDWIDTH: 5MHz 16QAM

Channel	Frequency (MHz)	Conducted Power (dBm)	G _{T-Lc} (dB)	EIRP (dBm)	EIRP (mW)	Limit (W)
19975	1712.5	21.74	-1.50	20.24	105.68	1
20175	1732.5	22.00	-1.50	20.50	112.20	1
20375	1752.5	22.02	-1.50	20.52	112.72	1

CHANNEL BANDWIDTH: 5MHz 64QAM

Channel	Frequency (MHz)	Conducted Power (dBm)	G _{T-Lc} (dB)	EIRP (dBm)	EIRP (mW)	Limit (W)
19975	1712.5	20.15	-1.50	18.65	73.28	1
20175	1732.5	20.41	-1.50	18.91	77.80	1
20375	1752.5	20.42	-1.50	18.92	77.98	1

CHANNEL BANDWIDTH: 10MHz QPSK

Channel	Frequency (MHz)	Conducted Power (dBm)	G _T -L _c (dB)	EIRP (dBm)	EIRP (mW)	Limit (W)
18650	1715.0	22.26	-1.50	20.76	119.12	1
18900	1732.5	22.40	-1.50	20.90	123.03	1
19150	1750.0	22.52	-1.50	21.02	126.47	1

CHANNEL BANDWIDTH: 10MHz 16QAM

Channel	Frequency (MHz)	Conducted Power (dBm)	G _T -L _c (dB)	EIRP (dBm)	EIRP (mW)	Limit (W)
20000	1715.0	21.79	-1.50	20.29	106.91	1
20175	1732.5	21.96	-1.50	20.46	111.17	1
20350	1750.0	22.05	-1.50	20.55	113.50	1

CHANNEL BANDWIDTH: 10MHz 64QAM

Channel	Frequency (MHz)	Conducted Power (dBm)	G _T -L _c (dB)	EIRP (dBm)	EIRP (mW)	Limit (W)
20000	1715.0	20.20	-1.50	18.70	74.13	1
20175	1732.5	20.37	-1.50	18.87	77.09	1
20350	1750.0	20.46	-1.50	18.96	78.70	1



**BUREAU
VERITAS**

Test Report No.: RFA20210104W001-6

CHANNEL BANDWIDTH: 15MHz QPSK

Channel	Frequency (MHz)	Conducted Power (dBm)	G _T -L _c (dB)	EIRP (dBm)	EIRP (mW)	Limit (W)
20025	1717.5	22.24	-1.50	20.74	118.58	1
20175	1732.5	22.45	-1.50	20.95	124.45	1
20325	1747.5	22.47	-1.50	20.97	125.03	1

CHANNEL BANDWIDTH: 15MHz 16QAM

Channel	Frequency (MHz)	Conducted Power (dBm)	G _T -L _c (dB)	EIRP (dBm)	EIRP (mW)	Limit (W)
20025	1717.5	21.78	-1.50	20.28	106.66	1
20175	1732.5	21.97	-1.50	20.47	111.43	1
20325	1747.5	22.05	-1.50	20.55	113.50	1

CHANNEL BANDWIDTH: 15MHz 64QAM

Channel	Frequency (MHz)	Conducted Power (dBm)	G _T -L _c (dB)	EIRP (dBm)	EIRP (mW)	Limit (W)
20025	1717.5	20.21	-1.50	18.71	74.30	1
20175	1732.5	20.36	-1.50	18.86	76.91	1
20325	1747.5	20.43	-1.50	18.93	78.16	1



BUREAU
VERITAS

Test Report No.: RFA20210104W001-6

CHANNEL BANDWIDTH: 20MHz QPSK

Channel	Frequency (MHz)	Conducted Power (dBm)	G _T -L _c (dB)	EIRP (dBm)	EIRP (mW)	Limit (W)
20050	1720.0	22.28	-1.50	20.78	119.67	1
20175	1732.5	22.48	-1.50	20.98	125.31	1
20300	1745.0	22.53	-1.50	21.03	126.77	1

CHANNEL BANDWIDTH: 20MHz 16QAM

Channel	Frequency (MHz)	Conducted Power (dBm)	G _T -L _c (dB)	EIRP (dBm)	EIRP (mW)	Limit (W)
20050	1720.0	21.82	-1.50	20.32	107.65	1
20175	1732.5	22.02	-1.50	20.52	112.72	1
20300	1745.0	22.07	-1.50	20.57	114.02	1

CHANNEL BANDWIDTH: 20MHz 64QAM

Channel	Frequency (MHz)	Conducted Power (dBm)	G _T -L _c (dB)	EIRP (dBm)	EIRP (mW)	Limit (W)
20050	1720.0	20.23	-1.50	18.73	74.64	1
20175	1732.5	20.43	-1.50	18.93	78.16	1
20300	1745.0	20.48	-1.50	18.98	79.07	1

REMARKS: ERP Output Power (dBm) = EIRP (dBm) -2.15(dB).

3.2 FREQUENCY STABILITY MEASUREMENT

3.2.1 LIMITS OF FREQUENCY STABILITY MEASUREMENT

The frequency stability shall be sufficient to ensure that the fundamental emissions stay within the authorized bands of operation.

3.2.2 TEST PROCEDURE

- a. Device is placed at the oven room. The oven room could control the temperatures and humidity. Power warm up is at least 15 min and power applied should perform before recording frequency error.
- b. EUT is connected the external power supply to control the DC input power. The test voltage range is from minimum to maximum working voltage. Each step shall be record the frequency error rate.
- c. The temperature range step is 10 degrees in this test items. All temperature levels shall be hold the $\pm 0.5^{\circ}\text{C}$ during the measurement testing. The each temperature step shall be at least 0.5 hours, consider the EUT could be test under the stability condition.

NOTE: The frequency error was recorded frequency error from the communication simulator.

3.2.3 TEST SETUP

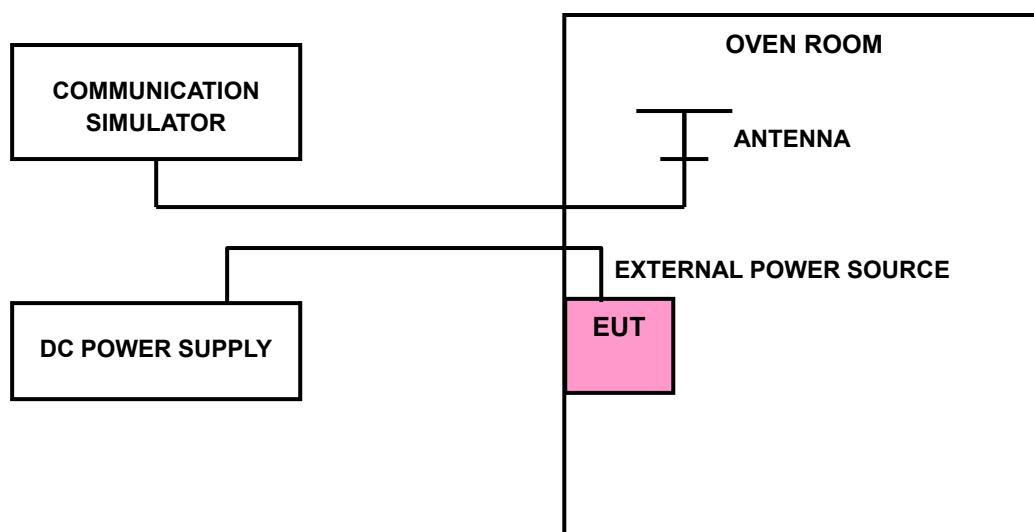

3.2.4 TEST RESULTS

LTE BAND 4

FREQUENCY ERROR VS. VOLTAGE

VOLTAGE (Volts)	1.4MHz		LIMIT (ppm)
	FREQUENCY ERROR (ppm)		
	Low Channel	High Channel	
V_{nor}	0.0019	0.0025	2.5
V_{min}	-0.0031	-0.003	2.5
V_{max}	0.0021	0.0021	2.5

NOTE: The applicant defined the normal working voltage of the battery is from V_{min} to V_{max} .

FREQUENCY ERROR vs. TEMPERATURE.

TEMP. (°C)	1.4MHz		LIMIT (ppm)
	FREQUENCY ERROR (ppm)		
	Low Channel	High Channel	
-30	-0.0122	-0.0114	2.5
-20	-0.01	-0.0099	2.5
-10	-0.0083	-0.0082	2.5
0	-0.0077	-0.0072	2.5
10	-0.005	-0.005	2.5
20	-0.0043	-0.0044	2.5
30	-0.0039	-0.0039	2.5
40	-0.0016	-0.0021	2.5
50	-0.0004	-0.0004	2.5

FREQUENCY ERROR VS. VOLTAGE

VOLTAGE (Volts)	3MHz		LIMIT (ppm)
	FREQUENCY ERROR (ppm)		
	Low Channel	High Channel	
V _{nor}	0.0021	0.0021	2.5
V _{min}	-0.0021	-0.0025	2.5
V _{max}	0.0019	0.0018	2.5

NOTE: The applicant defined the normal working voltage of the battery is from V_{min} to V_{max}.

FREQUENCY ERROR vs. TEMPERATURE.

TEMP. (°C)	3MHz		LIMIT (ppm)
	FREQUENCY ERROR (ppm)		
	Low Channel	High Channel	
-30	-0.0113	-0.0117	2.5
-20	-0.0108	-0.0109	2.5
-10	-0.0083	-0.0084	2.5
0	-0.0078	-0.0075	2.5
10	-0.0053	-0.0048	2.5
20	-0.0041	-0.0041	2.5
30	-0.004	-0.0038	2.5
40	-0.0022	-0.0014	2.5
50	-0.0002	-0.0004	2.5

FREQUENCY ERROR VS. VOLTAGE

VOLTAGE (Volts)	5MHz		LIMIT (ppm)
	FREQUENCY ERROR (ppm)		
	Low Channel	High Channel	
V _{nor}	0.0022	0.0023	2.5
V _{min}	-0.0024	-0.003	2.5
V _{max}	0.0021	0.0021	2.5

NOTE: The applicant defined the normal working voltage of the battery is from V_{min} to V_{max}.

FREQUENCY ERROR vs. TEMPERATURE.

TEMP. (°C)	5MHz		LIMIT (ppm)
	FREQUENCY ERROR (ppm)		
	Low Channel	High Channel	
-30	-0.0114	-0.0112	2.5
-20	-0.0113	-0.0107	2.5
-10	-0.0081	-0.008	2.5
0	-0.0077	-0.0073	2.5
10	-0.0046	-0.0045	2.5
20	-0.0041	-0.0037	2.5
30	-0.0036	-0.0036	2.5
40	-0.0021	-0.0016	2.5
50	-0.0005	-0.0003	2.5

FREQUENCY ERROR VS. VOLTAGE

VOLTAGE (Volts)	10MHz		LIMIT (ppm)
	FREQUENCY ERROR (ppm)		
	Low Channel	High Channel	
V _{nor}	0.0025	0.0025	2.5
V _{min}	-0.0031	-0.003	2.5
V _{max}	0.0026	0.0024	2.5

NOTE: The applicant defined the normal working voltage of the battery is from V_{min} to V_{max}.

FREQUENCY ERROR vs. TEMPERATURE.

TEMP. (°C)	10MHz		LIMIT (ppm)
	FREQUENCY ERROR (ppm)		
	Low Channel	High Channel	
-30	-0.0112	-0.0118	2.5
-20	-0.0111	-0.0104	2.5
-10	-0.0082	-0.0081	2.5
0	-0.0075	-0.0073	2.5
10	-0.0047	-0.0044	2.5
20	-0.0039	-0.004	2.5
30	-0.0037	-0.0041	2.5
40	-0.0015	-0.0017	2.5
50	-0.0001	-0.0002	2.5

FREQUENCY ERROR VS. VOLTAGE

VOLTAGE (Volts)	15MHz		LIMIT (ppm)
	FREQUENCY ERROR (ppm)		
	Low Channel	High Channel	
V _{nor}	0.0025	0.0025	2.5
V _{min}	-0.0031	-0.003	2.5
V _{max}	0.0024	0.0024	2.5

NOTE: The applicant defined the normal working voltage of the battery is from V_{min} to V_{max}.

FREQUENCY ERROR vs. TEMPERATURE.

TEMP. (°C)	15MHz		LIMIT (ppm)
	FREQUENCY ERROR (ppm)		
	Low Channel	High Channel	
-30	-0.0121	-0.0115	2.5
-20	-0.01	-0.0104	2.5
-10	-0.0085	-0.0083	2.5
0	-0.0075	-0.0072	2.5
10	-0.0054	-0.0049	2.5
20	-0.0038	-0.0041	2.5
30	-0.0035	-0.0025	2.5
40	-0.0017	-0.002	2.5
50	-0.0002	-0.0002	2.5

FREQUENCY ERROR VS. VOLTAGE

VOLTAGE (Volts)	20MHz		LIMIT (ppm)
	FREQUENCY ERROR (ppm)		
	Low Channel	High Channel	
V _{nor}	0.0024	0.0024	2.5
V _{min}	-0.0031	-0.003	2.5
V _{max}	0.0025	0.0023	2.5

NOTE: The applicant defined the normal working voltage of the battery is from V_{min} to V_{max}.

FREQUENCY ERROR vs. TEMPERATURE.

TEMP. (°C)	20MHz		LIMIT (ppm)
	FREQUENCY ERROR (ppm)		
	Low Channel	High Channel	
-30	-0.0117	-0.012	2.5
-20	-0.0102	-0.0101	2.5
-10	-0.0085	-0.0081	2.5
0	-0.0074	-0.0076	2.5
10	-0.0048	-0.0044	2.5
20	-0.004	-0.004	2.5
30	-0.0025	-0.0033	2.5
40	-0.0018	-0.002	2.5
50	-0.0004	-0.0003	2.5

3.3 OCCUPIED BANDWIDTH MEASUREMENT

3.3.1 LIMITS OF OCCUPIED BANDWIDTH MEASUREMENT

The width of a frequency band such that, below the lower and above the upper frequency limits, the mean powers emitted are each equal to a specified percentage 0.5 % of the total mean power of a given emission.

3.3.2 TEST SETUP

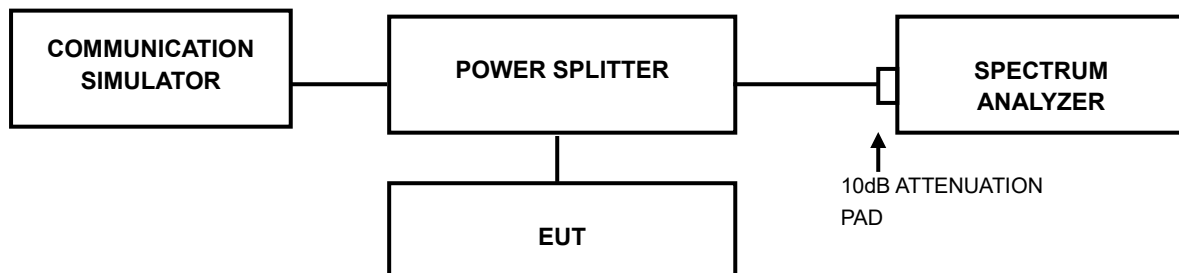

3.3.3 TEST PROCEDURES

- a. The conducted occupied bandwidth used the power splitter via EUT RF power connector between simulation base station and spectrum analyzer.
- b. Use OBW measurement function of Spectrum analyzer to measure 99 % occupied bandwidth.

3.3.4 TEST RESULTS

LTE BAND 4

CHANNEL BANDWIDTH: 1.4MHz							
CHANNEL	Frequency (MHz)	99% OCCUPIED Bandwidth (MHz)			26 dB bandwidth (MHz)		
		QPSK	16QAM	64QAM	QPSK	16QAM	64QAM
19957	1710.7	1.08	1.08	1.09	1.28	1.25	1.29
20175	1732.5	1.08	1.09	1.09	1.24	1.29	1.29
20393	1754.3	1.09	1.08	1.08	1.26	1.26	1.25



CHANNEL BANDWIDTH: 3MHz							
CHANNEL	Frequency (MHz)	99% OCCUPIED Bandwidth (MHz)			26 dB bandwidth (MHz)		
		QPSK	16QAM	64QAM	QPSK	16QAM	64QAM
19965	1711.5	2.68	2.67	2.67	2.86	2.86	2.85
20175	1732.5	2.68	2.67	2.67	2.86	2.87	2.88
20385	1753.5	2.68	2.67	2.68	2.87	2.86	2.86



CHANNEL BANDWIDTH: 5MHz							
CHANNEL	Frequency (MHz)	99% OCCUPIED Bandwidth (MHz)			26 dB bandwidth (MHz)		
		QPSK	16QAM	64QAM	QPSK	16QAM	64QAM
19975	1712.5	4.48	4.46	4.46	5.20	4.83	4.81
20175	1732.5	4.48	4.47	4.47	4.84	4.84	4.85
20375	1752.5	4.46	4.47	4.47	4.84	4.83	4.84



CHANNEL BANDWIDTH: 10MHz							
CHANNEL	Frequency (MHz)	99% OCCUPIED Bandwidth (MHz)			26 dB bandwidth (MHz)		
		QPSK	16QAM	64QAM	QPSK	16QAM	64QAM
20000	1715	8.95	8.94	8.95	9.53	9.50	9.61
20175	1732.5	8.94	8.94	8.94	9.62	9.51	9.53
20350	1750	8.93	8.94	8.95	9.53	9.56	9.56



LTE BAND 4

CHANNEL BANDWIDTH: 15MHz							
CHANNEL	Frequency (MHz)	99% OCCUPIED Bandwidth (MHz)			26 dB bandwidth (MHz)		
		QPSK	16QAM	64QAM	QPSK	16QAM	64QAM
20025	1717.5	13.44	13.40	13.41	14.99	14.34	14.27
20175	1732.5	13.38	13.40	13.40	14.32	14.33	14.34
20325	1747.5	13.44	13.44	13.41	14.48	14.46	14.25





LTE BAND 4

CHANNEL BANDWIDTH: 20MHz							
CHANNEL	Frequency (MHz)	99% OCCUPIED Bandwidth (MHz)			26 dB bandwidth (MHz)		
		QPSK	16QAM	64QAM	QPSK	16QAM	64QAM
20050	1720	17.90	17.89	17.87	19.98	19.05	19.02
20175	1732.5	17.83	17.84	17.87	18.94	19.02	19.03
20300	1745	17.92	17.91	17.89	19.08	19.26	19.11



3.4 PEAK TO AVERAGE RATIO

3.4.1 LIMITS OF PEAK TO AVERAGE RATIO MEASUREMENT

In measuring transmissions in this band using an average power technique, the peak to-average ratio (PAR) of the transmission may not exceed 13 dB

3.4.2 TEST SETUP

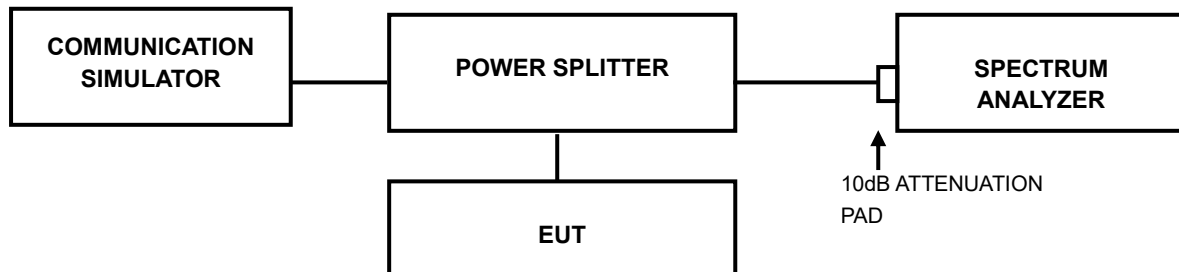

3.4.3 TEST PROCEDURES

1. Set resolution/measurement bandwidth \geq signal's occupied bandwidth;
2. Set the number of counts to a value that stabilizes the measured CCDF curve;
3. Record the maximum PAPR level associated with a probability of 0.1%.

3.4.4 TEST RESULTS

LTE BAND 4

CHANNEL BANDWIDTH: 1.4MHz				
CHANNEL	Frequency (MHz)	PEAK TO AVERAGE RATIO (dB)		
		QPSK	16QAM	64QAM
19957	1710.7	4.82	5.60	5.57
20175	1732.5	5.14	5.79	5.77
20393	1754.3	5.12	5.95	5.99

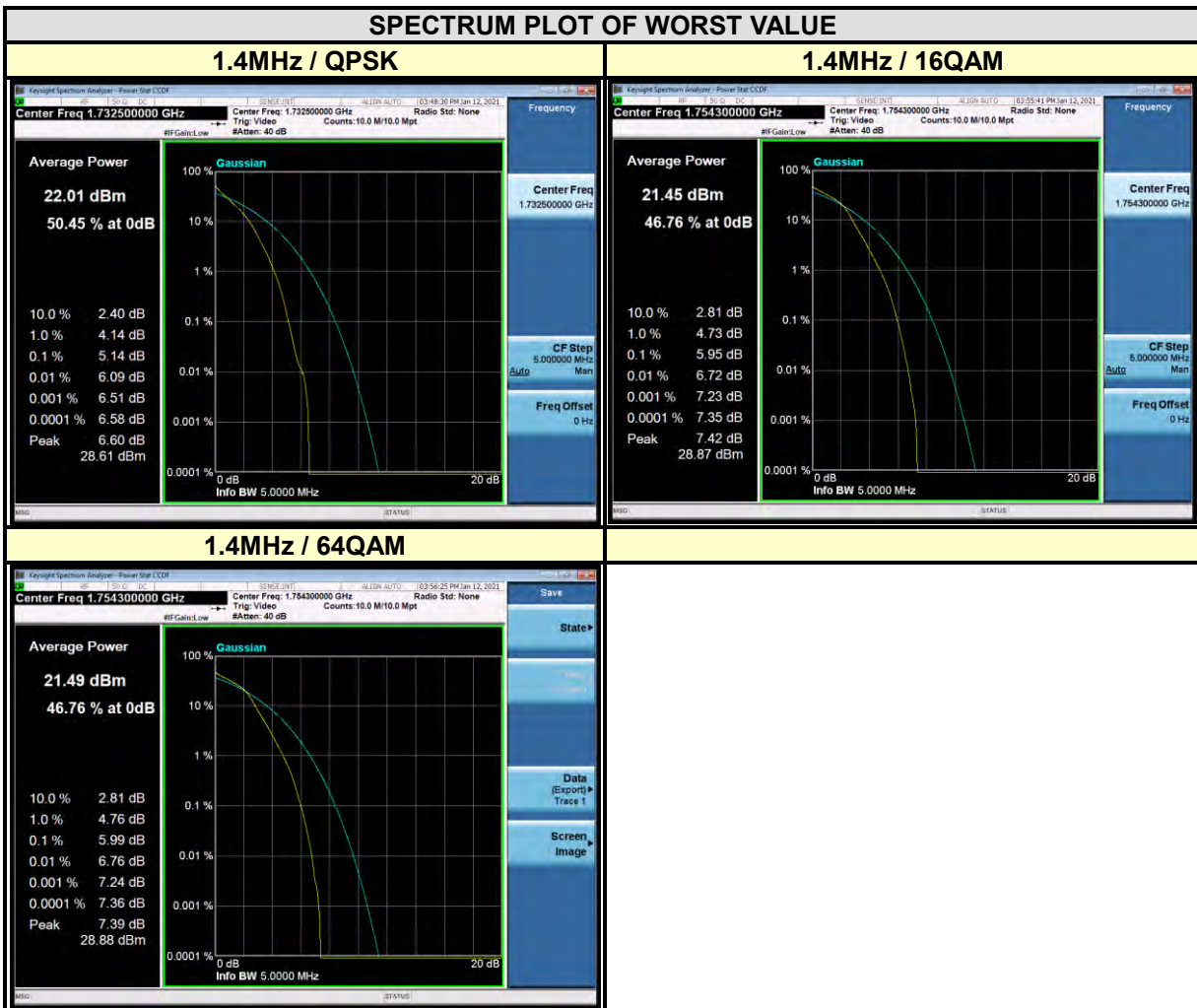

CHANNEL BANDWIDTH: 3MHz				
CHANNEL	Frequency (MHz)	PEAK TO AVERAGE RATIO (dB)		
		QPSK	16QAM	64QAM
19965	1711.5	4.93	5.74	5.74
20175	1732.5	5.21	5.92	5.94
20385	1753.5	5.09	5.82	5.81

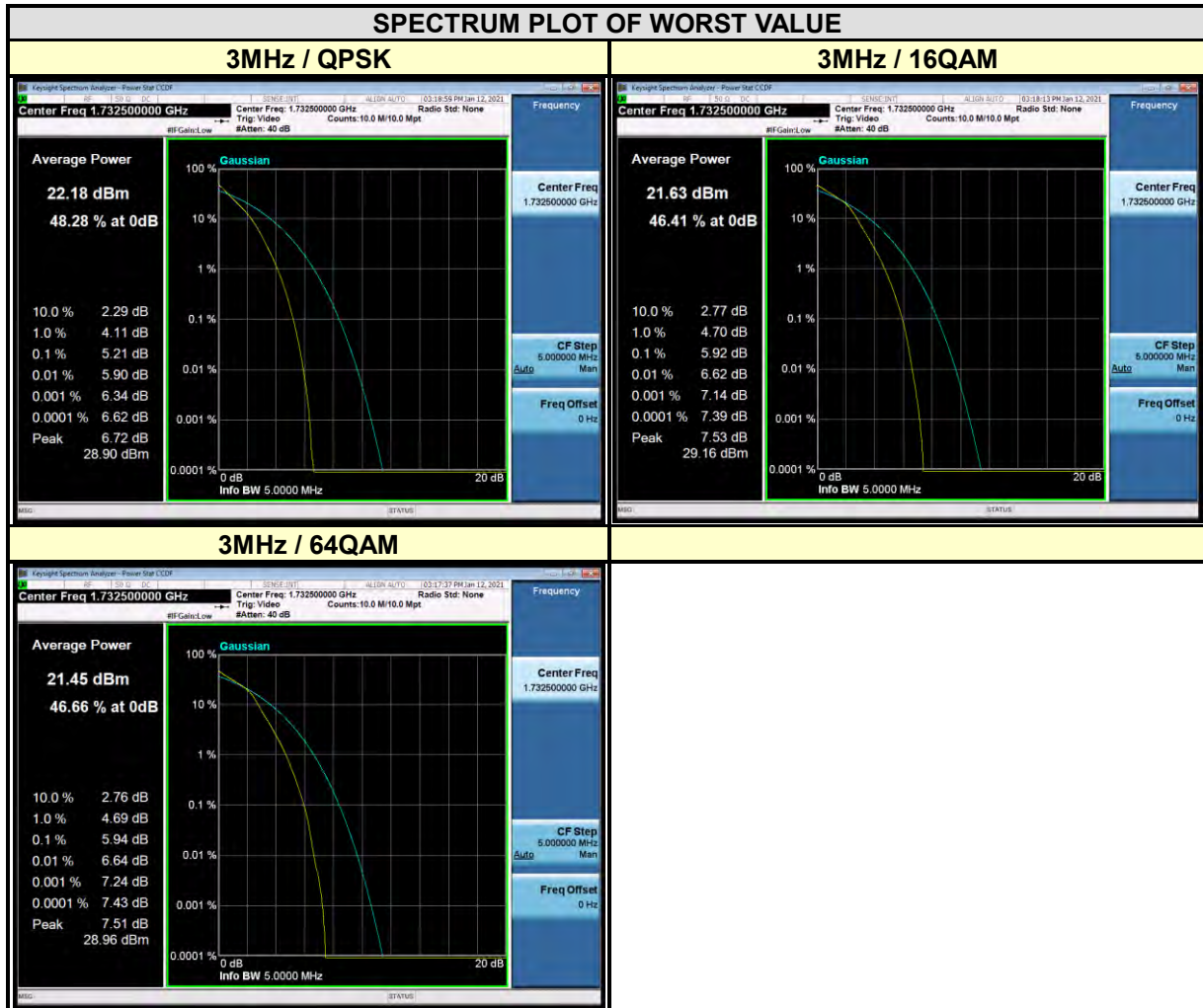



CHANNEL BANDWIDTH: 5MHz				
CHANNEL	Frequency (MHz)	PEAK TO AVERAGE RATIO (dB)		
		QPSK	16QAM	64QAM
19975	1712.5	5.15	5.89	5.89
20175	1732.5	5.35	5.92	5.91
20375	1752.5	5.39	6.04	6.04

SPECTRUM PLOT OF WORST VALUE

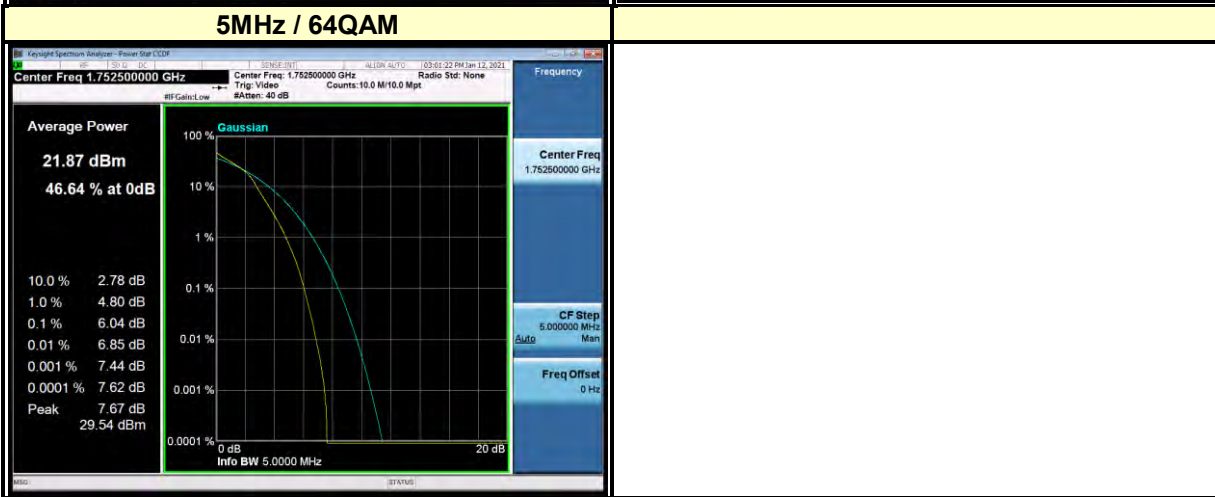
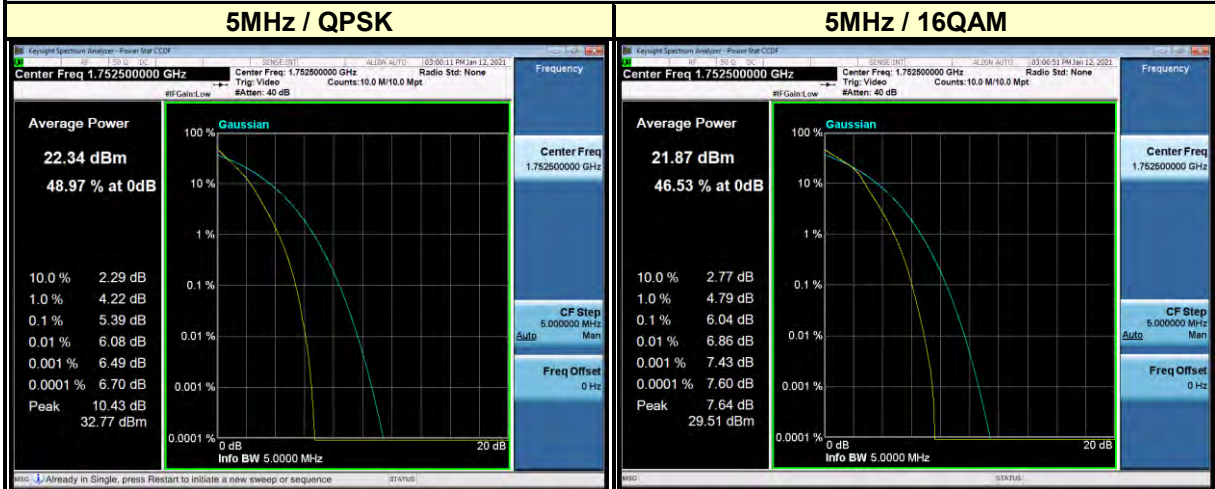



CHANNEL BANDWIDTH: 10MHz				
CHANNEL	Frequency (MHz)	PEAK TO AVERAGE RATIO (dB)		
		QPSK	16QAM	64QAM
20000	1715	4.89	5.69	5.69
20175	1732.5	5.58	5.77	5.79
20350	1750	5.23	5.88	5.89

SPECTRUM PLOT OF WORST VALUE

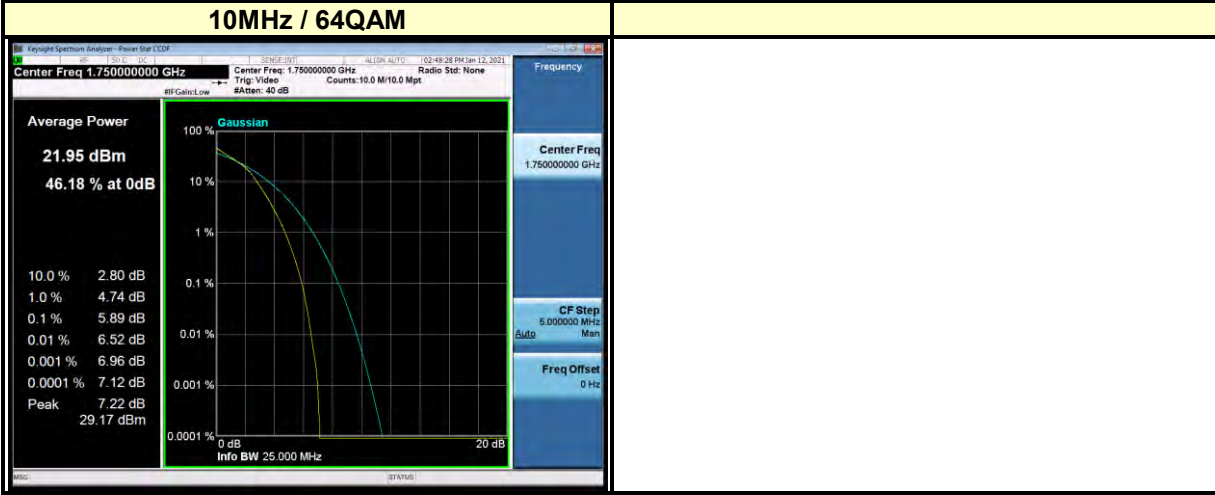
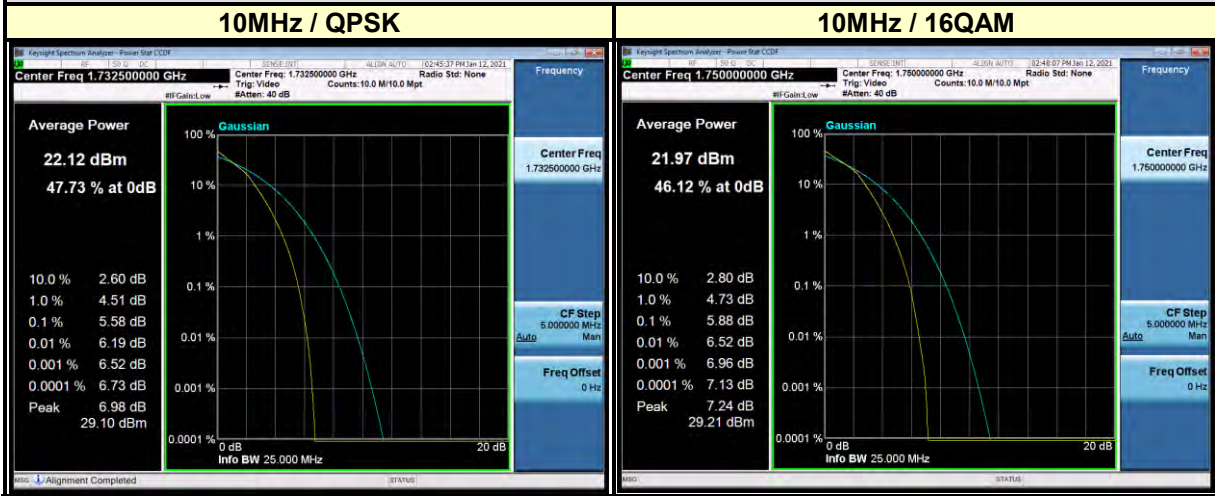



**BUREAU
VERITAS**

Test Report No.: RFA20210104W001-6

CHANNEL BANDWIDTH: 15MHz				
CHANNEL	Frequency (MHz)	PEAK TO AVERAGE RATIO (dB)		
		QPSK	16QAM	64QAM
20025	1717.5	5.35	5.75	5.77
20175	1732.5	5.47	5.56	5.93
20325	1747.5	5.58	6.02	6.03

SPECTRUM PLOT OF WORST VALUE

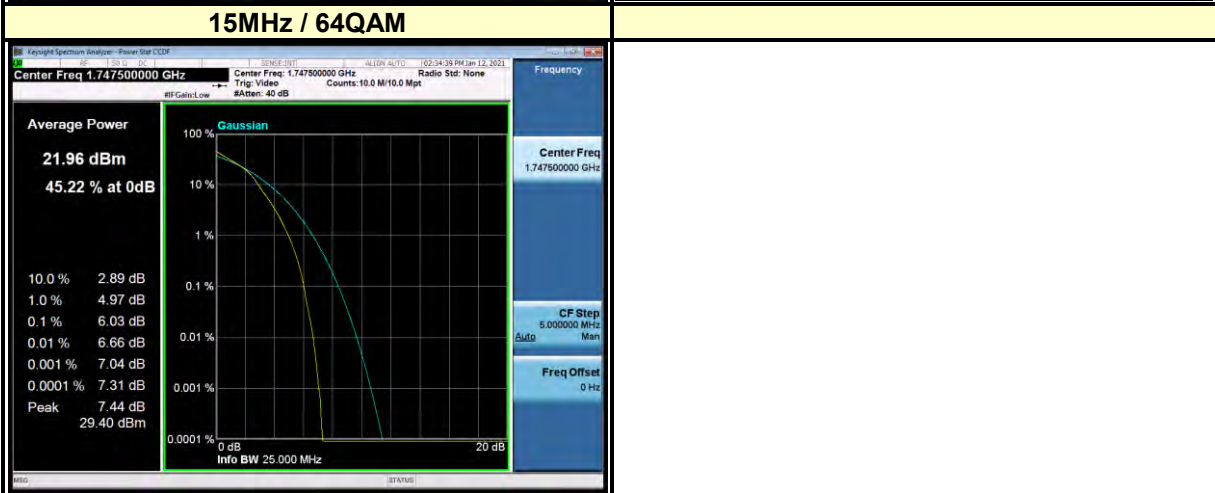
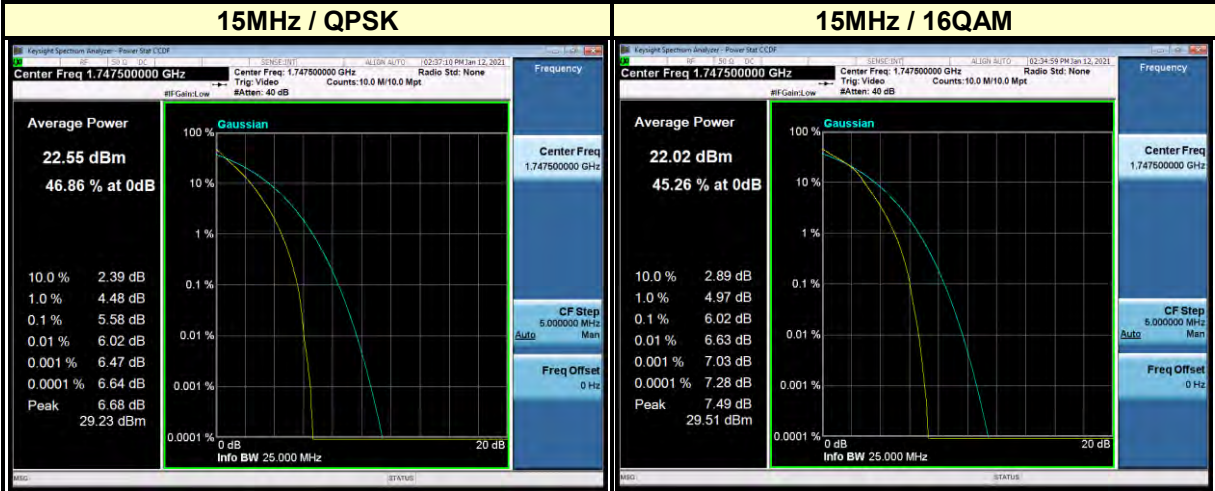



**BUREAU
VERITAS**

Test Report No.: RFA20210104W001-6

CHANNEL BANDWIDTH: 20MHz				
CHANNEL	Frequency (MHz)	PEAK TO AVERAGE RATIO (dB)		
		QPSK	16QAM	64QAM
20050	1720	5.34	5.85	5.81
20175	1732.5	5.23	5.88	5.89
20300	1745	5.35	5.97	5.97

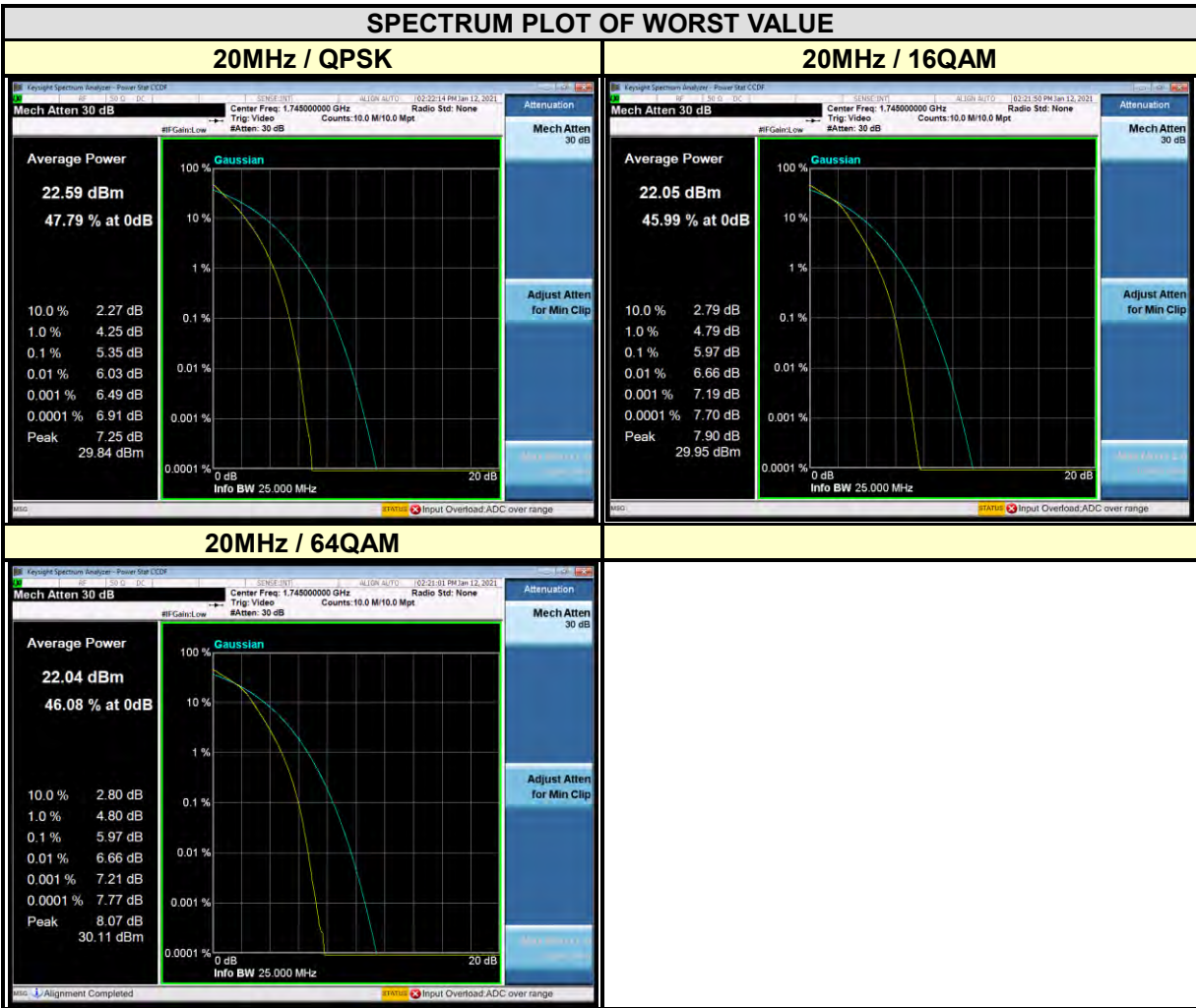

3.5 BAND EDGE MEASUREMENT

3.5.1 LIMITS OF BAND EDGE MEASUREMENT

The power of any emission outside a licensee's frequency band(s) of operation shall be attenuated below the transmitter power (P) within the licensed band(s) of operation, measured in watts, by at least $43 + 10 \log (P)$ dB. Compliance with this provision is based on the use of measurement instrumentation employing a resolution bandwidth of 100 kilohertz or greater.

However, in the 100 kilohertz bands immediately outside and adjacent to a licensee's frequency block, a resolution bandwidth of at least 30 kHz may be employed.

3.5.2 TEST SETUP

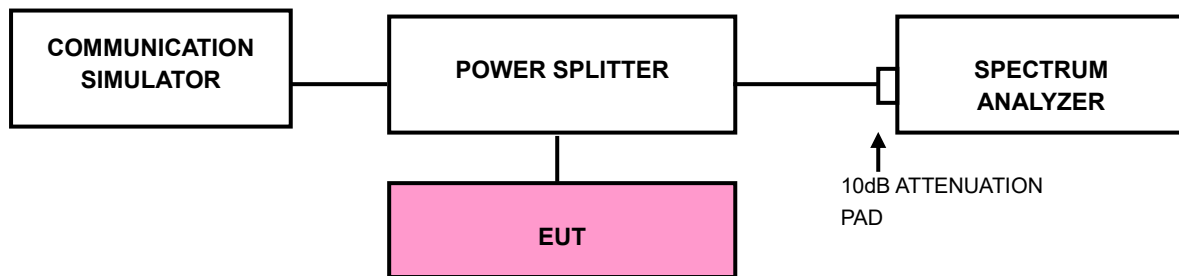



3.5.3 TEST PROCEDURES

- a. The EUT was set up for the maximum peak power with LTE link data modulation. The power was measured with R&S Spectrum Analyzer. All measurements were done at 2 channels (low and high operational frequency range.).
- b. The band edge measurement used the power splitter via EUT RF power connector between simulation base station and spectrum analyzer.
- c. The center frequency of spectrum is the band edge frequency and span is 1~5 MHz. RBW of the spectrum is 30kHz and VBW of the spectrum is 100 kHz. (LTE bandwidth 1.4MHz)
- d. The center frequency of spectrum is the band edge frequency and span is 1~5 MHz. RBW of the spectrum is 30kHz and VBW of the spectrum is 100kHz. (LTE bandwidth 3MHz)
- e. The center frequency of spectrum is the band edge frequency and span is 1~5 MHz. RBW of the spectrum is 50kHz and VBW of the spectrum is 200kHz. (LTE bandwidth 5MHz)
- f. The center frequency of spectrum is the band edge frequency and span is 1~5 MHz. RBW of the spectrum is 100kHz and VBW of the spectrum is 300kHz. (LTE bandwidth 10MHz)
- g. The center frequency of spectrum is the band edge frequency and span is 1~5 MHz. RBW of the spectrum is 200kHz and VBW of the spectrum is 1MHz. (LTE bandwidth 15MHz)
- h. The center frequency of spectrum is the band edge frequency and span is 1~5 MHz. RBW of the spectrum is 200kHz and VBW of the spectrum is 1MHz. (LTE bandwidth 20MHz)
- i. Record the max trace plot into the test report.



BUREAU VERITAS

Test Report No.: RFA20210104W001-6

3.5.4 TEST RESULTS

LTE BAND 4

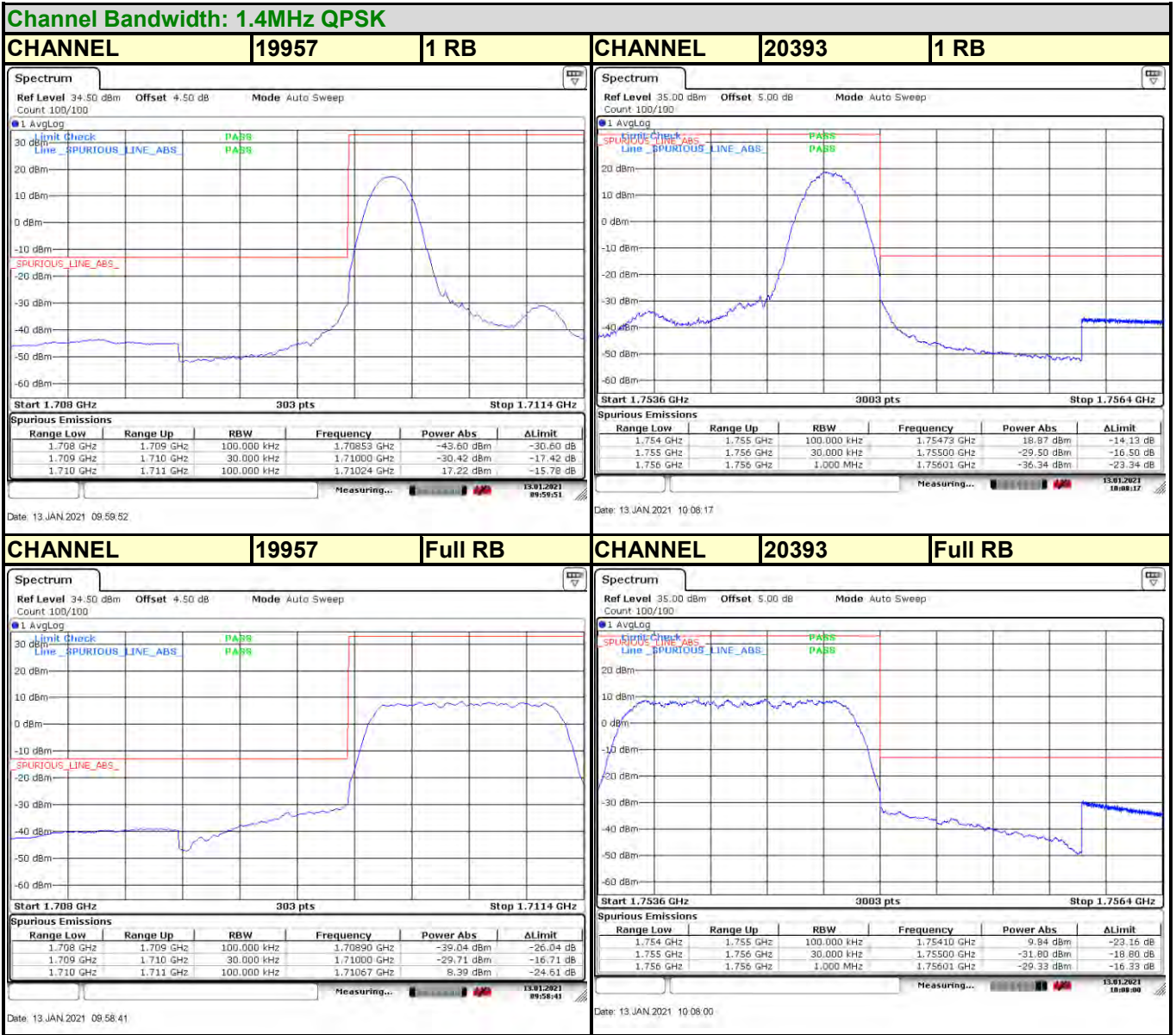



BUREAU VERITAS

Test Report No.: RFA20210104W001-6

Channel Bandwidth: 1.4MHz 16QAM

CHANNEL 19957 1 RB CHANNEL 20393 1 RB

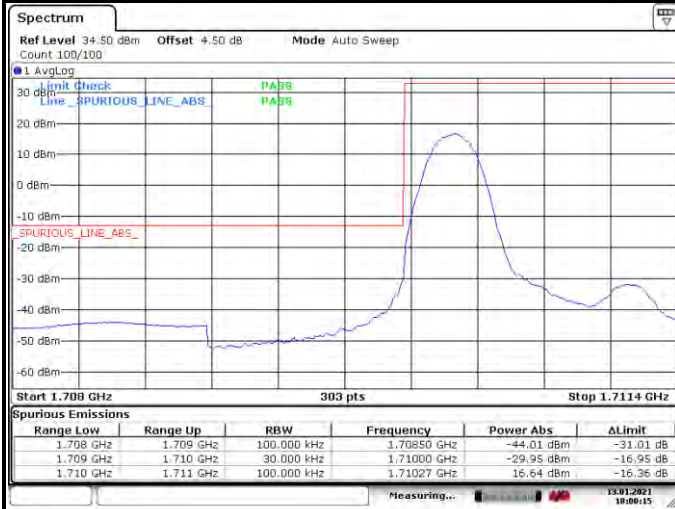

Date: 13.JAN.2021 10:00:15

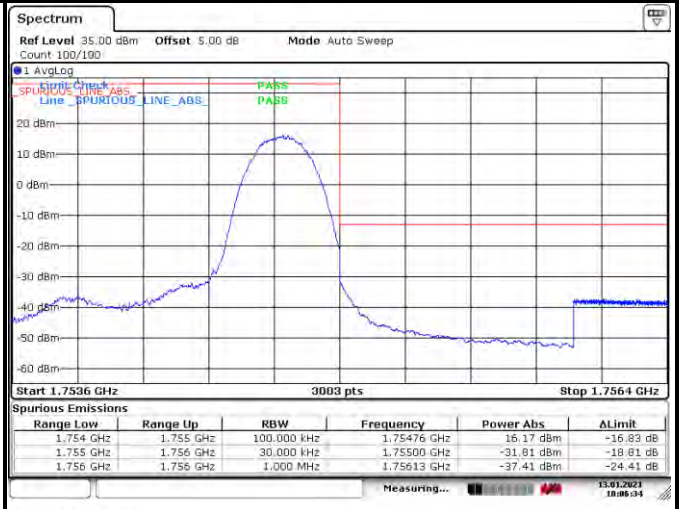

Date: 13.JAN.2021 10:06:34

CHANNEL 19957 Full RB CHANNEL 20393 Full RB

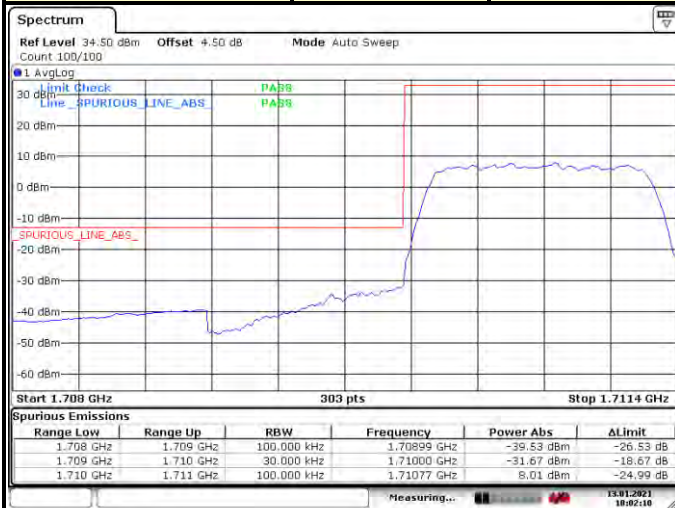

Date: 13.JAN.2021 10:02:10

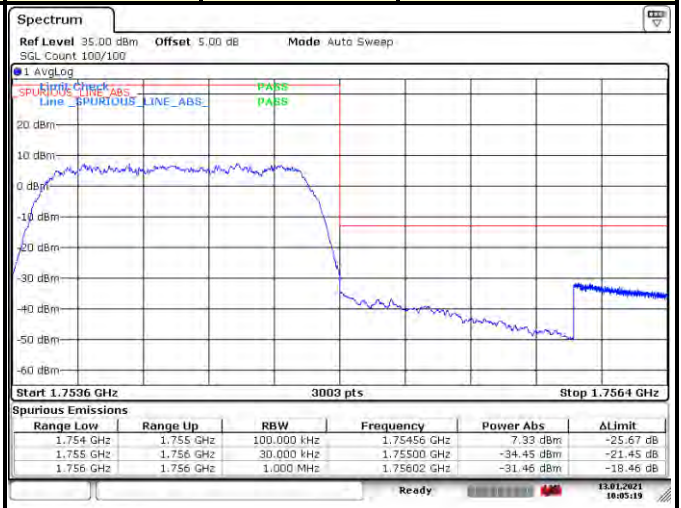

Date: 13.JAN.2021 10:05:19



**BUREAU
VERITAS**

Test Report No.: RFA20210104W001-6

Channel Bandwidth: 1.4MHz 64QAM

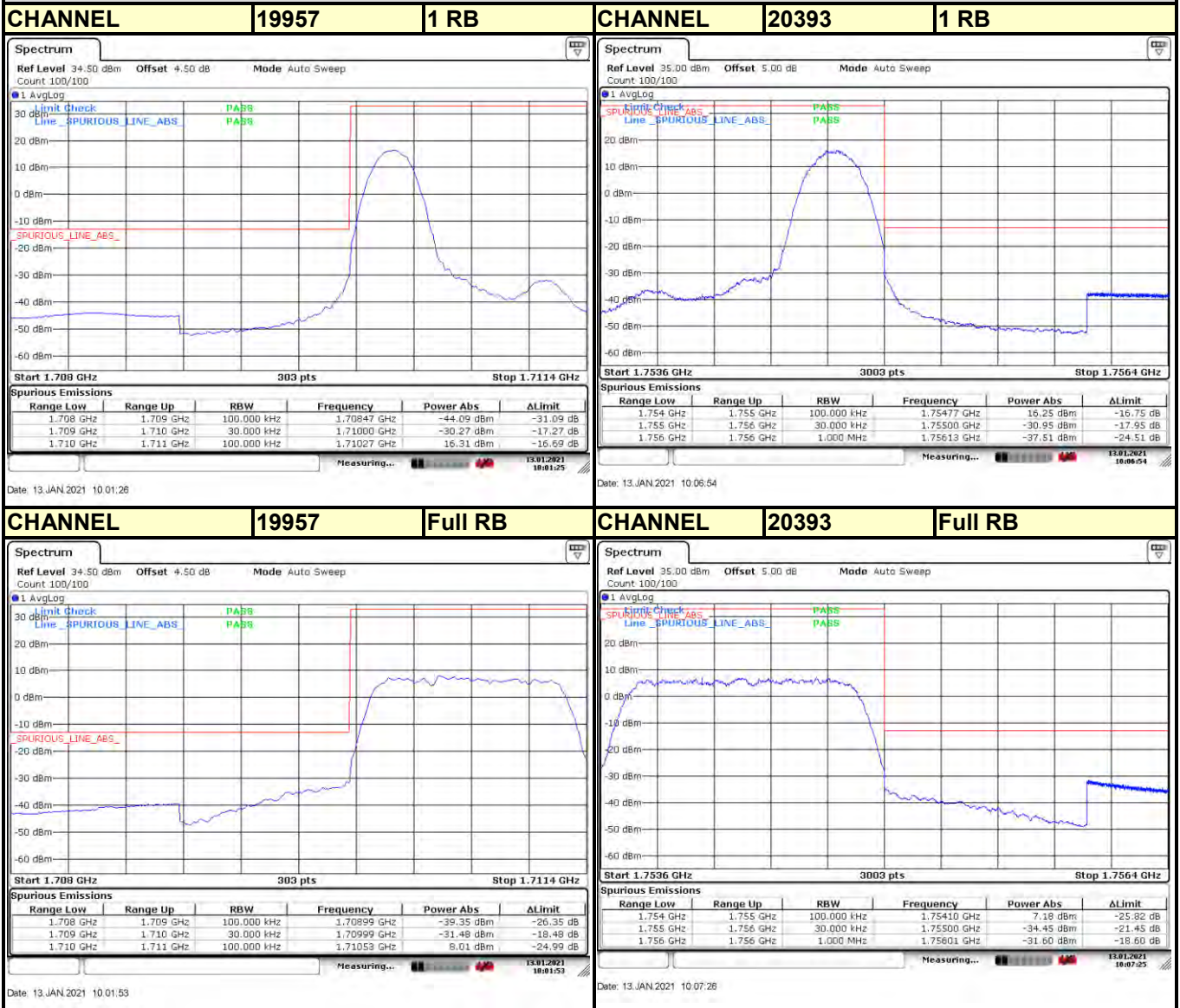



**BUREAU
VERITAS**

Test Report No.: RFA20210104W001-6

LTE BAND 4

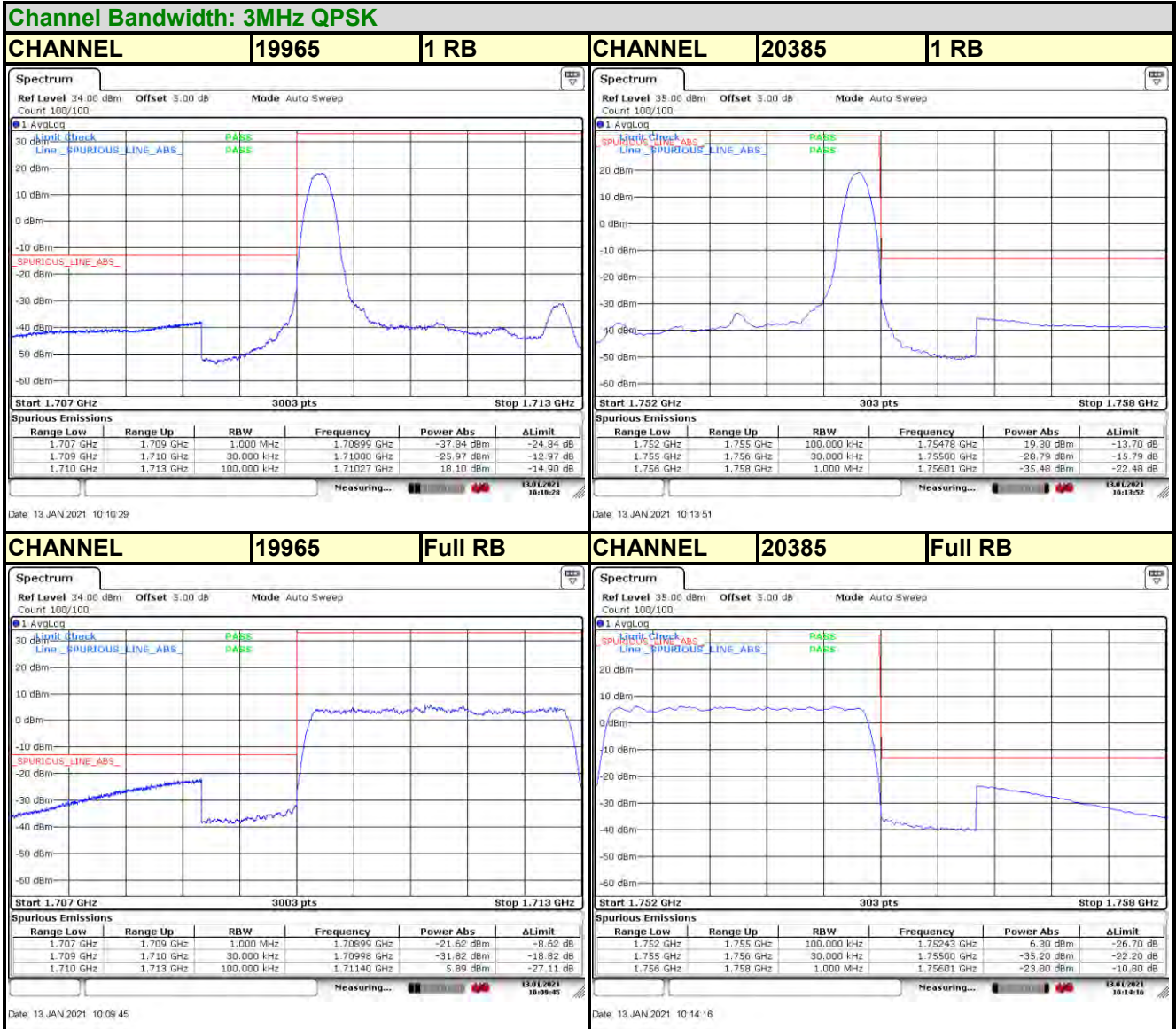



**BUREAU
VERITAS**

Test Report No.: RFA20210104W001-6

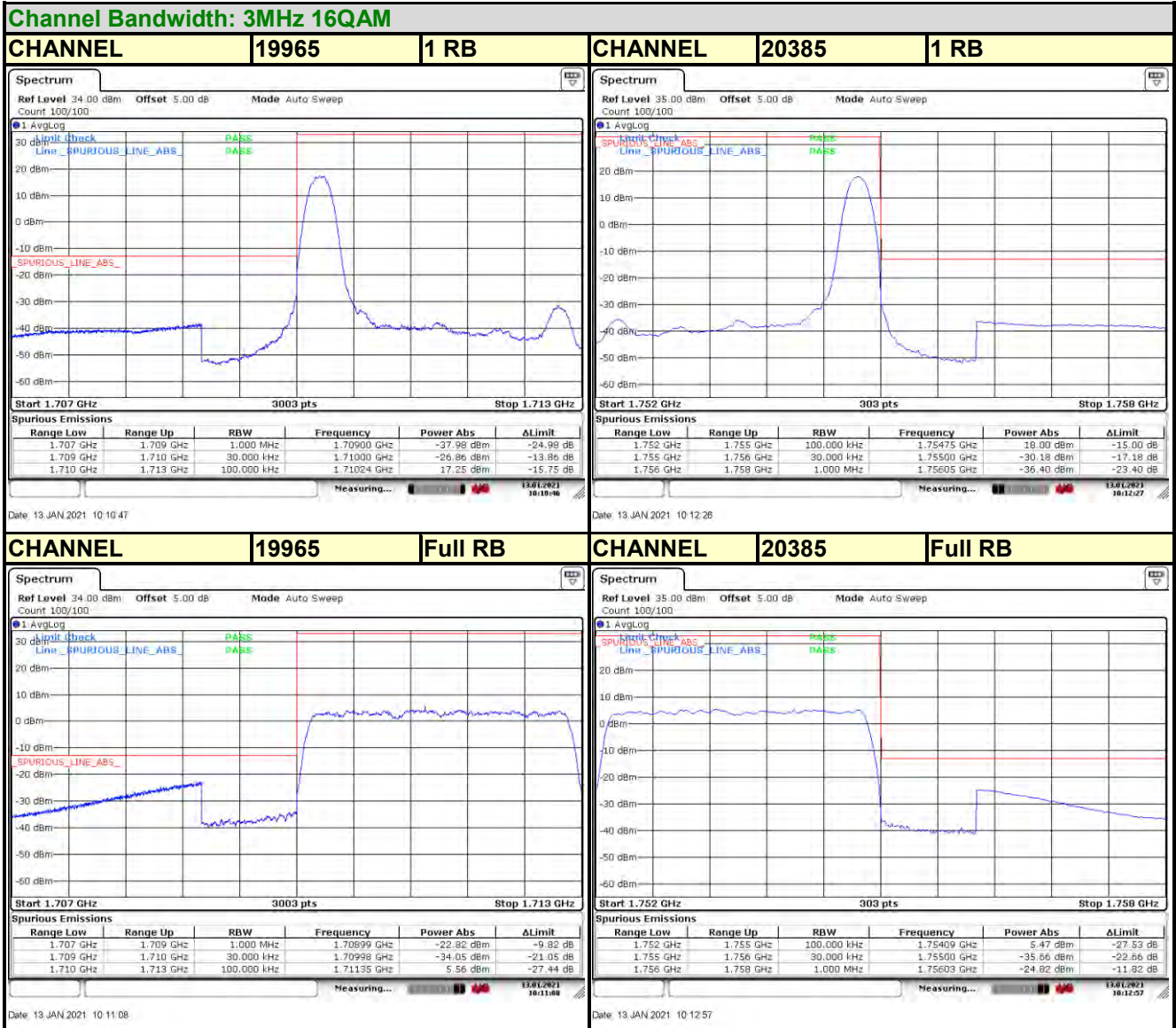



BUREAU VERITAS

Test Report No.: RFA20210104W001-6

Channel Bandwidth: 3MHz 64QAM

CHANNEL	19965	1 RB	CHANNEL	20385	1 RB
----------------	--------------	-------------	----------------	--------------	-------------

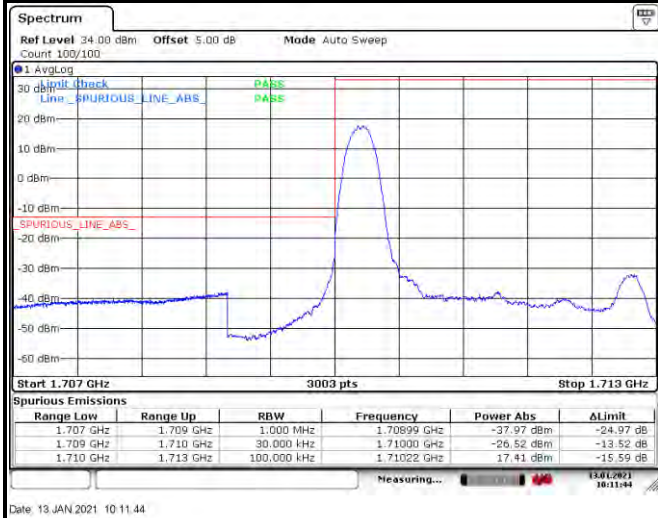

Date: 13 JAN 2021 10:11:44

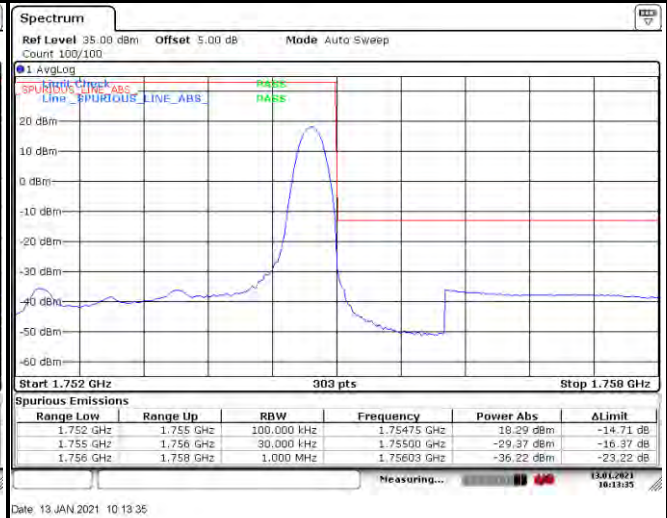

Date: 13 JAN 2021 10:13:35

CHANNEL	19965	Full RB	CHANNEL	20385	Full RB
----------------	--------------	----------------	----------------	--------------	----------------

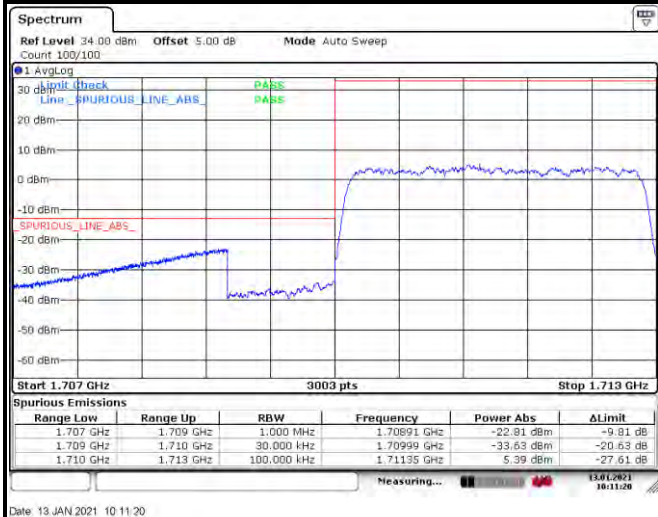

Date: 13 JAN 2021 10:11:20

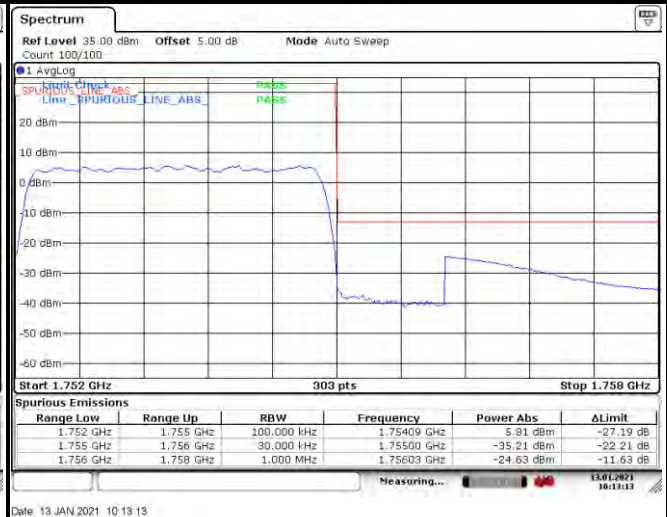

Date: 13 JAN 2021 10:13:13



**BUREAU
VERITAS**

Test Report No.: RFA20210104W001-6

LTE BAND 4

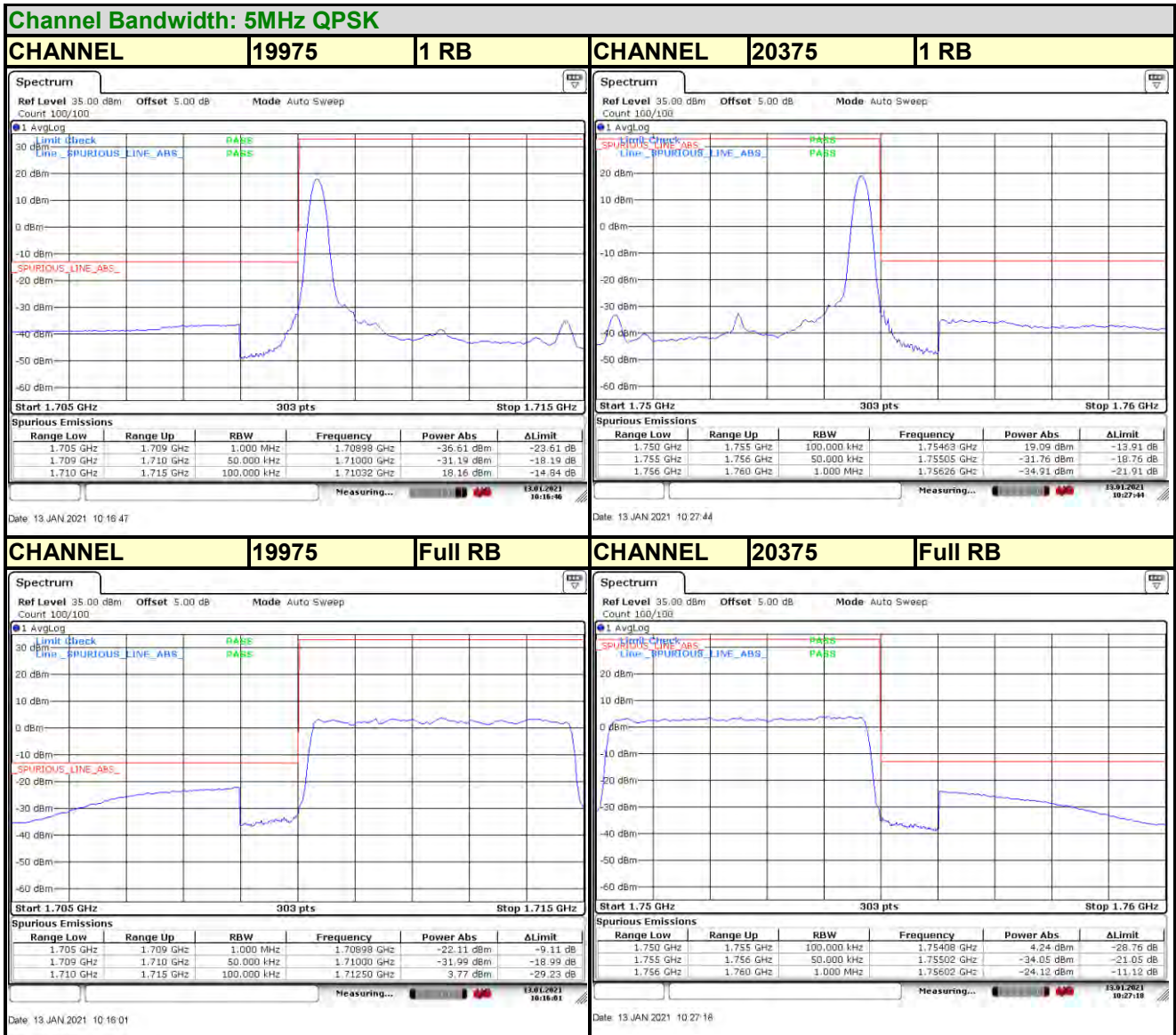



**BUREAU
VERITAS**

Test Report No.: RFA20210104W001-6

Channel Bandwidth: 5MHz 16QAM

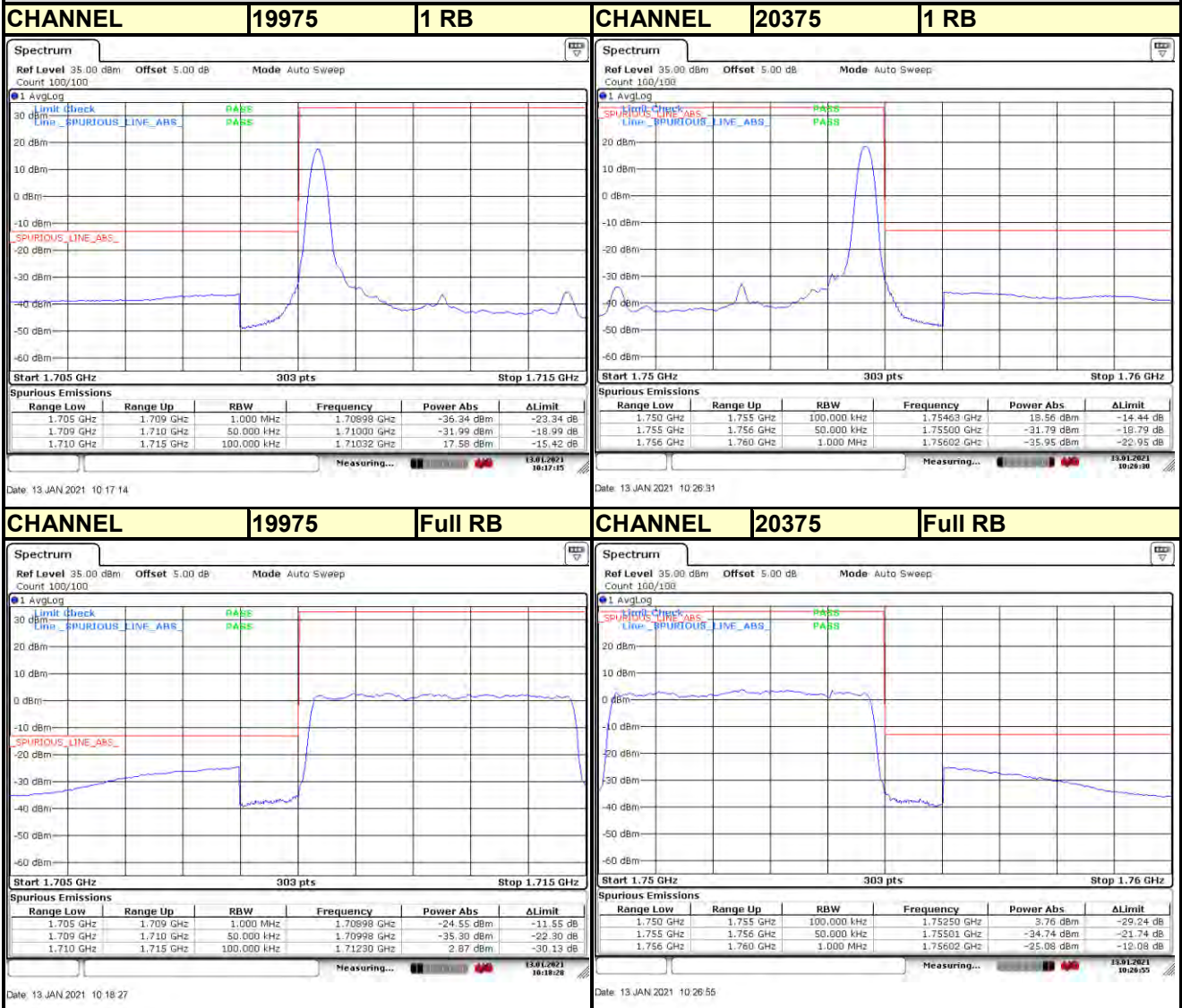



**BUREAU
VERITAS**

Test Report No.: RFA20210104W001-6

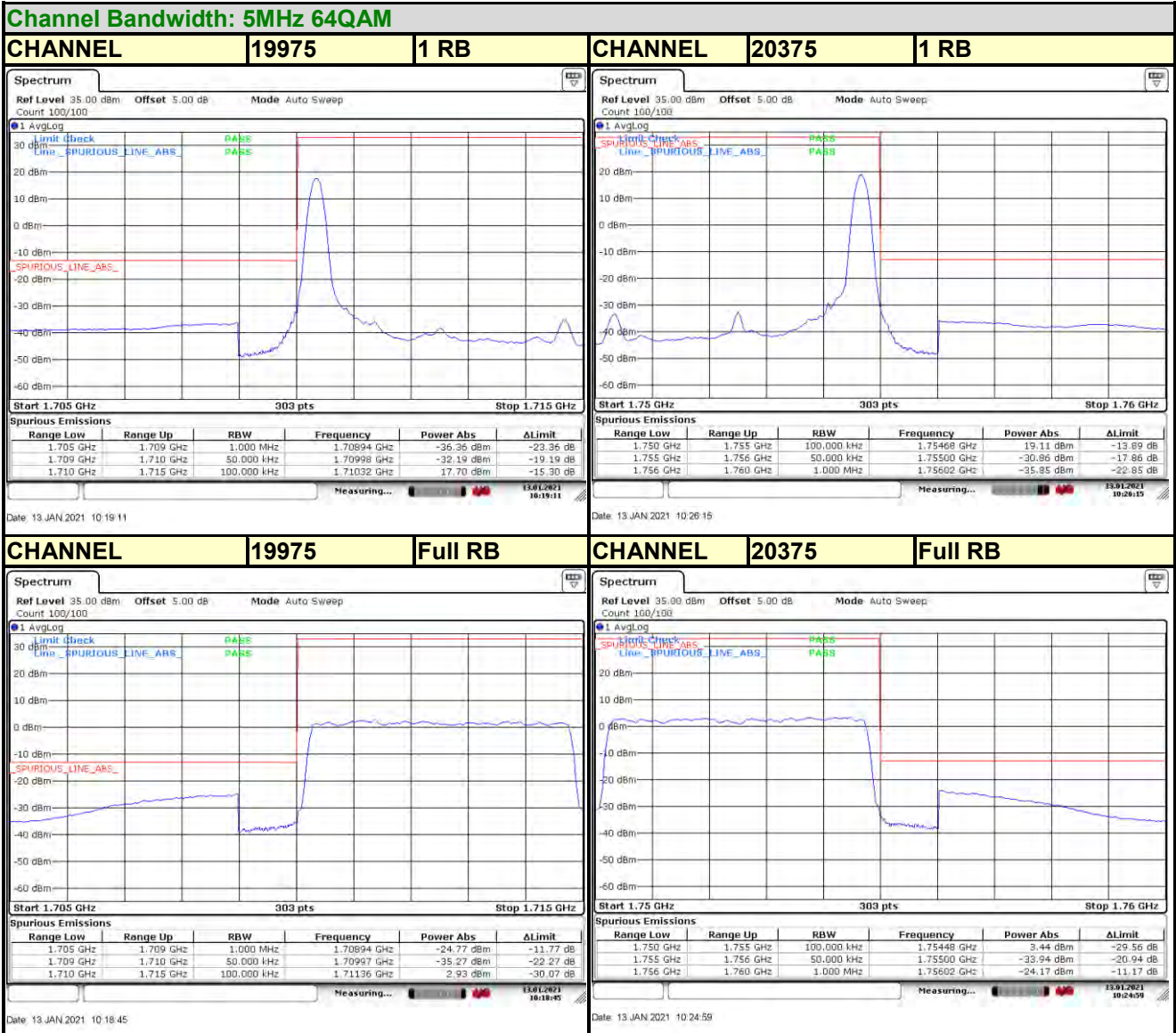



BUREAU VERITAS

Test Report No.: RFA20210104W001-6

LTE BAND 4

Channel Bandwidth: 10MHz QPSK

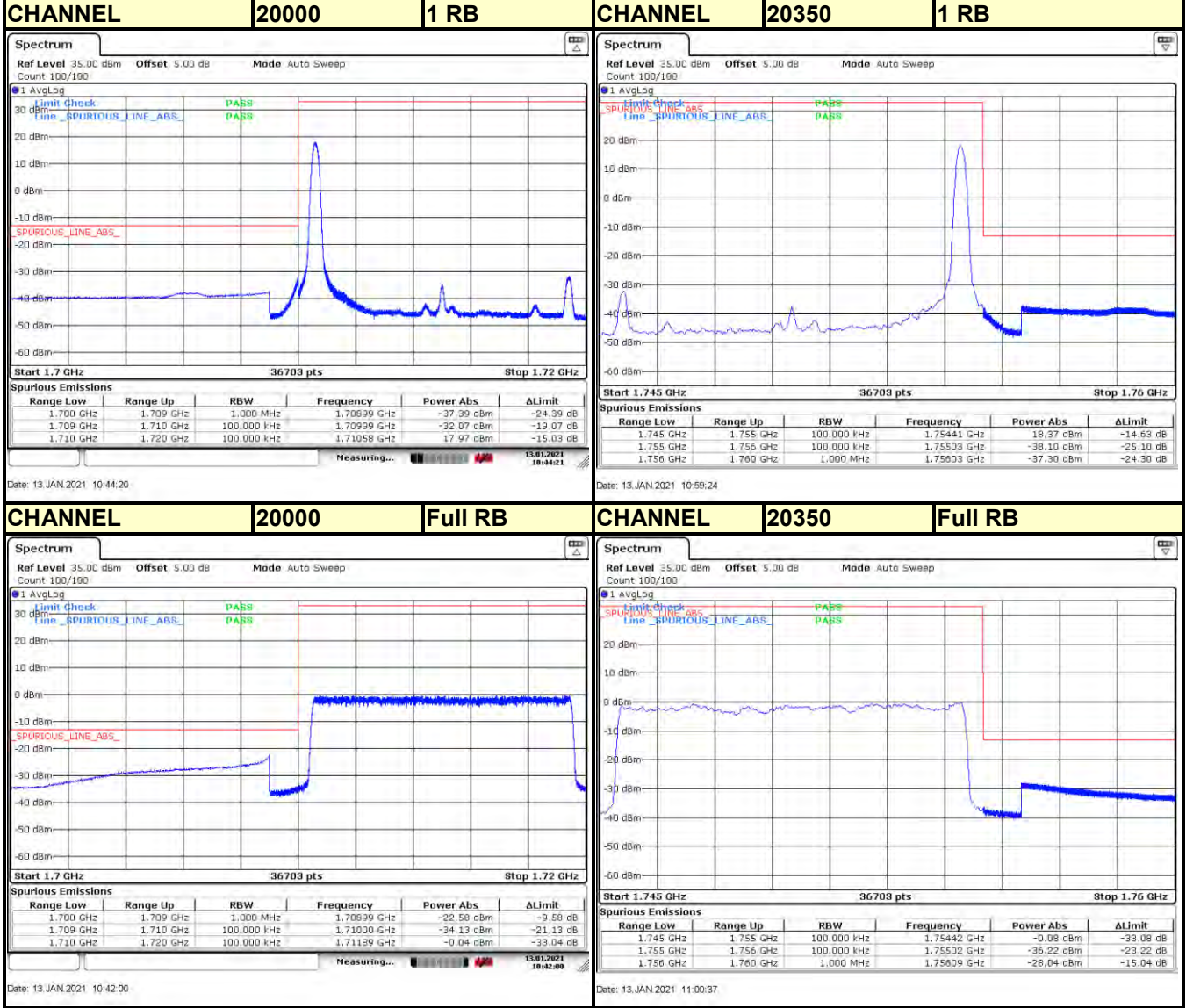



BUREAU VERITAS

Test Report No.: RFA20210104W001-6

Channel Bandwidth: 10MHz 16QAM

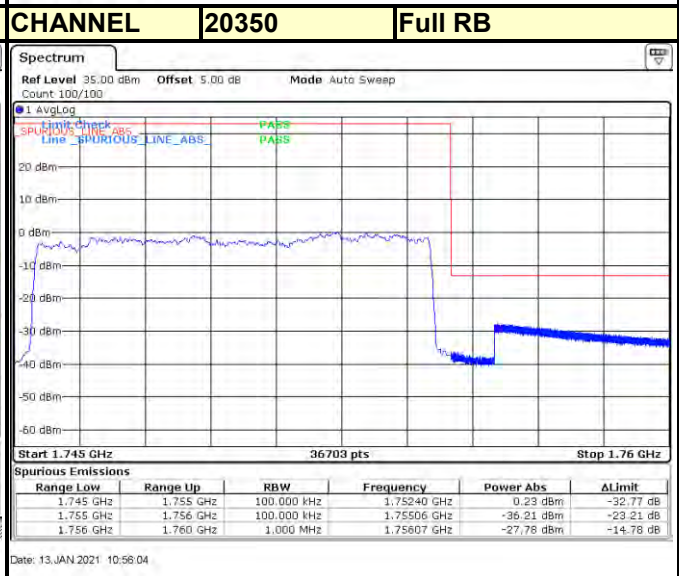
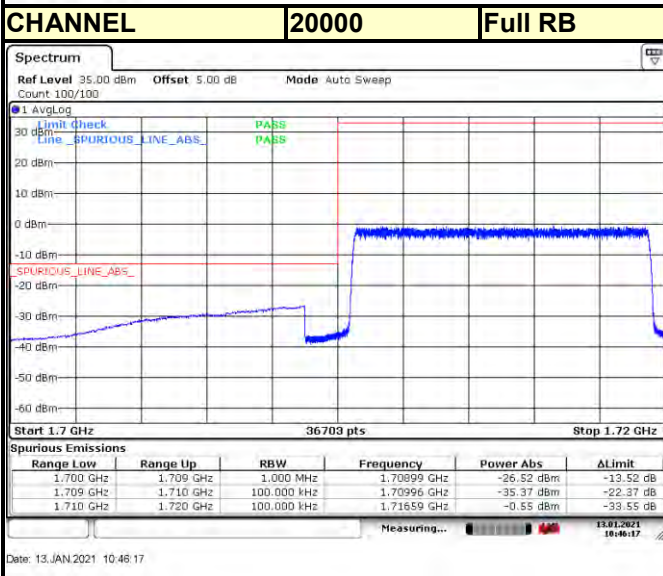
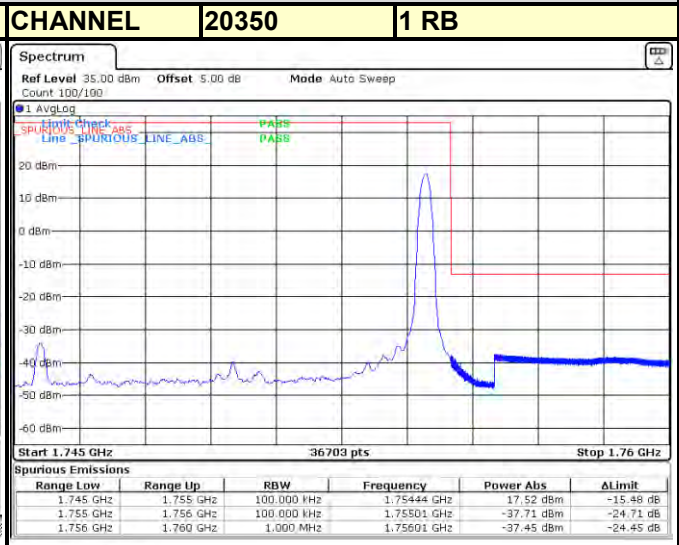
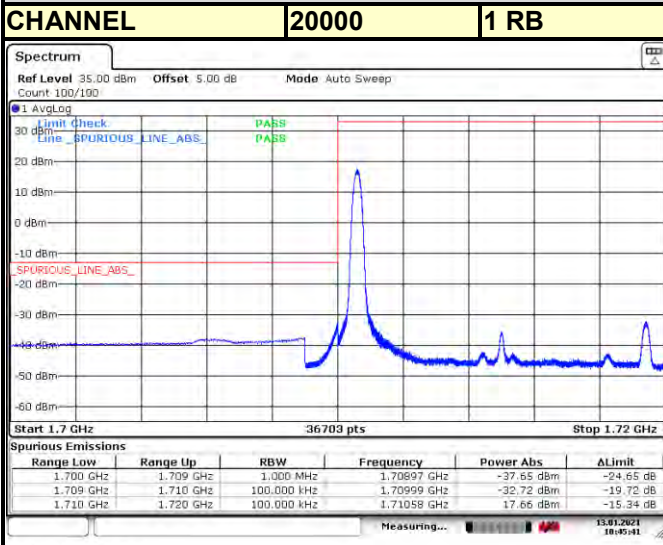



BUREAU VERITAS

Test Report No.: RFA20210104W001-6

Channel Bandwidth: 10MHz 64QAM

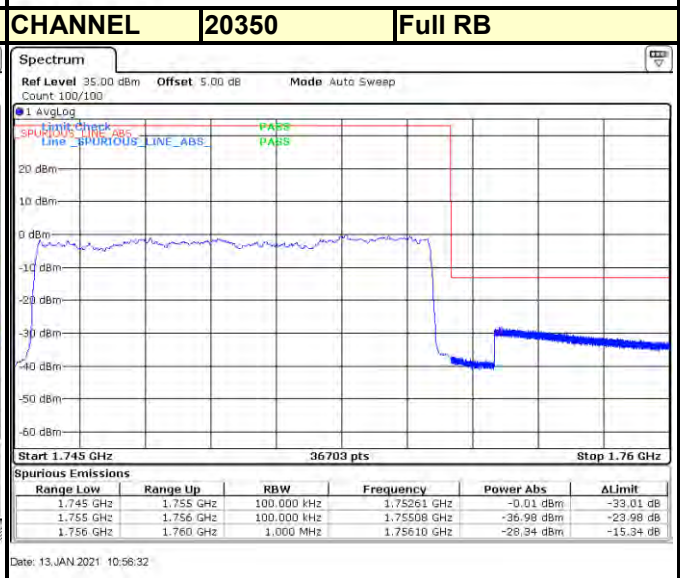
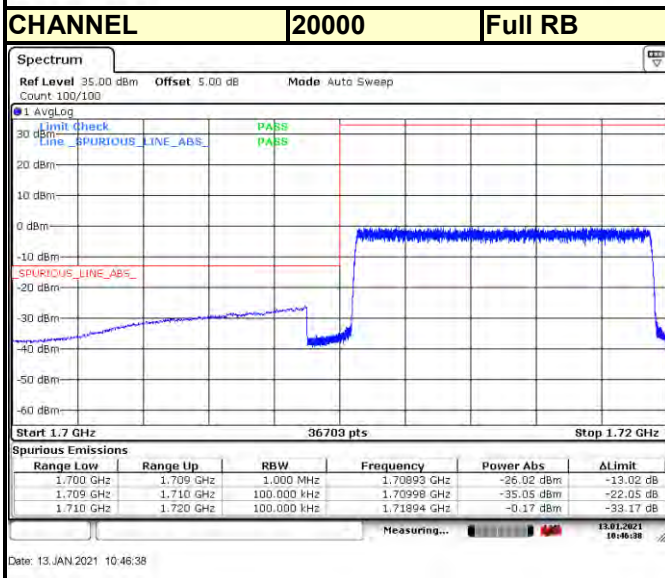
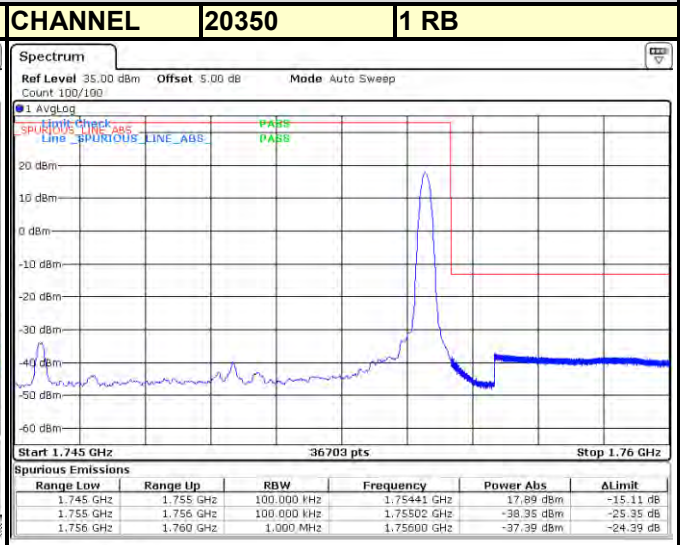
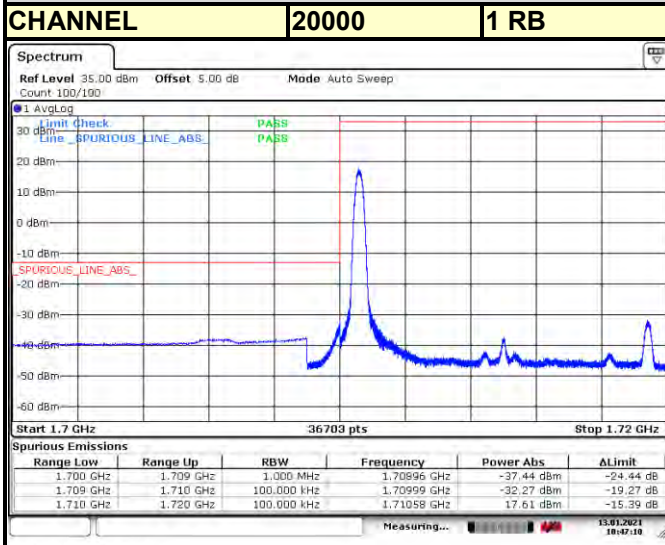



BUREAU VERITAS

Test Report No.: RFA20210104W001-6

LTE BAND 4

Channel Bandwidth: 15MHz QPSK

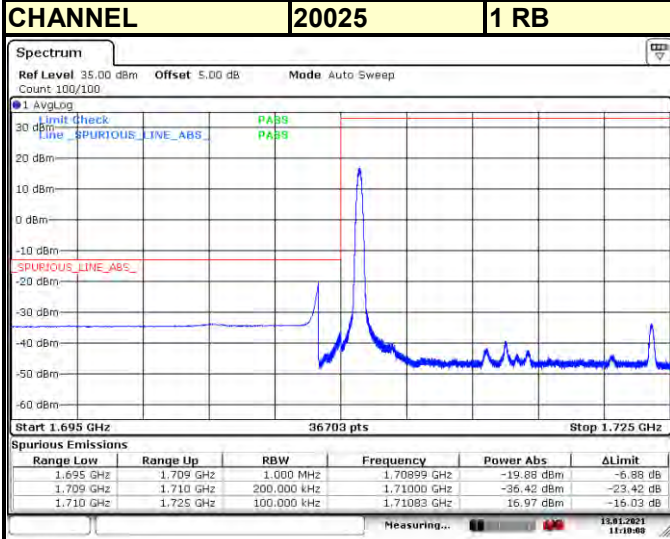

Date: 13 JAN 2021 11:10:08

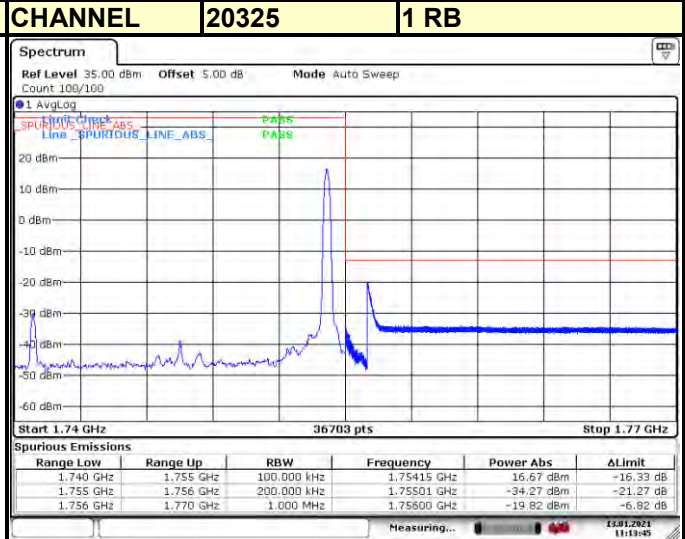

Date: 13 JAN 2021 11:13:45

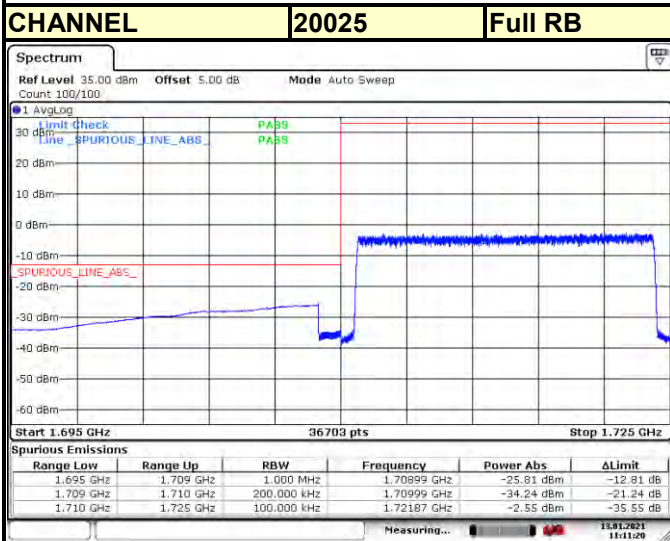

Date: 13 JAN 2021 11:11:20

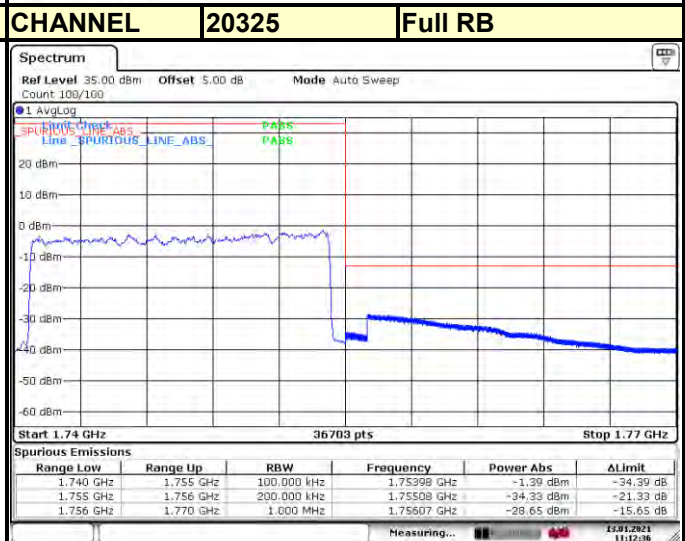

Date: 13 JAN 2021 11:12:36



BUREAU VERITAS

Test Report No.: RFA20210104W001-6

Channel Bandwidth: 15MHz 16QAM

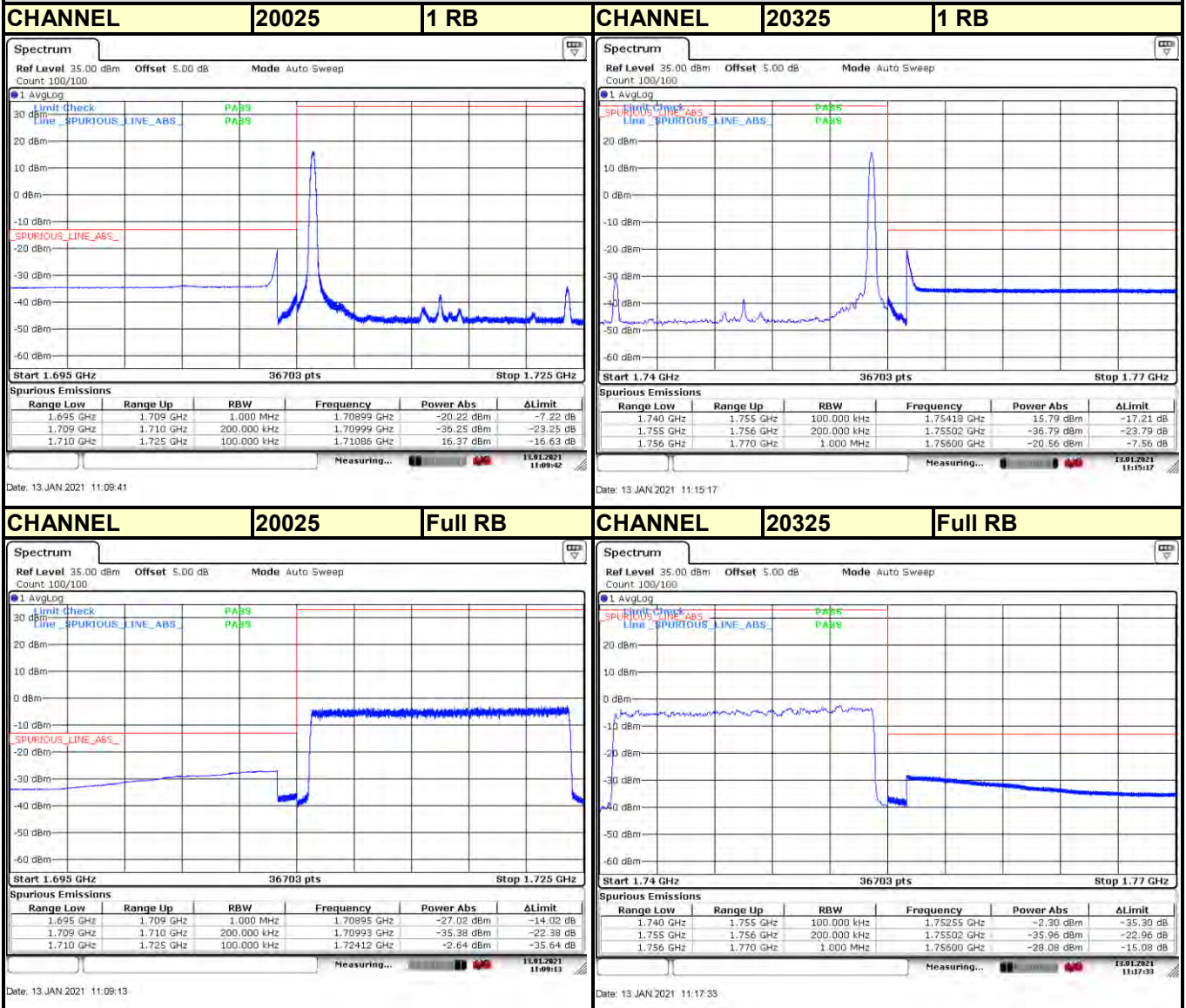



Channel Bandwidth: 15MHz 64QAM

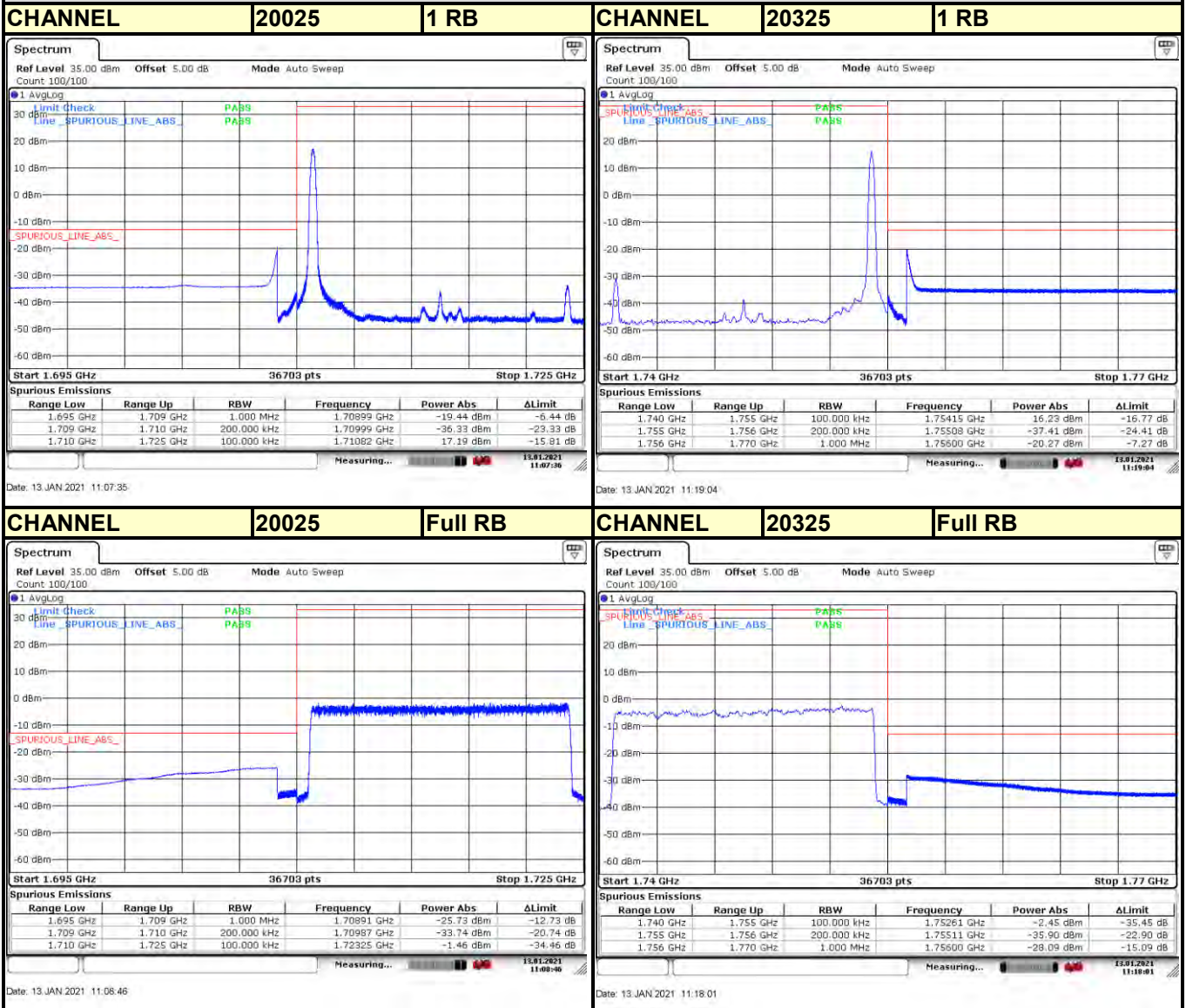



BUREAU VERITAS

Test Report No.: RFA20210104W001-6

LTE BAND 4

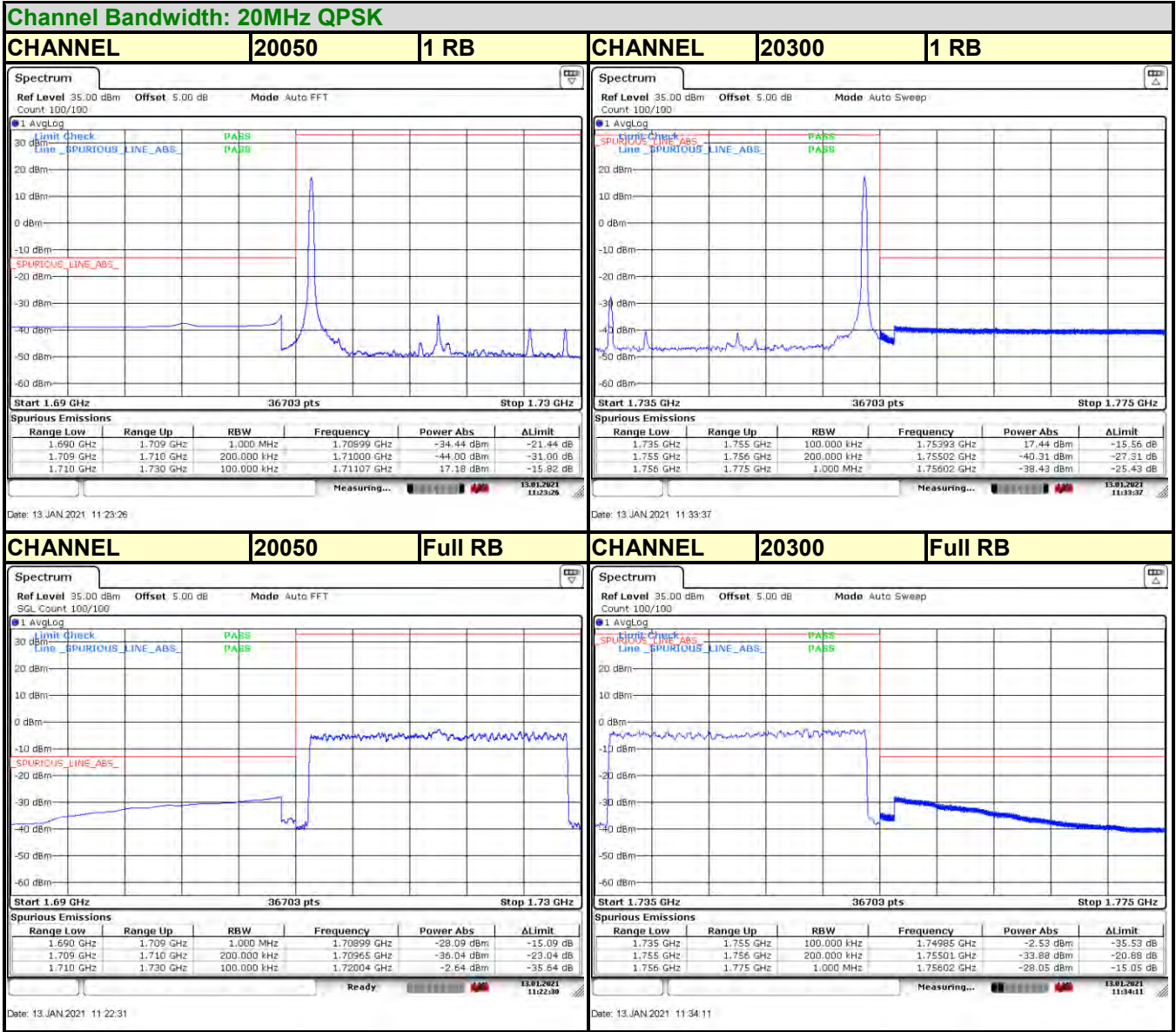



BUREAU VERITAS

Test Report No.: RFA20210104W001-6

Channel Bandwidth: 20MHz 16QAM

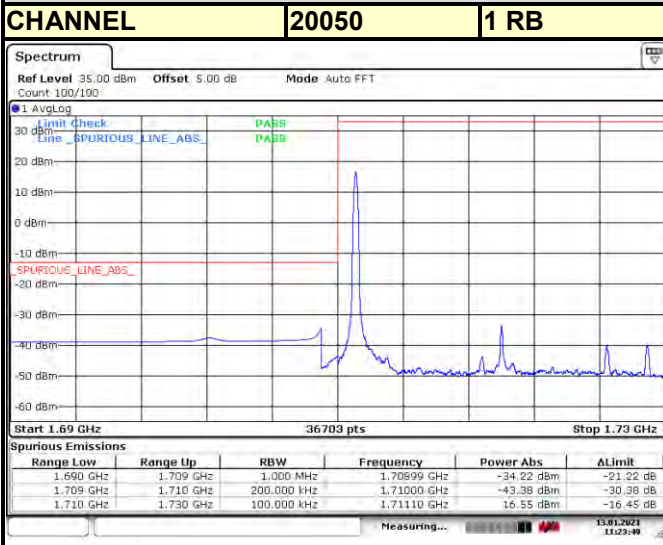

Date: 13 JAN 2021 11:23:49

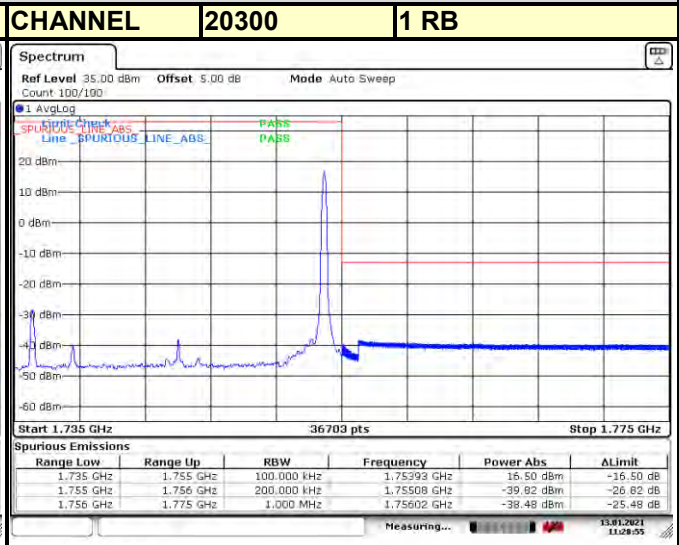

Date: 13 JAN 2021 11:28:55

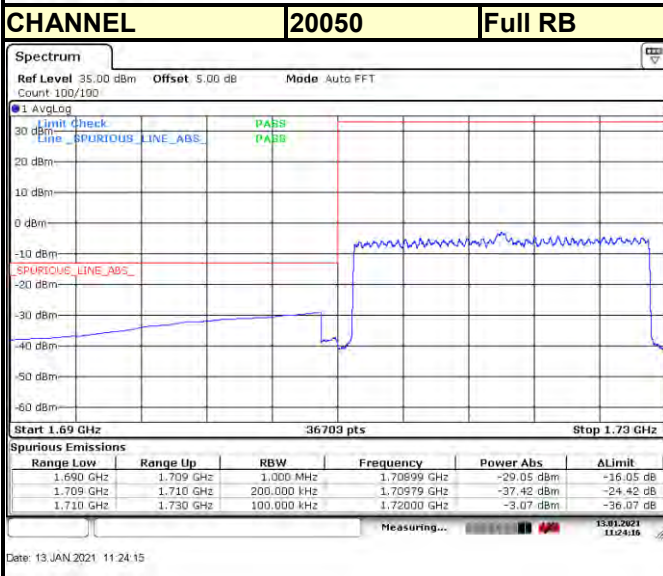

Date: 13 JAN 2021 11:24:15

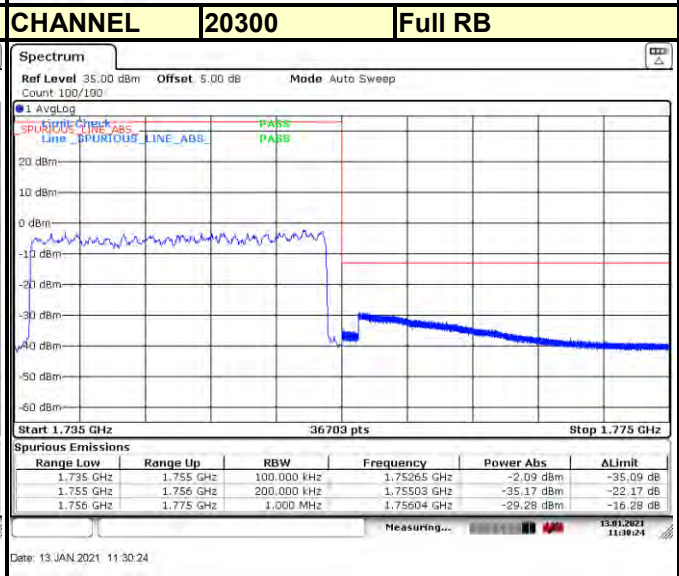

Date: 13 JAN 2021 11:30:24



Channel Bandwidth: 20MHz 64QAM

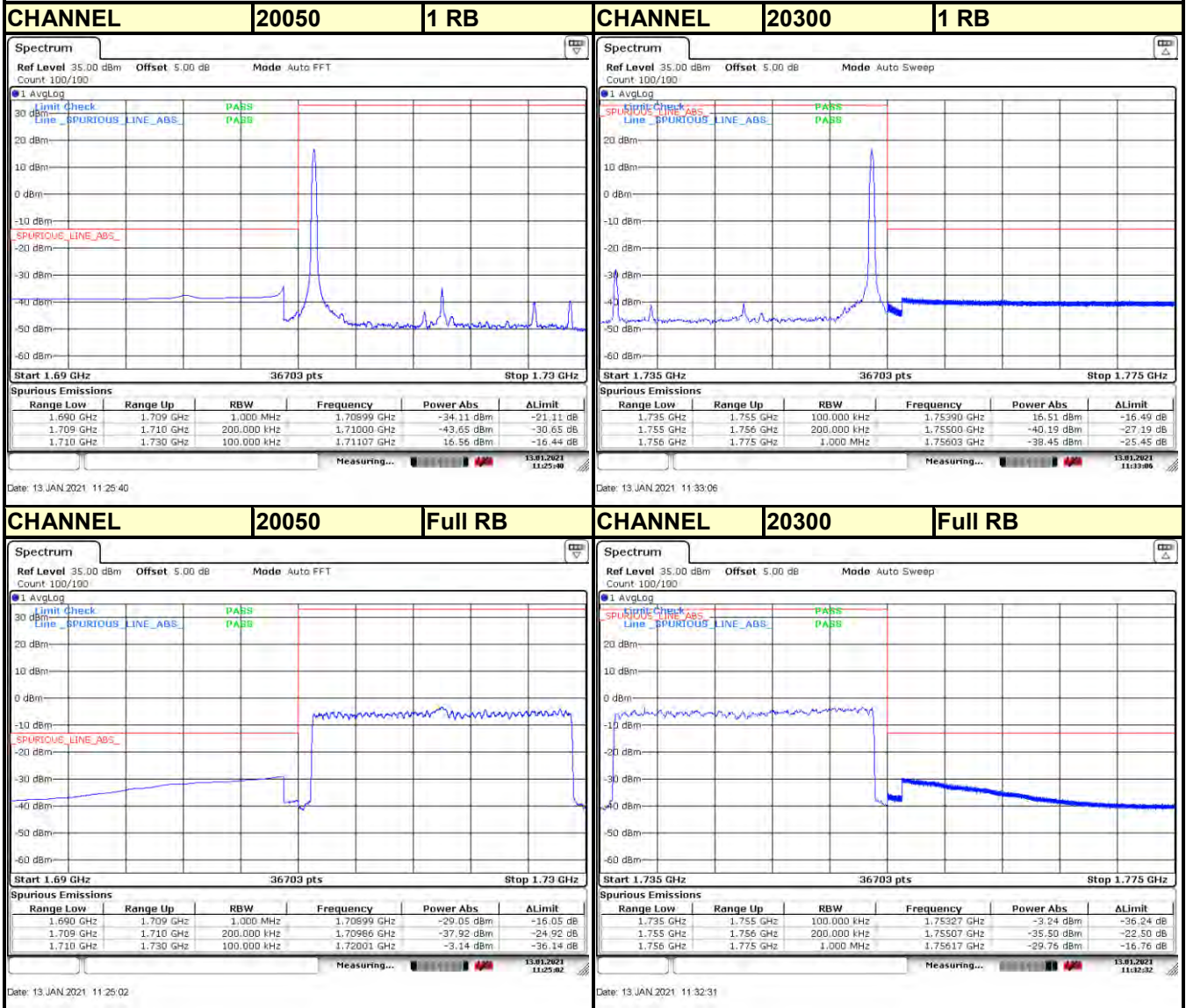

3.6 CONDUCTED SPURIOUS EMISSIONS

3.6.1 LIMITS OF CONDUCTED SPURIOUS EMISSIONS MEASUREMENT

The power of any emission outside a licensee's frequency block shall be attenuated below the transmitter power (P) by at least $43 + 10 \log_{10}(P)$ dB. The limit of emission equal to -13dBm

3.6.2 TEST PROCEDURE

- a. The EUT makes a phone call to the communication simulator. All measurements were done at middle operational frequency range.
- b. Measuring frequency range is from 30 MHz to 18GHz for WCDMA Band 4 & LTE Band 4, from 30 MHz to 7.2GHz for LTE Band 12, from 30 MHz to 7.9GHz for LTE Band 13. 10dB attenuation pad is connected with spectrum. RBW=1MHz and VBW=3MHz are used for conducted emission measurement.

3.6.3 TEST SETUP

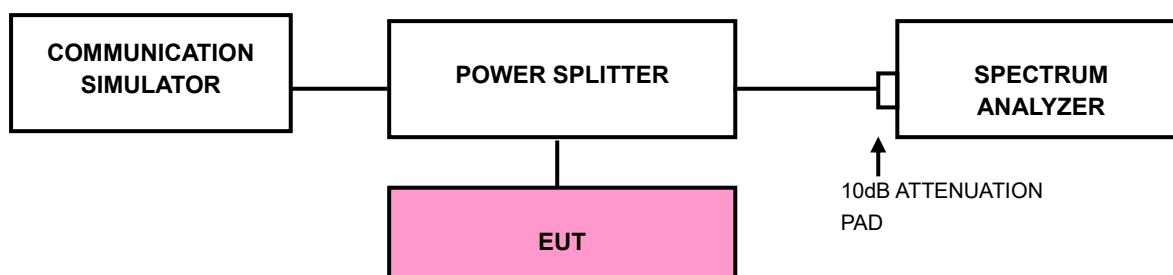

3.6.4 TEST RESULTS

LTE BAND 4





BUREAU VERITAS

Test Report No.: RFA20210104W001-6

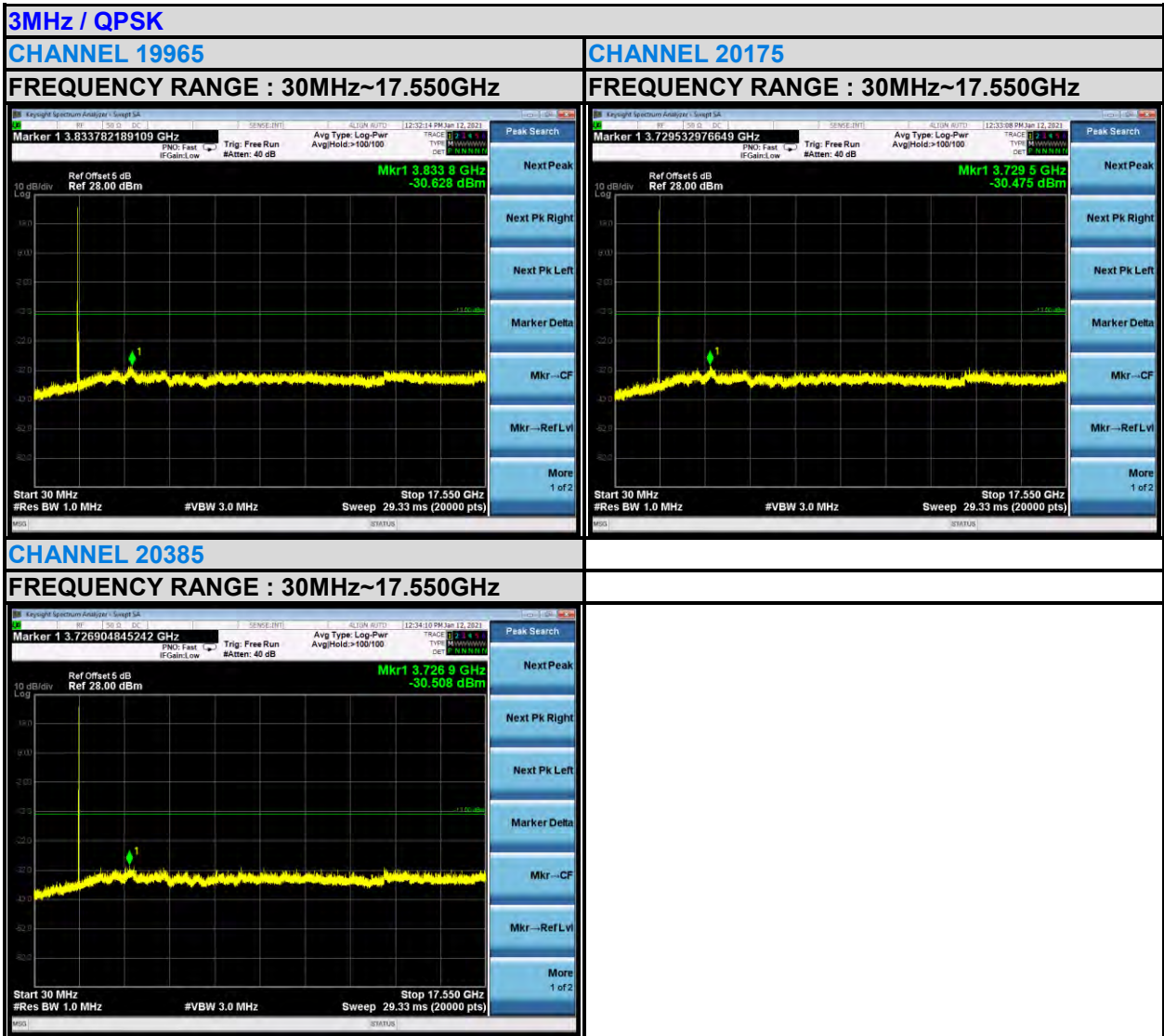



BUREAU VERITAS

Test Report No.: RFA20210104W001-6

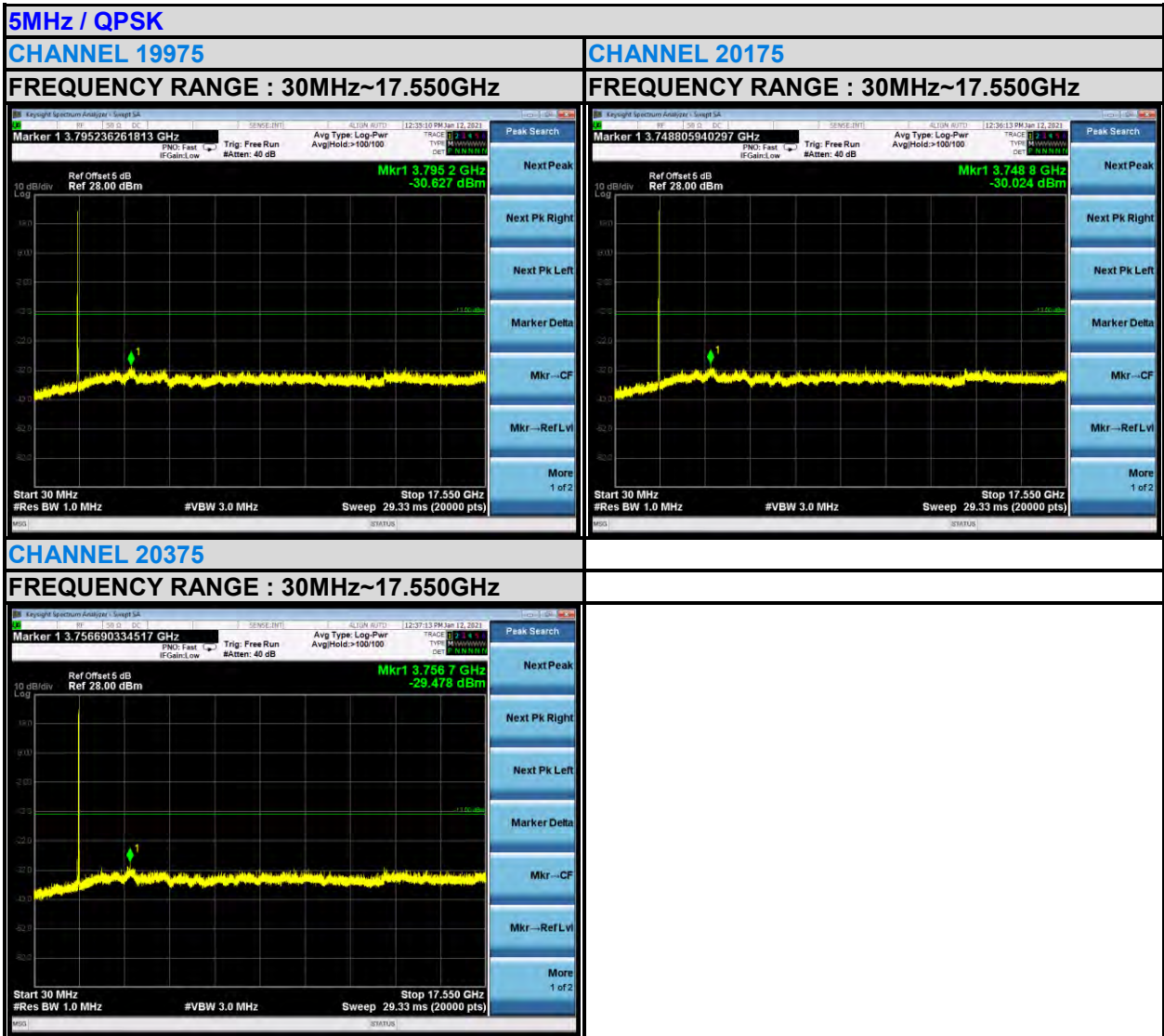



BUREAU VERITAS

Test Report No.: RFA20210104W001-6

10MHz / QPSK

CHANNEL 20000

FREQUENCY RANGE : 30MHz~17.550GHz

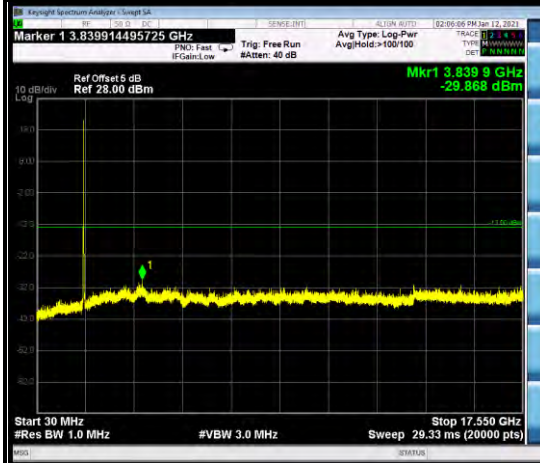

CHANNEL 20175

FREQUENCY RANGE : 30MHz~17.550GHz



CHANNEL 20350

FREQUENCY RANGE : 30MHz~17.550GHz

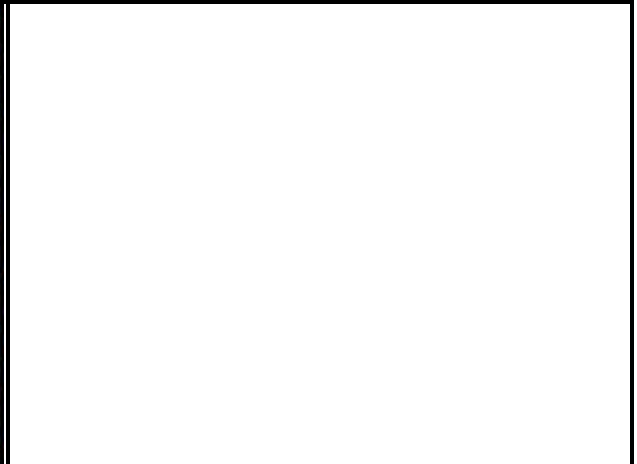
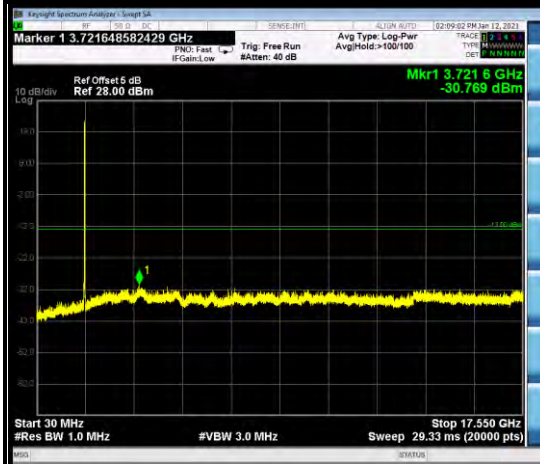



BUREAU VERITAS

Test Report No.: RFA20210104W001-6

15MHz / QPSK

CHANNEL 20025

FREQUENCY RANGE : 30MHz~17.550GHz

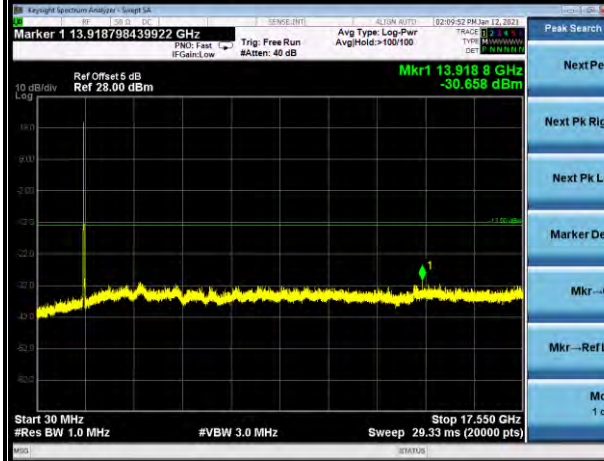

CHANNEL 20175

FREQUENCY RANGE : 30MHz~17.550GHz

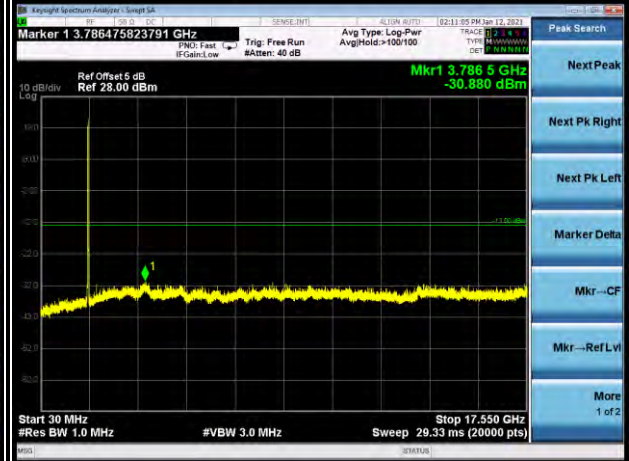

CHANNEL 20325

FREQUENCY RANGE : 30MHz~17.550GHz

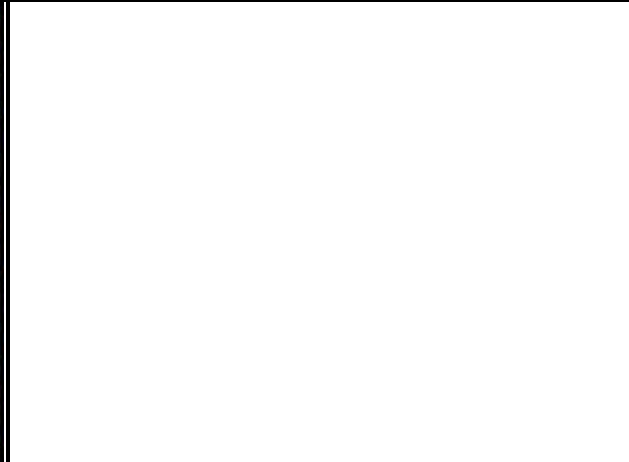
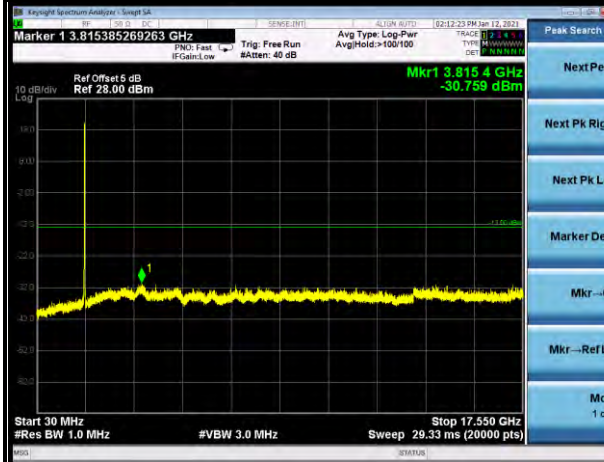



BUREAU VERITAS

Test Report No.: RFA20210104W001-6

20MHz / QPSK

CHANNEL 20050

FREQUENCY RANGE : 30MHz~17.550GHz

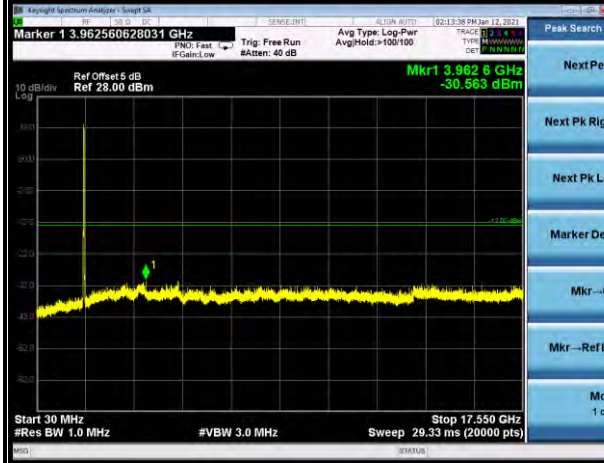

CHANNEL 20175

FREQUENCY RANGE : 30MHz~17.550GHz

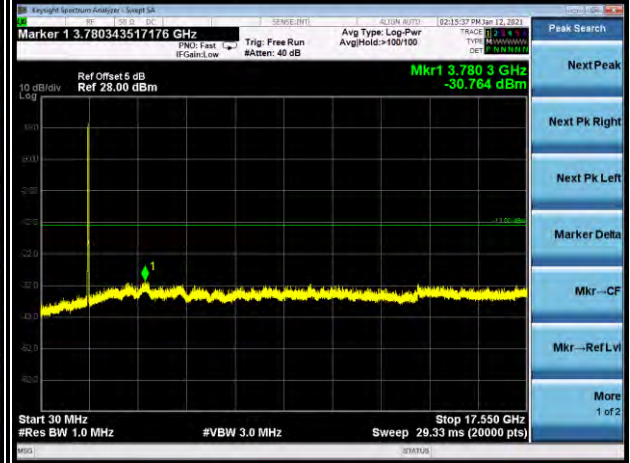

CHANNEL 20300

FREQUENCY RANGE : 30MHz~17.550GHz

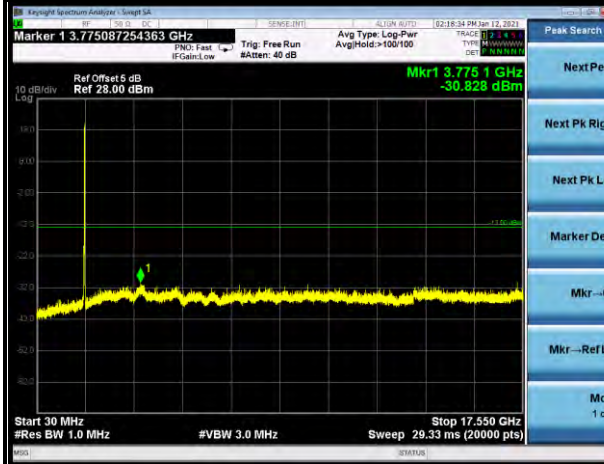



3.7 RADIATED EMISSION MEASUREMENT

3.7.1 LIMITS OF RADIATED EMISSION MEASUREMENT

The power of any emission outside a licensee's frequency block shall be attenuated below the transmitter power (P) by at least $43 + 10 \log_{10}(P)$ dB. The limit of emission equal to -13dBm

3.7.2 TEST PROCEDURES

- a. Substitution method is used for E.I.R.P measurement. In the semi-anechoic chamber, EUT placed on the 0.8m height of Turn Table, rotated the table around 360 degrees to search the maximum radiation power and receiver antenna shall be rotated vertical and horizontal polarization and moved height from 1m to 4m to find the maximum polar radiated power. The "Read Value" is the spectrum reading the maximum power value.
- b. The substitution horn antenna is substituted for EUT at the same position and signals generator export the CW signal to the substitution antenna via a TX cable. Rotated the Turn Table and moved receiving antenna to find the maximum radiation power. Adjust output power level of S.G to get a Value of spectrum reading equal to "Read Value" of step a. Record the power level of S.G
- c. $\text{EIRP} = \text{Output power level of S.G} - \text{TX cable loss} + \text{Antenna gain of substitution horn}$.
- d. E.R.P power can be calculated form E.I.R.P power by subtracting the gain of dipole, $\text{E.R.P power} = \text{E.I.P.R power} - 2.15\text{dBi}$.

NOTE: The resolution bandwidth of spectrum analyzer is 1 MHz and the video bandwidth is 3 MHz.

3.7.3 DEVIATION FROM TEST STANDARD

No deviation

3.7.4 TEST SETUP

< Frequency Range 30MHz~1GHz >

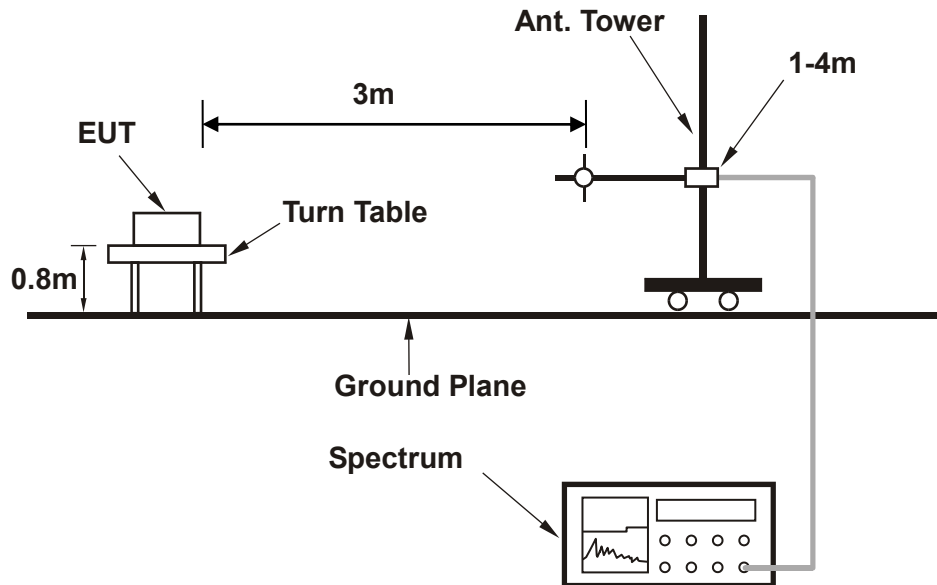

<Frequency Range above 1GHz>

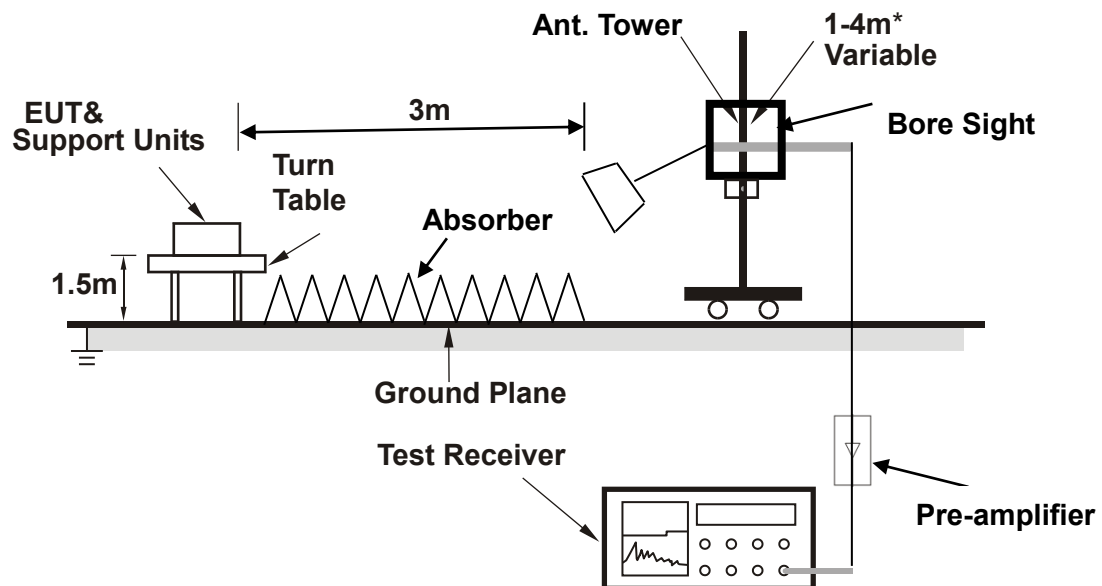

Note: Above 1G is a directional antenna

Depends on the EUT height and the antenna 3dB beamwidth both, refer to section 7.3 of CISPR 16-2-3.

For the actual test configuration, please refer to the attached file (Test Setup Photo).



3.7.5 TEST RESULTS

BELOW 1GHz WORST-CASE DATA

30 MHz – 1GHz data:

LTE BAND 4

CHANNEL BANDWIDTH: 5MHz / QPSK

MODE	TX channel 20175	FREQUENCY RANGE	Below 1000MHz
ENVIRONMENTAL CONDITIONS	23deg. C, 70%RH	INPUT POWER	DC 5V from adapter
TESTED BY	Jace Hu		
ANTENNA POLARITY & TEST DISTANCE: HORIZONTAL AT 3 M			

	Freq	Level	Read Level	Limit Line	Over Limit	Factor	Remark	Pol/Phase	
	MHz	dBm/m	dBm	dBm/m	dB	dB/m			
1	PP	30.000	-28.65	-47.99	-13.00	-15.65	19.34	Peak	Horizontal
2		96.930	-62.88	-52.37	-13.00	-49.88	-10.51	Peak	Horizontal
3		167.740	-59.61	-41.41	-13.00	-46.61	-18.20	Peak	Horizontal
4		197.810	-57.89	-40.60	-13.00	-44.89	-17.29	Peak	Horizontal
5		272.500	-54.84	-39.67	-13.00	-41.84	-15.17	Peak	Horizontal
6		343.310	-66.61	-54.25	-13.00	-53.61	-12.36	Peak	Horizontal

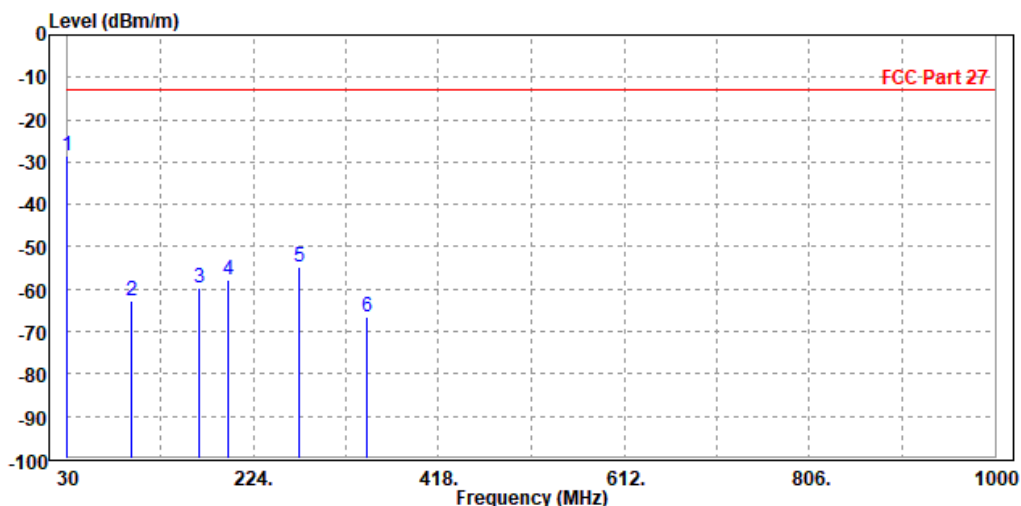



Test Report No.: RFA20210104W001-6

MODE	TX channel 20175	FREQUENCY RANGE	Below 1000MHz
ENVIRONMENTAL CONDITIONS	23deg. C, 70%RH	INPUT POWER	DC 5V from adapter
TESTED BY	Jace Hu		
ANTENNA POLARITY & TEST DISTANCE: VERTICAL AT 3 M			

	Freq	Level	Read Level	Limit Line	Over Limit	Factor	Remark	Pol/Phase
	MHz	dBm/m	dBm	dBm/m	dB	dB/m		
1 PP	40.670	-49.62	-48.09	-13.00	-36.62	-1.53	Peak	Vertical
2	80.440	-61.37	-51.11	-13.00	-48.37	-10.26	Peak	Vertical
3	167.740	-59.85	-45.39	-13.00	-46.85	-14.46	Peak	Vertical
4	201.690	-58.27	-47.61	-13.00	-45.27	-10.66	Peak	Vertical
5	271.530	-58.72	-47.30	-13.00	-45.72	-11.42	Peak	Vertical
6	399.570	-63.34	-52.40	-13.00	-50.34	-10.94	Peak	Vertical

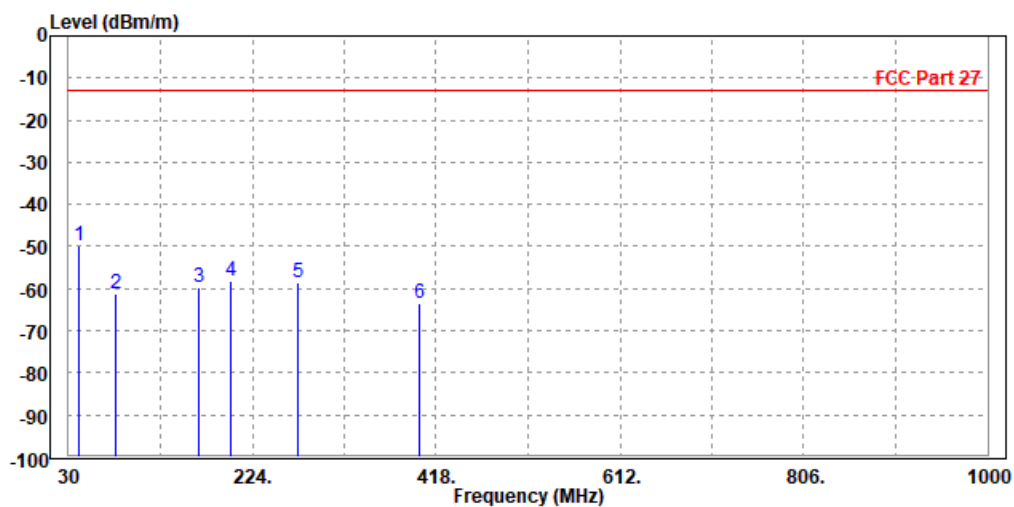



Test Report No.: RFA20210104W001-6

ABOVE 1GHz

Note: For higher frequency, the emission is too low to be detected.

WORST-CASE DATA

LTE BAND 4

CHANNEL BANDWIDTH: 1.4MHz / QPSK

CH 19957

MODE	TX channel 19957	FREQUENCY RANGE	Above 1000MHz
ENVIRONMENTAL CONDITIONS	23deg. C, 70%RH	INPUT POWER	DC 5V from adapter
TESTED BY	Jace Hu		
ANTENNA POLARITY & TEST DISTANCE: HORIZONTAL AT 3 M			

	Freq	Level	Read Level	Limit Line	Over Limit	Factor	Remark	Pol/Phase
	MHz	dBm/m	dBm	dBm/m	dB	dB/m		
1	PP 3418.000	-47.34	-55.93	-13.00	-34.34	8.59	Peak	Horizontal
2	5132.100	-48.08	-57.00	-13.00	-35.08	8.92	Peak	Horizontal

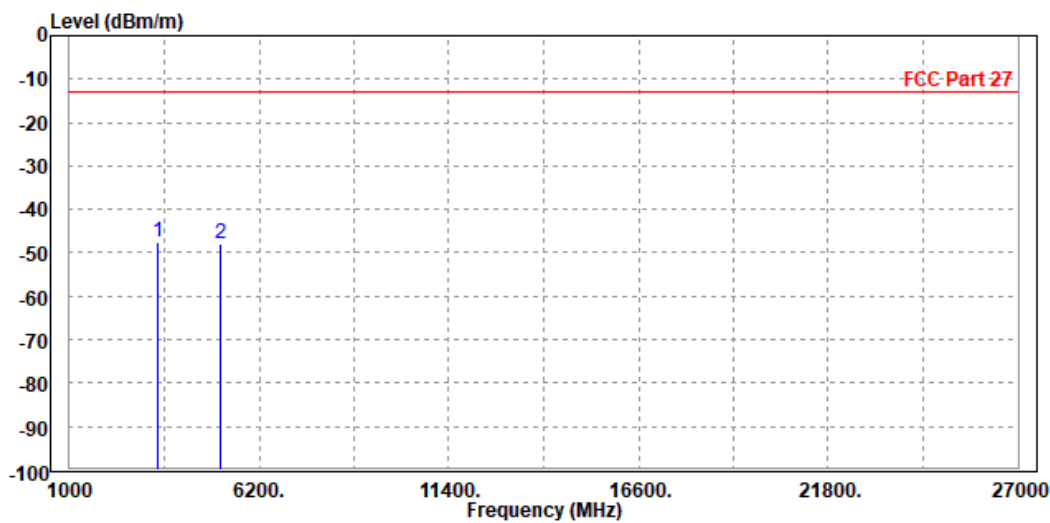



Test Report No.: RFA20210104W001-6

MODE	TX channel 19957	FREQUENCY RANGE	Above 1000MHz
ENVIRONMENTAL CONDITIONS	23deg. C, 70%RH	INPUT POWER	DC 5V from adapter
TESTED BY	Jace Hu		
ANTENNA POLARITY & TEST DISTANCE: VERTICAL AT 3 M			

	Freq	Level	Read Level	Limit Line	Over Limit	Factor	Remark	Pol/Phase
	MHz	dBm/m	dBm	dBm/m	dB	dB/m		
1	PP 3418.000	-43.59	-52.70	-13.00	-30.59	9.11	Peak	Vertical
2	5132.100	-46.69	-56.54	-13.00	-33.69	9.85	Peak	Vertical

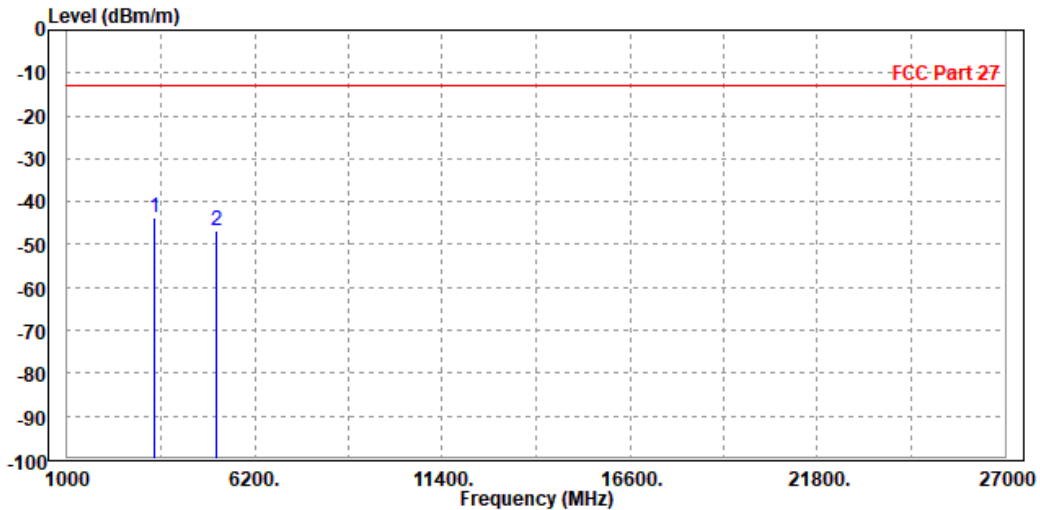



Test Report No.: RFA20210104W001-6

CH 20175

MODE	TX channel 20175	FREQUENCY RANGE	Above 1000MHz
ENVIRONMENTAL CONDITIONS	23deg. C, 70%RH	INPUT POWER	DC 5V from adapter
TESTED BY	Jace Hu		
ANTENNA POLARITY & TEST DISTANCE: HORIZONTAL AT 3 M			

	Freq	Level	Read Level	Limit Line	Over Limit	Factor	Remark	Pol/Phase
	MHz	dBm/m	dBm	dBm/m	dB	dB/m		
1	3470.000	-47.73	-56.31	-13.00	-34.73	8.58	Peak	Horizontal
2 PP	5197.500	-47.50	-56.62	-13.00	-34.50	9.12	Peak	Horizontal

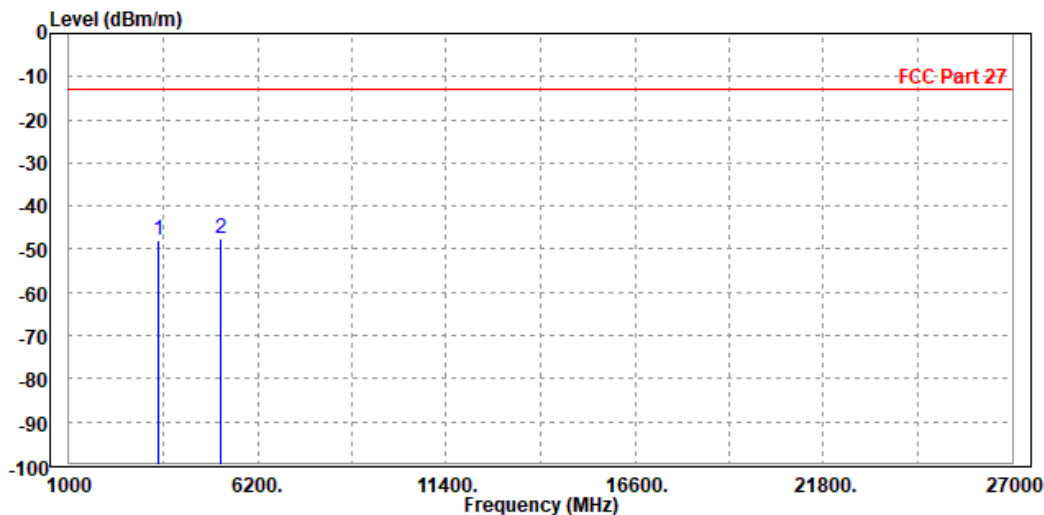



Test Report No.: RFA20210104W001-6

MODE	TX channel 20175	FREQUENCY RANGE	Above 1000MHz
ENVIRONMENTAL CONDITIONS	23deg. C, 70%RH	INPUT POWER	DC 5V from adapter
TESTED BY	Jace Hu		
ANTENNA POLARITY & TEST DISTANCE: VERTICAL AT 3 M			

	Freq	Level	Read Level	Limit Line	Over Limit	Factor	Remark	Pol/Phase
	MHz	dBm/m	dBm	dBm/m	dB	dB/m		
1 PP	3470.000	-46.20	-55.36	-13.00	-33.20	9.16	Peak	Vertical
2	5197.500	-48.40	-58.22	-13.00	-35.40	9.82	Peak	Vertical

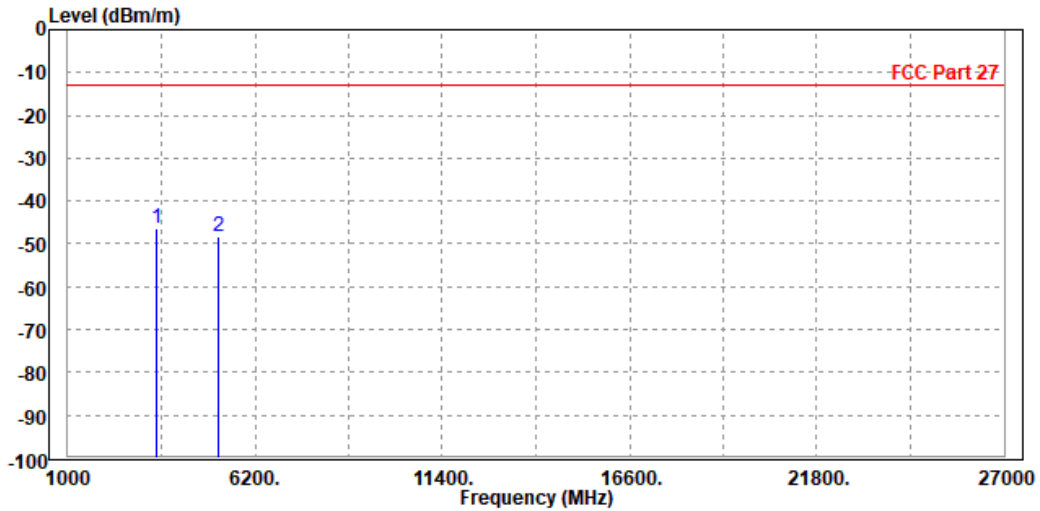



Test Report No.: RFA20210104W001-6

CH 20393

MODE	TX channel 20393	FREQUENCY RANGE	Above 1000MHz
ENVIRONMENTAL CONDITIONS	23deg. C, 70%RH	INPUT POWER	DC 5V from adapter
TESTED BY	Jace Hu		
ANTENNA POLARITY & TEST DISTANCE: HORIZONTAL AT 3 M			

	Freq	Level	Read Level	Limit Line	Over Limit	Factor	Remark	Pol/Phase
	MHz	dBm/m	dBm	dBm/m	dB	dB/m		
1 PP	3496.000	-46.18	-54.75	-13.00	-33.18	8.57	Peak	Horizontal
2	5262.900	-48.85	-58.16	-13.00	-35.85	9.31	Peak	Horizontal

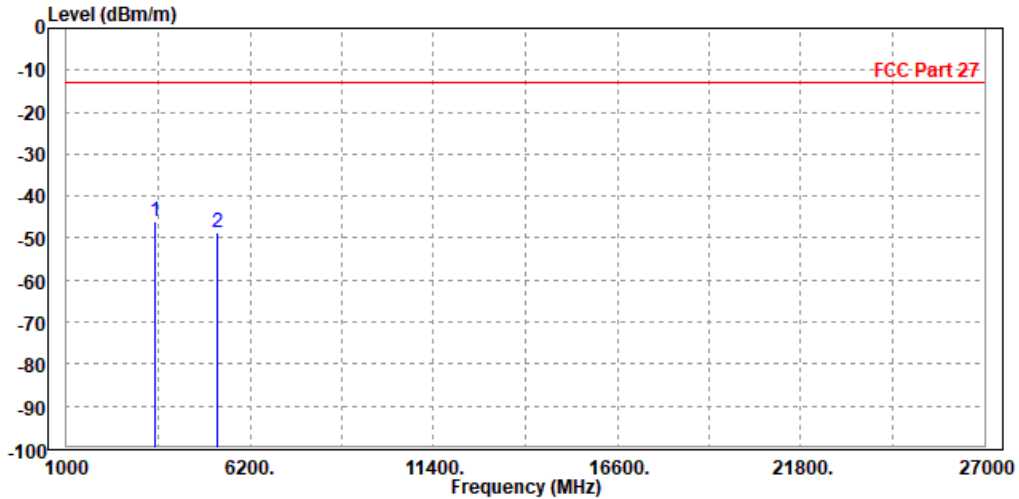



Test Report No.: RFA20210104W001-6

MODE	TX channel 20393	FREQUENCY RANGE	Above 1000MHz
ENVIRONMENTAL CONDITIONS	23deg. C, 70%RH	INPUT POWER	DC 5V from adapter
TESTED BY	Jace Hu		
ANTENNA POLARITY & TEST DISTANCE: VERTICAL AT 3 M			

	Freq	Level	Read Level	Limit Line	Over Limit	Factor	Remark	Pol/Phase
	MHz	dBm/m	dBm	dBm/m	dB	dB/m		
1	PP 3496.000	-43.24	-52.43	-13.00	-30.24	9.19	Peak	Vertical
2	5262.900	-48.62	-58.42	-13.00	-35.62	9.80	Peak	Vertical

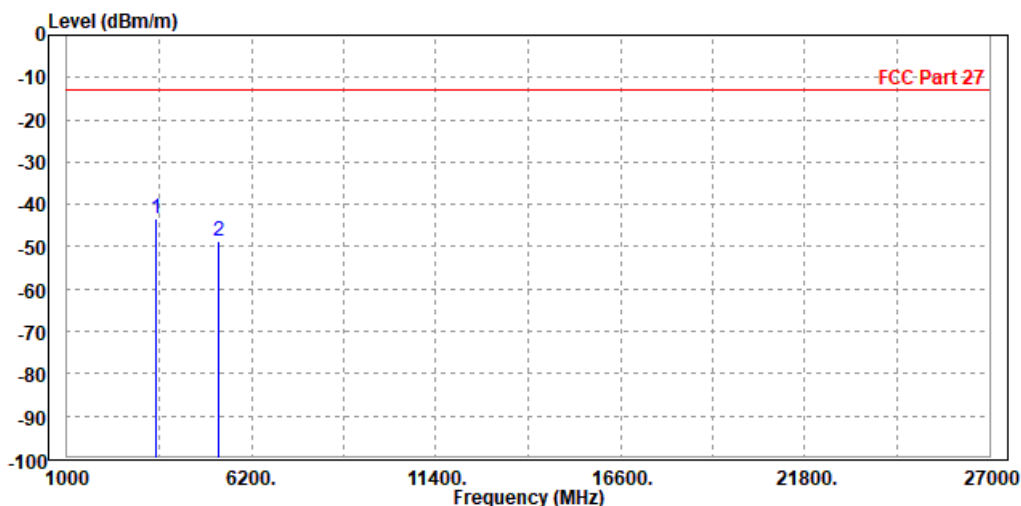



**BUREAU
VERITAS**

Test Report No.: RFA20210104W001-6

CHANNEL BANDWIDTH: 3MHz / QPSK

MODE	TX channel 20175	FREQUENCY RANGE	Above 1000MHz
ENVIRONMENTAL CONDITIONS	23deg. C, 70%RH	INPUT POWER	DC 5V from adapter
TESTED BY	Jace Hu		
ANTENNA POLARITY & TEST DISTANCE: HORIZONTAL AT 3 M			

	Freq	Level	Read Level	Limit Line	Over Limit	Factor	Remark	Pol/Phase
	MHz	dBm/m	dBm	dBm/m	dB	dB/m		
1	PP 3470.000	-47.53	-56.11	-13.00	-34.53	8.58	Peak	Horizontal
2	5197.500	-48.94	-58.06	-13.00	-35.94	9.12	Peak	Horizontal

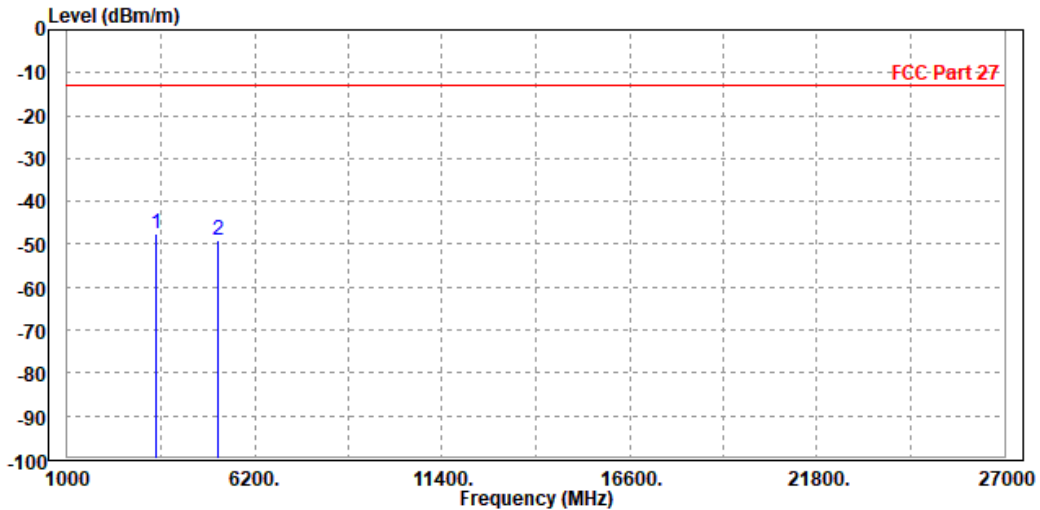



Test Report No.: RFA20210104W001-6

MODE	TX channel 20175	FREQUENCY RANGE	Above 1000MHz
ENVIRONMENTAL CONDITIONS	23deg. C, 70%RH	INPUT POWER	DC 5V from adapter
TESTED BY	Jace Hu		
ANTENNA POLARITY & TEST DISTANCE: VERTICAL AT 3 M			

	Freq	Level	Read Level	Limit Line	Over Limit	Factor	Remark	Pol/Phase
	MHz	dBm/m	dBm	dBm/m	dB	dB/m		
1	PP 3470.000	-47.24	-56.40	-13.00	-34.24	9.16	Peak	Vertical
2	5197.500	-47.92	-57.74	-13.00	-34.92	9.82	Peak	Vertical

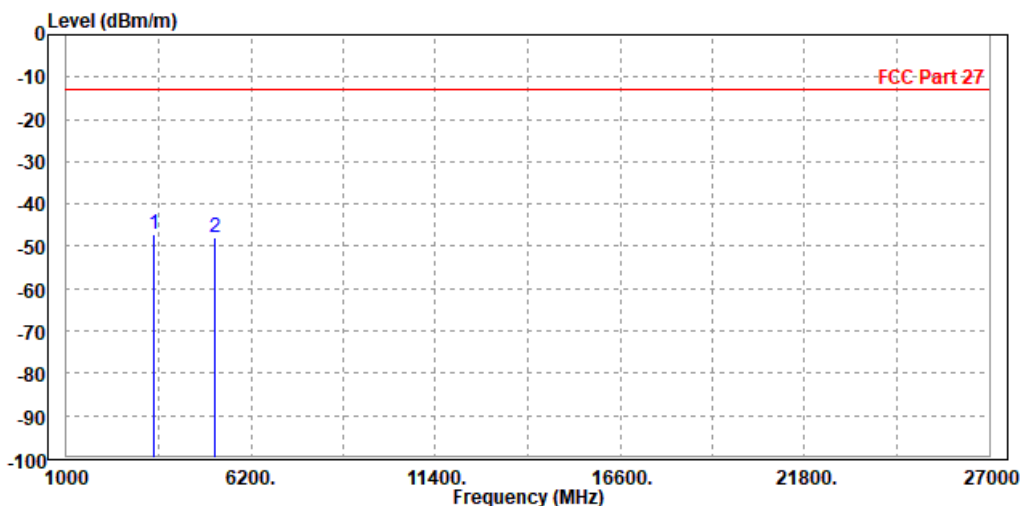



BUREAU VERITAS

Test Report No.: RFA20210104W001-6

CHANNEL BANDWIDTH: 5MHz / QPSK

MODE	TX channel 20175	FREQUENCY RANGE	Above 1000MHz
ENVIRONMENTAL CONDITIONS	23deg. C, 70%RH	INPUT POWER	DC 5V from adapter
TESTED BY	Jace Hu		
ANTENNA POLARITY & TEST DISTANCE: HORIZONTAL AT 3 M			

	Freq	Level	Read Level	Limit Line	Over Limit	Factor	Remark	Pol/Phase
	MHz	dBm/m	dBm	dBm/m	dB	dB/m		
1	3470.000	-47.81	-56.39	-13.00	-34.81	8.58	Peak	Horizontal
2 PP	5197.500	-47.20	-56.32	-13.00	-34.20	9.12	Peak	Horizontal

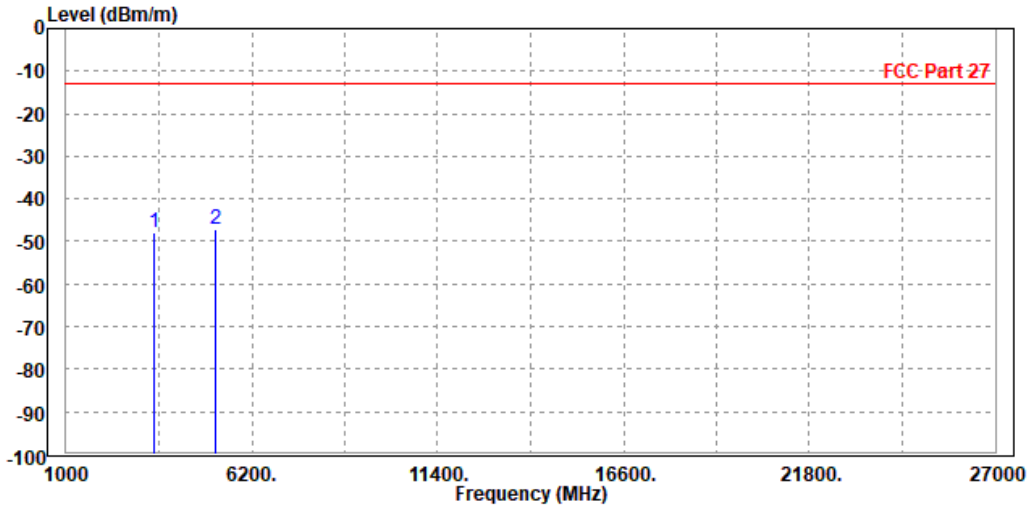



Test Report No.: RFA20210104W001-6

MODE	TX channel 20175	FREQUENCY RANGE	Above 1000MHz
ENVIRONMENTAL CONDITIONS	23deg. C, 70%RH	INPUT POWER	DC 5V from adapter
TESTED BY	Jace Hu		
ANTENNA POLARITY & TEST DISTANCE: VERTICAL AT 3 M			

	Read	Limit	Over				
Freq	Level	Level	Line	Limit	Factor	Remark	Pol/Phase
MHz	dBm/m	dBm	dBm/m	dB	dB/m		
1 PP 3470.000	-46.29	-55.45	-13.00	-33.29	9.16	Peak	Vertical
2 5197.500	-47.82	-57.64	-13.00	-34.82	9.82	Peak	Vertical

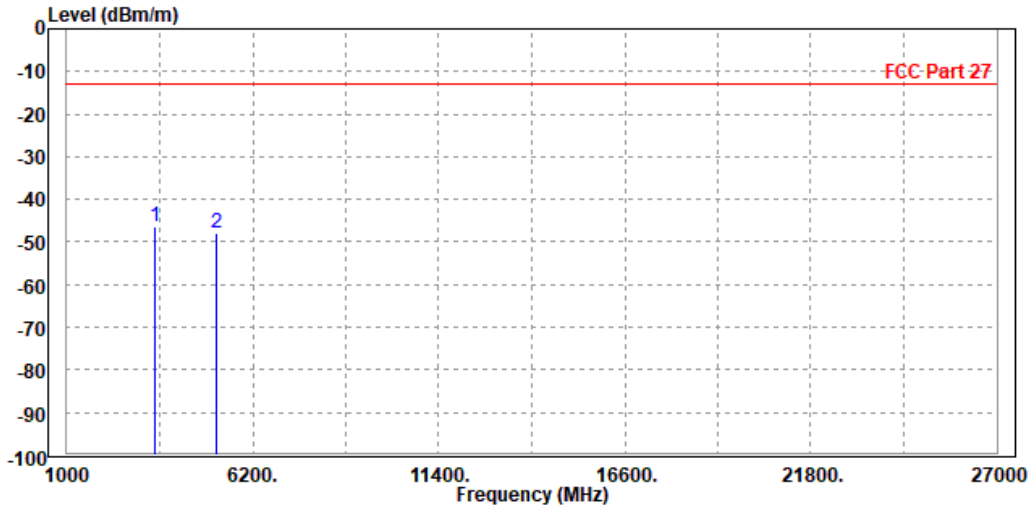



Test Report No.: RFA20210104W001-6

CHANNEL BANDWIDTH: 10MHz / QPSK

MODE	TX channel 20175	FREQUENCY RANGE	Above 1000MHz
ENVIRONMENTAL CONDITIONS	23deg. C, 70%RH	INPUT POWER	DC 5V from adapter
TESTED BY	Jace Hu		
ANTENNA POLARITY & TEST DISTANCE: HORIZONTAL AT 3 M			

	Freq	Level	Read Level	Limit Line	Over Limit	Factor	Remark	Pol/Phase
	MHz	dBm/m	dBm	dBm/m	dB	dB/m		
1	PP 3470.000	-47.82	-56.40	-13.00	-34.82	8.58	Peak	Horizontal
2	5197.500	-48.44	-57.56	-13.00	-35.44	9.12	Peak	Horizontal

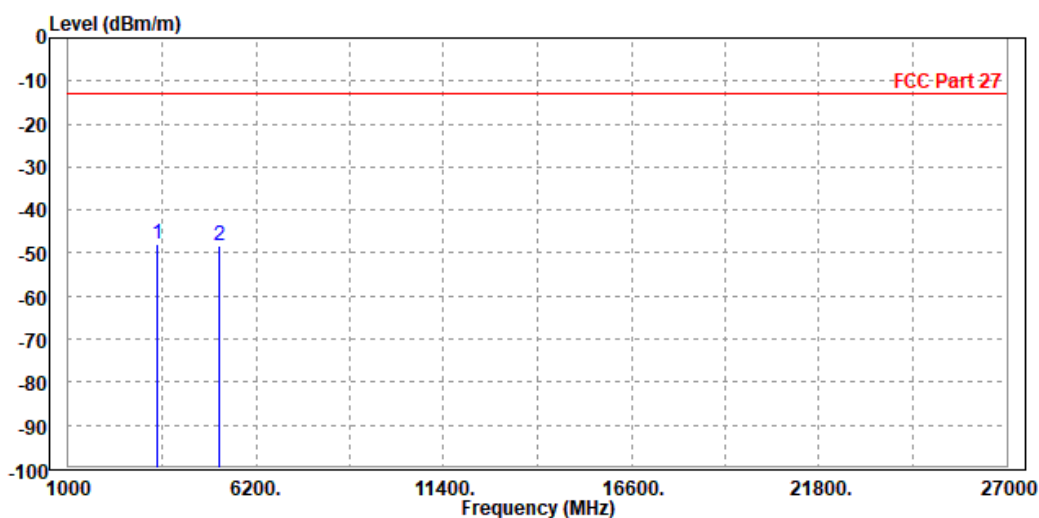



Test Report No.: RFA20210104W001-6

MODE	TX channel 20175	FREQUENCY RANGE	Above 1000MHz
ENVIRONMENTAL CONDITIONS	23deg. C, 70%RH	INPUT POWER	DC 5V from adapter
TESTED BY	Jace Hu		
ANTENNA POLARITY & TEST DISTANCE: VERTICAL AT 3 M			

	Freq	Level	Read Level	Limit Line	Over Limit	Factor	Remark	Pol/Phase
	MHz	dBm/m	dBm	dBm/m	dB	dB/m		
1	PP 3470.000	-46.96	-56.12	-13.00	-33.96	9.16	Peak	Vertical
2	5197.500	-48.03	-57.85	-13.00	-35.03	9.82	Peak	Vertical

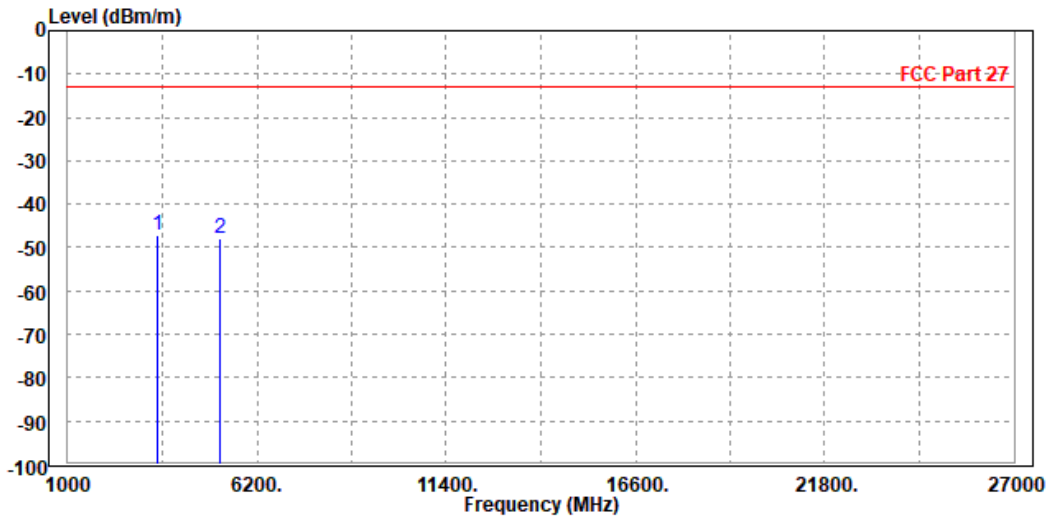



Test Report No.: RFA20210104W001-6

CHANNEL BANDWIDTH: 15MHz / QPSK

MODE	TX channel 20175	FREQUENCY RANGE	Above 1000MHz
ENVIRONMENTAL CONDITIONS	23deg. C, 70%RH	INPUT POWER	DC 5V from adapter
TESTED BY	Jace Hu		
ANTENNA POLARITY & TEST DISTANCE: HORIZONTAL AT 3 M			

	Freq	Read Level	Limit Level	Over Limit	Factor	Remark	Pol/Phase
	MHz	dBm/m	dBm	dBm/m	dB	dB/m	
1 PP	3470.000	-47.39	-55.97	-13.00	-34.39	8.58 Peak	Horizontal
2	5197.500	-48.85	-57.97	-13.00	-35.85	9.12 Peak	Horizontal

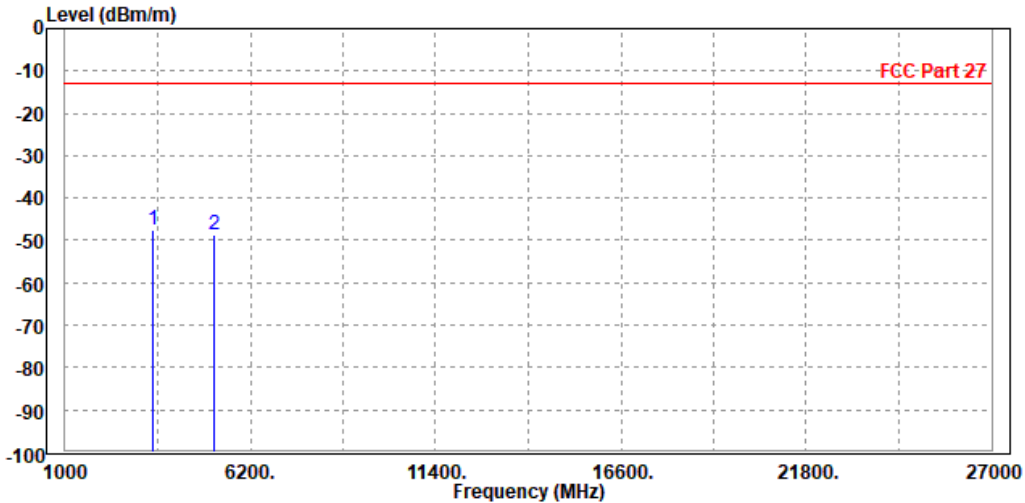



Test Report No.: RFA20210104W001-6

MODE	TX channel 20175	FREQUENCY RANGE	Above 1000MHz
ENVIRONMENTAL CONDITIONS	23deg. C, 70%RH	INPUT POWER	DC 5V from adapter
TESTED BY	Jace Hu		
ANTENNA POLARITY & TEST DISTANCE: VERTICAL AT 3 M			

	Freq	Level	Read Level	Limit Line	Over Limit	Factor	Remark	Pol/Phase
	MHz	dBm/m	dBm	dBm/m	dB	dB/m		
1	PP 3470.000	-47.07	-56.23	-13.00	-34.07	9.16	Peak	Vertical
2	5197.500	-48.23	-58.05	-13.00	-35.23	9.82	Peak	Vertical

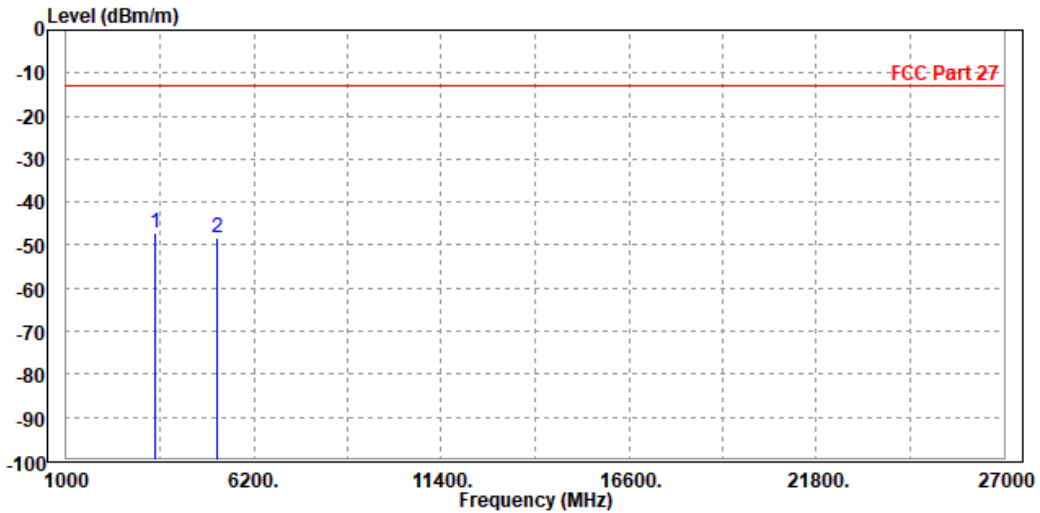



Test Report No.: RFA20210104W001-6

CHANNEL BANDWIDTH: 20MHz / QPSK

MODE	TX channel 20175	FREQUENCY RANGE	Above 1000MHz
ENVIRONMENTAL CONDITIONS	23deg. C, 70%RH	INPUT POWER	DC 5V from adapter
TESTED BY	Jace Hu		
ANTENNA POLARITY & TEST DISTANCE: HORIZONTAL AT 3 M			

	Freq	Level	Read Level	Limit Line	Over Limit	Factor	Remark	Pol/Phase
	MHz	dBm/m	dBm	dBm/m	dB	dB/m		
1	PP 3470.000	-47.62	-56.20	-13.00	-34.62	8.58	Peak	Horizontal
2	5197.500	-48.14	-57.26	-13.00	-35.14	9.12	Peak	Horizontal

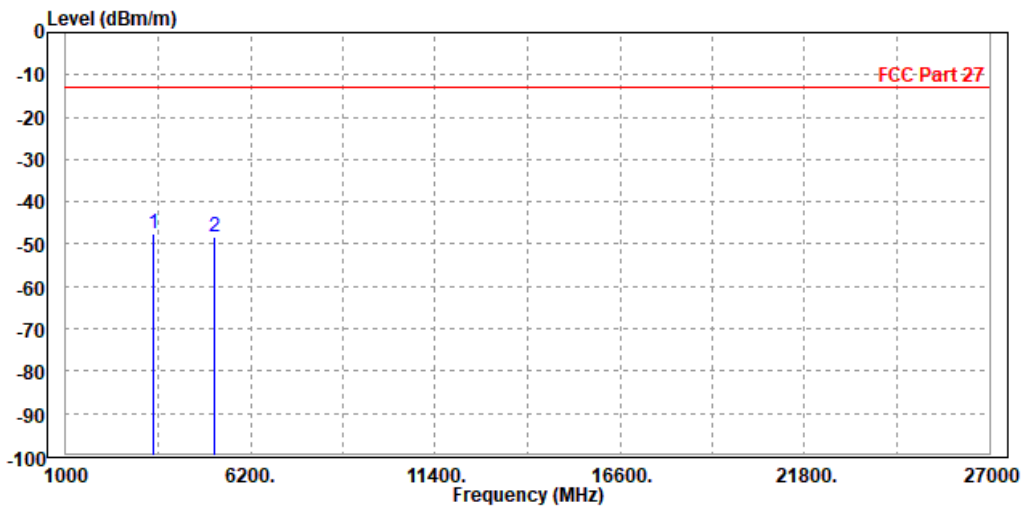



Test Report No.: RFA20210104W001-6

MODE	TX channel 20175	FREQUENCY RANGE	Above 1000MHz
ENVIRONMENTAL CONDITIONS	23deg. C, 70%RH	INPUT POWER	DC 5V from adapter
TESTED BY	Jace Hu		
ANTENNA POLARITY & TEST DISTANCE: VERTICAL AT 3 M			

	Freq	Level	Read Level	Limit Line	Over Limit	Factor	Remark	Pol/Phase
	MHz	dBm/m	dBm	dBm/m	dB	dB/m		
1	3470.000	-47.63	-56.79	-13.00	-34.63	9.16	Peak	Vertical
2 PP	5197.500	-47.58	-57.40	-13.00	-34.58	9.82	Peak	Vertical

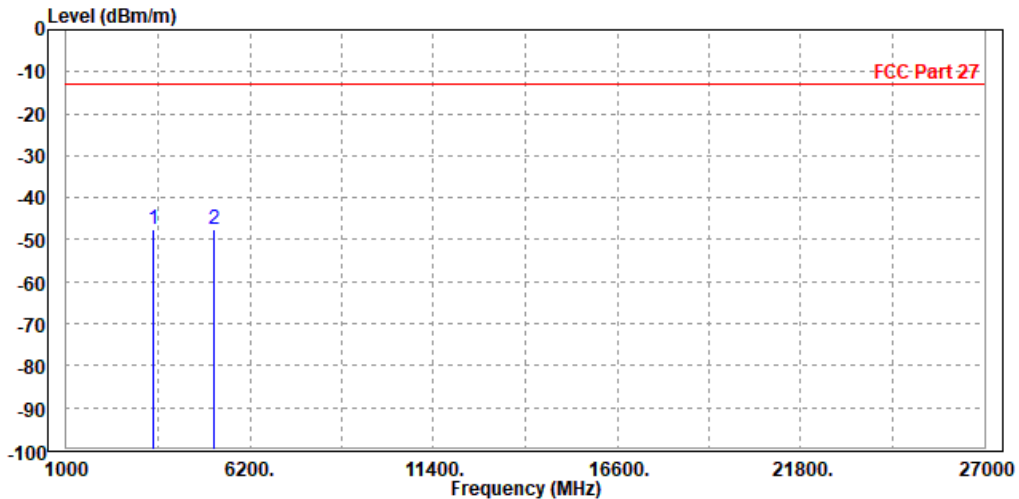



Test Report No.: RFA20210104W001-6

4 INFORMATION ON THE TESTING LABORATORIES

We, BV 7LAYERS COMMUNICATIONS TECHNOLOGY (SHENZHEN) CO. LTD., were founded in 2015 to provide our best service in EMC, Radio, Telecom and Safety consultation. Our laboratories are accredited and approved according to ISO/IEC 17025.

If you have any comments, please feel free to contact us at the following:

Shenzhen EMC/RF Lab:

Tel: +86-755-88696566

Fax: +86-755-88696577

Email: customerservice.dg@cn.bureauveritas.com

Web Site: www.adt.com.tw

The address and road map of all our labs can be found in our web site also.



Test Report No.: RFA20210104W001-6

5 APPENDIX A – MODIFICATIONS RECORDERS FOR ENGINEERING CHANGES TO THE EUT BY THE LAB

No modifications were made to the EUT by the lab during the test.

---END---