



# SAR TEST REPORT

No. I17Z61109-SEM02

For

**Lenovo PC HK Limited**

**Portable Tablet Computer**

**Model Name: Lenovo TB-7304X**

With

**Hardware Version: Lenovo Tablet TB-7304X**

**Software Version: TB-7304X\_RF01\_170728\_ROW**

**FCC ID: O57TB7304X**

**Issued Date: 2017-8-21**



**Note:**

The test results in this test report relate only to the devices specified in this report. This report shall not be reproduced except in full without the written approval of CTTL.

The report must not be used by the client to claim product certification, approval, or endorsement by NVLAP, NIST, or any agency of the U.S. Government.

**Test Laboratory:**

CTTL, Telecommunication Technology Labs, CAICT

No. 52, Huayuan North Road, Haidian District, Beijing, P. R. China 100191.

Tel:+86(0)10-62304633-2512, Fax:+86(0)10-62304633-2504

Email: [ctl\\_terminals@caict.ac.cn](mailto:ctl_terminals@caict.ac.cn), website: [www.caict.ac.cn](http://www.caict.ac.cn)



## **REPORT HISTORY**

<b>Report Number</b>	<b>Revision</b>	<b>Issue Date</b>	<b>Description</b>
I17Z61109-SEM02	Rev.0	2017-8-16	Initial creation of test report
I17Z61109-SEM02	Rev.1	2017-8-18	Update the description of the division factors in page27
I17Z61109-SEM02	Rev.2	2017-8-21	Remove the tissue parameter and system validation for of 1750MHz frequency

## TABLE OF CONTENT

<b>1</b>	<b>TEST LABORATORY</b> .....	<b>5</b>
1.1	TESTING LOCATION .....	5
1.2	TESTING ENVIRONMENT.....	5
1.3	PROJECT DATA.....	5
1.4	SIGNATURE.....	5
<b>2</b>	<b>STATEMENT OF COMPLIANCE</b> .....	<b>6</b>
<b>3</b>	<b>CLIENT INFORMATION</b> .....	<b>7</b>
3.1	APPLICANT INFORMATION .....	7
3.2	MANUFACTURER INFORMATION .....	7
<b>4</b>	<b>EQUIPMENT UNDER TEST (EUT) AND ANCILLARY EQUIPMENT (AE)</b> .....	<b>8</b>
4.1	ABOUT EUT .....	8
4.2	INTERNAL IDENTIFICATION OF EUT USED DURING THE TEST .....	8
4.3	INTERNAL IDENTIFICATION OF AE USED DURING THE TEST.....	8
<b>5</b>	<b>TEST METHODOLOGY</b> .....	<b>10</b>
5.1	APPLICABLE LIMIT REGULATIONS .....	10
5.2	APPLICABLE MEASUREMENT STANDARDS.....	10
<b>6</b>	<b>SPECIFIC ABSORPTION RATE (SAR)</b> .....	<b>10</b>
6.1	INTRODUCTION .....	11
6.2	SAR DEFINITION .....	11
<b>7</b>	<b>TISSUE SIMULATING LIQUIDS</b> .....	<b>12</b>
7.1	TARGETS FOR TISSUE SIMULATING LIQUID .....	12
7.2	DIELECTRIC PERFORMANCE .....	12
<b>8</b>	<b>SYSTEM VERIFICATION</b> .....	<b>17</b>
8.1	SYSTEM SETUP .....	17
8.2	SYSTEM VERIFICATION.....	18
<b>9</b>	<b>MEASUREMENT PROCEDURES</b> .....	<b>19</b>
9.1	TESTS TO BE PERFORMED.....	19
9.2	GENERAL MEASUREMENT PROCEDURE .....	21
9.3	WCDMA MEASUREMENT PROCEDURES FOR SAR.....	22
9.4	SAR MEASUREMENT FOR LTE .....	23
9.5	BLUETOOTH & WI-FI MEASUREMENT PROCEDURES FOR SAR.....	23
9.6	POWER DRIFT .....	24
<b>10</b>	<b>AREA SCAN BASED 1-G SAR</b> .....	<b>24</b>
10.1	REQUIREMENT OF KDB .....	24
10.2	FAST SAR ALGORITHMS.....	24
<b>11</b>	<b>CONDUCTED OUTPUT POWER</b> .....	<b>25</b>



11.1	GSM MEASUREMENT RESULT .....	25
11.2	WCDMA MEASUREMENT RESULT.....	27
11.3	LTE MEASUREMENT RESULT .....	29
11.4	WI-FI AND BT MEASUREMENT RESULT .....	32
<b>12</b>	<b>SIMULTANEOUS TX SAR CONSIDERATIONS.....</b>	<b>35</b>
12.1	INTRODUCTION.....	35
12.2	TRANSMIT ANTENNA SEPARATION DISTANCES .....	35
12.3	SAR MEASUREMENT POSITIONS .....	36
12.4	STANDALONE SAR TEST EXCLUSION CONSIDERATIONS.....	36
<b>13</b>	<b>EVALUATION OF SIMULTANEOUS.....</b>	<b>37</b>
<b>14</b>	<b>SAR TEST RESULT .....</b>	<b>38</b>
14.1	SAR RESULTS FOR FAST SAR.....	38
14.2	SAR RESULTS FOR FULL SAR.....	48
<b>15</b>	<b>SAR MEASUREMENT VARIABILITY.....</b>	<b>49</b>
<b>16</b>	<b>MEASUREMENT UNCERTAINTY .....</b>	<b>50</b>
16.1	MEASUREMENT UNCERTAINTY FOR NORMAL SAR TESTS (300MHZ~3GHZ).....	50
16.2	MEASUREMENT UNCERTAINTY FOR NORMAL SAR TESTS (3~6GHZ).....	51
16.3	MEASUREMENT UNCERTAINTY FOR FAST SAR TESTS (300MHZ~3GHZ).....	52
16.4	MEASUREMENT UNCERTAINTY FOR FAST SAR TESTS (3~6GHZ).....	53
<b>17</b>	<b>MAIN TEST INSTRUMENTS.....</b>	<b>55</b>
<b>ANNEX A</b>	<b>GRAPH RESULTS.....</b>	<b>56</b>
<b>ANNEX B</b>	<b>SYSTEM VERIFICATION RESULTS .....</b>	<b>72</b>
<b>ANNEX C</b>	<b>SAR MEASUREMENT SETUP .....</b>	<b>81</b>
<b>ANNEX D</b>	<b>POSITION OF THE WIRELESS DEVICE IN RELATION TO THE PHANTOM .....</b>	<b>87</b>
<b>ANNEX E</b>	<b>EQUIVALENT MEDIA RECIPES.....</b>	<b>90</b>
<b>ANNEX F</b>	<b>SYSTEM VALIDATION .....</b>	<b>91</b>
<b>ANNEX G</b>	<b>PROBE CALIBRATION CERTIFICATE.....</b>	<b>92</b>
<b>ANNEX H</b>	<b>DIPOLE CALIBRATION CERTIFICATE .....</b>	<b>103</b>
<b>ANNEX I</b>	<b>SENSOR TRIGGERING DATA SUMMARY.....</b>	<b>135</b>
<b>ANNEX J</b>	<b>ACCREDITATION CERTIFICATE.....</b>	<b>140</b>

## 1 Test Laboratory

### 1.1 Testing Location

Company Name:	CTTL(Shouxiang)
Address:	No. 51 Shouxiang Science Building, Xueyuan Road, Haidian District, Beijing, P. R. China100191

### 1.2 Testing Environment

Temperature:	18°C~25 °C,
Relative humidity:	30%~ 70%
Ground system resistance:	< 0.5 $\Omega$
Ambient noise & Reflection:	< 0.012 W/kg

### 1.3 Project Data

Project Leader:	Qi Dianyuan
Test Engineer:	Lin Xiaojun
Testing Start Date:	July 19, 2017
Testing End Date:	July 23, 2017

### 1.4 Signature



---

Lin Xiaojun

(Prepared this test report)

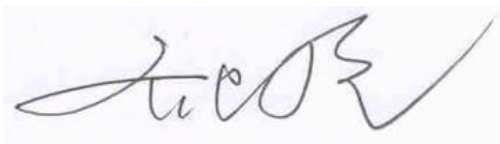

---

Qi Dianyuan

(Reviewed this test report)



---

Lu Bingsong

Deputy Director of the laboratory  
(Approved this test report)

## 2 Statement of Compliance

The maximum results of SAR found during testing for Lenovo PC HK Limited Portable Tablet Computer Lenovo TB-7304X is as follows:

**Table 2.1: Highest Reported SAR (1g)**

Exposure Configuration	Technology Band	Highest Reported SAR 1g(W/kg)	Equipment Class
Head	GSM 850	0.10	PCE
	PCS 1900	0.15	
	UMTS FDD 5	0.10	
	UMTS FDD 2	0.09	
	LTE Band 7	0.06	
	WLAN 2.4 GHz	0.75	DTS
Body	GSM 850	0.40	PCE
	PCS 1900	0.38	
	UMTS FDD 5	0.64	
	UMTS FDD 2	0.43	
	LTE Band 7	0.59	
	WLAN 2.4 GHz	0.92	DTS

The SAR values found for the Tablet computer are below the maximum recommended levels of 1.6 W/Kg as averaged over any 1g tissue according to the ANSI C95.1-1992.

For body worn operation, this device has been tested and meets FCC RF exposure guidelines when used with any accessory that contains no metal and which provides a minimum separation distance of 10 mm between this device and the body of the user. Use of other accessories may not ensure compliance with FCC RF exposure guidelines.

The EUT battery must be fully charged and checked periodically during the test to ascertain uniform power output.

The measurement together with the test system set-up is described in annex C of this test report. A detailed description of the equipment under test can be found in chapter 4 of this test report.

The highest reported SAR value is obtained at the case of **(Table 2.1)**, and the values are: **0.92 W/kg (1g)**.

**Table 2.2: The sum of reported SAR values for main antenna and WiFi**

	Position	Main antenna	WiFi	Sum
<b>Highest reported SAR value for Head</b>	Right hand, Touch cheek	0.10	0.75	<b>0.85</b>
<b>Highest reported SAR value for Body</b>	Rear 0mm	0.64	0.92	<b>1.56</b>

**Table 2.3: The sum of reported SAR values for main antenna and BT**

	Position	Main antenna	BT	Sum
<b>Maximum reported SAR value for Head</b>	Left hand, Touch cheek	0.15	0.13	<b>0.28</b>
<b>Maximum reported SAR value for Body</b>	Rear 0mm	0.64	0.07	<b>0.71</b>

[1] - Estimated SAR for Bluetooth (see the table 13.3)

According to the above tables, the highest sum of reported SAR values is **1.56 W/kg (1g)**. The detail for simultaneous transmission consideration is described in chapter 13.



### 3 Client Information

#### 3.1 Applicant Information

Company Name:	Lenovo(Shanghai) Electronics Technology Co., Ltd.
Address /Post:	NO.68 BUILDING, 199 FENJU RD, Pilot Free Trade Zone, 200131, China
City:	Shanghai
Postal Code:	201203
Country:	China
Contact Person:	Spring Zhou (For FCC)
E-mail:	zhoucb1@lenovo.com
Telephone:	+86-21-50504500-8281
Fax:	+86-21-50504500-8281

#### 3.2 Manufacturer Information

Company Name:	Lenovo PC HK Limited
Address /Post:	23/F, Lincoln Ho23/F, Lincoln House, Taikoo Place 979 King's Road, Quarry Bay, Hong Konguse, Taikoo Place
City:	Shanghai
Postal Code:	201203
Country:	China
Contact Person:	Jason Wang
E-mail:	wangjun28@lenovo.com
Telephone:	+86-10-57877542
Fax:	+86-10-58863425

## 4 Equipment Under Test (EUT) and Ancillary Equipment (AE)

### 4.1 About EUT

Description:	Portable Tablet Computer
Model name:	Lenovo TB-7304X
Operating mode(s):	GSM 850/900/1800/1900 WCDMA850/900/1900/2100 LTE B1/3/7/8/20, BT, WLAN
Tested Tx Frequency:	825 – 848.8 MHz (GSM 850)
	1850.2 – 1910 MHz (GSM 1900)
	826.4–846.6 MHz (WCDMA 850 Band V)
	1852.4–1907.6 MHz (WCDMA1900 Band II)
	2502.5 – 2567.5 MHz (LTE Band 7)
	2412 – 2462 MHz (Wi-Fi 2.4G)
GPRS/EGPRS Multislot Class:	12
Test device Production information:	Production unit
Device type:	Portable device
Antenna type:	Integrated antenna
Accessories/Body-worn configurations:	Headset
Hotspot mode:	Support
Product dimension	Long 194.8 mm ;Wide 102 mm ; Overall Diagonal 219.9 mm

### 4.2 Internal Identification of EUT used during the test

EUT ID*	IMEI	HW	SW Version
EUT1	865487030009750	Lenovo Tablet TB-7304X	TB-7304X_RF01_170728_ROW
EUT2	865487030010188	Lenovo Tablet TB-7304X	TB-7304X_RF01_170728_ROW
EUT3	865487030010097	Lenovo Tablet TB-7304X	TB-7304X_RF01_170728_ROW
EUT4	865487030009966	Lenovo Tablet TB-7304X	TB-7304X_RF01_170728_ROW
EUT5	865487030009800	Lenovo Tablet TB-7304X	TB-7304X_RF01_170728_ROW

\*EUT ID: is used to identify the test sample in the lab internally.

**Note:** It is performed to test SAR with the EUT1 to 3 and conducted power with the EUT4/5.

### 4.3 Internal Identification of AE used during the test

AE ID	Description	Model	SN	Manufacture
AE1	Battery	L13D1P31	/	Sunwoda
AE2	Battery	L13D1P31	/	SCUD

\*AE ID: is used to identify the test sample in the lab internally.



There are four kinds of combination modes to be tested and the detail information is as follows:

	SKU2		SKU4		SKU6		SKU8	
Material description	Model	Supplier	Model	Supplier	Model	Supplier	Model	Supplier
RAM+ROM	1+16 1st supplier		1+16 2nd supplier		2+16 1st supplier		2+16 2nd supplier	
motor	Motor_Semi-circular column_11.1*5.0*5.0_line_150mm	HZF	Motor_Semi-circular column_11.1*5.0*5.0_line_150mm	KW	Motor_Semi-circular column_11.1*5.0*5.0_line_150mm	HZF	Motor_Semi-circular column_11.1*5.0*5.0_line_150mm	KW
memory	KMFE60012M-B214	Samsung	KMFE10012M-B214013	Samsung	KMFE60012M-B214	Samsung	KMFE10012M-B214013	Samsung
PMIC	PMIC;MT6328V/AN;UMC Fab only;VFBGA206	MTK	PMIC;MT6328V/AN;UMC Fab only;VFBGA206	MTK	PMIC;MT6328V/AN;UMC Fab only;VFBGA206	MTK	PMIC;MT6328V/AN;UMC Fab only;VFBGA206	MTK
AP	BB;MT8735V/WD;VFBGA641;0.4mm	MTK	BB;MT8735V/WD;VFBGA641;0.4mm	MTK	BB;MT8735V/WD;VFBGA641;0.4mm	MTK	BB;MT8735V/WD;VFBGA641;0.4mm	MTK
PA	VC7912-51/VC7645-61	vanchip	VC7912-51/VC7645-61	vanchip	VC7912-51/VC7645-61	vanchip	VC7912-51/VC7645-61	vanchip
BT+WLAN+GPS+FM	WIFI/BT/GPS/FM&*MT6625LNAJC;HLM Cfab only	MTK	WIFI/BT/GPS/FM&*MT6625LNAJC;HLM Cfab only	MTK	WIFI/BT/GPS/FM&*MT6625LNAJC;HLM Cfab only	MTK	WIFI/BT/GPS/FM&*MT6625LNAJC;HLM Cfab only	MTK
Antenna	A1962	Saintenna Electronic Technology Co.,Ltd	A1962	Saintenna Electronic Technology Co.,Ltd	A1962	Saintenna Electronic Technology Co.,Ltd	A1962	Saintenna Electronic Technology Co.,Ltd
speaker	Speaker_1511*3.3mm_tanpian_0mm	Xichun	Speaker_1511*3.3mm_tanpian_0mm_Dongsheng	Dongsheng	Speaker_1511*3.3mm_tanpian_0mm	Xichun	Speaker_1511*3.3mm_tanpian_0mm_Dongsheng	Dongsheng
BB	MT8735V/WD	MTK	MT8735V/WD	MTK	MT8735V/WD	MTK	MT8735V/WD	MTK
LCM	LCM_6.95_1024*600_0nceil_3.6MAX_300_DX_HX8394D_ZIF	BOE	LCM_6.95_1024*600_0nceil_3.6max_300_HSD_NT5102_1BH_ZIF	DJ	LCM_6.95_1024*600_0nceil_3.6MAX_300_DX_HX8394D_ZIF	BOE	LCM_6.95_1024*600_0nceil_3.6max_300_HSD_NT5102_1BH_ZIF	DJ
RF transceiver	Transceiver;MT6169V/AM;TSMC Fab14 only	MTK	Transceiver;MT6169V/AM;TSMC Fab14 only	MTK	Transceiver;MT6169V/AM;TSMC Fab14 only	MTK	Transceiver;MT6169V/AM;TSMC Fab14 only	MTK
PCBA	A1962_PCB_V2_ZhiHao	ZhiHao	A1962_PCB_V2_YLAD	YLAD	A1962_PCB_V2_ZhiHao	ZhiHao	A1962_PCB_V2_YLAD	YLAD
Camera_Back	Camera_6.5*6.5*3.6_200W_S P2509_FF_ZIF_connector	CXT	Camera_6.5*6.5*3.6_200W_GC237_5_FF_ZIF_connector	BLX	Camera_6.5*6.5*3.6_200W_SP2509_FF_ZIF_connector	CXT	Camera_6.5*6.5*3.6_200W_GC237_5_FF_ZIF_connector	BLX
Camera_Front	Camera_6.5*6.5*3.6_200W_S P2509_FF_ZIF_connector	CXT	Camera_6.5*6.5*3.6_200W_GC237_5_FF_ZIF_connector	BLX	Camera_6.5*6.5*3.6_200W_SP2509_FF_ZIF_connector	CXT	Camera_6.5*6.5*3.6_200W_GC237_5_FF_ZIF_connector	BLX
Battery	A1990A_3450mAh_ATL 3087A0_L1enovo_L13D1P31	Sunwoda	A1900 batter_3450mAh_CA3087A0HV_Lenovo_no label	SCUD	A1990A_3450mAh_ATL 3087A0_L1enovo_L13D1P31	Sunwoda	A1900 batter_3450mAh_CA3087A0HV_Lenovo_no label	SCUD

We'll perform the SAR measurement with SKU6 and retest on highest value point with SKU8.

## 5 TEST METHODOLOGY

### 5.1 Applicable Limit Regulations

**ANSI C95.1–1992:** IEEE Standard for Safety Levels with Respect to Human Exposure to Radio Frequency Electromagnetic Fields, 3 kHz to 300 GHz.

It specifies the maximum exposure limit of **1.6 W/kg** as averaged over any 1 gram of tissue for portable devices being used within 20 cm of the user in the uncontrolled environment.

### 5.2 Applicable Measurement Standards

**IEEE 1528–2013:** Recommended Practice for Determining the Peak Spatial-Average Specific Absorption Rate (SAR) in the Human Head from Wireless Communications Devices: Measurement Techniques.

**KDB 616217 D04 SAR for laptop and tablets v01r02** SAR Evaluation Considerations for Laptop, Notebook, Notebook and Tablet Computers.

**KDB 447498 D01: General RF Exposure Guidance v06:** Mobile and Portable Devices RF Exposure Procedures and Equipment Authorization Policies.

**KDB 648474 D04 Handset SAR v01r03:** SAR Evaluation Considerations for Wireless Handsets.

**KDB 941225 D01 SAR test for 3G devices v03r01:** SAR Measurement Procedures for 3G Devices

**KDB 941225 D05 SAR for LTE Devices v02r05:** SAR Evaluation Considerations for LTE Devices

**KDB 941225 D06 Hotspot Mode SAR v02r01:** SAR Evaluation Procedures for Portable Devices with Wireless Router Capabilities

**KDB 248227 D01 802.11 Wi-Fi SAR v02r02:** SAR GUIDANCE FOR IEEE 802.11 (Wi-Fi) TRANSMITTERS

**KDB 865664 D01 SAR measurement 100 MHz to 6 GHz v01r04:** SAR Measurement Requirements for 100 MHz to 6 GHz.

**KDB 865664 D02 RF Exposure Reporting v01r02:** RF Exposure Compliance Reporting and Documentation Considerations

## 6 Specific Absorption Rate (SAR)

### 6.1 Introduction

SAR is related to the rate at which energy is absorbed per unit mass in an object exposed to a radio field. The SAR distribution in a biological body is complicated and is usually carried out by experimental techniques or numerical modeling. The standard recommends limits for two tiers of groups, occupational/controlled and general population/uncontrolled, based on a person's awareness and ability to exercise control over his or her exposure. In general, occupational/controlled exposure limits are higher than the limits for general population/uncontrolled.

### 6.2 SAR Definition

The SAR definition is the time derivative (rate) of the incremental energy ( $dW$ ) absorbed by (dissipated in) an incremental mass ( $dm$ ) contained in a volume element ( $dv$ ) of a given density ( $\rho$ ). The equation description is as below:

$$SAR = \frac{d}{dt} \left( \frac{dW}{dm} \right) = \frac{d}{dt} \left( \frac{dW}{\rho dv} \right)$$

SAR is expressed in units of Watts per kilogram (W/kg)

SAR measurement can be either related to the temperature elevation in tissue by

$$SAR = c \left( \frac{\delta T}{\delta t} \right)$$

Where:  $C$  is the specific heat capacity,  $\delta T$  is the temperature rise and  $\delta t$  is the exposure duration, or related to the electrical field in the tissue by

$$SAR = \frac{\sigma |E|^2}{\rho}$$

Where:  $\sigma$  is the conductivity of the tissue,  $\rho$  is the mass density of tissue and  $E$  is the RMS electrical field strength.

However for evaluating SAR of low power transmitter, electrical field measurement is typically applied.

## 7 Tissue Simulating Liquids

### 7.1 Targets for tissue simulating liquid

**Table 7.1: Targets for tissue simulating liquid**

Frequency(MHz)	Liquid Type	Conductivity( $\sigma$ )	$\pm 5\%$ Range	Permittivity( $\epsilon$ )	$\pm 5\%$ Range
835	Head	0.90	0.86~0.95	41.5	39.4~43.6
835	Body	0.97	0.92~1.02	55.2	52.4~58.0
1900	Head	1.40	1.33~1.47	40.0	38.0~42.0
1900	Body	1.52	1.44~1.60	53.3	50.6~56.0
2450	Head	1.80	1.71~1.89	39.2	37.2~41.2
2450	Body	1.95	1.85~2.05	52.7	50.1~55.3
2600	Head	1.96	1.86~2.06	39.01	37.06~40.96
2600	Body	2.16	2.05~2.27	52.5	49.9~55.1

### 7.2 Dielectric Performance

**Table 7.2: Dielectric Performance of Tissue Simulating Liquid**

Measurement Date yyyy/mm/dd	Frequency	Type	Permittivity $\epsilon$	Drift (%)	Conductivity $\sigma$ (S/m)	Drift (%)
2017/7/19	835 MHz	Head	41.62	0.29	0.889	-1.22
		Body	54.86	-0.62	0.965	-0.52
2017/7/21	1900 MHz	Head	40.65	1.63	1.414	1.00
		Body	52.84	-0.86	1.517	-0.20
2017/7/22	2450 MHz	Head	39.2	0.00	1.796	-0.22
		Body	52.5	-0.38	1.966	0.82
2017/7/23	2600 MHz	Head	39.16	0.38	1.968	0.41
		Body	52.14	-0.69	2.162	0.09

Note: The liquid temperature is 22.0 °C

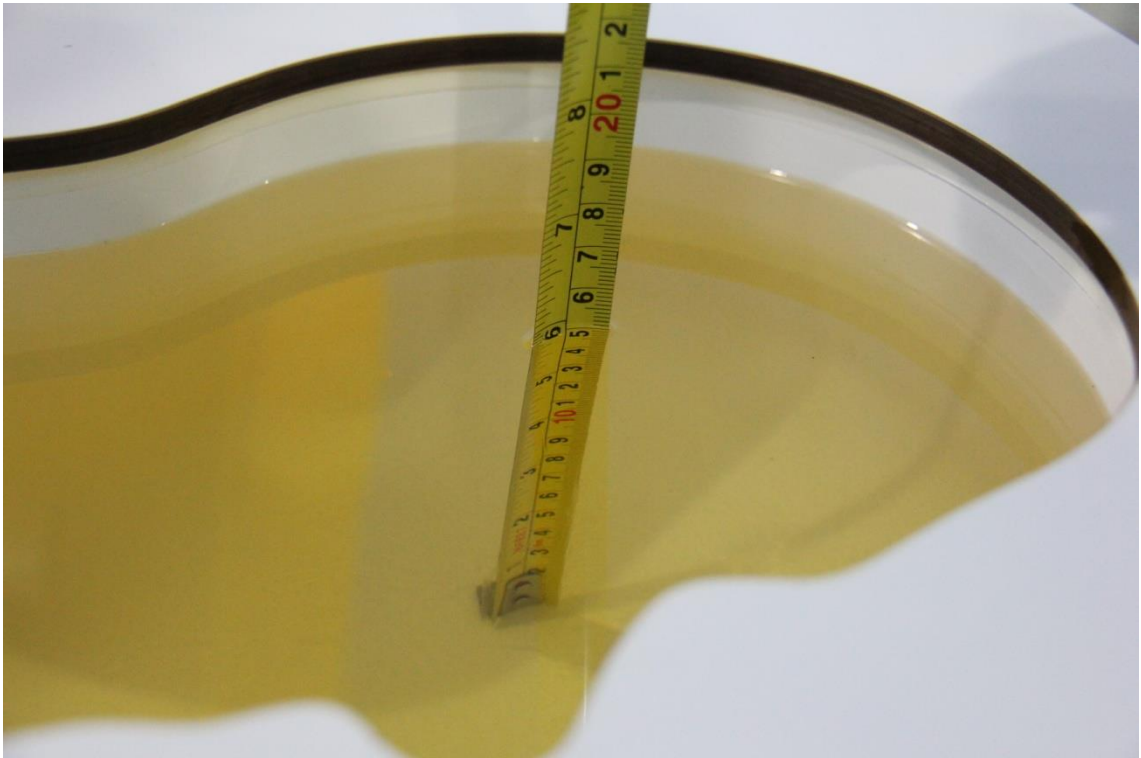

**Picture 7-1 Liquid depth in the Head Phantom (835MHz)**

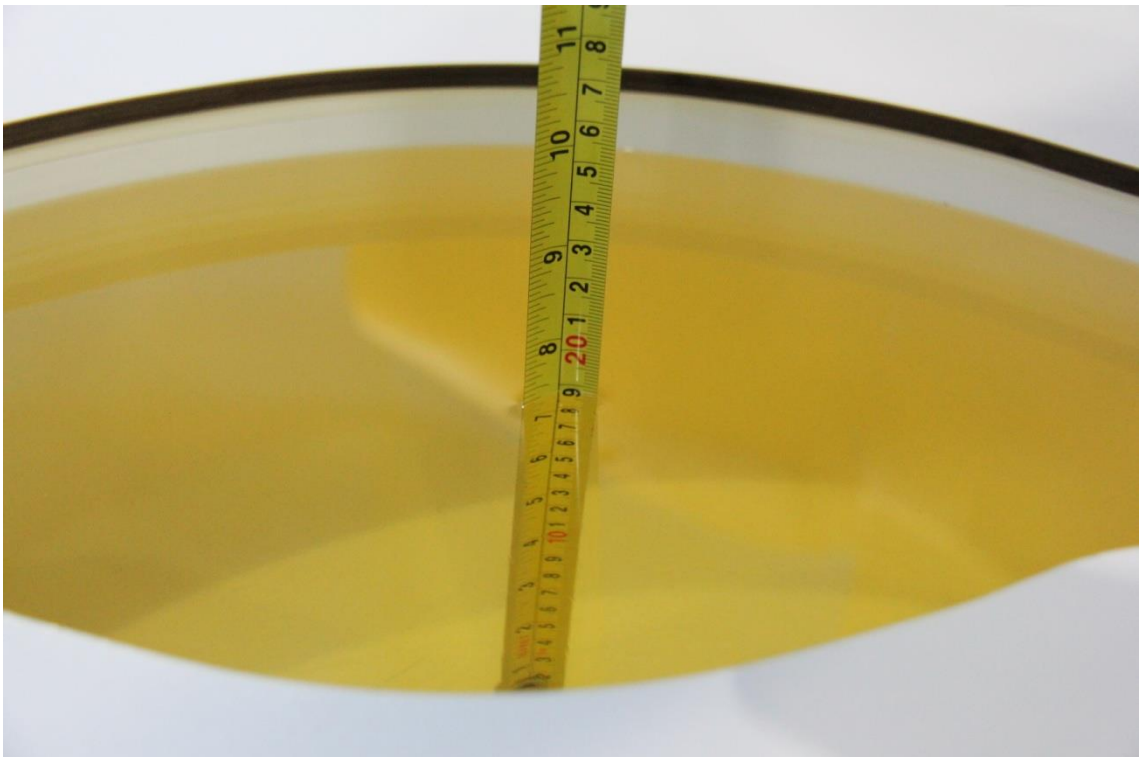

**Picture 7-2 Liquid depth in the Flat Phantom (835MHz)**

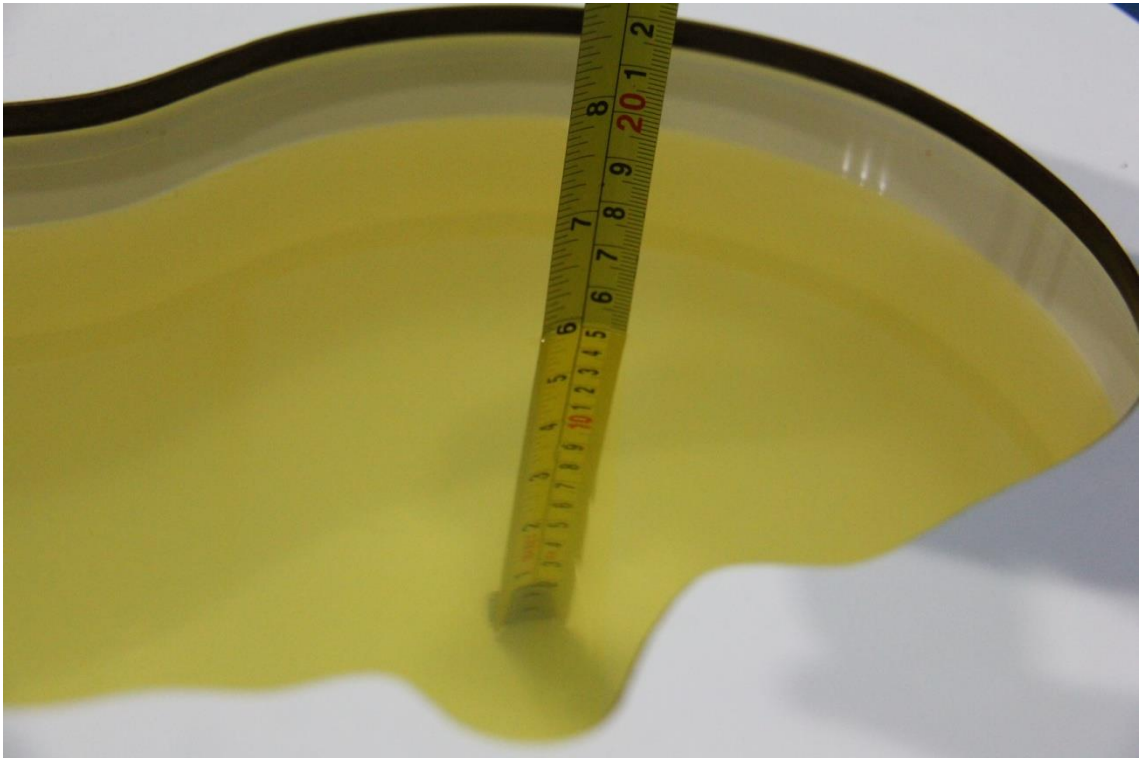

**Picture 7-3 Liquid depth in the Head Phantom (1900 MHz)**

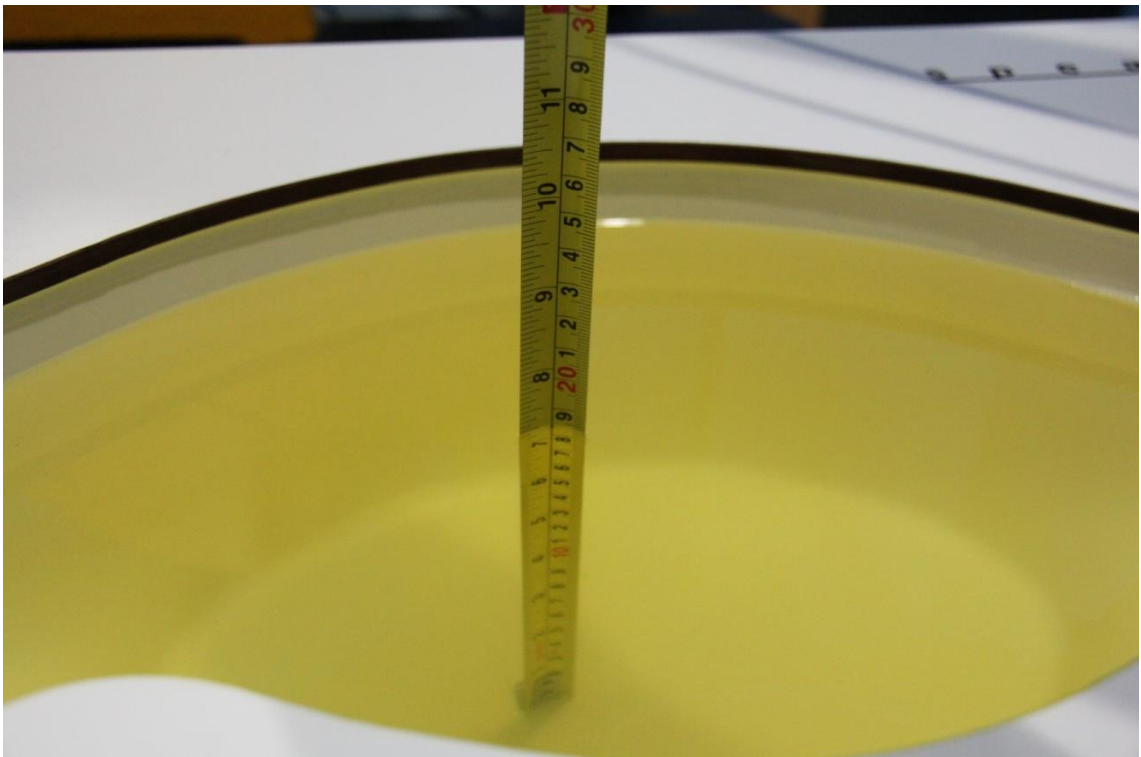

**Picture 7-4 Liquid depth in the Flat Phantom (1900MHz)**

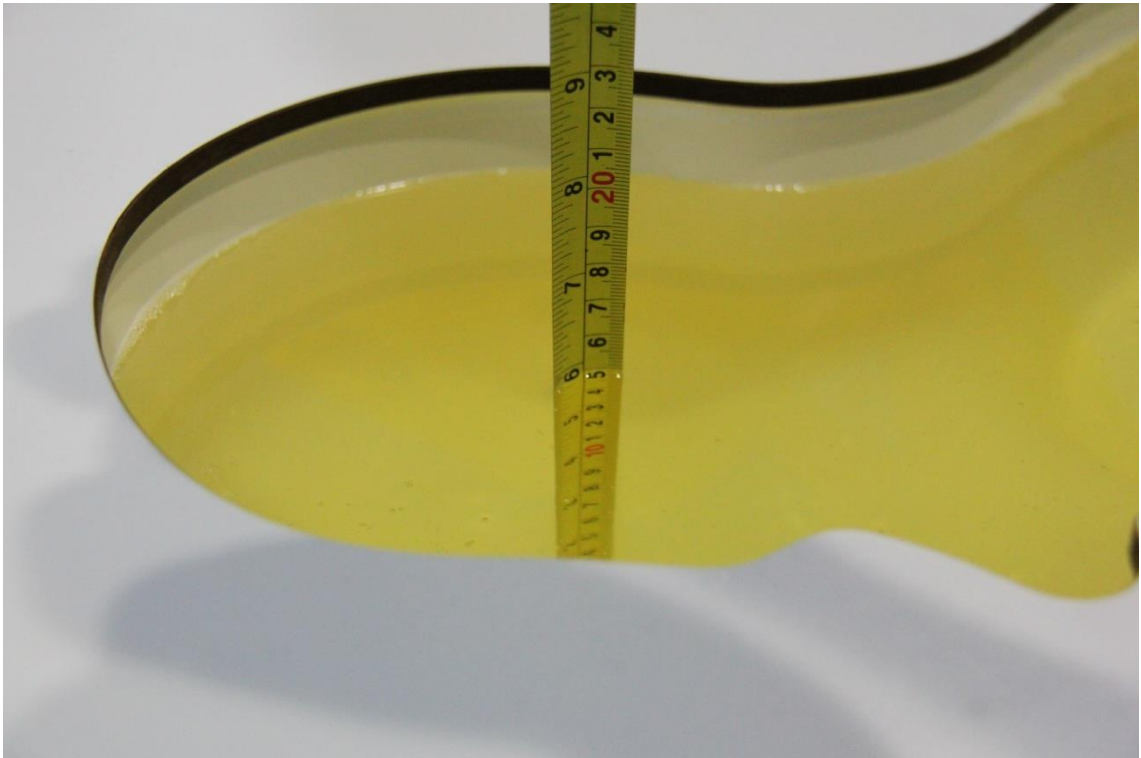

**Picture 7-5 Liquid depth in the Head Phantom (2450MHz)**

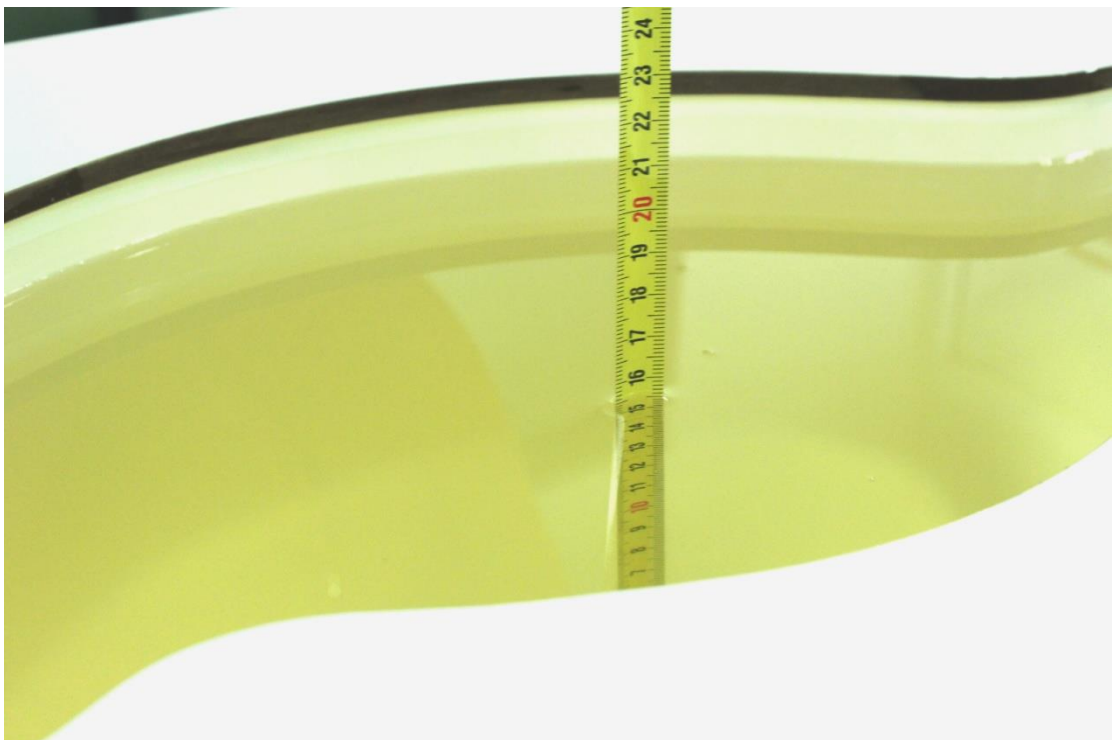

**Picture 7-6 Liquid depth in the Flat Phantom (2450MHz)**



**Picture 7-7 Liquid depth in the Head Phantom (2600 MHz Head)**

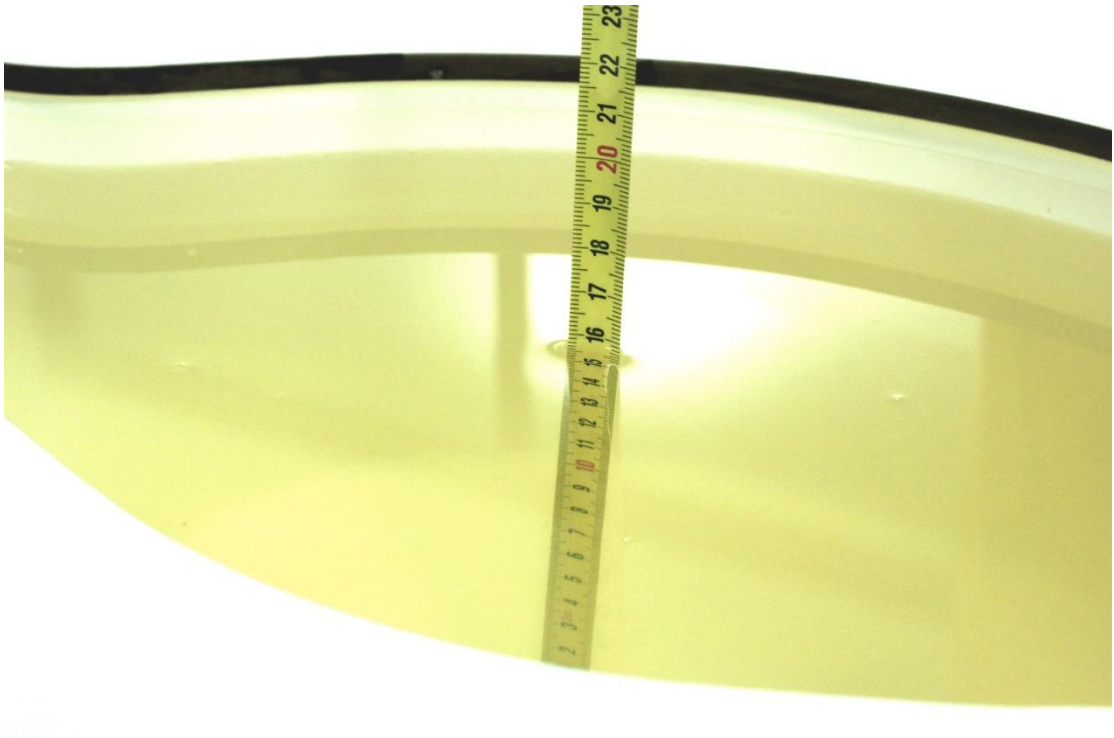

**Picture 7-8 Liquid depth in the Flat Phantom (2600MHz)**



## 8 System verification

### 8.1 System Setup

In the simplified setup for system evaluation, the DUT is replaced by a calibrated dipole and the power source is replaced by a continuous wave that comes from a signal generator. The calibrated dipole must be placed beneath the flat phantom section of the SAM twin phantom with the correct distance holder. The distance holder should touch the phantom surface with a light pressure at the reference marking and be oriented parallel to the long side of the phantom. The equipment setup is shown below:

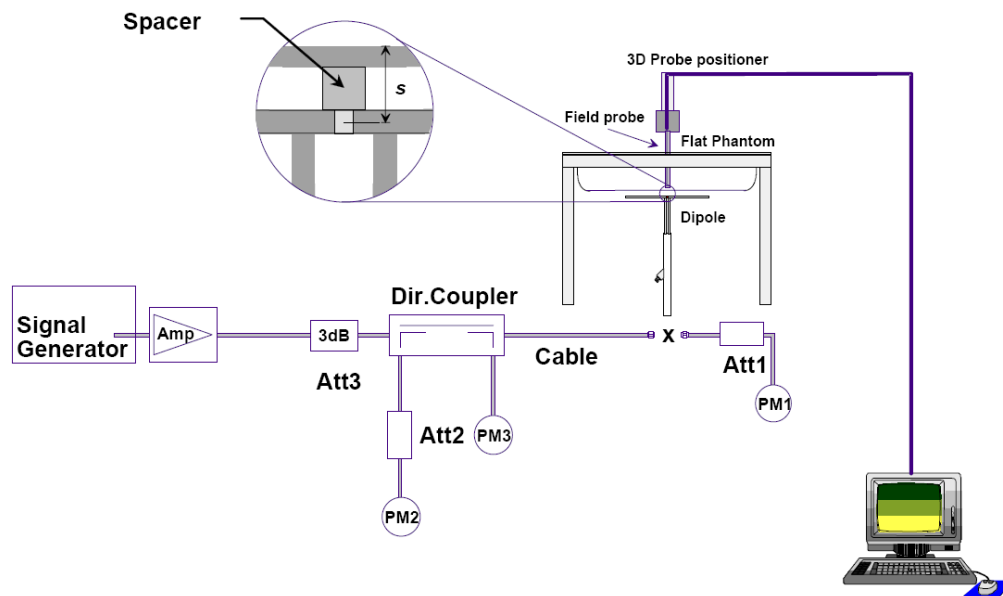

Picture 8.1 System Setup for System Evaluation



Picture 8.2 Photo of Dipole Setup

## 8.2 System Verification

SAR system verification is required to confirm measurement accuracy, according to the tissue dielectric media, probe calibration points and other system operating parameters required for measuring the SAR of a test device. The system verification must be performed for each frequency band and within the valid range of each probe calibration point required for testing the device.

The system verification results are required that the area scan estimated 1-g SAR is within 3% of the zoom scan 1-g SAR. The details are presented in annex B.

**Table 8.1: System Verification of Head**

Measurement Date (yyyy-mm-dd)	Frequency	Target value (W/kg)		Measured value (W/kg)		Deviation	
		10 g Average	1 g Average	10 g Average	1 g Average	10 g Average	1 g Average
2017/7/19	835 MHz	6.18	9.44	6.32	9.4	2.27%	-0.42%
2017/7/21	1900 MHz	21.2	40.7	21.44	40.32	1.13%	-0.93%
2017/7/22	2450 MHz	24.6	52.8	24.64	52.64	0.16%	-0.30%
2017/7/23	2600 MHz	25.2	56.7	25.48	56.36	1.11%	-0.60%

**Table 8.2: System Verification of Body**

Measurement Date (yyyy-mm-dd)	Frequency	Target value (W/kg)		Measured value (W/kg)		Deviation	
		10 g Average	1 g Average	10 g Average	1 g Average	10 g Average	1 g Average
2017/7/19	835 MHz	6.36	9.69	6.28	9.8	-1.26%	1.14%
2017/7/21	1900 MHz	21.3	40.1	21.6	40.12	1.41%	0.05%
2017/7/22	2450 MHz	24.1	51.2	24.36	51.28	1.08%	0.16%
2017/7/23	2600 MHz	24.8	55.3	24.32	55.72	-1.94%	0.76%

## 9 Measurement Procedures

### 9.1 Tests to be performed

In order to determine the highest value of the peak spatial-average SAR of a handset, all device positions, configurations and operational modes shall be tested for each frequency band according to steps 1 to 3 below. A flowchart of the test process is shown in picture 9.1.

**Step 1:** The tests described in 9.2 shall be performed at the channel that is closest to the center of the transmit frequency band ( $f_c$ ) for:

- a) all device positions (cheek and tilt, for both left and right sides of the SAM phantom, as described in annex D),
- b) all configurations for each device position in a), e.g., antenna extended and retracted, and
- c) all operational modes, e.g., analogue and digital, for each device position in a) and configuration in b) in each frequency band.

If more than three frequencies need to be tested according to 11.1 (i.e.,  $N_c > 3$ ), then all frequencies, configurations and modes shall be tested for all of the above test conditions.

**Step 2:** For the condition providing highest peak spatial-average SAR determined in Step 1, perform all tests described in 9.2 at all other test frequencies, i.e., lowest and highest frequencies. In addition, for all other conditions (device position, configuration and operational mode) where the peak spatial-average SAR value determined in Step 1 is within 3 dB of the applicable SAR limit, it is recommended that all other test frequencies shall be tested as well.

**Step 3:** Examine all data to determine the highest value of the peak spatial-average SAR found in Steps 1 to 2.

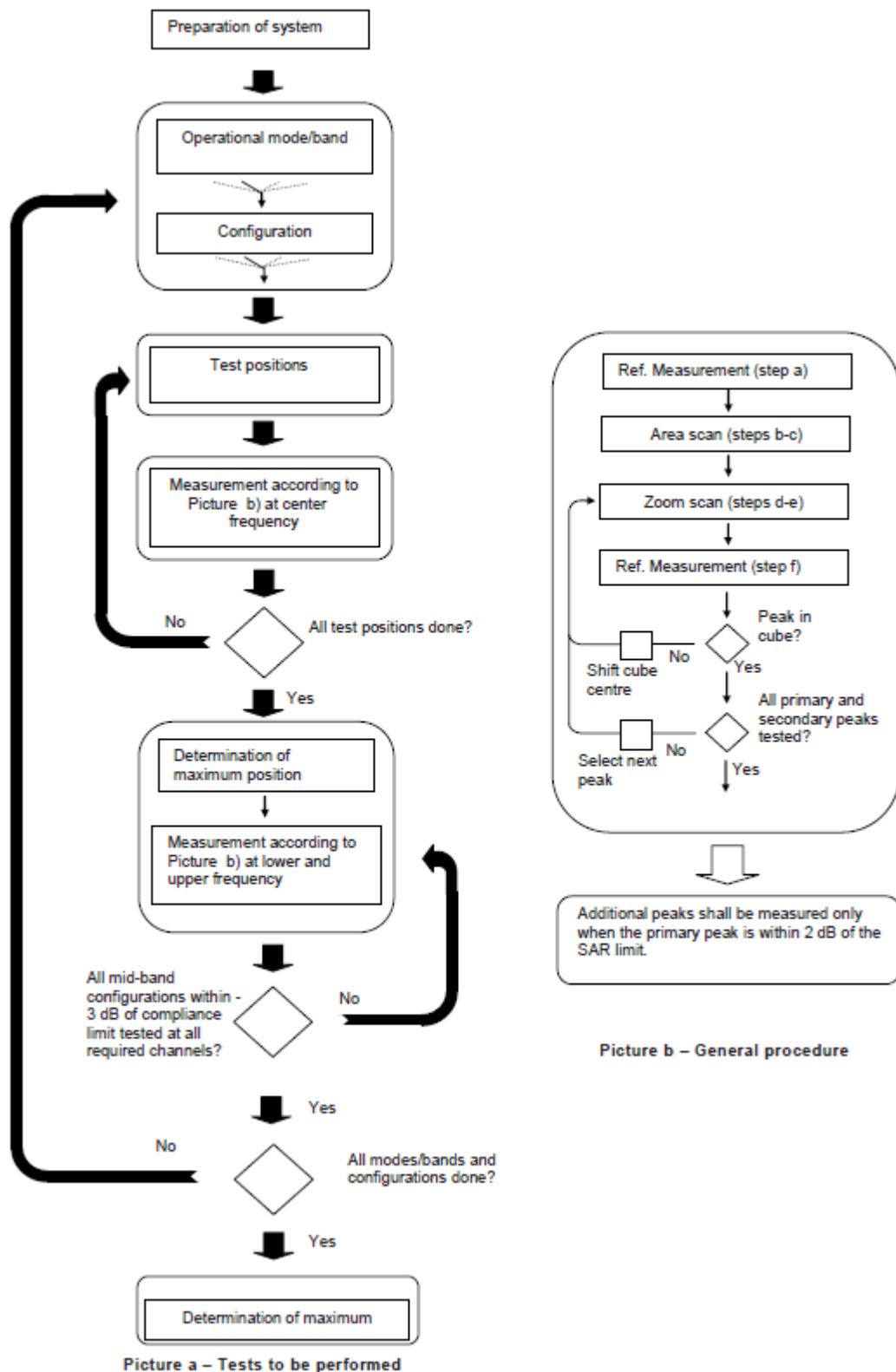

**Picture 9.1 Block diagram of the tests to be performed**