



# FCC RF Test Report

APPLICANT : Lenovo (Shanghai) Electronics Technology Co., Ltd.  
EQUIPMENT : Portable Tablet Computer  
BRAND NAME : Lenovo  
MODEL NAME : TB360ZU  
FCC ID : O57TB360ZU  
STANDARD : 47 CFR Part 2, 22, 27  
CLASSIFICATION : PCS Licensed Transmitter (PCB)  
TEST DATE(S) : Mar. 02, 2023 ~ Mar. 16, 2023

We, Sporton International Inc. (Kunshan), would like to declare that the tested sample has been evaluated in accordance with the procedures given in ANSI C63.26-2015 and shown compliance with the applicable technical standards.

The test results in this report apply exclusively to the tested model / sample. Without written approval of Sporton International Inc. (Kunshan), the test report shall not be reproduced except in full.

Jason Jia

Approved by: Jason Jia



**Sporton International Inc. (Kunshan)**

No. 1098, Pengxi North Road, Kunshan Economic Development Zone Jiangsu Province 215300  
People's Republic of China



TABLE OF CONTENTS

REVISION HISTORY... 3
SUMMARY OF TEST RESULT ... 4
1 GENERAL DESCRIPTION ... 5
1.1 Applicant ... 5
1.2 Manufacturer ... 5
1.3 Product Feature of Equipment Under Test ... 5
1.4 Product Specification of Equipment Under Test ... 5
1.5 Modification of EUT ... 6
1.6 Maximum ERP/EIRP Power and Emission Designator ... 7
1.7 Testing Location ... 8
1.8 Test Software ... 8
1.9 Applicable Standards ... 8
2 TEST CONFIGURATION OF EQUIPMENT UNDER TEST ... 9
2.1 Test Mode ... 9
2.2 Connection Diagram of Test System ... 11
2.3 Support Unit used in test configuration and system ... 11
2.4 Measurement Results Explanation Example ... 12
2.5 Frequency List of Low/Middle/High Channels ... 12
3 CONDUCTED TEST ITEMS ... 16
3.1 Measuring Instruments ... 16
3.2 Test Setup ... 16
3.3 Test Result of Conducted Test ... 16
3.4 Conducted Output Power and ERP/EIRP ... 17
3.5 Peak-to-Average Ratio ... 18
3.6 Occupied Bandwidth ... 19
3.7 Conducted Band Edge ... 20
3.8 Conducted Spurious Emission ... 22
3.9 Frequency Stability ... 23
4 RADIATED TEST ITEMS ... 24
4.1 Measuring Instruments ... 24
4.2 Test Setup ... 24
4.3 Test Result of Radiated Test ... 25
4.4 Radiated Spurious Emission ... 26
5 LIST OF MEASURING EQUIPMENT ... 27
6 UNCERTAINTY OF EVALUATION ... 28
APPENDIX A. TEST RESULTS OF CONDUCTED TEST
APPENDIX B. TEST RESULTS OF RADIATED TEST
APPENDIX C. TEST SETUP PHOTOGRAPHS



### REVISION HISTORY

REPORT NO.	VERSION	DESCRIPTION	ISSUED DATE
FG311926G	Rev. 01	Initial issue of report	Apr. 07, 2023



## SUMMARY OF TEST RESULT

Report Section	FCC Rule	Description	Limit	Result	Remark
3.4	§2.1046	Conducted Output Power	Reporting Only	PASS	-
	§22.913(a)(5)	Effective Radiated Power (5G NR n5)	ERP < 7 Watt		
	§27.50(c)(10)	Effective Radiated Power (5G NR n71)	ERP < 3 Watt		
	§27.50(h)(2)	Equivalent Isotropic Radiated Power (5G NR n7, n41, n38)	EIRP < 2Watt		
	§27.50(d)(4)	Equivalent Isotropic Radiated Power (5G NR n66)	EIRP < 1Watt		
3.5	§27.50(j)(4)	Peak-to-Average Ratio	<13 dB	PASS	-
3.6	§2.1049	Occupied Bandwidth	Reporting Only	PASS	-
3.7	§2.1051 §22.917(a) §27.53(h) §27.53(g)	Conducted Band Edge Measurement (5G NR n5) (5G NR n66) (5G NR n71)	< 43+10log <sub>10</sub> (P[Watts])	PASS	-
	§27.53(m)(4)	Conducted Band Edge Measurement (5G NR n7, n41, n38)	§27.53(m)(4)		
3.8	§2.1051 §22.917(a) §27.53(h) §27.53(g)	Conducted Spurious Emission (5G NR n5) (5G NR n66) (5G NR n71)	< 43+10log <sub>10</sub> (P[Watts])	PASS	-
	§2.1051 §27.53(m)(4)	Conducted Spurious Emission (5G NR n7, n41, n38)	< 55+10log <sub>10</sub> (P[Watts])		
3.9	§2.1055 §22.355	Frequency Stability Temperature & Voltage	< 2.5 ppm for Part 22	PASS	-
	§27.54		Within Authorized Band		
4.4	§2.1053 §22.917(a) §27.53(h) §27.53(g)	Radiated Spurious Emission (5G NR n5) (5G NR n66) (5G NR n71)	< 43+10log <sub>10</sub> (P[Watts])	PASS	Under limit 35.97 dB at 10310.00 MHz
	§2.1053 §27.53(m)(4)	Radiated Spurious Emission (5G NR n7, n41, n38)	< 55+10log <sub>10</sub> (P[Watts])		

**Declaration of Conformity:**

The test results with all measurement uncertainty excluded are presented in accordance with the regulation limits or requirements declared by manufacturers.

**Comments and Explanations:**

The declared of product specification for EUT presented in the report are provided by the manufacturer, and the manufacturer takes all the responsibilities for the accuracy of product specification.



# 1 General Description

## 1.1 Applicant

Lenovo (Shanghai) Electronics Technology Co., Ltd.

Section 304-305, Building No. 4, # 222, Meiyue Road, China (Shanghai) Pilot Free Trade Zone

## 1.2 Manufacturer

Lenovo PC HK Limited

23/F, Lincoln House, Taikoo Place 979 King's Road, Quarry Bay, Hong Kong, China

## 1.3 Product Feature of Equipment Under Test

Product Feature	
Equipment	Portable Tablet Computer
Brand Name	Lenovo
Model Name	TB360ZU
FCC ID	O57TB360ZU
IMEI Code	Conducted : 869864060008140 Radiation : 869864060010336
HW Version	TB360ZU
SW Version	TB360ZU_RF01_230312
EUT Stage	Identical Prototype

## 1.4 Product Specification of Equipment Under Test

Standards-related Product Specification	
Tx Frequency	5G NR n5 : 824 MHz ~ 849 MHz 5G NR n7 : 2500 MHz ~ 2570 MHz 5G NR n38 : 2570 MHz ~ 2620 MHz 5G NR n41 : 2496 MHz ~ 2690 MHz 5G NR n66 : 1710 MHz ~ 1780 MHz 5G NR n71: 663 MHz ~ 698 MHz
Rx Frequency	5G NR n5 : 869 MHz ~ 894 MHz 5G NR n7 : 2620 MHz ~ 2690 MHz 5G NR n38: 2570 MHz ~ 2620 MHz 5G NR n41 : 2496 MHz ~ 2690 MHz 5G NR n66 : 2110 MHz~ 2200 MHz 5G NR n71: 617 MHz ~ 652 MHz
Bandwidth	n5, n71: 5MHz / 10MHz / 15MHz / 20MHz n7: 5MHz / 10MHz / 15MHz / 20MHz / 25MHz / 30MHz / 40MHz n38: 20MHz / 30MHz / 40MHz n41 : 20MHz / 30MHz / 40MHz / 50MHz / 60MHz / 80MHz / 90MHz / 100MHz n66: 5MHz / 10MHz / 15MHz / 20MHz / 30MHz / 40MHz
SCS	15kHz, 30kHz
Antenna Gain	<Ant. 1>:



	n5: 0.04 dBi n71: -4.37 dBi <b>&lt;Ant. 2&gt;:</b> n7: 0.89 dBi n66: 2.61 dBi n38: 0.89 dBi n41: 0.89 dBi <b>&lt;Ant. 4&gt;:</b> n41: 0.91 dBi <b>&lt;Ant. 6&gt;:</b> n7: 0.92 dBi n66: -0.18 dBi n41: 0.92 dBi <b>&lt;Ant. 8&gt;:</b> n41: -3.0 dBi
<b>Type of Modulation</b>	CP-OFDM: QPSK / 16QAM / 64QAM / 256QAM DFT-s-OFDM: PI/2 BPSK / QPSK / 16QAM / 64QAM / 256QAM

**Remark:**

1. The maximum EIRP is calculated from max output power and max antenna gain, only the maximum EIRP are shown in the report, Ant. 2 for n7/n66/n41.
2. 5G NR support SA (n5/n7/n38/n41/n66/n71) mode and NSA(n5/n7/n66) mode. According to the maximum power between SA and NSA mode, SA covers NSA mode for (n5/n7/n66).
3. The device supports HPUE mode for 5G NR n41.
4. The device supports n41(1T4R) SRS resources on ant.2/4/6/8, only the test data of worst ant.2 is showed in the report according to the maximum power.
5. The device supports two PAs for 5G NR n7/n66 (main PA on Ant.2 and other PA on Ant.6), the maximum power of main PA is higher than the other PA, therefore, we chose main PA to calculate the EIRP and show in the report.
6. The EN-DC combinations declared by the manufacturer are as follows: DC\_7A\_n5A, DC\_2A\_n7A, DC\_66A\_n7A, DC\_2A\_n66A and DC\_7A\_n66A.

### 1.5 Modification of EUT

No modifications are made to the EUT during all test items.



### 1.6 Maximum ERP/EIRP Power and Emission Designator

5G NR n5		PI/2 BPSK / QPSK		16QAM / 64QAM / 256QAM	
BW (MHz)	Frequency Range (MHz)	Maximum ERP(W)	Emission Designator (99%OBW)	Maximum ERP(W)	Emission Designator (99%OBW)
20	834.0 ~ 839.0	0.1866	18M9G7D	0.1489	18M8W7D

5G NR n7		PI/2 BPSK / QPSK		16QAM / 64QAM / 256QAM	
BW (MHz)	Frequency Range (MHz)	Maximum EIRP(W)	Emission Designator (99%OBW)	Maximum EIRP(W)	Emission Designator (99%OBW)
40	2520.0 ~ 2550.0	0.3926	38M6G7D	0.3097	38M7W7D

5G NR n38		PI/2 BPSK / QPSK		16QAM / 64QAM / 256QAM	
BW (MHz)	Frequency Range (MHz)	Maximum EIRP(W)	Emission Designator (99%OBW)	Maximum EIRP(W)	Emission Designator (99%OBW)
40	2590.0 ~ 2600.0	0.3467	37M8G7D	0.2748	37M8W7D

5G NR n41		PI/2 BPSK / QPSK		16QAM / 64QAM / 256QAM	
BW (MHz)	Frequency Range (MHz)	Maximum EIRP(W)	Emission Designator (99%OBW)	Maximum EIRP(W)	Emission Designator (99%OBW)
100	2546.01 ~ 2640.00	0.3784	97M3G7D	0.3319	97M4W7D

5G NR n66		PI/2 BPSK / QPSK		16QAM / 64QAM / 256QAM	
BW (MHz)	Frequency Range (MHz)	Maximum EIRP(W)	Emission Designator (99%OBW)	Maximum EIRP(W)	Emission Designator (99%OBW)
40	1730.0 ~ 1760.0	0.5082	38M6G7D	0.4064	38M6W7D

5G NR n71		PI/2 BPSK / QPSK		16QAM / 64QAM / 256QAM	
BW (MHz)	Frequency Range (MHz)	Maximum ERP(W)	Emission Designator (99%OBW)	Maximum ERP(W)	Emission Designator (99%OBW)
20	673.0 ~ 688.0	0.0634	18M9G7D	0.0507	18M9W7D

**Note:**

1. 5G NR Band n41 overlaps the entire frequency range of Band n38. Therefore, the conducted test results provided in this report covers Band n41 as well as Band n38.
2. All modulations have been tested, only the maximum bandwidth and the worst test results of PSK & QAM are shown in the report.



### 1.7 Testing Location

Sporton International Inc. (Kunshan) is accredited to ISO/IEC 17025:2017 by American Association for Laboratory Accreditation with Certificate Number 5145.02.

<b>Test Firm</b>	Sporton International Inc. (Kunshan)		
<b>Test Site Location</b>	No. 1098, Pengxi North Road, Kunshan Economic Development Zone Jiangsu Province 215300 People's Republic of China TEL : +86-512-57900158 FAX : +86-512-57900958		
<b>Test Site No.</b>	<b>Sporton Site No.</b>	<b>FCC Designation No.</b>	<b>FCC Test Firm Registration No.</b>
	03CH04-KS TH01-KS	CN1257	314309

### 1.8 Test Software

Item	Site	Manufacturer	Name	Version
1.	03CH04-KS	AUDIX	E3	6.2009-8-24al

### 1.9 Applicable Standards

According to the specifications of the manufacturer, the EUT must comply with the requirements of the following standards:

- ♦ 47 CFR Part 2, 22, 27
- ♦ ANSI C63.26-2015
- ♦ FCC KDB 971168 D01 Power Meas License Digital Systems v03r01
- ♦ FCC KDB 412172 D01 Determining ERP and EIRP v01r01

**Remark:**

All test items were verified and recorded according to the standards and without any deviation during the test.





## 2 Test Configuration of Equipment Under Test

### 2.1 Test Mode

Antenna port conducted and radiated test items are performed according to KDB 971168 D01 Power Meas License Digital Systems v03r01 with maximum output power.

For radiated measurement, pre-scanned in three orthogonal panels, X, Y, Z. The worst cases (Y plane) were recorded in this report.

The device is investigated from 30MHz to 10 times of fundamental signal for radiated spurious emission test under different RB size/offset and modulations in exploratory test. Subsequently, only the worst case emissions are reported.

Orthogonal Planes of EUT	X Plane	Y Plane	Z Plane
			

Test Items	5G NR	Bandwidth (MHz)													Modulation					RB #		Test Channel			
		5	10	15	20	25	30	40	50	60	70	80	90	100	PI/2 BPSK	QPSK	16QAM	64QAM	256QAM	1	Full	L	M	H	
Max. Output Power	n5	v	v	v	v	-	-	-	-	-	-	-	-	-	v	v	v	v	v	v	v	v	v	v	v
	n7	v	v	v	v	v	v	v	-	-	-	-	-	-	v	v	v	v	v	v	v	v	v	v	v
	n38	-	-	-	v	-	v	v	-	-	-	-	-	-	v	v	v	v	v	v	v	v	v	v	v
	n41	-	-	-	v	-	v	v	v	v	-	v	v	v	v	v	v	v	v	v	v	v	v	v	v
	n66	v	v	v	v	-	v	v	-	-	-	-	-	-	v	v	v	v	v	v	v	v	v	v	v
	n71	v	v	v	v	-	-	-	-	-	-	-	-	-	v	v	v	v	v	v	v	v	v	v	v
Peak-to-Average Ratio	n5				v	-	-	-	-	-	-	-	-	v	v					v	v		v		
	n7							v	-	-	-	-	-	v	v					v	v		v		
	n41	-	-	-		-					-			v	v	v				v	v		v		
	n66				v	-		v	-	-	-	-	-	-	v	v					v	v		v	
	n71				v	-	-	-	-	-	-	-	-	-	v	v					v	v		v	
26dB and 99% Bandwidth	n5	v	v	v	v	-	-	-	-	-	-	-	-		v	v	v	v		v		v			
	n7	v	v	v	v	v	v	v	-	-	-	-	-		v	v	v	v		v		v			
	n41	-	-	-	v	-	v	v	v	v	-	v	v	v		v	v	v	v		v		v		
	n66	v	v	v	v	-	v	v	-	-	-	-	-	-		v	v	v	v		v		v		
	n71	v	v	v	v	-	-	-	-	-	-	-	-	-		v	v	v	v		v		v		



Test Items	5G NR	Bandwidth (MHz)													Modulation					RB #		Test Channel		
		5	10	15	20	25	30	40	50	60	70	80	90	100	PI/2 BPSK	QPSK	16QAM	64QAM	256QAM	1	Full	L	M	H
Conducted Band Edge	n5	v		v	v	-	-	-	-	-	-	-	-	-	v	v				v	v	v		v
	n7	v			v			v	-	-	-	-	-	-	v	v				v	v	v		v
	n41	-	-	-	v	-			v	-				v	v	v				v	v	v		v
	n66	v			v	-		v	-	-	-	-	-	-	v	v				v	v	v		v
	n71	v		v	v	-	-	-	-	-	-	-	-	-	v	v				v	v	v		v
Conducted Spurious Emission	n5	v		v	v	-	-	-	-	-	-	-	-	-	v	v				v		v	v	v
	n7	v			v			v	-	-	-	-	-	-	v	v				v		v	v	v
	n41	-	-	-	v	-			v	-				v	v	v				v		v	v	v
	n66	v			v	-		v	-	-	-	-	-	-	v	v				v		v	v	v
	n71	v		v	v	-	-	-	-	-	-	-	-	-	v	v				v		v	v	v
Frequency Stability	n5				v	-	-	-	-	-	-	-	-		v					v		v		
	n7				v				-	-	-	-	-		v					v		v		
	n41	-	-	-	v	-									v					v		v		
	n66				v	-			-	-	-	-	-		v					v		v		
	n71				v	-	-	-	-	-	-	-	-		v					v		v		
E.R.P / E.I.R.P	n5	v	v	v	v	-	-	-	-	-	-	-	-	-	v	v	v	v	v	v	v	v	v	v
	n7	v	v	v	v	v	v	v	-	-	-	-	-	-	v	v	v	v	v	v	v	v	v	v
	n38	-	-	-	v	-	v	v	-	-	-	-	-	-	v	v	v	v	v	v	v	v	v	v
	n41	-	-	-	v	-	v	v	v	v	-	v	v	v	v	v	v	v	v	v	v	v	v	v
	n66	v	v	v	v	-	v	v	-	-	-	-	-	-	v	v	v	v	v	v	v	v	v	v
	n71	v	v	v	v	-	-	-	-	-	-	-	-	-	v	v	v	v	v	v	v	v	v	v
Radiated Spurious Emission	n5	Worst Case																					v	
	n7	Worst Case																					v	
	n38	Worst Case																					v	
	n41	Worst Case																					v	
	n66	Worst Case																					v	
	n71	Worst Case																					v	
Note	1. The mark "v" means that this configuration is chosen for testing 2. The mark "-" means that this bandwidth is not supported. 3. The device is investigated from 30MHz to 10 times of fundamental signal for radiated spurious emission test under different RB size/offset and modulations in exploratory test. Subsequently, only the worst case emissions are reported. 4. Frequency Stability: Normal Voltage = 3.86V ; Low Voltage =3.60V ; High Voltage =4.43V.																							

## 2.2 Connection Diagram of Test System

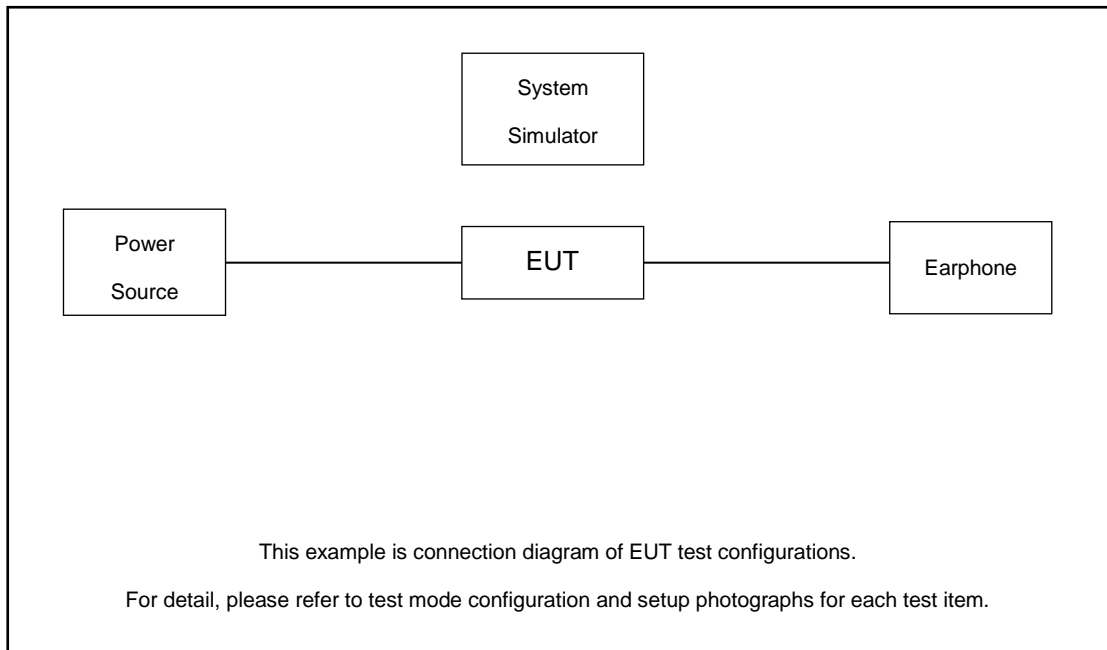

The EUT has been configuration operated in a manner tended to maximize its emission characteristics in a typical application.

## 2.3 Support Unit used in test configuration and system

Item	Equipment	Trade Name	Model No.	FCC ID	Data Cable	Power Cord
1.	DC Power Supply	GW	GPS-3030D	N/A	N/A	Unshielded, 1.8 m
2.	LTE Base Station	Anritsu	MT8821C	N/A	N/A	Unshielded, 1.8 m
3.	NR Base Station	Anritsu	MT8000A	N/A	N/A	Unshielded, 1.8 m
4.	Earphone	N/A	N/A	N/A	N/A	N/A



## 2.4 Measurement Results Explanation Example

**For all conducted test items:**

The offset level is set in the spectrum analyzer to compensate the RF cable loss and attenuator factor between EUT conducted output port and spectrum analyzer. With the offset compensation, the spectrum analyzer reading level is exactly the EUT RF output level.

The spectrum analyzer offset is derived from RF cable loss and attenuator factor.

$$\text{Offset} = \text{RF cable loss} + \text{attenuator factor}.$$

Following shows an offset computation example with cable loss 4.6 dB and 20dB attenuator.

Example :

$$\begin{aligned} \text{Offset(dB)} &= \text{RF cable loss(dB)} + \text{attenuator factor(dB)}. \\ &= 4.6 + 20 = 24.6 \text{ (dB)} \end{aligned}$$

## 2.5 Frequency List of Low/Middle/High Channels

5G NR n5 Channel and Frequency List				
BW [MHz]	Channel/Frequency(MHz)	Lowest	Middle	Highest
20	Channel	166800	167300	167800
	Frequency	834	836.5	839
15	Channel	166300	167300	168300
	Frequency	831.5	836.5	841.5
10	Channel	165800	167300	168800
	Frequency	829	836.5	844
5	Channel	165300	167300	169300
	Frequency	826.5	836.5	846.5



5G NR n7 Channel and Frequency List				
BW [MHz]	Channel/Frequency(MHz)	Lowest	Middle	Highest
40	Channel	504000	507000	510000
	Frequency	2520	2535	2550
30	Channel	503000	507000	511000
	Frequency	2515	2535	2555
25	Channel	502500	507000	511500
	Frequency	2512.5	2535	2557.5
20	Channel	502000	507000	512000
	Frequency	2510	2535	2560
15	Channel	501500	507000	512500
	Frequency	2507.5	2535	2562.5
10	Channel	501000	507000	513000
	Frequency	2505	2535	2565
5	Channel	500500	507000	513500
	Frequency	2502.5	2535	2567.5

5G NR n38 Channel and Frequency List				
BW [MHz]	Channel/Frequency(MHz)	Lowest	Middle	Highest
40	Channel	518000	519000	520000
	Frequency	2590	2595	2600
30	Channel	517000	519000	521000
	Frequency	2585	2595	2605
20	Channel	516000	519000	522000
	Frequency	2580	2595	2610



5G NR n41 Channel and Frequency List				
BW [MHz]	Channel/Frequency(MHz)	Lowest	Middle	Highest
100	Channel	509202	518598	528000
	Frequency	2546.01	2592.99	2640
90	Channel	508200	518598	528996
	Frequency	2541	2592.99	2644.98
80	Channel	507204	518598	529998
	Frequency	2536.02	2592.99	2649.99
60	Channel	505200	518598	531996
	Frequency	2526	2592.99	2659.98
50	Channel	504204	518598	532998
	Frequency	2521.02	2592.99	2664.99
40	Channel	503202	518598	534000
	Frequency	2516.01	2592.99	2670
30	Channel	502200	518598	534996
	Frequency	2511	2592.99	2674.98
20	Channel	501204	518598	535998
	Frequency	2506.02	2592.99	2679.99

5G NR n66 Channel and Frequency List				
BW [MHz]	Channel/Frequency(MHz)	Lowest	Middle	Highest
40	Channel	346000	349000	352000
	Frequency	1730	1745	1760
30	Channel	345000	349000	353000
	Frequency	1725	1745	1765
20	Channel	344000	349000	354000
	Frequency	1720	1745	1770
15	Channel	343500	349000	354500
	Frequency	1717.5	1745	1772.5
10	Channel	343000	349000	355000
	Frequency	1715	1745	1775
5	Channel	342500	349000	355500
	Frequency	1712.5	1745	1777.5



5G NR n71 Channel and Frequency List				
BW [MHz]	Channel/Frequency(MHz)	Lowest	Middle	Highest
20	Channel	134600	136100	137600
	Frequency	673	680.5	688
15	Channel	134100	136100	138100
	Frequency	670.5	680.5	690.5
10	Channel	133600	136100	138600
	Frequency	668	680.5	693
5	Channel	133100	136100	139100
	Frequency	665.5	680.5	695.5

### 3 Conducted Test Items

#### 3.1 Measuring Instruments

See list of measuring instruments of this test report.

#### 3.2 Test Setup

##### 3.2.1 Conducted Output Power



##### 3.2.2 Peak-to-Average Ratio, Occupied Bandwidth, Conducted Band-Edge and Conducted Spurious Emission



##### 3.2.3 Frequency Stability

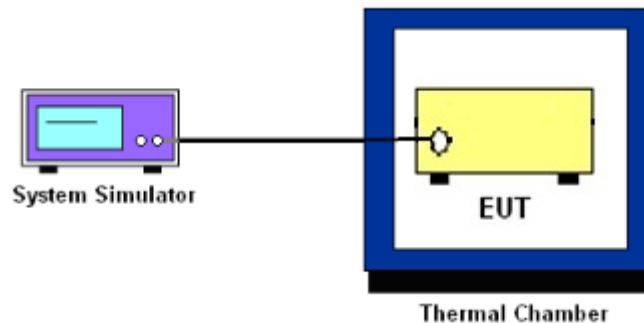

### 3.3 Test Result of Conducted Test

Please refer to Appendix A.





### 3.4 Conducted Output Power and ERP/EIRP

#### 3.4.1 Description of the Conducted Output Power Measurement and ERP/EIRP Measurement

A system simulator was used to establish communication with the EUT. Its parameters were set to force the EUT transmitting at maximum output power. The measured power in the radio frequency on the transmitter output terminals shall be reported.

The ERP of mobile transmitters must not exceed 7 Watts for 5G NR n5.

The ERP of mobile transmitters must not exceed 3 Watts for 5G NRn71.

The EIRP of mobile transmitters must not exceed 2 Watts for 5G NRn7, n38, n41.

The EIRP of mobile transmitters must not exceed 1 Watts for 5G NR n66.

According to KDB 412172 D01 Power Approach,

$EIRP = P_T + G_T - L_C$ ,  $ERP = EIRP - 2.15$ , where

$P_T$  = transmitter output power in dBm

$G_T$  = gain of the transmitting antenna in dBi

$L_C$  = signal attenuation in the connecting cable between the transmitter and antenna in dB

#### 3.4.2 Test Procedures

1. The testing follows ANSI C63.26 Section 5.2
2. The transmitter output port was connected to the system simulator.
3. Set EUT at maximum power through the system simulator.
4. Select lowest, middle, and highest channels for each band and different modulation.
5. Measure and record the power level from the system simulator.



## **3.5 Peak-to-Average Ratio**

### **3.5.1 Description of the PAR Measurement**

Power Complementary Cumulative Distribution Function (CCDF) curves provide a means for characterizing the power peaks of a digitally modulated signal on a statistical basis. A CCDF curve depicts the probability of the peak signal amplitude exceeding the average power level. Most contemporary measurement instrumentation include the capability to produce CCDF curves for an input signal provided that the instrument's resolution bandwidth can be set wide enough to accommodate the entire input signal bandwidth. In measuring transmissions in this band using an average power technique, the peak-to-average ratio (PAR) of the transmission may not exceed 13 dB.

### **3.5.2 Test Procedures**

1. The testing follows ANSI C63.26 Section 5.2.3.4 (CCDF).
2. The EUT was connected to spectrum and system simulator via a power divider.
3. Set the CCDF (Complementary Cumulative Distribution Function) option in spectrum analyzer.
4. The highest RF powers were measured and recorded the maximum PAPR level associated with a probability of 0.1 %.
5. Record the deviation as Peak to Average Ratio.



## 3.6 Occupied Bandwidth

### 3.6.1 Description of Occupied Bandwidth Measurement

The occupied bandwidth is the width of a frequency band such that, below the lower and above the upper frequency limits, the mean powers emitted are each equal to a specified percentage 0.5% of the total mean transmitted power.

The 26 dB emission bandwidth is defined as the frequency range between two points, one above and one below the carrier frequency, at which the spectral density of the emission is attenuated 26 dB below the maximum in-band spectral density of the modulated signal. Spectral density (power per unit bandwidth) is to be measured with a detector of resolution bandwidth equal to approximately 1.0% of the emission bandwidth.

### 3.6.2 Test Procedures

1. The testing follows ANSI C63.26 Section 5.4
2. The EUT was connected to spectrum analyzer and system simulator via a power divider.
3. The spectrum analyzer center frequency is set to the nominal EUT channel center frequency. The span range for the spectrum analyzer shall be between two and five times the anticipated OBW.
4. The nominal resolution bandwidth (RBW) shall be in the range of 1 to 5 % of the anticipated OBW, and the VBW shall be at least 3 times the RBW.
5. Set the detection mode to peak, and the trace mode to max hold.
6. Determine the reference value: Set the EUT to transmit a modulated signal. Allow the trace to stabilize. Set the spectrum analyzer marker to the highest level of the displayed trace.  
(this is the reference value)
7. Determine the “-26 dB down amplitude” as equal to (Reference Value – X).
8. Place two markers, one at the lowest and the other at the highest frequency of the envelope of the spectral display such that each marker is at or slightly below the “-X dB down amplitude” determined in step 6. If a marker is below this “-X dB down amplitude” value it shall be placed as close as possible to this value. The OBW is the positive frequency difference between the two markers.
9. Use the 99 % power bandwidth function of the spectrum analyzer and report the measured bandwidth.



### 3.7 Conducted Band Edge

#### 3.7.1 Description of Conducted Band Edge Measurement

22.917(a)

For operations in the 824 – 849 MHz band, the FCC limit is  $43 + 10\log_{10}(P[\text{Watts}])$  dB below the transmitter power P(Watts) in a 100kHz bandwidth. However, in the 1MHz bands immediately outside and adjacent to the licensee's frequency block, a resolution bandwidth of at least one percent of the emission bandwidth of the fundamental emission of the transmitter may be employed.

27.53 (h)

For operations in the 1710 – 1755 MHz band, the FCC limit is  $43 + 10\log_{10}(P[\text{Watts}])$  dB below the transmitter power P(Watts) in a 1 MHz bandwidth. However, in the 1MHz bands immediately outside and adjacent to the licensee's frequency block, a resolution bandwidth of at least one percent of the emission bandwidth of the fundamental emission of the transmitter may be employed.

27.53 (g)

For operations in the 600MHz band and 698 -746 MHz band, the FCC limit is  $43 + 10\log_{10}(P[\text{Watts}])$  dB below the transmitter power P(Watts) in a 100 kHz bandwidth. However, in the 100 kilohertz bands immediately outside and adjacent to a licensee's frequency block, a resolution bandwidth of at least 30 kHz may be employed.

27.53(m)(4)

For mobile digital stations, the attenuation factor shall be not less than  $40 + 10 \log (P)$  dB on all frequencies between the channel edge and 5 megahertz from the channel edge,  $43 + 10 \log (P)$  dB on all frequencies between 5 megahertz and X megahertz from the channel edge, and  $55 + 10 \log (P)$  dB on all frequencies more than X megahertz from the channel edge, where X is the greater of 6 megahertz or the actual emission bandwidth as defined in paragraph (m)(6) of this section. In addition, the attenuation factor shall not be less that  $43 + 10 \log (P)$  dB on all frequencies between 2490.5 MHz and 2496 MHz and  $55 + 10 \log (P)$  dB at or below 2490.5 MHz. Mobile Satellite Service licensees operating on frequencies below 2495 MHz may also submit a documented interference complaint against BRS licensees operating on channel BRS Channel 1 on the same terms and conditions as adjacent channel BRS or EBS licensees.



### 3.7.2 Test Procedures

1. The testing follows ANSI C63.26 section 5.7
2. The EUT was connected to spectrum analyzer and system simulator via a power divider.
3. The band edges of low and high channels for the highest RF powers were measured.
4. Set RBW  $\geq$  1% EBW in the 1MHz band immediately outside and adjacent to the band edge.
5. Beyond the 1 MHz band from the band edge, RBW=1MHz was used or a narrower RBW was used (generally limited to no less than 1% of the OBW) and the measured power was integrated over the full required measurement bandwidth.
6. Set spectrum analyzer with RMS detector.
7. The RF fundamental frequency should be excluded against the limit line in the operating frequency band.
8. Checked that all the results comply with the emission limit line.

Example:

The limit line is derived from  $43 + 10\log(P)$ dB below the transmitter power P(Watts)

$$= P(W) - [43 + 10\log(P)] \text{ (dB)}$$

$$= [30 + 10\log(P)] \text{ (dBm)} - [43 + 10\log(P)] \text{ (dB)} = -13\text{dBm}.$$

9. For 5G NR n7/n38/n41, the other 40 dB, and 55 dB have additionally applied same calculation above.
10. When using the integration method, the starting frequency of the integration shall be centered at one-half of the RBW away from the band edge.



### 3.8 Conducted Spurious Emission

#### 3.8.1 Description of Conducted Spurious Emission Measurement

The power of any emission outside of the authorized operating frequency ranges must be lower than the transmitter power (P) by a factor of at least  $43 + 10 \log (P)$  dB.

For 5G NR n7/n38/n41:

The power of any emission outside of the authorized operating frequency ranges must be lower than the transmitter power (P) by a factor of at least  $55 + 10 \log (P)$  dB.

It is measured by means of a calibrated spectrum analyzer and scanned from 30 MHz up to a frequency including its 10<sup>th</sup> harmonic.

#### 3.8.2 Test Procedures

1. The testing follows ANSI C63.26 section 5.7
2. The EUT was connected to spectrum analyzer and system simulator via a power divider.
3. The RF output of EUT was connected to the spectrum analyzer by RF cable and attenuator. The path loss was compensated to the results for each measurement.
4. The middle channel for the highest RF power within the transmitting frequency was measured.
5. The conducted spurious emission for the whole frequency range was taken.
6. Make the measurement with the spectrum analyzer's RBW = 1MHz, VBW = 3MHz.
7. Set spectrum analyzer with RMS detector.
8. Taking the record of maximum spurious emission.
9. The RF fundamental frequency should be excluded against the limit line in the operating frequency band.
10. The limit line is derived from  $43 + 10\log(P)$ dB below the transmitter power P(Watts)  
 $= P(W) - [43 + 10\log(P)]$  (dB)  
 $= [30 + 10\log(P)]$  (dBm) -  $[43 + 10\log(P)]$  (dB)  
 $= -13$ dBm.
11. For 5G NR n7/n38/n41  
The limit line is derived from  $55 + 10\log(P)$ dB below the transmitter power P(Watts)  
 $= P(W) - [55 + 10\log(P)]$  (dB)  
 $= [30 + 10\log(P)]$  (dBm) -  $[55 + 10\log(P)]$  (dB)  
 $= -25$ dBm.



## 3.9 Frequency Stability

### 3.9.1 Description of Frequency Stability Measurement

The frequency stability shall be measured by variation of ambient temperature and variation of primary supply voltage to ensure that the fundamental emission stays within the authorized frequency block. The frequency stability of the transmitter shall be maintained within  $\pm 0.00025\%$  ( $\pm 2.5\text{ppm}$ ) of the center frequency.

### 3.9.2 Test Procedures for Temperature Variation

1. The testing follows ANSI C63.26 section 5.6.4
2. The EUT was set up in the thermal chamber and connected with the system simulator.
3. With power OFF, the temperature was decreased to  $-30^{\circ}\text{C}$  and the EUT was stabilized before testing. Power was applied and the maximum change in frequency was recorded within one minute.
4. With power OFF, the temperature was raised in  $10^{\circ}\text{C}$  step up to  $50^{\circ}\text{C}$ . The EUT was stabilized at each step for at least half an hour. Power was applied and the maximum frequency change was recorded within one minute.

### 3.9.3 Test Procedures for Voltage Variation

1. The testing follows ANSI C63.26 section 5.6.5
2. The EUT was placed in a temperature chamber at  $20\pm 5^{\circ}\text{C}$  and connected with the system simulator.
3. The power supply voltage to the EUT was varied from 85% to 115% of the nominal value for other than hand carried battery equipment.
4. For hand carried, battery powered equipment, reduce the primary ac or dc supply voltage to the battery operating end point, which shall be specified by the manufacturer.
5. The variation in frequency was measured for the worst case.

## 4 Radiated Test Items

### 4.1 Measuring Instruments

See list of measuring instruments of this test report.

### 4.2 Test Setup

#### 4.2.1 For radiated test below 30MHz

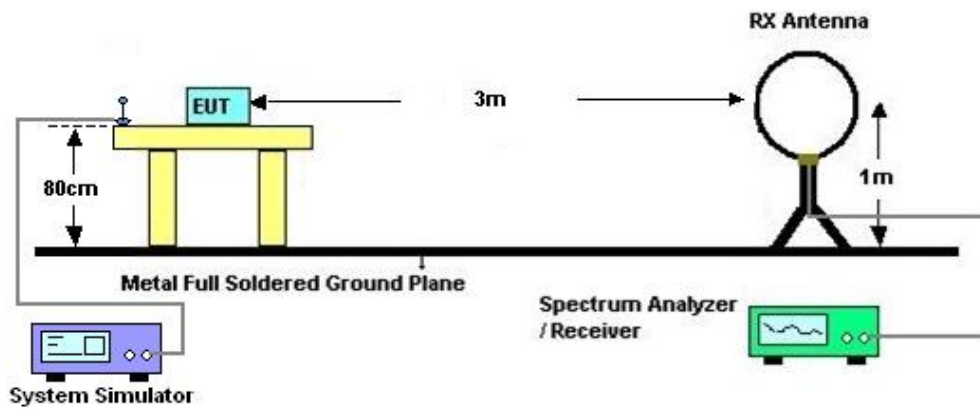

#### 4.2.2 For radiated test from 30MHz to 1GHz

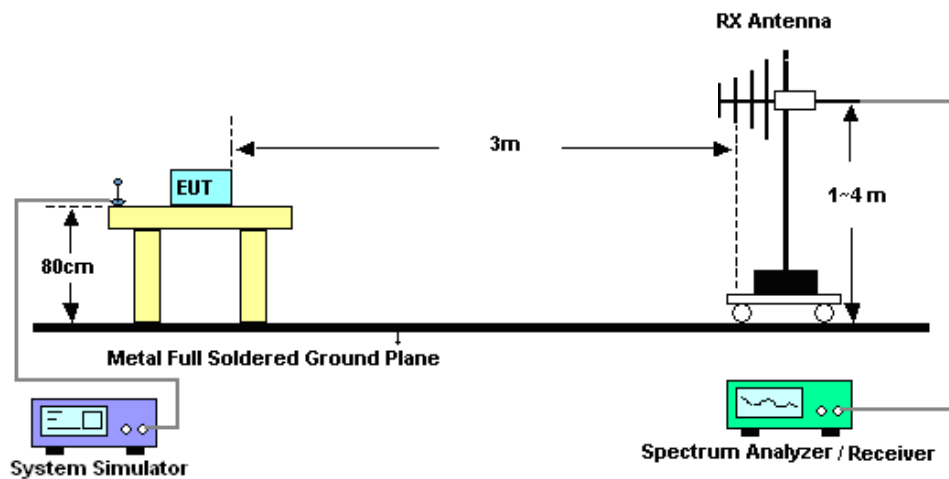



#### 4.2.3 For radiated test above 1GHz

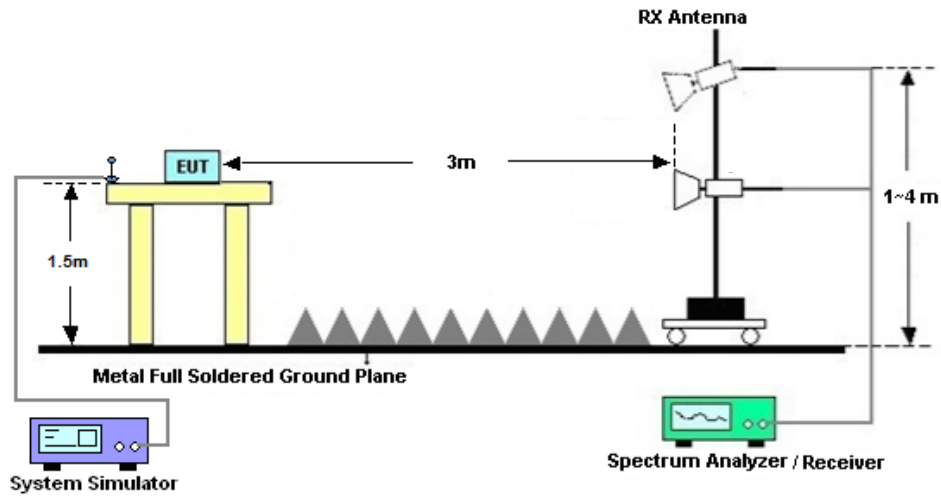

#### 4.3 Test Result of Radiated Test

The low frequency, which started from 9 kHz to 30MHz, was pre-scanned and the result which was 20dB lower than the limit line was not reported.

Please refer to Appendix B.



## 4.4 Radiated Spurious Emission

### 4.4.1 Description of Radiated Spurious Emission

The radiated spurious emission was measured by substitution method according to ANSI C63.26. The power of any emission outside of the authorized operating frequency ranges must be attenuated below the transmitter power (P) by a factor of at least  $43 + 10 \log (P)$  dB.

For 5G NR n7/n38/n41

The power of any emission outside of the authorized operating frequency ranges must be attenuated below the transmitter power (P) by a factor of at least  $55 + 10 \log (P)$  dB.

The spectrum is scanned from 30 MHz up to a frequency including its 10th harmonic.

### 4.4.2 Test Procedures

1. The testing follows ANSI C63.26 Section 5.5
2. The EUT was placed on a turntable with 0.8 meter height for frequency below 1GHz and 1.5 meter height for frequency above 1GHz respectively above ground.
3. The EUT was set 3 meters from the receiving antenna mounted on the antenna tower.
4. The table was rotated 360 degrees to determine the position of the highest spurious emission.
5. The height of the receiving antenna is varied between 1m to 4m to search the maximum spurious emission for both horizontal and vertical polarizations.
6. During the measurement, the system simulator parameters were set to force the EUT transmitting at maximum output power.
7. Make the measurement with the spectrum analyzer's RBW = 1MHz, VBW = 3MHz, taking the record of maximum spurious emission.
8. A horn antenna was substituted in place of the EUT and was driven by a signal generator.
9. Tune the output power of signal generator to the same emission level with EUT maximum spurious emission.
10.  $EIRP (dBm) = S.G. Power - Tx Cable Loss + Tx Antenna Gain$
11.  $ERP (dBm) = EIRP - 2.15$
12. The RF fundamental frequency should be excluded against the limit line in the operating frequency band.

The limit line is derived from  $43 + 10\log(P)$ dB below the transmitter power P(Watts)  
 $= P(W) - [43 + 10\log(P)] (dB)$   
 $= [30 + 10\log(P)] (dBm) - [43 + 10\log(P)] (dB)$   
 $= -13dBm.$

13. For 5G NR n7/n38/n41:

The limit line is derived from  $55 + 10\log(P)$ dB below the transmitter power P(Watts)The limit line is derived from  $55 + 10\log(P)$ dB below the transmitter power P(Watts)



## 5 List of Measuring Equipment

Instrument	Manufacturer	Model No.	Serial No.	Characteristics	Calibration Date	Test Date	Due Date	Remark
EXA Spectrum Analyzer	Keysight	N9010B	MY57471079	10Hz-44G,MAX 30dB	Oct. 12, 2022	Mar. 02, 2023~ Mar. 14, 2023	Oct. 11, 2023	Conducted (TH01-KS)
Power divider	STI	STI08-0055	-	0.5~40GHz	NCR	Mar. 02, 2023~ Mar. 14, 2023	NCR	Conducted (TH01-KS)
Temperature &	Hongzhan	LP-150U	H2014011440	-40~+150°C 20%~95%RH	Jul. 15, 2022	Mar. 02, 2023~ Mar. 14, 2023	Jul. 14, 2023	Conducted (TH01-KS)
EXA Spectrum Analyzer	Keysight	N9010B	MY57471079	10Hz-44G,MAX 30dB	Oct. 12, 2022	Mar. 16, 2023	Oct. 11, 2023	Radiation (03CH04-KS)
Bilog Antenna	TeseQ	CBL6111D	49922	30MHz-1GHz	May 24, 2022	Mar. 16, 2023	May 23, 2023	Radiation (03CH04-KS)
Horn Antenna	Schwarzbeck	BBHA9120D	1284	1GHz~18GHz	Oct. 16, 2022	Mar. 16, 2023	Oct. 15, 2023	Radiation (03CH04-KS)
SHF-EHF Horn	Com-power	AH-840	101070	18GHz~40GHz	Jan. 08, 2023	Mar. 16, 2023	Jan. 07, 2024	Radiation (03CH04-KS)
Amplifier	SONOMA	310N	187289	9KHz-1GHz	May 24, 2022	Mar. 16, 2023	May 23, 2023	Radiation (03CH04-KS)
Amplifier	MITEQ	EM18G40G GA	060728	18~40GHz	Jan. 05, 2023	Mar. 16, 2023	Jan. 04, 2024	Radiation (03CH04-KS)
high gain Amplifier	EM	EM01G18G A	060840	1Ghz-18Ghz	Oct. 12, 2022	Mar. 16, 2023	Oct. 11, 2023	Radiation (03CH04-KS)
Amplifier	Agilent	8449B	3008A02370	1Ghz-18Ghz	Oct. 12, 2022	Mar. 16, 2023	Oct. 11, 2023	Radiation (03CH04-KS)
AC Power Source	Chroma	61601	F104090004	N/A	NCR	Mar. 16, 2023	NCR	Radiation (03CH04-KS)
Turn Table	ChamPro	EM 1000-T	060762-T	0~360 degree	NCR	Mar. 16, 2023	NCR	Radiation (03CH04-KS)
Antenna Mast	ChamPro	EM 1000-A	060762-A	1 m~4 m	NCR	Mar. 16, 2023	NCR	Radiation (03CH04-KS)

NCR: No Calibration Required



## 6 Uncertainty of Evaluation

The measurement uncertainties shown below were calculated in accordance with the requirements of ANSI 63.26-2015. All the measurement uncertainty value were shown with a coverage K=2 to indicate 95% level of confidence. The measurement data show herein meets or exceeds the CISPR measurement uncertainty values specified in CISPR 16-4-2 and can be compared directly to specified limit to determine compliance.

### Uncertainty of Conducted Measurement

Test Item	Uncertainty
Conducted Power	±0.46 dB
Conducted Emissions	±0.48 dB
Occupied Channel Bandwidth	±0.1 %

### Uncertainty of Radiated Emission Measurement (30 MHz ~ 1000 MHz)

Measuring Uncertainty for a Level of Confidence of 95% (U = 2Uc(y))	3.3dB
---	-------

### Uncertainty of Radiated Emission Measurement (1 GHz ~ 18 GHz)

Measuring Uncertainty for a Level of Confidence of 95% (U = 2Uc(y))	2.8dB
---	-------

### Uncertainty of Radiated Emission Measurement (18 GHz ~ 40 GHz)

Measuring Uncertainty for a Level of Confidence of 95% (U = 2Uc(y))	2.8dB
---	-------

----- THE END -----



## Appendix A. Test Results of Conducted Test

Test Engineer :	Simle Wang	Temperature :	22~23°C
		Relative Humidity :	40~42%

## FR1 N5(ANT1)

### Transmitter Conducted Output Power And ERP, (G<sub>T</sub>-L<sub>C</sub>)=0.04dB

NR Band	SCS	BandWidth	Arfcn	Freq (MHz)	Modulation	RB	Conducted Power (dBm)	ERP (dBm)	ERP (W)
5	15	5	165300	826.5	DFT-s-OFDM PI/2 BPSK	1@1	24.66	22.55	0.1799
5	15	5	167300	836.5	DFT-s-OFDM PI/2 BPSK	1@1	24.53	22.42	0.1746
5	15	5	169300	846.5	DFT-s-OFDM PI/2 BPSK	1@1	24.41	22.3	0.1698
5	15	10	165800	829	DFT-s-OFDM PI/2 BPSK	1@1	24.59	22.48	0.1770
5	15	10	167300	836.5	DFT-s-OFDM PI/2 BPSK	1@1	24.55	22.44	0.1754
5	15	10	168800	844	DFT-s-OFDM PI/2 BPSK	1@1	24.48	22.37	0.1726
5	15	15	166300	831.5	DFT-s-OFDM PI/2 BPSK	1@1	24.67	22.56	0.1803
5	15	15	167300	836.5	DFT-s-OFDM PI/2 BPSK	1@1	24.64	22.53	0.1791
5	15	15	168300	841.5	DFT-s-OFDM PI/2 BPSK	1@1	24.53	22.42	0.1746
5	15	20	166800	834	DFT-s-OFDM PI/2 BPSK	50@25	24.6	22.49	0.1774
5	15	20	166800	834	DFT-s-OFDM PI/2 BPSK	1@1	24.7	22.59	0.1816
5	15	20	166800	834	DFT-s-OFDM PI/2 BPSK	1@104	24.43	22.32	0.1706
5	15	20	166800	834	DFT-s-OFDM QPSK	50@25	24.59	22.48	0.1770
5	15	20	166800	834	DFT-s-OFDM QPSK	1@1	24.82	22.71	0.1866
5	15	20	166800	834	DFT-s-OFDM QPSK	1@104	24.54	22.43	0.1750
5	15	20	166800	834	DFT-s-OFDM 16 QAM	50@25	23.59	21.48	0.1406
5	15	20	166800	834	DFT-s-OFDM 16 QAM	1@1	23.84	21.73	0.1489
5	15	20	166800	834	DFT-s-OFDM 16 QAM	1@104	23.51	21.4	0.1380
5	15	20	166800	834	DFT-s-OFDM 64 QAM	50@25	22.17	20.06	0.1014
5	15	20	166800	834	DFT-s-OFDM 64 QAM	1@1	22.4	20.29	0.1069
5	15	20	166800	834	DFT-s-OFDM 64 QAM	1@104	22.1	19.99	0.0998
5	15	20	166800	834	DFT-s-OFDM 256 QAM	50@25	19.89	17.78	0.0600
5	15	20	166800	834	DFT-s-OFDM 256 QAM	1@1	19.87	17.76	0.0597
5	15	20	166800	834	DFT-s-OFDM 256 QAM	1@104	19.6	17.49	0.0561
5	15	20	166800	834	CP-OFDM QPSK	1@1	23.21	21.1	0.1288
5	15	20	167300	836.5	DFT-s-OFDM PI/2 BPSK	50@25	24.55	22.44	0.1754
5	15	20	167300	836.5	DFT-s-OFDM PI/2 BPSK	1@1	24.7	22.59	0.1816
5	15	20	167300	836.5	DFT-s-OFDM PI/2 BPSK	1@104	24.27	22.16	0.1644
5	15	20	167300	836.5	DFT-s-OFDM QPSK	50@25	24.61	22.5	0.1778
5	15	20	167300	836.5	DFT-s-OFDM QPSK	1@1	24.79	22.68	0.1854
5	15	20	167300	836.5	DFT-s-OFDM QPSK	1@104	24.49	22.38	0.1730
5	15	20	167300	836.5	DFT-s-OFDM 16 QAM	50@25	23.51	21.4	0.1380
5	15	20	167300	836.5	DFT-s-OFDM 16 QAM	1@1	23.81	21.7	0.1479
5	15	20	167300	836.5	DFT-s-OFDM 16 QAM	1@104	23.42	21.31	0.1352
5	15	20	167300	836.5	DFT-s-OFDM 64 QAM	50@25	22.14	20.03	0.1007
5	15	20	167300	836.5	DFT-s-OFDM 64 QAM	1@1	22.32	20.21	0.1050
5	15	20	167300	836.5	DFT-s-OFDM 64 QAM	1@104	22.02	19.91	0.0979
5	15	20	167300	836.5	DFT-s-OFDM 256 QAM	50@25	19.97	17.86	0.0611
5	15	20	167300	836.5	DFT-s-OFDM 256 QAM	1@1	19.97	17.86	0.0611
5	15	20	167300	836.5	DFT-s-OFDM 256 QAM	1@104	19.51	17.4	0.0550

5	15	20	167300	836.5	CP-OFDM QPSK	1@1	23.31	21.2	0.1318
5	15	20	167800	839	DFT-s-OFDM PI/2 BPSK	50@25	24.51	22.4	0.1738
5	15	20	167800	839	DFT-s-OFDM PI/2 BPSK	1@1	24.61	22.5	0.1778
5	15	20	167800	839	DFT-s-OFDM PI/2 BPSK	1@104	24.23	22.12	0.1629
5	15	20	167800	839	DFT-s-OFDM QPSK	50@25	24.53	22.42	0.1746
5	15	20	167800	839	DFT-s-OFDM QPSK	1@1	24.78	22.67	0.1849
5	15	20	167800	839	DFT-s-OFDM QPSK	1@104	24.39	22.28	0.1690
5	15	20	167800	839	DFT-s-OFDM 16 QAM	50@25	23.54	21.43	0.1390
5	15	20	167800	839	DFT-s-OFDM 16 QAM	1@1	23.75	21.64	0.1459
5	15	20	167800	839	DFT-s-OFDM 16 QAM	1@104	23.39	21.28	0.1343
5	15	20	167800	839	DFT-s-OFDM 64 QAM	50@25	22.08	19.97	0.0993
5	15	20	167800	839	DFT-s-OFDM 64 QAM	1@1	22.32	20.21	0.1050
5	15	20	167800	839	DFT-s-OFDM 64 QAM	1@104	21.94	19.83	0.0962
5	15	20	167800	839	DFT-s-OFDM 256 QAM	50@25	19.97	17.86	0.0611
5	15	20	167800	839	DFT-s-OFDM 256 QAM	1@1	19.9	17.79	0.0601
5	15	20	167800	839	DFT-s-OFDM 256 QAM	1@104	19.53	17.42	0.0552
5	15	20	167800	839	CP-OFDM QPSK	1@1	23.26	21.15	0.1303

## Frequency Stability

NR Band	SCS (kHz)	Bandwidth (MHz)	Arfcn	Freq (MHz)	Modulation	RB	Deviation (ppm)	Verdict	Environment
5	15	20	167300	836.5	DFT-s-OFDM QPSK	100@0	-0.0012	PASS	NV
5	15	20	167300	836.5	DFT-s-OFDM QPSK	100@0	0.0013	PASS	LV
5	15	20	167300	836.5	DFT-s-OFDM QPSK	100@0	0.0026	PASS	HV
5	15	20	167300	836.5	DFT-s-OFDM QPSK	100@0	0.0024	PASS	-30°C
5	15	20	167300	836.5	DFT-s-OFDM QPSK	100@0	0.0011	PASS	-20°C
5	15	20	167300	836.5	DFT-s-OFDM QPSK	100@0	-0.0017	PASS	-10°C
5	15	20	167300	836.5	DFT-s-OFDM QPSK	100@0	0.0023	PASS	0°C
5	15	20	167300	836.5	DFT-s-OFDM QPSK	100@0	0.0022	PASS	10°C
5	15	20	167300	836.5	DFT-s-OFDM QPSK	100@0	0.0021	PASS	20°C
5	15	20	167300	836.5	DFT-s-OFDM QPSK	100@0	0.0015	PASS	30°C
5	15	20	167300	836.5	DFT-s-OFDM QPSK	100@0	-0.0031	PASS	40°C
5	15	20	167300	836.5	DFT-s-OFDM QPSK	100@0	0.0019	PASS	50°C



## Peak to Average Ratio

NR Band	SCS (kHz)	Bandwidth (MHz)	Arfcn	Freq (MHz)	Modulation	RB	Result (dB)	Limit (dB)	Verdict
5	15	20	167300	836.5	DFT-s-OFDM PI/2 BPSK	100@0	4.03	13	PASS
5	15	20	167300	836.5	DFT-s-OFDM PI/2 BPSK	1@0	4.02	13	PASS
5	15	20	167300	836.5	DFT-s-OFDM QPSK	100@0	5.05	13	PASS
5	15	20	167300	836.5	DFT-s-OFDM QPSK	1@0	5.16	13	PASS

N5(20M)\_DFT-s-OFDM\_PI\_2-BPSK\_Outer\_Full\_Mid\_CH



N5(20M)\_DFT-s-OFDM\_PI\_2-BPSK\_Edge\_1RB\_Left\_Mid\_CH



N5(20M)\_DFT-s-OFDM\_QPSK\_Outer\_Full\_Mid\_CH



N5(20M)\_DFT-s-OFDM\_QPSK\_Edge\_1RB\_Left\_Mid\_CH

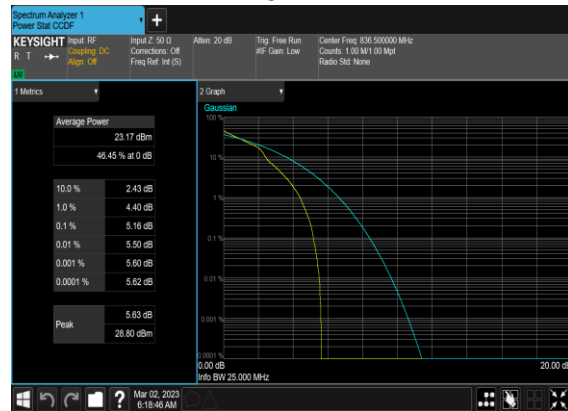

## Occupied Bandwidth

NR Band	SCS (kHz)	Bandwidth (MHz)	Arfcn	Freq (MHz)	Modulation	RB	OBW (MHz)	26dB BW (MHz)
5	15	5	167300	836.5	CP-OFDM QPSK	25@0	4.4619	4.865
5	15	5	167300	836.5	CP-OFDM 16 QAM	25@0	4.4893	4.875
5	15	5	167300	836.5	CP-OFDM 64 QAM	25@0	4.4556	4.86
5	15	5	167300	836.5	CP-OFDM 256 QAM	25@0	4.4726	4.914
5	15	10	167300	836.5	CP-OFDM QPSK	52@0	9.2631	9.826
5	15	10	167300	836.5	CP-OFDM 16 QAM	52@0	9.2814	9.84
5	15	10	167300	836.5	CP-OFDM 64 QAM	52@0	9.2506	9.822
5	15	10	167300	836.5	CP-OFDM 256 QAM	52@0	9.2628	9.834
5	15	15	167300	836.5	CP-OFDM QPSK	79@0	14.05	14.76
5	15	15	167300	836.5	CP-OFDM 16 QAM	79@0	14.067	14.69
5	15	15	167300	836.5	CP-OFDM 64 QAM	79@0	14.063	14.69
5	15	15	167300	836.5	CP-OFDM 256 QAM	79@0	14.056	14.81
5	15	20	167300	836.5	CP-OFDM QPSK	106@0	18.857	19.7
5	15	20	167300	836.5	CP-OFDM 16 QAM	106@0	18.847	19.69
5	15	20	167300	836.5	CP-OFDM 64 QAM	106@0	18.847	19.63
5	15	20	167300	836.5	CP-OFDM 256 QAM	106@0	18.802	19.63

### N5(5M)\_CP-OFDM\_QPSK\_Outer\_Full\_Mid\_CH

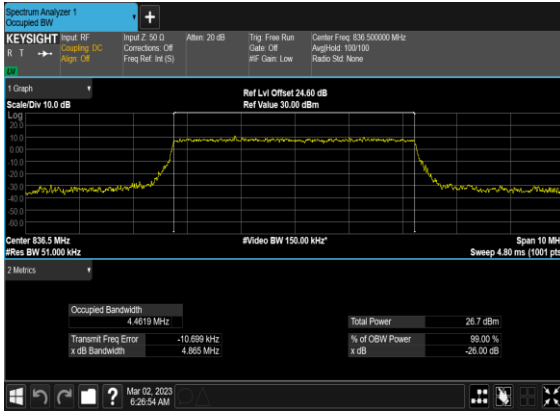

### N5(5M)\_CP-OFDM\_16QAM\_Outer\_Full\_Mid\_CH

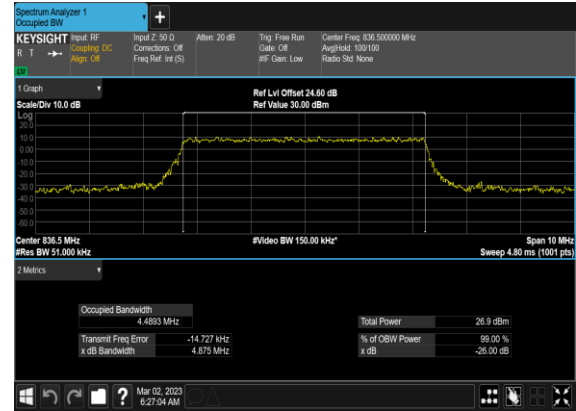

### N5(5M)\_CP-OFDM\_64QAM\_Outer\_Full\_Mid\_CH

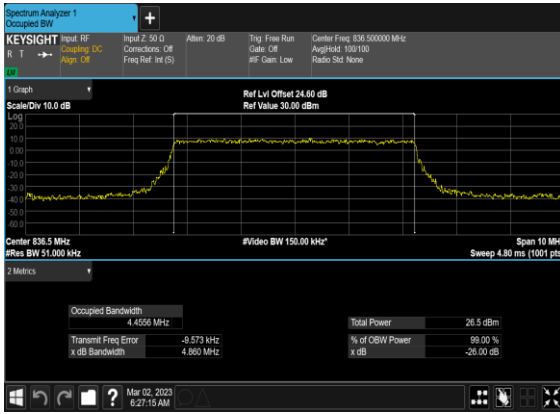

### N5(5M)\_CP-OFDM\_256QAM\_Outer\_Full\_Mid\_CH



### N5(10M)\_CP-OFDM\_QPSK\_Outer\_Full\_Mid\_CH

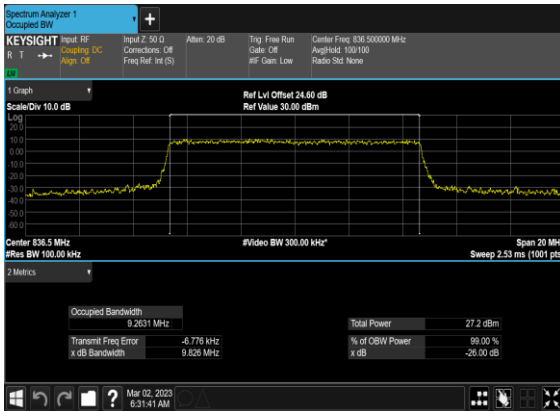

### N5(10M)\_CP-OFDM\_16QAM\_Outer\_Full\_Mid\_CH

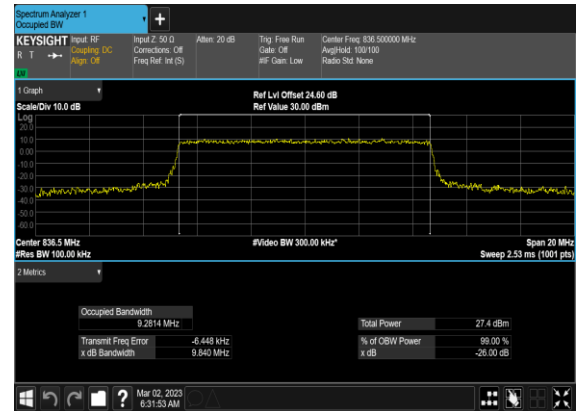

### N5(10M)\_CP-OFDM\_64 QAM\_Outer\_Full\_Mid\_CH

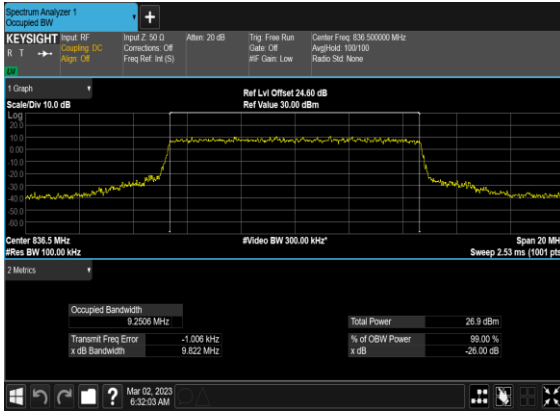

### N5(10M)\_CP-OFDM\_256 QAM\_Outer\_Full\_Mid\_CH

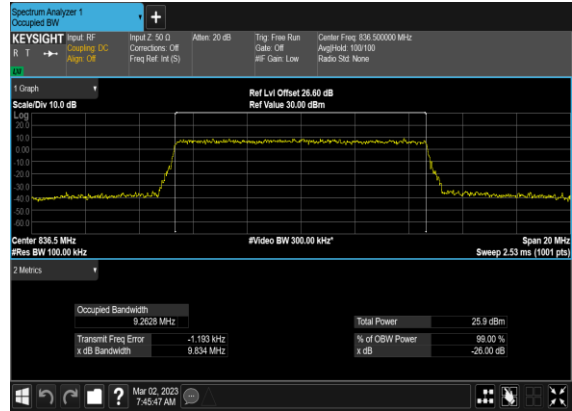

### N5(15M)\_CP- OFDM\_QPSK\_Outer\_Full\_Mid\_CH

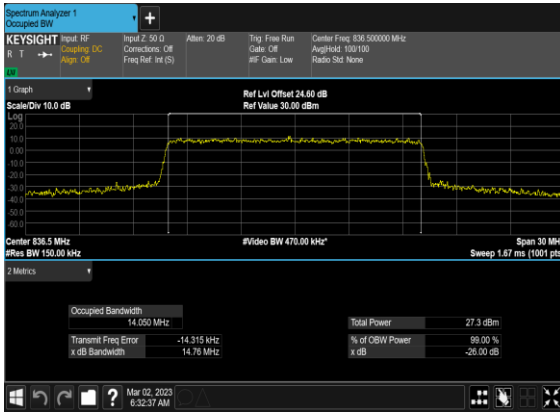

### N5(15M)\_CP-OFDM\_16 QAM\_Outer\_Full\_Mid\_CH



### N5(15M)\_CP-OFDM\_64 QAM\_Outer\_Full\_Mid\_CH

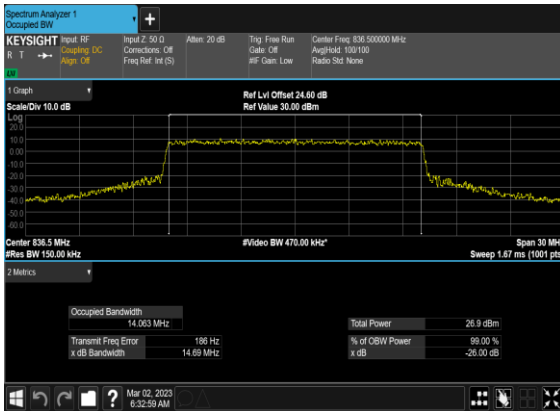

### N5(15M)\_CP-OFDM\_256 QAM\_Outer\_Full\_Mid\_CH

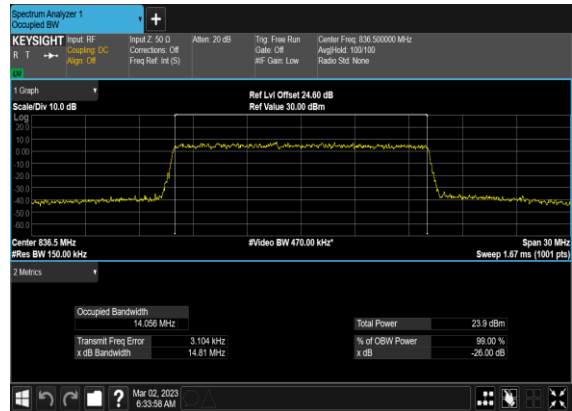

### N5(20M)\_CP- OFDM\_QPSK\_Outer\_Full\_Mid\_CH



### N5(20M)\_CP-OFDM\_16 QAM\_Outer\_Full\_Mid\_CH



### N5(20M)\_CP-OFDM\_64 QAM\_Outer\_Full\_Mid\_CH

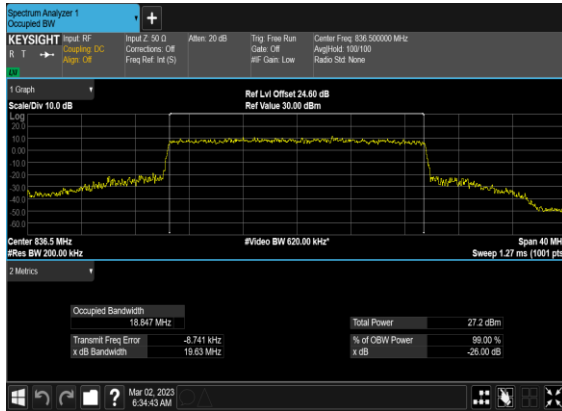

### N5(20M)\_CP-OFDM\_256 QAM\_Outer\_Full\_Mid\_CH

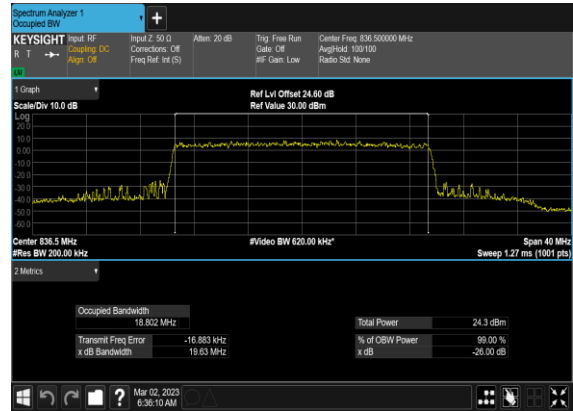

## Conducted Spurious Emissions

NR Band	SCS (kHz)	Bandwidth (MHz)	Arfcn	Freq (MHz)	Modulation	RB	Result	Verdict
5	15	5	165300	826.5	DFT-s-OFDM BPSK	1@0	see graph	---
5	15	5	165300	826.5	DFT-s-OFDM BPSK	1@0	see graph	PASS
5	15	5	165300	826.5	DFT-s-OFDM QPSK	1@0	see graph	---
5	15	5	165300	826.5	DFT-s-OFDM QPSK	1@0	see graph	PASS
5	15	5	167300	836.5	DFT-s-OFDM BPSK	1@0	see graph	---
5	15	5	167300	836.5	DFT-s-OFDM BPSK	1@0	see graph	PASS
5	15	5	167300	836.5	DFT-s-OFDM QPSK	1@0	see graph	---
5	15	5	167300	836.5	DFT-s-OFDM QPSK	1@0	see graph	PASS
5	15	5	169300	846.5	DFT-s-OFDM BPSK	1@0	see graph	---
5	15	5	169300	846.5	DFT-s-OFDM BPSK	1@0	see graph	PASS
5	15	5	169300	846.5	DFT-s-OFDM QPSK	1@0	see graph	---
5	15	5	169300	846.5	DFT-s-OFDM QPSK	1@0	see graph	PASS
5	15	15	166300	831.5	DFT-s-OFDM BPSK	1@0	see graph	---
5	15	15	166300	831.5	DFT-s-OFDM BPSK	1@0	see graph	PASS
5	15	15	166300	831.5	DFT-s-OFDM QPSK	1@0	see graph	---
5	15	15	166300	831.5	DFT-s-OFDM QPSK	1@0	see graph	PASS
5	15	15	167300	836.5	DFT-s-OFDM BPSK	1@0	see graph	---
5	15	15	167300	836.5	DFT-s-OFDM BPSK	1@0	see graph	PASS
5	15	15	167300	836.5	DFT-s-OFDM QPSK	1@0	see graph	---
5	15	15	167300	836.5	DFT-s-OFDM QPSK	1@0	see graph	PASS
5	15	15	168300	841.5	DFT-s-OFDM BPSK	1@0	see graph	---
5	15	15	168300	841.5	DFT-s-OFDM BPSK	1@0	see graph	PASS
5	15	15	168300	841.5	DFT-s-OFDM QPSK	1@0	see graph	---

5	15	15	168300	841.5	DFT-s-OFDM QPSK	1@0	see graph	<b>PASS</b>
5	15	20	166800	834.0	DFT-s-OFDM BPSK	1@0	see graph	---
5	15	20	166800	834.0	DFT-s-OFDM BPSK	1@0	see graph	<b>PASS</b>
5	15	20	166800	834.0	DFT-s-OFDM QPSK	1@0	see graph	---
5	15	20	166800	834.0	DFT-s-OFDM QPSK	1@0	see graph	<b>PASS</b>
5	15	20	167300	836.5	DFT-s-OFDM BPSK	1@0	see graph	---
5	15	20	167300	836.5	DFT-s-OFDM BPSK	1@0	see graph	<b>PASS</b>
5	15	20	167300	836.5	DFT-s-OFDM QPSK	1@0	see graph	---
5	15	20	167300	836.5	DFT-s-OFDM QPSK	1@0	see graph	<b>PASS</b>
5	15	20	167800	839.0	DFT-s-OFDM BPSK	1@0	see graph	---
5	15	20	167800	839.0	DFT-s-OFDM BPSK	1@0	see graph	<b>PASS</b>
5	15	20	167800	839.0	DFT-s-OFDM QPSK	1@0	see graph	---
5	15	20	167800	839.0	DFT-s-OFDM QPSK	1@0	see graph	<b>PASS</b>



### N5(5M)\_DFT-s-OFDM\_BPSK\_Edge\_1RB\_Left\_Low\_CH



### N5(5M)\_DFT-s-OFDM\_QPSK\_Edge\_1RB\_Left\_Low\_CH

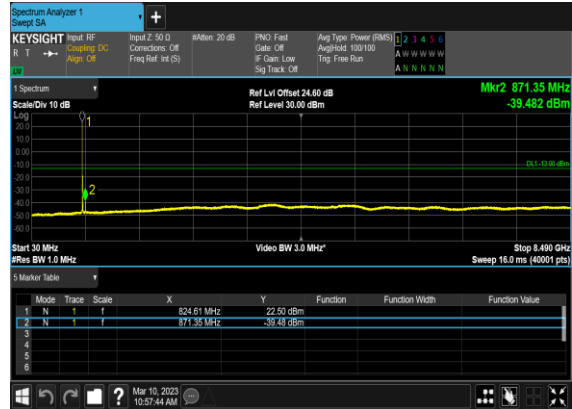

### N5(5M)\_DFT-s-OFDM\_BPSK\_Edge\_1RB\_Left\_Mid\_CH

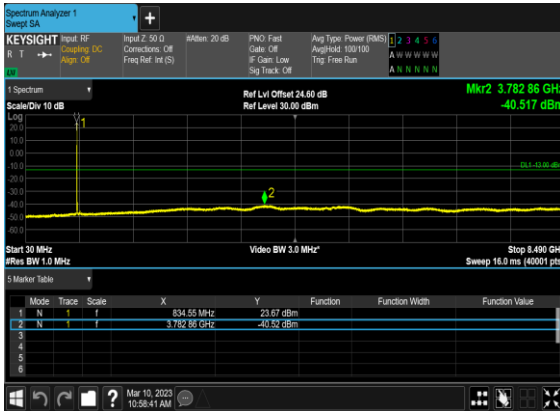

### N5(5M)\_DFT-s-OFDM\_QPSK\_Edge\_1RB\_Left\_Mid\_CH



### N5(5M)\_DFT-s-OFDM\_BPSK\_Edge\_1RB\_Left\_High\_CH

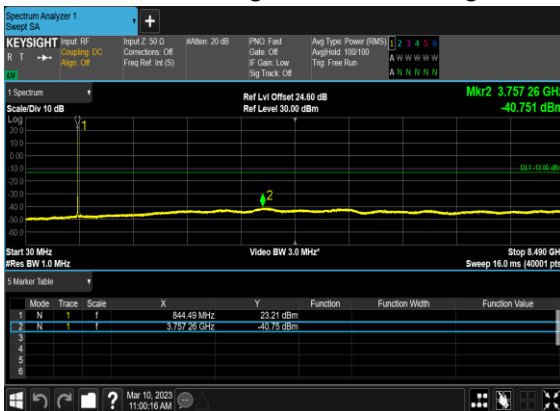

### N5(5M)\_DFT-s-OFDM\_QPSK\_Edge\_1RB\_Left\_High\_CH

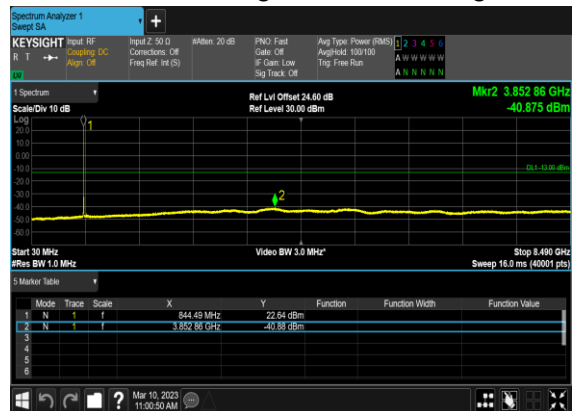

### N5(15M)\_DFT-s-OFDM\_BPSK\_Edge\_1RB\_Left\_Low\_CH



### N5(15M)\_DFT-s-OFDM\_QPSK\_Edge\_1RB\_Left\_Low\_CH



### N5(15M)\_DFT-s-OFDM\_BPSK\_Edge\_1RB\_Left\_Mid\_CH



### N5(15M)\_DFT-s-OFDM\_QPSK\_Edge\_1RB\_Left\_Mid\_CH

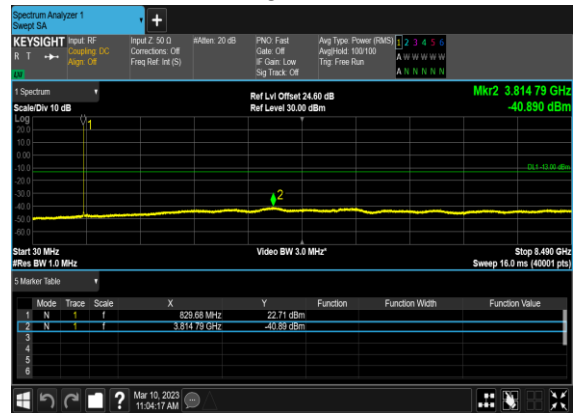

### N5(15M)\_DFT-s-OFDM\_BPSK\_Edge\_1RB\_Left\_High\_CH

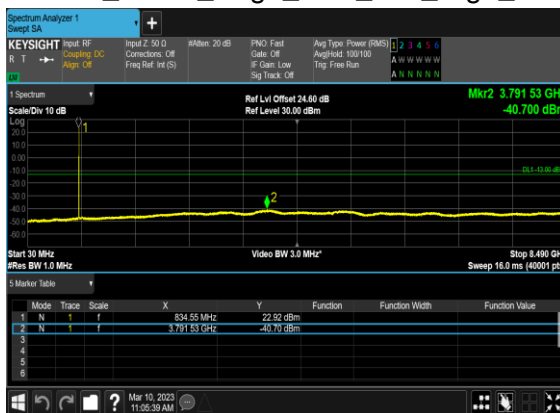

### N5(15M)\_DFT-s-OFDM\_QPSK\_Edge\_1RB\_Left\_High\_CH

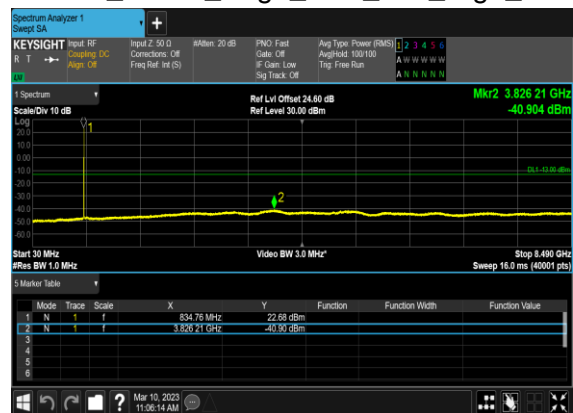

N5(20M)\_DFT-s-OFDM\_BPSK\_Edge\_1RB\_Left\_Low\_CH

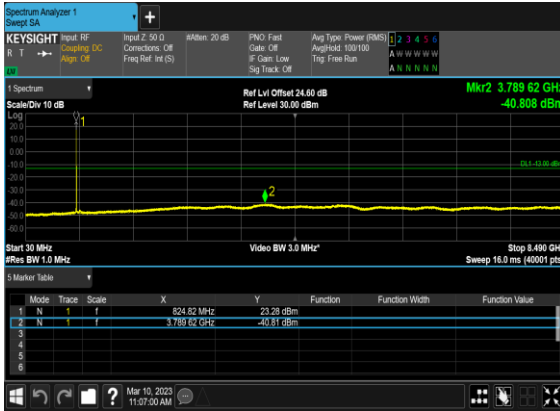

N5(20M)\_DFT-s-OFDM\_QPSK\_Edge\_1RB\_Left\_Low\_CH

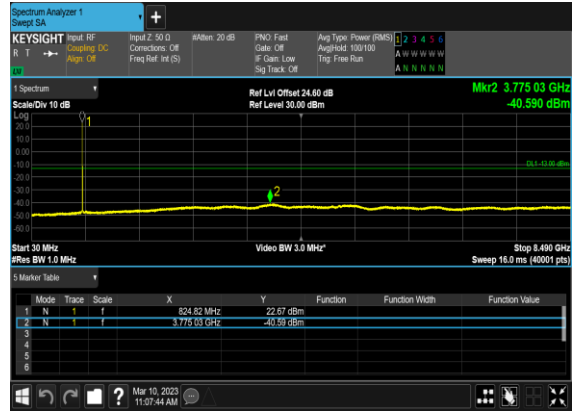

N5(20M)\_DFT-s-OFDM\_BPSK\_Edge\_1RB\_Left\_Mid\_CH

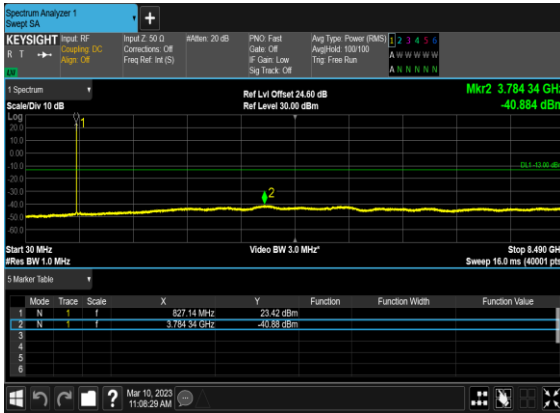

N5(20M)\_DFT-s-OFDM\_QPSK\_Edge\_1RB\_Left\_Mid\_CH

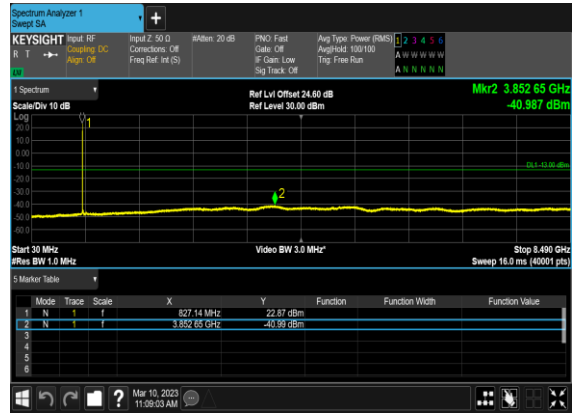

N5(20M)\_DFT-s-OFDM\_BPSK\_Edge\_1RB\_Left\_High\_CH

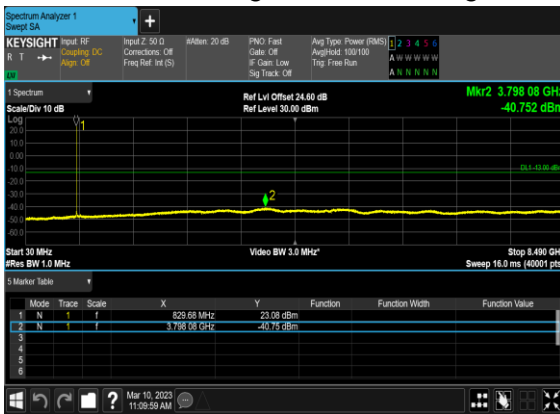

N5(20M)\_DFT-s-OFDM\_QPSK\_Edge\_1RB\_Left\_High\_CH

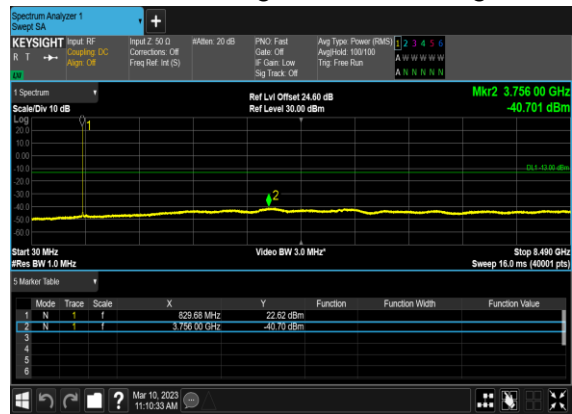

## Conducted Band Edge

NR Band	SCS (kHz)	Bandwidth (MHz)	Arfcn	Freq (MHz)	Modulation	RB	Result	Verdict
5	15	5	165300	826.5	DFT-s-OFDM BPSK	1@0	see graph	PASS
5	15	5	165300	826.5	DFT-s-OFDM QPSK	1@0	see graph	PASS
5	15	5	165300	826.5	DFT-s-OFDM BPSK	25@0	see graph	PASS
5	15	5	165300	826.5	DFT-s-OFDM QPSK	25@0	see graph	PASS
5	15	5	169300	846.5	DFT-s-OFDM BPSK	1@24	see graph	PASS
5	15	5	169300	846.5	DFT-s-OFDM QPSK	1@24	see graph	PASS
5	15	5	169300	846.5	DFT-s-OFDM BPSK	25@0	see graph	PASS
5	15	5	169300	846.5	DFT-s-OFDM QPSK	25@0	see graph	PASS
5	15	15	166300	831.5	DFT-s-OFDM BPSK	1@0	see graph	PASS
5	15	15	166300	831.5	DFT-s-OFDM QPSK	1@0	see graph	PASS
5	15	15	166300	831.5	DFT-s-OFDM BPSK	75@0	see graph	PASS
5	15	15	166300	831.5	DFT-s-OFDM QPSK	75@0	see graph	PASS
5	15	15	168300	841.5	DFT-s-OFDM BPSK	1@78	see graph	PASS
5	15	15	168300	841.5	DFT-s-OFDM QPSK	1@78	see graph	PASS
5	15	15	168300	841.5	DFT-s-OFDM BPSK	75@0	see graph	PASS
5	15	15	168300	841.5	DFT-s-OFDM QPSK	75@0	see graph	PASS
5	15	20	166800	834.0	DFT-s-OFDM BPSK	1@0	see graph	PASS
5	15	20	166800	834.0	DFT-s-OFDM QPSK	1@0	see graph	PASS
5	15	20	166800	834.0	DFT-s-OFDM BPSK	100@0	see graph	PASS
5	15	20	166800	834.0	DFT-s-OFDM QPSK	100@0	see graph	PASS
5	15	20	167800	839.0	DFT-s-OFDM BPSK	1@105	see graph	PASS
5	15	20	167800	839.0	DFT-s-OFDM QPSK	1@105	see graph	PASS
5	15	20	167800	839.0	DFT-s-OFDM BPSK	100@0	see graph	PASS
5	15	20	167800	839.0	DFT-s-OFDM QPSK	100@0	see graph	PASS

### N5(5M)\_DFT-s-OFDM\_BPSK\_Edge\_1RB\_Left\_Low\_CH

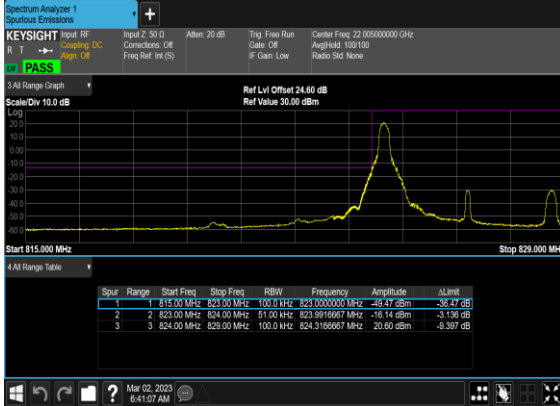

### N5(5M)\_DFT-s-OFDM\_QPSK\_Edge\_1RB\_Left\_Low\_CH

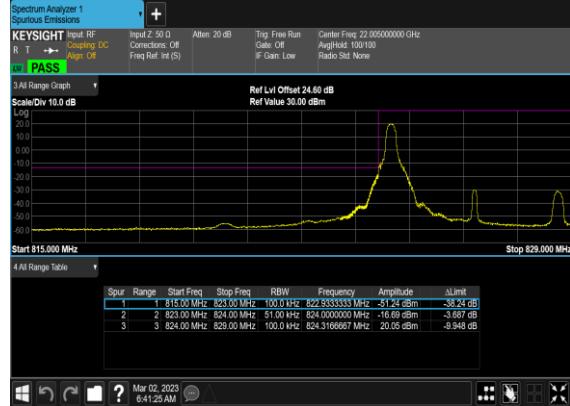

### N5(5M)\_DFT-s-OFDM\_BPSK\_Outer\_Full\_Low\_CH

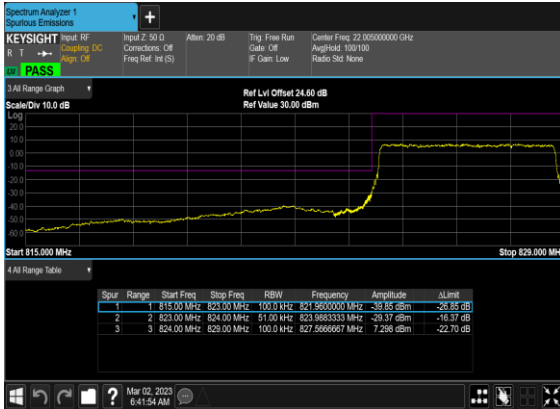

### N5(5M)\_DFT-s-OFDM\_QPSK\_Outer\_Full\_Low\_CH

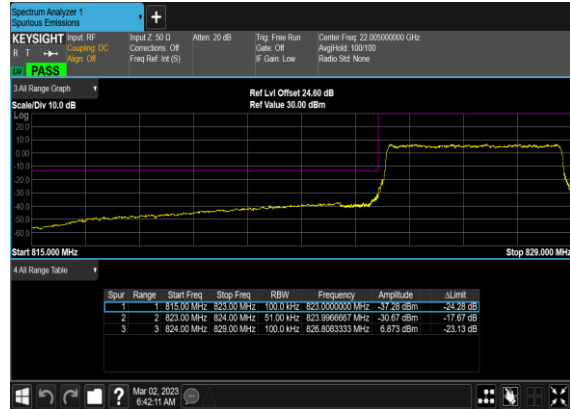

### N5(5M)\_DFT-s-OFDM\_BPSK\_Edge\_1RB\_Right\_High\_CH

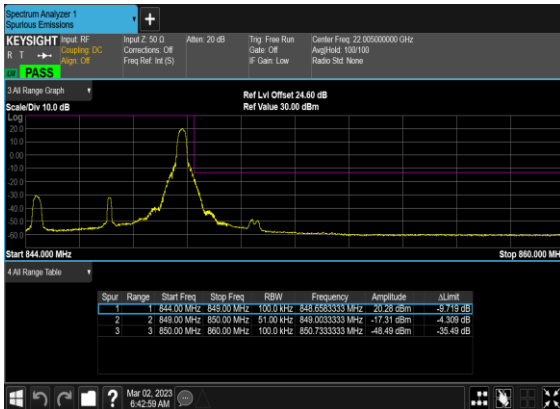

### N5(5M)\_DFT-s-OFDM\_QPSK\_Edge\_1RB\_Right\_High\_CH

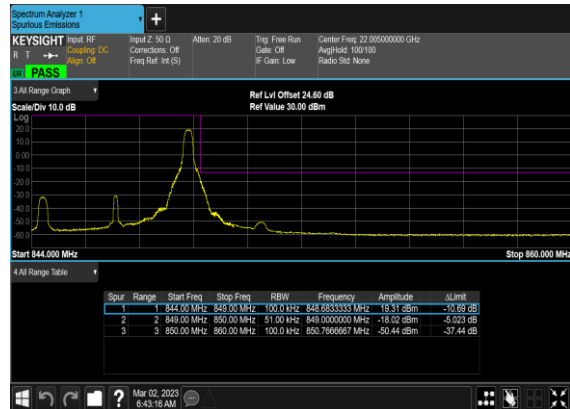

### N5(5M)\_DFT-s-OFDM\_BPSK\_Outer\_Full\_High\_CH

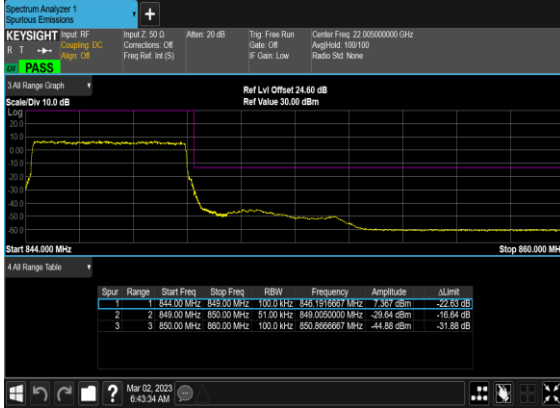

### N5(5M)\_DFT-s-OFDM\_QPSK\_Outer\_Full\_High\_CH

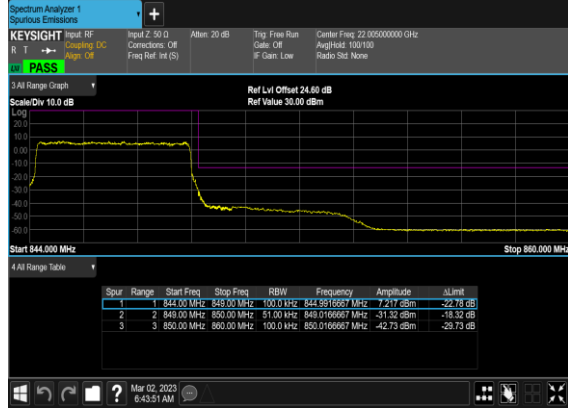

### N5(15M)\_DFT-s-OFDM\_BPSK\_Edge\_1RB\_Left\_Low\_CH

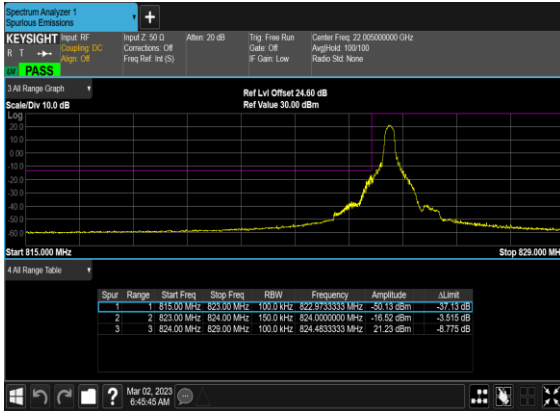

### N5(15M)\_DFT-s-OFDM\_QPSK\_Edge\_1RB\_Left\_Low\_CH

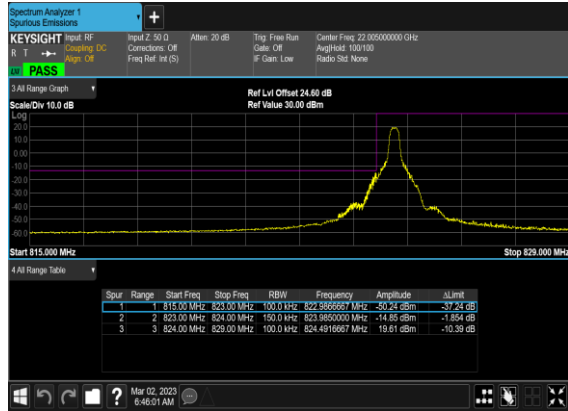

### N5(15M)\_DFT-s-OFDM\_BPSK\_Outer\_Full\_Low\_CH

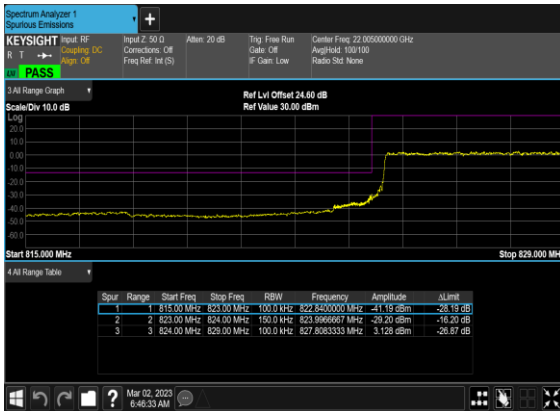

### N5(15M)\_DFT-s-OFDM\_QPSK\_Outer\_Full\_Low\_CH

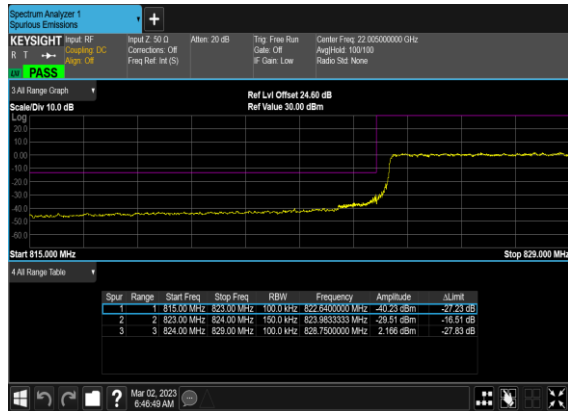

N5(15M)\_DFT-s-OFDM\_BPSK\_Edge\_1RB\_Right\_High\_CH

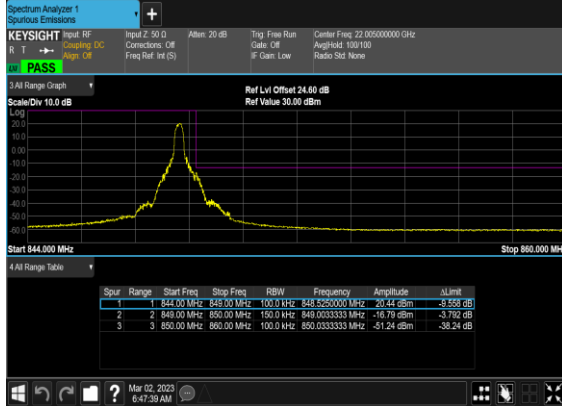

N5(15M)\_DFT-s-OFDM\_QPSK\_Edge\_1RB\_Right\_High\_CH

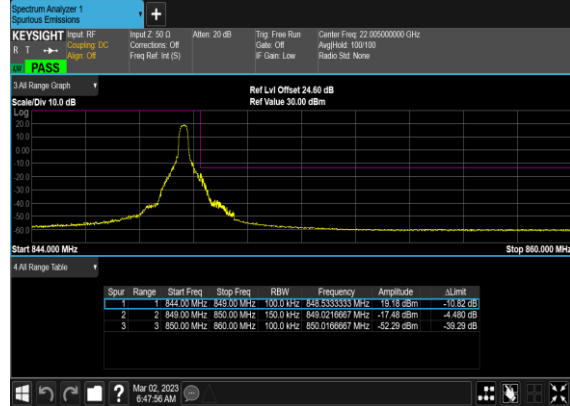

N5(15M)\_DFT-s-OFDM\_BPSK\_Outer\_Full\_High\_CH

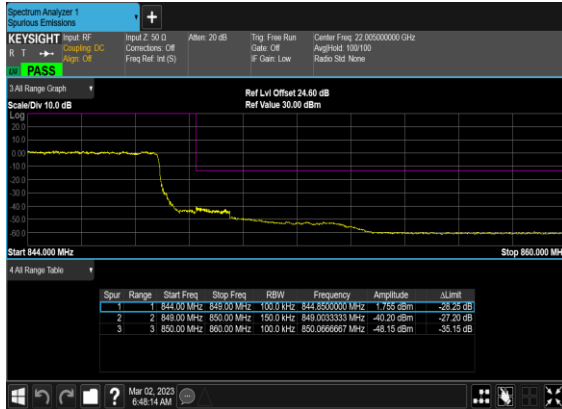

N5(15M)\_DFT-s-OFDM\_QPSK\_Outer\_Full\_High\_CH

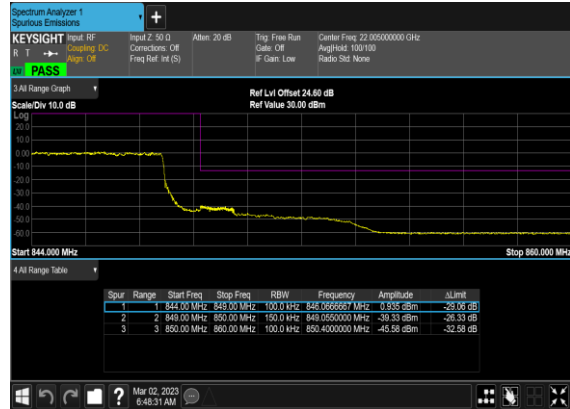

N5(20M)\_DFT-s-OFDM\_BPSK\_Edge\_1RB\_Left\_Low\_CH

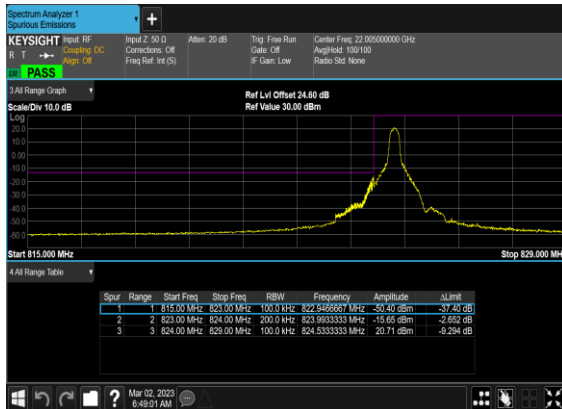

N5(20M)\_DFT-s-OFDM\_QPSK\_Edge\_1RB\_Left\_Low\_CH

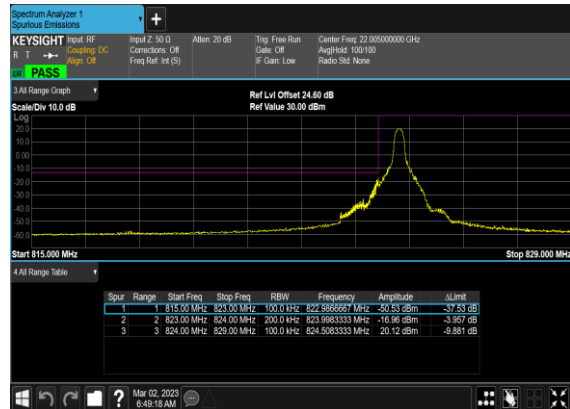

### N5(20M)\_DFT-s-OFDM\_BPSK\_Outer\_Full\_Low\_CH

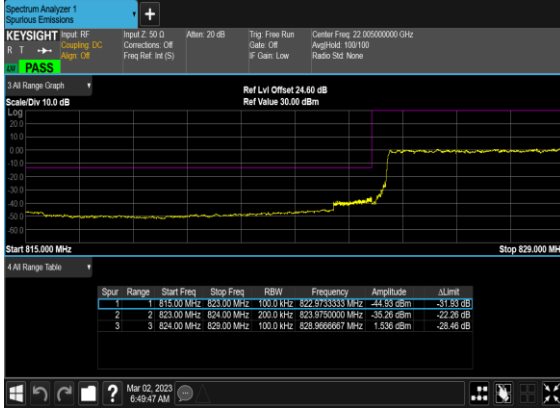

### N5(20M)\_DFT-s-OFDM\_QPSK\_Outer\_Full\_Low\_CH

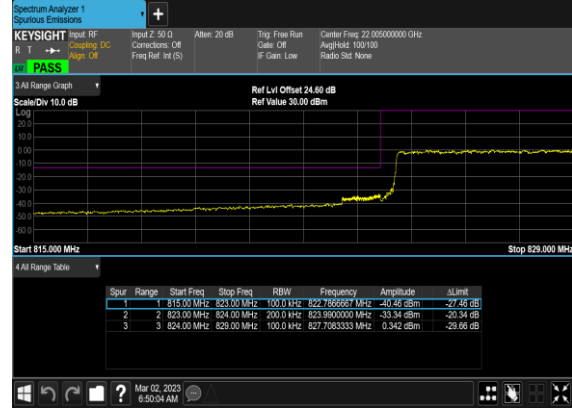

### N5(20M)\_DFT-s-OFDM\_BPSK\_Edge\_1RB\_Right\_High\_CH

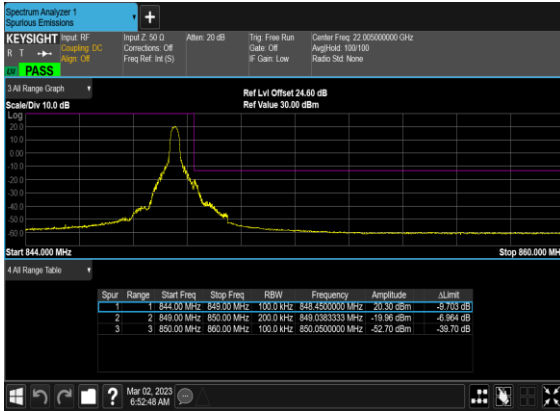

### N5(20M)\_DFT-s-OFDM\_QPSK\_Edge\_1RB\_Right\_High\_CH

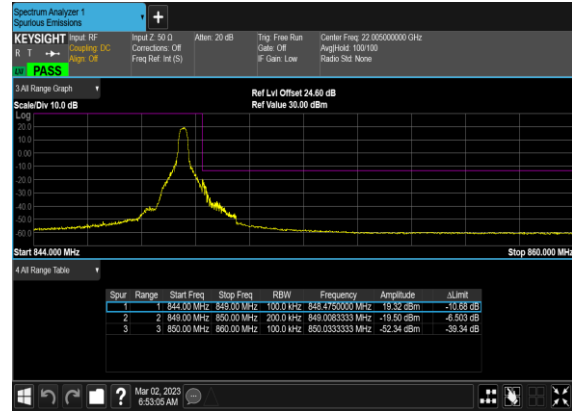

### N5(20M)\_DFT-s-OFDM\_BPSK\_Outer\_Full\_High\_CH

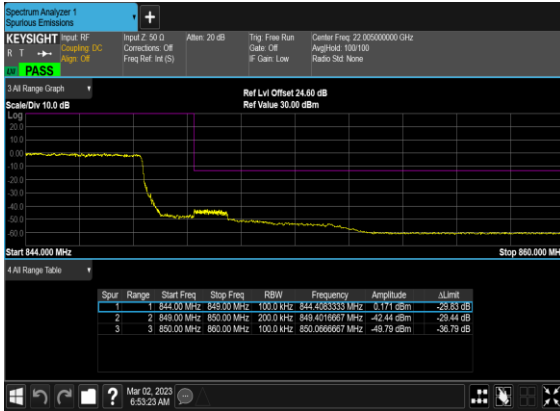

### N5(20M)\_DFT-s-OFDM\_QPSK\_Outer\_Full\_High\_CH

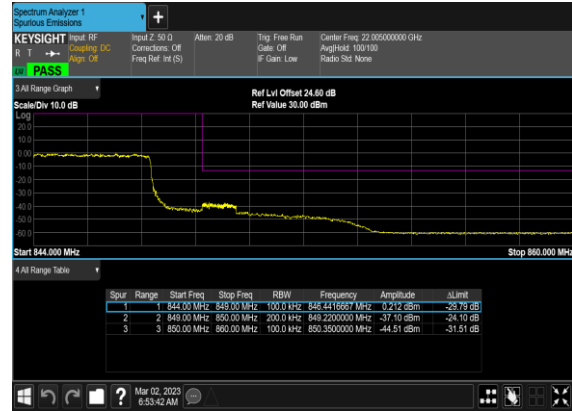



## FR1 N7(ANT2)

### Transmitter Conducted Output Power And EIRP, (G<sub>T</sub>-L<sub>C</sub>)=0.89dB

NR Band	SCS	BandWidth	Arfcn	Freq (MHz)	Modulation	RB	Conducted Power (dBm)	EIRP (dBm)	EIRP (W)
7	15	5	500500	2502.5	DFT-s-OFDM PI/2 BPSK	1@1	24.46	25.35	0.3428
7	15	5	507000	2535	DFT-s-OFDM PI/2 BPSK	1@1	24.64	25.53	0.3573
7	15	5	513500	2567.5	DFT-s-OFDM PI/2 BPSK	1@1	24.52	25.41	0.3475
7	15	10	501000	2505	DFT-s-OFDM PI/2 BPSK	1@1	24.53	25.42	0.3483
7	15	10	507000	2535	DFT-s-OFDM PI/2 BPSK	1@1	24.61	25.5	0.3548
7	15	10	513000	2565	DFT-s-OFDM PI/2 BPSK	1@1	24.54	25.43	0.3491
7	15	15	501500	2507.5	DFT-s-OFDM PI/2 BPSK	1@1	24.38	25.27	0.3365
7	15	15	507000	2535	DFT-s-OFDM PI/2 BPSK	1@1	24.49	25.38	0.3451
7	15	15	512500	2562.5	DFT-s-OFDM PI/2 BPSK	1@1	24.37	25.26	0.3357
7	15	20	502000	2510	DFT-s-OFDM PI/2 BPSK	1@1	24.43	25.32	0.3404
7	15	20	507000	2535	DFT-s-OFDM PI/2 BPSK	1@1	24.54	25.43	0.3491
7	15	20	512000	2560	DFT-s-OFDM PI/2 BPSK	1@1	24.35	25.24	0.3342
7	15	25	502500	2512.5	DFT-s-OFDM PI/2 BPSK	1@1	24.56	25.45	0.3508
7	15	25	507000	2535	DFT-s-OFDM PI/2 BPSK	1@1	24.79	25.68	0.3698
7	15	25	511500	2557.5	DFT-s-OFDM PI/2 BPSK	1@1	24.62	25.51	0.3556
7	15	30	503000	2515	DFT-s-OFDM PI/2 BPSK	1@1	24.56	25.45	0.3508
7	15	30	507000	2535	DFT-s-OFDM PI/2 BPSK	1@1	24.76	25.65	0.3673
7	15	30	511000	2555	DFT-s-OFDM PI/2 BPSK	1@1	24.54	25.43	0.3491
7	15	40	504000	2520	DFT-s-OFDM PI/2 BPSK	108@54	24.66	25.55	0.3589
7	15	40	504000	2520	DFT-s-OFDM PI/2 BPSK	1@1	24.51	25.4	0.3467
7	15	40	504000	2520	DFT-s-OFDM PI/2 BPSK	1@214	24.41	25.3	0.3388
7	15	40	504000	2520	DFT-s-OFDM QPSK	108@54	24.74	25.63	0.3656
7	15	40	504000	2520	DFT-s-OFDM QPSK	1@1	24.59	25.48	0.3532
7	15	40	504000	2520	DFT-s-OFDM QPSK	1@214	24.5	25.39	0.3459
7	15	40	504000	2520	DFT-s-OFDM 16 QAM	108@54	23.79	24.68	0.2938
7	15	40	504000	2520	DFT-s-OFDM 16 QAM	1@1	23.71	24.6	0.2884
7	15	40	504000	2520	DFT-s-OFDM 16 QAM	1@214	23.67	24.56	0.2858
7	15	40	504000	2520	DFT-s-OFDM 64 QAM	108@54	22.21	23.1	0.2042
7	15	40	504000	2520	DFT-s-OFDM 64 QAM	1@1	22.28	23.17	0.2075
7	15	40	504000	2520	DFT-s-OFDM 64 QAM	1@214	22.19	23.08	0.2032
7	15	40	504000	2520	DFT-s-OFDM 256 QAM	108@54	20.21	21.1	0.1288
7	15	40	504000	2520	DFT-s-OFDM 256 QAM	1@1	19.87	20.76	0.1191
7	15	40	504000	2520	DFT-s-OFDM 256 QAM	1@214	19.83	20.72	0.1180
7	15	40	504000	2520	CP-OFDM QPSK	1@1	23.15	24.04	0.2535
7	15	40	507000	2535	DFT-s-OFDM PI/2 BPSK	108@54	24.63	25.52	0.3565
7	15	40	507000	2535	DFT-s-OFDM PI/2 BPSK	1@1	24.82	25.71	0.3724
7	15	40	507000	2535	DFT-s-OFDM PI/2 BPSK	1@214	24.53	25.42	0.3483
7	15	40	507000	2535	DFT-s-OFDM QPSK	108@54	24.72	25.61	0.3639
7	15	40	507000	2535	DFT-s-OFDM QPSK	1@1	25.05	25.94	0.3926
7	15	40	507000	2535	DFT-s-OFDM QPSK	1@214	24.76	25.65	0.3673

7	15	40	507000	2535	DFT-s-OFDM 16 QAM	108@54	23.68	24.57	0.2864
7	15	40	507000	2535	DFT-s-OFDM 16 QAM	1@1	24.02	24.91	0.3097
7	15	40	507000	2535	DFT-s-OFDM 16 QAM	1@214	23.69	24.58	0.2871
7	15	40	507000	2535	DFT-s-OFDM 64 QAM	108@54	22.22	23.11	0.2046
7	15	40	507000	2535	DFT-s-OFDM 64 QAM	1@1	22.46	23.35	0.2163
7	15	40	507000	2535	DFT-s-OFDM 64 QAM	1@214	22.18	23.07	0.2028
7	15	40	507000	2535	DFT-s-OFDM 256 QAM	108@54	21.9	22.79	0.1901
7	15	40	507000	2535	DFT-s-OFDM 256 QAM	1@1	20.09	20.98	0.1253
7	15	40	507000	2535	DFT-s-OFDM 256 QAM	1@214	19.83	20.72	0.1180
7	15	40	507000	2535	CP-OFDM QPSK	1@1	23.4	24.29	0.2685
7	15	40	510000	2550	DFT-s-OFDM PI/2 BPSK	108@54	24.5	25.39	0.3459
7	15	40	510000	2550	DFT-s-OFDM PI/2 BPSK	1@1	24.57	25.46	0.3516
7	15	40	510000	2550	DFT-s-OFDM PI/2 BPSK	1@214	24.51	25.4	0.3467
7	15	40	510000	2550	DFT-s-OFDM QPSK	108@54	24.55	25.44	0.3499
7	15	40	510000	2550	DFT-s-OFDM QPSK	1@1	24.67	25.56	0.3597
7	15	40	510000	2550	DFT-s-OFDM QPSK	1@214	24.96	25.85	0.3846
7	15	40	510000	2550	DFT-s-OFDM 16 QAM	108@54	23.57	24.46	0.2793
7	15	40	510000	2550	DFT-s-OFDM 16 QAM	1@1	23.75	24.64	0.2911
7	15	40	510000	2550	DFT-s-OFDM 16 QAM	1@214	23.82	24.71	0.2958
7	15	40	510000	2550	DFT-s-OFDM 64 QAM	108@54	22.05	22.94	0.1968
7	15	40	510000	2550	DFT-s-OFDM 64 QAM	1@1	22.27	23.16	0.2070
7	15	40	510000	2550	DFT-s-OFDM 64 QAM	1@214	22.28	23.17	0.2075
7	15	40	510000	2550	DFT-s-OFDM 256 QAM	108@54	19.96	20.85	0.1216
7	15	40	510000	2550	DFT-s-OFDM 256 QAM	1@1	19.89	20.78	0.1197
7	15	40	510000	2550	DFT-s-OFDM 256 QAM	1@214	19.88	20.77	0.1194
7	15	40	510000	2550	CP-OFDM QPSK	1@1	23.28	24.17	0.2612

## Frequency Stability

NR Band	SCS (kHz)	Bandwidth (MHz)	Arfcn	Freq (MHz)	Modulation	RB	Deviation (ppm)	Verdict	Environment
7	15	20	507000	2535.0	DFT-s-OFDM QPSK	100@0	-0.0027	<b>PASS</b>	NV
7	15	20	507000	2535.0	DFT-s-OFDM QPSK	100@0	0.0026	<b>PASS</b>	LV
7	15	20	507000	2535.0	DFT-s-OFDM QPSK	100@0	0.0021	<b>PASS</b>	HV
7	15	20	507000	2535.0	DFT-s-OFDM QPSK	100@0	0.0017	<b>PASS</b>	-30°C
7	15	20	507000	2535.0	DFT-s-OFDM QPSK	100@0	0.0038	<b>PASS</b>	-20°C
7	15	20	507000	2535.0	DFT-s-OFDM QPSK	100@0	0.0019	<b>PASS</b>	-10°C
7	15	20	507000	2535.0	DFT-s-OFDM QPSK	100@0	0.0011	<b>PASS</b>	0°C
7	15	20	507000	2535.0	DFT-s-OFDM QPSK	100@0	0.0031	<b>PASS</b>	10°C
7	15	20	507000	2535.0	DFT-s-OFDM QPSK	100@0	0.0026	<b>PASS</b>	20°C
7	15	20	507000	2535.0	DFT-s-OFDM QPSK	100@0	0.0016	<b>PASS</b>	30°C
7	15	20	507000	2535.0	DFT-s-OFDM QPSK	100@0	0.0012	<b>PASS</b>	40°C
7	15	20	507000	2535.0	DFT-s-OFDM QPSK	100@0	0.0021	<b>PASS</b>	50°C

## Peak to Average Ratio

NR Band	SCS (kHz)	Bandwidth (MHz)	Arfcn	Freq (MHz)	Modulation	RB	Result (dB)	Limit (dB)	Verdict
7	15	40	507000	2535.0	DFT-s-OFDM PI/2 BPSK	216@0	6.71	13	PASS
7	15	40	507000	2535.0	DFT-s-OFDM PI/2 BPSK	1@0	3.6	13	PASS
7	15	40	507000	2535.0	DFT-s-OFDM QPSK	216@0	7.08	13	PASS
7	15	40	507000	2535.0	DFT-s-OFDM QPSK	1@0	4.58	13	PASS

N7(40M)\_DFT-s-OFDM\_PI\_2-BPSK\_Outer\_Full\_Mid\_CH



N7(40M)\_DFT-s-OFDM\_PI\_2-BPSK\_Edge\_1RB\_Left\_Mid\_CH



N7(40M)\_DFT-s-OFDM\_QPSK\_Outer\_Full\_Mid\_CH



N7(40M)\_DFT-s-OFDM\_QPSK\_Edge\_1RB\_Left\_Mid\_CH



## Occupied Bandwidth

NR Band	SCS (kHz)	Bandwidth (MHz)	Arfcn	Freq (MHz)	Modulation	RB	OBW (MHz)	26dB BW (MHz)
7	15	5	507000	2535.0	CP-OFDM QPSK	25@0	4.4692	4.911
7	15	5	507000	2535.0	CP-OFDM 16 QAM	25@0	4.4978	4.947
7	15	5	507000	2535.0	CP-OFDM 64 QAM	25@0	4.463	4.922
7	15	5	507000	2535.0	CP-OFDM 256 QAM	25@0	4.4766	4.899
7	15	10	507000	2535.0	CP-OFDM QPSK	52@0	9.2861	9.904
7	15	10	507000	2535.0	CP-OFDM 16 QAM	52@0	9.2814	9.905
7	15	10	507000	2535.0	CP-OFDM 64 QAM	52@0	9.2935	9.843
7	15	10	507000	2535.0	CP-OFDM 256 QAM	52@0	9.2918	9.901
7	15	15	507000	2535.0	CP-OFDM QPSK	79@0	14.124	14.8
7	15	15	507000	2535.0	CP-OFDM 16 QAM	79@0	14.133	14.63
7	15	15	507000	2535.0	CP-OFDM 64 QAM	79@0	14.14	14.86
7	15	15	507000	2535.0	CP-OFDM 256 QAM	79@0	14.084	14.76
7	15	20	507000	2535.0	CP-OFDM QPSK	106@0	18.972	19.84
7	15	20	507000	2535.0	CP-OFDM 16 QAM	106@0	18.947	19.78
7	15	20	507000	2535.0	CP-OFDM 64 QAM	106@0	18.98	20.28
7	15	20	507000	2535.0	CP-OFDM 256 QAM	106@0	18.905	19.79
7	15	25	507000	2535.0	CP-OFDM QPSK	133@0	23.793	24.64
7	15	25	507000	2535.0	CP-OFDM 16 QAM	133@0	23.817	24.68
7	15	25	507000	2535.0	CP-OFDM 64 QAM	133@0	23.816	24.78
7	15	25	507000	2535.0	CP-OFDM 256 QAM	133@0	23.825	24.72
7	15	30	507000	2535.0	CP-OFDM QPSK	160@0	28.657	29.56
7	15	30	507000	2535.0	CP-OFDM 16 QAM	160@0	28.604	29.55
7	15	30	507000	2535.0	CP-OFDM 64 QAM	160@0	28.657	29.66
7	15	30	507000	2535.0	CP-OFDM 256 QAM	160@0	28.673	29.54
7	15	40	507000	2535.0	CP-OFDM QPSK	216@0	38.599	39.89
7	15	40	507000	2535.0	CP-OFDM 16 QAM	216@0	38.576	40.0

7	15	40	507000	2535.0	CP-OFDM 64 QAM	216@0	38.658	39.89
7	15	40	507000	2535.0	CP-OFDM 256 QAM	216@0	38.666	39.84

N7(5M)\_CP-OFDM\_QPSK\_Outer\_Full\_Mid\_CH

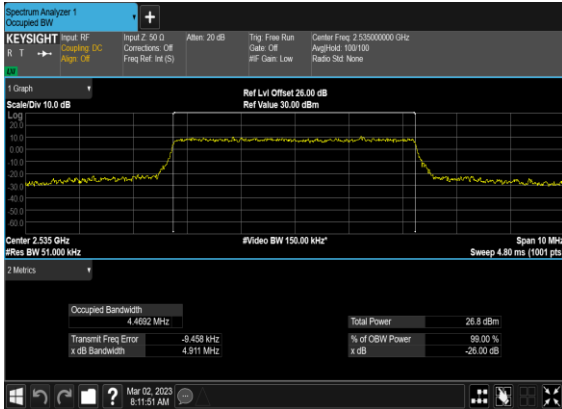

N7(5M)\_CP-OFDM\_16 QAM\_Outer\_Full\_Mid\_CH

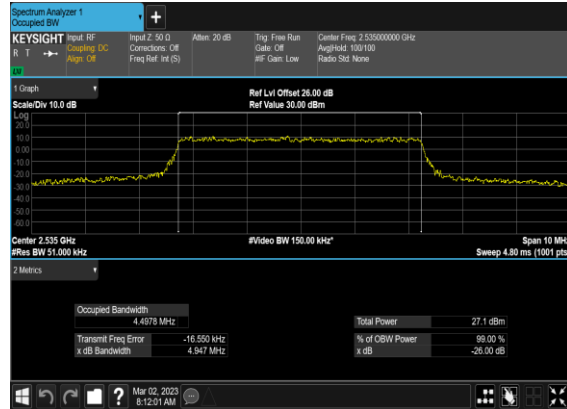

N7(5M)\_CP-OFDM\_64 QAM\_Outer\_Full\_Mid\_CH



N7(5M)\_CP-OFDM\_256 QAM\_Outer\_Full\_Mid\_CH

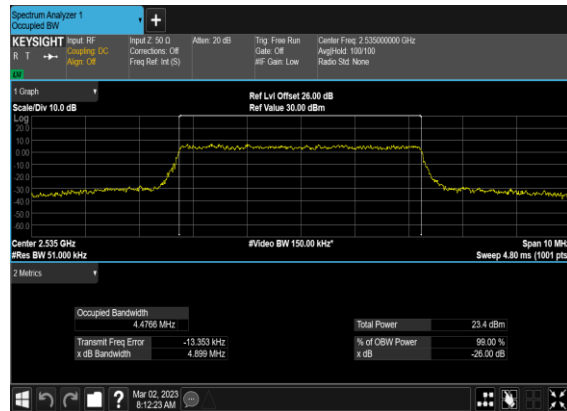

### N7(10M)\_CP-OFDM\_QPSK\_Outer\_Full\_Mid\_CH

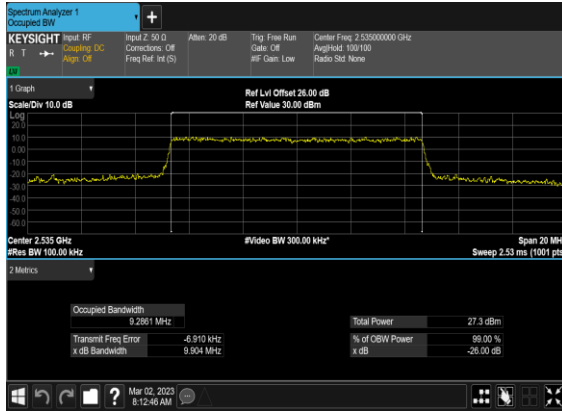

### N7(10M)\_CP-OFDM\_16QAM\_Outer\_Full\_Mid\_CH

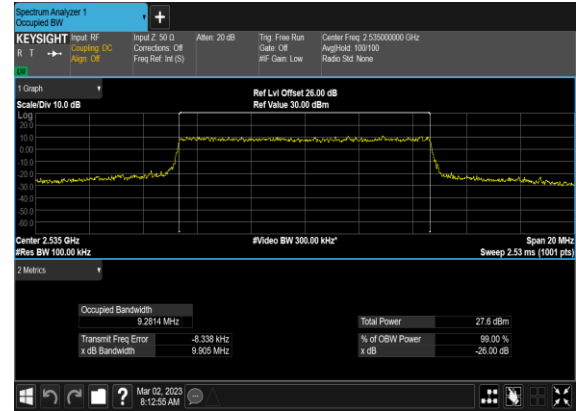

### N7(10M)\_CP-OFDM\_64QAM\_Outer\_Full\_Mid\_CH



### N7(10M)\_CP-OFDM\_256QAM\_Outer\_Full\_Mid\_CH

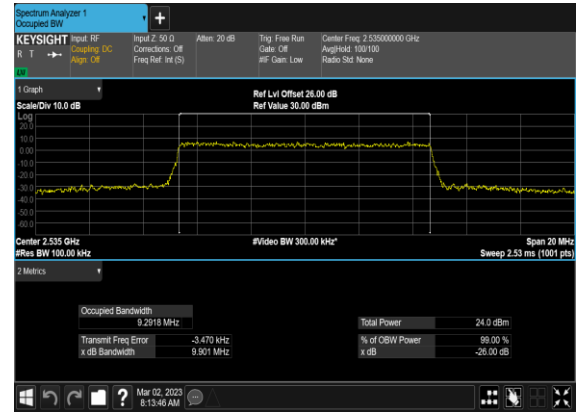

### N7(15M)\_CP-OFDM\_QPSK\_Outer\_Full\_Mid\_CH

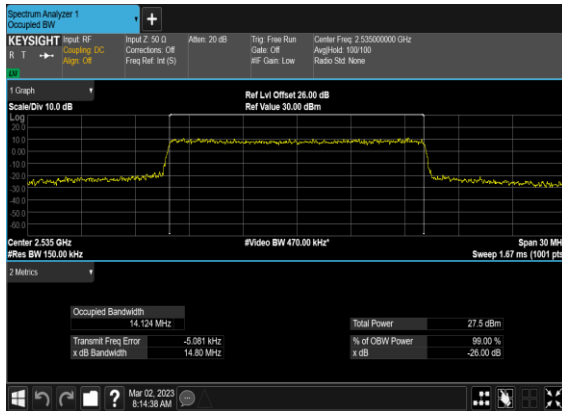

### N7(15M)\_CP-OFDM\_16QAM\_Outer\_Full\_Mid\_CH

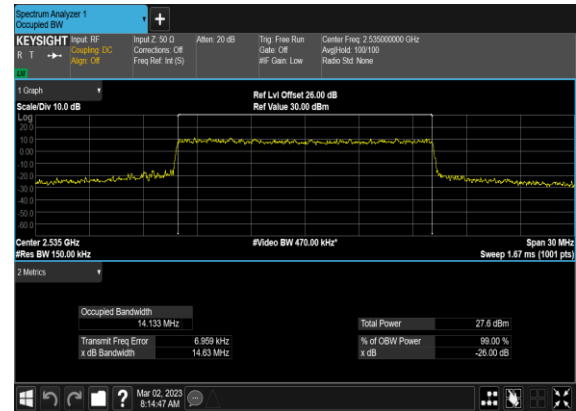



### N7(15M)\_CP-OFDM\_64 QAM\_Outer\_Full\_Mid\_CH



### N7(15M)\_CP-OFDM\_256 QAM\_Outer\_Full\_Mid\_CH

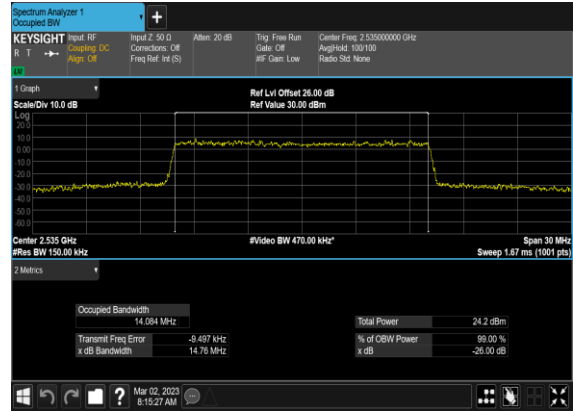

### N7(20M)\_CP- OFDM\_QPSK\_Outer\_Full\_Mid\_CH



### N7(20M)\_CP-OFDM\_16 QAM\_Outer\_Full\_Mid\_CH



### N7(20M)\_CP-OFDM\_64 QAM\_Outer\_Full\_Mid\_CH



### N7(20M)\_CP-OFDM\_256 QAM\_Outer\_Full\_Mid\_CH

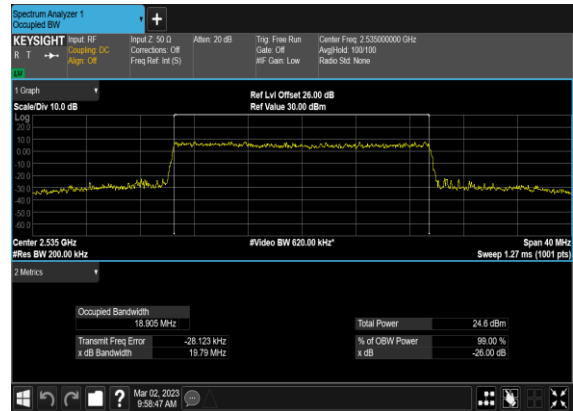

### N7(25M)\_CP-OFDM\_QPSK\_Outer\_Full\_Mid\_CH

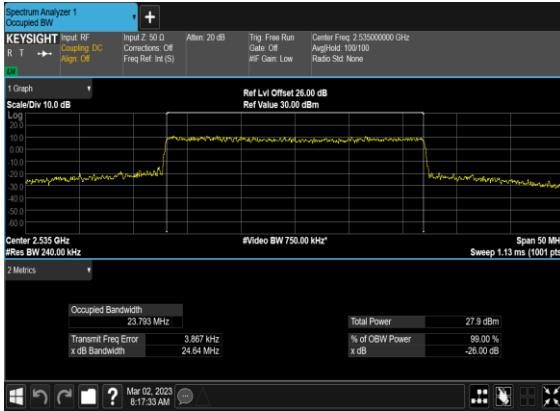

### N7(25M)\_CP-OFDM\_16QAM\_Outer\_Full\_Mid\_CH

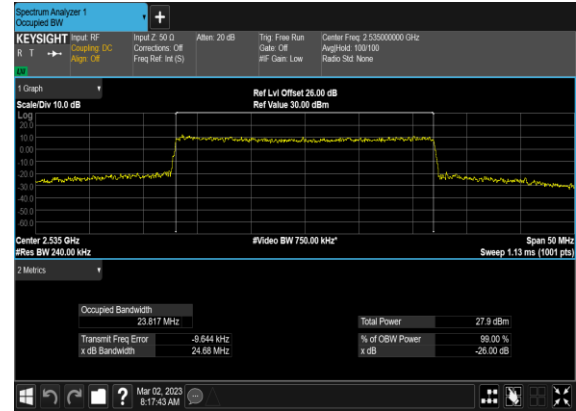

### N7(25M)\_CP-OFDM\_64QAM\_Outer\_Full\_Mid\_CH

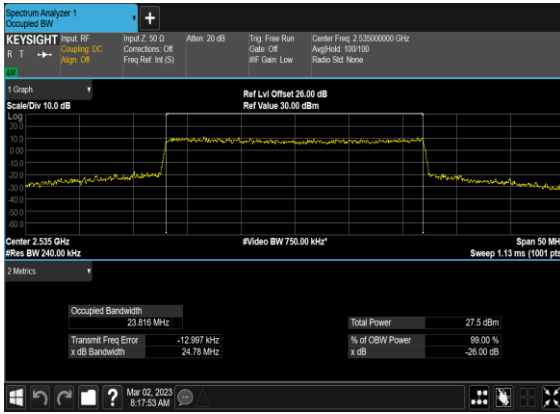

### N7(25M)\_CP-OFDM\_256QAM\_Outer\_Full\_Mid\_CH

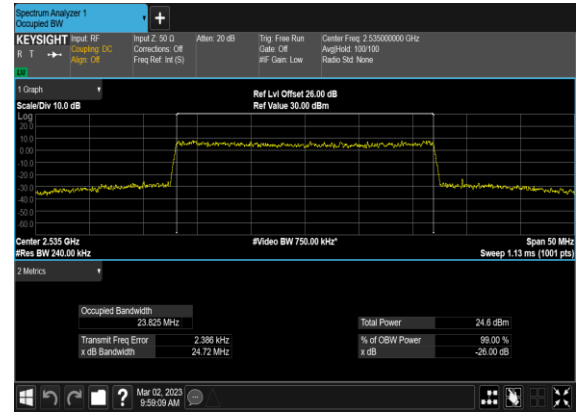

### N7(30M)\_CP-OFDM\_QPSK\_Outer\_Full\_Mid\_CH



### N7(30M)\_CP-OFDM\_16QAM\_Outer\_Full\_Mid\_CH

