



FCC RF Test Report

APPLICANT : Lenovo (Shanghai) Electronics Technology Co., Ltd.
EQUIPMENT : Portable Tablet Computer
BRAND NAME : Lenovo
MODEL NAME : TB360ZU
FCC ID : O57TB360ZU
STANDARD : 47 CFR Part 2, 22(H), 24(E), 27(L)
CLASSIFICATION : PCS Licensed Transmitter (PCB)
TEST DATE(S) : Feb. 24, 2023 ~ Mar. 16, 2023

We, Sporton International Inc. (Kunshan), would like to declare that the tested sample has been evaluated in accordance with the procedures given in ANSI C63.26-2015 and shown compliance with the applicable technical standards.

The test results in this report apply exclusively to the tested model / sample. Without written approval of Sporton International Inc. (Kunshan), the test report shall not be reproduced except in full.

Jason Jia

Approved by: Jason Jia



Sporton International Inc. (Kunshan)

**No. 1098, Pengxi North Road, Kunshan Economic Development Zone Jiangsu Province 215300
People's Republic of China**



TABLE OF CONTENTS

REVISION HISTORY... 3
SUMMARY OF TEST RESULT ... 4
1 GENERAL DESCRIPTION ... 5
1.1 Applicant ... 5
1.2 Manufacturer ... 5
1.3 Product Feature of Equipment Under Test ... 5
1.4 Product Specification of Equipment Under Test ... 5
1.5 Modification of EUT ... 6
1.6 Maximum ERP/EIRP and Emission Designator ... 7
1.7 Testing Location ... 9
1.8 Test Software ... 9
1.9 Applicable Standards ... 9
2 TEST CONFIGURATION OF EQUIPMENT UNDER TEST ... 10
2.1 Test Mode ... 10
2.2 Connection Diagram of Test System ... 11
2.3 Support Unit used in test configuration and system ... 11
2.4 Measurement Results Explanation Example ... 12
2.5 Frequency List of Low/Middle/High Channels ... 12
3 CONDUCTED TEST ITEMS ... 16
3.1 Measuring Instruments ... 16
3.2 Test Setup ... 16
3.3 Test Result of Conducted Test ... 16
3.4 Conducted Output Power and ERP/EIRP ... 17
3.5 Peak-to-Average Ratio ... 18
3.6 Occupied Bandwidth ... 19
3.7 Conducted Band Edge ... 20
3.8 Conducted Spurious Emission ... 21
3.9 Frequency Stability ... 22
4 RADIATED TEST ITEMS ... 23
4.1 Measuring Instruments ... 23
4.2 Test Setup ... 23
4.3 Test Result of Radiated Test ... 24
4.4 Radiated Spurious Emission ... 25
5 LIST OF MEASURING EQUIPMENT ... 26
6 UNCERTAINTY OF EVALUATION ... 27
APPENDIX A. TEST RESULTS OF CONDUCTED TEST
APPENDIX B. TEST RESULTS OF RADIATED TEST
APPENDIX C. TEST SETUP PHOTOGRAPHS



REVISION HISTORY

| REPORT NO. | VERSION | DESCRIPTION | ISSUED DATE |
|------------|---------|-------------------------|---------------|
| FG311926B | Rev. 01 | Initial issue of report | Apr. 07, 2023 |
| | | | |
| | | | |
| | | | |
| | | | |
| | | | |
| | | | |
| | | | |
| | | | |
| | | | |
| | | | |
| | | | |
| | | | |
| | | | |
| | | | |
| | | | |



SUMMARY OF TEST RESULT

| Report Section | FCC Rule | Description | Limit | Result | Remark |
|----------------|--|--|-------------------------------------|-------------|--|
| 3.4 | §2.1046 | Conducted Output Power | - | Report Only | - |
| | §22.913(a)(5) | Effective Radiated Power (Band 5) (Band 26) | ERP < 7 Watt | PASS | - |
| | §24.232(c) | Equivalent Isotropic Radiated Power (Band 2) (Band 25) | EIRP < 2Watt | | - |
| | §27.50(d)(4) | Equivalent Isotropic Radiated Power (Band 4) (Band 66) | EIRP < 1Watt | | - |
| 3.5 | §24.232(d) | Peak-to-Average Ratio | <13 dB | PASS | - |
| 3.6 | §2.1049 | Occupied Bandwidth | - | Report Only | - |
| 3.7 | §2.1051 §22.917(a) §24.238(a) §27.53(h) | Conducted Band Edge Measurement (Band 2) (Band 4) (Band 5) (Band 25) (Band 26) (Band 66) | < 43+10log ₁₀ (P[Watts]) | PASS | - |
| 3.8 | §2.1051 §22.917(a) §24.238(a) §27.53(h) | Conducted Spurious Emission (Band 2) (Band 4) (Band 5) (Band 25) (Band 26) (Band 66) | < 43+10log ₁₀ (P[Watts]) | PASS | - |
| 3.9 | §2.1055 §22.355 | Frequency Stability Temperature & Voltage | < 2.5 ppm for Part 22 | PASS | - |
| | §2.1055 §24.235 §27.54 | | Within Authorized Band | | |
| 4.4 | §2.1053 §22.917(a) §24.238(a) §27.53(h) | Radiated Spurious Emission (Band 2) (Band 4) (Band 5) (Band 25) (Band 26) (Band 66) | < 43+10log ₁₀ (P[Watts]) | PASS | Under limit 33.98 dB at 2488.00 MHz |

Declaration of Conformity:

The test results with all measurement uncertainty excluded are presented in accordance with the regulation limits or requirements declared by manufacturers.

Comments and Explanations:

The declared of product specification for EUT presented in the report are provided by the manufacturer, and the manufacturer takes all the responsibilities for the accuracy of product specification.



1 General Description

1.1 Applicant

Lenovo (Shanghai) Electronics Technology Co., Ltd.

Section 304-305, Building No. 4, # 222, Meiyue Road, China (Shanghai) Pilot Free Trade Zone

1.2 Manufacturer

Lenovo PC HK Limited

23/F, Lincoln House, Taikoo Place 979 King's Road, Quarry Bay, Hong Kong, China

1.3 Product Feature of Equipment Under Test

| Product Feature | |
|-----------------|--|
| Equipment | Portable Tablet Computer |
| Brand Name | Lenovo |
| Model Name | TB360ZU |
| FCC ID | O57TB360ZU |
| IMEI Code | Conducted : 869864060008140 Radiation : 869864060010336 |
| HW Version | TB360ZU |
| SW Version | TB360ZU_RF01_230312 |
| EUT Stage | Identical Prototype |

1.4 Product Specification of Equipment Under Test

| Standards-related Product Specification | |
|---|---|
| Tx Frequency | LTE Band 2 : 1850 MHz ~ 1910 MHz LTE Band 4 : 1710 MHz ~ 1755 MHz LTE Band 5 : 824 MHz ~ 849 MHz LTE Band 25 : 1850 MHz ~ 1915 MHz LTE Band 26 : 824 MHz ~ 849 MHz LTE Band 66 : 1710 MHz ~ 1780 MHz |
| Rx Frequency | LTE Band 2 : 1930 MHz ~ 1990 MHz LTE Band 4 : 2110 MHz ~ 2155 MHz LTE Band 5 : 869 MHz ~ 894 MHz LTE Band 25 : 1930 MHz ~ 1995 MHz LTE Band 26 : 869 MHz ~ 894 MHz LTE Band 66 : 2110 MHz~ 2200 MHz |
| Bandwidth | LTE Band 2 : 1.4MHz / 3MHz / 5MHz / 10MHz / 15MHz / 20MHz LTE Band 4 : 1.4MHz / 3MHz / 5MHz / 10MHz / 15MHz / 20MHz LTE Band 5 : 1.4MHz / 3MHz / 5MHz / 10MHz LTE Band 25 : 1.4MHz / 3MHz / 5MHz / 10MHz / 15MHz / 20MHz LTE Band 26 : 1.4MHz / 3MHz / 5MHz / 10MHz / 15MHz LTE Band 66 : 1.4MHz / 3MHz / 5MHz / 10MHz / 15MHz / 20MHz |
| Maximum Output Power to | <Ant. 1> |



| | |
|---------------------------|---|
| Antenna | LTE Band 5 : 23.94 dBm LTE Band 26 : 24.10 dBm <Ant. 2> LTE Band 2 : 23.41 dBm LTE Band 4 : 23.49 dBm LTE Band 25 : 23.47 dBm LTE Band 66 : 23.53 dBm <Ant. 6> LTE Band 4 : 23.44 dBm LTE Band 66 : 23.68 dBm |
| Antenna Gain | <Ant. 1> LTE Band 5 : 0.04 dBi LTE Band 26 : 0.04 dBi <Ant. 2> LTE Band 2 : 2.88 dBi LTE Band 4 : 2.61 dBi LTE Band 25 : 2.88 dBi LTE Band 66 : 2.61 dBi <Ant. 6> LTE Band 4 : -0.18 dBi LTE Band 66 : -0.18 dBi |
| Type of Modulation | QPSK / 16QAM / 64QAM / 256QAM |

Remark:

1. The maximum EIRP is calculated from max output power and max antenna gain, only the maximum EIRP are shown in the report, Ant. 2 for LTE Band 4/66.
2. The device supports two PAs for LTE Band 4 (main PA on Ant.2 and other PA on Ant.6), the maximum power of main PA is higher than the other PA. Therefore, the maximum EIRP for main PA is shown in the report.
3. The device supports two PAs for LTE Band 66 (main PA on Ant.2 and other PA on Ant.6), the maximum power of other PA is higher than the main PA, but the maximum EIRP of main PA is higher than the other PA. Therefore, the maximum EIRP for main PA is shown in the report.

1.5 Modification of EUT

No modifications are made to the EUT during all test items.



1.6 Maximum ERP/EIRP and Emission Designator

| LTE Band 2 | | QPSK | | 16QAM/64QAM/256QAM | |
|-------------|-----------------------|-----------------|------------------------------|--------------------|------------------------------|
| BW (MHz) | Frequency Range (MHz) | Maximum EIRP(W) | Emission Designator (99%OBW) | Maximum EIRP(W) | Emission Designator (99%OBW) |
| 1.4 | 1850.7 ~ 1909.3 | 0.4246 | 1M09G7D | 0.3491 | 1M09W7D |
| 3 | 1851.5 ~ 1908.5 | 0.4159 | 2M71G7D | 0.3516 | 2M72W7D |
| 5 | 1852.5 ~ 1907.5 | 0.4178 | 4M52G7D | 0.3443 | 4M48W7D |
| 10 | 1855.0 ~ 1905.0 | 0.4207 | 9M05G7D | 0.3483 | 9M03W7D |
| 15 | 1857.5 ~ 1902.5 | 0.4236 | 13M5G7D | 0.3491 | 13M4W7D |
| 20 | 1860.0 ~ 1900.0 | 0.4256 | 17M9G7D | 0.3540 | 17M9W7D |
| LTE Band 25 | | QPSK | | 16QAM/64QAM/256QAM | |
| BW (MHz) | Frequency Range (MHz) | Maximum EIRP(W) | Emission Designator (99%OBW) | Maximum EIRP(W) | Emission Designator (99%OBW) |
| 1.4 | 1850.7 ~ 1914.3 | 0.4305 | 1M09G7D | 0.3524 | 1M09W7D |
| 3 | 1851.5 ~ 1913.5 | 0.4207 | 2M71G7D | 0.3516 | 2M72W7D |
| 5 | 1852.5 ~ 1912.5 | 0.4246 | 4M52G7D | 0.3467 | 4M48W7D |
| 10 | 1855.0 ~ 1910.0 | 0.4256 | 9M05G7D | 0.3524 | 9M03W7D |
| 15 | 1857.5 ~ 1907.5 | 0.4276 | 13M5G7D | 0.3483 | 13M4W7D |
| 20 | 1860.0 ~ 1905.0 | 0.4315 | 17M9G7D | 0.3548 | 17M9W7D |
| LTE Band 4 | | QPSK | | 16QAM/64QAM/256QAM | |
| BW (MHz) | Frequency Range (MHz) | Maximum EIRP(W) | Emission Designator (99%OBW) | Maximum EIRP(W) | Emission Designator (99%OBW) |
| 1.4 | 1710.7 ~ 1754.3 | 0.4046 | 1M09G7D | 0.3243 | 1M09W7D |
| 3 | 1711.5 ~ 1753.5 | 0.4027 | 2M75G7D | 0.3214 | 2M72W7D |
| 5 | 1712.5 ~ 1752.5 | 0.3945 | 4M49G7D | 0.3266 | 4M51W7D |
| 10 | 1715.0 ~ 1750.0 | 0.3936 | 9M07G7D | 0.3243 | 9M03W7D |
| 15 | 1717.5 ~ 1747.5 | 0.4009 | 13M5G7D | 0.3243 | 13M5W7D |
| 20 | 1720.0 ~ 1745.0 | 0.4074 | 17M9G7D | 0.3296 | 17M9W7D |
| LTE Band 5 | | QPSK | | 16QAM/64QAM/256QAM | |
| BW (MHz) | Frequency Range (MHz) | Maximum ERP(W) | Emission Designator (99%OBW) | Maximum ERP(W) | Emission Designator (99%OBW) |
| 1.4 | 824.7 ~ 848.3 | 0.1507 | 1M09G7D | 0.1233 | 1M09W7D |
| 3 | 825.5 ~ 847.5 | 0.1493 | 2M72G7D | 0.123 | 2M72W7D |
| 5 | 826.5 ~ 846.5 | 0.1507 | 4M48G7D | 0.1225 | 4M49W7D |
| 10 | 829.0 ~ 844.0 | 0.1524 | 8M97G7D | 0.1262 | 9M03W7D |



| LTE Band 26 | | QPSK | | 16QAM/64QAM/256QAM | |
|-------------|-----------------------|-----------------|------------------------------|--------------------|------------------------------|
| BW (MHz) | Frequency Range (MHz) | Maximum ERP(W) | Emission Designator (99%OBW) | Maximum ERP(W) | Emission Designator (99%OBW) |
| 1.4 | 824.7 ~ 848.3 | 0.1549 | 1M09G7D | 0.1265 | 1M09W7D |
| 3 | 825.5 ~ 847.5 | 0.1552 | 2M72G7D | 0.1265 | 2M72W7D |
| 5 | 826.5 ~ 846.5 | 0.1560 | 4M48G7D | 0.1259 | 4M49W7D |
| 10 | 829.0 ~ 844.0 | 0.1535 | 8M97G7D | 0.1268 | 9M03W7D |
| 15 | 831.5 ~ 841.5 | 0.1581 | 13M4G7D | 0.1285 | 13M4W7D |
| CH26790 | 824.0 | 0.1549 | 13M4G7D | 0.1262 | 13M6W7D |
| LTE Band 66 | | QPSK | | 16QAM/64QAM/256QAM | |
| BW (MHz) | Frequency Range (MHz) | Maximum EIRP(W) | Emission Designator (99%OBW) | Maximum EIRP(W) | Emission Designator (99%OBW) |
| 1.4 | 1710.7 ~ 1779.3 | 0.4064 | 1M09G7D | 0.3334 | 1M09W7D |
| 3 | 1711.5 ~ 1778.5 | 0.3999 | 2M75G7D | 0.3311 | 2M72W7D |
| 5 | 1712.5 ~ 1777.5 | 0.4018 | 4M49G7D | 0.3296 | 4M51W7D |
| 10 | 1715.0 ~ 1775.0 | 0.3999 | 9M07G7D | 0.3296 | 9M03W7D |
| 15 | 1717.5 ~ 1772.5 | 0.4046 | 13M5G7D | 0.3350 | 13M5W7D |
| 20 | 1720.0 ~ 1770.0 | 0.4111 | 17M9G7D | 0.3396 | 17M9W7D |

Note:

1. LTE Band 26 overlaps the entire frequency range of LTE Band 5. Therefore, the test results provided in this report covers Band 5 and the portion of Band 26 subject to Part 22.
2. LTE Band 66 overlaps the entire frequency range of LTE Band 4. Therefore, the test results provided in this report covers Band 66 as well as Band 4.
3. LTE Band 25 overlaps the entire frequency range of LTE Band 2. Therefore, the test results provided in this report covers Band 25 as well as Band 2.
4. All modulations have been tested, only the worst test results of PSK & QAM are shown in the report.



1.7 Testing Location

Sporton International Inc. (Kunshan) is accredited to ISO/IEC 17025:2017 by American Association for Laboratory Accreditation with Certificate Number 5145.02.

| | | | |
|---------------------------|--|----------------------------|---------------------------------------|
| Test Firm | Sporton International Inc. (Kunshan) | | |
| Test Site Location | No. 1098, Pengxi North Road, Kunshan Economic Development Zone Jiangsu Province 215300 People's Republic of China TEL : +86-512-57900158 FAX : +86-512-57900958 | | |
| Test Site No. | Sporton Site No. | FCC Designation No. | FCC Test Firm Registration No. |
| | 03CH04-KS TH01-KS | CN1257 | 314309 |

1.8 Test Software

| Item | Site | Manufacture | Name | Version |
|------|-----------|-------------|------|---------------|
| 1. | 03CH04-KS | AUDIX | E3 | 6.2009-8-24al |

1.9 Applicable Standards

According to the specifications of the manufacturer, the EUT must comply with the requirements of the following standards:

- 47 CFR Part 2, 22(H), 24(E), 27(L)
- ANSI C63.26-2015
- FCC KDB 971168 D01 Power Meas License Digital Systems v03r01
- FCC KDB 412172 D01 Determining ERP and EIRP v01r01

Remark:

1. All test items were verified and recorded according to the standards and without any deviation during the test.
2. This EUT has also been tested and complied with the requirements of FCC Part 15, Subpart B, recorded in a separate test report.



2 Test Configuration of Equipment Under Test

2.1 Test Mode

Antenna port conducted and radiated test items listed below are performed according to KDB 971168 D01 Power Meas License Digital Systems v03r01 with maximum output power.

Radiated measurements are performed by rotating the EUT in three different orthogonal test planes to find the maximum emission. (Y Plane)

| Test Items | Band | Bandwidth (MHz) | | | | | | Modulation | | | | RB # | | | Test Channel | | |
|-----------------------------|------|-----------------|---|---|----|----|----|------------|--------|--------|---------|------|------|------|--------------|---|---|
| | | 1.4 | 3 | 5 | 10 | 15 | 20 | QPSK | 16 QAM | 64 QAM | 256 QAM | 1 | Half | Full | L | M | H |
| Max. Output Power | 2 | v | v | v | v | v | v | v | v | v | v | v | | v | v | v | v |
| | 4 | v | v | v | v | v | v | v | v | v | v | v | | v | v | v | v |
| | 5 | v | v | v | v | - | - | v | v | v | v | v | | v | v | v | v |
| | 25 | v | v | v | v | v | v | v | v | v | v | v | | v | v | v | v |
| | 26 | v | v | v | v | v | - | v | v | v | v | v | | v | v | v | v |
| | 66 | v | v | v | v | v | v | v | v | v | v | v | | v | v | v | v |
| Peak-to-Average Ratio | 25 | | | | | | v | v | v | v | v | | | v | | v | |
| | 26 | | | | | v | - | v | v | v | v | | | v | | v | |
| | 66 | | | | | | v | v | v | v | v | | | v | | v | |
| 26dB and 99% Bandwidth | 25 | v | v | v | v | v | v | v | v | | | | | v | | v | |
| | 26 | v | v | v | v | v | - | v | v | | | | | v | | v | |
| | 66 | v | v | v | v | v | v | v | v | | | | | v | | v | |
| Conducted Band Edge | 25 | v | v | v | v | v | v | v | v | v | v | v | | v | v | | v |
| | 26 | v | v | v | v | v | - | v | v | v | v | v | | v | v | | v |
| | 66 | v | v | v | v | v | v | v | v | v | v | v | | v | v | | v |
| Conducted Spurious Emission | 25 | v | v | v | v | v | v | v | | | | v | | | v | v | v |
| | 26 | v | v | v | v | v | - | v | | | | v | | | v | v | v |
| | 66 | v | v | v | v | v | v | v | | | | v | | | v | v | v |
| Frequency Stability | 25 | | | | v | | | v | | | | v | | | | v | |
| | 26 | | | | v | | - | v | | | | v | | | | v | |
| | 66 | | | | v | | | v | | | | v | | | | v | |



| Test Items | Band | Bandwidth (MHz) | | | | | | Modulation | | | | RB # | | | Test Channel | | | |
|----------------------------|---|-----------------|---|---|----|----|----|------------|--------|--------|---------|------|------|------|--------------|---|---|---|
| | | 1.4 | 3 | 5 | 10 | 15 | 20 | QPSK | 16 QAM | 64 QAM | 256 QAM | 1 | Half | Full | L | M | H | |
| E.R.P / E.I.R.P | 25 | v | v | v | v | v | v | v | v | v | v | v | v | | v | v | v | v |
| | 26 | v | v | v | v | v | - | v | v | v | v | v | v | | v | v | v | v |
| | 66 | v | v | v | v | v | v | v | v | v | v | v | v | | v | v | v | v |
| Radiated Spurious Emission | 25 | Worst Case | | | | | | | | | | | | | | | v | |
| | 26 | Worst Case | | | | | | | | | | | | | | | v | |
| | 66 | Worst Case | | | | | | | | | | | | | | | v | |
| Note | 1. The mark "v " means that this configuration is chosen for testing 2. The mark "-" means that this bandwidth is not supported. 3. The device is investigated from 30MHz to 10 times of fundamental signal for radiated spurious emission test under different RB size/offset and modulations in exploratory test. Subsequently, only the worst case emissions are reported. 4. All test items are based on engineering evaluation. | | | | | | | | | | | | | | | | | |

2.2 Connection Diagram of Test System

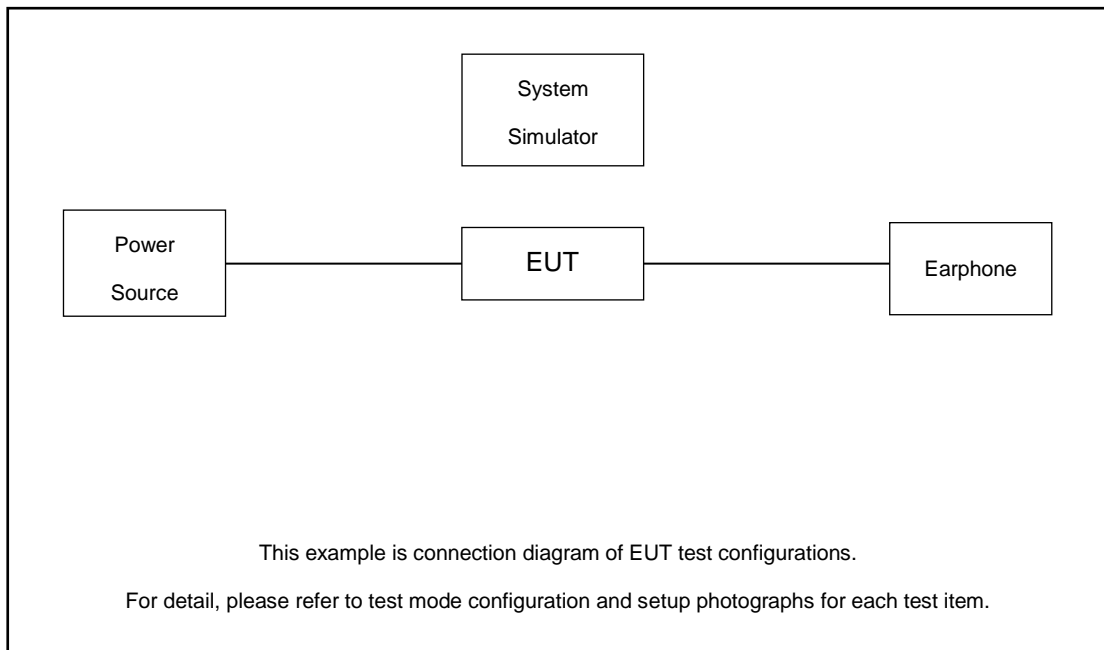

2.3 Support Unit used in test configuration and system

| Item | Equipment | Trade Name | Model No. | FCC ID | Data Cable | Power Cord |
|------|------------------|------------|-----------|--------|------------|-------------------|
| 1. | Power Supply | GWINSTEK | PSS-2002 | N/A | N/A | Unshielded, 1.8 m |
| 2. | LTE Base Station | Anritsu | MT8820C | N/A | N/A | Unshielded, 1.8 m |
| 3. | Earphone | N/A | N/A | N/A | N/A | N/A |



2.4 Measurement Results Explanation Example

For all conducted test items:

The offset level is set in the spectrum analyzer to compensate the RF cable loss between EUT conducted output port and spectrum analyzer. With the offset compensation, the spectrum analyzer reading level is exactly the EUT RF output level.

The spectrum analyzer offset is derived from RF cable loss.

$$\text{Offset} = \text{RF cable loss.}$$

Following shows an offset computation example with cable loss 5.4 dB.

Example :

$$\begin{aligned} \text{Offset(dB)} &= \text{RF cable loss(dB)}. \\ &= 5.4 \text{ (dB)} \end{aligned}$$

2.5 Frequency List of Low/Middle/High Channels

| LTE Band 2 Channel and Frequency List | | | | |
|---------------------------------------|------------------------|--------|--------|---------|
| BW [MHz] | Channel/Frequency(MHz) | Lowest | Middle | Highest |
| 20 | Channel | 18700 | 18900 | 19100 |
| | Frequency | 1860 | 1880 | 1900 |
| 15 | Channel | 18675 | 18900 | 19125 |
| | Frequency | 1857.5 | 1880 | 1902.5 |
| 10 | Channel | 18650 | 18900 | 19150 |
| | Frequency | 1855 | 1880 | 1905 |
| 5 | Channel | 18625 | 18900 | 19175 |
| | Frequency | 1852.5 | 1880 | 1907.5 |
| 3 | Channel | 18615 | 18900 | 19185 |
| | Frequency | 1851.5 | 1880 | 1908.5 |
| 1.4 | Channel | 18607 | 18900 | 19193 |
| | Frequency | 1850.7 | 1880 | 1909.3 |



| LTE Band 4 Channel and Frequency List | | | | |
|---------------------------------------|------------------------|--------|--------|---------|
| BW [MHz] | Channel/Frequency(MHz) | Lowest | Middle | Highest |
| 20 | Channel | 20050 | 20175 | 20300 |
| | Frequency | 1720 | 1732.5 | 1745 |
| 15 | Channel | 20025 | 20175 | 20325 |
| | Frequency | 1717.5 | 1732.5 | 1747.5 |
| 10 | Channel | 20000 | 20175 | 20350 |
| | Frequency | 1715 | 1732.5 | 1750 |
| 5 | Channel | 19975 | 20175 | 20375 |
| | Frequency | 1712.5 | 1732.5 | 1752.5 |
| 3 | Channel | 19965 | 20175 | 20385 |
| | Frequency | 1711.5 | 1732.5 | 1753.5 |
| 1.4 | Channel | 19957 | 20175 | 20393 |
| | Frequency | 1710.7 | 1732.5 | 1754.3 |

| LTE Band 5 Channel and Frequency List | | | | |
|---------------------------------------|------------------------|--------|--------|---------|
| BW [MHz] | Channel/Frequency(MHz) | Lowest | Middle | Highest |
| 10 | Channel | 20450 | 20525 | 20600 |
| | Frequency | 829 | 836.5 | 844 |
| 5 | Channel | 20425 | 20525 | 20625 |
| | Frequency | 826.5 | 836.5 | 846.5 |
| 3 | Channel | 20415 | 20525 | 20635 |
| | Frequency | 825.5 | 836.5 | 847.5 |
| 1.4 | Channel | 20407 | 20525 | 20643 |
| | Frequency | 824.7 | 836.5 | 848.3 |



| LTE Band 25 Channel and Frequency List | | | | |
|--|------------------------|--------|--------|---------|
| BW [MHz] | Channel/Frequency(MHz) | Lowest | Middle | Highest |
| 20 | Channel | 26140 | 26340 | 26590 |
| | Frequency | 1860 | 1880 | 1905 |
| 15 | Channel | 26115 | 26340 | 26615 |
| | Frequency | 1857.5 | 1880 | 1907.5 |
| 10 | Channel | 26090 | 26340 | 26640 |
| | Frequency | 1855 | 1880 | 1910 |
| 5 | Channel | 26065 | 26340 | 26665 |
| | Frequency | 1852.5 | 1880 | 1912.5 |
| 3 | Channel | 26055 | 26340 | 26675 |
| | Frequency | 1851.5 | 1880 | 1913.5 |
| 1.4 | Channel | 26047 | 26340 | 26683 |
| | Frequency | 1850.7 | 1880 | 1914.3 |

| LTE Band 26 Channel and Frequency List | | | | |
|--|------------------------|--------|--------|---------|
| BW [MHz] | Channel/Frequency(MHz) | Lowest | Middle | Highest |
| 15 | Channel | 26865 | 26915 | 26965 |
| | Frequency | 831.5 | 836.5 | 841.5 |
| 10 | Channel | 26840 | 26915 | 26990 |
| | Frequency | 829 | 836.5 | 844 |
| 5 | Channel | 26815 | 26915 | 27015 |
| | Frequency | 826.5 | 836.5 | 846.5 |
| 3 | Channel | 26805 | 26915 | 27025 |
| | Frequency | 825.5 | 836.5 | 847.5 |
| 1.4 | Channel | 26797 | 26915 | 27033 |
| | Frequency | 824.7 | 836.5 | 848.3 |



| LTE Band 66 Channel and Frequency List | | | | |
|--|------------------------|--------|--------|---------|
| BW [MHz] | Channel/Frequency(MHz) | Lowest | Middle | Highest |
| 20 | Channel | 132072 | 132322 | 132572 |
| | Frequency | 1720 | 1745 | 1770 |
| 15 | Channel | 132047 | 132322 | 132597 |
| | Frequency | 1717.5 | 1745 | 1772.5 |
| 10 | Channel | 132022 | 132322 | 132622 |
| | Frequency | 1715 | 1745 | 1775 |
| 5 | Channel | 131997 | 132322 | 132647 |
| | Frequency | 1712.5 | 1745 | 1777.5 |
| 3 | Channel | 131987 | 132322 | 132657 |
| | Frequency | 1711.5 | 1745 | 1778.5 |
| 1.4 | Channel | 131979 | 132322 | 132665 |
| | Frequency | 1710.7 | 1745 | 1779.3 |

3 Conducted Test Items

3.1 Measuring Instruments

See list of measuring instruments of this test report.

3.2 Test Setup

3.2.1 Conducted Output Power

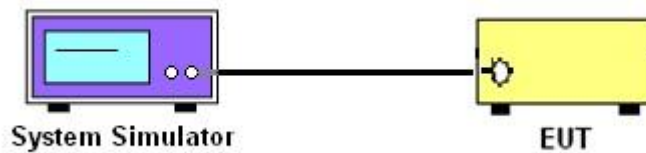

3.2.2 Peak-to-Average Ratio, Occupied Bandwidth, Conducted Band-Edge and Conducted Spurious Emission

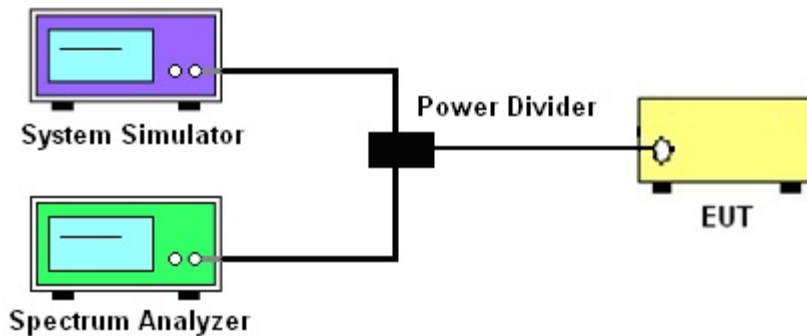

3.2.3 Frequency Stability

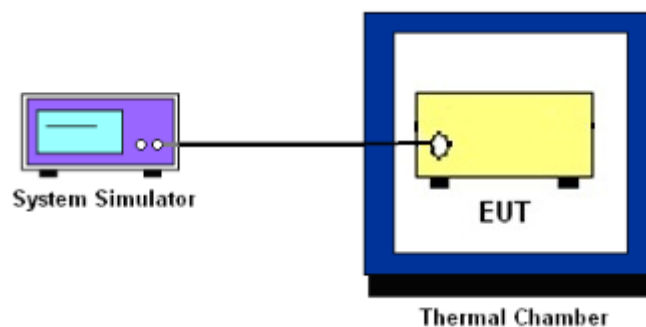

3.3 Test Result of Conducted Test

Please refer to Appendix A.



3.4 Conducted Output Power and ERP/EIRP

3.4.1 Description of the Conducted Output Power Measurement and ERP/EIRP Measurement

A system simulator was used to establish communication with the EUT. Its parameters were set to force the EUT transmitting at maximum output power. The measured power in the radio frequency on the transmitter output terminals shall be reported.

The ERP of mobile transmitters must not exceed 7 Watts for LTE Band 5 and Band 26.

The EIRP of mobile transmitters must not exceed 2 Watts for LTE Band 2 and Band 25.

The EIRP of mobile transmitters must not exceed 1 Watts for LTE Band 4 and Band 66.

According to KDB 412172 D01 Power Approach,

$EIRP = P_T + G_T - L_C$, $ERP = EIRP - 2.15$, where

P_T = transmitter output power in dBm

G_T = gain of the transmitting antenna in dBi

L_C = signal attenuation in the connecting cable between the transmitter and antenna in dB

3.4.2 Test Procedures

1. The testing follows ANSI C63.26 Section 5.2
2. The transmitter output port was connected to the system simulator.
3. Set EUT at maximum power through the system simulator.
4. Select lowest, middle, and highest channels for each band and different modulation.
5. Measure and record the power level from the system simulator.



3.5 Peak-to-Average Ratio

3.5.1 Description of the PAR Measurement

Power Complementary Cumulative Distribution Function (CCDF) curves provide a means for characterizing the power peaks of a digitally modulated signal on a statistical basis. A CCDF curve depicts the probability of the peak signal amplitude exceeding the average power level. Most contemporary measurement instrumentation include the capability to produce CCDF curves for an input signal provided that the instrument's resolution bandwidth can be set wide enough to accommodate the entire input signal bandwidth. In measuring transmissions in this band using an average power technique, the peak-to-average ratio (PAR) of the transmission may not exceed 13 dB.

3.5.2 Test Procedures

1. The testing follows ANSI C63.26 Section 5.2.3.4 (CCDF).
2. The EUT was connected to spectrum and system simulator via a power divider.
3. Set the CCDF (Complementary Cumulative Distribution Function) option in spectrum analyzer.
4. The highest RF powers were measured and recorded the maximum PAPR level associated with a probability of 0.1 %.
5. Record the deviation as Peak to Average Ratio.



3.6 Occupied Bandwidth

3.6.1 Description of Occupied Bandwidth Measurement

The occupied bandwidth is the width of a frequency band such that, below the lower and above the upper frequency limits, the mean powers emitted are each equal to a specified percentage 0.5% of the total mean transmitted power.

The 26 dB emission bandwidth is defined as the frequency range between two points, one above and one below the carrier frequency, at which the spectral density of the emission is attenuated 26 dB below the maximum in-band spectral density of the modulated signal. Spectral density (power per unit bandwidth) is to be measured with a detector of resolution bandwidth equal to approximately 1.0% of the emission bandwidth.

3.6.2 Test Procedures

1. The testing follows ANSI C63.26 Section 5.4
2. The EUT was connected to spectrum analyzer and system simulator via a power divider.
3. The spectrum analyzer center frequency is set to the nominal EUT channel center frequency. The span range for the spectrum analyzer shall be between two and five times the anticipated OBW.
4. The nominal resolution bandwidth (RBW) shall be in the range of 1 to 5 % of the anticipated OBW, and the VBW shall be at least 3 times the RBW.
5. Set the detection mode to peak, and the trace mode to max hold.
6. Determine the reference value: Set the EUT to transmit a modulated signal. Allow the trace to stabilize. Set the spectrum analyzer marker to the highest level of the displayed trace.
(this is the reference value)
7. Determine the “-26 dB down amplitude” as equal to (Reference Value – X).
8. Place two markers, one at the lowest and the other at the highest frequency of the envelope of the spectral display such that each marker is at or slightly below the “-X dB down amplitude” determined in step 6. If a marker is below this “-X dB down amplitude” value it shall be placed as close as possible to this value. The OBW is the positive frequency difference between the two markers.
9. Use the 99 % power bandwidth function of the spectrum analyzer and report the measured bandwidth.



3.7 Conducted Band Edge

3.7.1 Description of Conducted Band Edge Measurement

22.917(a)

For operations in the 824 – 849 MHz band, the FCC limit is $43 + 10\log_{10}(P[\text{Watts}])$ dB below the transmitter power P(Watts) in a 100kHz bandwidth. However, in the 1MHz bands immediately outside and adjacent to the licensee's frequency block, a resolution bandwidth of at least one percent of the emission bandwidth of the fundamental emission of the transmitter may be employed.

24.238 (a)

For operations in the 1850-1910 and 1930-1990 MHz band, the FCC limit is $43 + 10\log_{10}(P[\text{Watts}])$ dB below the transmitter power P(Watts) in a 1MHz bandwidth. However, in the 1 MHz bands immediately outside and adjacent to the frequency block a resolution bandwidth of at least one percent of the emission bandwidth of the fundamental emission of the transmitter may be employed.

27.53 (h)

For operations in the 1710 – 1755 MHz band, the FCC limit is $43 + 10\log_{10}(P[\text{Watts}])$ dB below the transmitter power P(Watts) in a 1 MHz bandwidth. However, in the 1MHz bands immediately outside and adjacent to the licensee's frequency block, a resolution bandwidth of at least one percent of the emission bandwidth of the fundamental emission of the transmitter may be employed.

3.7.2 Test Procedures

1. The testing follows ANSI C63.26 section 5.7
2. The EUT was connected to spectrum analyzer and system simulator via a power divider.
3. The band edges of low and high channels for the highest RF powers were measured.
4. Set RBW \geq 1% EBW in the 1MHz band immediately outside and adjacent to the band edge.
5. Beyond the 1 MHz band from the band edge, RBW=1MHz was used.
6. Set spectrum analyzer with RMS detector.
7. The RF fundamental frequency should be excluded against the limit line in the operating frequency band.
8. Checked that all the results comply with the emission limit line.

Example:

The limit line is derived from $43 + 10\log(P)$ dB below the transmitter power P(Watts)
= P(W)- [43 + 10log(P)] (dB)
= [30 + 10log(P)] (dBm) - [43 + 10log(P)] (dB) = -13dBm.

When using the integration method, the starting frequency of the integration shall be centered at one-half of the RBW away from the band edge.



3.8 Conducted Spurious Emission

3.8.1 Description of Conducted Spurious Emission Measurement

The power of any emission outside of the authorized operating frequency ranges must be lower than the transmitter power (P) by a factor of at least $43 + 10 \log (P)$ dB.

It is measured by means of a calibrated spectrum analyzer and scanned from 30 MHz up to a frequency including its 10th harmonic.

3.8.2 Test Procedures

1. The testing follows ANSI C63.26 section 5.7
2. The EUT was connected to spectrum analyzer and system simulator via a power divider.
3. The RF output of EUT was connected to the spectrum analyzer by RF cable and attenuator. The path loss was compensated to the results for each measurement.
4. The middle channel for the highest RF power within the transmitting frequency was measured.
5. The conducted spurious emission for the whole frequency range was taken.
6. Make the measurement with the spectrum analyzer's RBW = 1MHz, VBW = 3MHz.
7. Set spectrum analyzer with RMS detector.
8. Taking the record of maximum spurious emission.
9. The RF fundamental frequency should be excluded against the limit line in the operating frequency band.
10. The limit line is derived from $43 + 10\log(P)$ dB below the transmitter power P(Watts)
= $P(W) - [43 + 10\log(P)]$ (dB)
= $[30 + 10\log(P)]$ (dBm) - $[43 + 10\log(P)]$ (dB)
= -13dBm.



3.9 Frequency Stability

3.9.1 Description of Frequency Stability Measurement

The frequency stability shall be measured by variation of ambient temperature and variation of primary supply voltage to ensure that the fundamental emission stays within the authorized frequency block. The frequency stability of the transmitter shall be maintained within $\pm 0.00025\%$ ($\pm 2.5\text{ppm}$) of the center frequency.

3.9.2 Test Procedures for Temperature Variation

1. The testing follows ANSI C63.26 section 5.6.4
2. The EUT was set up in the thermal chamber and connected with the system simulator.
3. With power OFF, the temperature was decreased to -30°C and the EUT was stabilized before testing. Power was applied and the maximum change in frequency was recorded within one minute.
4. With power OFF, the temperature was raised in 10°C step up to 50°C . The EUT was stabilized at each step for at least half an hour. Power was applied and the maximum frequency change was recorded within one minute.

3.9.3 Test Procedures for Voltage Variation

1. The testing follows ANSI C63.26 section 5.6.5
2. The EUT was placed in a temperature chamber at $20\pm 5^{\circ}\text{C}$ and connected with the system simulator.
3. The power supply voltage to the EUT was varied from 85% to 115% of the nominal value for other than hand carried battery equipment.
4. For hand carried, battery powered equipment, reduce the primary ac or dc supply voltage to the battery operating end point, which shall be specified by the manufacturer.
5. The variation in frequency was measured for the worst case.

4 Radiated Test Items

4.1 Measuring Instruments

See list of measuring instruments of this test report.

4.2 Test Setup

4.2.1 For radiated test below 30MHz

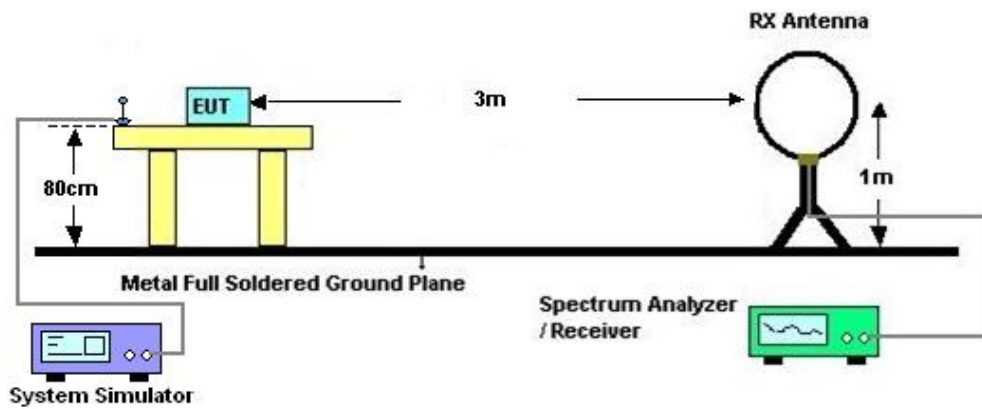

4.2.2 For radiated test from 30MHz to 1GHz

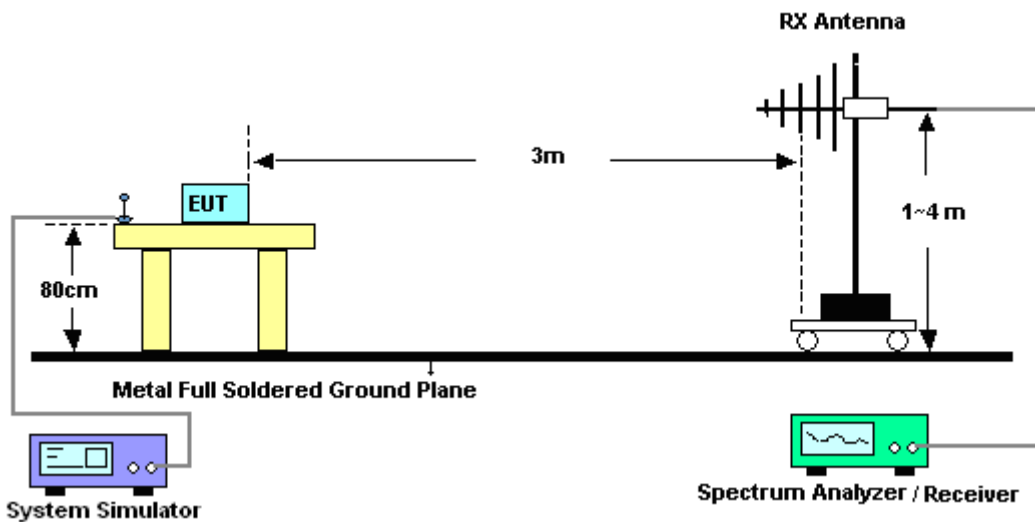

4.2.3 For radiated test above 1GHz

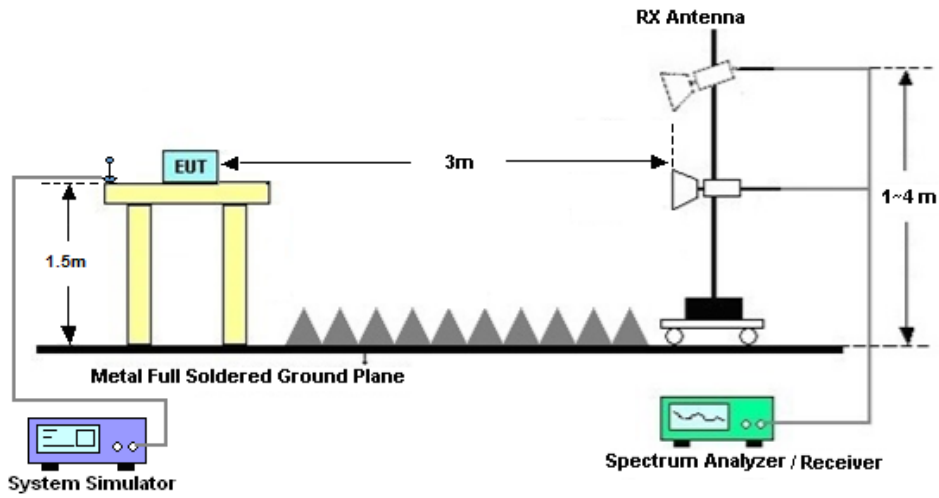

4.3 Test Result of Radiated Test

The low frequency, which started from 9 kHz to 30MHz, was pre-scanned and the result which was 20dB lower than the limit line was not reported.

Please refer to Appendix B.



4.4 Radiated Spurious Emission

4.4.1 Description of Radiated Spurious Emission

The radiated spurious emission was measured by substitution method according to ANSI C63.26. The power of any emission outside of the authorized operating frequency ranges must be attenuated below the transmitter power (P) by a factor of at least $43 + 10 \log (P)$ dB.

The spectrum is scanned from 30 MHz up to a frequency including its 10th harmonic.

4.4.2 Test Procedures

1. The testing follows ANSI C63.26 Section 5.5
2. The EUT was placed on a turntable with 0.8 meter height for frequency below 1GHz and 1.5 meter height for frequency above 1GHz respectively above ground.
3. The EUT was set 3 meters from the receiving antenna mounted on the antenna tower.
4. The table was rotated 360 degrees to determine the position of the highest spurious emission.
5. The height of the receiving antenna is varied between 1m to 4m to search the maximum spurious emission for both horizontal and vertical polarizations.
6. During the measurement, the system simulator parameters were set to force the EUT transmitting at maximum output power.
7. Make the measurement with the spectrum analyzer's RBW = 1MHz, VBW = 3MHz, taking the record of maximum spurious emission.
8. A horn antenna was substituted in place of the EUT and was driven by a signal generator.
9. Tune the output power of signal generator to the same emission level with EUT maximum spurious emission.
10. $EIRP \text{ (dBm)} = S.G. \text{ Power} - Tx \text{ Cable Loss} + Tx \text{ Antenna Gain}$
11. $ERP \text{ (dBm)} = EIRP - 2.15$
12. The RF fundamental frequency should be excluded against the limit line in the operating frequency band.

The limit line is derived from $43 + 10\log(P)$ dB below the transmitter power P(Watts)
= $P(W) - [43 + 10\log(P)] \text{ (dB)}$
= $[30 + 10\log(P)] \text{ (dBm)} - [43 + 10\log(P)] \text{ (dB)}$
= -13dBm.



5 List of Measuring Equipment

| Instrument | Manufacturer | Model No. | Serial No. | Characteristics | Calibration Date | Test Date | Due Date | Remark |
|-----------------------|--------------|----------------|-------------|-------------------------|------------------|---------------------------------|---------------|-----------------------|
| Spectrum Analyzer | R&S | FSV40 | 101040 | 10Hz~40GHz | Oct. 12, 2022 | Feb. 24, 2023~ Mar. 09, 2023 | Oct. 11, 2023 | Conducted (TH01-KS) |
| Power divider | STI | STI08-0055 | - | 0.5~40GHz | NCR | Feb. 24, 2023~ Mar. 09, 2023 | NCR | Conducted (TH01-KS) |
| Temperature & | Hongzhan | LP-150U | H2014011440 | -40~+150°C 20%~95%RH | Jul. 15, 2022 | Feb. 24, 2023~ Mar. 09, 2023 | Jul. 14, 2023 | Conducted (TH01-KS) |
| EXA Spectrum Analyzer | Keysight | N9010B | MY57471079 | 10Hz-44G,MAX 30dB | Oct. 12, 2022 | Mar. 16, 2023 | Oct. 11, 2023 | Radiation (03CH04-KS) |
| Bilog Antenna | TeseQ | CBL6111D | 49922 | 30MHz-1GHz | May 24, 2022 | Mar. 16, 2023 | May 23, 2023 | Radiation (03CH04-KS) |
| Horn Antenna | Schwarzbeck | BBHA9120D | 1284 | 1GHz~18GHz | Oct. 16, 2022 | Mar. 16, 2023 | Oct. 15, 2023 | Radiation (03CH04-KS) |
| SHF-EHF Horn | Com-power | AH-840 | 101070 | 18GHz~40GHz | Jan. 08, 2023 | Mar. 16, 2023 | Jan. 07, 2024 | Radiation (03CH04-KS) |
| Amplifier | SONOMA | 310N | 187289 | 9KHz-1GHz | May 24, 2022 | Mar. 16, 2023 | May 23, 2023 | Radiation (03CH04-KS) |
| Amplifier | MITEQ | EM18G40G GA | 060728 | 18~40GHz | Jan. 05, 2023 | Mar. 16, 2023 | Jan. 04, 2024 | Radiation (03CH04-KS) |
| high gain Amplifier | EM | EM01G18G A | 060840 | 1Ghz-18Ghz | Oct. 12, 2022 | Mar. 16, 2023 | Oct. 11, 2023 | Radiation (03CH04-KS) |
| Amplifier | Agilent | 8449B | 3008A02370 | 1Ghz-18Ghz | Oct. 12, 2022 | Mar. 16, 2023 | Oct. 11, 2023 | Radiation (03CH04-KS) |
| AC Power Source | Chroma | 61601 | F104090004 | N/A | NCR | Mar. 16, 2023 | NCR | Radiation (03CH04-KS) |
| Turn Table | ChamPro | EM 1000-T | 060762-T | 0~360 degree | NCR | Mar. 16, 2023 | NCR | Radiation (03CH04-KS) |
| Antenna Mast | ChamPro | EM 1000-A | 060762-A | 1 m~4 m | NCR | Mar. 16, 2023 | NCR | Radiation (03CH04-KS) |

NCR: No Calibration Required



6 Uncertainty of Evaluation

The measurement uncertainties shown below were calculated in accordance with the requirements of ANSI 63.26-2015. All the measurement uncertainty value were shown with a coverage K=2 to indicate 95% level of confidence. The measurement data show herein meets or exceeds the CISPR measurement uncertainty values specified in CISPR 16-4-2 and can be compared directly to specified limit to determine compliance.

Uncertainty of Conducted Measurement

| Test Item | Uncertainty |
|----------------------------|-------------|
| Conducted Power | ±0.46 dB |
| Conducted Emissions | ±0.48 dB |
| Occupied Channel Bandwidth | ±0.1 % |

Uncertainty of Radiated Emission Measurement (30 MHz ~ 1000 MHz)

| | |
|---|-------|
| Measuring Uncertainty for a Level of Confidence of 95% (U = 2Uc(y)) | 3.3dB |
|---|-------|

Uncertainty of Radiated Emission Measurement (1 GHz ~ 40 GHz)

| | |
|---|-------|
| Measuring Uncertainty for a Level of Confidence of 95% (U = 2Uc(y)) | 2.8dB |
|---|-------|



Appendix A. Test Results of Conducted Test

| | | | |
|-----------------|------------|---------------------|---------|
| Test Engineer : | Simle Wang | Temperature : | 22~23°C |
| | | Relative Humidity : | 40~42% |

Conducted Output Power(Average power) and ERP/EIRP

LTE Band 2 <Ant.2>:

| BW [MHz] | Modulation | RB Size | RB Offset | Power Low | Power Middle | Power High | EIRP(W) | | |
|-----------------|------------|---------|-----------|-------------|--------------|-------------|---------|--------|--------|
| | | | | Ch. / Freq. | Ch. / Freq. | Ch. / Freq. | L | M | H |
| Channel | | | | 18700 | 18900 | 19100 | EIRP(W) | | |
| Frequency (MHz) | | | | 1860 | 1880 | 1900 | L | M | H |
| 20 | QPSK | 1 | 0 | 23.34 | 23.41 | 23.32 | 0.4188 | 0.4256 | 0.4169 |
| 20 | QPSK | 1 | 99 | 23.29 | 23.38 | 23.32 | 0.4140 | 0.4227 | 0.4169 |
| 20 | QPSK | 100 | 0 | 22.35 | 22.45 | 22.34 | 0.3334 | 0.3412 | 0.3327 |
| 20 | 16QAM | 1 | 0 | 22.45 | 22.61 | 22.54 | 0.3412 | 0.3540 | 0.3483 |
| 20 | 64QAM | 1 | 0 | 21.45 | 21.50 | 21.46 | 0.2710 | 0.2742 | 0.2716 |
| 20 | 256QAM | 1 | 0 | 18.45 | 18.50 | 18.37 | 0.1358 | 0.1374 | 0.1334 |
| Channel | | | | 18675 | 18900 | 19125 | EIRP(W) | | |
| Frequency (MHz) | | | | 1857.5 | 1880 | 1902.5 | L | M | H |
| 15 | QPSK | 1 | 0 | 23.23 | 23.39 | 23.21 | 0.4083 | 0.4236 | 0.4064 |
| 15 | 16QAM | 1 | 0 | 22.36 | 22.55 | 22.43 | 0.3342 | 0.3491 | 0.3396 |
| Channel | | | | 18650 | 18900 | 19150 | EIRP(W) | | |
| Frequency (MHz) | | | | 1855 | 1880 | 1905 | L | M | H |
| 10 | QPSK | 1 | 0 | 23.12 | 23.36 | 23.24 | 0.3981 | 0.4207 | 0.4093 |
| 10 | 16QAM | 1 | 0 | 22.43 | 22.54 | 22.51 | 0.3396 | 0.3483 | 0.3459 |
| Channel | | | | 18625 | 18900 | 19175 | EIRP(W) | | |
| Frequency (MHz) | | | | 1852.5 | 1880 | 1907.5 | L | M | H |
| 5 | QPSK | 1 | 0 | 23.27 | 23.33 | 23.23 | 0.4121 | 0.4178 | 0.4083 |
| 5 | 16QAM | 1 | 0 | 22.30 | 22.49 | 22.40 | 0.3296 | 0.3443 | 0.3373 |
| Channel | | | | 18615 | 18900 | 19185 | EIRP(W) | | |
| Frequency (MHz) | | | | 1851.5 | 1880 | 1908.5 | L | M | H |
| 3 | QPSK | 1 | 0 | 23.24 | 23.31 | 23.20 | 0.4093 | 0.4159 | 0.4055 |
| 3 | 16QAM | 1 | 0 | 22.34 | 22.58 | 22.43 | 0.3327 | 0.3516 | 0.3396 |
| Channel | | | | 18607 | 18900 | 19193 | EIRP(W) | | |
| Frequency (MHz) | | | | 1850.7 | 1880 | 1909.3 | L | M | H |
| 1.4 | QPSK | 1 | 0 | 23.20 | 23.40 | 23.19 | 0.4055 | 0.4246 | 0.4046 |
| 1.4 | 16QAM | 1 | 0 | 22.40 | 22.55 | 22.50 | 0.3373 | 0.3491 | 0.3451 |



LTE Band 4 <Ant.2>:

| BW [MHz] | Modulation | RB Size | RB Offset | Power Low Ch. / Freq. | Power Middle Ch. / Freq. | Power High Ch. / Freq. | EIRP(W) | | |
|-----------------|------------|---------|-----------|-----------------------|--------------------------|------------------------|---------|--------|--------|
| Channel | | | | 20050 | 20175 | 20300 | EIRP(W) | | |
| Frequency (MHz) | | | | 1720 | 1732.5 | 1745 | L | M | H |
| 20 | QPSK | 1 | 0 | 23.34 | 23.49 | 23.40 | 0.3936 | 0.4074 | 0.3990 |
| 20 | QPSK | 1 | 99 | 23.38 | 23.40 | 23.32 | 0.3972 | 0.3990 | 0.3917 |
| 20 | QPSK | 100 | 0 | 22.32 | 22.46 | 22.33 | 0.3112 | 0.3214 | 0.3119 |
| 20 | 16QAM | 1 | 0 | 22.50 | 22.57 | 22.50 | 0.3243 | 0.3296 | 0.3243 |
| 20 | 64QAM | 1 | 0 | 21.35 | 21.42 | 21.33 | 0.2489 | 0.2529 | 0.2477 |
| 20 | 256QAM | 1 | 0 | 18.39 | 18.51 | 18.38 | 0.1259 | 0.1294 | 0.1256 |
| Channel | | | | 20025 | 20175 | 20325 | EIRP(W) | | |
| Frequency (MHz) | | | | 1717.5 | 1732.5 | 1747.5 | L | M | H |
| 15 | QPSK | 1 | 0 | 23.22 | 23.42 | 23.37 | 0.3828 | 0.4009 | 0.3963 |
| 15 | 16QAM | 1 | 0 | 22.38 | 22.50 | 22.26 | 0.3155 | 0.3243 | 0.3069 |
| Channel | | | | 20000 | 20175 | 20350 | EIRP(W) | | |
| Frequency (MHz) | | | | 1715 | 1732.5 | 1750 | L | M | H |
| 10 | QPSK | 1 | 0 | 23.31 | 23.33 | 23.34 | 0.3908 | 0.3926 | 0.3936 |
| 10 | 16QAM | 1 | 0 | 22.39 | 22.50 | 22.34 | 0.3162 | 0.3243 | 0.3126 |
| Channel | | | | 19975 | 20175 | 20375 | EIRP(W) | | |
| Frequency (MHz) | | | | 1712.5 | 1732.5 | 1752.5 | L | M | H |
| 5 | QPSK | 1 | 0 | 23.31 | 23.35 | 23.26 | 0.3908 | 0.3945 | 0.3864 |
| 5 | 16QAM | 1 | 0 | 22.35 | 22.53 | 22.46 | 0.3133 | 0.3266 | 0.3214 |
| Channel | | | | 19965 | 20175 | 20385 | EIRP(W) | | |
| Frequency (MHz) | | | | 1711.5 | 1732.5 | 1753.5 | L | M | H |
| 3 | QPSK | 1 | 0 | 23.24 | 23.44 | 23.24 | 0.3846 | 0.4027 | 0.3846 |
| 3 | 16QAM | 1 | 0 | 22.45 | 22.41 | 22.46 | 0.3206 | 0.3177 | 0.3214 |
| Channel | | | | 19950 | 20175 | 20393 | EIRP(W) | | |
| Frequency (MHz) | | | | 1710 | 1732.5 | 1754.3 | L | M | H |
| 1.4 | QPSK | 1 | 0 | 23.18 | 23.46 | 23.28 | 0.3793 | 0.4046 | 0.3882 |
| 1.4 | 16QAM | 1 | 0 | 22.35 | 22.50 | 22.40 | 0.3133 | 0.3243 | 0.3170 |



LTE Band 5 <Ant.1>:

| BW [MHz] | Modulation | RB Size | RB Offset | Power Low Ch. / Freq. | Power Middle Ch. / Freq. | Power High Ch. / Freq. | ERP(W) | | |
|-----------------|------------|---------|-----------|-----------------------|--------------------------|------------------------|--------|--------|--------|
| Channel | | | | 20450 | 20525 | 20600 | ERP(W) | | |
| Frequency (MHz) | | | | 829 | 836.5 | 844 | L | M | H |
| 10 | QPSK | 1 | 0 | 23.82 | 23.94 | 23.88 | 0.1483 | 0.1524 | 0.1503 |
| 10 | QPSK | 1 | 49 | 23.76 | 23.85 | 23.74 | 0.1462 | 0.1493 | 0.1455 |
| 10 | QPSK | 50 | 0 | 22.79 | 22.94 | 22.91 | 0.1169 | 0.1211 | 0.1202 |
| 10 | 16QAM | 1 | 0 | 23.05 | 23.12 | 22.96 | 0.1242 | 0.1262 | 0.1216 |
| 10 | 64QAM | 1 | 0 | 21.96 | 22.02 | 21.99 | 0.0966 | 0.0979 | 0.0973 |
| 10 | 256QAM | 1 | 0 | 18.95 | 19.06 | 18.98 | 0.0483 | 0.0495 | 0.0486 |
| Channel | | | | 20425 | 20525 | 20625 | ERP(W) | | |
| Frequency (MHz) | | | | 826.5 | 836.5 | 846.5 | L | M | H |
| 5 | QPSK | 1 | 0 | 23.71 | 23.89 | 23.72 | 0.1445 | 0.1507 | 0.1449 |
| 5 | 16QAM | 1 | 0 | 22.98 | 22.99 | 22.86 | 0.1222 | 0.1225 | 0.1189 |
| Channel | | | | 20415 | 20525 | 20635 | ERP(W) | | |
| Frequency (MHz) | | | | 825.5 | 836.5 | 847.5 | L | M | H |
| 3 | QPSK | 1 | 0 | 23.74 | 23.85 | 23.74 | 0.1455 | 0.1493 | 0.1455 |
| 3 | 16QAM | 1 | 0 | 22.96 | 23.01 | 22.85 | 0.1216 | 0.1230 | 0.1186 |
| Channel | | | | 20407 | 20525 | 20643 | ERP(W) | | |
| Frequency (MHz) | | | | 824.7 | 836.5 | 848.3 | L | M | H |
| 1.4 | QPSK | 1 | 0 | 23.67 | 23.89 | 23.85 | 0.1432 | 0.1507 | 0.1493 |
| 1.4 | 16QAM | 1 | 0 | 23.00 | 23.02 | 22.87 | 0.1227 | 0.1233 | 0.1191 |



LTE Band 25 <Ant.2>:

| BW [MHz] | Modulation | RB Size | RB Offset | Power Low Ch. / Freq. | Power Middle Ch. / Freq. | Power High Ch. / Freq. | EIRP(W) | | |
|-----------------|------------|---------|-----------|-----------------------|--------------------------|------------------------|---------|--------|--------|
| Channel | | | | 26140 | 26340 | 26590 | EIRP(W) | | |
| Frequency (MHz) | | | | 1860 | 1880 | 1905 | L | M | H |
| 20 | QPSK | 1 | 0 | 23.42 | 23.47 | 23.38 | 0.4266 | 0.4315 | 0.4227 |
| 20 | QPSK | 1 | 99 | 23.29 | 23.44 | 23.29 | 0.4140 | 0.4285 | 0.4140 |
| 20 | QPSK | 100 | 0 | 22.62 | 22.66 | 22.53 | 0.3548 | 0.3581 | 0.3475 |
| 20 | 16QAM | 1 | 0 | 22.49 | 22.62 | 22.57 | 0.3443 | 0.3548 | 0.3508 |
| 20 | 64QAM | 1 | 0 | 21.55 | 21.65 | 21.54 | 0.2773 | 0.2838 | 0.2767 |
| 20 | 256QAM | 1 | 0 | 18.64 | 18.81 | 18.73 | 0.1419 | 0.1476 | 0.1449 |
| Channel | | | | 26115 | 26340 | 26615 | EIRP(W) | | |
| Frequency (MHz) | | | | 1857.5 | 1880 | 1907.5 | L | M | H |
| 15 | QPSK | 1 | 0 | 23.37 | 23.43 | 23.34 | 0.4217 | 0.4276 | 0.4188 |
| 15 | 16QAM | 1 | 0 | 22.43 | 22.53 | 22.54 | 0.3396 | 0.3475 | 0.3483 |
| Channel | | | | 26090 | 26340 | 26640 | EIRP(W) | | |
| Frequency (MHz) | | | | 1855 | 1880 | 1910 | L | M | H |
| 10 | QPSK | 1 | 0 | 23.16 | 23.41 | 23.13 | 0.4018 | 0.4256 | 0.3990 |
| 10 | 16QAM | 1 | 0 | 22.43 | 22.59 | 22.49 | 0.3396 | 0.3524 | 0.3443 |
| Channel | | | | 26065 | 26340 | 26665 | EIRP(W) | | |
| Frequency (MHz) | | | | 1852.5 | 1880 | 1912.5 | L | M | H |
| 5 | QPSK | 1 | 0 | 23.21 | 23.40 | 23.19 | 0.4064 | 0.4246 | 0.4046 |
| 5 | 16QAM | 1 | 0 | 22.32 | 22.47 | 22.52 | 0.3311 | 0.3428 | 0.3467 |
| Channel | | | | 26055 | 26340 | 26675 | EIRP(W) | | |
| Frequency (MHz) | | | | 1851.5 | 1880 | 1913.5 | L | M | H |
| 3 | QPSK | 1 | 0 | 23.21 | 23.36 | 23.12 | 0.4064 | 0.4207 | 0.3981 |
| 3 | 16QAM | 1 | 0 | 22.38 | 22.58 | 22.42 | 0.3357 | 0.3516 | 0.3388 |
| Channel | | | | 26047 | 26340 | 26683 | EIRP(W) | | |
| Frequency (MHz) | | | | 1850.7 | 1880 | 1914.3 | L | M | H |
| 1.4 | QPSK | 1 | 0 | 23.46 | 23.39 | 23.34 | 0.4305 | 0.4236 | 0.4188 |
| 1.4 | 16QAM | 1 | 0 | 22.33 | 22.59 | 22.42 | 0.3319 | 0.3524 | 0.3388 |



LTE Band 26 <Ant.1>:

| BW [MHz] | Modulation | RB Size | RB Offset | Power Low Ch. / Freq. | Power Low Ch. / Freq. | Power Middle Ch. / Freq. | Power High Ch. / Freq. | ERP(W) | | | |
|-----------------|------------|---------|-----------|-----------------------|-----------------------|--------------------------|------------------------|-------------|--------|--------|--------|
| Channel | | | | 26790 | 26865 | 26915 | 26965 | | | | |
| Frequency (MHz) | | | | 824 | 831.5 | 836.5 | 841.5 | Straddle Ch | L | M | H |
| 15 | QPSK | 1 | 0 | 24.01 | 24.02 | 24.10 | 23.97 | 0.1549 | 0.1552 | 0.1581 | 0.1535 |
| 15 | QPSK | 1 | 74 | 23.80 | 23.81 | 23.93 | 23.84 | 0.1476 | 0.1479 | 0.1521 | 0.1489 |
| 15 | QPSK | 75 | 0 | 22.89 | 22.92 | 23.06 | 22.92 | 0.1197 | 0.1205 | 0.1245 | 0.1205 |
| 15 | 16QAM | 1 | 0 | 23.12 | 23.10 | 23.20 | 23.15 | 0.1262 | 0.1256 | 0.1285 | 0.1271 |
| 15 | 64QAM | 1 | 0 | 22.13 | 22.05 | 22.18 | 22.16 | 0.1005 | 0.0986 | 0.1016 | 0.1012 |
| 15 | 256QAM | 1 | 0 | 19.03 | 19.00 | 19.14 | 19.02 | 0.0492 | 0.0489 | 0.0505 | 0.0491 |
| Channel | | | | - | 26840 | 26915 | 26990 | ERP(W) | | | |
| Frequency (MHz) | | | | | 829 | 836.5 | 844 | L | M | H | |
| 10 | QPSK | 1 | 0 | | 23.94 | 23.97 | 23.85 | - | 0.1524 | 0.1535 | 0.1493 |
| 10 | 16QAM | 1 | 0 | | 23.07 | 23.14 | 23.03 | - | 0.1247 | 0.1268 | 0.1236 |
| Channel | | | | | 26815 | 26915 | 27015 | ERP(W) | | | |
| Frequency (MHz) | | | | | 826.5 | 836.5 | 846.5 | L | M | H | |
| 5 | QPSK | 1 | 0 | | 23.95 | 24.04 | 23.82 | - | 0.1528 | 0.1560 | 0.1483 |
| 5 | 16QAM | 1 | 0 | | 23.03 | 23.11 | 23.00 | - | 0.1236 | 0.1259 | 0.1227 |
| Channel | | | | | 26815 | 26915 | 27025 | ERP(W) | | | |
| Frequency (MHz) | | | | | 825.5 | 836.5 | 847.5 | L | M | H | |
| 3 | QPSK | 1 | 0 | | 24.00 | 24.02 | 23.81 | - | 0.1545 | 0.1552 | 0.1479 |
| 3 | 16QAM | 1 | 0 | | 22.98 | 23.13 | 23.08 | - | 0.1222 | 0.1265 | 0.1250 |
| Channel | | | | | 26797 | 26915 | 27033 | ERP(W) | | | |
| Frequency (MHz) | | | | | 824.7 | 836.5 | 848.3 | L | M | H | |
| 1.4 | QPSK | 1 | 0 | | 23.86 | 24.01 | 23.87 | - | 0.1496 | 0.1549 | 0.1500 |
| 1.4 | 16QAM | 1 | 0 | | 22.98 | 23.13 | 23.08 | - | 0.1222 | 0.1265 | 0.1250 |



LTE Band 66 <Ant.2>:

| BW [MHz] | Modulation | RB Size | RB Offset | Power Low Ch. / Freq. | Power Middle Ch. / Freq. | Power High Ch. / Freq. | EIRP(W) | | |
|-----------------|------------|---------|-----------|-----------------------|--------------------------|------------------------|---------|--------|--------|
| Channel | | | | 132072 | 132322 | 132572 | EIRP(W) | | |
| Frequency (MHz) | | | | 1720 | 1745 | 1770 | L | M | H |
| 20 | QPSK | 1 | 0 | 23.48 | 23.53 | 23.39 | 0.4064 | 0.4111 | 0.3981 |
| 20 | QPSK | 1 | 99 | 23.39 | 23.48 | 23.44 | 0.3981 | 0.4064 | 0.4027 |
| 20 | QPSK | 100 | 0 | 22.59 | 22.63 | 22.47 | 0.3311 | 0.3342 | 0.3221 |
| 20 | 16QAM | 1 | 0 | 22.61 | 22.70 | 22.56 | 0.3327 | 0.3396 | 0.3289 |
| 20 | 64QAM | 1 | 0 | 21.51 | 21.63 | 21.53 | 0.2582 | 0.2655 | 0.2594 |
| 20 | 256QAM | 1 | 0 | 18.56 | 18.59 | 18.43 | 0.1309 | 0.1318 | 0.1271 |
| Channel | | | | 132047 | 132322 | 132597 | EIRP(W) | | |
| Frequency (MHz) | | | | 1717.5 | 1745 | 1772.5 | L | M | H |
| 15 | QPSK | 1 | 0 | 23.22 | 23.46 | 23.27 | 0.3828 | 0.4046 | 0.3873 |
| 15 | 16QAM | 1 | 0 | 22.56 | 22.64 | 22.46 | 0.3289 | 0.3350 | 0.3214 |
| Channel | | | | 132022 | 132322 | 132622 | EIRP(W) | | |
| Frequency (MHz) | | | | 1715 | 1745 | 1775 | L | M | H |
| 10 | QPSK | 1 | 0 | 23.33 | 23.41 | 23.37 | 0.3926 | 0.3999 | 0.3963 |
| 10 | 16QAM | 1 | 0 | 22.39 | 22.57 | 22.34 | 0.3162 | 0.3296 | 0.3126 |
| Channel | | | | 131997 | 132322 | 132647 | EIRP(W) | | |
| Frequency (MHz) | | | | 1712.5 | 1745 | 1777.5 | L | M | H |
| 5 | QPSK | 1 | 0 | 23.41 | 23.43 | 23.22 | 0.3999 | 0.4018 | 0.3828 |
| 5 | 16QAM | 1 | 0 | 22.32 | 22.57 | 22.39 | 0.3112 | 0.3296 | 0.3162 |
| Channel | | | | 131987 | 132322 | 132657 | EIRP(W) | | |
| Frequency (MHz) | | | | 1711.5 | 1745 | 1778.5 | L | M | H |
| 3 | QPSK | 1 | 0 | 23.34 | 23.31 | 23.41 | 0.3936 | 0.3908 | 0.3999 |
| 3 | 16QAM | 1 | 0 | 22.52 | 22.59 | 22.45 | 0.3258 | 0.3311 | 0.3206 |
| Channel | | | | 131979 | 132322 | 132665 | EIRP(W) | | |
| Frequency (MHz) | | | | 1710.7 | 1745 | 1779.3 | L | M | H |
| 1.4 | QPSK | 1 | 0 | 23.36 | 23.48 | 23.39 | 0.3954 | 0.4064 | 0.3981 |
| 1.4 | 16QAM | 1 | 0 | 22.54 | 22.62 | 22.48 | 0.3273 | 0.3334 | 0.3228 |



LTE Band 25<Ant.2>

Peak-to-Average Ratio

| Mode | LTE Band 25 / 20MHz | | | | |
|-----------|---------------------|---------|---------|---------|-------------|
| Mod. | QPSK | 16QAM | 64QAM | 256QAM | Limit: 13dB |
| RB Size | Full RB | Full RB | Full RB | Full RB | Result |
| Middle CH | 4.70 | 5.65 | 6.23 | 6.55 | PASS |

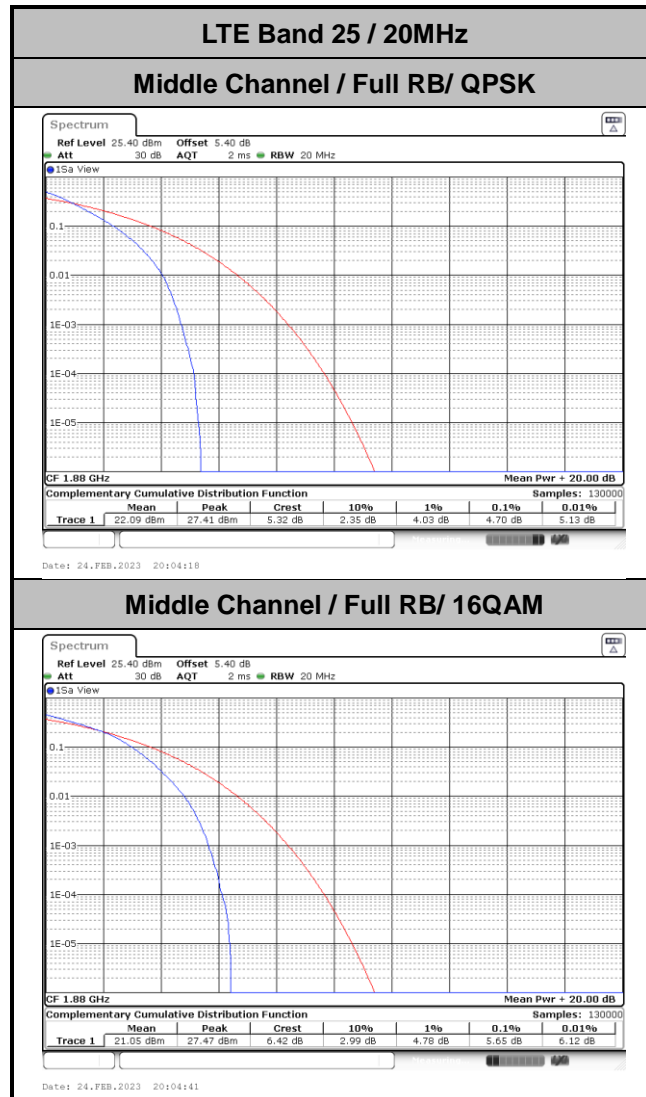

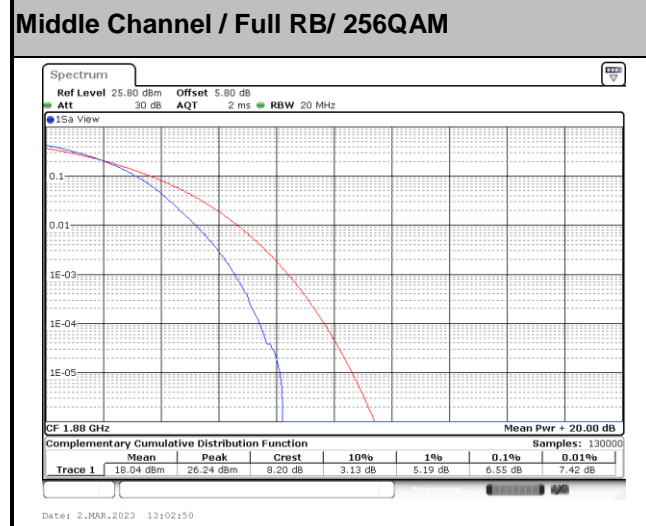
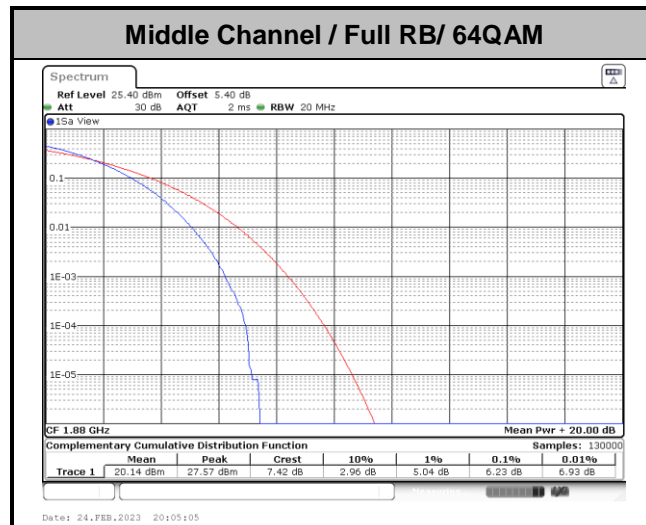



26dB Bandwidth

| Mode | LTE Band 25 : 26dB BW(MHz) | |
|------------------|----------------------------|--------------|
| BW | 1.4MHz | |
| Mod. | QPSK | 16QAM |
| Middle CH | 1.23 | 1.23 |
| BW | 3MHz | |
| Mod. | QPSK | 16QAM |
| Middle CH | 3.06 | 3.02 |
| BW | 5MHz | |
| Mod. | QPSK | 16QAM |
| Middle CH | 4.95 | 4.92 |
| BW | 10MHz | |
| Mod. | QPSK | 16QAM |
| Middle CH | 9.75 | 9.81 |
| BW | 15MHz | |
| Mod. | QPSK | 16QAM |
| Middle CH | 14.18 | 14.54 |
| BW | 20MHz | |
| Mod. | QPSK | 16QAM |
| Middle CH | 18.90 | 18.86 |



LTE Band 25

Middle Channel / 1.4MHz / QPSK

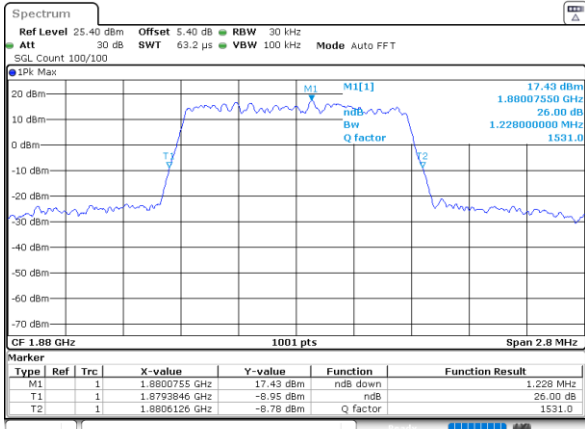

Date: 24.FEB.2023 20:06:40

Middle Channel / 1.4MHz / 16QAM

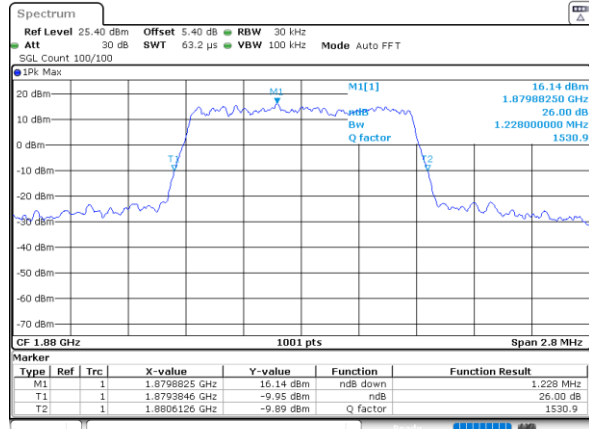

Date: 24.FEB.2023 20:07:30

Middle Channel / 3MHz / QPSK

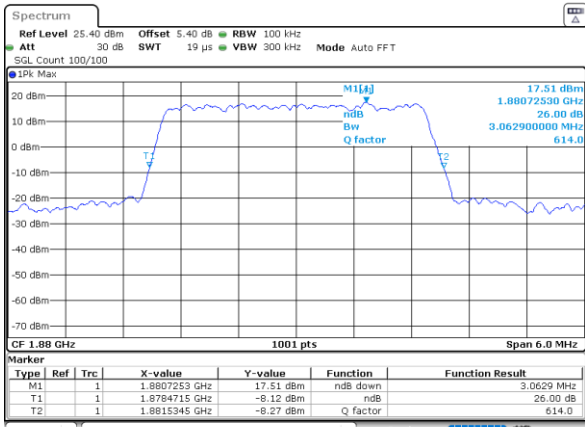

Date: 24.FEB.2023 20:08:24

Middle Channel / 3MHz / 16QAM

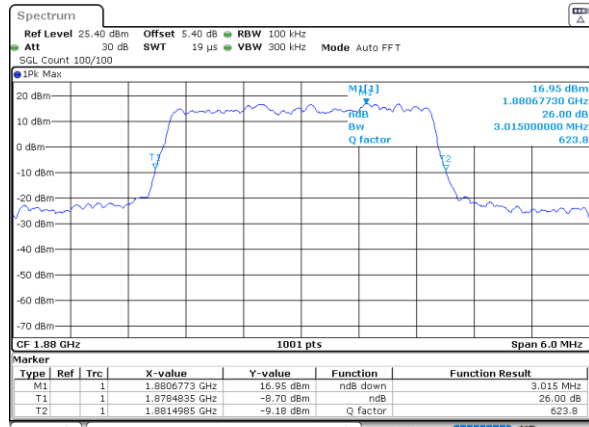

Date: 24.FEB.2023 20:09:14

Middle Channel / 5MHz / QPSK

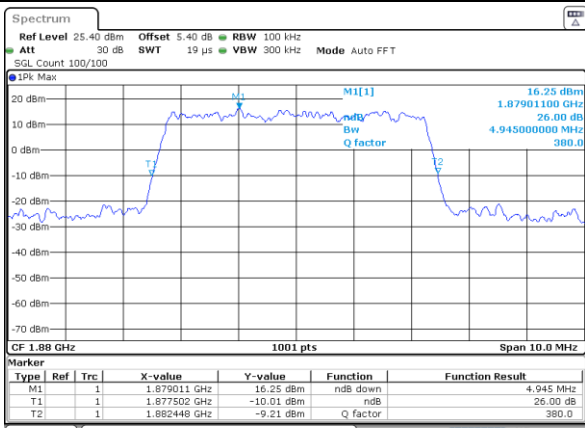

Date: 24.FEB.2023 20:10:07

Middle Channel / 5MHz / 16QAM

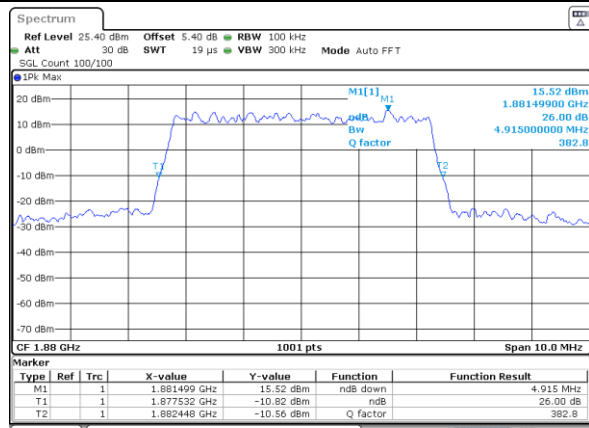

Date: 24.FEB.2023 20:12:33



LTE Band 25

Middle Channel / 10MHz / QPSK

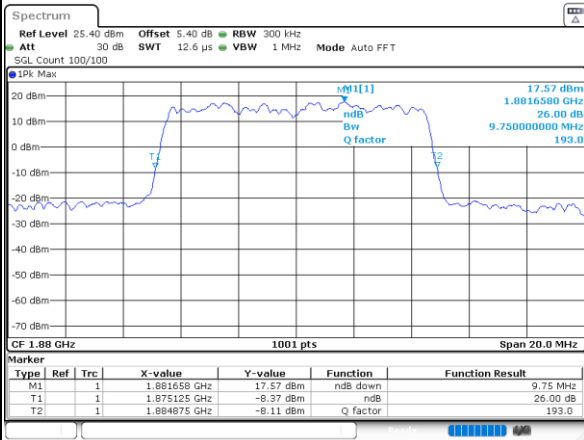

Date: 24.FEB.2023 20:14:11

Middle Channel / 10MHz / 16QAM

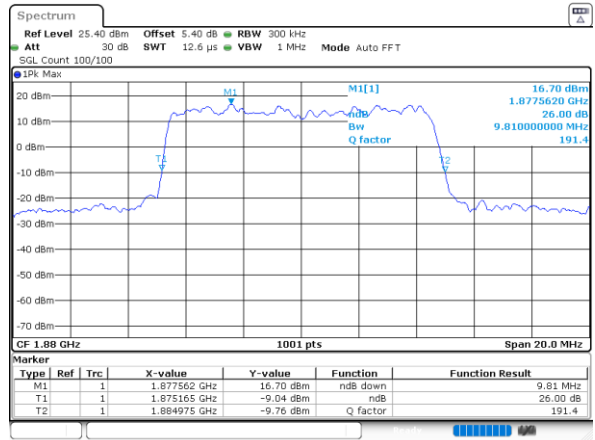

Date: 24.FEB.2023 20:15:59

Middle Channel / 15MHz / QPSK

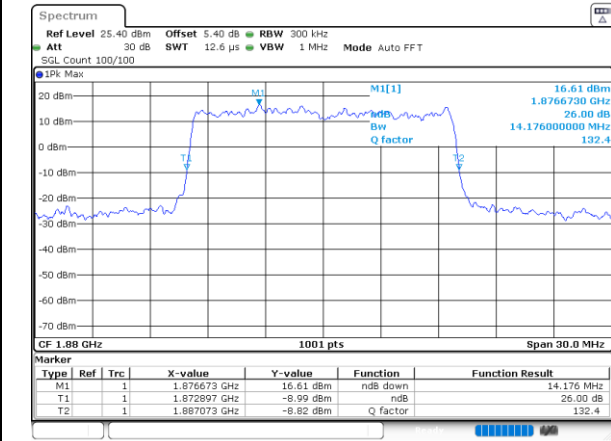

Date: 24.FEB.2023 20:17:33

Middle Channel / 15MHz / 16QAM

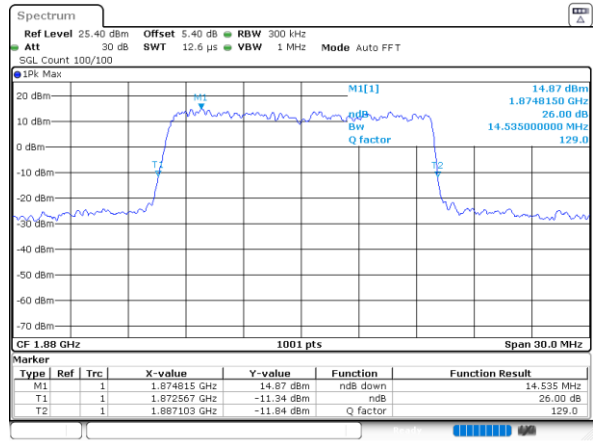

Date: 24.FEB.2023 20:19:09

Middle Channel / 20MHz / QPSK

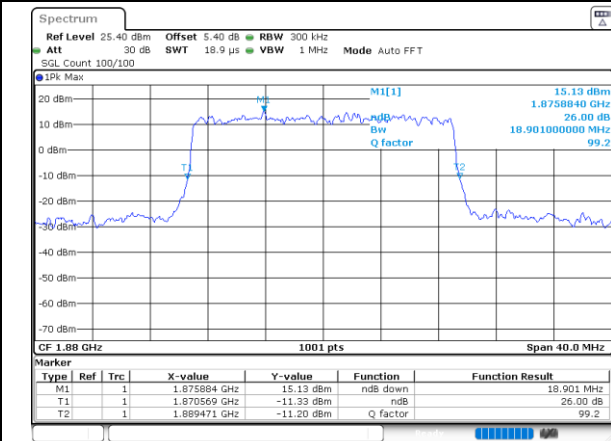

Date: 24.FEB.2023 19:52:06

Middle Channel / 20MHz / 16QAM

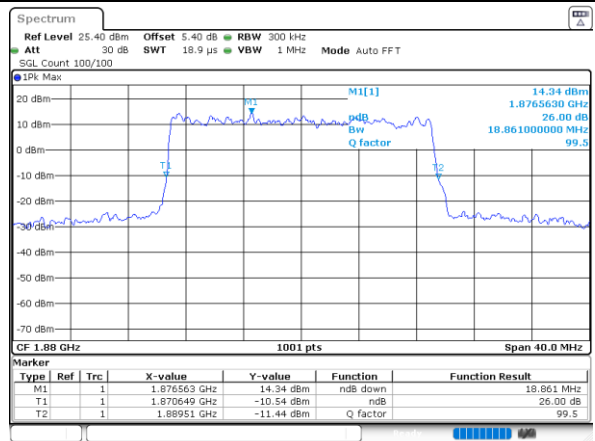

Date: 24.FEB.2023 19:52:28



Occupied Bandwidth

| Mode | LTE Band 25 : 99%OBW(MHz) | |
|------------------|---------------------------|--------------|
| BW | 1.4MHz | |
| Mod. | QPSK | 16QAM |
| Middle CH | 1.09 | 1.09 |
| BW | 3MHz | |
| Mod. | QPSK | 16QAM |
| Middle CH | 2.71 | 2.72 |
| BW | 5MHz | |
| Mod. | QPSK | 16QAM |
| Middle CH | 4.52 | 4.48 |
| BW | 10MHz | |
| Mod. | QPSK | 16QAM |
| Middle CH | 9.05 | 9.03 |
| BW | 15MHz | |
| Mod. | QPSK | 16QAM |
| Middle CH | 13.49 | 13.43 |
| BW | 20MHz | |
| Mod. | QPSK | 16QAM |
| Middle CH | 17.94 | 17.90 |



LTE Band 25

Middle Channel / 1.4MHz / QPSK

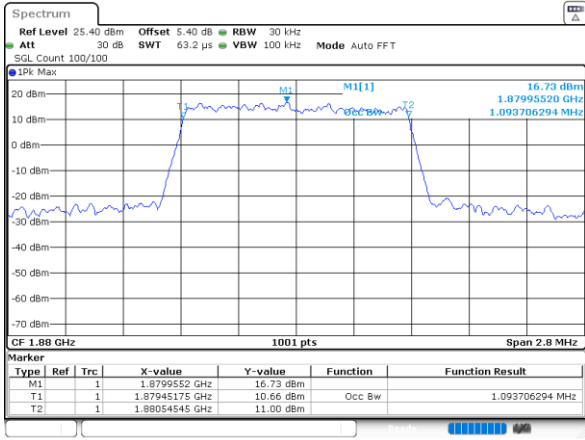

Date: 24.FEB.2023 20:06:17

Middle Channel / 1.4MHz / 16QAM

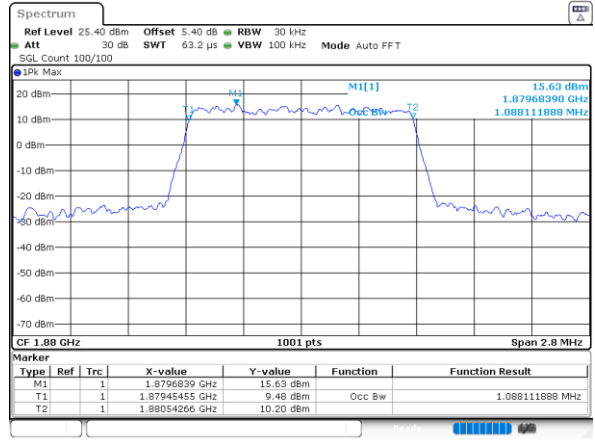

Date: 24.FEB.2023 20:07:05

Middle Channel / 3MHz / QPSK

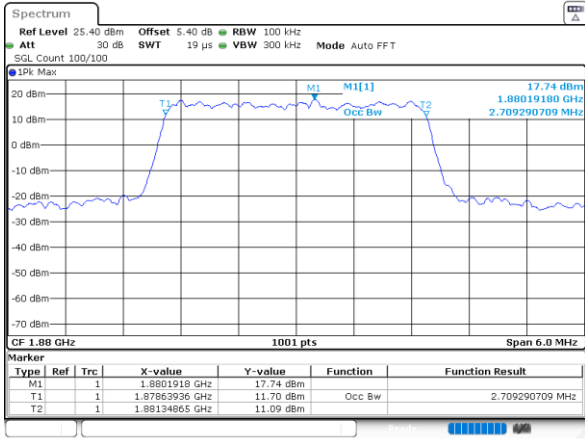

Date: 24.FEB.2023 20:08:02

Middle Channel / 3MHz / 16QAM

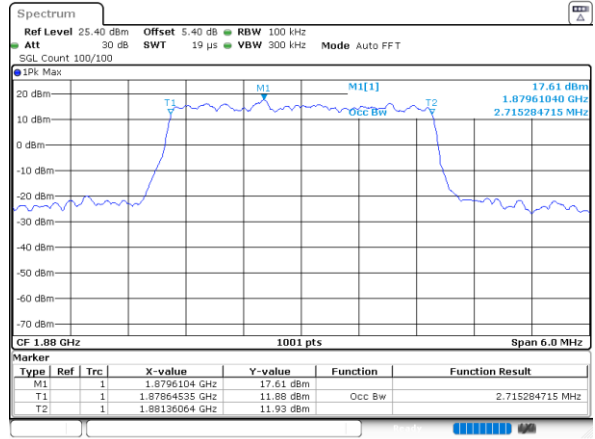

Date: 24.FEB.2023 20:08:49

Middle Channel / 5MHz / QPSK

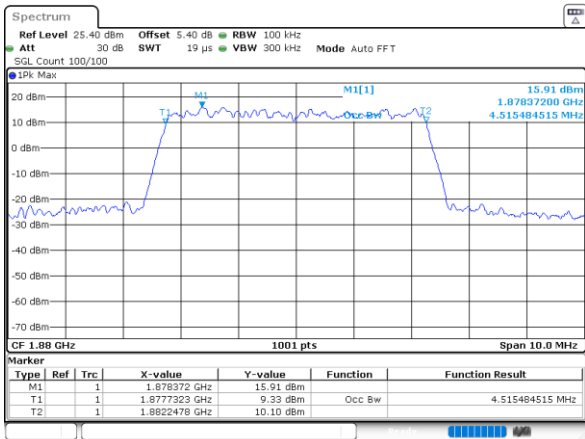

Date: 24.FEB.2023 20:09:44

Middle Channel / 5MHz / 16QAM

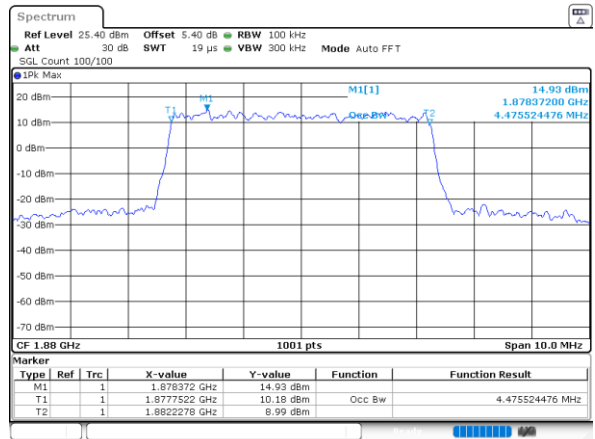

Date: 24.FEB.2023 20:11:25



LTE Band 25

Middle Channel / 10MHz / QPSK

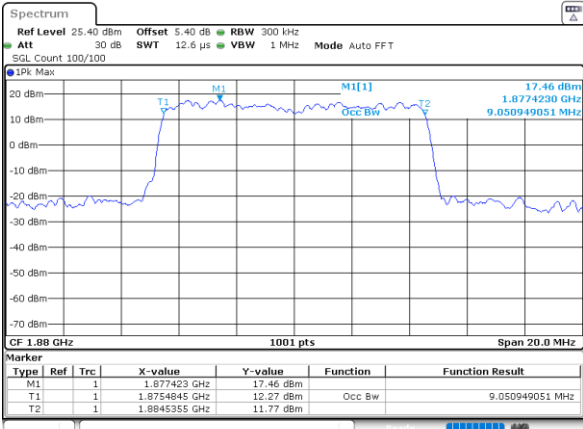

Date: 24.FEB.2023 20:13:37

Middle Channel / 10MHz / 16QAM

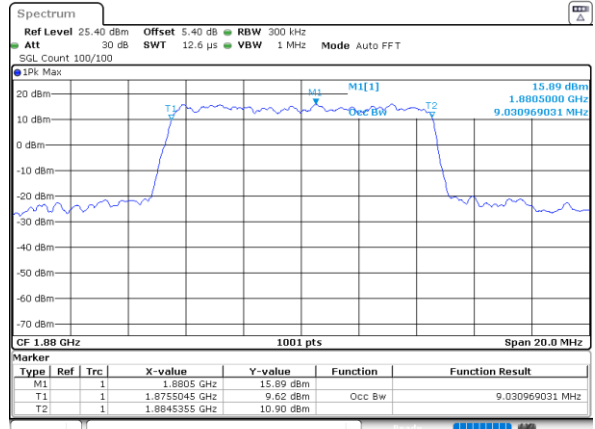

Date: 24.FEB.2023 20:14:52

Middle Channel / 15MHz / QPSK

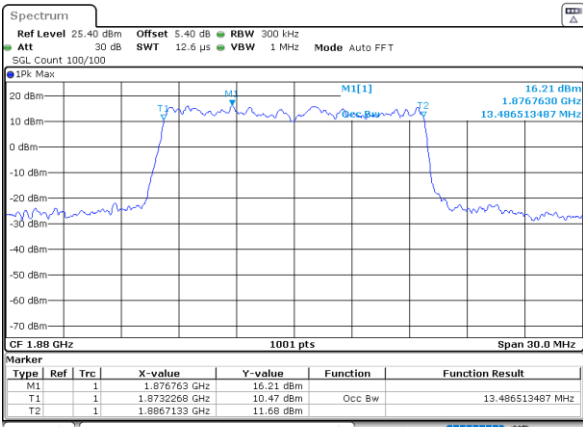

Date: 24.FEB.2023 20:16:40

Middle Channel / 15MHz / 16QAM

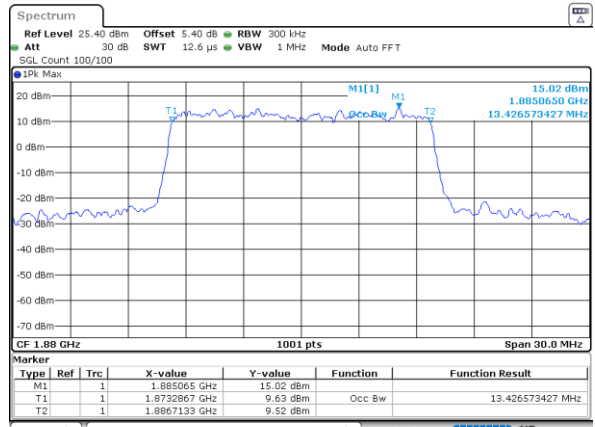

Date: 24.FEB.2023 20:18:28

Middle Channel / 20MHz / QPSK

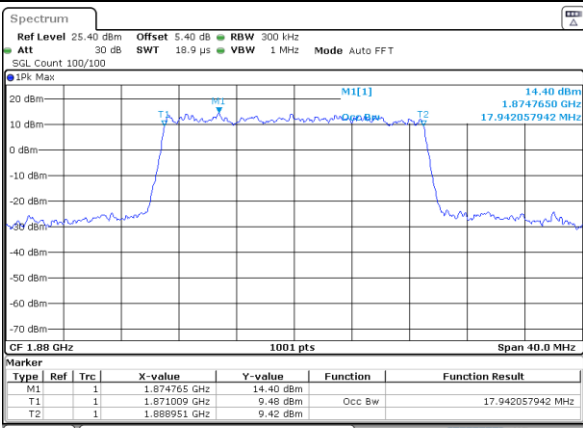

Date: 24.FEB.2023 19:51:43

Middle Channel / 20MHz / 16QAM

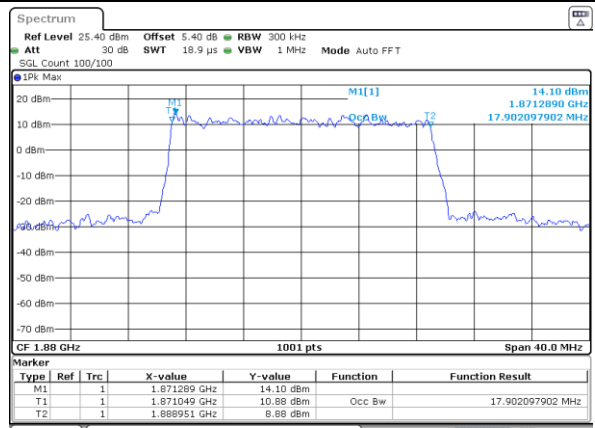

Date: 24.FEB.2023 19:54:31



Conducted Band Edge

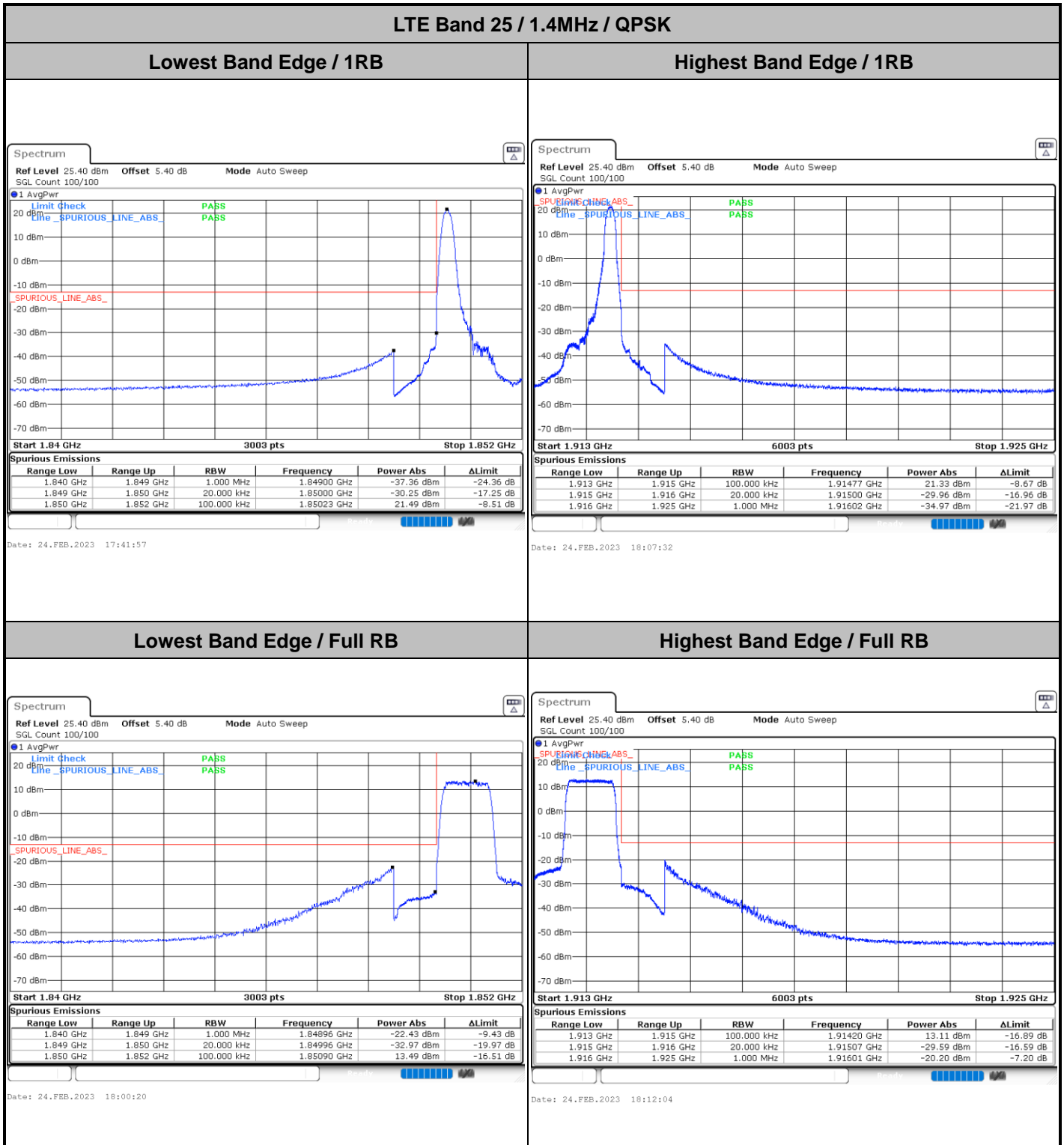



LTE Band 25 / 1.4MHz / 16QAM

Lowest Band Edge / 1 RB

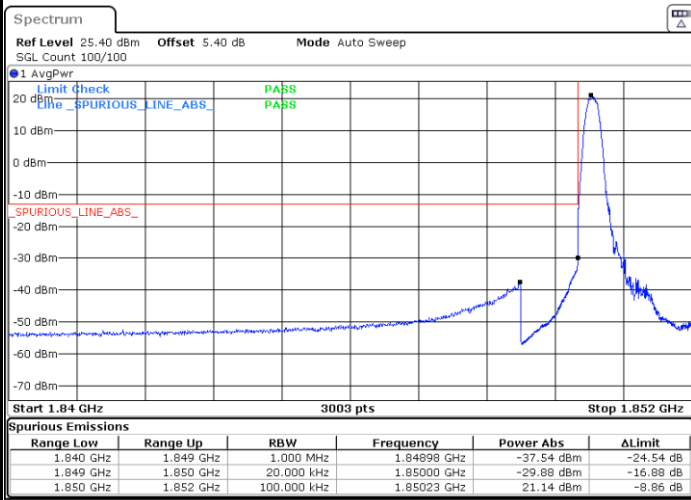

Date: 24.FEB.2023 17:44:21

Highest Band Edge / 1 RB

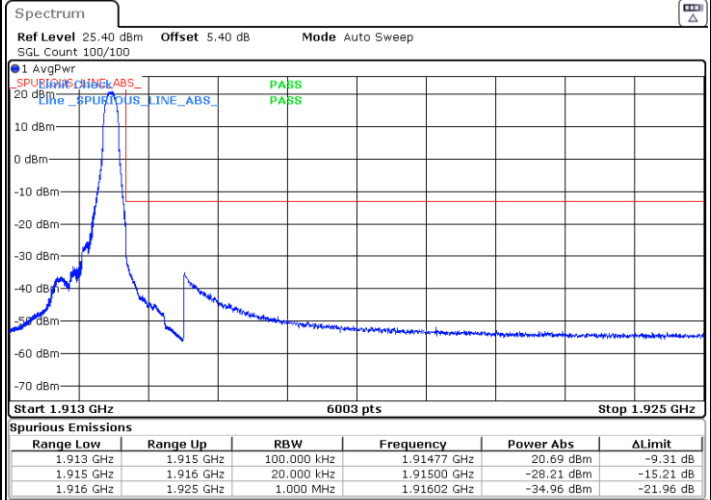

Date: 24.FEB.2023 18:09:02

Lowest Band Edge / Full RB

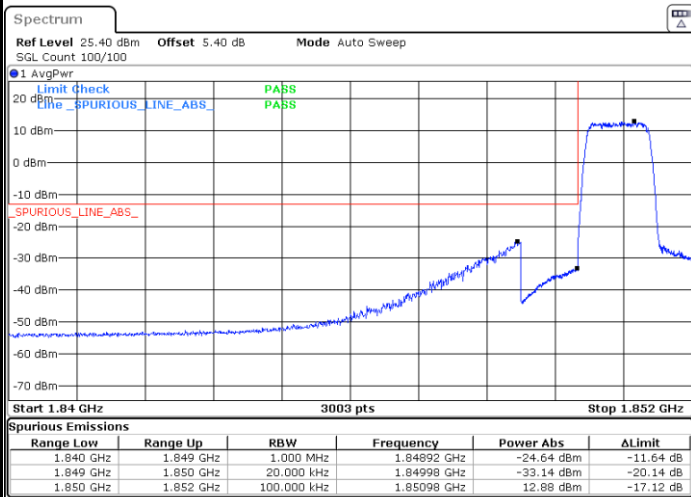

Date: 24.FEB.2023 18:01:50

Highest Band Edge / Full RB

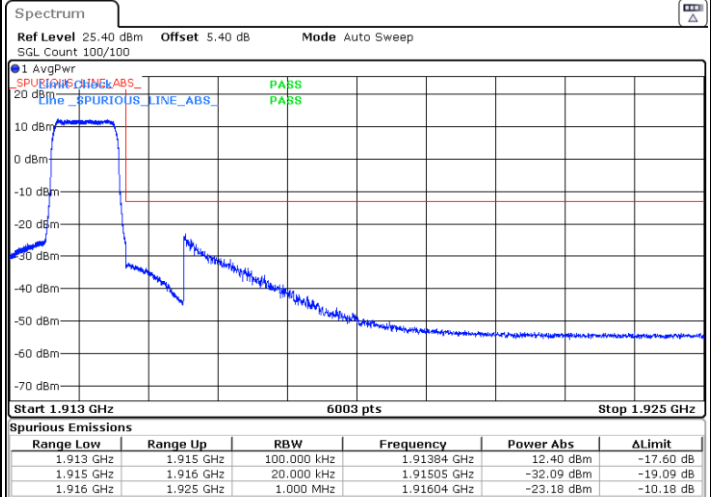

Date: 24.FEB.2023 18:13:34



LTE Band 25 / 1.4MHz / 64QAM

Lowest Band Edge / 1 RB

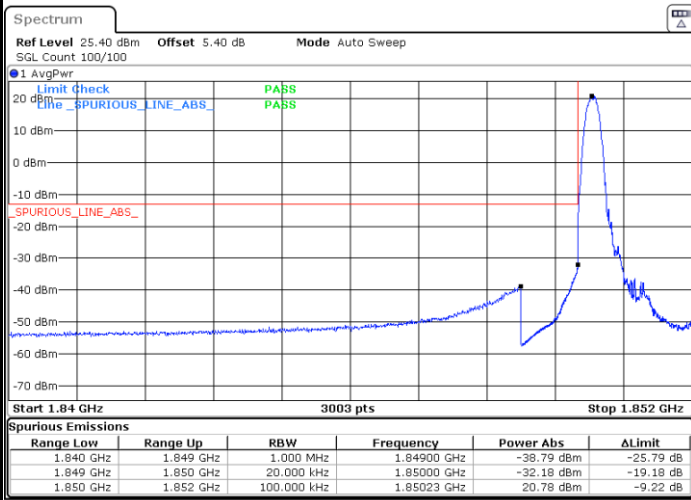

Date: 24.FEB.2023 17:46:01

Highest Band Edge / 1 RB

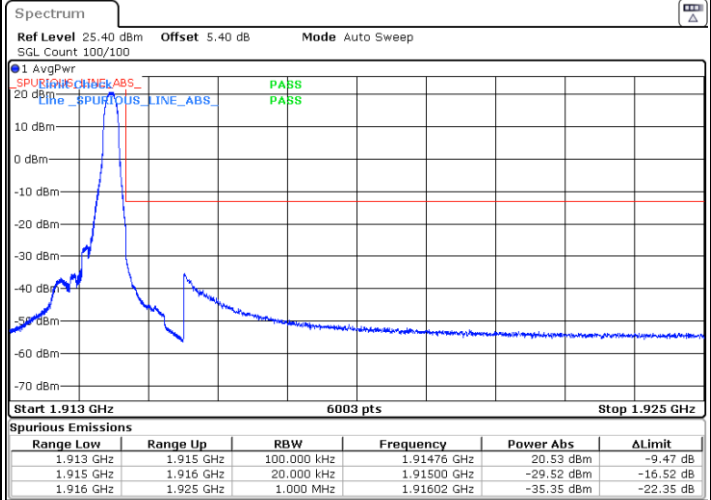

Date: 24.FEB.2023 18:10:33

Lowest Band Edge / Full RB

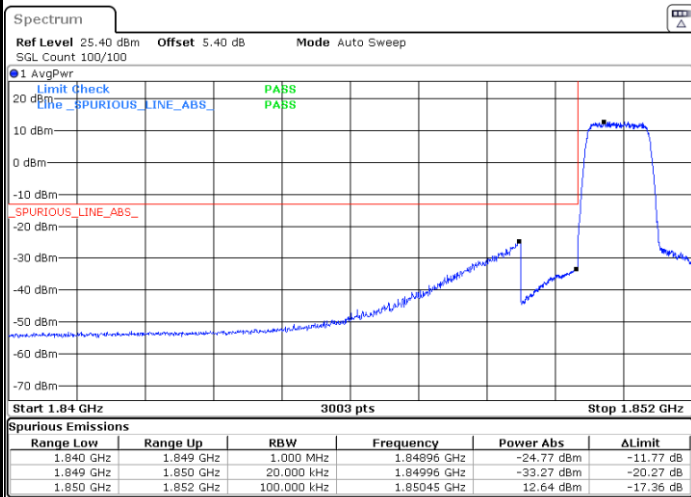

Date: 24.FEB.2023 18:03:21

Highest Band Edge / Full RB

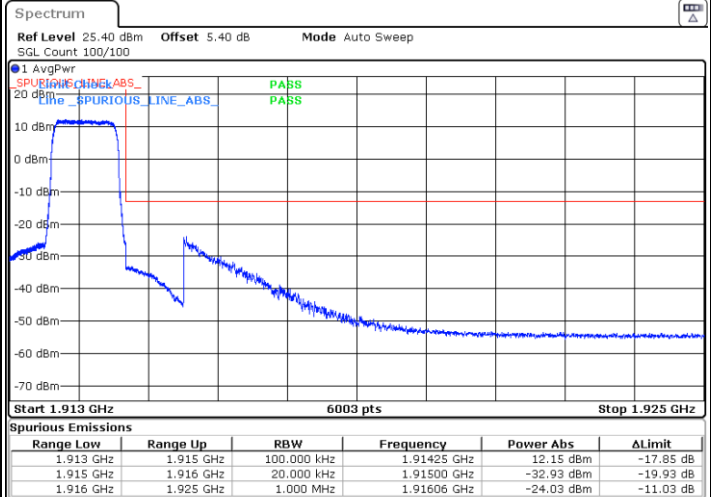

Date: 24.FEB.2023 18:15:05



LTE Band 25 / 1.4MHz / 256QAM

Lowest Band Edge / 1 RB

Highest Band Edge / 1 RB

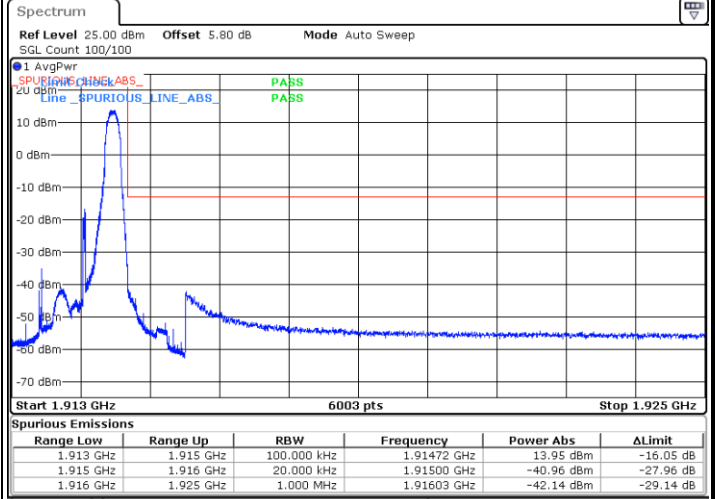
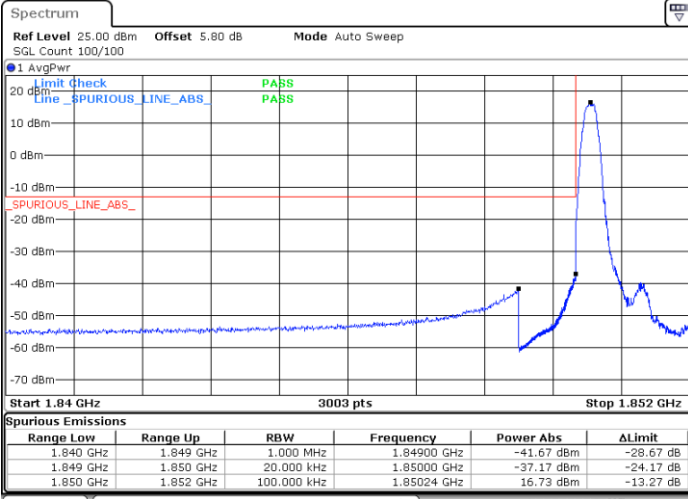

Date: 2.MAR.2023 10:22:08

Date: 2.MAR.2023 10:36:49

Lowest Band Edge / Full RB

Highest Band Edge / Full RB

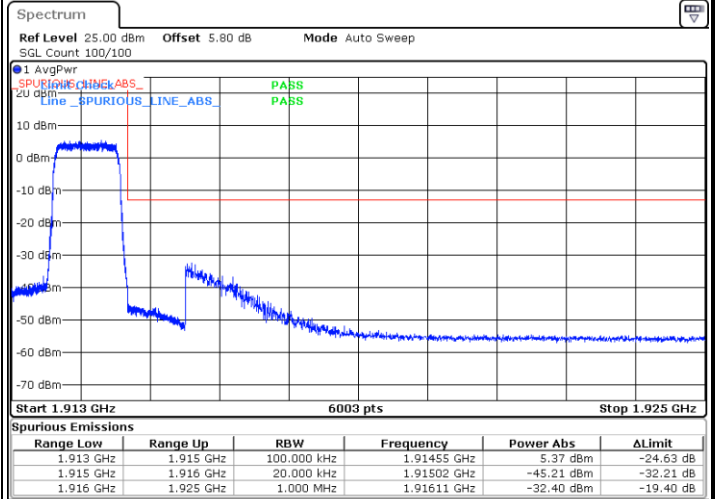
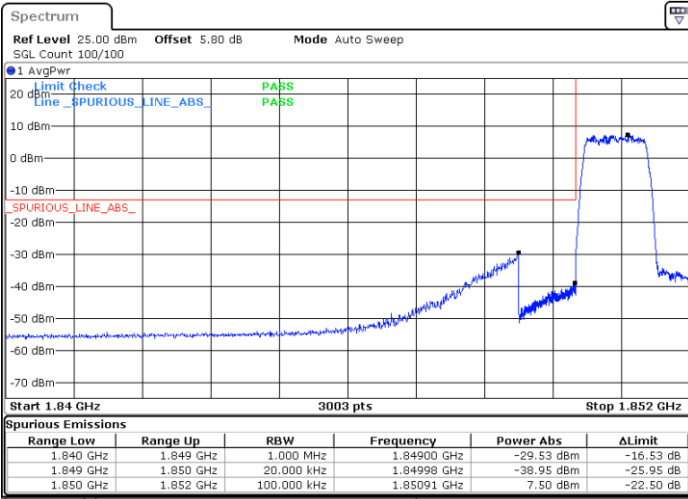

Date: 2.MAR.2023 10:27:47

Date: 2.MAR.2023 10:39:24



LTE Band 25 / 3MHz / QPSK

Lowest Band Edge / 1RB

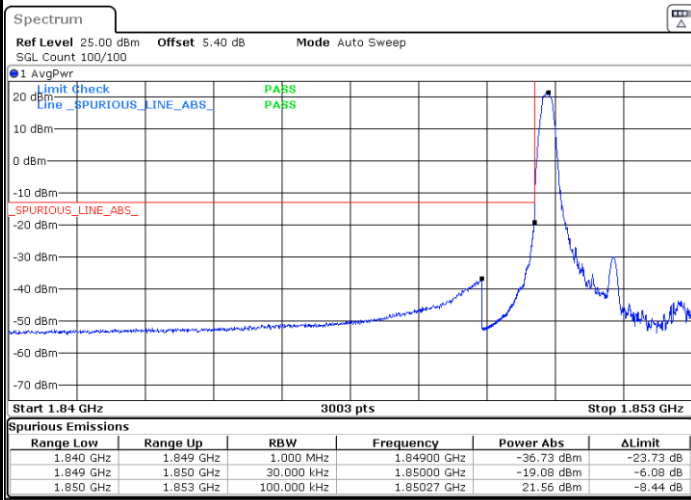

Date: 24.FEB.2023 18:22:27

Highest Band Edge / 1 RB

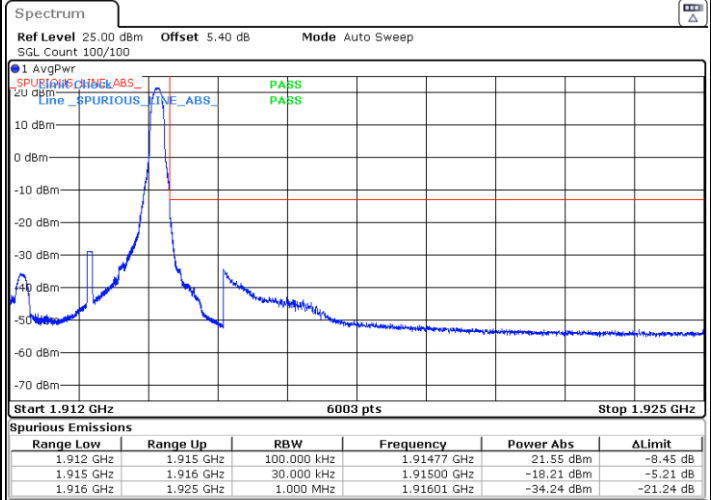

Date: 24.FEB.2023 18:29:39

Lowest Band Edge / Full RB

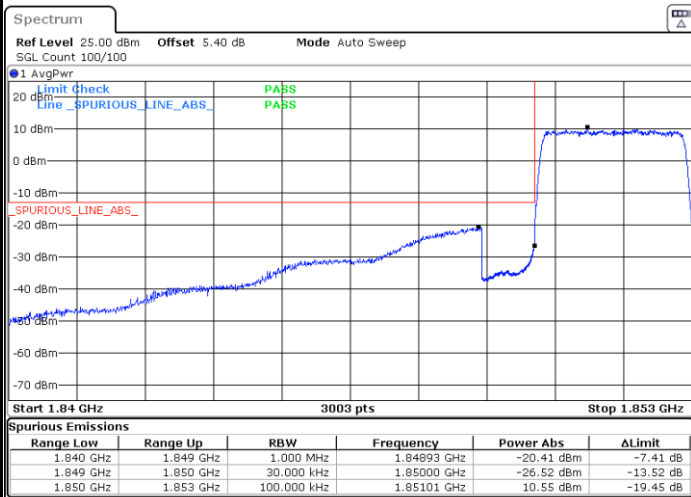

Date: 24.FEB.2023 18:16:36

Highest Band Edge / Full RB

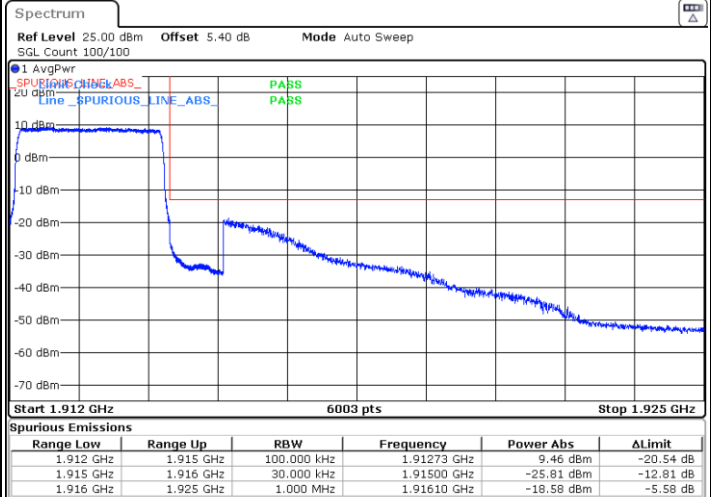

Date: 24.FEB.2023 18:04:14



LTE Band 25 / 3MHz / 16QAM

Lowest Band Edge / 1 RB

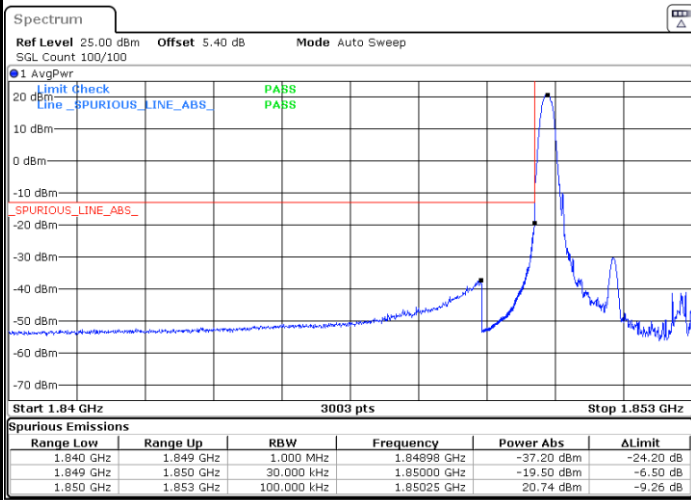

Date: 24.FEB.2023 18:23:58

Highest Band Edge / 1 RB

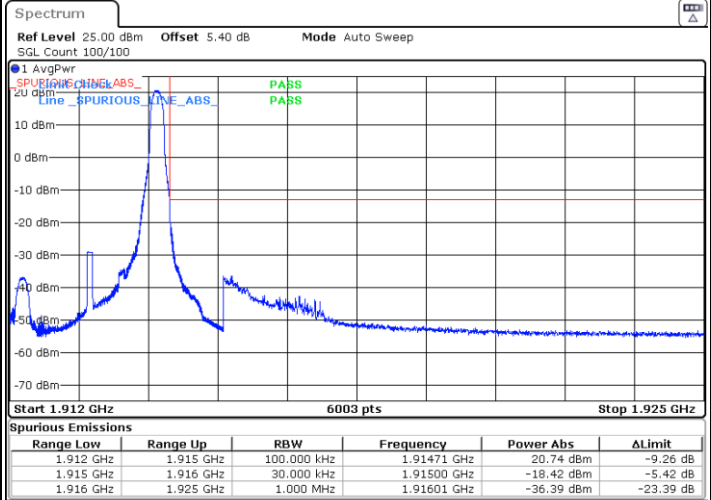

Date: 24.FEB.2023 18:31:10

Lowest Band Edge / Full RB

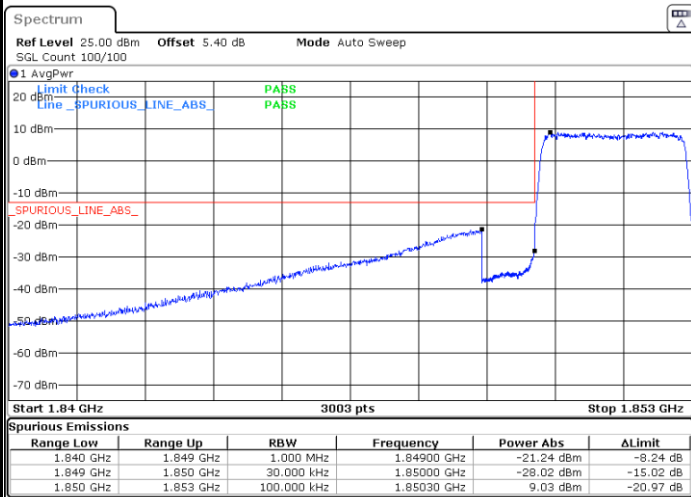

Date: 24.FEB.2023 18:18:06

Highest Band Edge / Full RB

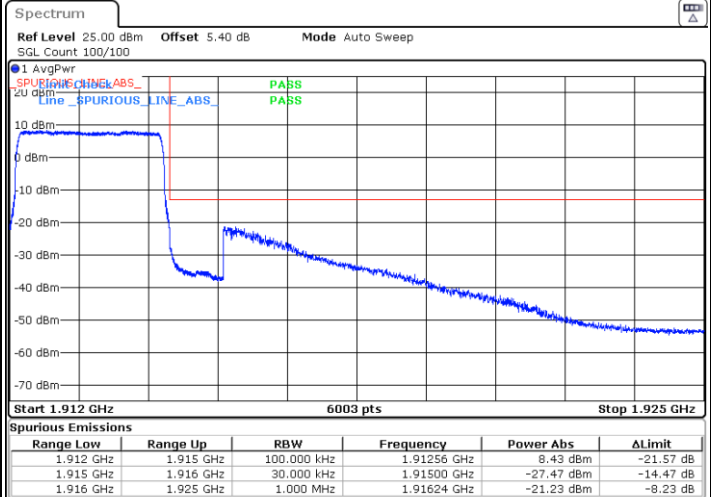

Date: 24.FEB.2023 18:05:14



LTE Band 25 / 3MHz / 64QAM

Lowest Band Edge / 1 RB

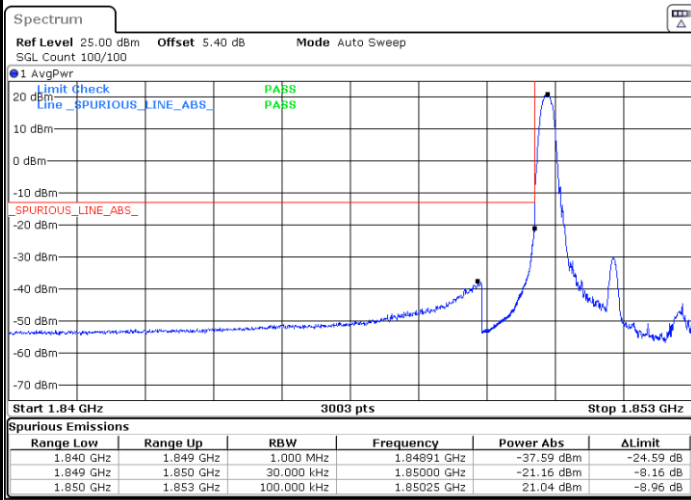

Date: 24.FEB.2023 18:25:28

Highest Band Edge / 1 RB

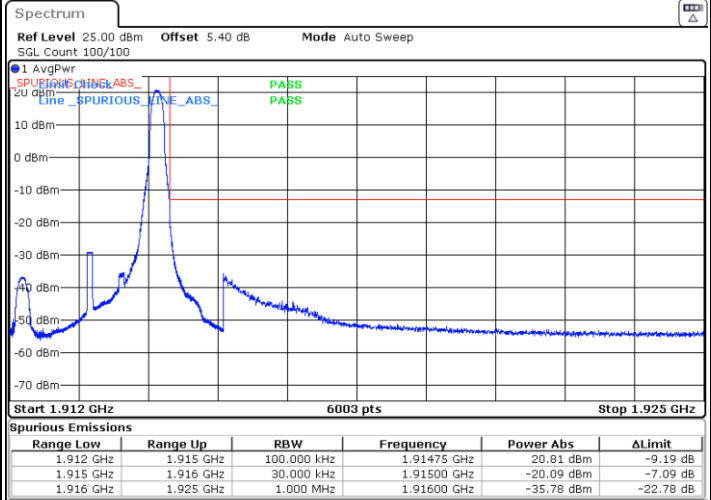

Date: 24.FEB.2023 18:32:40

Lowest Band Edge / Full RB

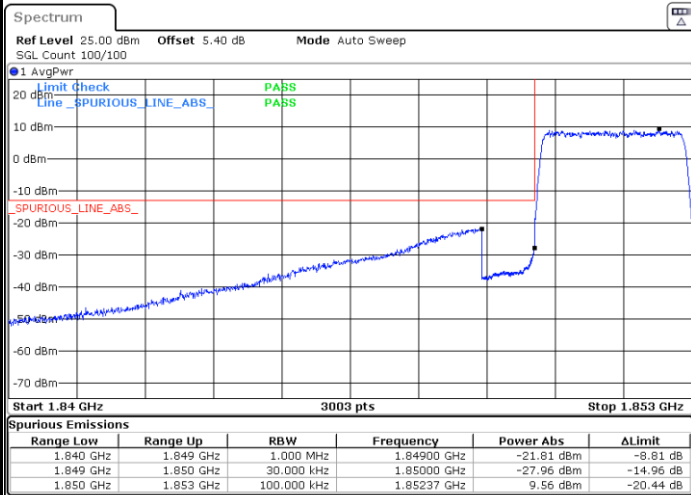

Date: 24.FEB.2023 18:19:36

Highest Band Edge / Full RB

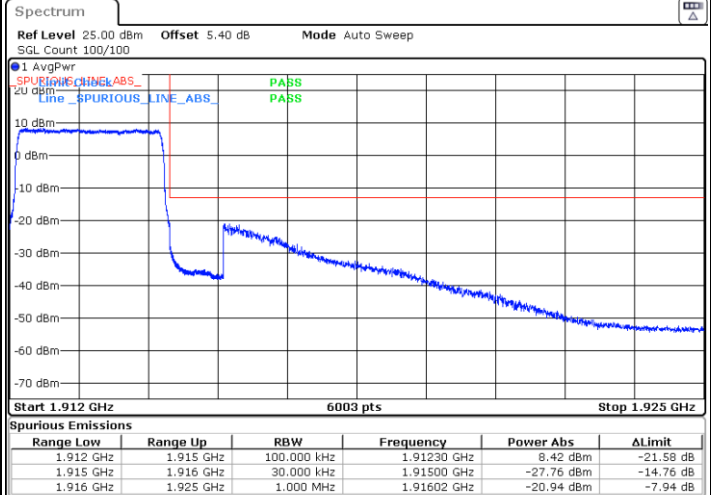

Date: 24.FEB.2023 18:36:14



LTE Band 25 / 3MHz / 256QAM

Lowest Band Edge / 1 RB

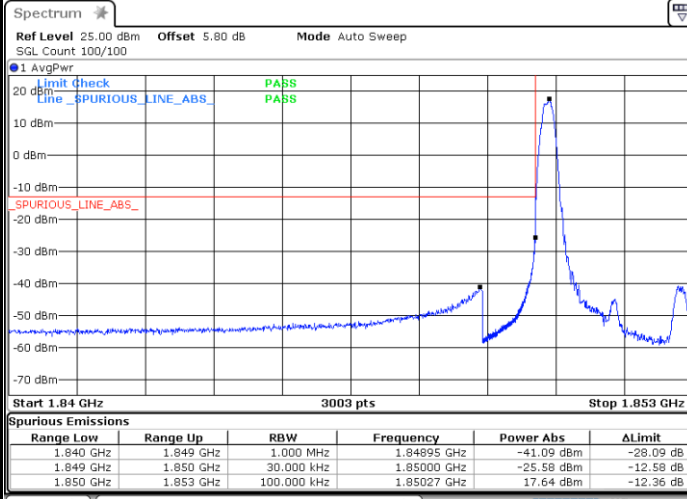

Date: 2.MAR.2023 12:09:37

Highest Band Edge / 1 RB

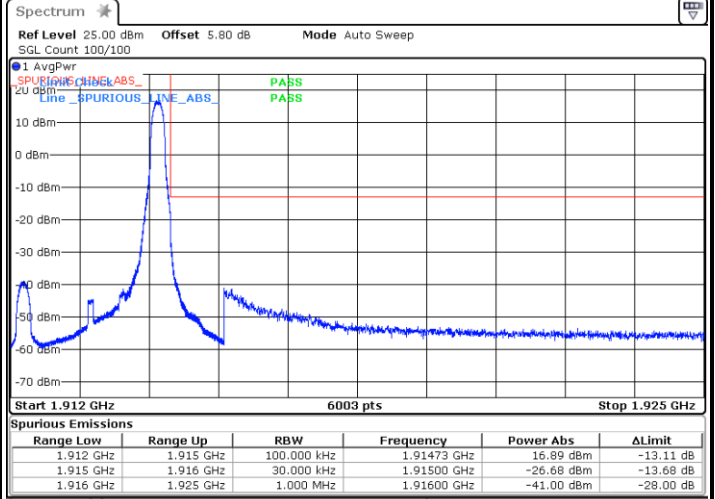

Date: 2.MAR.2023 12:14:46

Lowest Band Edge / Full RB

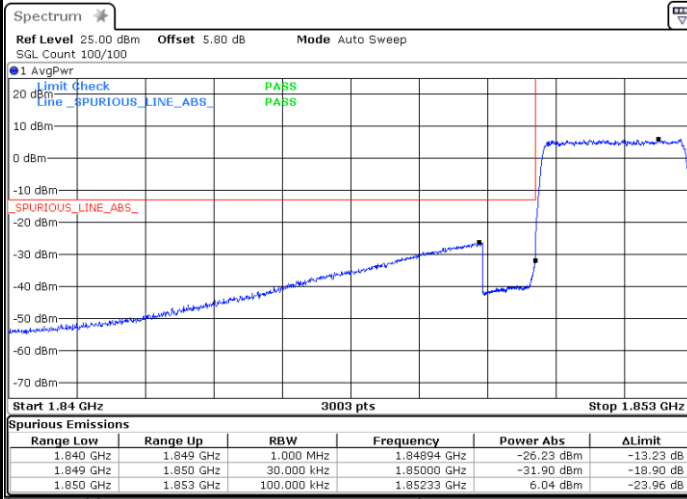

Date: 2.MAR.2023 12:11:18

Highest Band Edge / Full RB

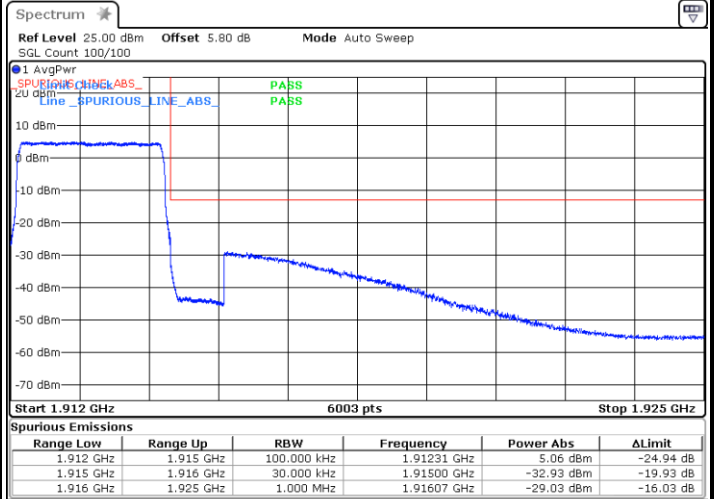

Date: 2.MAR.2023 12:19:38



LTE Band 25 / 5MHz / QPSK

Lowest Band Edge / 1 RB

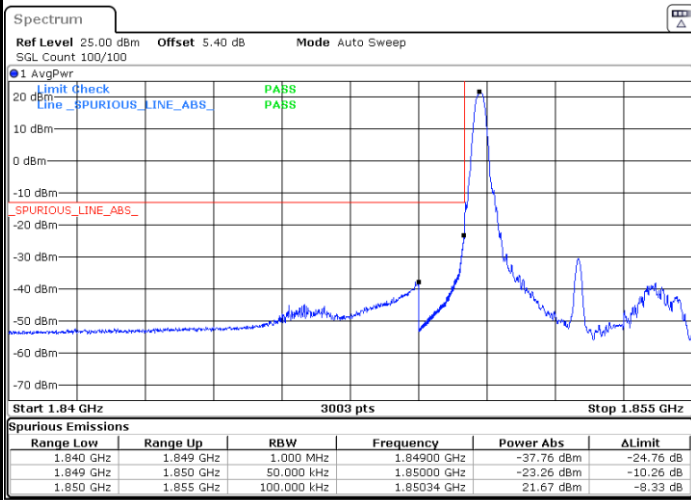

Date: 24.FEB.2023 18:46:52

Highest Band Edge / 1 RB

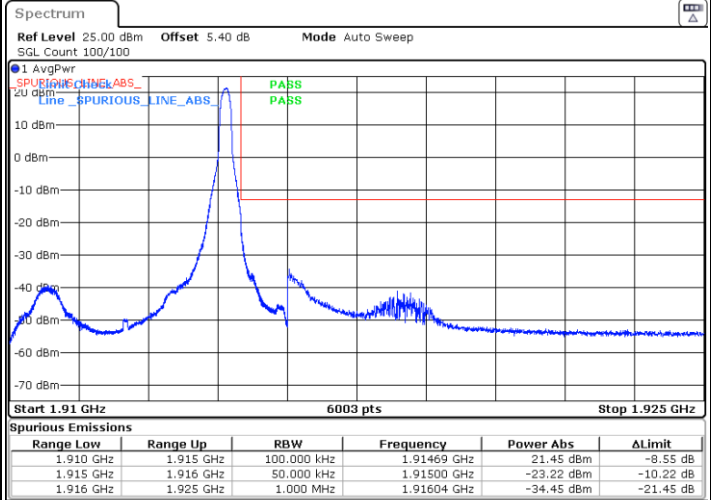

Date: 24.FEB.2023 18:57:37

Lowest Band Edge / Full RB

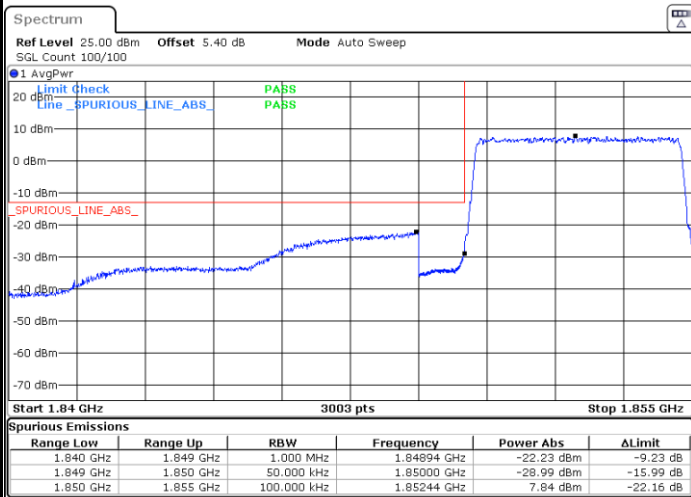

Date: 24.FEB.2023 18:41:30

Highest Band Edge / Full RB

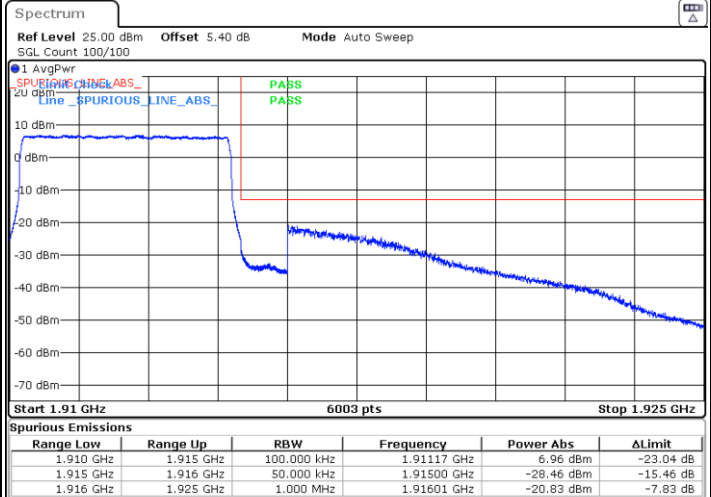

Date: 24.FEB.2023 18:53:35



LTE Band 25 / 5MHz / 16QAM

Lowest Band Edge / 1RB

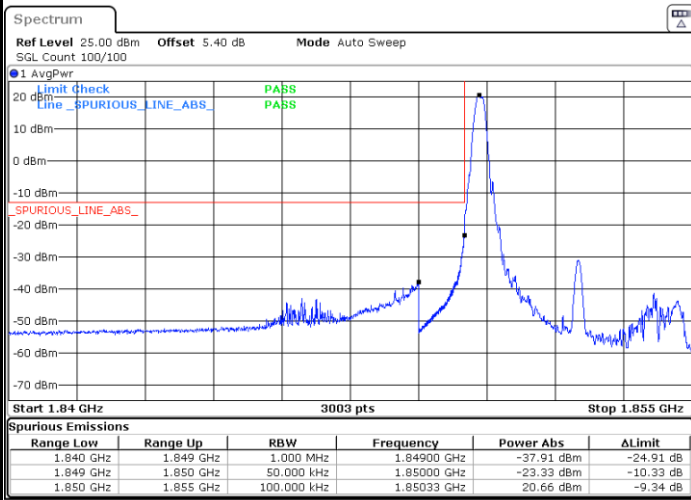

Date: 24.FEB.2023 18:48:12

Highest Band Edge / 1 RB

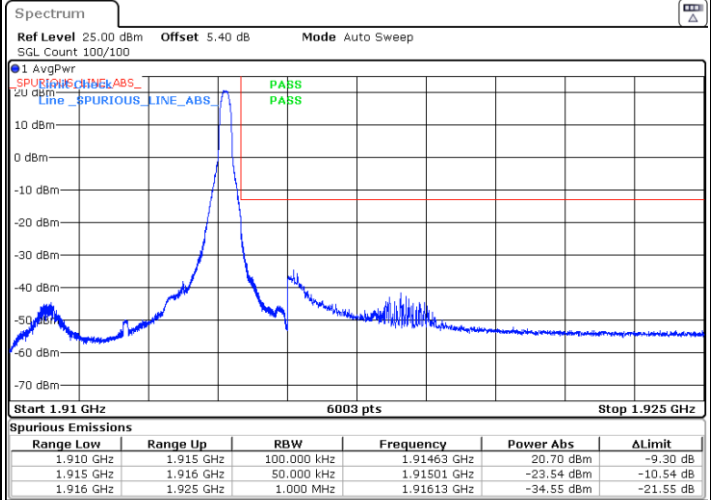

Date: 24.FEB.2023 18:58:58

Lowest Band Edge / Full RB

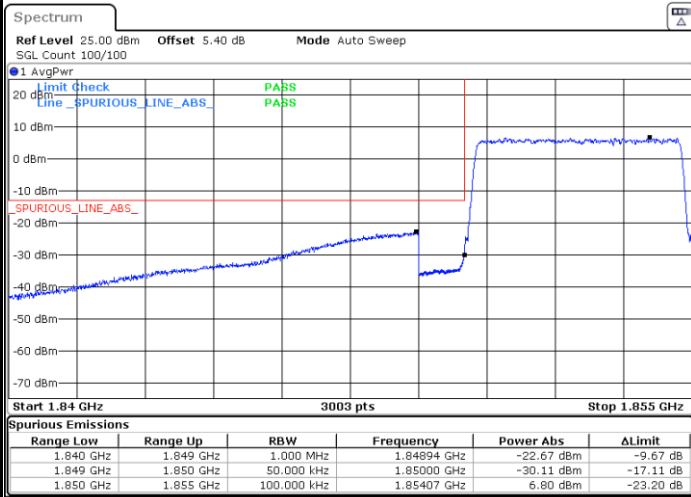

Date: 24.FEB.2023 18:42:50

Highest Band Edge / Full RB

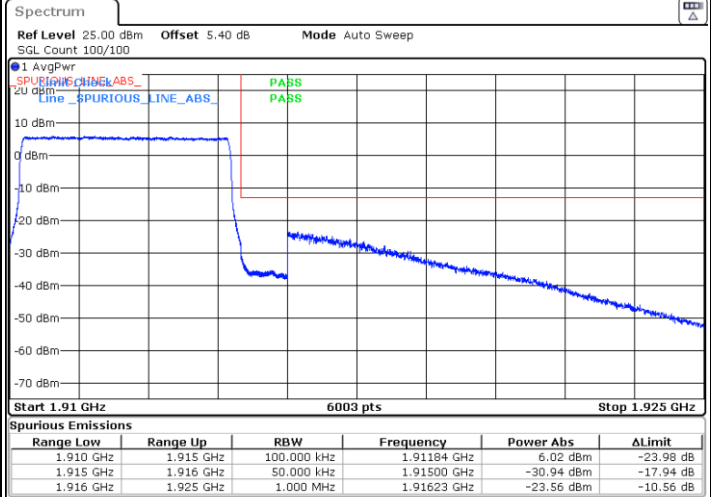

Date: 24.FEB.2023 18:54:56



LTE Band 25 / 5MHz / 64QAM

Lowest Band Edge / 1RB

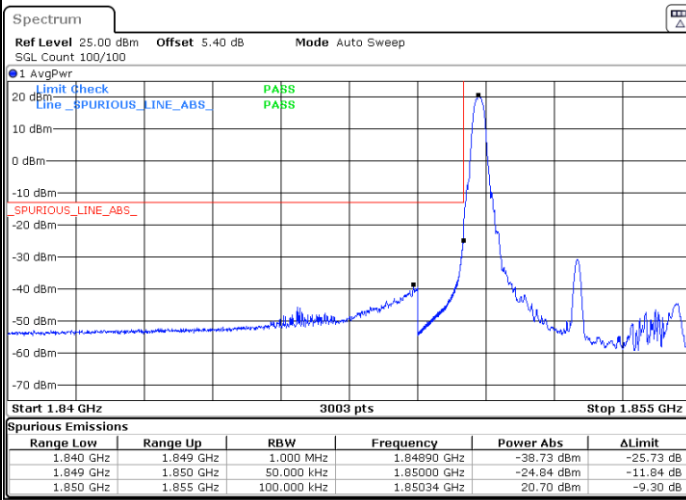

Date: 24.FEB.2023 18:49:33

Highest Band Edge / 1 RB

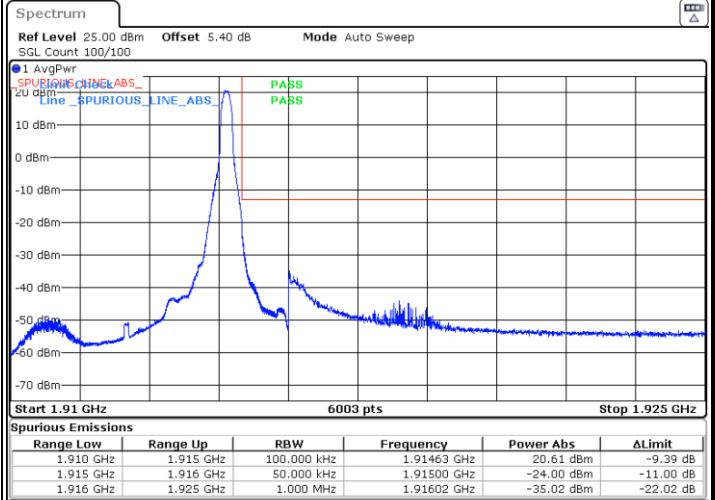

Date: 24.FEB.2023 19:00:18

Lowest Band Edge / Full RB

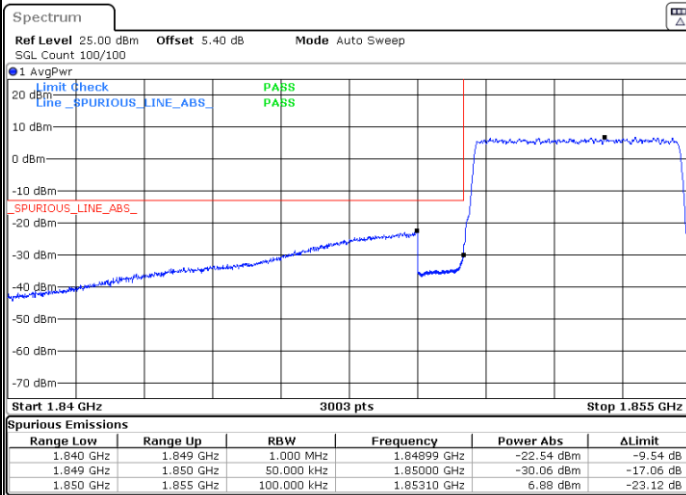

Date: 24.FEB.2023 18:44:11

Highest Band Edge / Full RB

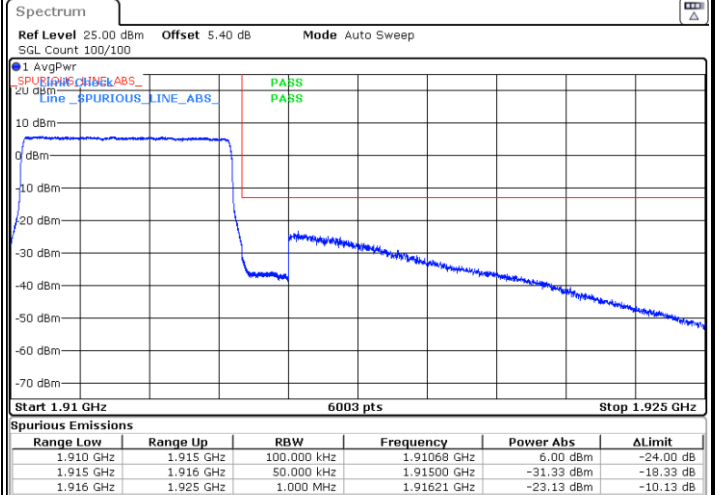

Date: 24.FEB.2023 18:56:16



LTE Band 25 / 5MHz / 256QAM

Lowest Band Edge / 1RB

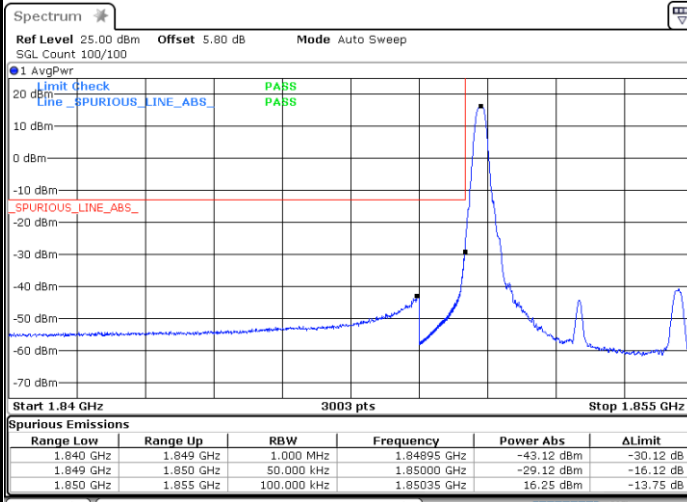

Date: 2.MAR.2023 12:21:35

Highest Band Edge / 1 RB

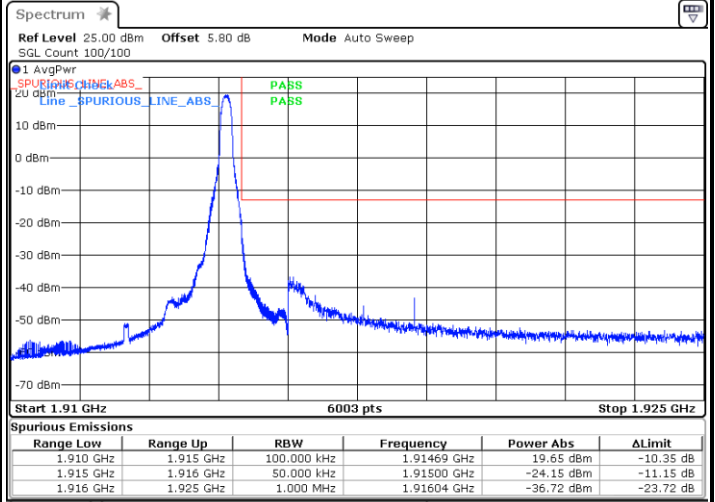

Date: 2.MAR.2023 12:24:58

Lowest Band Edge / Full RB

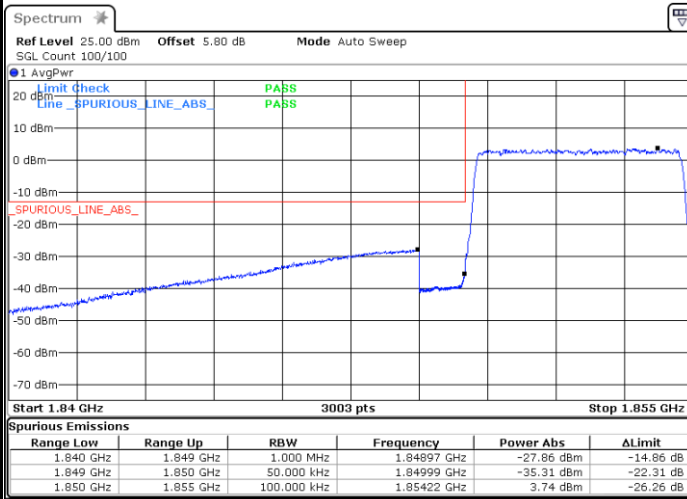

Date: 2.MAR.2023 12:23:16

Highest Band Edge / Full RB

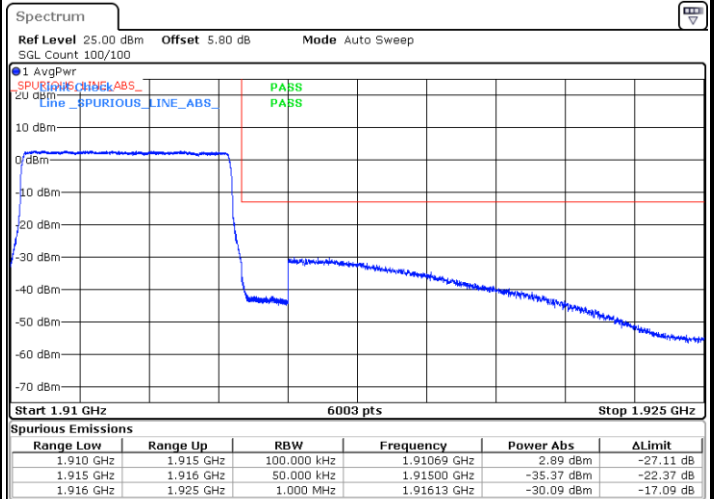

Date: 2.MAR.2023 12:26:40



LTE Band 25 / 10MHz / QPSK

Lowest Band Edge / 1 RB

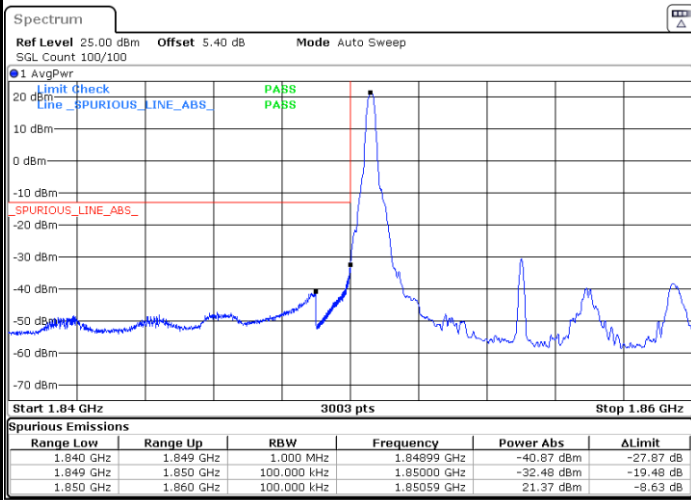

Date: 24.FEB.2023 19:05:42

Highest Band Edge / 1 RB

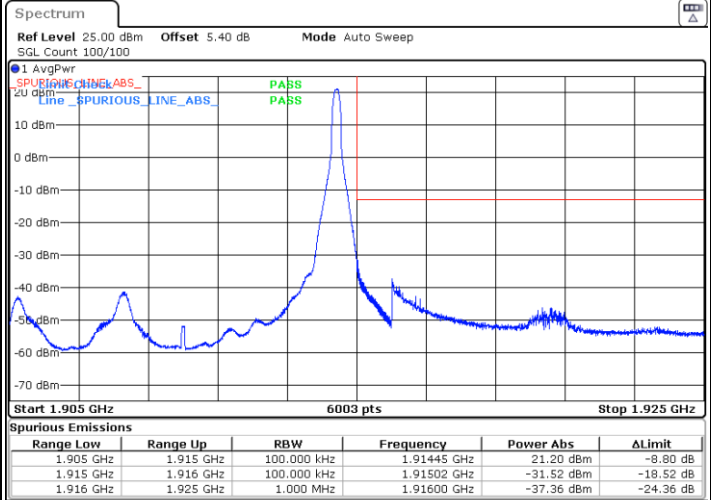

Date: 24.FEB.2023 19:17:47

Lowest Band Edge / Full RB

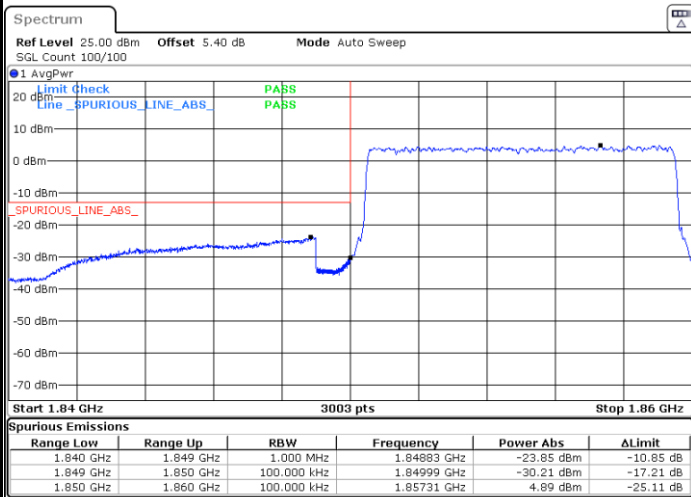

Date: 24.FEB.2023 19:01:39

Highest Band Edge / Full RB

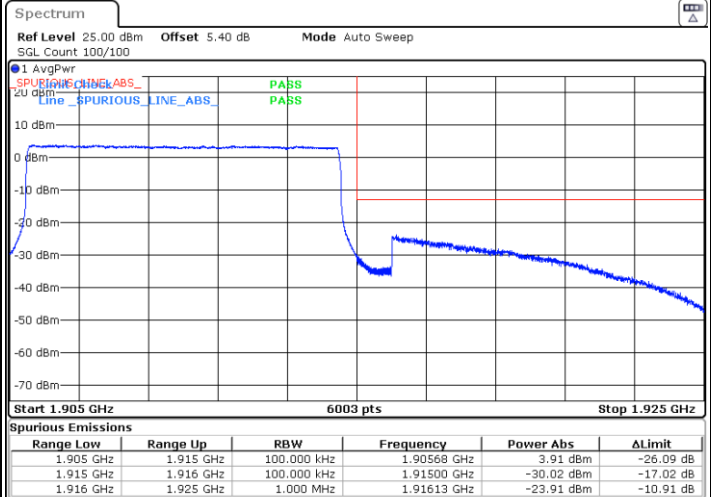

Date: 24.FEB.2023 19:13:45



LTE Band 25 / 10MHz / 16QAM

Lowest Band Edge / 1 RB

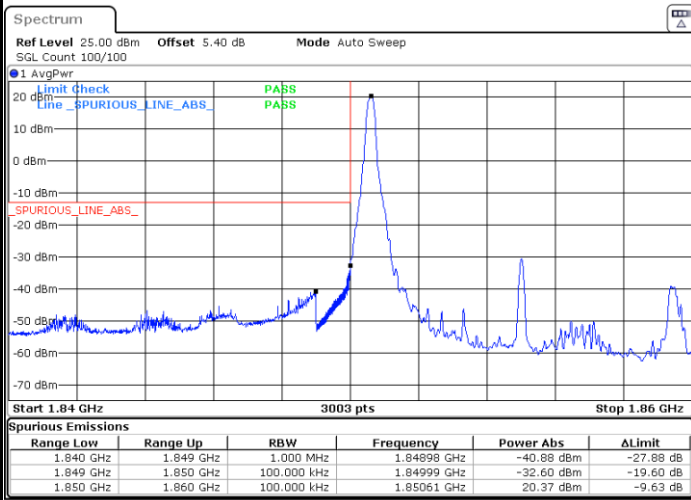

Date: 24.FEB.2023 19:08:23

Highest Band Edge / 1 RB

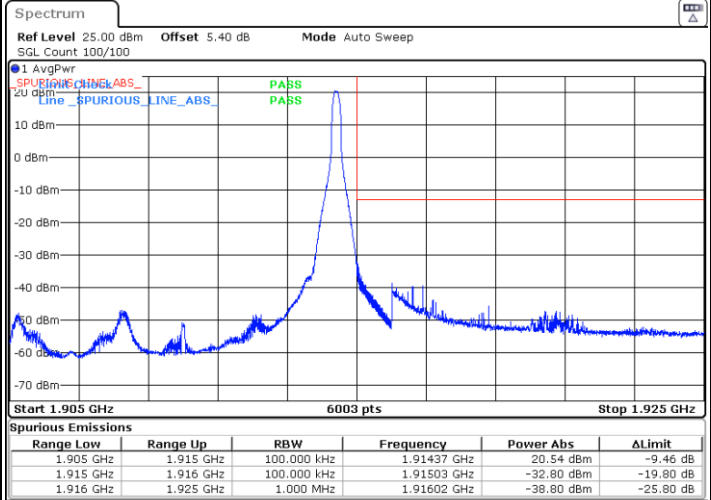

Date: 24.FEB.2023 19:19:07

Lowest Band Edge / Full RB

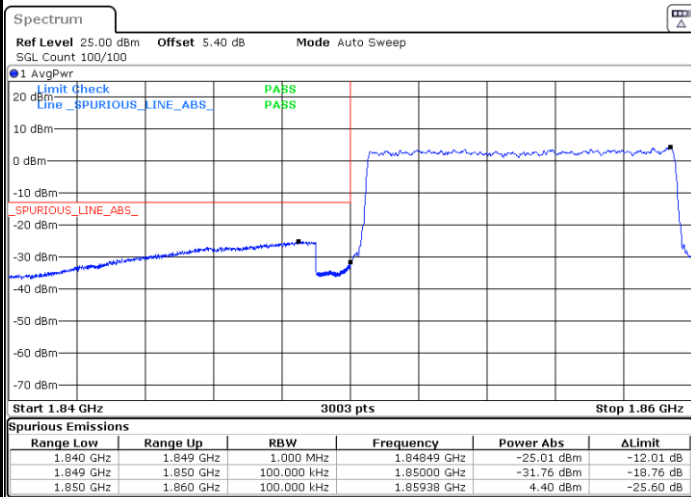

Date: 24.FEB.2023 19:03:01

Highest Band Edge / Full RB

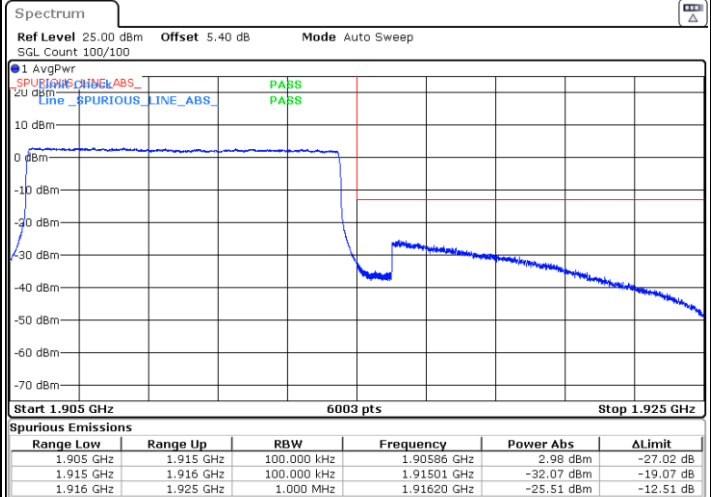

Date: 24.FEB.2023 19:15:06



LTE Band 25 / 10MHz / 64QAM

Lowest Band Edge / 1 RB

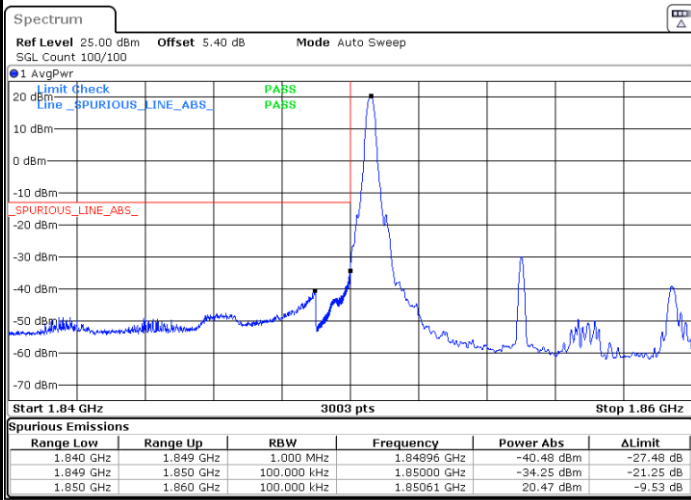

Date: 24.FEB.2023 19:09:43

Highest Band Edge / 1 RB

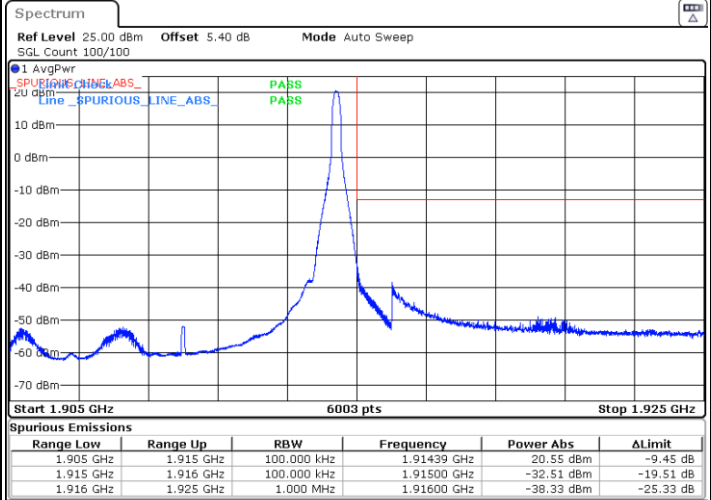

Date: 24.FEB.2023 19:20:28

Lowest Band Edge / Full RB

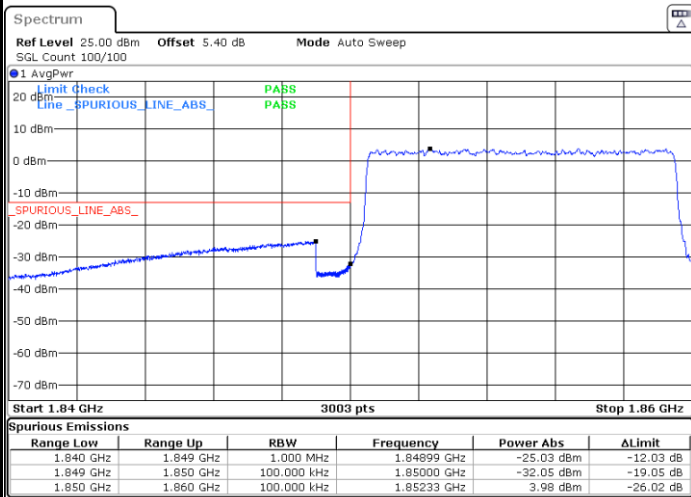

Date: 24.FEB.2023 19:04:21

Highest Band Edge / Full RB

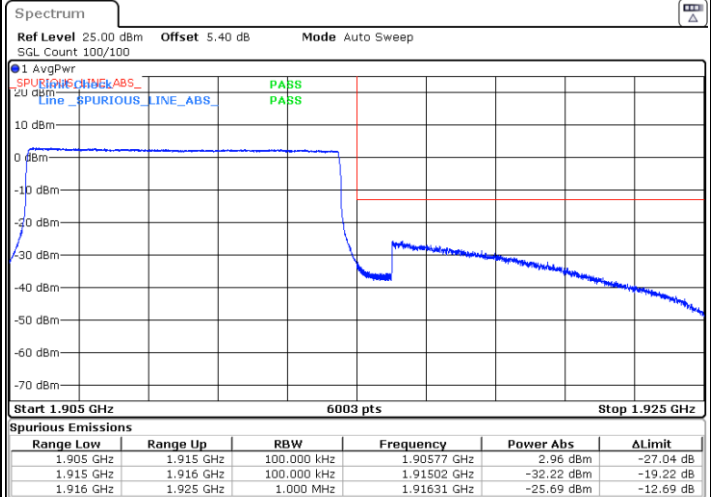

Date: 24.FEB.2023 19:16:26