



FCC RF Test Report

APPLICANT : Lenovo (Shanghai) Electronics Technology Co., Ltd.
EQUIPMENT : Portable Tablet Computer
BRAND NAME : Lenovo
MODEL NAME : TB360ZU
FCC ID : O57TB360ZU
STANDARD : 47 CFR Part 2, 96
CLASSIFICATION : Citizens Band End User Devices (CBE)
EQUIPMENT TYPE : End User Equipment
TEST DATE(S) : Mar. 16, 2023 ~ Apr. 12, 2023

We, Sporton International Inc. (Kunshan), would like to declare that the tested sample has been evaluated in accordance with the procedures given in ANSI C63.26 and shown compliance with the applicable technical standards.

The test results in this report apply exclusively to the tested model / sample. Without written approval of Sporton International Inc. (Kunshan), the test report shall not be reproduced except in full.

Jason Jia

Approved by: Jason Jia



Sporton International Inc. (Kunshan)

No. 1098, Pengxi North Road, Kunshan Economic Development Zone Jiangsu

Province 215300 People's Republic of China



Table of Contents

History of this test report..... 3

Summary of Test Result..... 4

1 General Description 5

 1.1 Applicant..... 5

 1.2 Manufacturer 5

 1.3 Feature of Equipment Under Test..... 5

 1.4 Maximum EIRP Power and Emission Designator 6

 1.5 Testing Site..... 6

 1.6 Test Software 7

 1.7 Applied Standards 7

2 Test Configuration of Equipment Under Test 8

 2.1 Test Mode..... 8

 2.2 Connection Diagram of Test System 9

 2.3 Support Unit used in test configuration 9

 2.4 Measurement Results Explanation Example 9

 2.5 Frequency List of Low/Middle/High Channels 10

3 Conducted Test Items..... 11

 3.1 Measuring Instruments..... 11

 3.2 Conducted Output Power 12

 3.3 EIRP 13

 3.4 Occupied Bandwidth 14

 3.5 Conducted Band Edge 15

 3.6 Conducted Spurious Emission 16

 3.7 Frequency Stability..... 17

4 Radiated Test Items 18

 4.1 Measuring Instruments..... 18

 4.2 Test Setup 18

 4.3 Test Result of Radiated Test..... 19

 4.4 Radiated Spurious Emission 20

5 List of Measuring Equipment..... 21

6 Uncertainty of Evaluation..... 22

Appendix A. Test Results of Conducted Test

Appendix B. Test Results of EIRP and Radiated Test

Appendix C. Test Setup Photographs



History of this test report

Report No.	Version	Description	Issued Date
FG311926J	01	Initial issue of report	Apr. 14, 2023



Summary of Test Result

Report Clause	Ref Std. Clause	Test Items	Result (PASS/FAIL)	Remark
3.2	§2.1046	Conducted Output Power	Reporting only	-
-	§96.41	Peak-to-Average Ratio	Not Applicable	Not applicable for End User Devices
3.3	§96.41	Maximum E.I.R.P	Pass	-
		Maximum Power Spectral Density	Not Applicable	Not applicable for End User Devices
3.4	§2.1049 §96.41	Occupied Bandwidth	Reporting only	-
3.5	§2.1051 §96.41	Conducted Band Edge Measurement Adjacent Channel Leakage Ratio	Pass	-
3.6	§2.1051 §96.41	Conducted Spurious Emission	Pass	
3.7	§2.1055	Frequency Stability for Temperature & Voltage	Pass	-
4.4	§2.1051 §96.41	Radiated Spurious Emission	Pass	Under limit 15.49 dB at 10728.000 MHz

Declaration of Conformity:
The test results with all measurement uncertainty excluded are presented in accordance with the regulation limits or requirements declared by manufacturers.
Comments and Explanations:
The declared of product specification for EUT presented in the report are provided by the manufacturer, and the manufacturer takes all the responsibilities for the accuracy of product specification.



1 General Description

1.1 Applicant

Lenovo (Shanghai) Electronics Technology Co., Ltd.

Section 304-305, Building No. 4, # 222, Meiyue Road, China (Shanghai) Pilot Free Trade Zone

1.2 Manufacturer

Lenovo PC HK Limited

23/F, Lincoln House, Taikoo Place 979 King's Road, Quarry Bay, Hong Kong, China

1.3 Feature of Equipment Under Test

Product Feature	
Equipment	Portable Tablet Computer
Brand Name	Lenovo
Model Name	TB360ZU
FCC ID	O57TB360ZU
Tx/Rx Frequency	5G NR n77/n78: 3550 MHz ~ 3700 MHz
Bandwidth	n77/n78: 20MHz / 30MHz / 40MHz / 50MHz / 60MHz / 70MHz / 80MHz / 90MHz / 100MHz
Antenna Type	PIFA Antenna
Antenna Gain	<p><Ant. 3>: n77: 0.32 dBi n78: 0.32 dBi</p> <p><Ant. 4>: n77: 0.09 dBi n78: 0.09 dBi</p> <p><Ant. 7>: n77: 0.13 dBi n78: 0.13 dBi</p> <p><Ant. 11>: n77: -2.11 dBi n78: -2.11 dBi</p>
Type of Modulation	DFT-s-OFDM (PI/2 BPSK / QPSK / 16QAM / 64QAM / 256QAM) CP-OFDM (QPSK / 16QAM / 64QAM / 256QAM)
IMEI Code	Conducted: 869864060008140 Radiation: 869864060010336
HW Version	TB360ZU
SW Version	TB360ZU_RF01_230312
EUT Stage	Identical Prototype

Remark:

1. The device supports power class 3 only for 5G NR n77/n78(3550 MHz ~ 3700 MHz).
2. The device supports n77/n78(1T4R) SRS resources on Ant.3/4/7/11, only the worst test data of Antenna 3 is showed in the report.
3. 5G NR support SA (n77/n78) mode and NSA(n78) mode. According to the maximum power between SA and NSA mode, SA covers NSA mode for conducted test items.

4. The EN-DC mode combination could be referred to the product spec.

1.4 Maximum EIRP Power and Emission Designator

5G NR n77		PI/2 BPSK / QPSK		16QAM / 64QAM / 256QAM	
BW (MHz)	Frequency Range (MHz)	Maximum EIRP(W)	Emission Designator (99%OBW)	Maximum EIRP(W)	Emission Designator (99%OBW)
100	3600.00 ~ 3649.98	0.0904	97M5G7D	0.0849	97M7W7D

5G NR n78		PI/2 BPSK / QPSK		16QAM / 64QAM / 256QAM	
BW (MHz)	Frequency Range (MHz)	Maximum EIRP(W)	Emission Designator (99%OBW)	Maximum EIRP(W)	Emission Designator (99%OBW)
100	3600.00 ~ 3649.98	0.0944	97M5G7D	0.0899	97M7W7D

Note:

1. According to the maximum power between 5G NR n77 and 5G NR n78, 5G NR n78 covers 5G NR n77 mode for conducted test items.
2. All modulations have been tested, and only the worst test results of PSK & QAM are shown in the report.

1.5 Testing Site

Sporton International Inc. (Kunshan) is accredited to ISO/IEC 17025:2017 by American Association for Laboratory Accreditation with Certificate Number 5145.02.

Test Firm	Sporton International Inc. (Kunshan)		
Test Site Location	No. 1098, Pengxi North Road, Kunshan Economic Development Zone Jiangsu Province 215300 People’s Republic of China TEL : +86-512-57900158 FAX : +86-512-57900958		
Test Site No.	Sporton Site No.	FCC Designation No.	FCC Test Firm Registration No.
	03CH04-KS TH01-KS	CN1257	314309



1.6 Test Software

Item	Site	Manufacturer	Name	Version
1.	03CH04-KS	AUDIX	E3	6.2009-8-24al

1.7 Applied Standards

According to the specifications of the manufacturer, the EUT must comply with the requirements of the following standards:

- ♦ ANSI C63.26-2015
- ♦ 47 CFR Part 2, 96
- ♦ FCC KDB 971168 D01 Power Meas. License Digital Systems v03r01
- ♦ FCC KDB 940660 D01 Part 96 CBRS v03
- ♦ FCC KDB 412172 D01 Determining ERP and EIRP v01r01

Remark:

1. All test items were verified and recorded according to the standards and without any deviation during the test.
2. This EUT has also been tested and complied with the requirements of FCC Part 15, Subpart B, recorded in a separate test report.



2 Test Configuration of Equipment Under Test

2.1 Test Mode

Antenna port conducted and radiated test items listed below are performed according to KDB 971168 D01 Power Meas. License Digital Systems v03r01 with maximum output power.

For radiated measurement, pre-scanned in three orthogonal panels, X, Y, Z. The worst cases (Y plane) were recorded in this report.

Test Items	5G NR	Bandwidth (MHz)									Modulation					RB #		Test Channel			
		20	30	40	50	60	70	80	90	100	PI/2 BPSK	QPSK	16QAM	64QAM	256 QAM	1	Full	L	M	H	
Max. Output Power	n77	v	v	v	v	v	v	v	v	v	v	v	v	v	v	v	v	v	v	v	
	n78	v	v	v	v	v	v	v	v	v	v	v	v	v	v	v	v	v	v	v	
26dB and 99% Bandwidth	n78	v	v	v	v	v	v	v	v	v	v	v	v	v	v		v		v		
Conducted Band Edge	n78	v				v				v	v	v				v	v	v		v	
Conducted Spurious Emission	n78	v				v				v	v	v				v		v	v	v	
Frequency Stability	n78	v										v					v		v		
E.I.R.P	n77	v	v	v	v	v	v	v	v	v	v	v	v	v	v	v	v	v	v	v	
	n78	v	v	v	v	v	v	v	v	v	v	v	v	v	v	v	v	v	v	v	
Radiated Spurious Emission	n77	Worst Case																		v	
	n78	Worst Case																		v	
Note	1. The mark "v" means that this configuration is chosen for testing 2. The mark "-" means that this bandwidth is not supported. 3. The device is investigated from 30MHz to 10 times of fundamental signal for radiated spurious emission test under different RB size/offset and modulations in exploratory test. Subsequently, only the worst case emissions are reported. 4. Based on engineering evaluation, only the worst modulations test results are shown in the report. 5. Frequency Stability : Normal Voltage = 3.86V ; Low Voltage =3.60V. ; High Voltage =4.43V																				

2.2 Connection Diagram of Test System

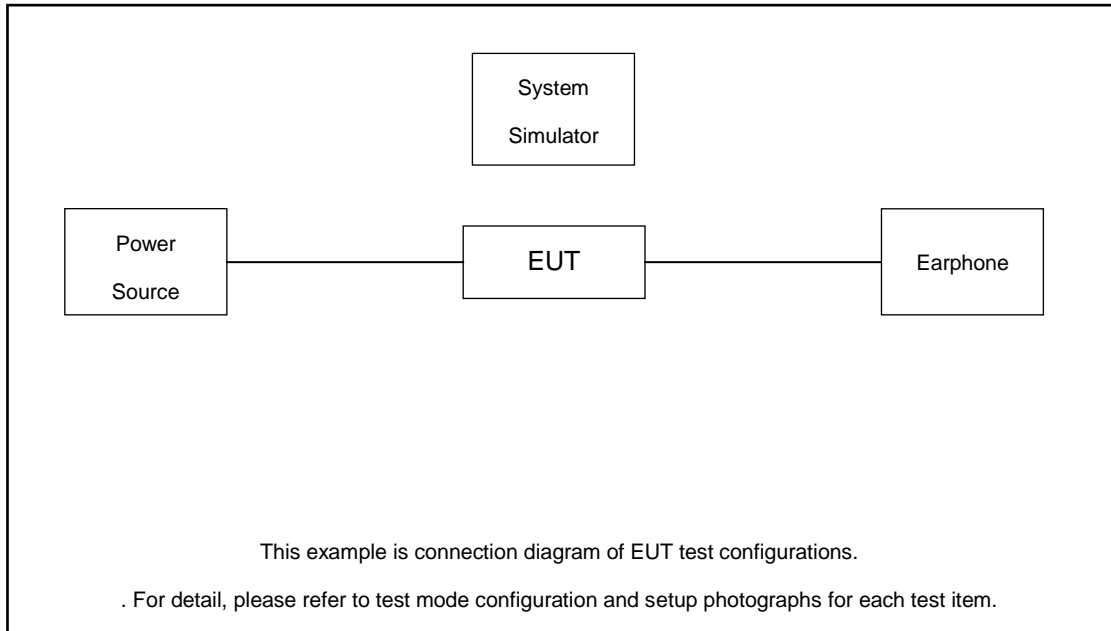

2.3 Support Unit used in test configuration

Item	Equipment	Trade Name	Model No.	FCC ID	Data Cable	Power Cord
1.	Power Supply	GWINSTEK	PSS-2002	N/A	N/A	Unshielded, 1.8 m
2.	LTE Base Station	Anritsu	MT8821C	N/A	N/A	Unshielded, 1.8 m
3.	NR Base Station	Anritsu	MT8000A	N/A	N/A	Unshielded, 1.8 m
4.	Earphone	N/A	N/A	N/A	N/A	N/A

2.4 Measurement Results Explanation Example

For all conducted test items:

The offset level is set in the spectrum analyzer to compensate the RF cable loss between EUT conducted output port and spectrum analyzer. With the offset compensation, the spectrum analyzer reading level is exactly the EUT RF output level.

The spectrum analyzer offset is derived from RF cable loss.

Offset = RF cable loss.

Following shows an offset computation example with cable loss 6.5 dB.

Example :

$$\begin{aligned} \text{Offset(dB)} &= \text{RF cable loss(dB)}. \\ &= 6.5 \text{ (dB)} \end{aligned}$$



2.5 Frequency List of Low/Middle/High Channels

5G n77/n78 Channel and Frequency List				
BW [MHz]	Channel/Frequency(MHz)	Lowest	Middle	Highest
100	Channel	640000	641666	643332
	Frequency	3600	3624.99	3649.98
90	Channel	639668	641666	643666
	Frequency	3595.02	3624.99	3654.99
80	Channel	639334	641666	644000
	Frequency	3590.01	3624.99	3660
70	Channel	639000	641666	644332
	Frequency	3585	3624.99	3664.98
60	Channel	638668	641666	644666
	Frequency	3580.02	3624.99	3669.99
50	Channel	638334	641666	645000
	Frequency	3575.01	3624.99	3675
40	Channel	638000	641666	645332
	Frequency	3570	3624.99	3679.98
30	Channel	637668	641666	645666
	Frequency	3565.02	3624.99	3684.99
20	Channel	637334	641666	646000
	Frequency	3560.01	3624.99	3690

3 Conducted Test Items

3.1 Measuring Instruments

See list of measuring instruments of this test report.

3.1.1 Test Setup

3.1.2 Conducted Output Power



3.1.3 EIRP, Occupied Bandwidth, Conducted Band-Edge and Conducted Spurious Emission

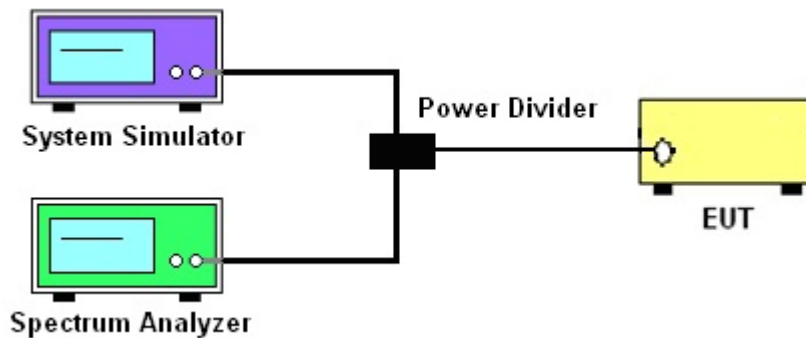

3.1.4 Frequency Stability

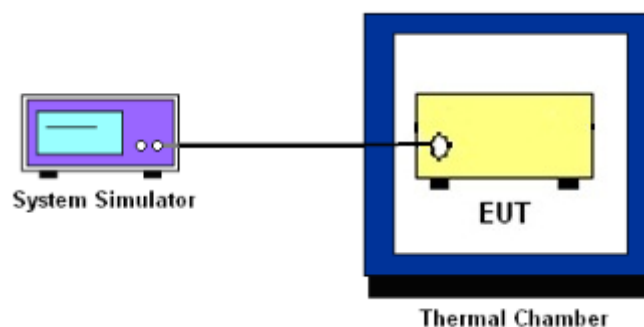

3.1.5 Test Result of Conducted Test

Please refer to Appendix A.



3.2 Conducted Output Power

3.2.1 Description of the Conducted Output Power Measurement

A system simulator was used to establish communication with the EUT. Its parameters were set to force the EUT transmitting at maximum output power. The measured power in the radio frequency on the transmitter output terminals shall be reported.

3.2.2 Test Procedures

1. The transmitter output port was connected to the system simulator.
2. Set EUT at maximum power through the system simulator.
3. Select lowest, middle, and highest channels for each band and different modulation.
4. Measure and record the power level from the system simulator.

3.3 EIRP

3.3.1 Description of the EIRP Measurement

EIRP limits for CBRS equipment as below table:

Device		Maximum EIRP (dBm/10 MHz)	Maximum PSD (dBm/MHz)
Applied	End User Device	23	n/a
<input type="checkbox"/>	Category A CBSD	30	20
<input type="checkbox"/>	Category B CBSD	47	37

Remark: The worst case EIRP shown in this section is found with LTE operating only using 1RB. As such, the EIRP/10MHz and full channel EIRP values will be identical since 1RB is fully contained within all available channel bandwidths for LTE Band 48 (i.e. 5, 10, 15, 20MHz)

3.3.2 Test Procedures for EIRP

1. Establishing a communications link with the call box (Base station) to measure the Maximum conducted power, the parameters were set to force the EUT transmitting at maximum output power level. Use the average power measurement function to measure total channel power of each channel bandwidth (per ANSI C63.26-2015 Section 5.2.1)
2. Determining ERP and/or EIRP from conducted RF output power measurements (Per ANSI C63.26-2015 Section 5.2.5.5)
 - EIRP = $P_T + G_T - L_C$, ERP = EIRP - 2.15, where
 - P_T = transmitter output power in dBm
 - G_T = gain of the transmitting antenna in dBi
 - L_C = signal attenuation in the connecting cable between the transmitter and antenna in dB



3.4 Occupied Bandwidth

3.4.1 Description of Occupied Bandwidth Measurement

The occupied bandwidth is the width of a frequency band such that, below the lower and above the upper frequency limits, the mean powers emitted are each equal to a specified percentage 0.5% of the total mean transmitted power.

The 26 dB emission bandwidth is defined as the frequency range between two points, one above and one below the carrier frequency, at which the spectral density of the emission is attenuated 26 dB below the maximum in-band spectral density of the modulated signal. Spectral density (power per unit bandwidth) is to be measured with a detector of resolution bandwidth equal to approximately 1.0% of the emission bandwidth.

3.4.2 Test Procedures

The testing follows ANSI C63.26-2015 Section 5.4.3 (26dB) and Section 5.4.4 (99OB)

1. The EUT was connected to spectrum analyzer and system simulator via a power divider.
2. The spectrum analyzer center frequency is set to the nominal EUT channel center frequency. The span range for the spectrum analyzer shall be between two and five times the anticipated OBW.
3. The nominal resolution bandwidth (RBW) shall be in the range of 1 to 5 % of the anticipated OBW, and the VBW shall be at least 3 times the RBW.
4. Set the detection mode to peak, and the trace mode to max hold.
5. Determine the reference value: Set the EUT to transmit a modulated signal. Allow the trace to stabilize. Set the spectrum analyzer marker to the highest level of the displayed trace.
(this is the reference value)
6. Determine the “-26 dB down amplitude” as equal to (Reference Value – X).
7. Place two markers, one at the lowest and the other at the highest frequency of the envelope of the spectral display such that each marker is at or slightly below the “-X dB down amplitude” determined in step 6. If a marker is below this “-X dB down amplitude” value it shall be placed as close as possible to this value. The OBW is the positive frequency difference between the two markers.
8. Use the 99 % power bandwidth function of the spectrum analyzer and report the measured bandwidth.

3.5 Conducted Band Edge

3.5.1 Description of Conducted Band Edge Measurement

Part 96.41 (e) (1) (ii)

For End User Devices the emission limits outside the fundamental are as follows:

Within 0 MHz to B MHz above and below the assigned channel ≤ -13 dBm/MHz

Greater than B MHz above and below the assigned channel ≤ -25 dBm/MHz

where B is the bandwidth in megahertz of the assigned channel or multiple contiguous channels of the End User Device.

Notwithstanding the emission limits in this paragraph, the Adjacent Channel Leakage Ratio for End User Devices shall be at least 30 dB.

Part 96.41 (e) (2)

For CBSDs and End User Devices, the conducted power of emissions below 3540 MHz or above 3710 MHz shall not exceed -25 dBm/MHz, and the conducted power of emissions below 3530 MHz or above 3720 MHz shall not exceed -40 dBm/MHz

3.5.2 Test Procedures

The testing follows FCC KDB 971168 D01 v03r01 Section 6.1.

1. The EUT was connected to spectrum analyzer and system simulator via a power divider.
2. The band edges of low and high channels for the highest RF powers were measured.
3. Set RBW $\geq 1\%$ EBW in the 1MHz band immediately outside and adjacent to the band edge.
4. Beyond the 1 MHz band from the band edge, RBW=1MHz was used
5. Offset has included the duty factor for LTE Band 48. Duty factor $=10 \log (1/x)$, where x is the measured duty cycle.
6. Set spectrum analyzer with RMS detector.
7. The RF fundamental frequency should be excluded against the limit line in the operating frequency band.
8. When using the integration method, the starting frequency of the integration shall be centered at one-half of the RBW away from the band edge.



3.6 Conducted Spurious Emission

3.6.1 Description of Conducted Spurious Emission Measurement

96.41 (e)(2)

The conducted power of any emissions below 3530 MHz or above 3720 MHz shall not exceed -40dBm/MHz.

3.6.2 Test Procedures

The testing follows FCC KDB 971168 D01 v03r01 Section 6.1.

1. The EUT was connected to spectrum analyzer and system simulator via a power divider.
2. The RF output of EUT was connected to the spectrum analyzer by RF cable and attenuator. The path loss was compensated to the results for each measurement.
3. The middle channel for the highest RF power within the transmitting frequency was measured.
4. The conducted spurious emission for the whole frequency range was taken.
5. Make the measurement with the spectrum analyzer's RBW = 1MHz, VBW = 3MHz.
6. Set spectrum analyzer with RMS detector.
7. Taking the record of maximum spurious emission.
8. The RF fundamental frequency should be excluded against the limit line in the operating frequency band.
9. The limit line is -40dBm/MHz.

3.7 Frequency Stability

3.7.1 Description of Frequency Stability Measurement

The frequency stability shall be measured by variation of ambient temperature and variation of primary supply voltage to ensure that the fundamental emission stays within the authorized frequency block. The frequency stability of the transmitter shall be maintained within $\pm 0.00025\%$ ($\pm 2.5\text{ppm}$) of the center frequency

3.7.2 Test Procedures for Temperature Variation

The testing follows FCC KDB 971168 D01 v03r01 Section 9.0.

1. The EUT was set up in the thermal chamber and connected with the system simulator.
2. With power OFF, the temperature was decreased to -10°C and the EUT was stabilized before testing. Power was applied and the maximum change in frequency was recorded within one minute.
3. With power OFF, the temperature was raised in 10°C step up to 50°C . The EUT was stabilized at each step for at least half an hour. Power was applied and the maximum frequency change was recorded within one minute.

3.7.3 Test Procedures for Voltage Variation

The testing follows FCC KDB 971168 D01 v03r01 Section 9.0.

1. The EUT was placed in a temperature chamber at $25\pm 5^{\circ}\text{C}$ and connected with the system simulator.
2. The power supply voltage to the EUT was varied from 85% to 115% of the nominal value measured at the input to the EUT.
3. The variation in frequency was measured for the worst case.

4 Radiated Test Items

4.1 Measuring Instruments

See list of measuring instruments of this test report.

4.2 Test Setup

4.2.1 For radiated test below 30MHz

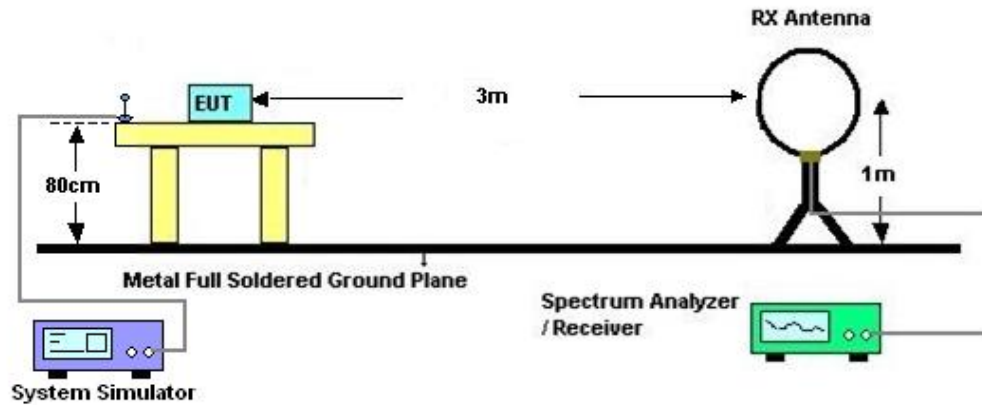

4.2.2 For radiated test from 30MHz to 1GHz

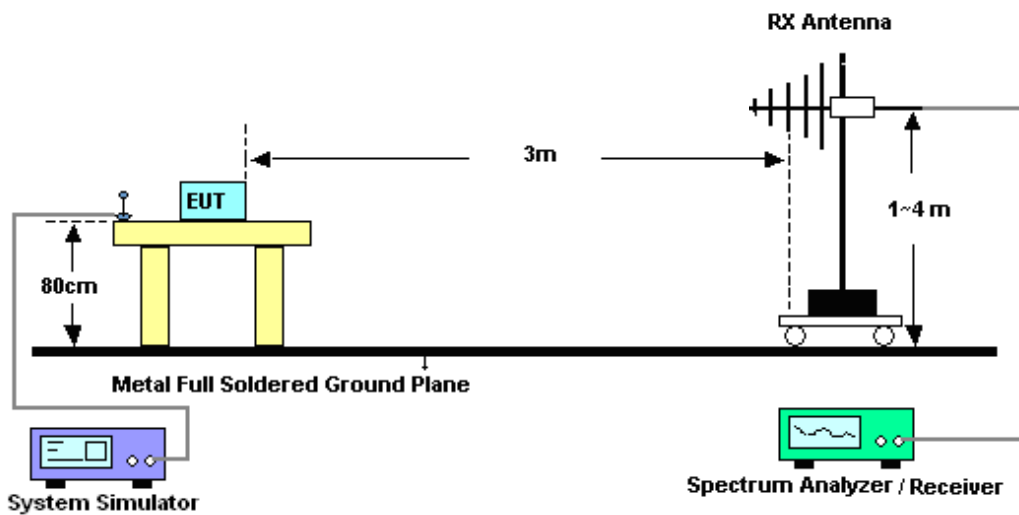

4.2.3 For radiated test above 1GHz

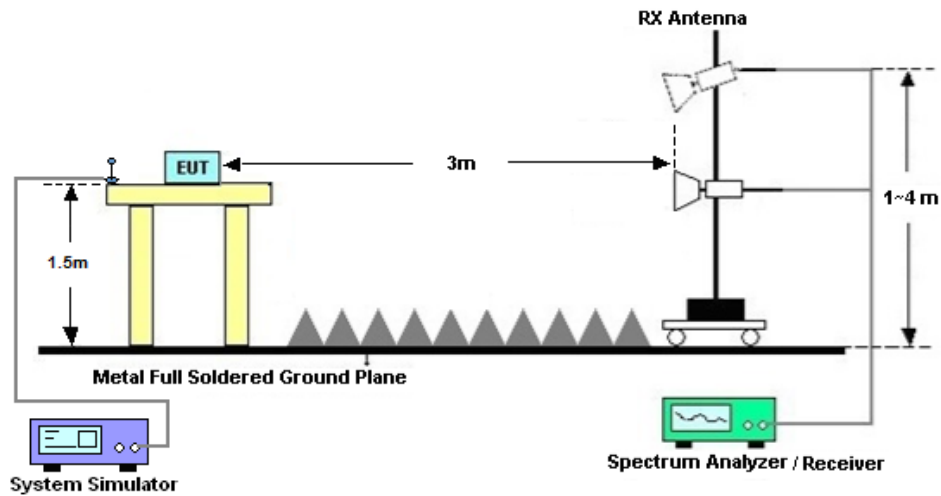

4.3 Test Result of Radiated Test

The low frequency, which started from 9 kHz to 30MHz, was pre-scanned and the result which was 20dB lower than the limit line was not reported.

Please refer to Appendix B.



4.4 Radiated Spurious Emission

4.4.1 Description of Radiated Spurious Emission Measurement

The radiated spurious emission was measured by substitution method according to ANSI C63.26. The power of any emission outside of the authorized operating frequency ranges must be attenuated below the transmitter power (P) by a factor of at least -40dBm / MHz.

The spectrum is scanned from 30 MHz up to a frequency including its 10th harmonic.

4.4.2 Test Procedures

1. The EUT was placed on a turntable with 0.8 meter height for frequency below 1GHz and 1.5 meter height for frequency above 1GHz respectively above ground.
2. The EUT was set 3 meters from the receiving antenna mounted on the antenna tower.
3. The table was rotated 360 degrees to determine the position of the highest spurious emission.
4. The height of the receiving antenna is varied between 1m to 4m to search the maximum spurious emission for both horizontal and vertical polarizations.
5. During the measurement, the system simulator parameters were set to force the EUT transmitting at maximum output power.
6. Make the measurement with the spectrum analyzer's RBW = 1MHz, VBW = 3MHz, taking the record of maximum spurious emission.
7. A horn antenna was substituted in place of the EUT and was driven by a signal generator. Tune the output power of signal generator to the same emission level with EUT maximum spurious emission.
$$\text{EIRP (dBm)} = \text{S.G. Power} - \text{Tx Cable Loss} + \text{Tx Antenna Gain}$$
$$\text{ERP (dBm)} = \text{EIRP} - 2.15$$
8. The RF fundamental frequency should be excluded against the limit line in the operating frequency band.
The limit line is -40dBm/MHz



5 List of Measuring Equipment

Instrument	Manufacturer	Model No.	Serial No.	Characteristics	Calibration Date	Test Date	Due Date	Remark
Spectrum Analyzer	R&S	FSV40	101040	10Hz~40GHz	Oct. 12, 2022	Apr. 01, 2023~Apr. 12, 2023	Oct. 11, 2023	Conducted (TH01-KS)
Power divider	STI	STI08-0055	-	0.5~40GHz	NCR	Apr. 01, 2023~Apr. 12, 2023	NCR	Conducted (TH01-KS)
Temperature & humidity chamber	Hongzhan	LP-150U	H2014011440	-40~+150°C 20%~95%RH	Jul. 15, 2022	Apr. 01, 2023~Apr. 12, 2023	Jul. 14, 2023	Conducted (TH01-KS)
EXA Spectrum Analyzer	Keysight	N9010B	MY57471079	10Hz-44G,MAX 30dB	Oct. 12, 2022	Mar. 16, 2023	Oct. 11, 2023	Radiation (03CH04-KS)
Loop Antenna	R&S	HFH2-Z2	100321	9kHz~30MHz	Oct. 16, 2022	Mar. 16, 2023	Oct. 15, 2023	Radiation (03CH04-KS)
Bilog Antenna	TeseQ	CBL6111D	49922	30MHz-1GHz	May 24, 2022	Mar. 16, 2023	May 23, 2023	Radiation (03CH04-KS)
Horn Antenna	Schwarzbeck	BBHA9120D	1284	1GHz~18GHz	Jan. 04, 2023	Mar. 16, 2023	Jan. 03, 2024	Radiation (03CH04-KS)
SHF-EHF Horn	Com-power	AH-840	101070	18GHz~40GHz	Jan. 04, 2023	Mar. 16, 2023	Jan. 03, 2024	Radiation (03CH04-KS)
Amplifier	SONOMA	310N	187289	9KHz-1GHz	Jan. 04, 2023	Mar. 16, 2023	Jan. 03, 2024	Radiation (03CH04-KS)
Amplifier	MITEQ	EM18G40G GA	060728	18~40GHz	Jan. 04, 2023	Mar. 16, 2023	Jan. 03, 2024	Radiation (03CH04-KS)
high gain Amplifier	EM	EM01G18G A	060840	1Ghz-18Ghz	Oct. 12, 2022	Mar. 16, 2023	Oct. 11, 2023	Radiation (03CH04-KS)
Amplifier	Agilent	8449B	3008A02370	1Ghz-18Ghz	Oct. 12, 2022	Mar. 16, 2023	Oct. 11, 2023	Radiation (03CH04-KS)
AC Power Source	Chroma	61601	F104090004	N/A	NCR	Mar. 16, 2023	NCR	Radiation (03CH04-KS)
Turn Table	ChamPro	EM 1000-T	060762-T	0~360 degree	NCR	Mar. 16, 2023	NCR	Radiation (03CH04-KS)
Antenna Mast	ChamPro	EM 1000-A	060762-A	1 m~4 m	NCR	Mar. 16, 2023	NCR	Radiation (03CH04-KS)

NCR: No Calibration Required.



6 Uncertainty of Evaluation

Uncertainty of Conducted Measurement

Test Item	Uncertainty
Conducted Power	±0.46 dB
Conducted Emissions	±0.48 dB
Occupied Channel Bandwidth	±0.1 %

Uncertainty of Radiated Emission Measurement (30 MHz ~ 1000 MHz)

Measuring Uncertainty for a Level of Confidence of 95% (U = 2Uc(y))	3.3dB
---	-------

Uncertainty of Radiated Emission Measurement (1 GHz ~ 18 GHz)

Measuring Uncertainty for a Level of Confidence of 95% (U = 2Uc(y))	2.8dB
---	-------

Uncertainty of Radiated Emission Measurement (18 GHz ~ 40 GHz)

Measuring Uncertainty for a Level of Confidence of 95% (U = 2Uc(y))	2.8dB
---	-------

----- THE END -----



Appendix A. Test Results of Conducted Test

Test Engineer :	Simle Wang	Temperature :	22~23°C
		Relative Humidity :	40~42%

FR1 N77(Ant3)

Transmitter Conducted Output Power And EIRP, (G_T-L_C)=0.32dB

NR Band	SCS	BandWidth	Arfcn	Freq(MHz)	Modulation	RB	Conducted Power(dBm)	EIRP(dBm)	EIRP(W)
77	30	20	637334	3560.01	DFT-s-OFDM PI/2 BPSK	1@1	18.62	18.94	0.0783
77	30	20	641666	3624.99	DFT-s-OFDM PI/2 BPSK	1@1	18.73	19.05	0.0804
77	30	20	646000	3690	DFT-s-OFDM PI/2 BPSK	1@1	18.97	19.29	0.0849
77	30	30	637668	3565.02	DFT-s-OFDM PI/2 BPSK	1@1	18.72	19.04	0.0802
77	30	30	641666	3624.99	DFT-s-OFDM PI/2 BPSK	1@1	18.95	19.27	0.0845
77	30	30	645666	3684.99	DFT-s-OFDM PI/2 BPSK	1@1	19.14	19.46	0.0883
77	30	40	638000	3570	DFT-s-OFDM PI/2 BPSK	1@1	19.03	19.35	0.0861
77	30	40	641666	3624.99	DFT-s-OFDM PI/2 BPSK	1@1	19.17	19.49	0.0889
77	30	40	645332	3679.98	DFT-s-OFDM PI/2 BPSK	1@1	18.57	18.89	0.0774
77	30	50	638334	3575.01	DFT-s-OFDM PI/2 BPSK	1@1	18.55	18.87	0.0771
77	30	50	641666	3624.99	DFT-s-OFDM PI/2 BPSK	1@1	18.9	19.22	0.0836
77	30	50	645000	3675	DFT-s-OFDM PI/2 BPSK	1@1	18.7	19.02	0.0798
77	30	60	638668	3580.02	DFT-s-OFDM PI/2 BPSK	1@1	18.61	18.93	0.0782
77	30	60	641666	3624.99	DFT-s-OFDM PI/2 BPSK	1@1	18.88	19.2	0.0832
77	30	60	644666	3669.99	DFT-s-OFDM PI/2 BPSK	1@1	18.57	18.89	0.0774
77	30	70	639000	3585	DFT-s-OFDM PI/2 BPSK	1@1	18.5	18.82	0.0762
77	30	70	641666	3624.99	DFT-s-OFDM PI/2 BPSK	1@1	18.72	19.04	0.0802
77	30	70	644332	3664.98	DFT-s-OFDM PI/2 BPSK	1@1	18.55	18.87	0.0771
77	30	80	639334	3590.01	DFT-s-OFDM PI/2 BPSK	1@1	18.51	18.83	0.0764
77	30	80	641666	3624.99	DFT-s-OFDM PI/2 BPSK	1@1	18.84	19.16	0.0824
77	30	80	644000	3660	DFT-s-OFDM PI/2 BPSK	1@1	18.6	18.92	0.0780
77	30	90	639668	3595.02	DFT-s-OFDM PI/2 BPSK	1@1	18.48	18.8	0.0759
77	30	90	641666	3624.99	DFT-s-OFDM PI/2 BPSK	1@1	18.82	19.14	0.0820
77	30	90	643666	3654.99	DFT-s-OFDM PI/2 BPSK	1@1	18.67	18.99	0.0793
77	30	100	640000	3600	DFT-s-OFDM PI/2 BPSK	135@67	18.72	19.04	0.0802
77	30	100	640000	3600	DFT-s-OFDM PI/2 BPSK	1@1	19.24	19.56	0.0904
77	30	100	640000	3600	DFT-s-OFDM PI/2 BPSK	1@271	18.58	18.9	0.0776
77	30	100	640000	3600	DFT-s-OFDM QPSK	135@67	18.75	19.07	0.0807
77	30	100	640000	3600	DFT-s-OFDM QPSK	1@1	18.57	18.89	0.0774
77	30	100	640000	3600	DFT-s-OFDM QPSK	1@271	18.53	18.85	0.0767
77	30	100	640000	3600	DFT-s-OFDM 16 QAM	135@67	18.72	19.04	0.0802
77	30	100	640000	3600	DFT-s-OFDM 16 QAM	1@1	18.69	19.01	0.0796
77	30	100	640000	3600	DFT-s-OFDM 16 QAM	1@271	18.66	18.98	0.0791
77	30	100	640000	3600	DFT-s-OFDM 64 QAM	135@67	18.77	19.09	0.0811
77	30	100	640000	3600	DFT-s-OFDM 64 QAM	1@1	18.51	18.83	0.0764
77	30	100	640000	3600	DFT-s-OFDM 64 QAM	1@271	18.58	18.9	0.0776
77	30	100	640000	3600	DFT-s-OFDM 256 QAM	135@67	18.74	19.06	0.0805
77	30	100	640000	3600	DFT-s-OFDM 256 QAM	1@1	18.47	18.79	0.0757

77	30	100	640000	3600	DFT-s-OFDM 256 QAM	1@271	18.42	18.74	0.0748
77	30	100	640000	3600	CP-OFDM QPSK	1@1	18.58	18.9	0.0776
77	30	100	641666	3624.99	DFT-s-OFDM PI/2 BPSK	135@67	18.61	18.93	0.0782
77	30	100	641666	3624.99	DFT-s-OFDM PI/2 BPSK	1@1	18.83	19.15	0.0822
77	30	100	641666	3624.99	DFT-s-OFDM PI/2 BPSK	1@271	18.81	19.13	0.0818
77	30	100	641666	3624.99	DFT-s-OFDM QPSK	135@67	18.52	18.84	0.0766
77	30	100	641666	3624.99	DFT-s-OFDM QPSK	1@1	18.86	19.18	0.0828
77	30	100	641666	3624.99	DFT-s-OFDM QPSK	1@271	18.62	18.94	0.0783
77	30	100	641666	3624.99	DFT-s-OFDM 16 QAM	135@67	18.51	18.83	0.0764
77	30	100	641666	3624.99	DFT-s-OFDM 16 QAM	1@1	18.95	19.27	0.0845
77	30	100	641666	3624.99	DFT-s-OFDM 16 QAM	1@271	18.8	19.12	0.0817
77	30	100	641666	3624.99	DFT-s-OFDM 64 QAM	135@67	18.59	18.91	0.0778
77	30	100	641666	3624.99	DFT-s-OFDM 64 QAM	1@1	18.69	19.01	0.0796
77	30	100	641666	3624.99	DFT-s-OFDM 64 QAM	1@271	18.62	18.94	0.0783
77	30	100	641666	3624.99	DFT-s-OFDM 256 QAM	135@67	18.57	18.89	0.0774
77	30	100	641666	3624.99	DFT-s-OFDM 256 QAM	1@1	18.63	18.95	0.0785
77	30	100	641666	3624.99	DFT-s-OFDM 256 QAM	1@271	18.59	18.91	0.0778
77	30	100	641666	3624.99	CP-OFDM QPSK	1@1	18.79	19.11	0.0815
77	30	100	643332	3649.98	DFT-s-OFDM PI/2 BPSK	135@67	18.69	19.01	0.0796
77	30	100	643332	3649.98	DFT-s-OFDM PI/2 BPSK	1@1	18.8	19.12	0.0817
77	30	100	643332	3649.98	DFT-s-OFDM PI/2 BPSK	1@271	18.4	18.72	0.0745
77	30	100	643332	3649.98	DFT-s-OFDM QPSK	135@67	18.68	19	0.0794
77	30	100	643332	3649.98	DFT-s-OFDM QPSK	1@1	18.87	19.19	0.0830
77	30	100	643332	3649.98	DFT-s-OFDM QPSK	1@271	18.36	18.68	0.0738
77	30	100	643332	3649.98	DFT-s-OFDM 16 QAM	135@67	18.66	18.98	0.0791
77	30	100	643332	3649.98	DFT-s-OFDM 16 QAM	1@1	18.97	19.29	0.0849
77	30	100	643332	3649.98	DFT-s-OFDM 16 QAM	1@271	18.47	18.79	0.0757
77	30	100	643332	3649.98	DFT-s-OFDM 64 QAM	135@67	18.72	19.04	0.0802
77	30	100	643332	3649.98	DFT-s-OFDM 64 QAM	1@1	18.74	19.06	0.0805
77	30	100	643332	3649.98	DFT-s-OFDM 64 QAM	1@271	18.34	18.66	0.0735
77	30	100	643332	3649.98	DFT-s-OFDM 256 QAM	135@67	18.71	19.03	0.0800
77	30	100	643332	3649.98	DFT-s-OFDM 256 QAM	1@1	18.74	19.06	0.0805
77	30	100	643332	3649.98	DFT-s-OFDM 256 QAM	1@271	18.26	18.58	0.0721
77	30	100	643332	3649.98	CP-OFDM QPSK	1@1	18.81	19.13	0.0818

FR1 N78(Ant3)

Transmitter Conducted Output Power And EIRP, (G_T-L_C)=0.32dB

NR Band	SCS	BandWidth	Arfcn	Freq(MHz)	Modulation	RB	Conducted Power(dBm)	EIRP(dBm)	EIRP(W)
78	30	20	637334	3560.01	DFT-s-OFDM PI/2 BPSK	1@1	19.16	19.48	0.0887
78	30	20	641666	3624.99	DFT-s-OFDM PI/2 BPSK	1@1	19.27	19.59	0.0910
78	30	20	646000	3690	DFT-s-OFDM PI/2 BPSK	1@1	19.26	19.58	0.0908
78	30	30	637668	3565.02	DFT-s-OFDM PI/2 BPSK	1@1	19.18	19.5	0.0891
78	30	30	641666	3624.99	DFT-s-OFDM PI/2 BPSK	1@1	19.35	19.67	0.0927
78	30	30	645666	3684.99	DFT-s-OFDM PI/2 BPSK	1@1	19.38	19.7	0.0933
78	30	40	638000	3570	DFT-s-OFDM PI/2 BPSK	1@1	19.28	19.6	0.0912
78	30	40	641666	3624.99	DFT-s-OFDM PI/2 BPSK	1@1	19.4	19.72	0.0938
78	30	40	645332	3679.98	DFT-s-OFDM PI/2 BPSK	1@1	19.41	19.73	0.0940
78	30	50	638334	3575.01	DFT-s-OFDM PI/2 BPSK	1@1	18.96	19.28	0.0847
78	30	50	641666	3624.99	DFT-s-OFDM PI/2 BPSK	1@1	19.07	19.39	0.0869
78	30	50	645000	3675	DFT-s-OFDM PI/2 BPSK	1@1	19.02	19.34	0.0859
78	30	60	638668	3580.02	DFT-s-OFDM PI/2 BPSK	1@1	18.86	19.18	0.0828
78	30	60	641666	3624.99	DFT-s-OFDM PI/2 BPSK	1@1	19.05	19.37	0.0865
78	30	60	644666	3669.99	DFT-s-OFDM PI/2 BPSK	1@1	18.93	19.25	0.0841
78	30	70	639000	3585	DFT-s-OFDM PI/2 BPSK	1@1	18.89	19.21	0.0834
78	30	70	641666	3624.99	DFT-s-OFDM PI/2 BPSK	1@1	19.02	19.34	0.0859
78	30	70	644332	3664.98	DFT-s-OFDM PI/2 BPSK	1@1	18.99	19.31	0.0853
78	30	80	639334	3590.01	DFT-s-OFDM PI/2 BPSK	1@1	18.91	19.23	0.0838
78	30	80	641666	3624.99	DFT-s-OFDM PI/2 BPSK	1@1	19.05	19.37	0.0865
78	30	80	644000	3660	DFT-s-OFDM PI/2 BPSK	1@1	19.06	19.38	0.0867
78	30	90	639668	3595.02	DFT-s-OFDM PI/2 BPSK	1@1	18.89	19.21	0.0834
78	30	90	641666	3624.99	DFT-s-OFDM PI/2 BPSK	1@1	19.09	19.41	0.0873
78	30	90	643666	3654.99	DFT-s-OFDM PI/2 BPSK	1@1	19.07	19.39	0.0869
78	30	100	640000	3600	DFT-s-OFDM PI/2 BPSK	135@67	19.05	19.37	0.0865
78	30	100	640000	3600	DFT-s-OFDM PI/2 BPSK	1@1	18.85	19.17	0.0826
78	30	100	640000	3600	DFT-s-OFDM PI/2 BPSK	1@271	18.82	19.14	0.0820
78	30	100	640000	3600	DFT-s-OFDM QPSK	135@67	18.97	19.29	0.0849
78	30	100	640000	3600	DFT-s-OFDM QPSK	1@1	18.91	19.23	0.0838
78	30	100	640000	3600	DFT-s-OFDM QPSK	1@271	18.9	19.22	0.0836
78	30	100	640000	3600	DFT-s-OFDM 16 QAM	135@67	18.93	19.25	0.0841
78	30	100	640000	3600	DFT-s-OFDM 16 QAM	1@1	19.06	19.38	0.0867
78	30	100	640000	3600	DFT-s-OFDM 16 QAM	1@271	18.91	19.23	0.0838
78	30	100	640000	3600	DFT-s-OFDM 64 QAM	135@67	18.95	19.27	0.0845
78	30	100	640000	3600	DFT-s-OFDM 64 QAM	1@1	18.81	19.13	0.0818
78	30	100	640000	3600	DFT-s-OFDM 64 QAM	1@271	18.77	19.09	0.0811

78	30	100	640000	3600	DFT-s-OFDM 256 QAM	135@67	19	19.32	0.0855
78	30	100	640000	3600	DFT-s-OFDM 256 QAM	1@1	18.79	19.11	0.0815
78	30	100	640000	3600	DFT-s-OFDM 256 QAM	1@271	18.7	19.02	0.0798
78	30	100	640000	3600	CP-OFDM QPSK	1@1	18.99	19.31	0.0853
78	30	100	641666	3624.99	DFT-s-OFDM PI/2 BPSK	135@67	18.93	19.25	0.0841
78	30	100	641666	3624.99	DFT-s-OFDM PI/2 BPSK	1@1	19	19.32	0.0855
78	30	100	641666	3624.99	DFT-s-OFDM PI/2 BPSK	1@271	18.89	19.21	0.0834
78	30	100	641666	3624.99	DFT-s-OFDM QPSK	135@67	18.91	19.23	0.0838
78	30	100	641666	3624.99	DFT-s-OFDM QPSK	1@1	19.03	19.35	0.0861
78	30	100	641666	3624.99	DFT-s-OFDM QPSK	1@271	19	19.32	0.0855
78	30	100	641666	3624.99	DFT-s-OFDM 16 QAM	135@67	18.92	19.24	0.0839
78	30	100	641666	3624.99	DFT-s-OFDM 16 QAM	1@1	19.22	19.54	0.0899
78	30	100	641666	3624.99	DFT-s-OFDM 16 QAM	1@271	19.09	19.41	0.0873
78	30	100	641666	3624.99	DFT-s-OFDM 64 QAM	135@67	18.96	19.28	0.0847
78	30	100	641666	3624.99	DFT-s-OFDM 64 QAM	1@1	18.97	19.29	0.0849
78	30	100	641666	3624.99	DFT-s-OFDM 64 QAM	1@271	18.92	19.24	0.0839
78	30	100	641666	3624.99	DFT-s-OFDM 256 QAM	135@67	18.97	19.29	0.0849
78	30	100	641666	3624.99	DFT-s-OFDM 256 QAM	1@1	18.86	19.18	0.0828
78	30	100	641666	3624.99	DFT-s-OFDM 256 QAM	1@271	18.86	19.18	0.0828
78	30	100	641666	3624.99	CP-OFDM QPSK	1@1	19.06	19.38	0.0867
78	30	100	643332	3649.98	DFT-s-OFDM PI/2 BPSK	135@67	19.03	19.35	0.0861
78	30	100	643332	3649.98	DFT-s-OFDM PI/2 BPSK	1@1	19.43	19.75	0.0944
78	30	100	643332	3649.98	DFT-s-OFDM PI/2 BPSK	1@271	18.96	19.28	0.0847
78	30	100	643332	3649.98	DFT-s-OFDM QPSK	135@67	18.94	19.26	0.0843
78	30	100	643332	3649.98	DFT-s-OFDM QPSK	1@1	19.07	19.39	0.0869
78	30	100	643332	3649.98	DFT-s-OFDM QPSK	1@271	19.01	19.33	0.0857
78	30	100	643332	3649.98	DFT-s-OFDM 16 QAM	135@67	18.9	19.22	0.0836
78	30	100	643332	3649.98	DFT-s-OFDM 16 QAM	1@1	19.17	19.49	0.0889
78	30	100	643332	3649.98	DFT-s-OFDM 16 QAM	1@271	18.97	19.29	0.0849
78	30	100	643332	3649.98	DFT-s-OFDM 64 QAM	135@67	18.93	19.25	0.0841
78	30	100	643332	3649.98	DFT-s-OFDM 64 QAM	1@1	18.96	19.28	0.0847
78	30	100	643332	3649.98	DFT-s-OFDM 64 QAM	1@271	18.74	19.06	0.0805
78	30	100	643332	3649.98	DFT-s-OFDM 256 QAM	135@67	18.94	19.26	0.0843
78	30	100	643332	3649.98	DFT-s-OFDM 256 QAM	1@1	18.87	19.19	0.0830
78	30	100	643332	3649.98	DFT-s-OFDM 256 QAM	1@271	18.73	19.05	0.0804
78	30	100	643332	3649.98	CP-OFDM QPSK	1@1	18.99	19.31	0.0853

Frequency Stability

NR Band	SCS (kHz)	Bandwidth (MHz)	Arfcn	Freq (MHz)	Modulation	RB	Deviation (ppm)	Verdict	Environment
78	30	20	641666	3624.99	DFT-s-OFDM QPSK	50@0	-0.0014	PASS	NV
78	30	20	641666	3624.99	DFT-s-OFDM QPSK	50@0	0.0010	PASS	LV
78	30	20	641666	3624.99	DFT-s-OFDM QPSK	50@0	0.0022	PASS	HV
78	30	20	641666	3624.99	DFT-s-OFDM QPSK	50@0	0.0023	PASS	-30°C
78	30	20	641666	3624.99	DFT-s-OFDM QPSK	50@0	0.0013	PASS	-20°C
78	30	20	641666	3624.99	DFT-s-OFDM QPSK	50@0	0.0018	PASS	-10°C
78	30	20	641666	3624.99	DFT-s-OFDM QPSK	50@0	0.0021	PASS	0°C
78	30	20	641666	3624.99	DFT-s-OFDM QPSK	50@0	0.0026	PASS	10°C
78	30	20	641666	3624.99	DFT-s-OFDM QPSK	50@0	0.0024	PASS	20°C
78	30	20	641666	3624.99	DFT-s-OFDM QPSK	50@0	0.0017	PASS	30°C
78	30	20	641666	3624.99	DFT-s-OFDM QPSK	50@0	-0.0025	PASS	40°C
78	30	20	641666	3624.99	DFT-s-OFDM QPSK	50@0	-0.0018	PASS	50°C

Occupied Bandwidth

NR Band	SCS (kHz)	Bandwidth (MHz)	Arfcn	Freq (MHz)	Modulation	RB	OBW (MHz)	26dB BW (MHz)
78	30	20	641666	3624.99	CP-OFDM QPSK	51@0	18.196	18.92
78	30	20	641666	3624.99	CP-OFDM 16 QAM	51@0	18.209	19.02
78	30	20	641666	3624.99	CP-OFDM 64 QAM	51@0	18.18	19.28
78	30	20	641666	3624.99	CP-OFDM 256 QAM	51@0	18.132	19.29
78	30	30	641666	3624.99	CP-OFDM QPSK	78@0	27.9	29.29
78	30	30	641666	3624.99	CP-OFDM 16 QAM	78@0	27.899	29.15
78	30	30	641666	3624.99	CP-OFDM 64 QAM	78@0	27.848	28.98
78	30	30	641666	3624.99	CP-OFDM 256 QAM	78@0	27.832	29.06
78	30	40	641666	3624.99	CP-OFDM QPSK	106@0	37.892	39.21
78	30	40	641666	3624.99	CP-OFDM 16 QAM	106@0	37.771	39.4
78	30	40	641666	3624.99	CP-OFDM 64 QAM	106@0	37.753	39.08
78	30	40	641666	3624.99	CP-OFDM 256 QAM	106@0	37.779	39.37
78	30	50	641666	3624.99	CP-OFDM QPSK	133@0	47.385	49.19
78	30	50	641666	3624.99	CP-OFDM 16 QAM	133@0	47.472	48.96
78	30	50	641666	3624.99	CP-OFDM 64 QAM	133@0	47.338	49.09
78	30	50	641666	3624.99	CP-OFDM 256 QAM	133@0	47.401	48.99
78	30	60	641666	3624.99	CP-OFDM QPSK	162@0	57.829	59.91
78	30	60	641666	3624.99	CP-OFDM 16 QAM	162@0	57.817	59.7
78	30	60	641666	3624.99	CP-OFDM 64 QAM	162@0	57.786	59.79
78	30	60	641666	3624.99	CP-OFDM 256 QAM	162@0	57.632	59.68
78	30	70	641666	3624.99	CP-OFDM QPSK	189@0	67.509	69.66
78	30	70	641666	3624.99	CP-OFDM 16 QAM	189@0	67.375	69.53
78	30	70	641666	3624.99	CP-OFDM 64 QAM	189@0	67.624	69.58
78	30	70	641666	3624.99	CP-OFDM 256 QAM	189@0	67.396	69.68
78	30	80	641666	3624.99	CP-OFDM QPSK	217@0	77.543	80.04
78	30	80	641666	3624.99	CP-OFDM 16 QAM	217@0	77.615	79.87

78	30	80	641666	3624.99	CP-OFDM 64 QAM	217@0	77.442	80.0
78	30	80	641666	3624.99	CP-OFDM 256 QAM	217@0	77.357	79.84
78	30	90	641666	3624.99	CP-OFDM QPSK	245@0	87.623	90.2
78	30	90	641666	3624.99	CP-OFDM 16 QAM	245@0	87.326	90.16
78	30	90	641666	3624.99	CP-OFDM 64 QAM	245@0	87.327	90.13
78	30	90	641666	3624.99	CP-OFDM 256 QAM	245@0	87.515	90.21
78	30	100	641666	3624.99	CP-OFDM QPSK	273@0	97.46	100.4
78	30	100	641666	3624.99	CP-OFDM 16 QAM	273@0	97.654	100.5
78	30	100	641666	3624.99	CP-OFDM 64 QAM	273@0	97.518	100.5
78	30	100	641666	3624.99	CP-OFDM 256 QAM	273@0	97.545	100.6

N78(20M)_CP-OFDM_QPSK_Outer_Full_Mid_CH

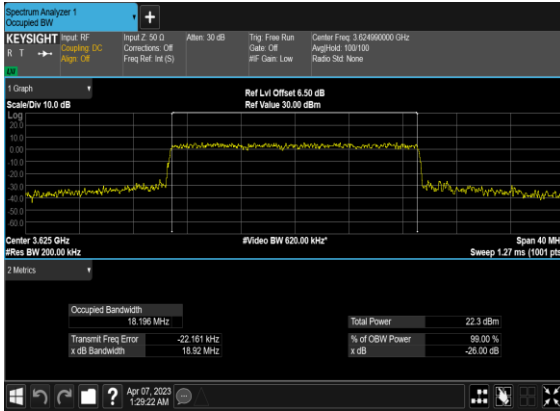

N78(20M)_CP-OFDM_16QAM_Outer_Full_Mid_CH

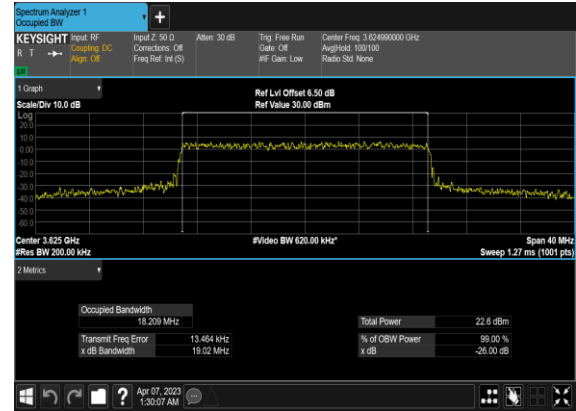

N78(20M)_CP-OFDM_64QAM_Outer_Full_Mid_CH

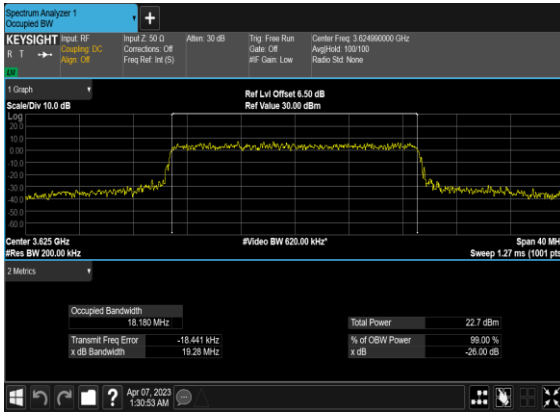

N78(20M)_CP-OFDM_256QAM_Outer_Full_Mid_CH

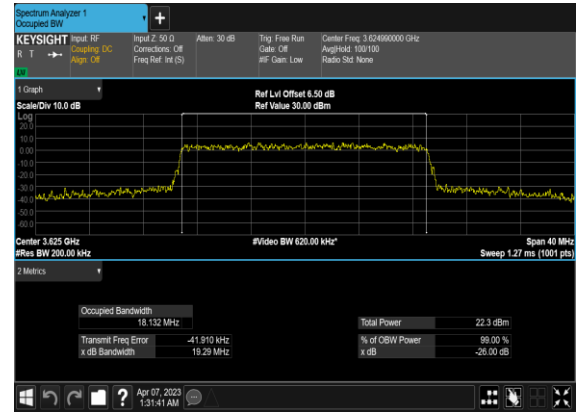

N78(30M)_CP-OFDM_QPSK_Outer_Full_Mid_CH

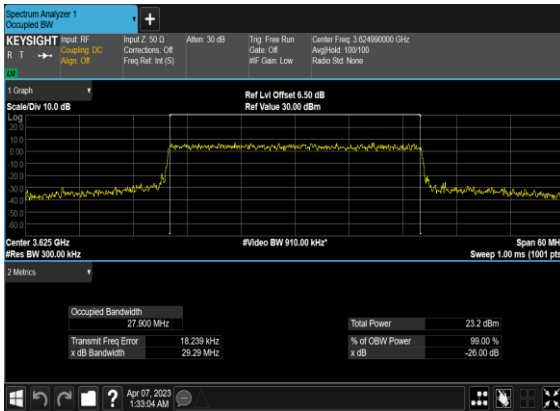

N78(30M)_CP-OFDM_16QAM_Outer_Full_Mid_CH

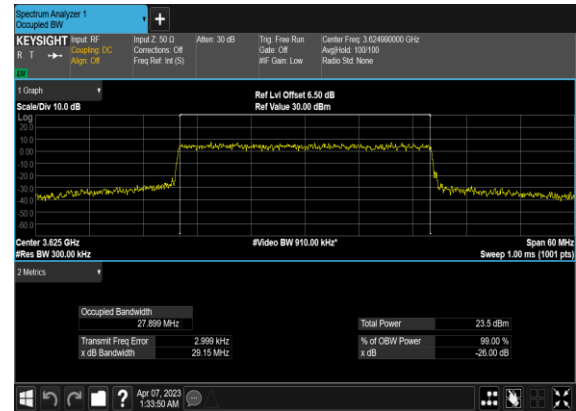

N78(30M)_CP-OFDM_64 QAM_Outer_Full_Mid_CH

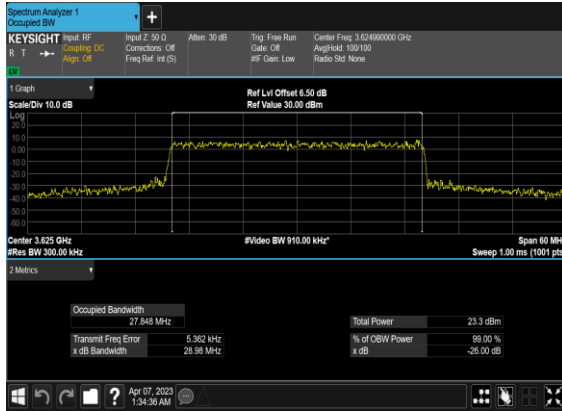

N78(30M)_CP-OFDM_256 QAM_Outer_Full_Mid_CH

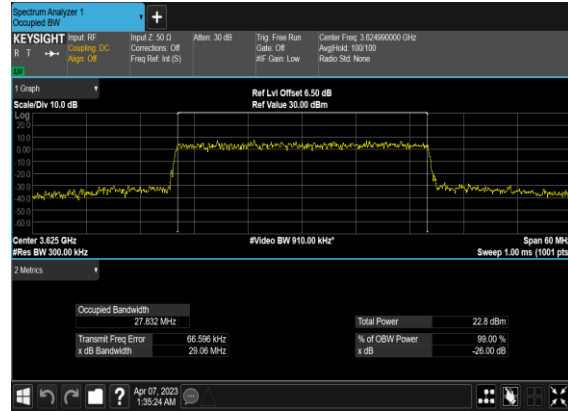

N78(40M)_CP- OFDM_QPSK_Outer_Full_Mid_CH

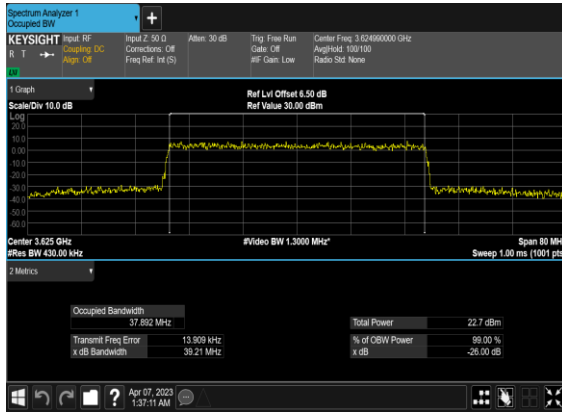

N78(40M)_CP-OFDM_16 QAM_Outer_Full_Mid_CH

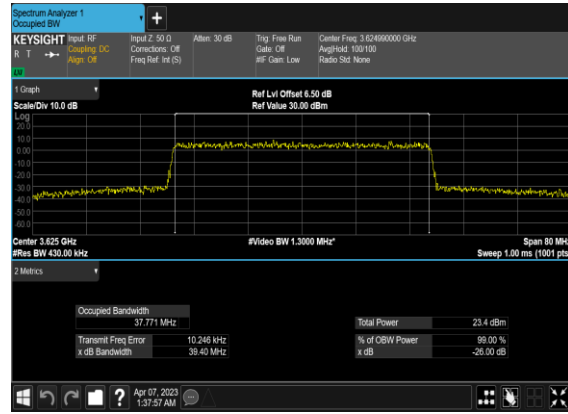

N78(40M)_CP-OFDM_64 QAM_Outer_Full_Mid_CH

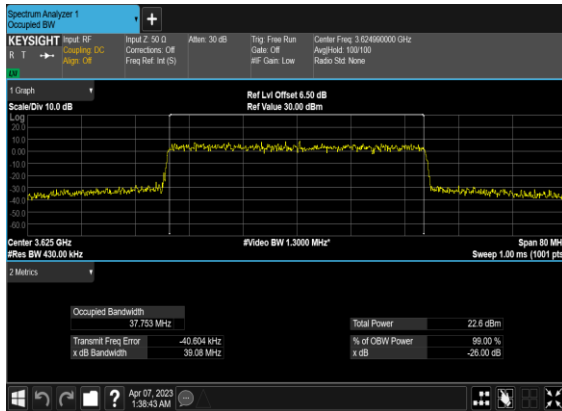

N78(40M)_CP-OFDM_256 QAM_Outer_Full_Mid_CH

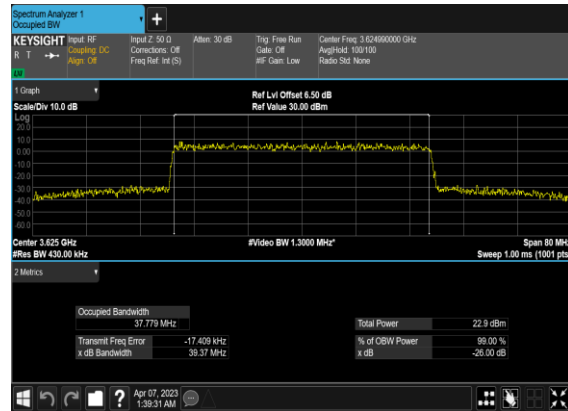

N78(50M)_CP-OFDM_QPSK_Outer_Full_Mid_CH

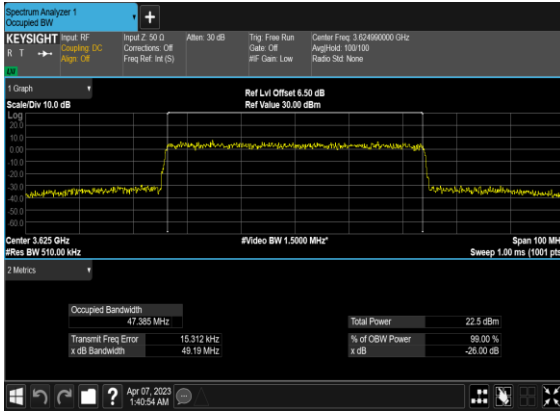

N78(50M)_CP-OFDM_16QAM_Outer_Full_Mid_CH

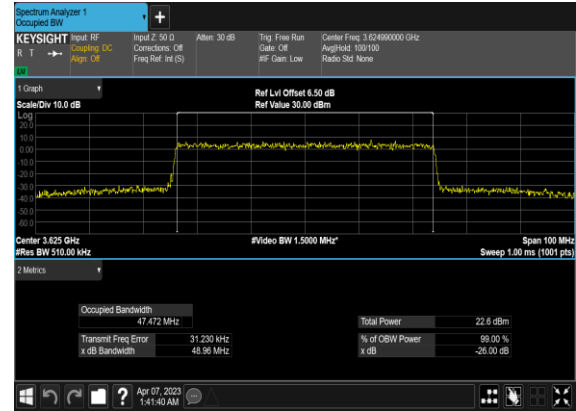

N78(50M)_CP-OFDM_64QAM_Outer_Full_Mid_CH

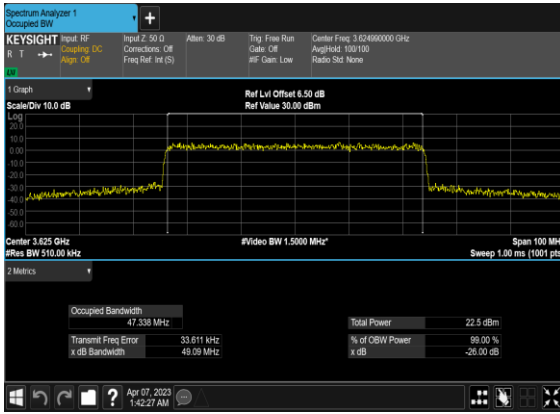

N78(50M)_CP-OFDM_256QAM_Outer_Full_Mid_CH

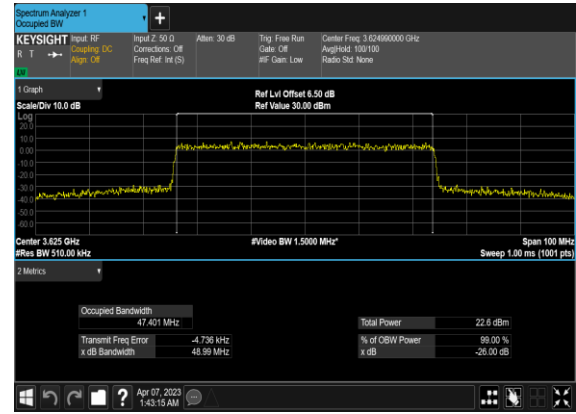

N78(60M)_CP-OFDM_QPSK_Outer_Full_Mid_CH

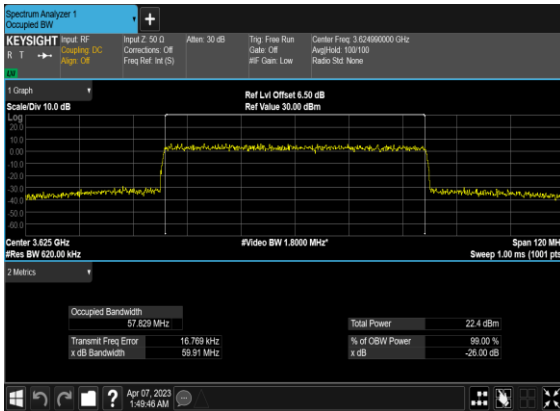

N78(60M)_CP-OFDM_16QAM_Outer_Full_Mid_CH

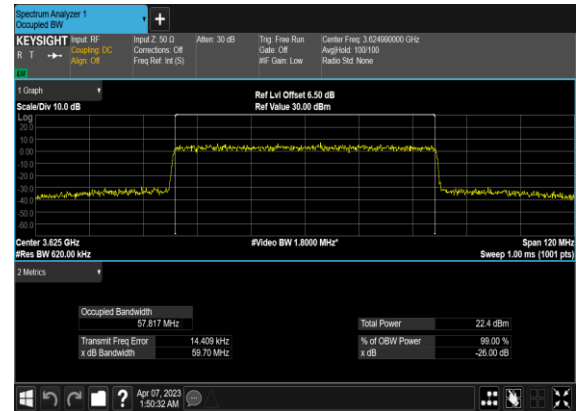

N78(60M)_CP-OFDM_64 QAM_Outer_Full_Mid_CH

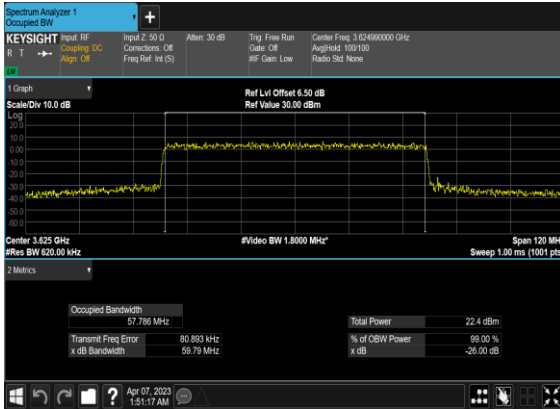

N78(60M)_CP-OFDM_256 QAM_Outer_Full_Mid_CH

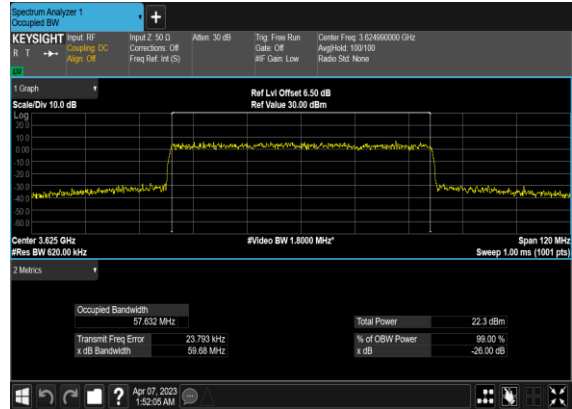

N78(70M)_CP- OFDM_QPSK_Outer_Full_Mid_CH

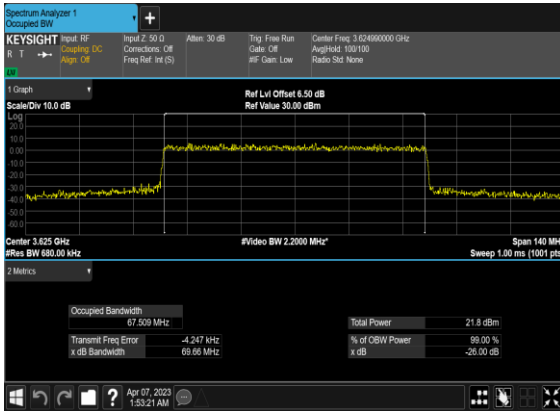

N78(70M)_CP-OFDM_16 QAM_Outer_Full_Mid_CH

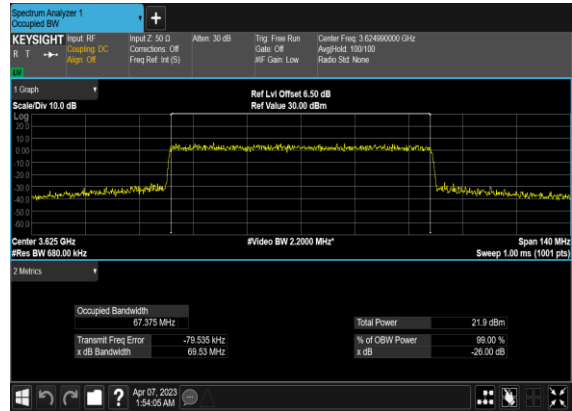

N78(70M)_CP-OFDM_64 QAM_Outer_Full_Mid_CH

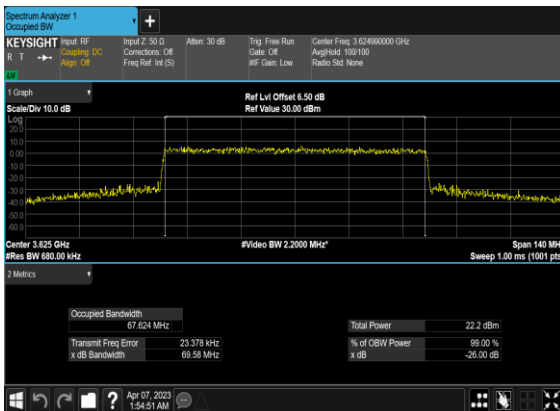

N78(70M)_CP-OFDM_256 QAM_Outer_Full_Mid_CH

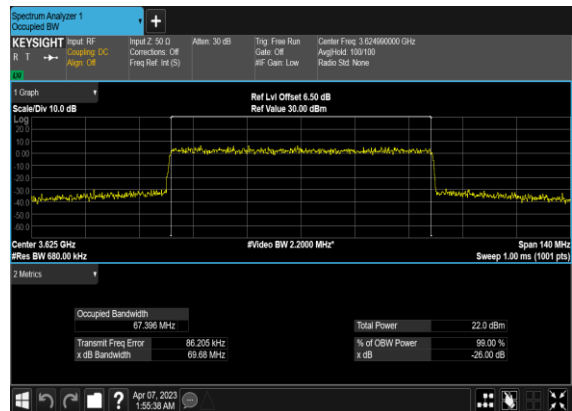

N78(80M)_CP-OFDM_QPSK_Outer_Full_Mid_CH

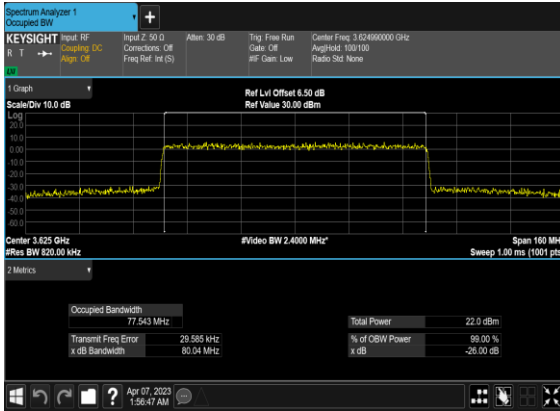

N78(80M)_CP-OFDM_16QAM_Outer_Full_Mid_CH

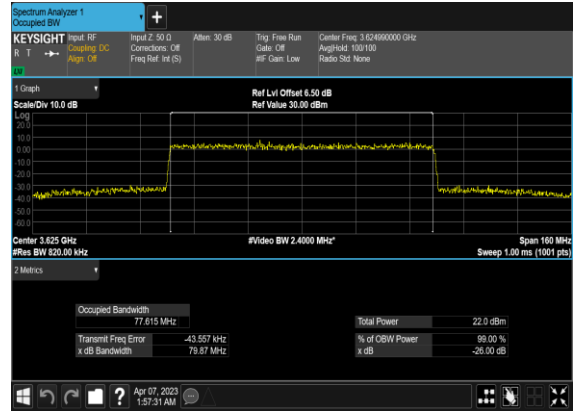

N78(80M)_CP-OFDM_64QAM_Outer_Full_Mid_CH

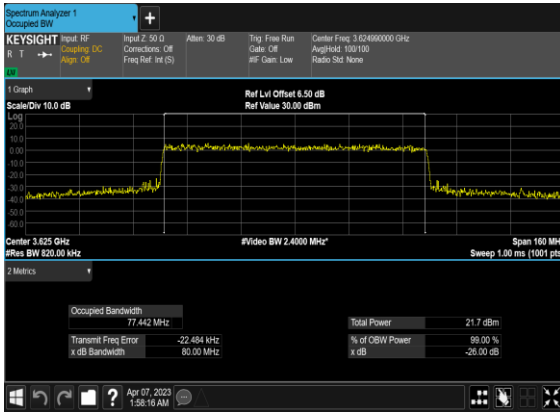

N78(80M)_CP-OFDM_256QAM_Outer_Full_Mid_CH

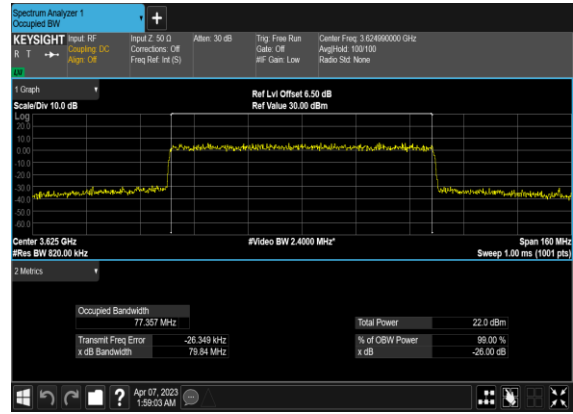

N78(90M)_CP-OFDM_QPSK_Outer_Full_Mid_CH

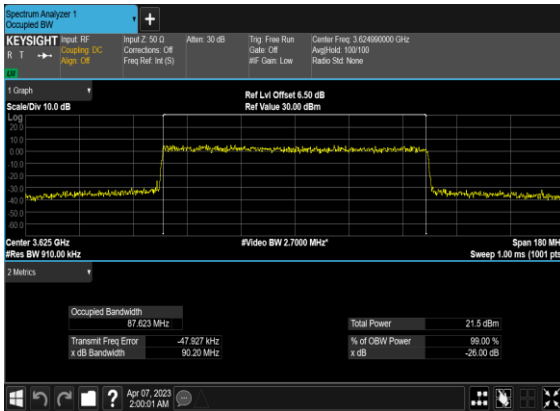

N78(90M)_CP-OFDM_16QAM_Outer_Full_Mid_CH

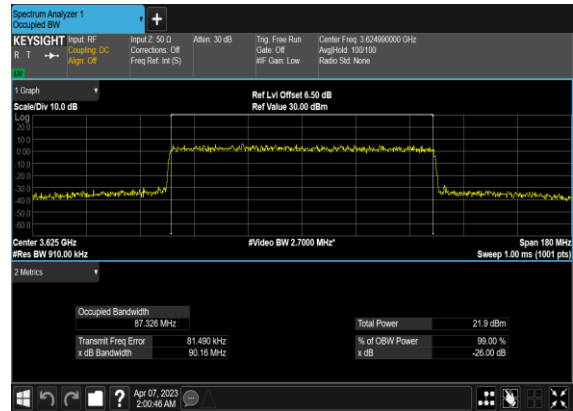

N78(90M)_CP-OFDM_64 QAM_Outer_Full_Mid_CH

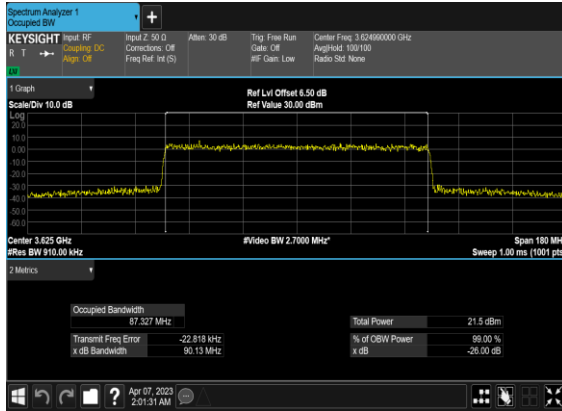

N78(90M)_CP-OFDM_256 QAM_Outer_Full_Mid_CH

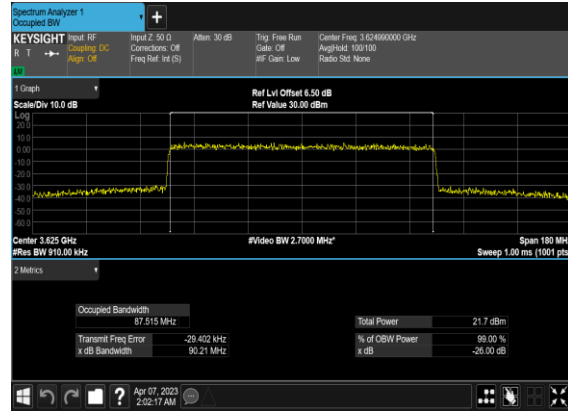

N78(100M)_CP- OFDM_QPSK_Outer_Full_Mid_CH

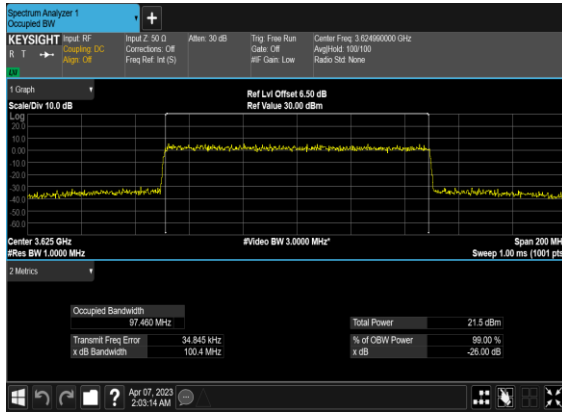

N78(100M)_CP-OFDM_16 QAM_Outer_Full_Mid_CH

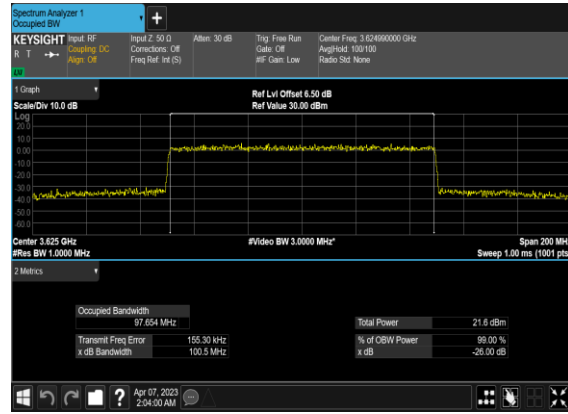

N78(100M)_CP-OFDM_64 QAM_Outer_Full_Mid_CH

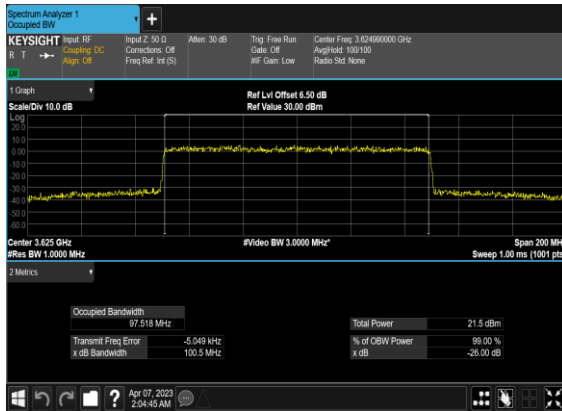

N78(100M)_CP-OFDM_256 QAM_Outer_Full_Mid_CH

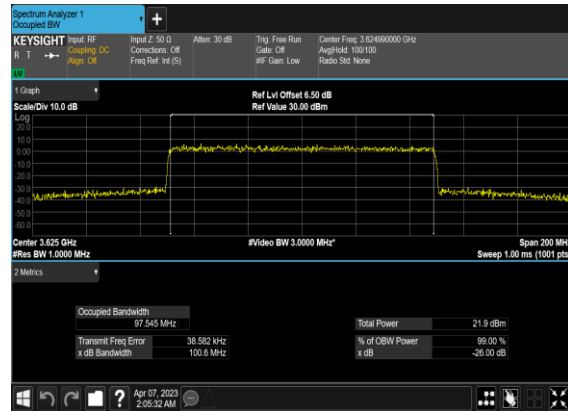

Conducted Spurious Emissions

NR Band	SCS (kHz)	Bandwidth (MHz)	Arfcn	Freq (MHz)	Modulation	RB	Result	Verdict
78	30	20	637334	3560.01	DFT-s-OFDM BPSK	1@0	see graph	---
78	30	20	637334	3560.01	DFT-s-OFDM BPSK	1@0	see graph	PASS
78	30	20	637334	3560.01	DFT-s-OFDM BPSK	1@0	see graph	PASS
78	30	20	637334	3560.01	DFT-s-OFDM QPSK	1@0	see graph	---
78	30	20	637334	3560.01	DFT-s-OFDM QPSK	1@0	see graph	PASS
78	30	20	637334	3560.01	DFT-s-OFDM QPSK	1@0	see graph	PASS
78	30	20	641666	3624.99	DFT-s-OFDM BPSK	1@0	see graph	---
78	30	20	641666	3624.99	DFT-s-OFDM BPSK	1@0	see graph	PASS
78	30	20	641666	3624.99	DFT-s-OFDM BPSK	1@0	see graph	PASS
78	30	20	641666	3624.99	DFT-s-OFDM QPSK	1@0	see graph	---
78	30	20	641666	3624.99	DFT-s-OFDM QPSK	1@0	see graph	PASS
78	30	20	641666	3624.99	DFT-s-OFDM QPSK	1@0	see graph	PASS
78	30	20	646000	3690.0	DFT-s-OFDM BPSK	1@0	see graph	---
78	30	20	646000	3690.0	DFT-s-OFDM BPSK	1@0	see graph	PASS
78	30	20	646000	3690.0	DFT-s-OFDM BPSK	1@0	see graph	PASS
78	30	20	646000	3690.0	DFT-s-OFDM QPSK	1@0	see graph	---
78	30	20	646000	3690.0	DFT-s-OFDM QPSK	1@0	see graph	PASS
78	30	20	646000	3690.0	DFT-s-OFDM QPSK	1@0	see graph	PASS
78	30	60	638668	3580.02	DFT-s-OFDM BPSK	1@0	see graph	---
78	30	60	638668	3580.02	DFT-s-OFDM BPSK	1@0	see graph	PASS
78	30	60	638668	3580.02	DFT-s-OFDM BPSK	1@0	see graph	PASS
78	30	60	638668	3580.02	DFT-s-OFDM QPSK	1@0	see graph	---
78	30	60	638668	3580.02	DFT-s-OFDM QPSK	1@0	see graph	PASS

78	30	60	638668	3580.02	DFT-s-OFDM QPSK	1@0	see graph	PASS
78	30	60	641666	3624.99	DFT-s-OFDM BPSK	1@0	see graph	---
78	30	60	641666	3624.99	DFT-s-OFDM BPSK	1@0	see graph	PASS
78	30	60	641666	3624.99	DFT-s-OFDM BPSK	1@0	see graph	PASS
78	30	60	641666	3624.99	DFT-s-OFDM QPSK	1@0	see graph	---
78	30	60	641666	3624.99	DFT-s-OFDM QPSK	1@0	see graph	PASS
78	30	60	641666	3624.99	DFT-s-OFDM QPSK	1@0	see graph	PASS
78	30	60	644666	3669.99	DFT-s-OFDM BPSK	1@0	see graph	---
78	30	60	644666	3669.99	DFT-s-OFDM BPSK	1@0	see graph	PASS
78	30	60	644666	3669.99	DFT-s-OFDM BPSK	1@0	see graph	PASS
78	30	60	644666	3669.99	DFT-s-OFDM QPSK	1@0	see graph	---
78	30	60	644666	3669.99	DFT-s-OFDM QPSK	1@0	see graph	PASS
78	30	60	644666	3669.99	DFT-s-OFDM QPSK	1@0	see graph	PASS
78	30	100	640000	3600.0	DFT-s-OFDM BPSK	1@0	see graph	---
78	30	100	640000	3600.0	DFT-s-OFDM BPSK	1@0	see graph	PASS
78	30	100	640000	3600.0	DFT-s-OFDM BPSK	1@0	see graph	PASS
78	30	100	640000	3600.0	DFT-s-OFDM QPSK	1@0	see graph	---
78	30	100	640000	3600.0	DFT-s-OFDM QPSK	1@0	see graph	PASS
78	30	100	640000	3600.0	DFT-s-OFDM QPSK	1@0	see graph	PASS
78	30	100	641666	3624.99	DFT-s-OFDM BPSK	1@0	see graph	---
78	30	100	641666	3624.99	DFT-s-OFDM BPSK	1@0	see graph	PASS
78	30	100	641666	3624.99	DFT-s-OFDM BPSK	1@0	see graph	PASS
78	30	100	641666	3624.99	DFT-s-OFDM QPSK	1@0	see graph	---
78	30	100	641666	3624.99	DFT-s-OFDM QPSK	1@0	see graph	PASS

78	30	100	641666	3624.99	DFT-s-OFDM QPSK	1@0	see graph	PASS
78	30	100	643332	3649.98	DFT-s-OFDM BPSK	1@0	see graph	---
78	30	100	643332	3649.98	DFT-s-OFDM BPSK	1@0	see graph	PASS
78	30	100	643332	3649.98	DFT-s-OFDM BPSK	1@0	see graph	PASS
78	30	100	643332	3649.98	DFT-s-OFDM QPSK	1@0	see graph	---
78	30	100	643332	3649.98	DFT-s-OFDM QPSK	1@0	see graph	PASS
78	30	100	643332	3649.98	DFT-s-OFDM QPSK	1@0	see graph	PASS

N78(20M)_DFT-s-OFDM_BPSK_Edge_1RB_Left_Low_CH

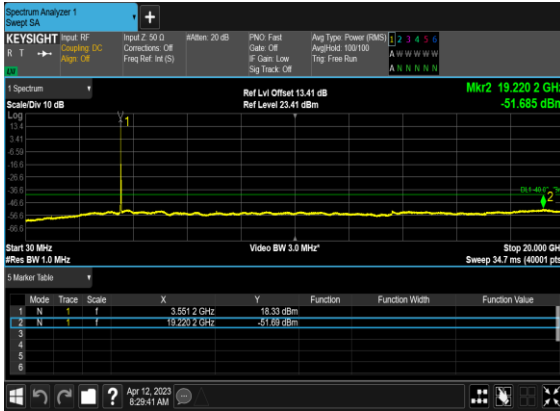

N78(20M)_DFT-s-OFDM_BPSK_Edge_1RB_Left_Low_CH

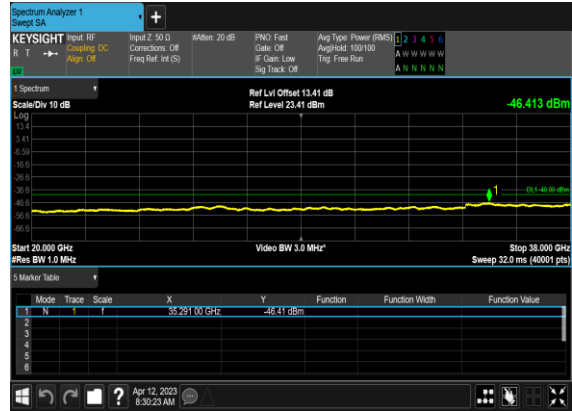

N78(20M)_DFT-s-OFDM_QPSK_Edge_1RB_Left_Low_CH

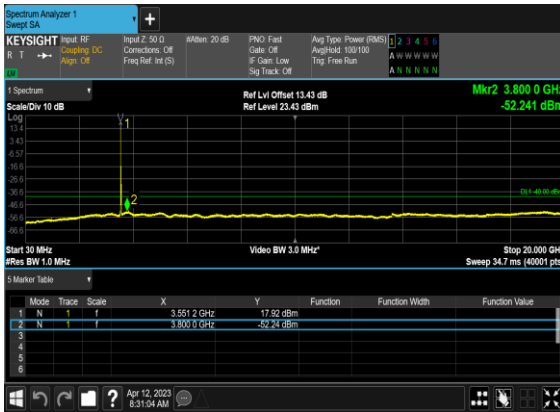

N78(20M)_DFT-s-OFDM_QPSK_Edge_1RB_Left_Low_CH

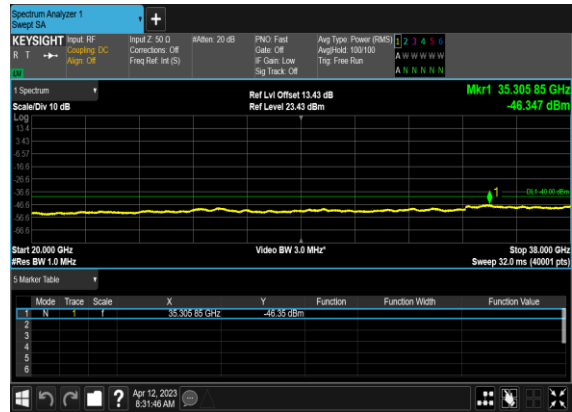

N78(20M)_DFT-s-OFDM_BPSK_Edge_1RB_Left_Mid_CH

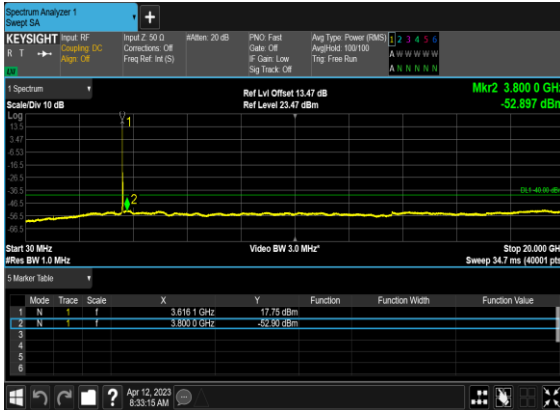

N78(20M)_DFT-s-OFDM_BPSK_Edge_1RB_Left_Mid_CH

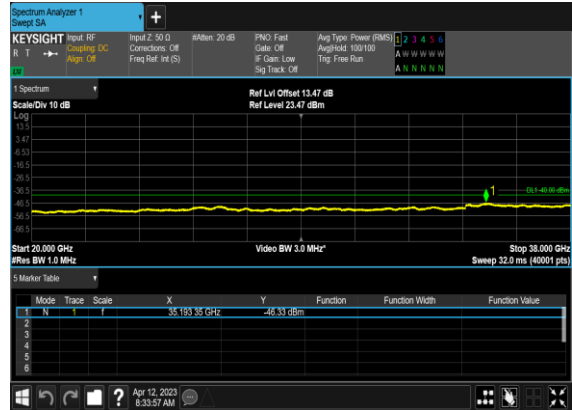

N78(20M)_DFT-s-OFDM_QPSK_Edge_1RB_Left_Mid_CH

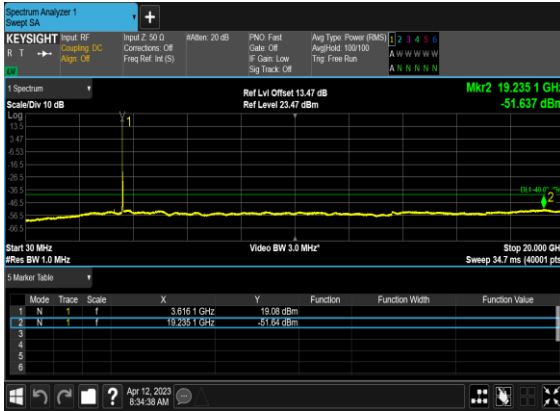

N78(20M)_DFT-s-OFDM_QPSK_Edge_1RB_Left_Mid_CH

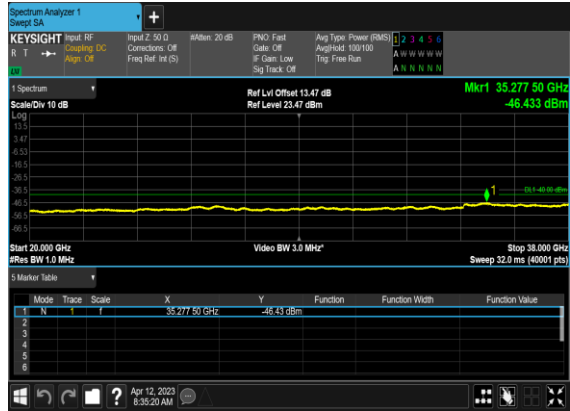

N78(20M)_DFT-s-OFDM_BPSK_Edge_1RB_Left_High_CH

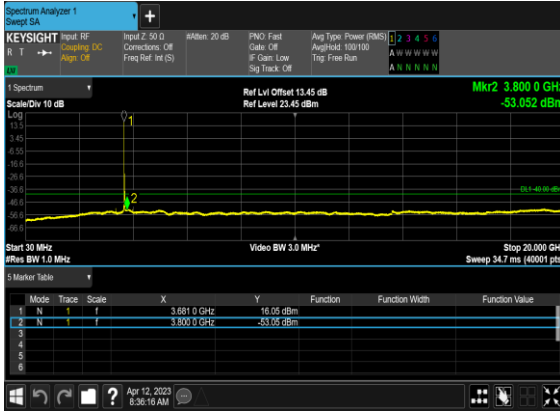

N78(20M)_DFT-s-OFDM_BPSK_Edge_1RB_Left_High_CH

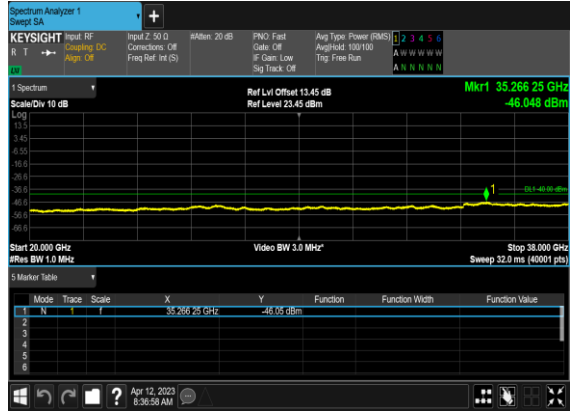

N78(20M)_DFT-s-OFDM_QPSK_Edge_1RB_Left_High_CH



N78(20M)_DFT-s-OFDM_QPSK_Edge_1RB_Left_High_CH



N78(60M)_DFT-s-OFDM_BPSK_Edge_1RB_Left_Low_CH

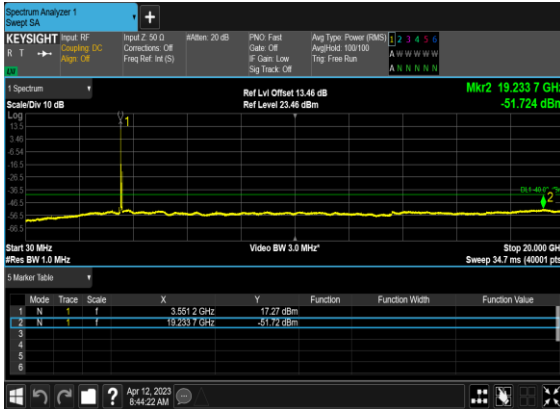

N78(60M)_DFT-s-OFDM_BPSK_Edge_1RB_Left_Low_CH

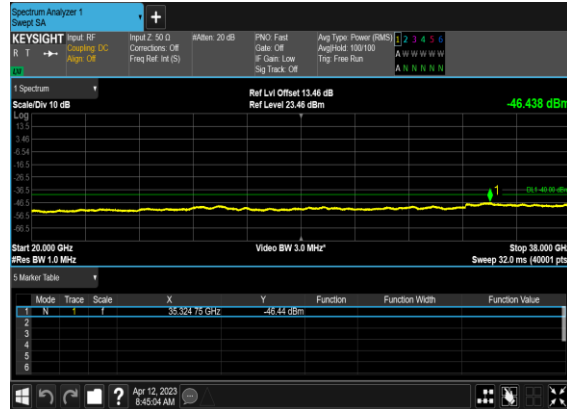

N78(60M)_DFT-s-OFDM_QPSK_Edge_1RB_Left_Low_CH

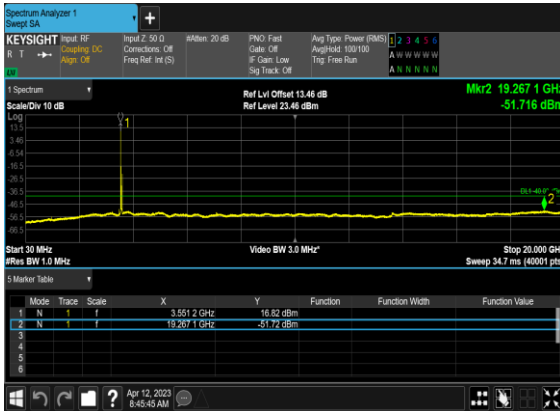

N78(60M)_DFT-s-OFDM_QPSK_Edge_1RB_Left_Low_CH

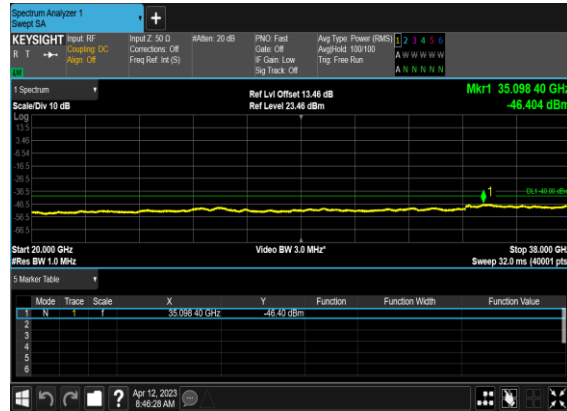

N78(60M)_DFT-s-OFDM_BPSK_Edge_1RB_Left_Mid_CH

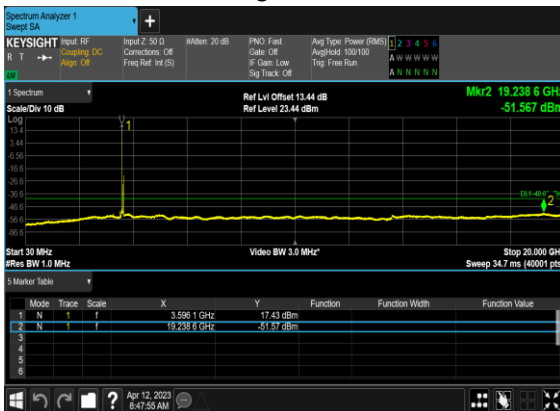

N78(60M)_DFT-s-OFDM_BPSK_Edge_1RB_Left_Mid_CH

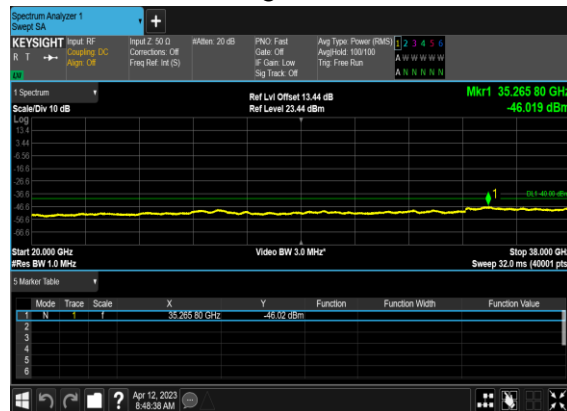

N78(60M)_DFT-s-OFDM_QPSK_Edge_1RB_Left_Mid_CH

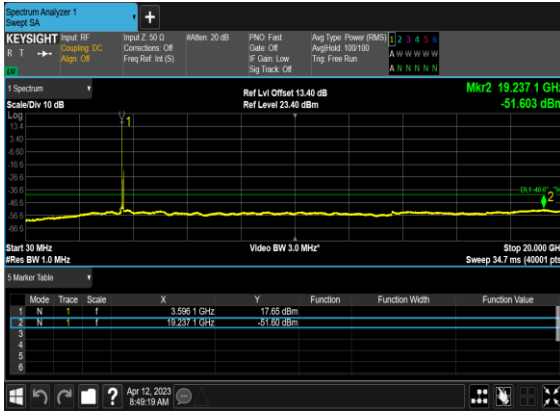

N78(60M)_DFT-s-OFDM_QPSK_Edge_1RB_Left_Mid_CH

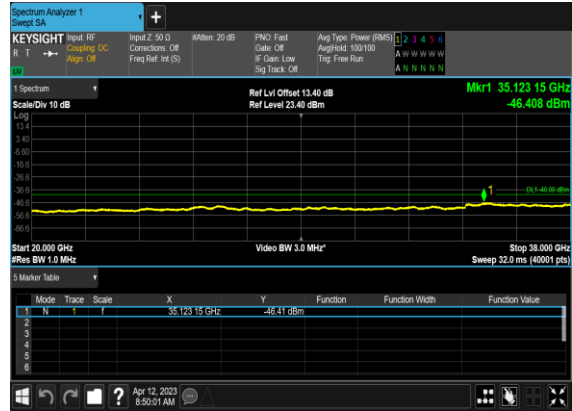

N78(60M)_DFT-s-OFDM_BPSK_Edge_1RB_Left_High_CH

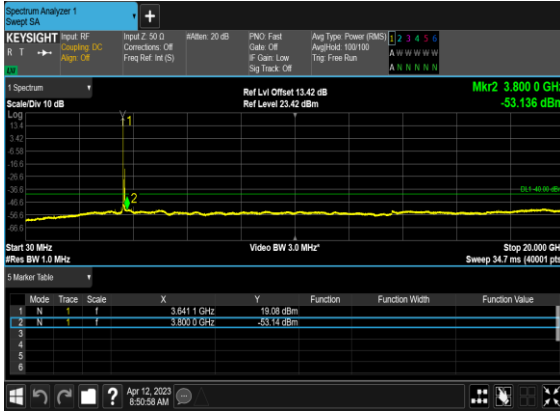

N78(60M)_DFT-s-OFDM_BPSK_Edge_1RB_Left_High_CH

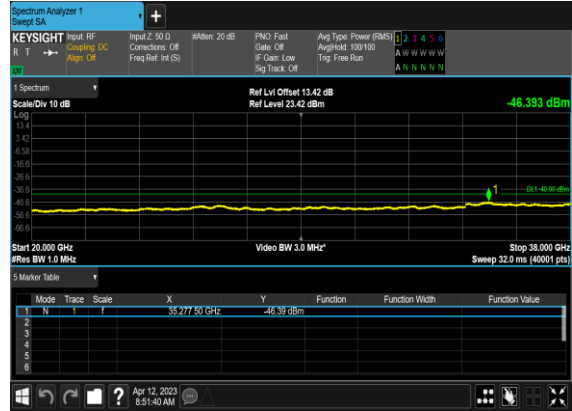

N78(60M)_DFT-s-OFDM_QPSK_Edge_1RB_Left_High_CH



N78(60M)_DFT-s-OFDM_QPSK_Edge_1RB_Left_High_CH



N78(100M)_DFT-s-OFDM_BPSK_Edge_1RB_Left_Low_CH



N78(100M)_DFT-s-OFDM_BPSK_Edge_1RB_Left_Low_CH

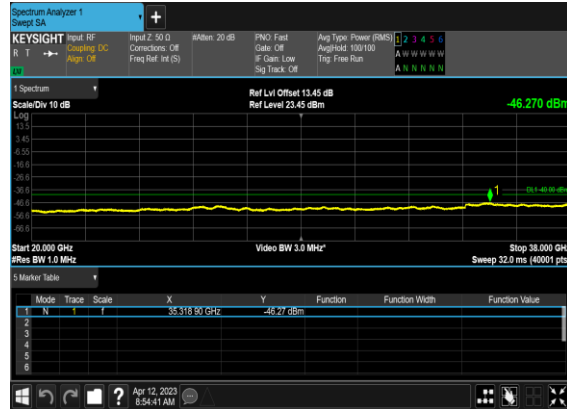

N78(100M)_DFT-s-OFDM_QPSK_Edge_1RB_Left_Low_CH

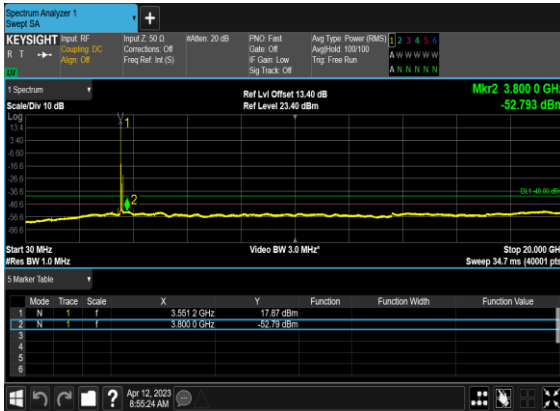

N78(100M)_DFT-s-OFDM_QPSK_Edge_1RB_Left_Low_CH

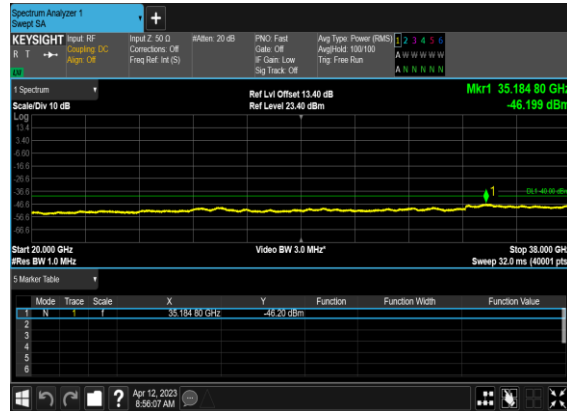

N78(100M)_DFT-s-OFDM_BPSK_Edge_1RB_Left_Mid_CH

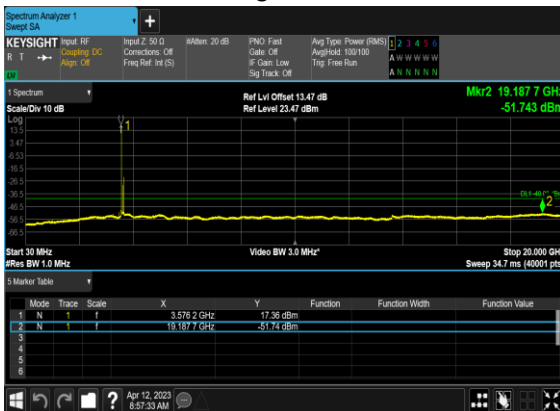

N78(100M)_DFT-s-OFDM_BPSK_Edge_1RB_Left_Mid_CH

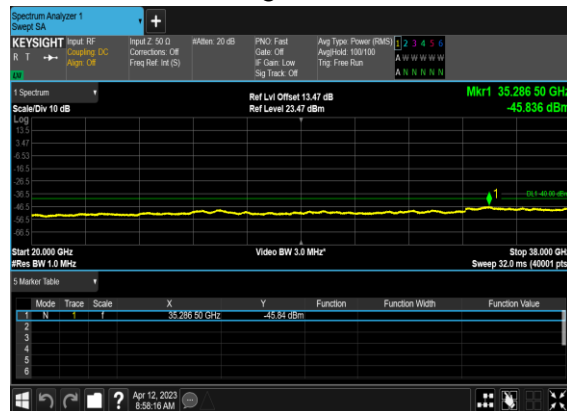

N78(100M)_DFT-s-OFDM_QPSK_Edge_1RB_Left_Mid_CH

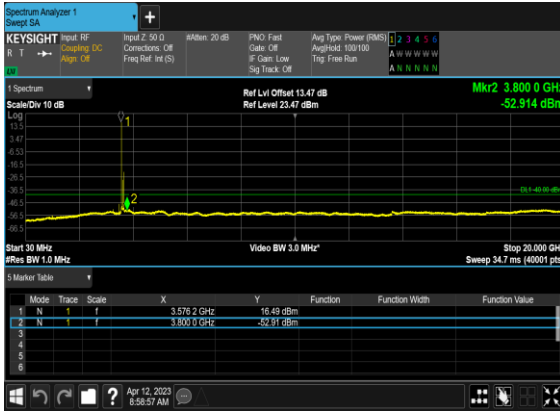

N78(100M)_DFT-s-OFDM_QPSK_Edge_1RB_Left_Mid_CH

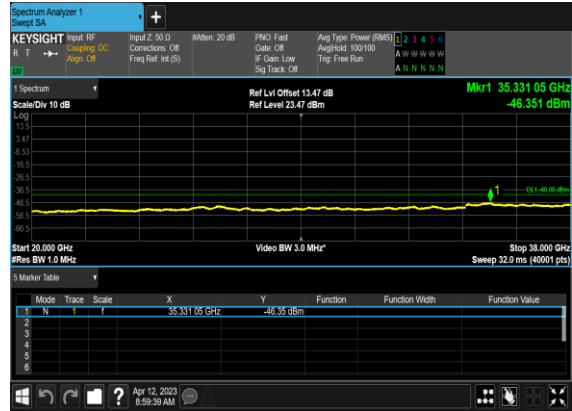

N78(100M)_DFT-s-OFDM_BPSK_Edge_1RB_Left_High_CH

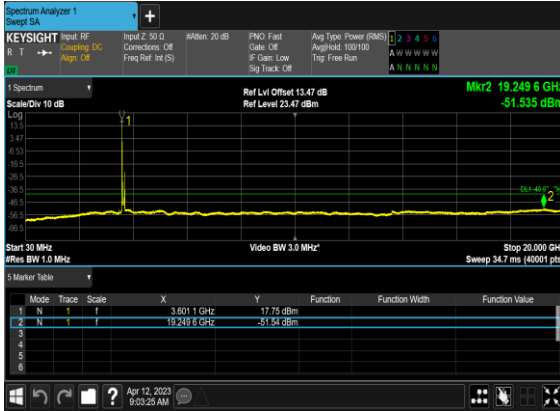

N78(100M)_DFT-s-OFDM_BPSK_Edge_1RB_Left_High_CH

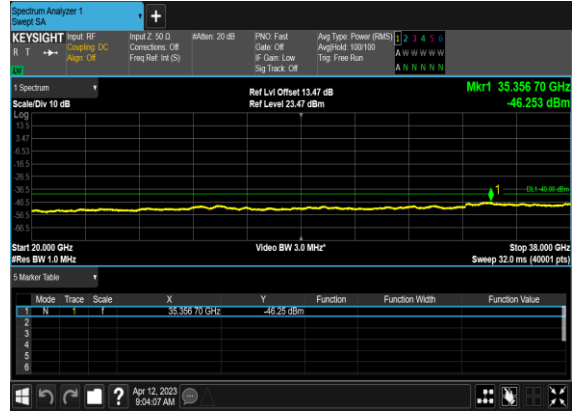

N78(100M)_DFT-s-OFDM_QPSK_Edge_1RB_Left_High_CH

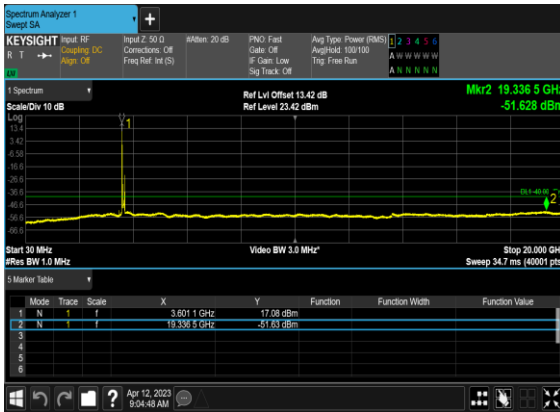

N78(100M)_DFT-s-OFDM_QPSK_Edge_1RB_Left_High_CH

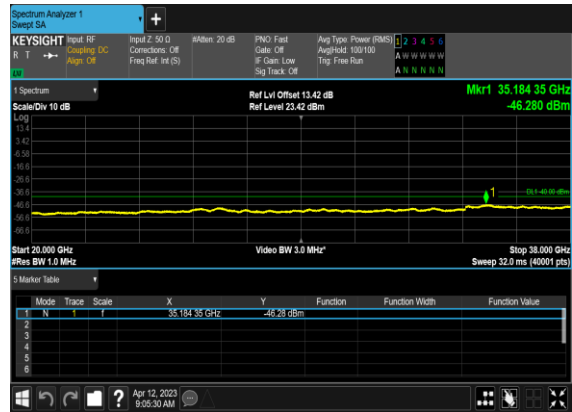

Conducted Band Edge

NR Band	SCS (kHz)	Bandwidth (MHz)	Arfcn	Freq (MHz)	Modulation	RB	Result	Verdict
78	30	20	637334	3560.01	DFT-s-OFDM BPSK	1@0	see graph	PASS
78	30	20	637334	3560.01	DFT-s-OFDM QPSK	1@0	see graph	PASS
78	30	20	637334	3560.01	DFT-s-OFDM BPSK	1@50	see graph	PASS
78	30	20	637334	3560.01	DFT-s-OFDM QPSK	1@50	see graph	PASS
78	30	20	637334	3560.01	DFT-s-OFDM BPSK	50@0	see graph	PASS
78	30	20	637334	3560.01	DFT-s-OFDM QPSK	50@0	see graph	PASS
78	30	20	641666	3624.99	DFT-s-OFDM BPSK	1@0	see graph	PASS
78	30	20	641666	3624.99	DFT-s-OFDM QPSK	1@0	see graph	PASS
78	30	20	641666	3624.99	DFT-s-OFDM BPSK	1@50	see graph	PASS
78	30	20	641666	3624.99	DFT-s-OFDM QPSK	1@50	see graph	PASS
78	30	20	641666	3624.99	DFT-s-OFDM BPSK	50@0	see graph	PASS
78	30	20	641666	3624.99	DFT-s-OFDM QPSK	50@0	see graph	PASS
78	30	20	646000	3690.0	DFT-s-OFDM BPSK	1@0	see graph	PASS
78	30	20	646000	3690.0	DFT-s-OFDM QPSK	1@0	see graph	PASS
78	30	20	646000	3690.0	DFT-s-OFDM BPSK	1@50	see graph	PASS
78	30	20	646000	3690.0	DFT-s-OFDM QPSK	1@50	see graph	PASS
78	30	20	646000	3690.0	DFT-s-OFDM BPSK	50@0	see graph	PASS
78	30	20	646000	3690.0	DFT-s-OFDM QPSK	50@0	see graph	PASS
78	30	60	638668	3580.02	DFT-s-OFDM BPSK	1@0	see graph	PASS
78	30	60	638668	3580.02	DFT-s-OFDM QPSK	1@0	see graph	PASS
78	30	60	638668	3580.02	DFT-s-OFDM BPSK	1@161	see graph	PASS
78	30	60	638668	3580.02	DFT-s-OFDM QPSK	1@161	see graph	PASS
78	30	60	638668	3580.02	DFT-s-OFDM BPSK	162@0	see graph	PASS

78	30	60	638668	3580.02	DFT-s-OFDM QPSK	162@0	see graph	PASS
78	30	60	641666	3624.99	DFT-s-OFDM BPSK	1@0	see graph	PASS
78	30	60	641666	3624.99	DFT-s-OFDM QPSK	1@0	see graph	PASS
78	30	60	641666	3624.99	DFT-s-OFDM BPSK	1@161	see graph	PASS
78	30	60	641666	3624.99	DFT-s-OFDM QPSK	1@161	see graph	PASS
78	30	60	641666	3624.99	DFT-s-OFDM BPSK	162@0	see graph	PASS
78	30	60	641666	3624.99	DFT-s-OFDM QPSK	162@0	see graph	PASS
78	30	60	644666	3669.99	DFT-s-OFDM BPSK	1@0	see graph	PASS
78	30	60	644666	3669.99	DFT-s-OFDM QPSK	1@0	see graph	PASS
78	30	60	644666	3669.99	DFT-s-OFDM BPSK	1@161	see graph	PASS
78	30	60	644666	3669.99	DFT-s-OFDM QPSK	1@161	see graph	PASS
78	30	60	644666	3669.99	DFT-s-OFDM BPSK	162@0	see graph	PASS
78	30	60	644666	3669.99	DFT-s-OFDM QPSK	162@0	see graph	PASS
78	30	100	640000	3600.0	DFT-s-OFDM BPSK	1@0	see graph	PASS
78	30	100	640000	3600.0	DFT-s-OFDM QPSK	1@0	see graph	PASS
78	30	100	640000	3600.0	DFT-s-OFDM BPSK	1@272	see graph	PASS
78	30	100	640000	3600.0	DFT-s-OFDM QPSK	1@272	see graph	PASS
78	30	100	640000	3600.0	DFT-s-OFDM BPSK	270@0	see graph	PASS
78	30	100	640000	3600.0	DFT-s-OFDM QPSK	270@0	see graph	PASS
78	30	100	641666	3624.99	DFT-s-OFDM BPSK	1@0	see graph	PASS
78	30	100	641666	3624.99	DFT-s-OFDM QPSK	1@0	see graph	PASS
78	30	100	641666	3624.99	DFT-s-OFDM BPSK	1@272	see graph	PASS
78	30	100	641666	3624.99	DFT-s-OFDM QPSK	1@272	see graph	PASS
78	30	100	641666	3624.99	DFT-s-OFDM BPSK	270@0	see graph	PASS
78	30	100	641666	3624.99	DFT-s-OFDM	270@0	see graph	PASS

QPSK								
78	30	100	643332	3649.98	DFT-s-OFDM BPSK	1@0	see graph	PASS
78	30	100	643332	3649.98	DFT-s-OFDM QPSK	1@0	see graph	PASS
78	30	100	643332	3649.98	DFT-s-OFDM BPSK	1@272	see graph	PASS
78	30	100	643332	3649.98	DFT-s-OFDM QPSK	1@272	see graph	PASS
78	30	100	643332	3649.98	DFT-s-OFDM BPSK	270@0	see graph	PASS
78	30	100	643332	3649.98	DFT-s-OFDM QPSK	270@0	see graph	PASS

N78(20M)_DFT-s-OFDM_BPSK_Edge_1RB_Left_Low_CH

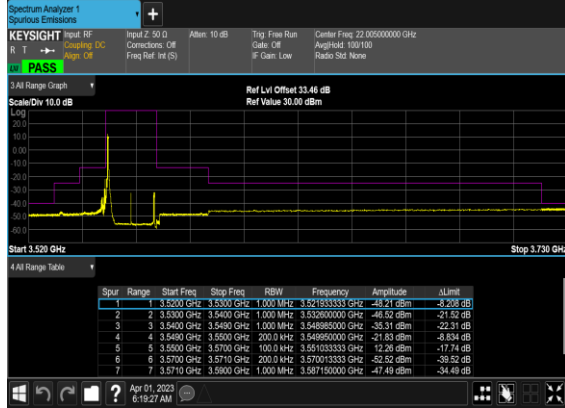

N78(20M)_DFT-s-OFDM_QPSK_Edge_1RB_Left_Low_CH

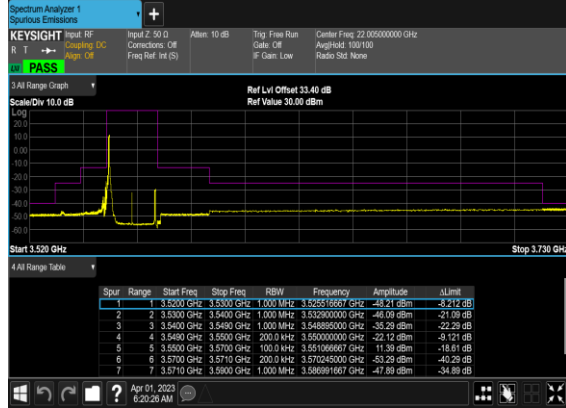

N78(20M)_DFT-s-OFDM_BPSK_Edge_1RB_Right_Low_CH

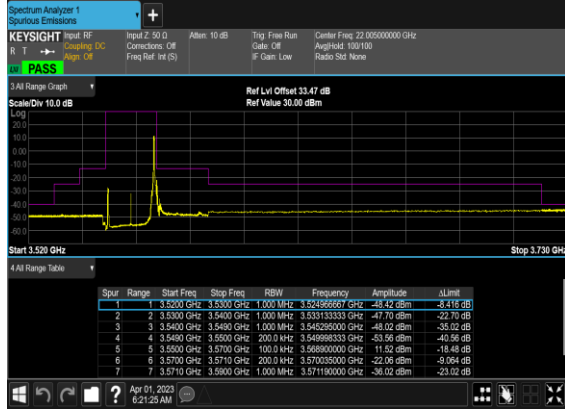

N78(20M)_DFT-s-OFDM_QPSK_Edge_1RB_Right_Low_CH

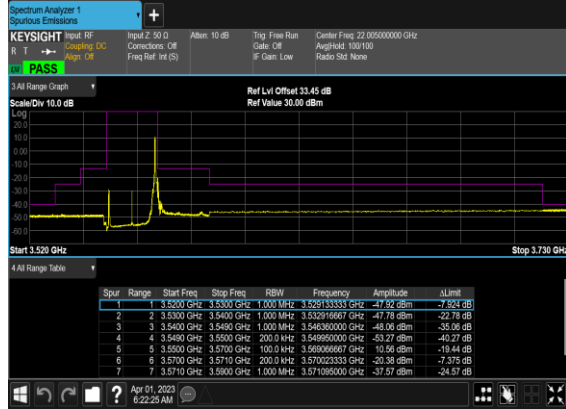

N78(20M)_DFT-s-OFDM_BPSK_Outer_Full_Low_CH

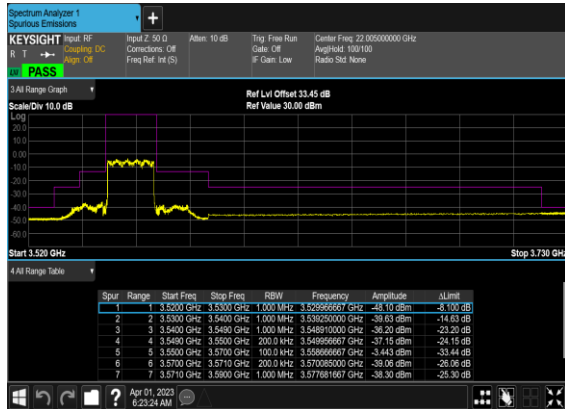

N78(20M)_DFT-s-OFDM_QPSK_Outer_Full_Low_CH

