



# FCC RF Test Report

**APPLICANT** : Lenovo (Shanghai) Electronics Technology Co., Ltd.  
**EQUIPMENT** : Portable Tablet Computer  
**BRAND NAME** : Lenovo  
**MODEL NAME** : TB300XU  
**FCC ID** : O57TB300XU  
**STANDARD** : 47 CFR Part 2, 22(H), 24(E), 27(L), 27(M)  
**CLASSIFICATION** : PCS Licensed Transmitter Held to Ear (PCE)  
**TEST DATE(S)** : Aug. 18, 2022 ~ Sep. 04, 2022

We, Sporton International Inc. (Kunshan), would like to declare that the tested sample has been evaluated in accordance with the procedures given in ANSI C63.26-2015 and shown compliance with the applicable technical standards.

The test results in this report apply exclusively to the tested model / sample. Without written approval of Sporton International Inc. (Kunshan), the test report shall not be reproduced except in full.

Jason Jia

Approved by: Jason Jia



**Sporton International Inc. (Kunshan)**

**No. 1098, Pengxi North Road, Kunshan Economic Development Zone Jiangsu Province 215300  
People's Republic of China**



TABLE OF CONTENTS

REVISION HISTORY...3
SUMMARY OF TEST RESULT...4
1 GENERAL DESCRIPTION...5
1.1 Applicant...5
1.2 Manufacturer...5
1.3 Product Feature of Equipment Under Test...5
1.4 Product Specification of Equipment Under Test...5
1.5 Modification of EUT...6
1.6 Maximum ERP/EIRP Power and Emission Designator...7
1.7 Testing Location...8
1.8 Test Software...8
1.9 Applicable Standards...8
2 TEST CONFIGURATION OF EQUIPMENT UNDER TEST...9
2.1 Test Mode...9
2.2 Connection Diagram of Test System...11
2.3 Support Unit used in test configuration and system...11
2.4 Measurement Results Explanation Example...11
2.5 Frequency List of Low/Middle/High Channels...12
3 CONDUCTED TEST ITEMS...15
3.1 Measuring Instruments...15
3.2 Test Setup...15
3.3 Test Result of Conducted Test...15
3.4 Conducted Output Power and ERP/EIRP...16
3.5 Peak-to-Average Ratio...17
3.6 Occupied Bandwidth...18
3.7 Conducted Band Edge...19
3.8 Conducted Spurious Emission...21
3.9 Frequency Stability...22
4 RADIATED TEST ITEMS...23
4.1 Measuring Instruments...23
4.2 Test Setup...23
4.3 Test Result of Radiated Test...24
4.4 Radiated Spurious Emission...25
5 LIST OF MEASURING EQUIPMENT...26
6 UNCERTAINTY OF EVALUATION...27
APPENDIX A. TEST RESULTS OF CONDUCTED TEST
APPENDIX B. TEST RESULTS OF RADIATED TEST
APPENDIX C. TEST SETUP PHOTOGRAPHS



### REVISION HISTORY

REPORT NO.	VERSION	DESCRIPTION	ISSUED DATE
FG272505-01B	Rev. 01	Initial issue of report	Sep. 20, 2022



## SUMMARY OF TEST RESULT

Report Section	FCC Rule	Description	Limit	Result	Remark
3.4	§2.1046	Conducted Output Power	-	Report Only	-
	§22.913(a)(5)	Effective Radiated Power (Band 5) (Band 26)	ERP < 7 Watt	PASS	-
	§24.232(c) §27.50(h)(2)	Equivalent Isotropic Radiated Power (Band 2)(Band 7) (Band 38) (Band 41)	EIRP < 2Watt		-
	§27.50(d)(4)	Equivalent Isotropic Radiated Power (Band 4)	EIRP < 1Watt		-
3.5	§24.232(d)	Peak-to-Average Ratio	<13 dB	PASS	-
3.6	§2.1049	Occupied Bandwidth	-	Report Only	-
3.7	§2.1051 §22.917(a) §24.238(a) §27.53(h)	Conducted Band Edge Measurement (Band 2) (Band 4) (Band 5)(Band 26)	< 43+10log10(P[Watts])	PASS	-
	§27.53(m)(4)	Conducted Band Edge Measurement (Band 7) (Band 38) (Band 41)	§27.53(m)(4)		
3.8	§2.1051 §22.917(a) §24.238(a) §27.53(h)	Conducted Spurious Emission (Band 2) (Band 4) (Band 5)(Band 26)	< 43+10log10(P[Watts])	PASS	-
	§2.1051 §27.53(m)(4)	Conducted Spurious Emission (Band 7) (Band 38) (Band 41)	< 55+10log <sub>10</sub> (P[Watts])		
3.9	§2.1055 §22.355	Frequency Stability Temperature & Voltage	< 2.5 ppm for Part 22	PASS	-
	§2.1055 §24.235 §27.54		Within Authorized Band		
4.4	§2.1053 §22.917(a) §24.238(a) §27.53(h)	Radiated Spurious Emission (Band 2) (Band 4) (Band 5)(Band 26)	< 43+10log <sub>10</sub> (P[Watts])	PASS	Under limit 26.73 dB at 7576.000 MHz
	§2.1053 §27.53(m)(4)	Radiated Spurious Emission (Band 7) (Band 38) (Band 41)	< 55+10log <sub>10</sub> (P[Watts])		

**Declaration of Conformity:**

The test results with all measurement uncertainty excluded are presented in accordance with the regulation limits or requirements declared by manufacturers.

**Comments and Explanations:**

The declared of product specification for EUT presented in the report are provided by the manufacturer, and the manufacturer takes all the responsibilities for the accuracy of product specification.



# 1 General Description

## 1.1 Applicant

Lenovo (Shanghai) Electronics Technology Co., Ltd.

Section 304-305, Building No. 4, # 222, Meiyue Road, China (Shanghai) Pilot Free Trade Zone

## 1.2 Manufacturer

Lenovo PC HK Limited

23/F, Lincoln House, Taikoo Place 979 King's Road, Quarry Bay, Hong Kong, China

## 1.3 Product Feature of Equipment Under Test

Product Feature	
Equipment	Portable Tablet Computer
Brand Name	Lenovo
Model Name	TB300XU
FCC ID	O57TB300XU
IMEI Code	Conducted: 863270060008336/863270060008378 Radiation: 863270060007528
HW Version	Lenovo Tablet TB300XU
SW Version	TB300XU_RF01_220809
EUT Stage	Identical Prototype

## 1.4 Product Specification of Equipment Under Test

Standards-related Product Specification	
Tx Frequency	LTE Band 2 : 1850 MHz ~ 1910 MHz LTE Band 4 : 1710 MHz ~ 1755 MHz LTE Band 5 : 824 MHz ~ 849 MHz LTE Band 7 : 2500 MHz ~ 2570 MHz LTE Band 26 : 824 MHz ~ 849 MHz LTE Band 38 : 2570 MHz ~ 2620 MHz LTE Band 41 : 2496 MHz ~ 2690 MHz
Rx Frequency	LTE Band 2 : 1930 MHz ~ 1990 MHz LTE Band 4 : 2110 MHz ~ 2155 MHz LTE Band 5 : 869 MHz ~ 894 MHz LTE Band 7 : 2620 MHz ~ 2690 MHz LTE Band 26 : 869 MHz ~ 894 MHz LTE Band 38 : 2570 MHz ~ 2620 MHz LTE Band 41 : 2496 MHz ~ 2690 MHz
Bandwidth	LTE Band 2 : 1.4MHz / 3MHz / 5MHz / 10MHz / 15MHz / 20MHz LTE Band 4 : 1.4MHz / 3MHz / 5MHz / 10MHz / 15MHz / 20MHz LTE Band 5 : 1.4MHz / 3MHz / 5MHz / 10MHz LTE Band 7 : 5MHz / 10MHz / 15MHz / 20MHz LTE Band 26 : 1.4MHz / 3MHz / 5MHz / 10MHz / 15MHz



	LTE Band 38 : 5MHz / 10MHz / 15MHz / 20MHz LTE Band 41 : 5MHz / 10MHz / 15MHz / 20MHz
<b>Maximum Output Power to Antenna</b>	LTE Band 2 : 22.99 dBm LTE Band 4 : 23.36 dBm LTE Band 5 : 23.33 dBm LTE Band 7 : 23.58 dBm LTE Band 26 : 23.39 dBm LTE Band 38 : 23.46 dBm LTE Band 41 : 23.53 dBm
<b>Antenna Gain</b>	LTE Band 2 : -1.1 dBi LTE Band 4 : -1.2 dBi LTE Band 5 : -2.5 dBi LTE Band 7 : -0.2 dBi LTE Band 26 : -2.5 dBi LTE Band 38 : -0.2 dBi LTE Band 41 : -0.2 dBi
<b>Type of Modulation</b>	QPSK / 16QAM / 64QAM

### 1.5 Modification of EUT

No modifications are made to the EUT during all test items.



### 1.6 Maximum ERP/EIRP Power and Emission Designator

LTE Band 2		QPSK		16QAM/64QAM	
BW (MHz)	Frequency Range (MHz)	Maximum EIRP(W)	Emission Designator (99%OBW)	Maximum EIRP(W)	Emission Designator (99%OBW)
20	1860.0 ~ 1900.0	0.1545	17M9G7D	0.1186	17M9W7D
LTE Band 4		QPSK		16QAM/64QAM	
BW (MHz)	Frequency Range (MHz)	Maximum EIRP(W)	Emission Designator (99%OBW)	Maximum EIRP(W)	Emission Designator (99%OBW)
20	1720.0 ~ 1745.0	0.1644	18M0G7D	0.1250	17M9W7D
LTE Band 5		QPSK		16QAM/64QAM	
BW (MHz)	Frequency Range (MHz)	Maximum ERP(W)	Emission Designator (99%OBW)	Maximum ERP(W)	Emission Designator (99%OBW)
10	829.0 ~ 844.0	0.0738	9M01G7D	0.0558	9M05W7D
LTE Band 7		QPSK		16QAM/64QAM	
BW (MHz)	Frequency Range (MHz)	Maximum EIRP(W)	Emission Designator (99%OBW)	Maximum EIRP(W)	Emission Designator (99%OBW)
20	2510.0 ~ 2560.0	0.2178	17M9G7D	0.1585	17M9W7D
LTE Band 26		QPSK		16QAM/64QAM	
BW (MHz)	Frequency Range (MHz)	Maximum ERP(W)	Emission Designator (99%OBW)	Maximum ERP(W)	Emission Designator (99%OBW)
15	831.5 ~ 841.5	0.0748	13M5G7D	0.0573	13M5W7D
CH26790	824	0.0684	13M4G7D	0.0485	13M4W7D
LTE Band 38		QPSK		16QAM/64QAM	
BW (MHz)	Frequency Range (MHz)	Maximum EIRP(W)	Emission Designator (99%OBW)	Maximum EIRP(W)	Emission Designator (99%OBW)
20	2580.0 ~ 2610.0	0.2118	17M9G7D	0.1560	17M9W7D
LTE Band 41		QPSK		16QAM/64QAM	
BW (MHz)	Frequency Range (MHz)	Maximum EIRP(W)	Emission Designator (99%OBW)	Maximum EIRP(W)	Emission Designator (99%OBW)
20	2506.0 ~ 2680.0	0.2153	17M9G7D	0.1556	17M9W7D

**Note:**

1. LTE Band 26 overlaps the entire frequency range of LTE Band 5. Therefore, the test results provided in this report covers Band 5 and the portion of Band 26 subject to Part 22.
2. LTE Band 41 overlaps the entire frequency range of LTE Band 38. Therefore, the test results provided in this report covers Band 41 as well as Band 38.



### 1.7 Testing Location

Sporton International Inc. (Kunshan) is accredited to ISO/IEC 17025:2017 by American Association for Laboratory Accreditation with Certificate Number 5145.02.

<b>Test Firm</b>	Sporton International Inc. (Kunshan)		
<b>Test Site Location</b>	No. 1098, Pengxi North Road, Kunshan Economic Development Zone Jiangsu Province 215300 People's Republic of China TEL : +86-512-57900158 FAX : +86-512-57900958		
<b>Test Site No.</b>	<b>Sporton Site No.</b>	<b>FCC Designation No.</b>	<b>FCC Test Firm Registration No.</b>
	03CH04-KS TH01-KS	CN1257	314309

### 1.8 Test Software

Item	Site	Manufacture	Name	Version
1.	03CH04-KS	AUDIX	E3	6.2009-8-24a

### 1.9 Applicable Standards

According to the specifications of the manufacturer, the EUT must comply with the requirements of the following standards:

- ♦ 47 CFR Part 2, 22(H), 24(E), 27(L), 27(M)
- ♦ ANSI C63.26-2015
- ♦ FCC KDB 971168 D01 Power Meas License Digital Systems v03r01
- ♦ FCC KDB 412172 D01 Determining ERP and EIRP v01r01

**Remark:**

1. All test items were verified and recorded according to the standards and without any deviation during the test.
2. This EUT has also been tested and complied with the requirements of FCC Part 15, Subpart B, recorded in a separate test report.





## 2 Test Configuration of Equipment Under Test

### 2.1 Test Mode

Antenna port conducted and radiated test items listed below are performed according to KDB 971168 D01 Power Meas License Digital Systems v03r01 with maximum output power.

Radiated measurements are performed by rotating the EUT in three different orthogonal test planes to find the maximum emission.

Test Items	Band	Bandwidth (MHz)						Modulation			RB #			Test Channel		
		1.4	3	5	10	15	20	QPSK	16QA M	64QA M	1	Half	Full	L	M	H
Max. Output Power	2	v	v	v	v	v	v	v	v	v	v		v	v	v	v
	4	v	v	v	v	v	v	v	v	v	v		v	v	v	v
	5	v	v	v	v	-	-	v	v	v	v		v	v	v	v
	7	-	-	v	v	v	v	v	v	v	v		v	v	v	v
	26	v	v	v	v	v	-	v	v	v	v		v	v	v	v
	38	-	-	v	v	v	v	v	v	v	v		v	v	v	v
	41	-	-	v	v	v	v	v	v	v	v		v	v	v	v
Peak-to-Average Ratio	2						v	v	v	v			v		v	
	4						v	v	v	v			v		v	
	7	-	-				v	v	v	v			v		v	
	26					v	-	v	v	v			v		v	
	41	-	-				v	v	v	v			v		v	
26dB and 99% Bandwidth	2						v	v	v				v		v	
	4						v	v	v				v		v	
	7	-	-				v	v	v				v		v	
	26				v	v	-	v	v				v	v	v	v
	41	-	-				v	v	v				v		v	
Conducted Band Edge	2	v	v	v	v	v	v	v	v	v	v		v	v		v
	4	v	v	v	v	v	v	v	v	v	v		v	v		v
	7	-	-	v	v	v	v	v	v	v	v		v	v		v
	26	v	v	v	v	v	-	v	v	v	v		v	v		v
	41	-	-	v	v	v	v	v	v	v	v		v	v		v



Test Items	Band	Bandwidth (MHz)						Modulation			RB #			Test Channel		
		1.4	3	5	10	15	20	QPSK	16QAM	64QAM	1	Half	Full	L	M	H
Conducted Spurious Emission	2	v	v	v	v	v	v	v			v			v	v	v
	4	v	v	v	v	v	v	v			v			v	v	v
	7	-	-	v	v	v	v	v			v			v	v	v
	26	v	v	v	v	v	-	v			v			v	v	v
	41	-	-	v	v	v	v	v			v			v	v	v
Frequency Stability	2				v			v					v		v	
	4				v			v					v		v	
	7	-	-		v			v					v		v	
	26				v		-	v					v		v	
	41	-	-		v			v					v		v	
E.R.P / E.I.R.P	2	v	v	v	v	v	v	v	v	v	v		v	v	v	v
	4	v	v	v	v	v	v	v	v	v	v		v	v	v	v
	5	v	v	v	v	-	-	v	v	v	v		v	v	v	v
	7	-	-	v	v	v	v	v	v	v	v		v	v	v	v
	26	v	v	v	v	v	-	v	v	v	v		v	v	v	v
	38	-	-	v	v	v	v	v	v	v	v		v	v	v	v
	41	-	-	v	v	v	v	v	v	v	v		v	v	v	v
Radiated Spurious Emission	2	Worst Case													v	
	4	Worst Case													v	
	7	Worst Case													v	
	26	Worst Case													v	
	41	Worst Case													v	
Note	<ol style="list-style-type: none"> <li>The mark "v" means that this configuration is chosen for testing</li> <li>The mark "-" means that this bandwidth is not supported.</li> <li>The device is investigated from 30MHz to 10 times of fundamental signal for radiated spurious emission test under different RB size/offset and modulations in exploratory test. Subsequently, only the worst case emissions are reported.</li> <li>LTE Band 26 overlaps the entire frequency range of LTE Band 5. Therefore, the test results provided in this report covers Band 5 and the portion of Band 26 subject to Part 22.</li> <li>LTE Band 41 overlaps the entire frequency range of LTE Band 38. Therefore, the test results provided in this report covers Band 41 as well as Band 38.</li> </ol>															

## 2.2 Connection Diagram of Test System

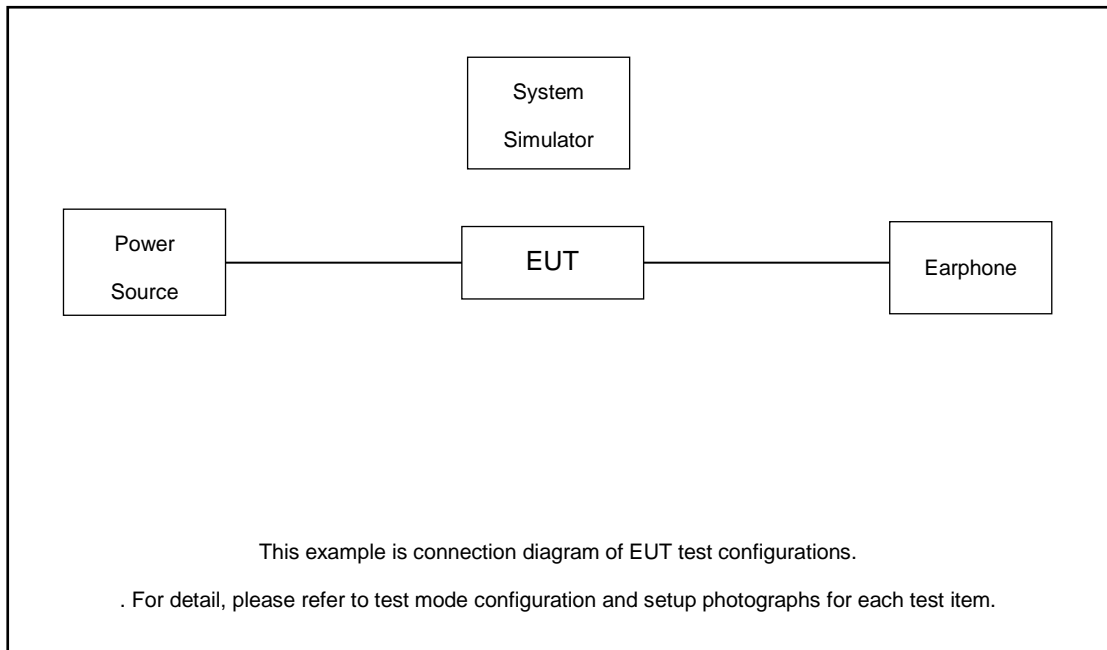

## 2.3 Support Unit used in test configuration and system

Item	Equipment	Trade Name	Model No.	FCC ID	Data Cable	Power Cord
1.	Power Supply	GWINSTEK	PSS-2002	N/A	N/A	Unshielded, 1.8 m
2.	LTE Base Station	Anritsu	MT8820C	N/A	N/A	Unshielded, 1.8 m
3.	Earphone	N/A	N/A	N/A	N/A	N/A

## 2.4 Measurement Results Explanation Example

### For all conducted test items:

The offset level is set in the spectrum analyzer to compensate the RF cable loss between EUT conducted output port and spectrum analyzer. With the offset compensation, the spectrum analyzer reading level is exactly the EUT RF output level.

The spectrum analyzer offset is derived from RF cable loss.

*Offset = RF cable loss.*

Following shows an offset computation example with cable loss 5.4 dB.

Example :

$$\text{Offset(dB)} = \text{RF cable loss(dB)} \\ = 5.4(\text{dB})$$



### 2.5 Frequency List of Low/Middle/High Channels

LTE Band 2 Channel and Frequency List				
BW [MHz]	Channel/Frequency(MHz)	Lowest	Middle	Highest
20	Channel	18700	18900	19100
	Frequency	1860	1880	1900
15	Channel	18675	18900	19125
	Frequency	1857.5	1880	1902.5
10	Channel	18650	18900	19150
	Frequency	1855	1880	1905
5	Channel	18625	18900	19175
	Frequency	1852.5	1880	1907.5
3	Channel	18615	18900	19185
	Frequency	1851.5	1880	1908.5
1.4	Channel	18607	18900	19193
	Frequency	1850.7	1880	1909.3

LTE Band 4 Channel and Frequency List				
BW [MHz]	Channel/Frequency(MHz)	Lowest	Middle	Highest
20	Channel	20050	20175	20300
	Frequency	1720	1732.5	1745
15	Channel	20025	20175	20325
	Frequency	1717.5	1732.5	1747.5
10	Channel	20000	20175	20350
	Frequency	1715	1732.5	1750
5	Channel	19975	20175	20375
	Frequency	1712.5	1732.5	1752.5
3	Channel	19965	20175	20385
	Frequency	1711.5	1732.5	1753.5
1.4	Channel	19957	20175	20393
	Frequency	1710.7	1732.5	1754.3



LTE Band 5 Channel and Frequency List				
BW [MHz]	Channel/Frequency(MHz)	Lowest	Middle	Highest
10	Channel	20450	20525	20600
	Frequency	829	836.5	844
5	Channel	20425	20525	20625
	Frequency	826.5	836.5	846.5
3	Channel	20415	20525	20635
	Frequency	825.5	836.5	847.5
1.4	Channel	20407	20525	20643
	Frequency	824.7	836.5	848.3

LTE Band 7 Channel and Frequency List				
BW [MHz]	Channel/Frequency(MHz)	Lowest	Middle	Highest
20	Channel	20850	21100	21350
	Frequency	2510	2535	2560
15	Channel	20825	21100	21375
	Frequency	2507.5	2535	2562.5
10	Channel	20800	21100	21400
	Frequency	2505	2535	2565
5	Channel	20775	21100	21425
	Frequency	2502.5	2535	2567.5

LTE Band 26 Channel and Frequency List				
BW [MHz]	Channel/Frequency(MHz)	Lowest	Middle	Highest
15	Channel	26865	26915	26965
	Frequency	831.5	836.5	841.5
10	Channel	26840	26915	26990
	Frequency	829	836.5	844
5	Channel	26815	26915	27015
	Frequency	826.5	836.5	846.5
3	Channel	26805	26915	27025
	Frequency	825.5	836.5	847.5
1.4	Channel	26797	26915	27033
	Frequency	824.7	836.5	848.3



LTE Band 26 Cross-rule Channel and Frequency List				
BW [MHz]	Channel/Frequency(MHz)	-	Middle	-
15	Channel	-	26790	-
	Frequency	-	824	-
10	Channel	-	26790	-
	Frequency	-	824	-
5	Channel	-	26790	-
	Frequency	-	824	-
3	Channel	-	26790	-
	Frequency	-	824	-
1.4	Channel	-	26790	-
	Frequency	-	824	-

LTE Band 38 Channel and Frequency List				
BW [MHz]	Channel/Frequency(MHz)	Lowest	Middle	Highest
20	Channel	37850	38000	38150
	Frequency	2580	2595	2610
15	Channel	37825	38000	38175
	Frequency	2577.5	2595	2612.5
10	Channel	37800	38000	38200
	Frequency	2575	2595	2615
5	Channel	37775	38000	38225
	Frequency	2572.5	2595	2617.5

LTE Band 41 Channel and Frequency List				
BW [MHz]	Channel/Frequency(MHz)	Lowest	Middle	Highest
20	Channel	39750	40620	41490
	Frequency	2506	2593	2680
15	Channel	39725	40620	41515
	Frequency	2503.5	2593	2682.5
10	Channel	39700	40620	41540
	Frequency	2501	2593	2685
5	Channel	39675	40620	41565
	Frequency	2498.5	2593	2687.5

### 3 Conducted Test Items

#### 3.1 Measuring Instruments

See list of measuring instruments of this test report.

#### 3.2 Test Setup

##### 3.2.1 Conducted Output Power



##### 3.2.2 Peak-to-Average Ratio, Occupied Bandwidth ,Conducted Band-Edge and Conducted Spurious Emission

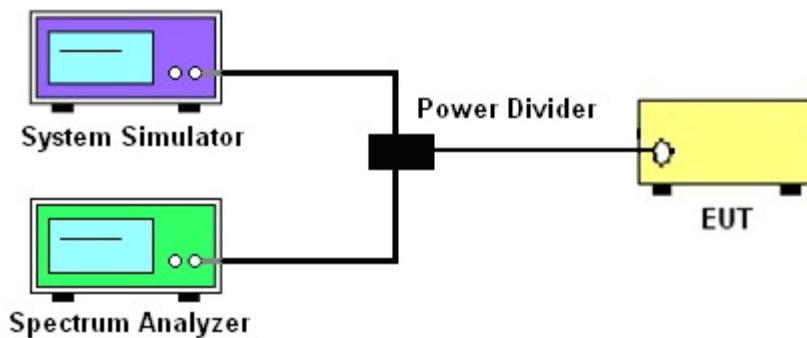

##### 3.2.3 Frequency Stability



### 3.3 Test Result of Conducted Test

Please refer to Appendix A.



### 3.4 Conducted Output Power and ERP/EIRP

#### 3.4.1 Description of the Conducted Output Power Measurement and ERP/EIRP Measurement

A system simulator was used to establish communication with the EUT. Its parameters were set to force the EUT transmitting at maximum output power. The measured power in the radio frequency on the transmitter output terminals shall be reported.

The ERP of mobile transmitters must not exceed 7 Watts for LTE Band 5 and Band 26.

The EIRP of mobile transmitters must not exceed 2 Watts for LTE Band 2 and Band 7 and Band 38 and Band 41.

The EIRP of mobile transmitters must not exceed 1 Watts for LTE Band 4.

According to KDB 412172 D01 Power Approach,

$EIRP = P_T + G_T - L_C$ ,  $ERP = EIRP - 2.15$ , where

$P_T$  = transmitter output power in dBm

$G_T$  = gain of the transmitting antenna in dBi

$L_C$  = signal attenuation in the connecting cable between the transmitter and antenna in dB

#### 3.4.2 Test Procedures

1. The testing follows ANSI C63.26 Section 5.2
2. The transmitter output port was connected to the system simulator.
3. Set EUT at maximum power through the system simulator.
4. Select lowest, middle, and highest channels for each band and different modulation.
5. Measure and record the power level from the system simulator.





## 3.5 Peak-to-Average Ratio

### 3.5.1 Description of the PAR Measurement

Power Complementary Cumulative Distribution Function (CCDF) curves provide a means for characterizing the power peaks of a digitally modulated signal on a statistical basis. A CCDF curve depicts the probability of the peak signal amplitude exceeding the average power level. Most contemporary measurement instrumentation include the capability to produce CCDF curves for an input signal provided that the instrument's resolution bandwidth can be set wide enough to accommodate the entire input signal bandwidth. In measuring transmissions in this band using an average power technique, the peak-to-average ratio (PAR) of the transmission may not exceed 13 dB.

### 3.5.2 Test Procedures

1. The testing follows ANSI C63.26 Section 5.2.3.4 (CCDF).
2. The EUT was connected to spectrum and system simulator via a power divider.
3. Set the CCDF (Complementary Cumulative Distribution Function) option in spectrum analyzer.
4. The highest RF powers were measured and recorded the maximum PAPR level associated with a probability of 0.1 %.
5. Record the deviation as Peak to Average Ratio.



### 3.6 Occupied Bandwidth

#### 3.6.1 Description of Occupied Bandwidth Measurement

The occupied bandwidth is the width of a frequency band such that, below the lower and above the upper frequency limits, the mean powers emitted are each equal to a specified percentage 0.5% of the total mean transmitted power.

The 26 dB emission bandwidth is defined as the frequency range between two points, one above and one below the carrier frequency, at which the spectral density of the emission is attenuated 26 dB below the maximum in-band spectral density of the modulated signal. Spectral density (power per unit bandwidth) is to be measured with a detector of resolution bandwidth equal to approximately 1.0% of the emission bandwidth.

#### 3.6.2 Test Procedures

1. The testing follows ANSI C63.26 Section 5.4
2. The EUT was connected to spectrum analyzer and system simulator via a power divider.
3. The spectrum analyzer center frequency is set to the nominal EUT channel center frequency. The span range for the spectrum analyzer shall be between two and five times the anticipated OBW.
4. The nominal resolution bandwidth (RBW) shall be in the range of 1 to 5 % of the anticipated OBW, and the VBW shall be at least 3 times the RBW.
5. Set the detection mode to peak, and the trace mode to max hold.
6. Determine the reference value: Set the EUT to transmit a modulated signal. Allow the trace to stabilize. Set the spectrum analyzer marker to the highest level of the displayed trace.  
(this is the reference value)
7. Determine the “-26 dB down amplitude” as equal to (Reference Value – X).
8. Place two markers, one at the lowest and the other at the highest frequency of the envelope of the spectral display such that each marker is at or slightly below the “-X dB down amplitude” determined in step 6. If a marker is below this “-X dB down amplitude” value it shall be placed as close as possible to this value. The OBW is the positive frequency difference between the two markers.
9. Use the 99 % power bandwidth function of the spectrum analyzer and report the measured bandwidth.



### 3.7 Conducted Band Edge

#### 3.7.1 Description of Conducted Band Edge Measurement

22.917(a)

For operations in the 824 – 849 MHz band, the FCC limit is  $43 + 10\log_{10}(P[\text{Watts}])$  dB below the transmitter power  $P(\text{Watts})$  in a 100kHz bandwidth. However, in the 1MHz bands immediately outside and adjacent to the licensee's frequency block, a resolution bandwidth of at least one percent of the emission bandwidth of the fundamental emission of the transmitter may be employed.

24.238 (a)

For operations in the 1850-1910 and 1930-1990 MHz band, the FCC limit is  $43 + 10\log_{10}(P[\text{Watts}])$  dB below the transmitter power  $P(\text{Watts})$  in a 1MHz bandwidth. However, in the 1 MHz bands immediately outside and adjacent to the frequency block a resolution bandwidth of at least one percent of the emission bandwidth of the fundamental emission of the transmitter may be employed.

27.53 (h)

For operations in the 1710 – 1755 MHz band, the FCC limit is  $43 + 10\log_{10}(P[\text{Watts}])$  dB below the transmitter power  $P(\text{Watts})$  in a 1 MHz bandwidth. However, in the 1MHz bands immediately outside and adjacent to the licensee's frequency block, a resolution bandwidth of at least one percent of the emission bandwidth of the fundamental emission of the transmitter may be employed.

27.53(m)(4)

For mobile digital stations, the attenuation factor shall be not less than  $40 + 10 \log (P)$  dB on all frequencies between the channel edge and 5 megahertz from the channel edge,  $43 + 10 \log (P)$  dB on all frequencies between 5 megahertz and X megahertz from the channel edge, and  $55 + 10 \log (P)$  dB on all frequencies more than X megahertz from the channel edge, where X is the greater of 6 megahertz or the actual emission bandwidth as defined in paragraph (m)(6) of this section. In addition, the attenuation factor shall not be less that  $43 + 10 \log (P)$  dB on all frequencies between 2490.5 MHz and 2496 MHz and  $55 + 10 \log (P)$  dB at or below 2490.5 MHz. Mobile Satellite Service licensees operating on frequencies below 2495 MHz may also submit a documented interference complaint against BRS licensees operating on channel BRS Channel 1 on the same terms and conditions as adjacent channel BRS or EBS licensees.



### 3.7.2 Test Procedures

1. The testing follows ANSI C63.26 section 5.7
2. The EUT was connected to spectrum analyzer and system simulator via a power divider.
3. The band edges of low and high channels for the highest RF powers were measured.
4. Set RBW  $\geq$  1% EBW in the 1MHz band immediately outside and adjacent to the band edge.
5. Beyond the 1 MHz band from the band edge, RBW=1MHz was used or a narrower RBW was used and the measured power was integrated over the full required measurement bandwidth of 1 MHz.
6. Set spectrum analyzer with RMS detector.
7. The RF fundamental frequency should be excluded against the limit line in the operating frequency band.
8. Checked that all the results comply with the emission limit line.

Example:

The limit line is derived from  $43 + 10\log(P)$ dB below the transmitter power P(Watts)  
= P(W)- [43 + 10log(P)] (dB)  
= [30 + 10log(P)] (dBm) - [43 + 10log(P)] (dB) = -13dBm.

9. For LTE Band 7, 38, 41, the other 40 dB, and 55 dB have additionally applied same calculation above.
10. When using the integration method, the starting frequency of the integration shall be centered at one-half of the RBW away from the band edge.



### 3.8 Conducted Spurious Emission

#### 3.8.1 Description of Conducted Spurious Emission Measurement

The power of any emission outside of the authorized operating frequency ranges must be lower than the transmitter power (P) by a factor of at least  $43 + 10 \log (P)$  dB.

For Band 7,38,41:

The power of any emission outside of the authorized operating frequency ranges must be lower than the transmitter power (P) by a factor of at least  $55 + 10 \log (P)$  dB.

It is measured by means of a calibrated spectrum analyzer and scanned from 30 MHz up to a frequency including its 10<sup>th</sup> harmonic.

#### 3.8.2 Test Procedures

1. The testing follows ANSI C63.26 section 5.7
2. The EUT was connected to spectrum analyzer and system simulator via a power divider.
3. The RF output of EUT was connected to the spectrum analyzer by RF cable and attenuator. The path loss was compensated to the results for each measurement.
4. The middle channel for the highest RF power within the transmitting frequency was measured.
5. The conducted spurious emission for the whole frequency range was taken.
6. Make the measurement with the spectrum analyzer's RBW = 1MHz, VBW = 3MHz.
7. Set spectrum analyzer with RMS detector.
8. Taking the record of maximum spurious emission.
9. The RF fundamental frequency should be excluded against the limit line in the operating frequency band.
10. The limit line is derived from  $43 + 10\log(P)$ dB below the transmitter power P(Watts)  
=  $P(W) - [43 + 10\log(P)]$  (dB)  
=  $[30 + 10\log(P)]$  (dBm) -  $[43 + 10\log(P)]$  (dB)  
= -13dBm.
11. For Band 7, 38, 41  
The limit line is derived from  $55 + 10\log(P)$ dB below the transmitter power P(Watts)  
=  $P(W) - [55 + 10\log(P)]$  (dB)  
=  $[30 + 10\log(P)]$  (dBm) -  $[55 + 10\log(P)]$  (dB)  
= -25dBm.



## 3.9 Frequency Stability

### 3.9.1 Description of Frequency Stability Measurement

The frequency stability shall be measured by variation of ambient temperature and variation of primary supply voltage to ensure that the fundamental emission stays within the authorized frequency block. The frequency stability of the transmitter shall be maintained within  $\pm 0.00025\%$  ( $\pm 2.5\text{ppm}$ ) of the center frequency.

### 3.9.2 Test Procedures for Temperature Variation

1. The testing follows ANSI C63.26 section 5.6.4
2. The EUT was set up in the thermal chamber and connected with the system simulator.
3. With power OFF, the temperature was decreased to  $-30^{\circ}\text{C}$  and the EUT was stabilized before testing. Power was applied and the maximum change in frequency was recorded within one minute.
4. With power OFF, the temperature was raised in  $10^{\circ}\text{C}$  step up to  $50^{\circ}\text{C}$ . The EUT was stabilized at each step for at least half an hour. Power was applied and the maximum frequency change was recorded within one minute.

### 3.9.3 Test Procedures for Voltage Variation

1. The testing follows ANSI C63.26 section 5.6.5
2. The EUT was placed in a temperature chamber at  $20\pm 5^{\circ}\text{C}$  and connected with the system simulator.
3. The power supply voltage to the EUT was varied from 85% to 115% of the nominal value for other than hand carried battery equipment.
4. For hand carried, battery powered equipment, reduce the primary ac or dc supply voltage to the battery operating end point, which shall be specified by the manufacturer.
5. The variation in frequency was measured for the worst case.

## 4 Radiated Test Items

### 4.1 Measuring Instruments

See list of measuring instruments of this test report.

### 4.2 Test Setup

#### 4.2.1 For radiated test below 30MHz

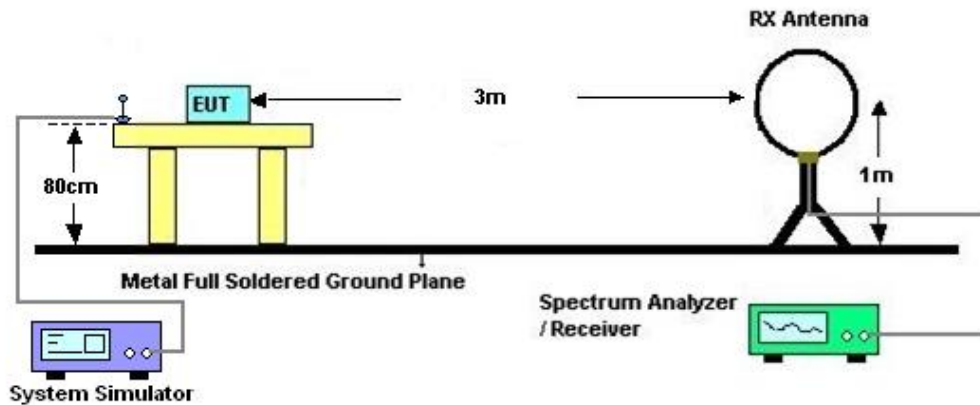

#### 4.2.2 For radiated test from 30MHz to 1GHz

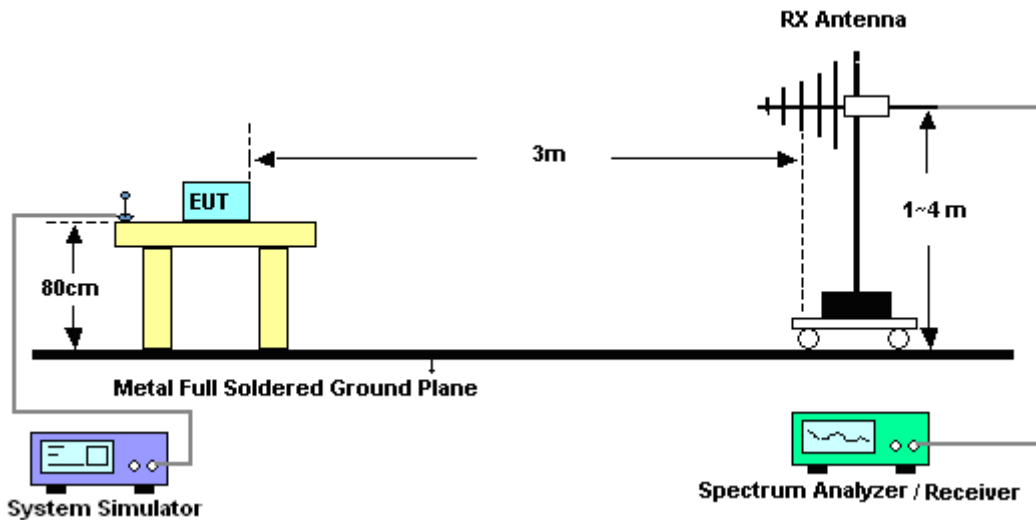

#### 4.2.3 For radiated test above 1GHz

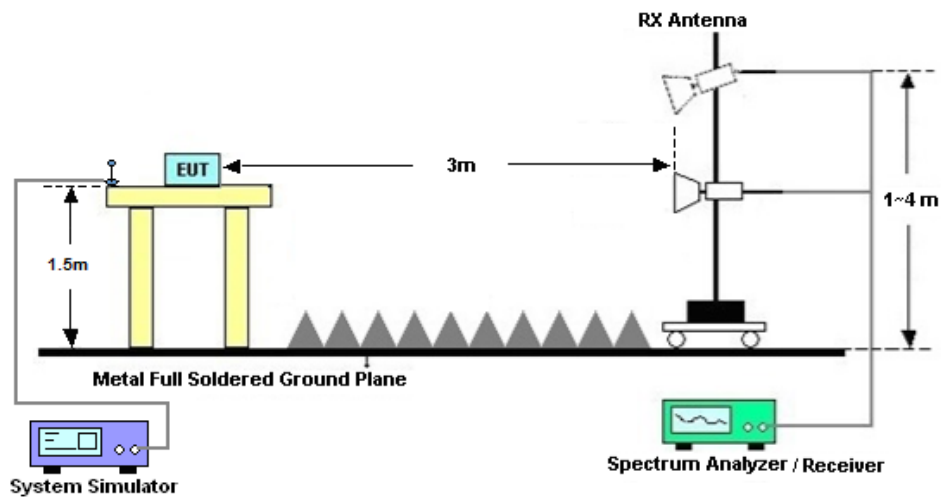

#### 4.3 Test Result of Radiated Test

The low frequency, which started from 9 kHz to 30MHz, was pre-scanned and the result which was 20dB lower than the limit line was not reported.

Please refer to Appendix B.





## 4.4 Radiated Spurious Emission

### 4.4.1 Description of Radiated Spurious Emission

The radiated spurious emission was measured by substitution method according to ANSI C63.26. The power of any emission outside of the authorized operating frequency ranges must be attenuated below the transmitter power (P) by a factor of at least  $43 + 10 \log (P)$  dB.

For Band 7, 38, 41

The power of any emission outside of the authorized operating frequency ranges must be attenuated below the transmitter power (P) by a factor of at least  $55 + 10 \log (P)$  dB.

The spectrum is scanned from 30 MHz up to a frequency including its 10th harmonic.

### 4.4.2 Test Procedures

1. The testing follows ANSI C63.26 Section 5.5
2. The EUT was placed on a turntable with 0.8 meter height for frequency below 1GHz and 1.5 meter height for frequency above 1GHz respectively above ground.
3. The EUT was set 3 meters from the receiving antenna mounted on the antenna tower.
4. The table was rotated 360 degrees to determine the position of the highest spurious emission.
5. The height of the receiving antenna is varied between 1m to 4m to search the maximum spurious emission for both horizontal and vertical polarizations.
6. During the measurement, the system simulator parameters were set to force the EUT transmitting at maximum output power.
7. Make the measurement with the spectrum analyzer's RBW = 1MHz, VBW = 3MHz, taking the record of maximum spurious emission.
8. A horn antenna was substituted in place of the EUT and was driven by a signal generator.
9. Tune the output power of signal generator to the same emission level with EUT maximum spurious emission.
10.  $EIRP (dBm) = S.G. Power - Tx Cable Loss + Tx Antenna Gain$
11.  $ERP (dBm) = EIRP - 2.15$
12. The RF fundamental frequency should be excluded against the limit line in the operating frequency band.

The limit line is derived from  $43 + 10\log(P)$ dB below the transmitter power P(Watts)  
 $= P(W) - [43 + 10\log(P)] (dB)$   
 $= [30 + 10\log(P)] (dBm) - [43 + 10\log(P)] (dB)$   
 $= -13dBm.$

13. For Band 7, 38, 41:

The limit line is derived from  $55 + 10\log(P)$ dB below the transmitter power P(Watts)



## 5 List of Measuring Equipment

Instrument	Manufacturer	Model No.	Serial No.	Characteristics	Calibration Date	Test Date	Due Date	Remark
Spectrum Analyzer	R&S	FSV40	101040	10Hz~40GHz	Oct. 14, 2021	Aug. 18, 2022~ Aug. 19, 2022	Oct. 13, 2022	Conducted (TH01-KS)
Power divider	STI	STI08-0055	-	0.5~40GHz	Aug. 26, 2021	Aug. 18, 2022~ Aug. 19, 2022	Aug. 25, 2022	Conducted (TH01-KS)
Temperature & humidity chamber	Hongzhan	LP-150U	H2014011440	-40~+150°C 20%~95%RH	Jul. 15, 2022	Aug. 18, 2022~ Aug. 19, 2022	Jul. 14, 2023	Conducted (TH01-KS)
EXA Spectrum Analyzer	Keysight	N9010B	MY57541079	10Hz~44G,MAX 30dB	Oct. 14, 2021	Sep. 04, 2022	Oct. 13, 2022	Radiation (03CH04-KS)
Loop Antenna	R&S	HFH2-Z2	100321	9kHz~30MHz	Oct. 30, 2021	Sep. 04, 2022	Oct. 29, 2022	Radiation (03CH04-KS)
Bilog Antenna	TeseQ	CBL6111D	49922	30MHz~1GHz	May 24, 2022	Sep. 04, 2022	May 23, 2023	Radiation (03CH04-KS)
Horn Antenna	Schwarzbeck	BBHA9120D	1284	1GHz~18GHz	Jan. 05, 2022	Sep. 04, 2022	Jan. 04, 2023	Radiation (03CH04-KS)
SHF-EHF Horn	Com-power	AH-840	101070	18GHz~40GHz	Jan. 05, 2022	Sep. 04, 2022	Jan. 04, 2023	Radiation (03CH04-KS)
Amplifier	SONOMA	310N	187289	9KHz~1GHz	Jan. 05, 2022	Sep. 04, 2022	Jan. 04, 2023	Radiation (03CH04-KS)
Amplifier	MITEQ	EM18G40G GA	060728	18~40GHz	Jan. 05, 2022	Sep. 04, 2022	Jan. 04, 2023	Radiation (03CH04-KS)
high gain Amplifier	EM	EM01G18G A	060839	1Ghz~18Ghz	Oct. 14, 2021	Sep. 04, 2022	Oct. 13, 2022	Radiation (03CH04-KS)
Amplifier	Keysight	83017A	MY57280106	500MHz~26.5GHz	Oct. 13, 2021	Sep. 04, 2022	Oct. 12, 2022	Radiation (03CH04-KS)
AC Power Source	Chroma	61601	F104090004	N/A	NCR	Sep. 04, 2022	NCR	Radiation (03CH04-KS)
Turn Table	ChamPro	EM 1000-T	060762-T	0~360 degree	NCR	Sep. 04, 2022	NCR	Radiation (03CH04-KS)
Antenna Mast	ChamPro	EM 1000-A	060762-A	1 m~4 m	NCR	Sep. 04, 2022	NCR	Radiation (03CH04-KS)

NCR: No Calibration Required



## 6 Uncertainty of Evaluation

The measurement uncertainties shown below were calculated in accordance with the requirements of ANSI 63.26-2015. All the measurement uncertainty value were shown with a coverage K=2 to indicate 95% level of confidence. The measurement data show herein meets or exceeds the CISPR measurement uncertainty values specified in CISPR 16-4-2 and can be compared directly to specified limit to determine compliance.

### Uncertainty of Radiated Emission Measurement (30 MHz ~ 1000 MHz)

Measuring Uncertainty for a Level of Confidence of 95% (U = 2Uc(y))	3.3dB
---------------------------------------------------------------------	-------

### Uncertainty of Radiated Emission Measurement (1 GHz ~ 40 GHz)

Measuring Uncertainty for a Level of Confidence of 95% (U = 2Uc(y))	2.8dB
---------------------------------------------------------------------	-------



## Appendix A. Test Results of Conducted Test

### Conducted Output Power(Average power) and ERP/EIRP

**LTE Band 2:**

BW [MHz]	Modulation	RB Size	RB Offset	Power Low Ch. / Freq.	Power Middle Ch. / Freq.	Power High Ch. / Freq.	EIRP(W)		
Channel				18700	18900	19100	EIRP(W)		
Frequency (MHz)				1860	1880	1900	L	M	H
20	QPSK	1	0	22.84	22.99	22.94	0.1493	0.1545	0.1528
20	QPSK	1	99	22.87	22.89	22.82	0.1503	0.1510	0.1486
20	QPSK	100	0	21.73	21.81	21.73	0.1156	0.1178	0.1156
20	16QAM	1	0	21.59	21.84	21.75	0.1119	0.1186	0.1161
20	64QAM	1	0	20.72	20.82	20.67	0.0916	0.0938	0.0906
Channel				18675	18900	19125	EIRP(W)		
Frequency (MHz)				1857.5	1880	1902.5	L	M	H
15	QPSK	1	0	22.75	22.95	22.84	0.1462	0.1531	0.1493
15	16QAM	1	0	21.52	21.72	21.59	0.1102	0.1153	0.1119
Channel				18650	18900	19150	EIRP(W)		
Frequency (MHz)				1855	1880	1905	L	M	H
10	QPSK	1	0	22.67	22.88	22.81	0.1435	0.1507	0.1483
10	16QAM	1	0	21.59	21.62	21.69	0.1119	0.1127	0.1146
Channel				18625	18900	19175	EIRP(W)		
Frequency (MHz)				1852.5	1880	1907.5	L	M	H
5	QPSK	1	0	22.73	22.91	22.79	0.1455	0.1517	0.1476
5	16QAM	1	0	21.45	21.61	21.59	0.1084	0.1125	0.1119
Channel				18615	18900	19185	EIRP(W)		
Frequency (MHz)				1851.5	1880	1908.5	L	M	H
3	QPSK	1	0	22.72	22.76	22.85	0.1452	0.1466	0.1496
3	16QAM	1	0	21.43	21.72	21.63	0.1079	0.1153	0.1130
Channel				18607	18900	19193	EIRP(W)		
Frequency (MHz)				1850.7	1880	1909.3	L	M	H
1.4	QPSK	1	0	22.71	22.92	22.88	0.1449	0.1521	0.1507
1.4	16QAM	1	0	21.76	21.77	21.71	0.1164	0.1167	0.1151



**LTE Band 4:**

BW [MHz]	Modulation	RB Size	RB Offset	Power Low Ch. / Freq.	Power Middle Ch. / Freq.	Power High Ch. / Freq.	EIRP(W)		
Channel				20050	20175	20300	EIRP(W)		
Frequency (MHz)				1720	1732.5	1745	L	M	H
20	QPSK	1	0	23.11	23.36	23.29	0.1552	0.1644	0.1618
20	QPSK	1	99	23.18	23.21	23.05	0.1578	0.1589	0.1531
20	QPSK	100	0	22.09	22.18	22.05	0.1227	0.1253	0.1216
20	16QAM	1	0	21.82	22.02	22.17	0.1153	0.1208	0.1250
20	64QAM	1	0	21.01	21.13	21.02	0.0957	0.0984	0.0959
Channel				20025	20175	20325	EIRP(W)		
Frequency (MHz)				1717.5	1732.5	1747.5	L	M	H
15	QPSK	1	0	22.95	23.30	23.26	0.1496	0.1622	0.1607
15	16QAM	1	0	21.81	22.01	21.72	0.1151	0.1205	0.1127
Channel				20000	20175	20350	EIRP(W)		
Frequency (MHz)				1715	1732.5	1750	L	M	H
10	QPSK	1	0	23.02	23.32	23.13	0.1521	0.1629	0.1560
10	16QAM	1	0	21.71	21.89	22.06	0.1125	0.1172	0.1219
Channel				19975	20175	20375	EIRP(W)		
Frequency (MHz)				1712.5	1732.5	1752.5	L	M	H
5	QPSK	1	0	22.93	23.26	23.03	0.1489	0.1607	0.1524
5	16QAM	1	0	21.76	21.93	22.06	0.1138	0.1183	0.1219
Channel				19965	20175	20385	EIRP(W)		
Frequency (MHz)				1711.5	1732.5	1753.5	L	M	H
3	QPSK	1	0	23.04	23.25	23.19	0.1528	0.1603	0.1581
3	16QAM	1	0	21.76	21.89	22.08	0.1138	0.1172	0.1225
Channel				19950	20175	20393	EIRP(W)		
Frequency (MHz)				1710	1732.5	1754.3	L	M	H
1.4	QPSK	1	0	22.96	23.26	23.21	0.1500	0.1607	0.1589
1.4	16QAM	1	0	21.99	22.12	22.03	0.1199	0.1236	0.1211

**LTE Band 5:**

BW [MHz]	Modulation	RB Size	RB Offset	Power Low Ch. / Freq.	Power Middle Ch. / Freq.	Power High Ch. / Freq.	ERP(W)		
Channel				20450	20525	20600	ERP(W)		
Frequency (MHz)				829	836.5	844	L	M	H
10	QPSK	1	0	22.99	23.33	23.26	0.0682	0.0738	0.0726
10	QPSK	1	49	23.18	23.08	23.06	0.0713	0.0697	0.0693
10	QPSK	50	0	22.03	22.08	21.97	0.0547	0.0553	0.0540
10	16QAM	1	0	21.80	21.96	22.12	0.0519	0.0538	0.0558
10	64QAM	1	0	20.97	21.09	20.85	0.0429	0.0441	0.0417
Channel				20425	20525	20625	ERP(W)		
Frequency (MHz)				826.5	836.5	846.5	L	M	H
5	QPSK	1	0	22.87	23.29	23.21	0.0664	0.0731	0.0718
5	16QAM	1	0	21.63	21.90	21.94	0.0499	0.0531	0.0536
Channel				20415	20525	20635	ERP(W)		
Frequency (MHz)				825.5	836.5	847.5	L	M	H
3	QPSK	1	0	22.88	23.24	23.18	0.0665	0.0723	0.0713
3	16QAM	1	0	21.76	21.88	21.91	0.0514	0.0528	0.0532



Channel				20407	20525	20643	ERP(W)		
Frequency (MHz)				824.7	836.5	848.3	L	M	H
1.4	QPSK	1	0	22.84	23.26	23.13	0.0659	0.0726	0.0705
1.4	16QAM	1	0	22.02	22.06	21.81	0.0546	0.0551	0.0520

**LTE Band 7:**

BW [MHz]	Modulation	RB Size	RB Offset	Power Low Ch. / Freq.	Power Middle Ch. / Freq.	Power High Ch. / Freq.	EIRP(W)		
Channel				20850	20850	21350	EIRP(W)		
Frequency (MHz)				2510	2535	2560	L	M	H
20	QPSK	1	0	23.54	23.58	23.47	0.2158	0.2178	0.2123
20	QPSK	1	99	23.45	23.39	23.39	0.2113	0.2084	0.2084
20	QPSK	100	0	22.23	22.25	22.17	0.1596	0.1603	0.1574
20	16QAM	1	0	21.98	22.20	22.10	0.1507	0.1585	0.1549
20	64QAM	1	0	21.09	21.18	21.35	0.1227	0.1253	0.1303
Channel				20825	21100	21375	EIRP(W)		
Frequency (MHz)				2507.5	2535	2562.5	L	M	H
15	QPSK	1	0	23.41	23.52	23.42	0.2094	0.2148	0.2099
15	16QAM	1	0	21.82	22.09	21.92	0.1452	0.1545	0.1486
Channel				20800	21100	21400	EIRP(W)		
Frequency (MHz)				2505	2535	2565	L	M	H
10	QPSK	1	0	23.39	23.40	23.35	0.2084	0.2089	0.2065
10	16QAM	1	0	21.95	22.14	21.96	0.1496	0.1563	0.1500
Channel				20775	21100	21425	EIRP(W)		
Frequency (MHz)				2502.5	2535	2567.5	L	M	H
5	QPSK	1	0	23.39	23.43	23.29	0.2084	0.2104	0.2037
5	16QAM	1	0	21.82	22.11	22.01	0.1452	0.1552	0.1517

**LTE Band 26:**

BW [MHz]	Modulation	RB Size	RB Offset	Power Low Ch. / Freq.	Power Low Ch. / Freq.	Power Middle Ch. / Freq.	Power High Ch. / Freq.	ERP(W)			
Channel				26790	26865	26915	26965	ERP(W)			
Frequency (MHz)				824	831.5	836.5	841.5	L	M	H	
15	QPSK	1	0	23.00	23.39	23.39	23.32	0.0684	0.0748	0.0748	0.0736
15	QPSK	1	74	22.79	23.23	23.23	23.11	0.0652	0.0721	0.0721	0.0701
15	QPSK	75	0	21.79	22.12	22.12	22.03	0.0518	0.0558	0.0558	0.0547
15	16QAM	1	0	21.51	22.23	22.01	21.84	0.0485	0.0573	0.0545	0.0524
15	64QAM	1	0	20.60	20.98	20.98	21.13	0.0394	0.0430	0.0430	0.0445
Channel				26815	26840	26915	26990	ERP(W)			
Frequency (MHz)					829	836.5	844	L	M	H	
10	QPSK	1	0		23.25	23.36	23.16	0.0724	0.0743	0.0710	
10	16QAM	1	0		21.69	21.97	21.91	0.0506	0.0540	0.0532	
Channel					26815	26915	27015	ERP(W)			
Frequency (MHz)					826.5	836.5	846.5	L	M	H	
5	QPSK	1	0		23.28	23.17	22.94	0.0729	0.0711	0.0675	
5	16QAM	1	0		21.63	21.95	21.66	0.0499	0.0537	0.0502	
Channel					26815	26915	27025	ERP(W)			



Frequency (MHz)				825.5	836.5	847.5	L	M	H
3	QPSK	1	0	23.24	23.22	23.25	0.0723	0.0719	0.0724
3	16QAM	1	0	21.77	21.91	21.80	0.0515	0.0532	0.0519
Channel				26797	26915	27033	ERP(W)		
Frequency (MHz)				824.7	836.5	848.3	L	M	H
1.4	QPSK	1	0	23.27	23.12	23.02	0.0728	0.0703	0.0687
1.4	16QAM	1	0	21.99	22.13	22.01	0.0542	0.0560	0.0545

**LTE Band 38:**

BW [MHz]	Modulation	RB Size	RB Offset	Power Low Ch. / Freq.	Power Middle Ch. / Freq.	Power High Ch. / Freq.	EIRP(W)		
Channel				37850	38000	38150	EIRP(W)		
Frequency (MHz)				2580	2595	2610	L	M	H
20	QPSK	1	0	23.44	23.46	23.42	0.2109	0.2118	0.2099
20	QPSK	1	99	23.45	23.35	23.29	0.2113	0.2065	0.2037
20	QPSK	100	0	22.16	22.18	22.17	0.1570	0.1578	0.1574
20	16QAM	1	0	21.94	22.13	21.87	0.1493	0.1560	0.1469
20	64QAM	1	0	21.12	21.07	21.26	0.1236	0.1222	0.1276
Channel				37825	38000	38175	EIRP(W)		
Frequency (MHz)				2577.5	2595	2612.5	L	M	H
15	QPSK	1	0	23.35	23.41	23.26	0.2065	0.2094	0.2023
15	16QAM	1	0	21.76	21.97	22.05	0.1432	0.1503	0.1531
Channel				37800	38000	38200	EIRP(W)		
Frequency (MHz)				2575	2595	2615	L	M	H
10	QPSK	1	0	23.36	23.18	23.11	0.2070	0.1986	0.1954
10	16QAM	1	0	21.74	21.92	22.02	0.1426	0.1486	0.1521
Channel				37775	38000	38225	EIRP(W)		
Frequency (MHz)				2572.5	2595	2617.5	L	M	H
5	QPSK	1	0	23.28	23.38	23.30	0.2032	0.2080	0.2042
5	16QAM	1	0	21.86	22.05	21.79	0.1466	0.1531	0.1442

**LTE Band 41:**

BW [MHz]	Modulation	RB Size	RB Offset	Power Low Ch. / Freq.	Power Middle Ch. / Freq.	Power High Ch. / Freq.	EIRP(W)		
Channel				39750	40620	41490	EIRP(W)		
Frequency (MHz)				2506	2593	2680	L	M	H
20	QPSK	1	0	23.40	23.53	23.37	0.2089	0.2153	0.2075
20	QPSK	1	99	23.48	23.42	23.22	0.2128	0.2099	0.2004
20	QPSK	100	0	22.13	22.17	22.10	0.1560	0.1574	0.1549
20	16QAM	1	0	21.84	22.12	22.07	0.1459	0.1556	0.1538
20	64QAM	1	0	21.09	21.10	21.31	0.1227	0.1230	0.1291
Channel				39725	40620	41515	EIRP(W)		
Frequency (MHz)				2503.5	2593	2682.5	L	M	H
15	QPSK	1	0	23.43	23.31	23.19	0.2104	0.2046	0.1991
15	16QAM	1	0	21.72	22.04	21.97	0.1419	0.1528	0.1503
Channel				39700	40620	41540	EIRP(W)		
Frequency (MHz)				2501	2593	2685	L	M	H
10	QPSK	1	0	23.31	23.39	23.06	0.2046	0.2084	0.1932



10	16QAM	1	0	21.70	22.07	21.95	0.1413	0.1538	0.1496
Channel				39675	40620	41565	EIRP(W)		
Frequency (MHz)				2498.5	2593	2687.5	L	M	H
5	QPSK	1	0	23.23	23.47	23.29	0.2009	0.2123	0.2037
5	16QAM	1	0	21.79	22.04	21.94	0.1442	0.1528	0.1493





## LTE Band 2

### Peak-to-Average Ratio

Mode	LTE Band 2 / 20MHz			
Mod.	QPSK	16QAM	64QAM	Limit: 13dB
RB Size	Full RB	Full RB	Full RB	Result
Middle CH	5.19	6.06	6.35	<b>PASS</b>

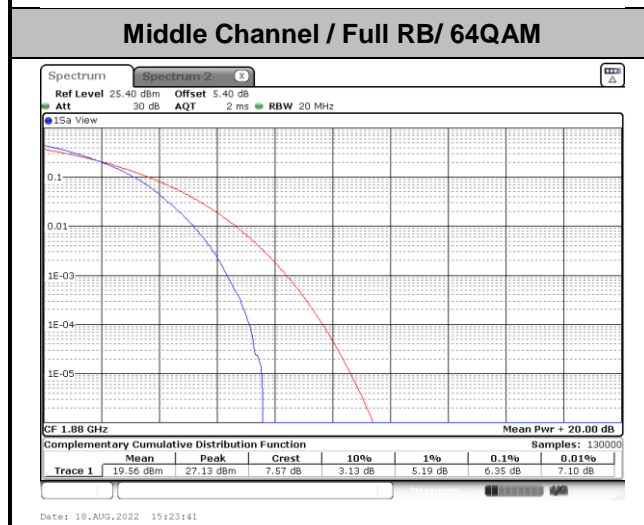
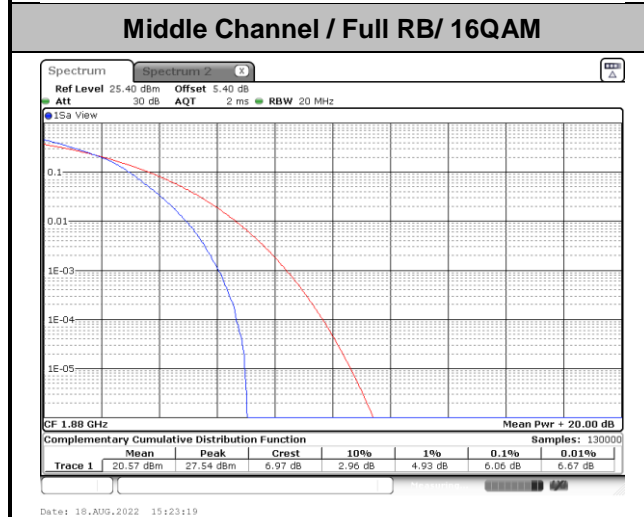
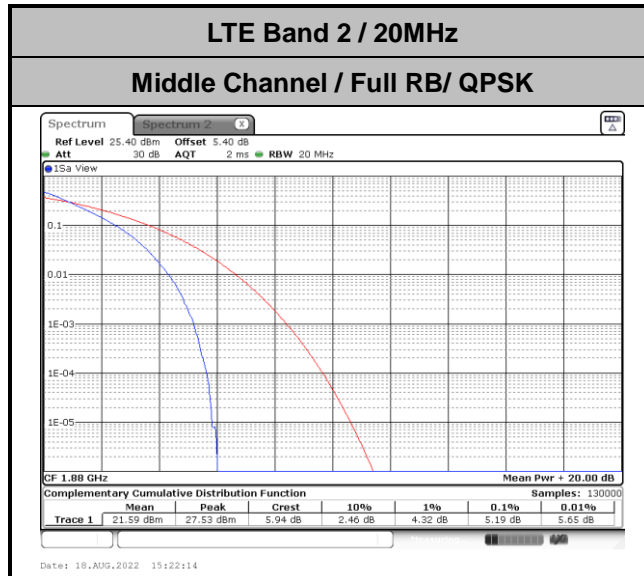



## 26dB Bandwidth

<b>Mode</b>	<b>LTE Band 2 : 26dB BW(MHz)</b>	
<b>BW</b>	<b>20MHz</b>	
<b>Mod.</b>	<b>QPSK</b>	<b>16QAM</b>
<b>Middle CH</b>	18.90	19.10

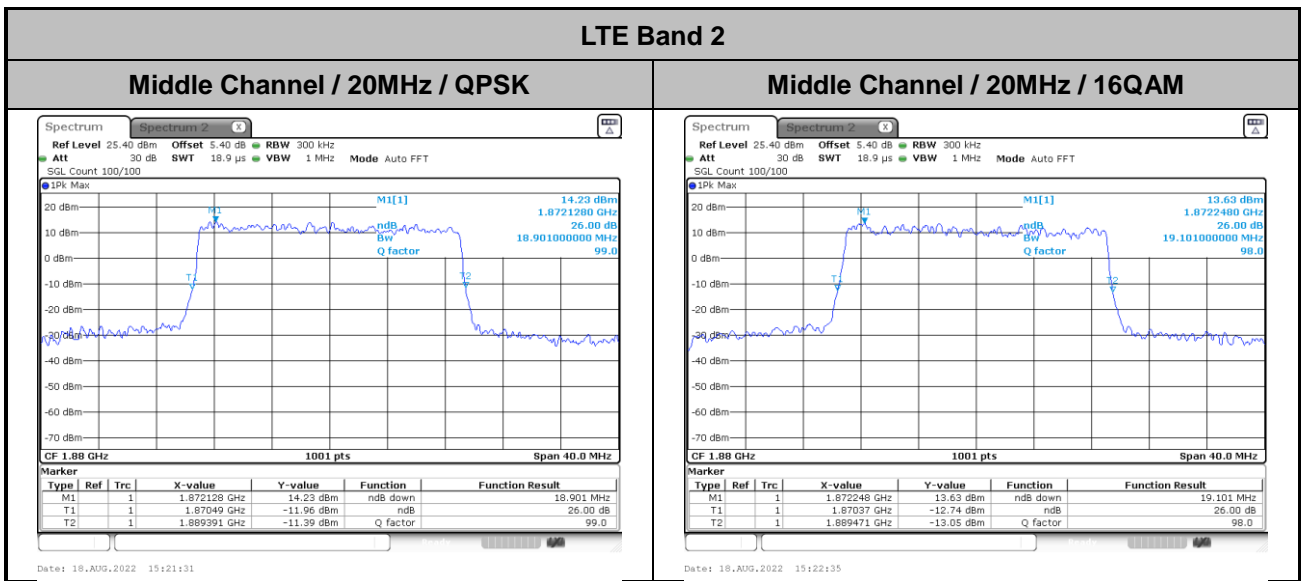



# Occupied Bandwidth

Mode	LTE Band 2 : 99%OBW(MHz)	
BW	20MHz	
Mod.	QPSK	16QAM
Middle CH	17.90	17.94

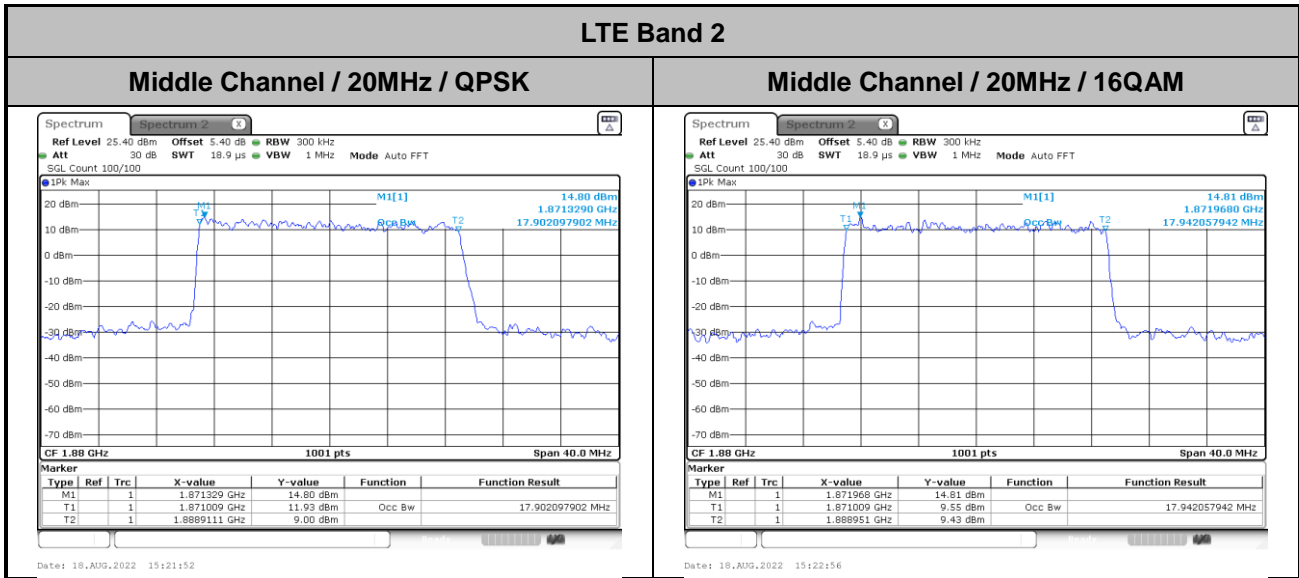



# Conducted Band Edge

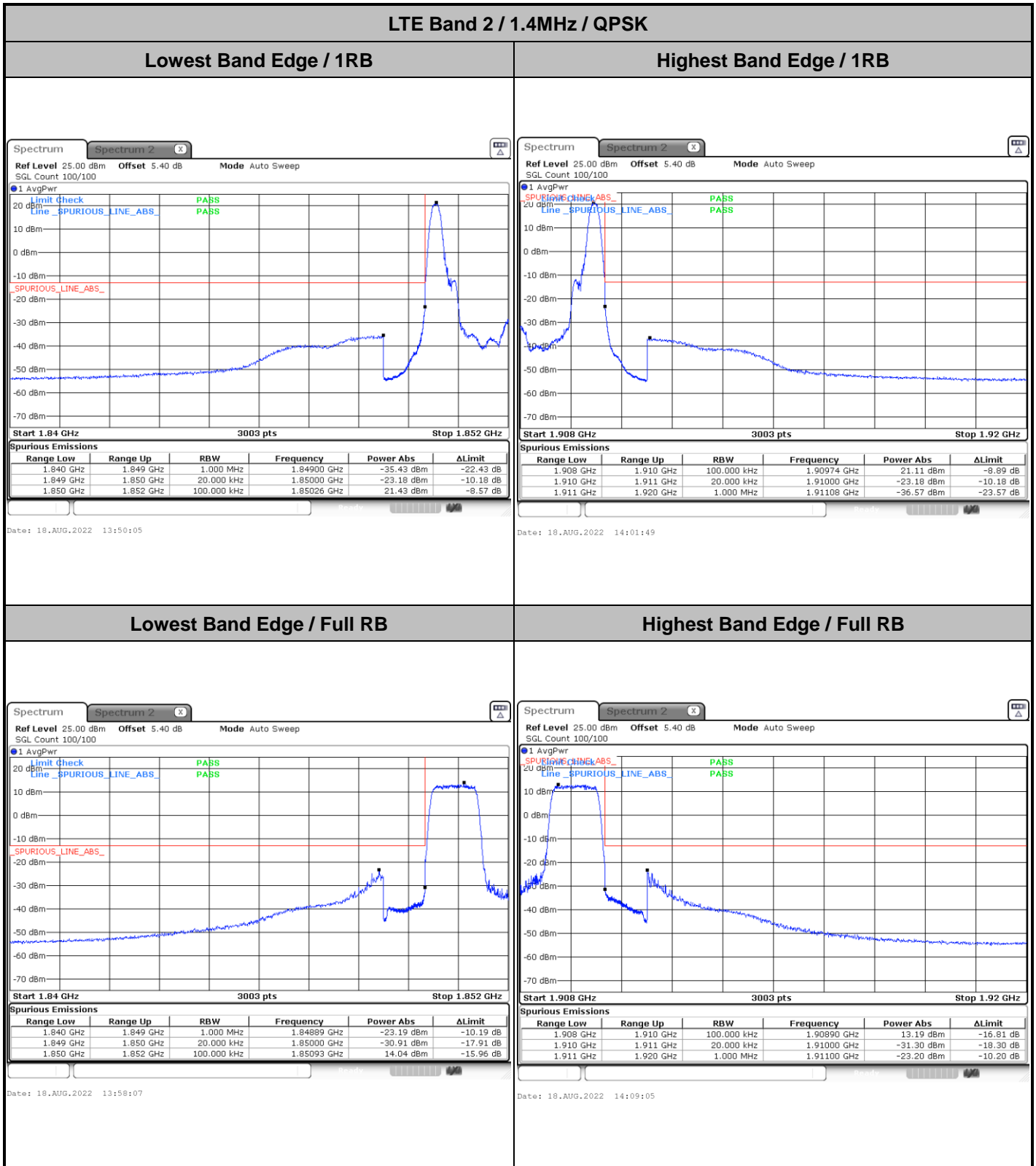



LTE Band 2 / 1.4MHz / 16QAM

Lowest Band Edge / 1 RB

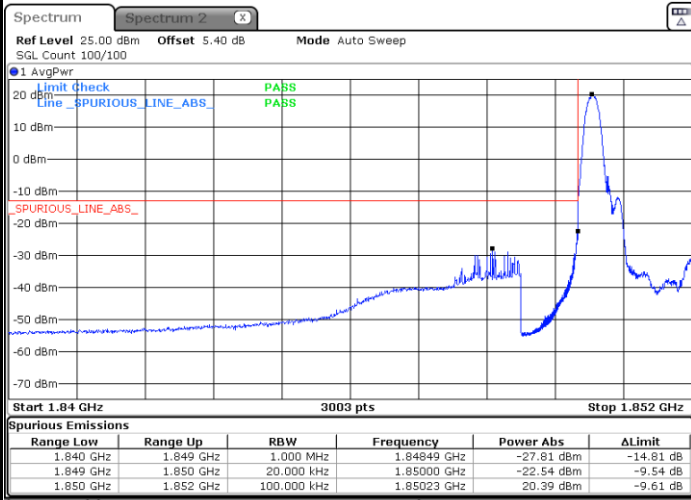

Date: 18.AUG.2022 13:52:16

Highest Band Edge / 1 RB

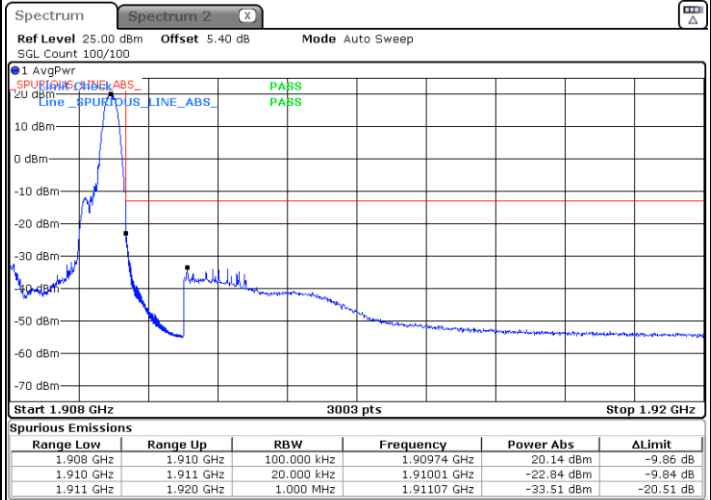

Date: 18.AUG.2022 14:03:16

Lowest Band Edge / Full RB

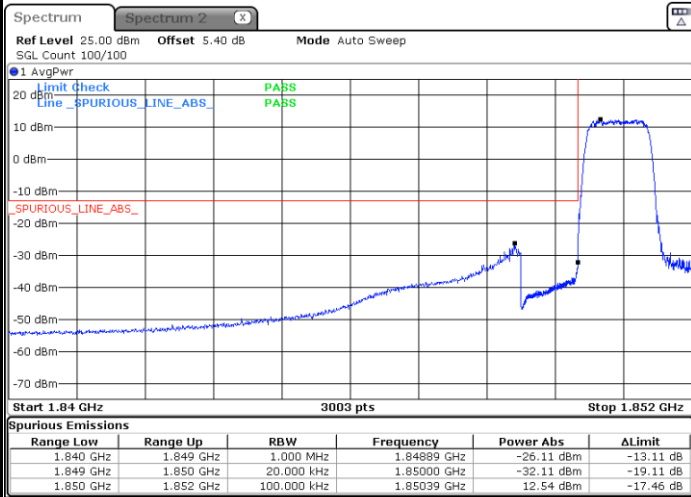

Date: 18.AUG.2022 13:56:40

Highest Band Edge / Full RB

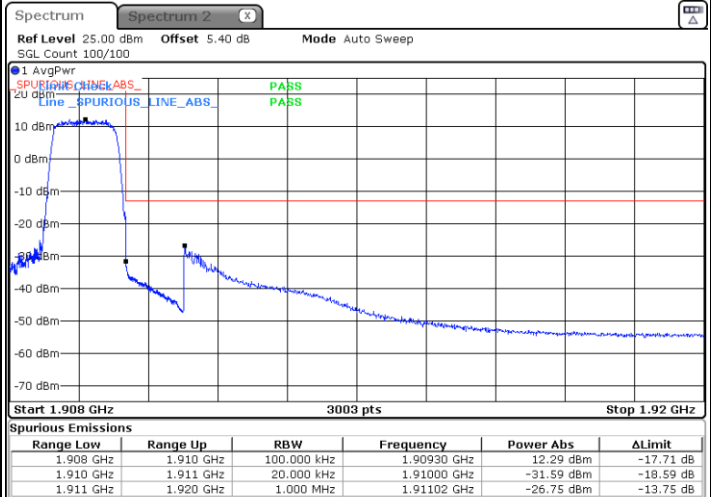

Date: 18.AUG.2022 14:07:38



LTE Band 2 / 1.4MHz / 64QAM

Lowest Band Edge / 1 RB

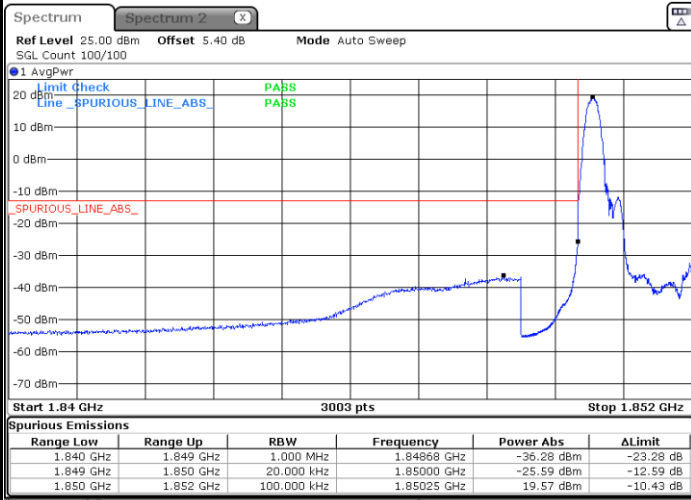

Date: 18.AUG.2022 13:53:45

Highest Band Edge / 1 RB

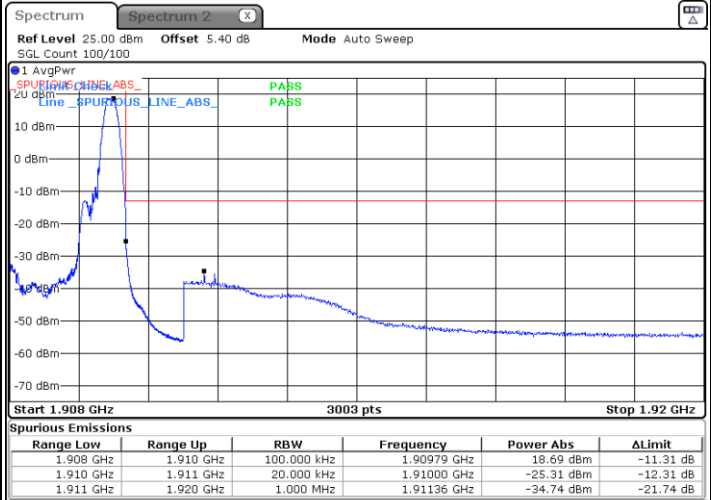

Date: 18.AUG.2022 14:04:43

Lowest Band Edge / Full RB

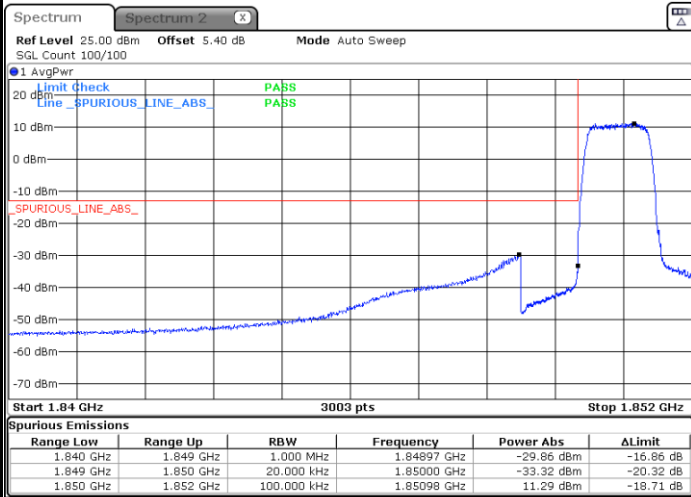

Date: 18.AUG.2022 13:55:13

Highest Band Edge / Full RB

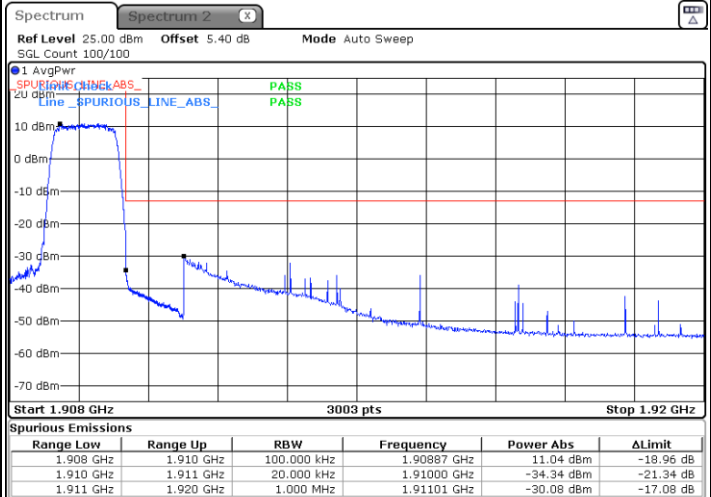

Date: 18.AUG.2022 14:06:11



LTE Band 2 / 3MHz / QPSK

Lowest Band Edge / 1RB

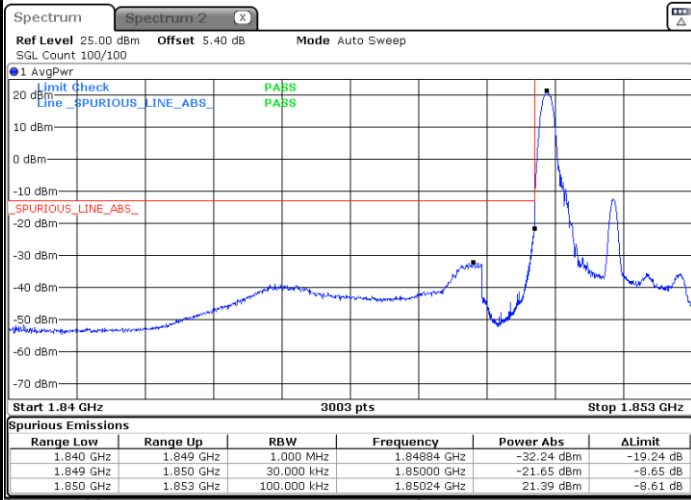

Date: 18.AUG.2022 14:11:41

Highest Band Edge / 1 RB

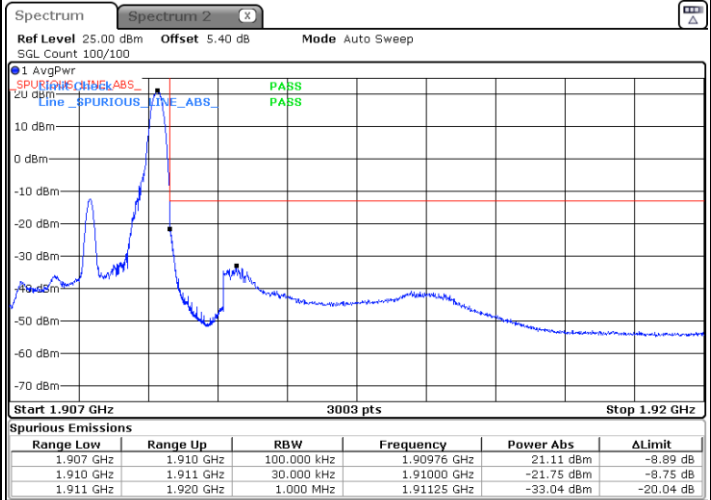

Date: 18.AUG.2022 14:22:38

Lowest Band Edge / Full RB

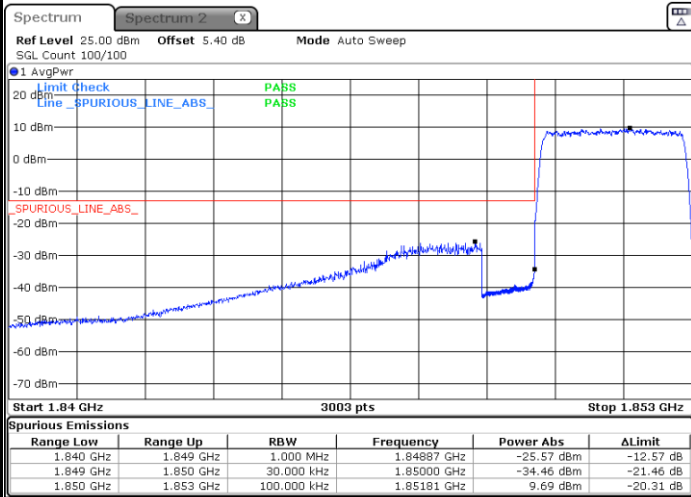

Date: 18.AUG.2022 14:18:57

Highest Band Edge / Full RB

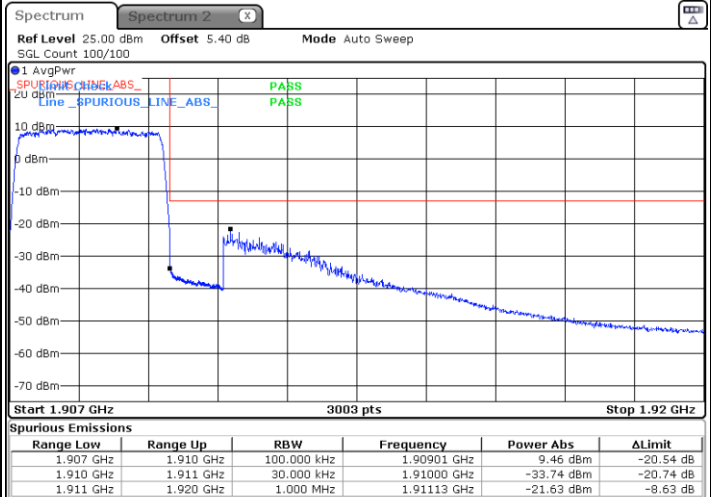

Date: 18.AUG.2022 14:30:35





**LTE Band 2 / 3MHz / 16QAM**

**Lowest Band Edge / 1 RB**

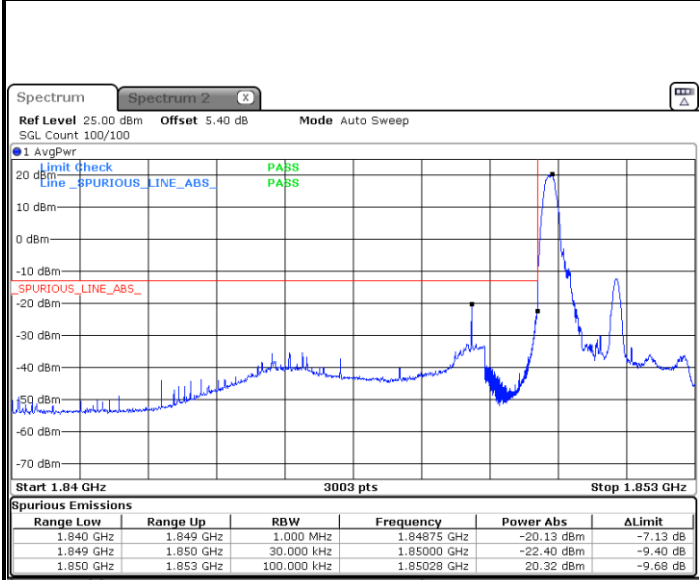

Date: 18.AUG.2022 14:13:08

**Highest Band Edge / 1 RB**

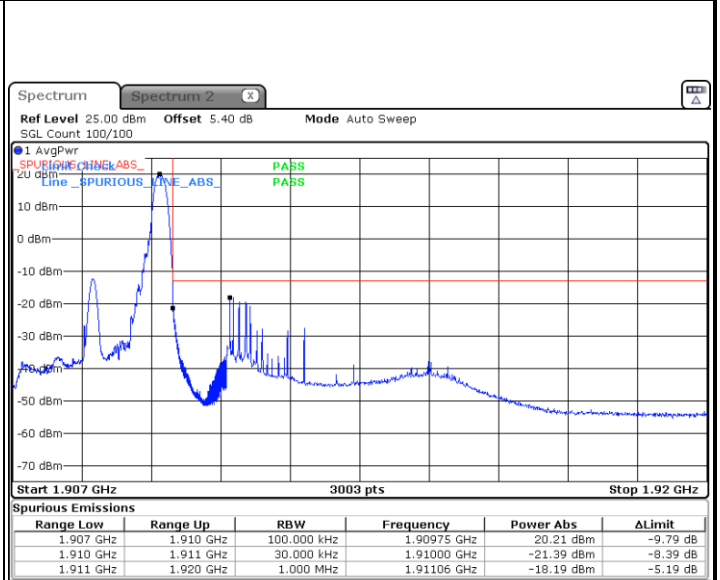

Date: 18.AUG.2022 14:26:06

**Lowest Band Edge / Full RB**

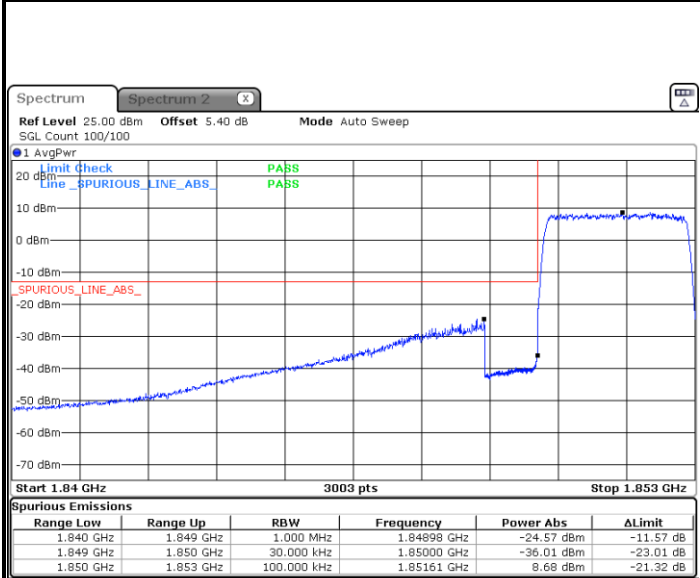

Date: 18.AUG.2022 14:17:30

**Highest Band Edge / Full RB**

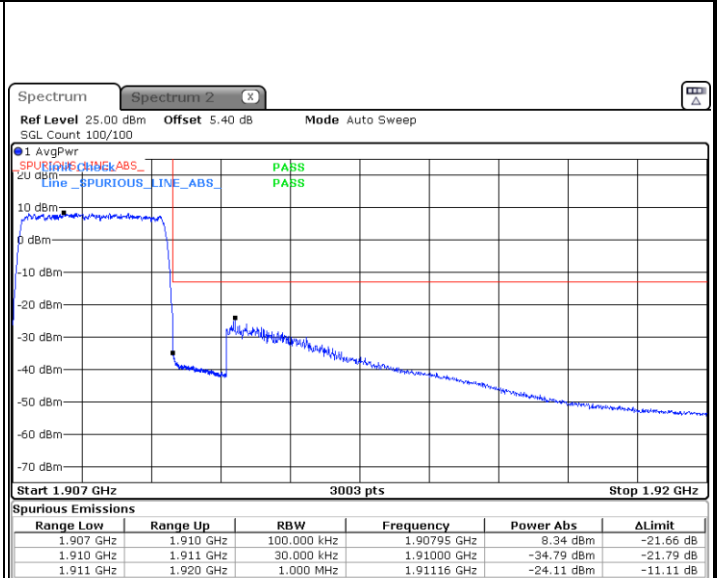

Date: 18.AUG.2022 14:29:27



LTE Band 2 / 3MHz / 64QAM

Lowest Band Edge / 1 RB

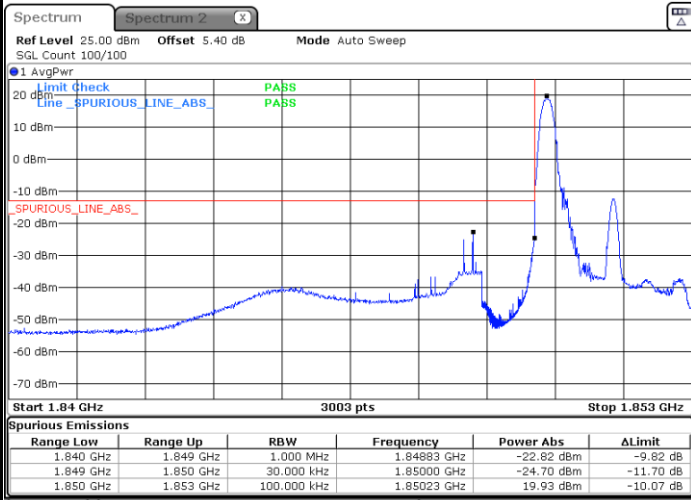

Date: 18.AUG.2022 14:14:35

Highest Band Edge / 1 RB

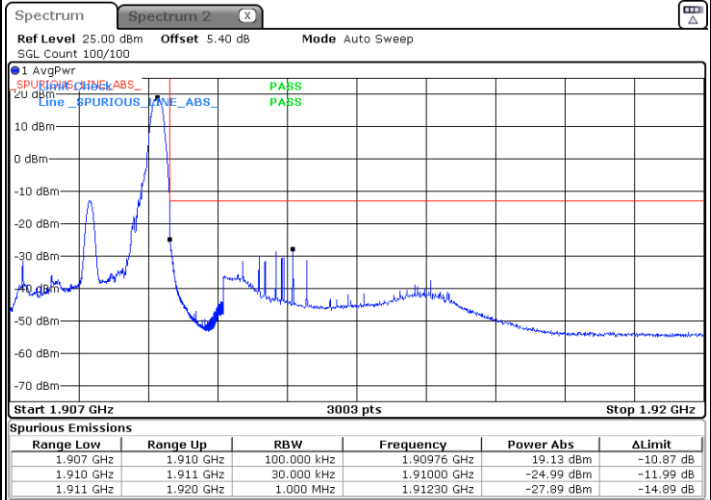

Date: 18.AUG.2022 14:27:13

Lowest Band Edge / Full RB

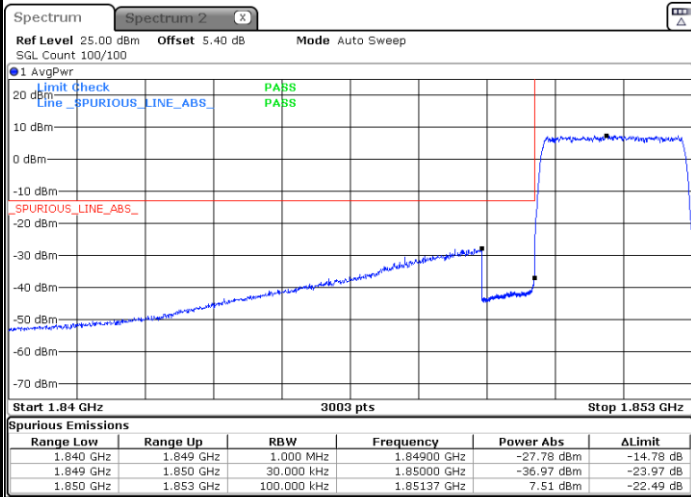

Date: 18.AUG.2022 14:16:02

Highest Band Edge / Full RB

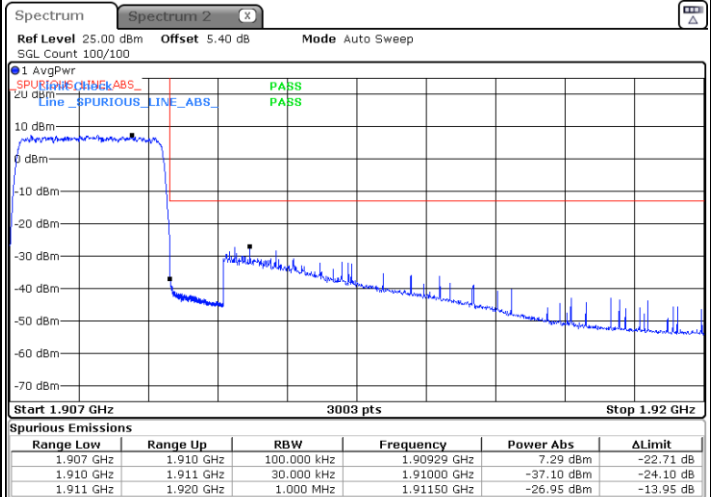

Date: 18.AUG.2022 14:28:20



LTE Band 2 / 5MHz / QPSK

Lowest Band Edge / 1 RB

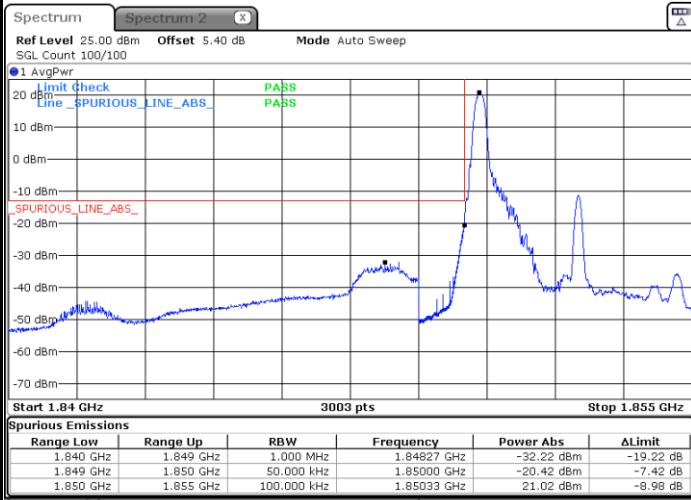

Highest Band Edge / 1 RB

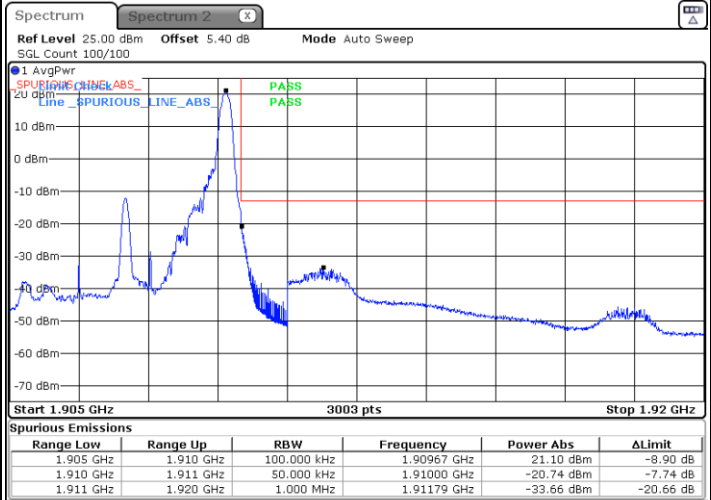

Lowest Band Edge / Full RB

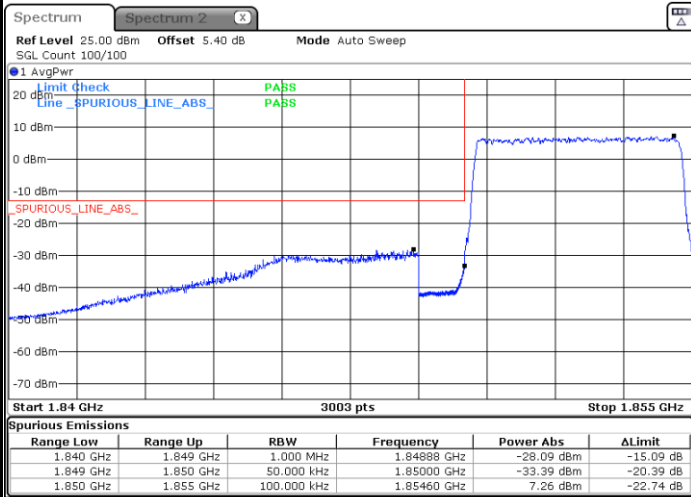

Highest Band Edge / Full RB

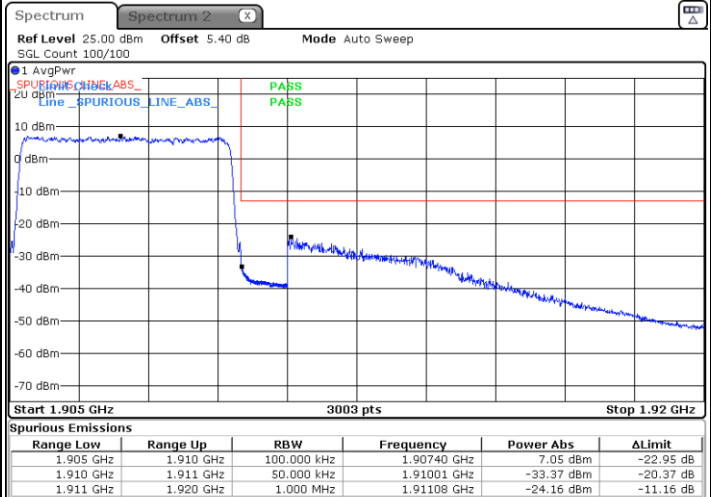



LTE Band 2 / 5MHz / 16QAM

Lowest Band Edge / 1RB

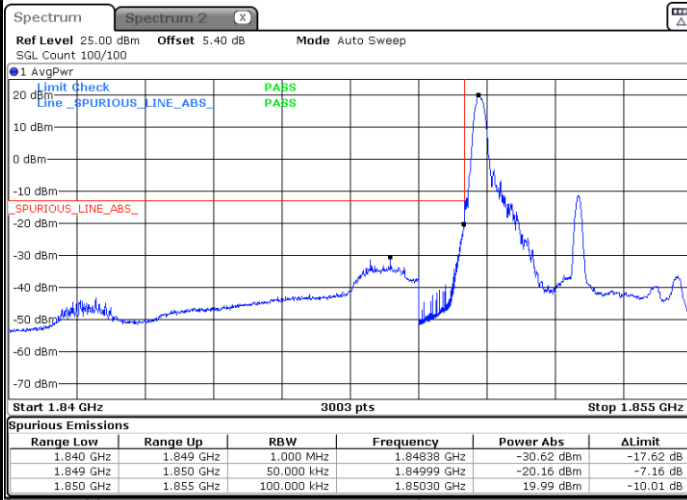

Date: 18.AUG.2022 14:33:57

Highest Band Edge / 1 RB



Date: 18.AUG.2022 14:42:54

Lowest Band Edge / Full RB

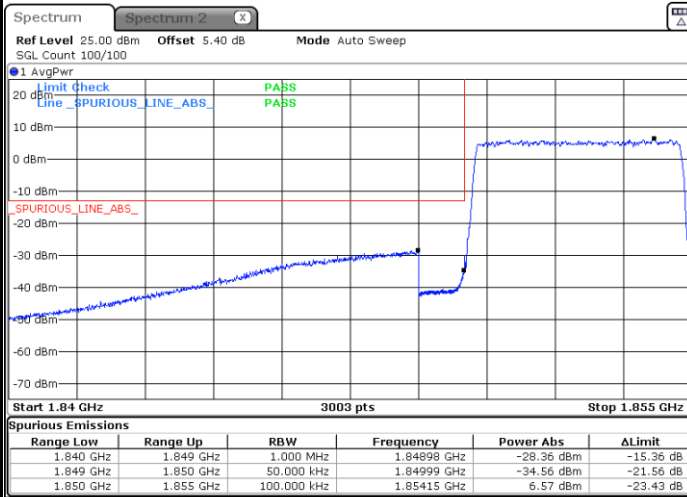

Date: 18.AUG.2022 14:37:18

Highest Band Edge / Full RB

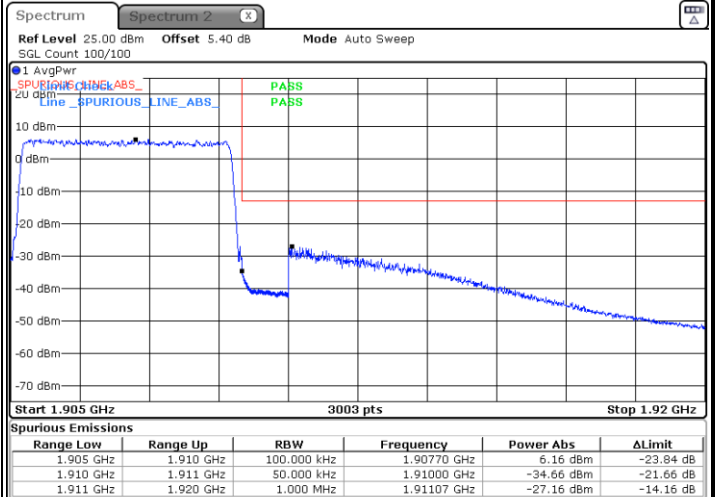

Date: 18.AUG.2022 14:46:16



LTE Band 2 / 5MHz / 64QAM

Lowest Band Edge / 1RB

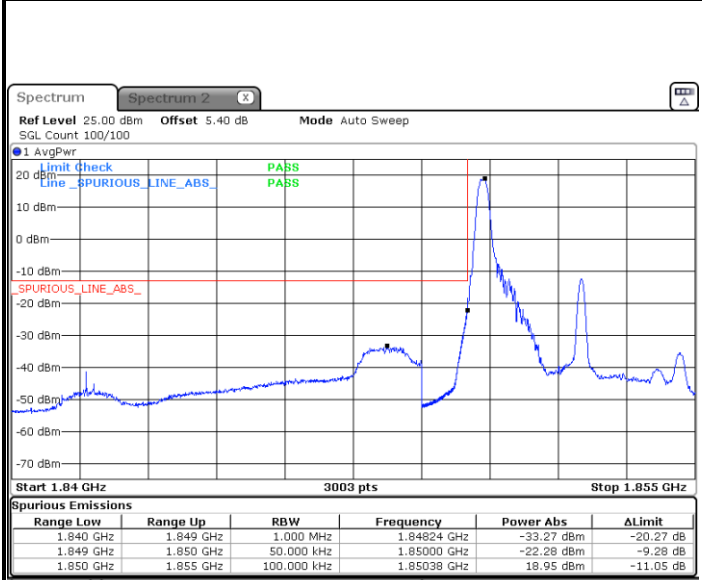

Date: 18.AUG.2022 14:35:04

Highest Band Edge / 1 RB

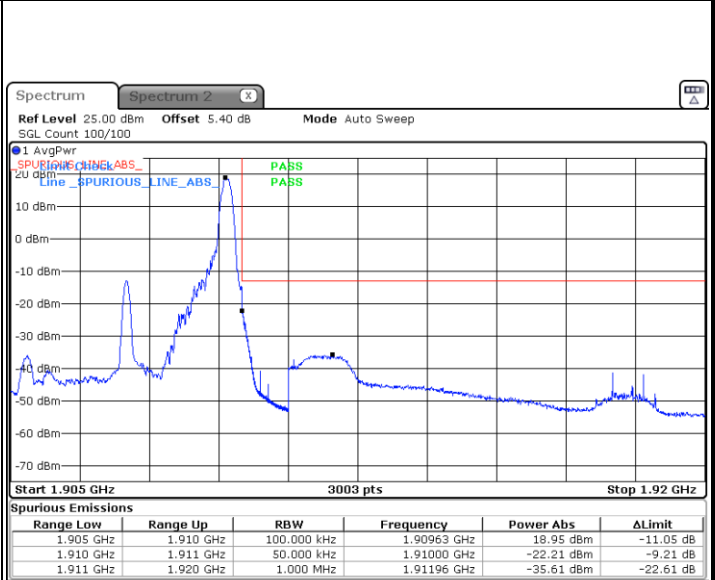

Date: 18.AUG.2022 14:44:02

Lowest Band Edge / Full RB

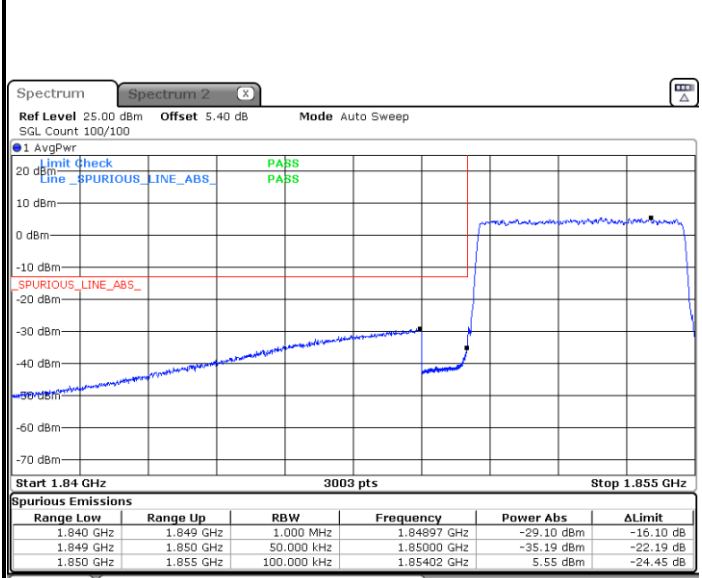

Date: 18.AUG.2022 14:36:11

Highest Band Edge / Full RB

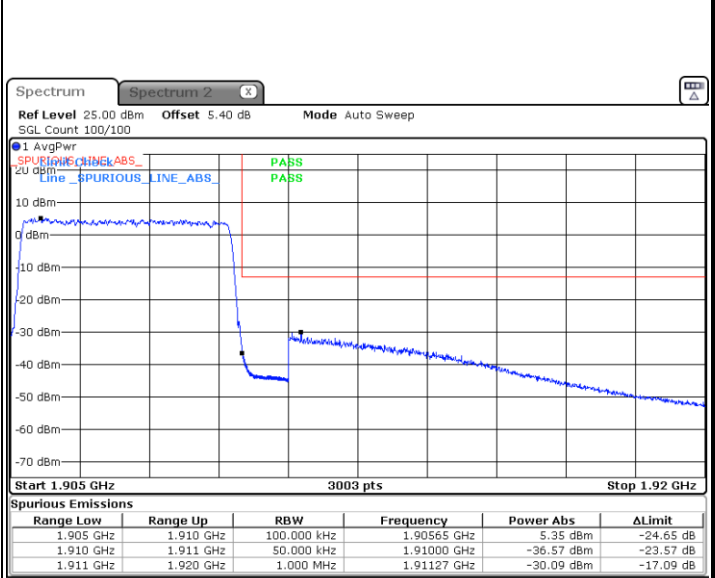

Date: 18.AUG.2022 14:45:09



LTE Band 2 / 10MHz / QPSK

Lowest Band Edge / 1 RB

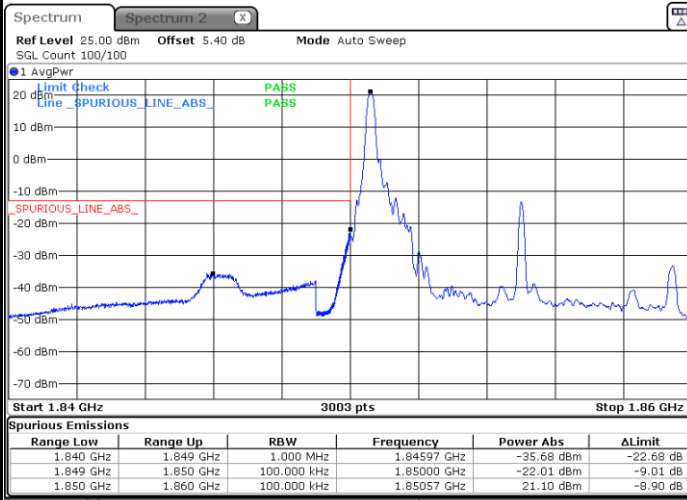

Date: 18.AUG.2022 14:49:38

Highest Band Edge / 1 RB

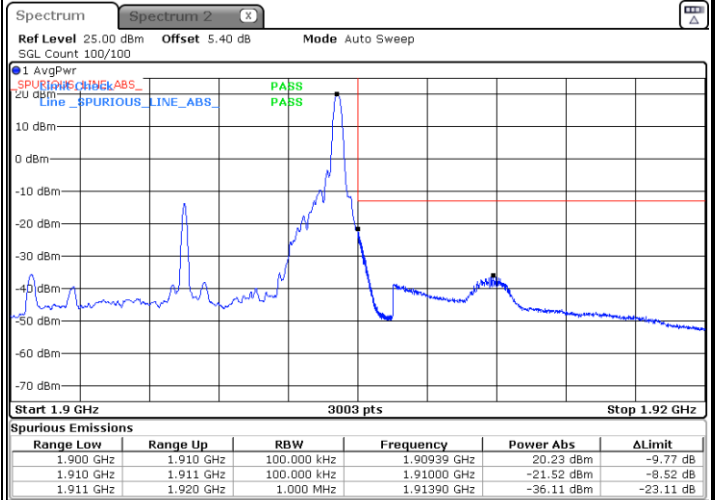

Date: 18.AUG.2022 14:57:34

Lowest Band Edge / Full RB

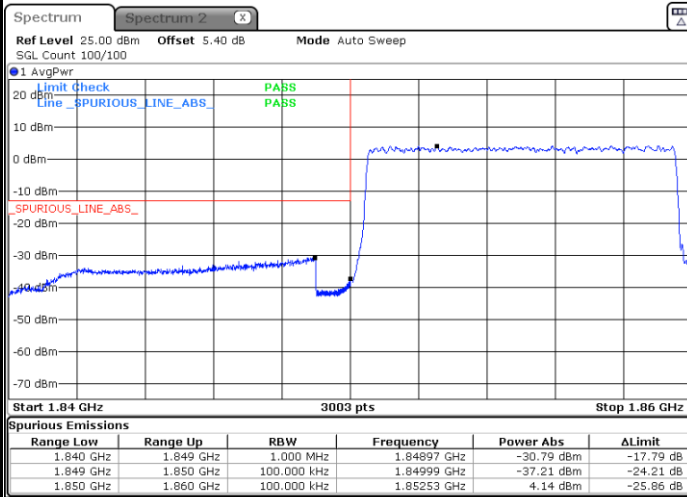

Date: 18.AUG.2022 14:54:44

Highest Band Edge / Full RB

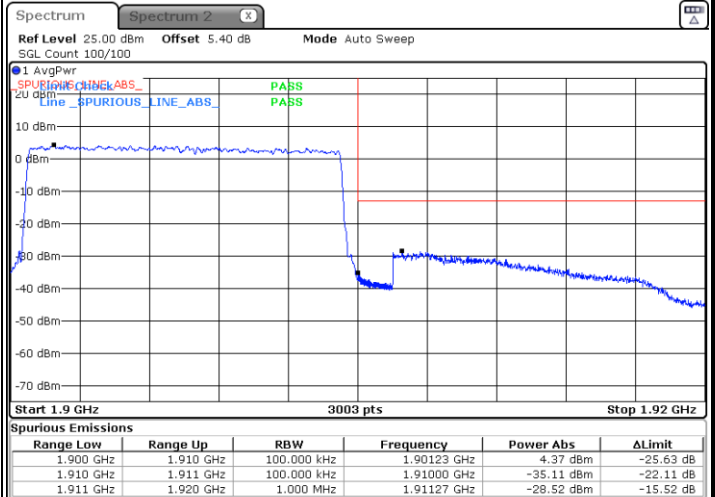

Date: 18.AUG.2022 15:00:28



LTE Band 2 / 10MHz / 16QAM

Lowest Band Edge / 1 RB

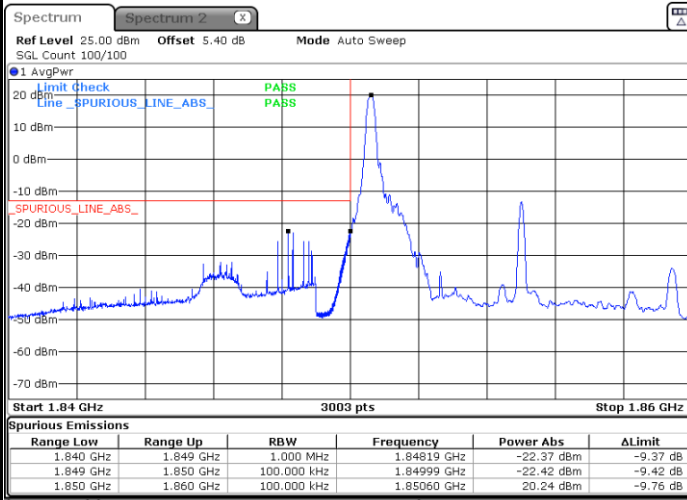

Date: 18.AUG.2022 14:51:22

Highest Band Edge / 1 RB

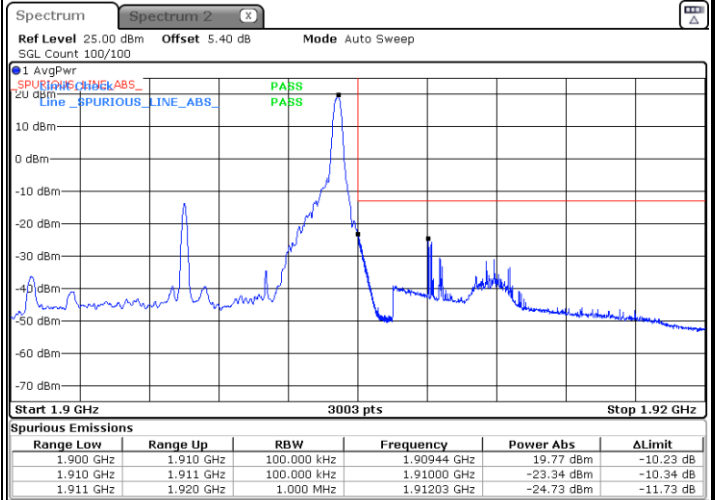

Date: 18.AUG.2022 14:58:09

Lowest Band Edge / Full RB

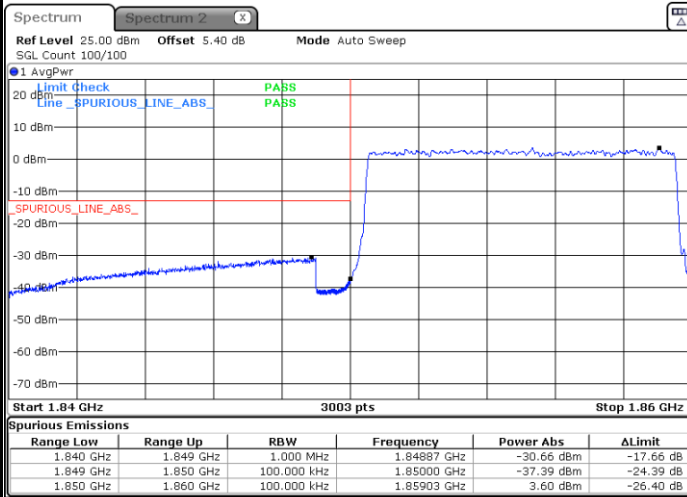

Date: 18.AUG.2022 14:54:09

Highest Band Edge / Full RB

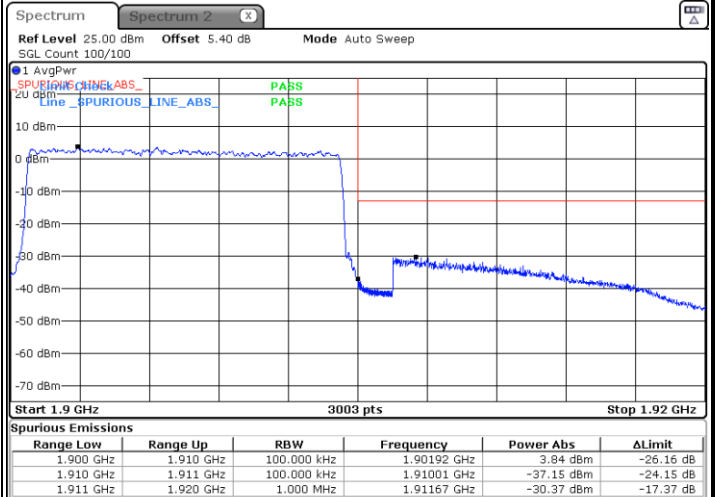

Date: 18.AUG.2022 14:59:53



LTE Band 2 / 10MHz / 64QAM

Lowest Band Edge / 1 RB

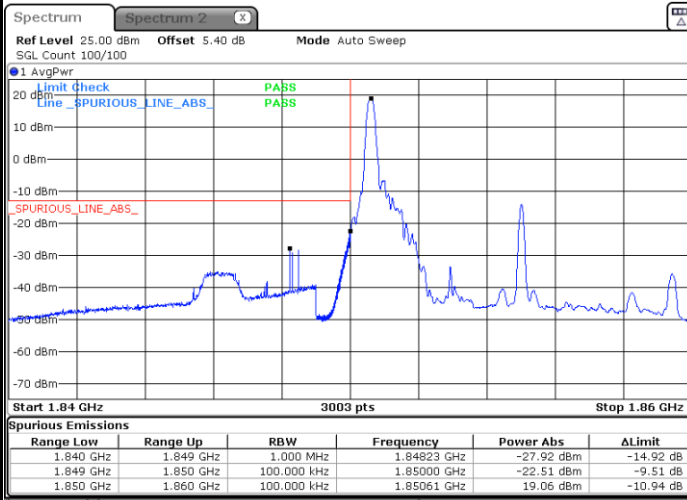

Date: 18.AUG.2022 14:52:58

Highest Band Edge / 1 RB

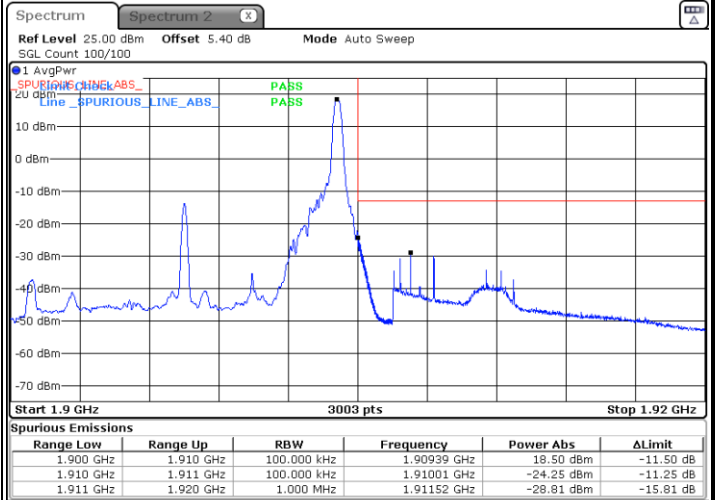

Date: 18.AUG.2022 14:58:43

Lowest Band Edge / Full RB

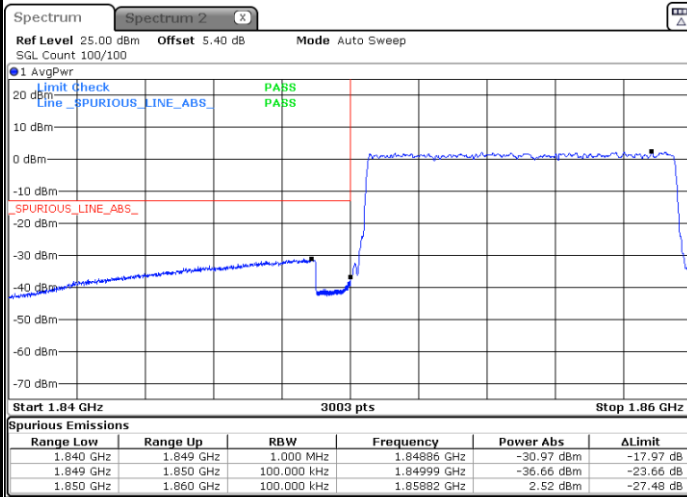

Date: 18.AUG.2022 14:53:34

Highest Band Edge / Full RB

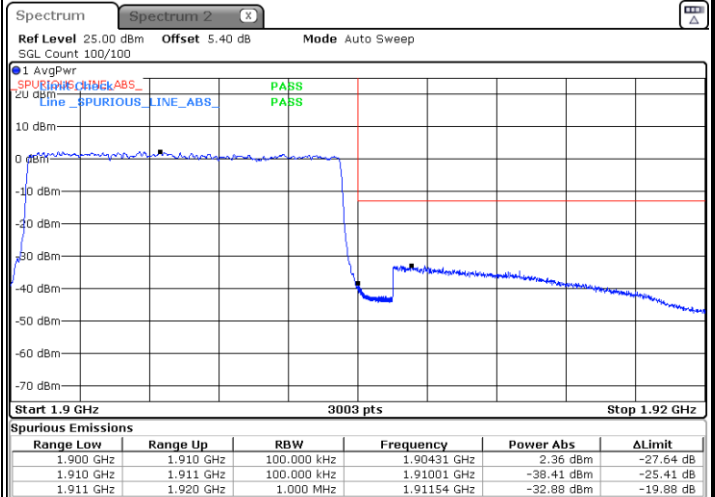

Date: 18.AUG.2022 14:59:18





LTE Band 2 / 15MHz / QPSK

Lowest Band Edge / 1 RB

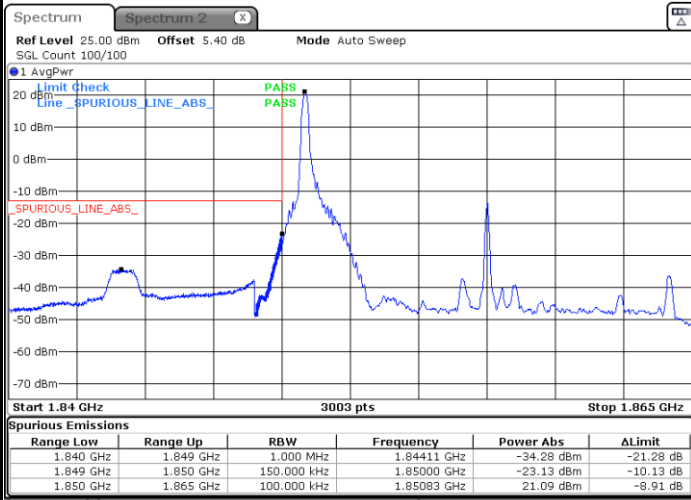

Date: 18.AUG.2022 15:02:11

Highest Band Edge / 1 RB

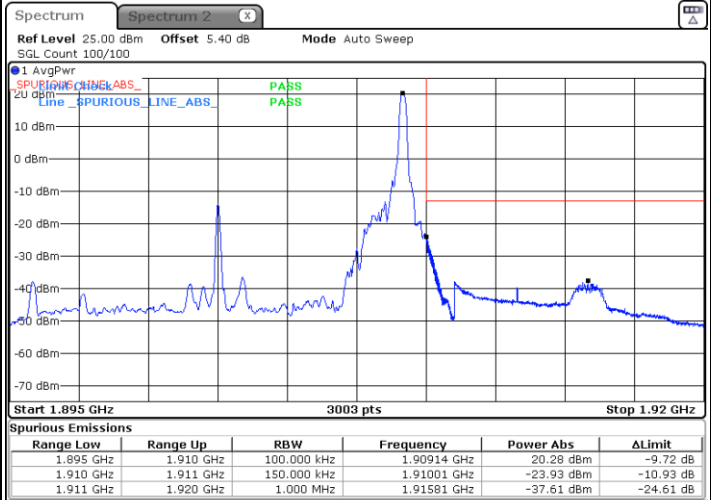

Date: 18.AUG.2022 15:07:54

Lowest Band Edge / Full RB

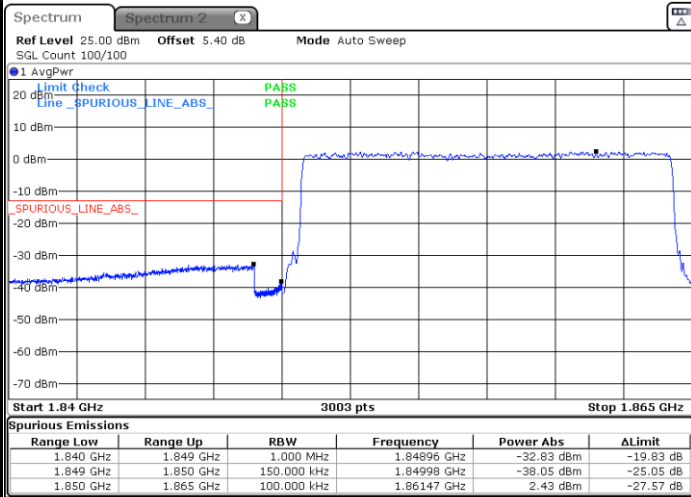

Date: 18.AUG.2022 15:05:05

Highest Band Edge / Full RB

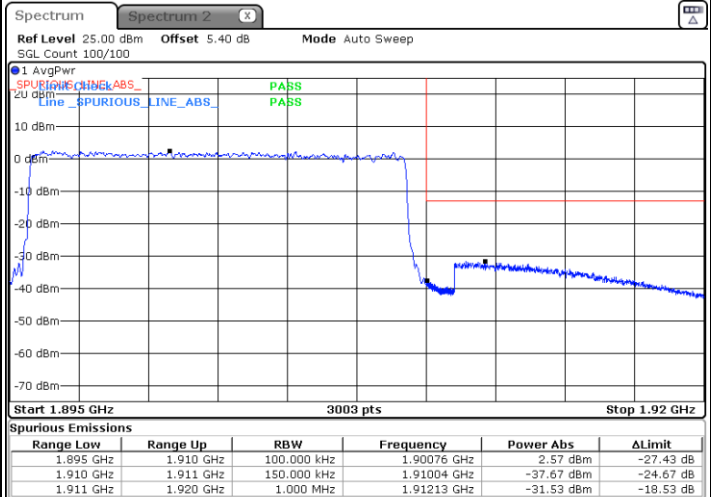

Date: 18.AUG.2022 15:10:49



LTE Band 2 / 15MHz / 16QAM

Lowest Band Edge / 1 RB

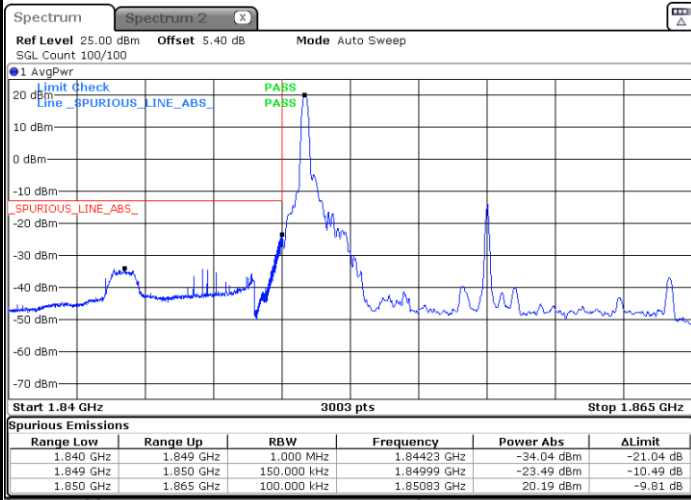

Date: 18.AUG.2022 15:02:45

Highest Band Edge / 1 RB

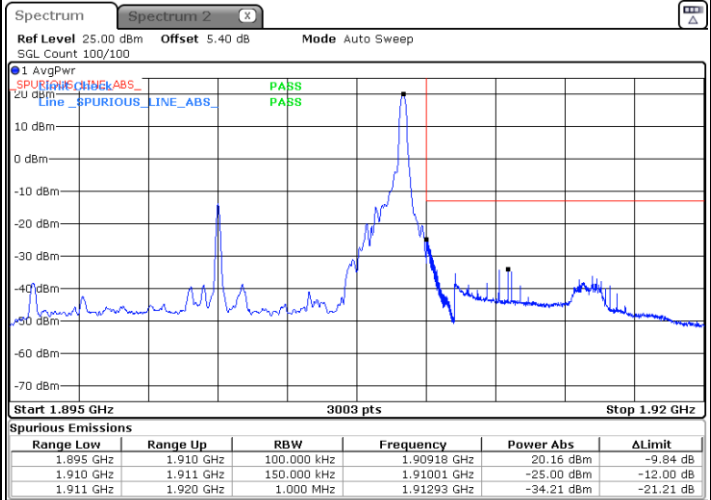

Date: 18.AUG.2022 15:08:29

Lowest Band Edge / Full RB

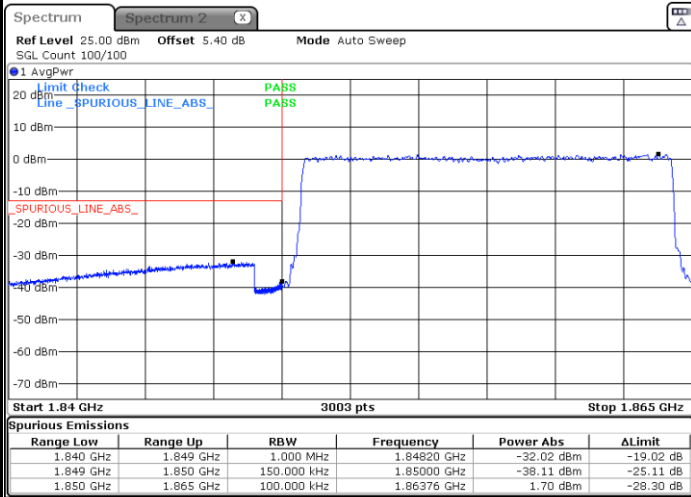

Date: 18.AUG.2022 15:04:30

Highest Band Edge / Full RB

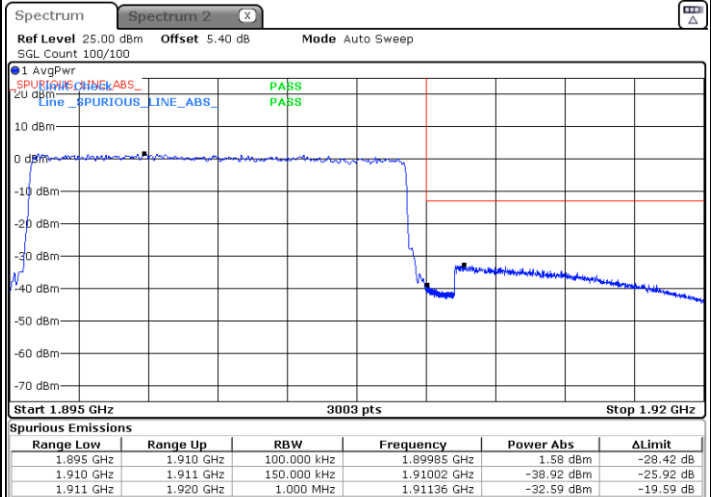

Date: 18.AUG.2022 15:10:14



LTE Band 2 / 15MHz / 64QAM

Lowest Band Edge / 1 RB

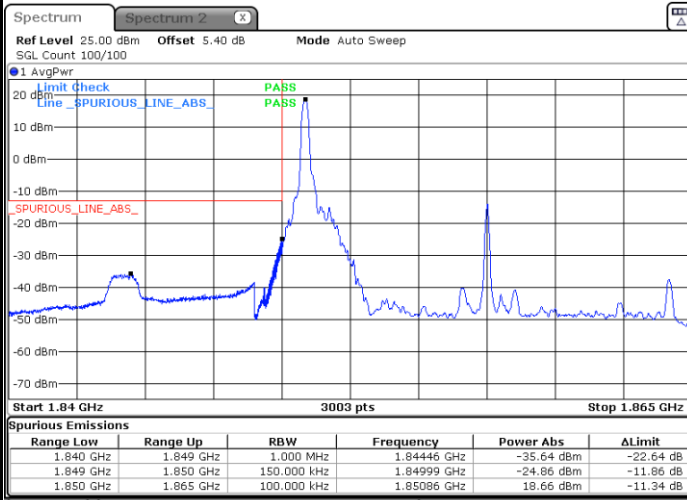

Date: 18.AUG.2022 15:03:20

Highest Band Edge / 1 RB

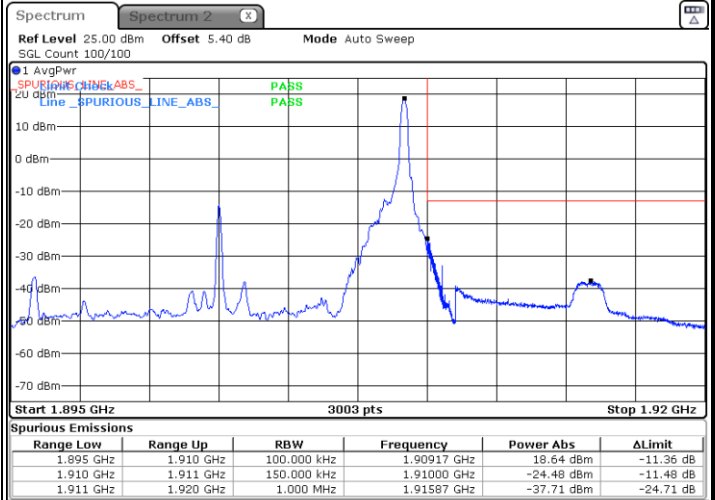

Date: 18.AUG.2022 15:09:04

Lowest Band Edge / Full RB

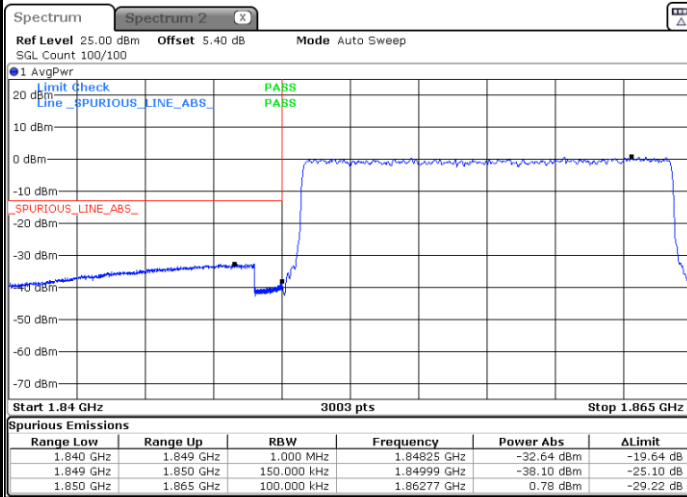

Date: 18.AUG.2022 15:03:55

Highest Band Edge / Full RB

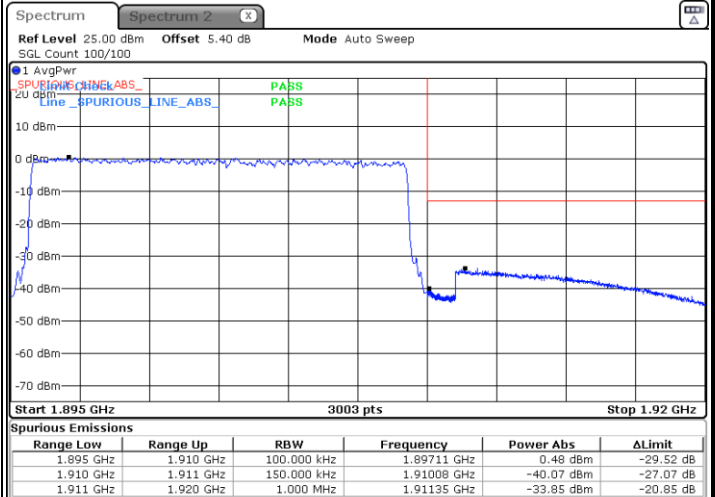

Date: 18.AUG.2022 15:09:39



LTE Band 2 / 20MHz / QPSK

Lowest Band Edge / 1 RB

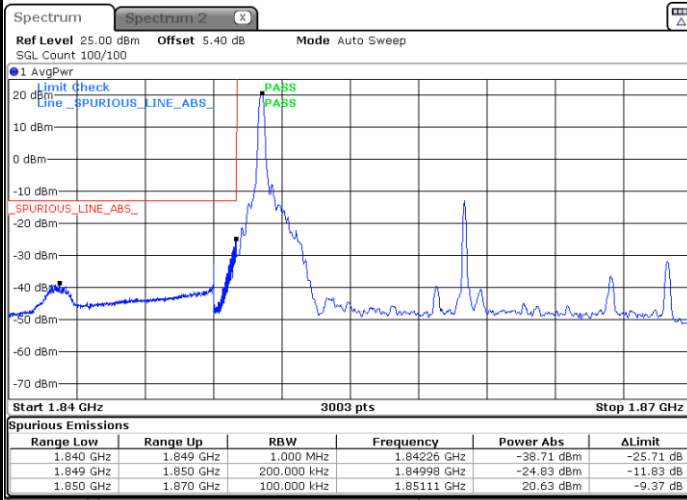

Date: 18.AUG.2022 15:12:32

Highest Band Edge / 1 RB

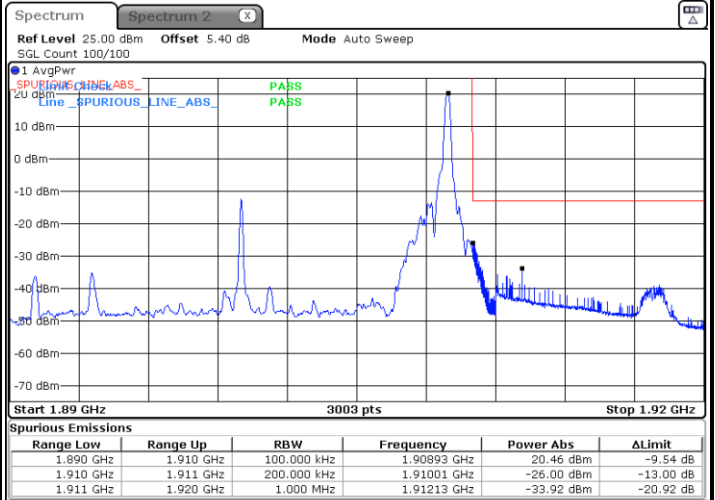

Date: 18.AUG.2022 15:18:15

Lowest Band Edge / Full RB

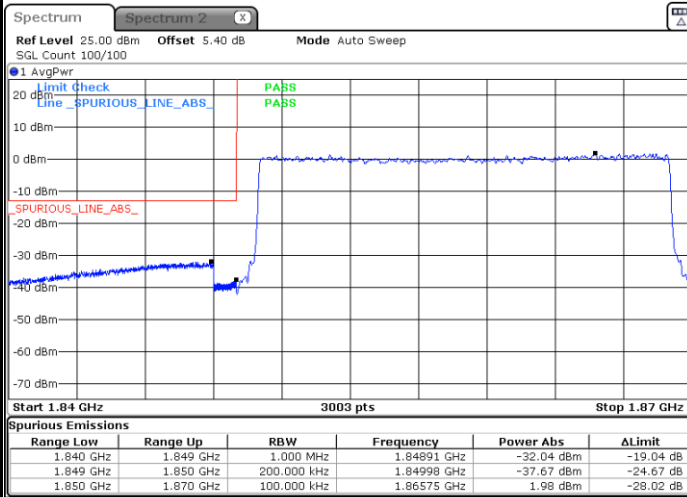

Date: 18.AUG.2022 15:15:26

Highest Band Edge / Full RB

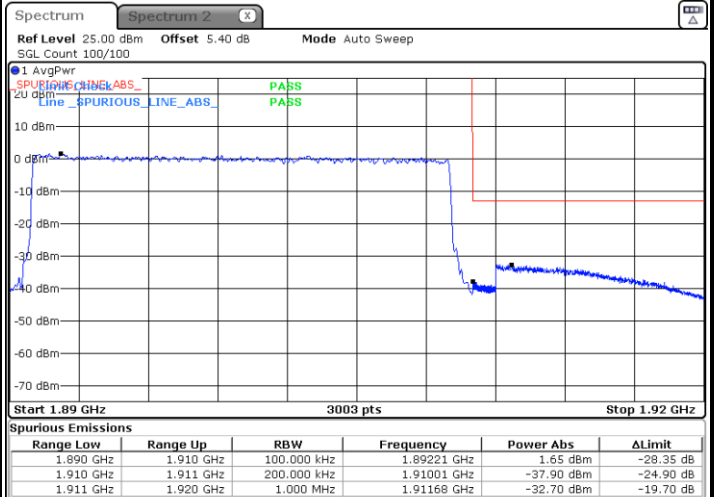

Date: 18.AUG.2022 15:21:09



LTE Band 2 / 20MHz / 16QAM

Lowest Band Edge / 1 RB

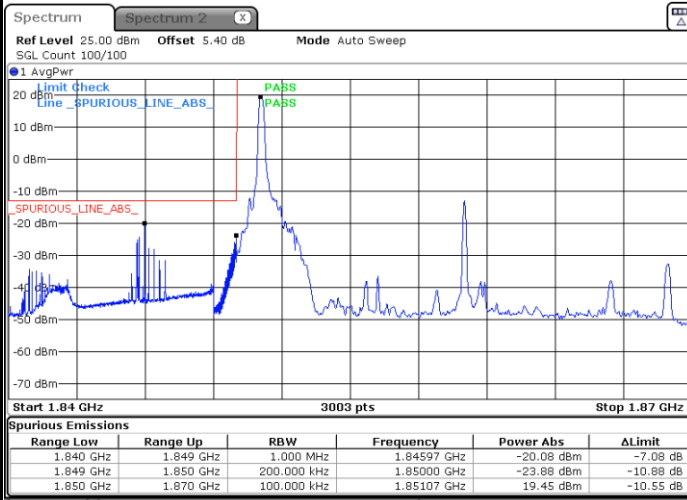

Date: 18.AUG.2022 15:13:07

Highest Band Edge / 1 RB

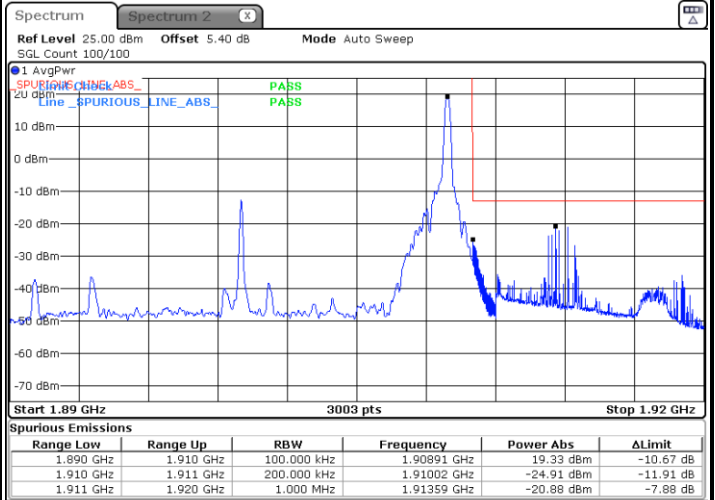

Date: 18.AUG.2022 15:18:50

Lowest Band Edge / Full RB

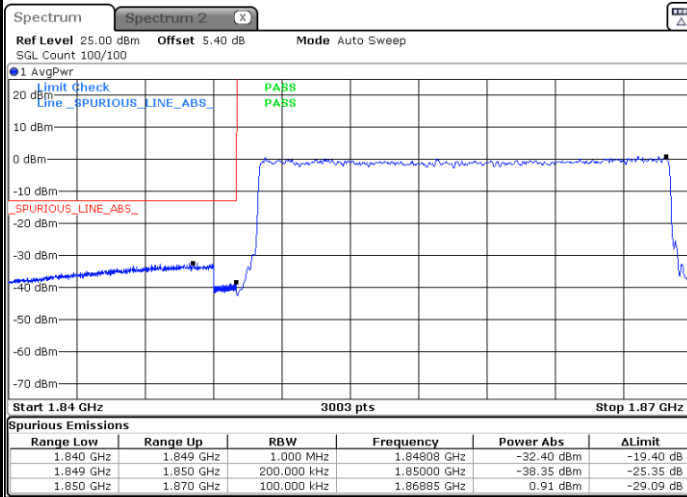

Date: 18.AUG.2022 15:14:51

Highest Band Edge / Full RB

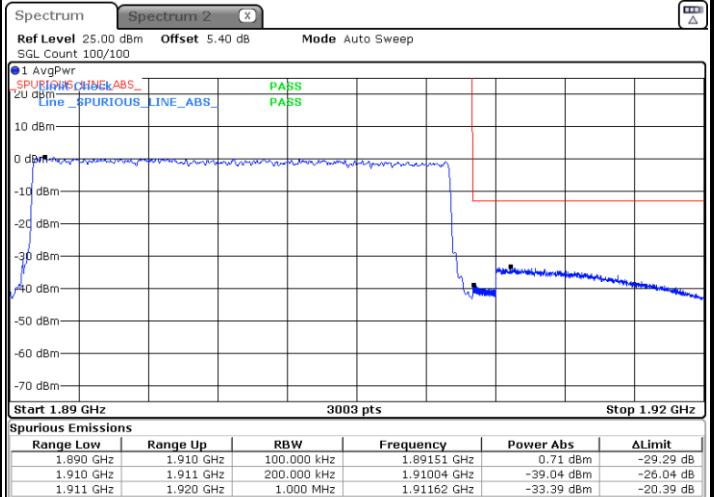

Date: 18.AUG.2022 15:20:35



LTE Band 2 / 20MHz / 64QAM

Lowest Band Edge / 1 RB

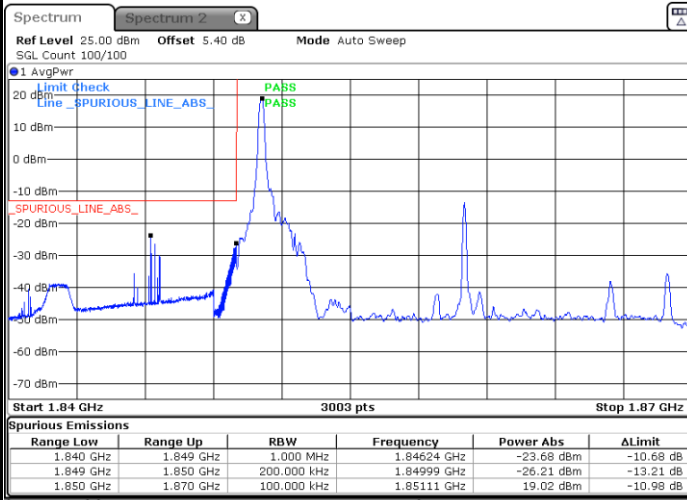

Date: 18.AUG.2022 15:13:41

Highest Band Edge / 1 RB

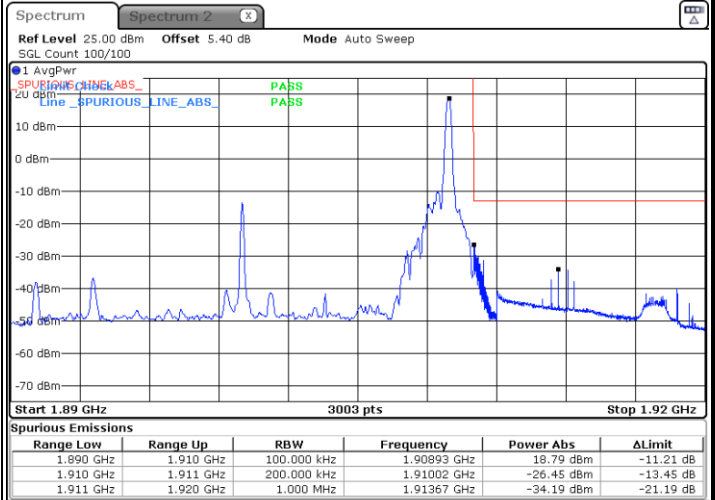

Date: 18.AUG.2022 15:19:25

Lowest Band Edge / Full RB

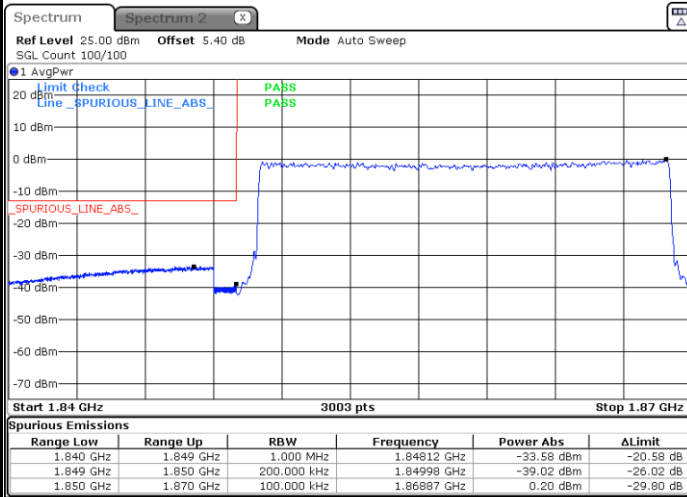

Date: 18.AUG.2022 15:14:16

Highest Band Edge / Full RB

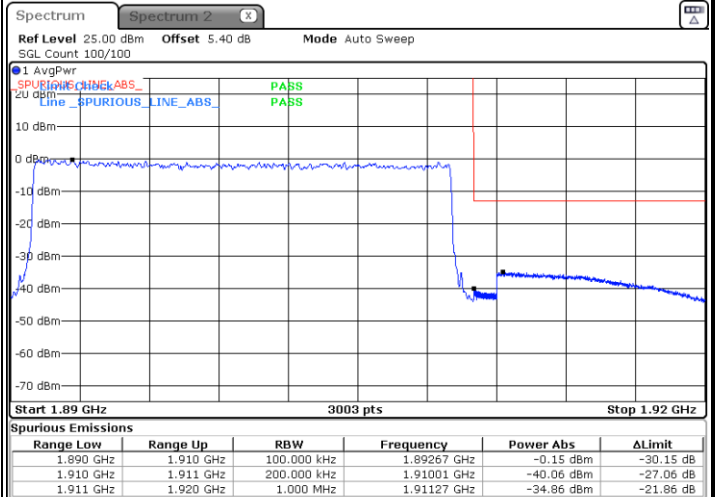

Date: 18.AUG.2022 15:20:00