



FCC RF Test Report

APPLICANT : Lenovo(Shanghai) Electronics Technology Co., Ltd.
EQUIPMENT : Portable Tablet Computer
BRAND NAME : Lenovo
MODEL NAME : TB128XU
FCC ID : O57TB128XU
STANDARD : 47 CFR Part 2, and 90(S)
CLASSIFICATION : PCS Licensed Transmitter (PCB)
Test Date(s) : Mar. 11, 2022 ~ Mar. 18, 2022

We, Sporton International Inc. (Kunshan), would like to declare that the tested sample has been evaluated in accordance with the procedures given in ANSI C63.26-2015 and shown compliance with the applicable technical standards.

The test results in this report apply exclusively to the tested model / sample. Without written approval of Sporton International Inc. (Kunshan), the test report shall not be reproduced except in full.

Jason Jia

Reviewed by: Jason Jia / Supervisor

Alex Wang

Approved by: Alex Wang / Manager



Sporton International Inc. (Kunshan)

**No. 1098, Pengxi North Road, Kunshan Economic Development Zone Jiangsu Province 215300
People's Republic of China**



TABLE OF CONTENTS

REVISION HISTORY..... 3

SUMMARY OF TEST RESULT 4

1 GENERAL DESCRIPTION 5

 1.1 Applicant..... 5

 1.2 Manufacturer 5

 1.3 Feature of Equipment Under Test..... 5

 1.4 Product Specification of Equipment Under Test 5

 1.5 Modification of EUT 5

 1.6 Maximum Conducted Power and Emission Designator 6

 1.7 Testing Site..... 6

 1.8 Test Software 6

 1.9 Applied Standards 7

2 TEST CONFIGURATION OF EQUIPMENT UNDER TEST 8

 2.1 Test Mode..... 8

 2.2 Connection Diagram of Test System 9

 2.3 Support Unit used in test configuration and system 9

 2.4 Measurement Results Explanation Example 9

 2.5 Frequency List of Low/Middle/High Channels 10

3 TEST RESULT 11

 3.1 Conducted Output Power Measurement 11

 3.2 99% Occupied Bandwidth and 26dB Bandwidth Measurement..... 12

 3.3 Emissions Mask Measurement 13

 3.4 Emissions Mask – Out Of Band Emissions Measurement..... 15

 3.5 Field Strength of Spurious Radiation Measurement 16

 3.6 Frequency Stability Measurement..... 19

4 LIST OF MEASURING EQUIPMENT 21

5 UNCERTAINTY OF EVALUATION 22

APPENDIX A. TEST RESULTS OF CONDUCTED TEST

APPENDIX B. TEST RESULTS OF RADIATED TEST

APPENDIX C. TEST SETUP PHOTOGRAPHS



REVISION HISTORY

REPORT NO.	VERSION	DESCRIPTION	ISSUED DATE
FG230211C	Rev. 01	Initial issue of report	Apr. 09, 2022



SUMMARY OF TEST RESULT

Report Section	FCC Rule	Description	Limit	Result	Remark
3.1	§2.1046	Conducted Output Power	—	Report only	-
3.2	§2.1049 §90.209	Occupied Bandwidth and 26dB Bandwidth	—	Report only	-
3.3	§2.1051 §90.691	Emission masks – In-band emissions	$< 50+10\log_{10}(P[\text{Watts}])$	PASS	-
3.4	§2.1051 §90.691	Emission masks – Out of band emissions	$< 43+10\log_{10}(P[\text{Watts}])$	PASS	-
3.5	§2.1053 §90.691	Field Strength of Spurious Radiation	$< 43+10\log_{10}(P[\text{Watts}])$	PASS	Under limit 40.02 dB at 2440.00 MHz
3.6	§2.1055 §90.213	Frequency Stability for Temperature & Voltage	$< 2.5 \text{ ppm}$	PASS	-

Declaration of Conformity:

The test results with all measurement uncertainty excluded are presented in accordance with the regulation limits or requirements declared by manufacturers.

Comments and Explanations:

The declared of product specification for EUT presented in the report are provided by the manufacturer, and the manufacturer takes all the responsibilities for the accuracy of product specification.



1 General Description

1.1 Applicant

Lenovo(Shanghai) Electronics Technology Co., Ltd.

Section 304-305, Building No. 4, # 222, Meiyue Road, China (Shanghai) Pilot Free Trade Zone

1.2 Manufacturer

Lenovo PC HK Limited

23/F, Lincoln House, Taikoo Place 979 King's Road, Quarry Bay, Hong Kong, China

1.3 Feature of Equipment Under Test

Product Feature	
Equipment	Portable Tablet Computer
Brand Name	Lenovo
Model Name	TB128XU
FCC ID	O57TB128XU
HW Version	Lenovo TB128XU
SW Version	TB128XU_RF01_220301
EUT Stage	Identical Prototype

Remark: The above EUT's information was declared by manufacturer. Please refer to the specifications or user's manual for more detailed description.

1.4 Product Specification of Equipment Under Test

Product Specification subjective to this standard	
Tx Frequency	814 ~ 824 MHz
Rx Frequency	859 ~ 869 MHz
Bandwidth	1.4MHz / 3MHz / 5MHz / 10MHz / 15MHz
Maximum Output Power to Antenna	24.09 dBm
Antenna Gain / Type	-1.12 dBi / IFA Antenna
Type of Modulation	QPSK / 16QAM / 64QAM

1.5 Modification of EUT

No modifications are made to the EUT during all test items.



1.6 Maximum Conducted Power and Emission Designator

LTE Band 26		QPSK		16QAM/64QAM	
BW (MHz)	Frequency Range (MHz)	Maximum Conducted power (W)	Emission Designator (99%OBW)	Maximum Conducted power (W)	Emission Designator (99%OBW)
10	819	0.2559	9M05G7D	0.2128	9M09W7D
15	821.5	0.2564	13M4G7D	0.2128	13M5W7D

Note: All modulations have been tested, only the maximum bandwidth and the worst modulation of PSK/QAM are shown in the report.

1.7 Testing Site

Sporton International Inc. (Kunshan) is accredited to ISO/IEC 17025:2017 by American Association for Laboratory Accreditation with Certificate Number 5145.02.

Test Firm	Sporton International Inc. (Kunshan)		
Test Site Location	No. 1098, Pengxi North Road, Kunshan Economic Development Zone Jiangsu Province 215300 People's Republic of China TEL : +86-512-57900158 FAX : +86-512-57900958		
Test Site No.	Sporton Site No.	FCC Designation No.	FCC Test Firm Registration No.
	03CH02-KS TH01-KS	CN1257	314309

1.8 Test Software

Item	Site	Manufacturer	Name	Version
1.	03CH02-KS	AUDIX	E3	6.2009-8-24a



1.9 Applied Standards

According to the specifications of the manufacturer, the EUT must comply with the requirements of the following standards:

- ♦ 47 CFR Part 2, 90(S)
- ♦ ANSI C63.26-2015
- ♦ FCC KDB 971168 D01 Power Meas. License Digital Systems v03r01
- ♦ FCC KDB 971168 D02 Misc Rev Approv License Devices v02r01

Remark:

1. All test items were verified and recorded according to the standards and without any deviation during the test.
2. This EUT has also been tested and complied with the requirements of FCC Part 15, Subpart B, recorded in a separate test report.



2 Test Configuration of Equipment Under Test

2.1 Test Mode

During all testing, EUT is in link mode with base station emulator at maximum power level. The spurious emission measurements were carried out in semi-anechoic chamber with 3-meter test range, and EUT is rotated on three test planes to find out the worst emission.

Frequency range investigated for radiated emission is 30 MHz to 9000 MHz.

Test Items	Band	Bandwidth (MHz)						Modulation				RB #			Test Channel			
		1.4	3	5	10	15	20	QPSK	16QAM	64QAM	256QAM	1	Half	Full	L	M	H	
Max. Output Power	26	v	v	v	v	v	-	v	v	v	-	v	v	v	v	v	v	
26dB and 99% Bandwidth	26				v		-	v	v		-			v		v		
	26					v	-	v	v		-			v	v			
Emission masks In-band emissions	26	v	v	v	v	v	-	v	v	v	-	v		v	v		v	
Emission masks - Out of band emissions	26	v	v	v	v	v	-	v	v		-	v				v	v	v
Frequency Stability	26				v		-	v			-			v		v		
Radiated Spurious Emission	26	Worst case															v	
Note	<ol style="list-style-type: none"> The mark "v" means that this configuration is chosen for testing The mark "-" means that this bandwidth is not supported. LTE Band26 transmit frequency for part22 rule is 824MHz-849MHz, for part90 rule is 814MHz-824MHz. ERP over 15MHz bandwidth complies the ERP limit line of part22 rule, therefore ERP of the partial frequency spectrum which falls within part 22 also complies. 																	

2.2 Connection Diagram of Test System

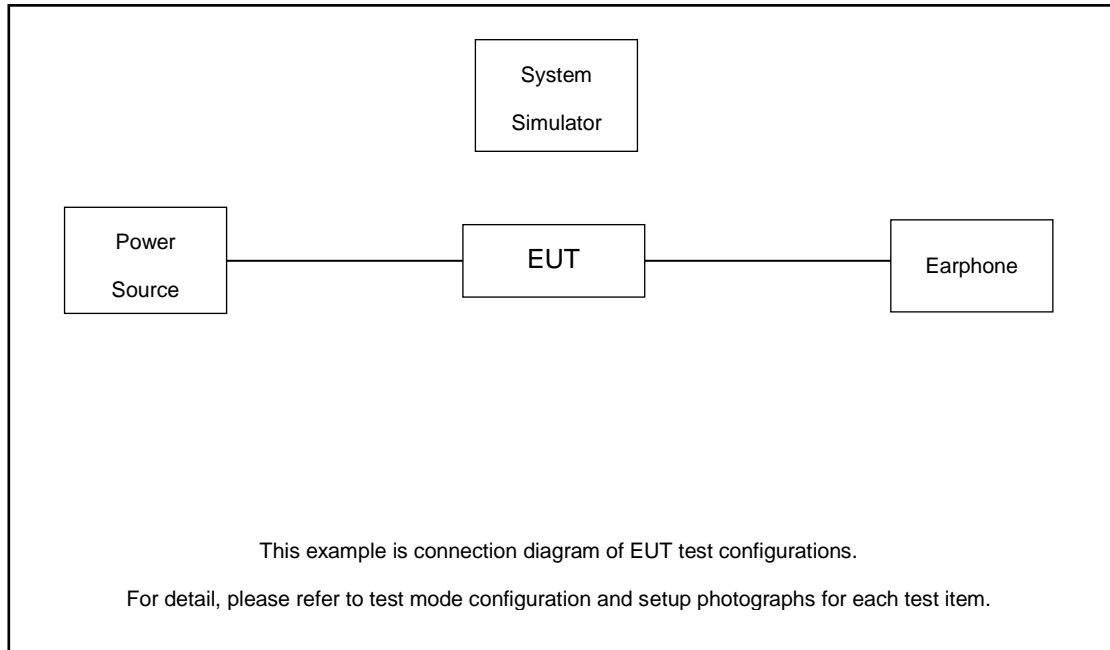

2.3 Support Unit used in test configuration and system

Item	Equipment	Trade Name	Model No.	FCC ID	Data Cable	Power Cord
1.	System Simulator	Anritsu	MT8820C	N/A	N/A	Unshielded, 1.8 m
2.	Earphone	N/A	N/A	N/A	N/A	N/A

2.4 Measurement Results Explanation Example

For all conducted test items:

The offset level is set in the spectrum analyzer to compensate the RF cable loss between RF conducted output port and spectrum analyzer. With the offset compensation, the spectrum analyzer reading level will be exactly the RF output level.

The spectrum analyzer offset is derived from RF cable loss.

$Offset = RF\ cable\ loss.$

The following shows an offset computation example with RF cable loss 4.80 dB

Example :

$Offset(dB) = RF\ cable\ loss(dB).$
= 4.80 (dB)



2.5 Frequency List of Low/Middle/High Channels

LTE Band 26 Channel and Frequency List				
BW [MHz]	Channel/Frequency(MHz)	Lowest	Middle	Highest
15	Channel	26765	-	-
	Frequency	821.5	-	-
10	Channel	-	26740	-
	Frequency	-	819	-
5	Channel	26715	26740	26765
	Frequency	816.5	819	821.5
3	Channel	26705	26740	26775
	Frequency	815.5	819	822.5
1.4	Channel	26697	26740	26783
	Frequency	814.7	819	823.3

3 Test Result

3.1 Conducted Output Power Measurement

3.1.1 Description of the Conducted Output Power Measurement

A system simulator was used to establish communication with the EUT. Its parameters were set to enforce EUT transmitting at the maximum power. The measured power in the radio frequency on the transmitter output terminals shall be reported.

3.1.2 Measuring Instruments

The measuring equipment is listed in the section 4 of this test report.

3.1.3 Test Procedures

1. The transmitter output port was connected to the system simulator.
2. Set EUT at maximum power through the system simulator.
3. Select lowest, middle, and highest channels for each band and different modulation.
4. Measure and record the power level from the system simulator.

3.1.4 Test Setup

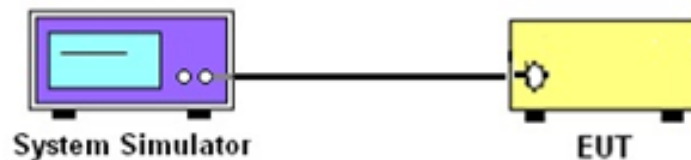

3.1.5 Test Result of Conducted Output Power

Please refer to Appendix A.

3.2 99% Occupied Bandwidth and 26dB Bandwidth Measurement

3.2.1 Description of (Occupied) Bandwidth Limitations Measurement

The 99% occupied bandwidth is the width of a frequency band such that, below the lower and above the upper frequency limits, the mean powers emitted are each equal to a specified percentage 0.5% of the total mean transmitted power.

The emission bandwidth is defined as the width of the signal between two points, located at the 2 sides of the carrier frequency, outside of which all emissions are attenuated at least 26 dB below the transmitter power.

3.2.2 Measuring Instruments

The measuring equipment is listed in the section 4 of this test report.

3.2.3 Test Procedures

1. The EUT was connected to spectrum analyzer and system simulator via a power divider.
2. The 26dB and 99% occupied bandwidth (BW) of the middle channel for the highest RF power with full RB sizes were measured.

3.2.4 Test Setup



3.2.5 Test Result of 99% Occupied Bandwidth and 26dB Bandwidth

Please refer to Appendix A.



3.3 Emissions Mask Measurement

3.3.1 Description of Emissions Mask Measurement

Equipment used in this licensed to EA or non-EA systems shall comply with the emission mask provisions of FCC Part 90.691.(a):

(a) Out-of-band emission requirement shall apply only to the “outer” channels included in an EA license and to spectrum adjacent to interior channels used by incumbent licensees. The emission limits are as follows:

(1) For any frequency removed from the EA licensee's frequency block by up to and including 37.5 kHz, the power of any emission shall be attenuated below the transmitter power (P) in watts by at least $116 \text{ Log}_{10}(f/6.1)$ decibels or $50 + 10 \text{ Log}_{10}(P)$ decibels or 80 decibels, whichever is the lesser attenuation, where f is the frequency removed from the center of the outer channel in the block in kilohertz and where f is greater than 12.5 kHz.

(2) For any frequency removed from the EA licensee's frequency block greater than 37.5 kHz, the power of any emission shall be attenuated below the transmitter power (P) in watts by at least $43 + 10 \text{ Log}_{10}(P)$ decibels or 80 decibels, whichever is the lesser attenuation, where f is the frequency removed from the center of the outer channel in the block in kilohertz and where f is greater than 37.5 kHz.

3.3.2 Measuring Instruments

The measuring equipment is listed in the section 4 of this test report.

3.3.3 Test Procedures

1. The EUT was connected to spectrum analyzer and base station via power divider.
2. The emissions mask of low and high channels for the highest RF powers were measured.
3. The measured RBW and the VBW set 3 times of RBW are then set in spectrum analyzer, and the RBW correction factor $10 \text{ log} (1\% \text{ of OBW}/\text{measured RBW})(\text{dB})$ was compensated, if required.
4. The test results were shown below plots with a correction offset factor including cable loss, insertion loss of power divider.

3.3.4 Test Setup

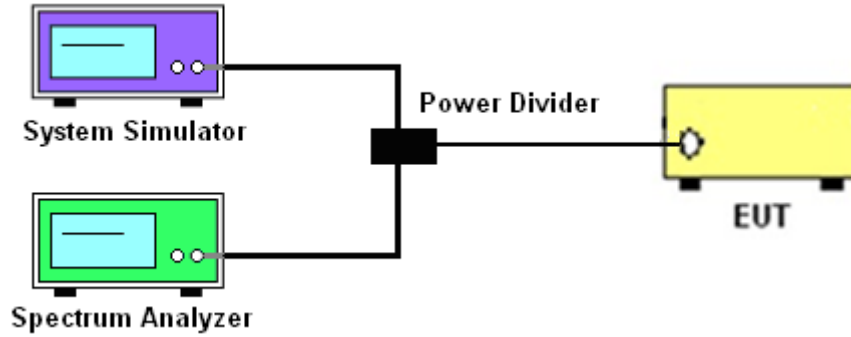

3.3.5 Test Result (Plots) of Conducted Emissions Mask

Please refer to Appendix A.

3.4 Emissions Mask – Out Of Band Emissions Measurement

3.4.1 Description of Conducted Emissions Out of band emissions measurement

The power of any emission FCC Part 90.691 (a)(2) on any frequency removed from the assigned frequency by out of the authorized bandwidth at least $43 + 10 \log (P)$ dB. It is measured by means of a calibrated spectrum analyzer and scanned from 30 MHz up to a frequency including its 10th harmonic.

3.4.2 Measuring Instruments

The measuring equipment is listed in the section 4 of this test report.

3.4.3 Test Procedures

1. The EUT was connected to spectrum analyzer and system simulator via a power divider.
2. The RF output of EUT was connected to the spectrum analyzer by RF cable and attenuator. The path loss was compensated to the results for each measurement.
3. The middle channel for the highest RF power within the transmitting frequency was measured.
4. The conducted spurious emission for the whole frequency range was taken.
5. Make the measurement with the spectrum analyzer's RBW = 1MHz, VBW = 3MHz, taking the record of maximum spurious emission.
6. The RF fundamental frequency should be excluded against the limit line in the operating frequency band.
7. The limit line is derived from $43 + 10\log(P)$ dB below the transmitter power P(Watts)

3.4.4 Test Setup

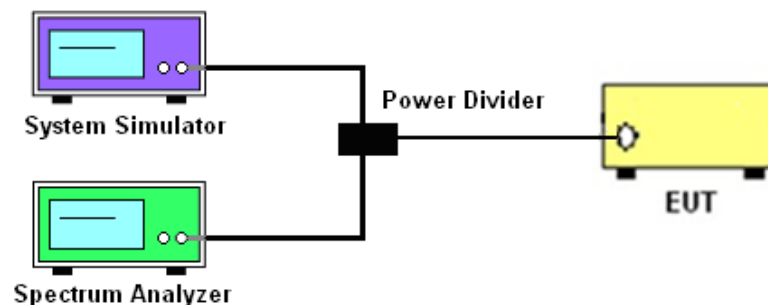

3.4.5 Test Result (Plots) of Conducted Emission

Please refer to Appendix A.



3.5 Field Strength of Spurious Radiation Measurement

3.5.1 Description of Field Strength of Spurious Radiated Measurement

The radiated spurious emission was measured by substitution method according to ANSI/TIA-603-E. The power of any emission FCC Part 90.691 on any frequency removed from the assigned frequency by more than 250 percent of the authorized bandwidth at least $43 + 10 \log (P)$ dB. The spectrum is scanned from 30 MHz up to a frequency including its 10th harmonic.

The power of any emission outside of the authorized operating frequency ranges must be attenuated below the transmitter power (P) by a factor of at least $43 + 10 \log_{10}(P[\text{Watts}])$ dB. The spectrum is scanned from 30 MHz up to a frequency including its 10th harmonic.

3.5.2 Measuring Instruments

The measuring equipment is listed in the section 4 of this test report.

3.5.3 Test Procedures

1. The EUT was placed on a turntable with 0.8 meter for frequency below 1GHz and 1.5 meter for frequency above 1GHz respectively above ground.
2. The EUT was set 3 meters from the receiving antenna, which was mounted on the antenna tower.
3. The table was rotated 360 degrees to determine the position of the highest spurious emission.
4. The height of the receiving antenna is varied between one meter and four meters to search the maximum spurious emission for both horizontal and vertical polarizations.
5. Make the measurement with the spectrum analyzer's RBW = 1MHz, VBW = 3MHz, Sweep = 500ms, Taking the record of maximum spurious emission.
6. A horn antenna was substituted in place of the EUT and was driven by a signal generator.
7. Tune the output power of signal generator to the same emission level with EUT maximum spurious emission.
8. Taking the record of output power at antenna port.
9. Repeat step 7 to step 8 for another polarization.
10. $\text{EIRP (dBm)} = \text{S.G. Power} - \text{Tx Cable Loss} + \text{Tx Antenna Gain}$
11. $\text{ERP (dBm)} = \text{EIRP} - 2.15$
12. The RF fundamental frequency should be excluded against the limit line in the operating frequency band.
13. The limit line is derived from $43 + 10 \log(P)$ dB below the transmitter power P(Watts)

3.5.4 Test Setup

For radiated test from 30MHz



For radiated test from 30MHz to 1GHz

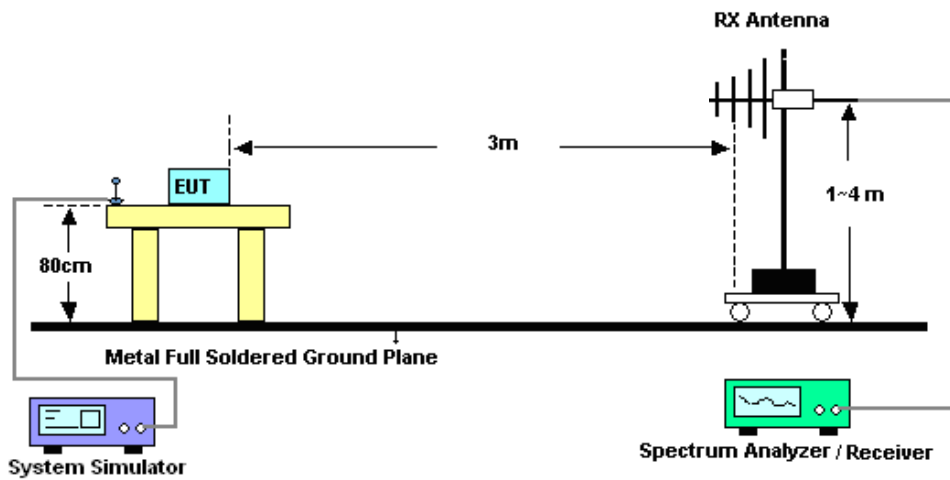

For radiated test above 1GHz

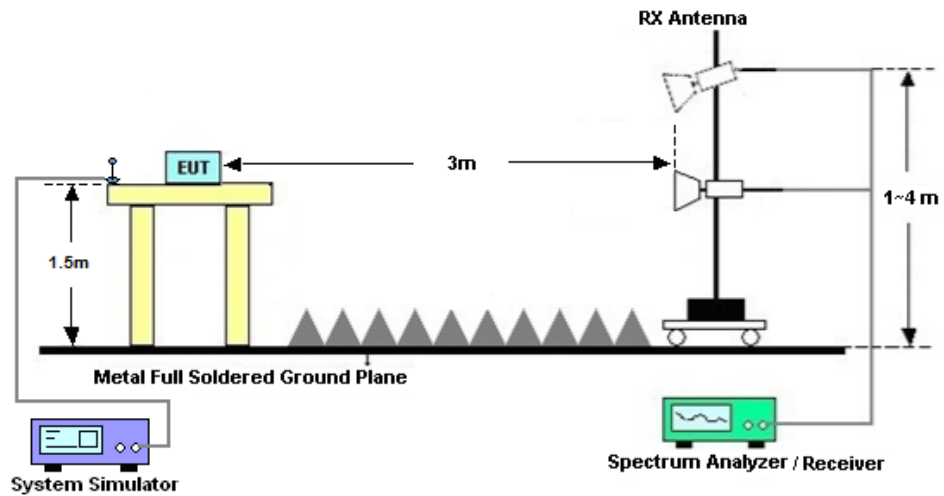

3.5.5 Test Result of Field Strength of Spurious Radiated

The low frequency, which started from 9 kHz to 30MHz, was pre-scanned and the result which was 20dB lower than the limit line was not reported.

Please refer to Appendix B.



3.6 Frequency Stability Measurement

3.6.1 Description of Frequency Stability Measurement

The frequency stability shall be measured by variation of ambient temperature and variation of primary supply voltage to ensure that the fundamental emission stays within the authorized frequency block. The frequency stability of the transmitter shall be maintained within $\pm 0.00025\%$ ($\pm 2.5\text{ppm}$) of the center frequency according to FCC Part 90.213.

3.6.2 Measuring Instruments

The measuring equipment is listed in the section 4 of this test report.

3.6.3 Test Procedures for Temperature Variation

1. The EUT was set up in the thermal chamber and connected with the base station.
2. With power OFF, the temperature was decreased to -30°C and the EUT was stabilized for three hours. Power was applied and the maximum change in frequency was recorded within one minute.
3. With power OFF, the temperature was raised in 10°C step up to 50°C . The EUT was stabilized at each step for at least half an hour. Power was applied and the maximum frequency change was recorded within one minute.

3.6.4 Test Procedures for Voltage Variation

1. The EUT was placed in a temperature chamber at $20\pm 5^{\circ}\text{C}$ and connected with the system simulator.
2. The power supply voltage to the EUT was varied from 85% to 115% of the nominal value for other than hand carried battery equipment.
3. For hand carried, battery powered equipment, reduce the primary ac or dc supply voltage to the battery operating end point, which shall be specified by the manufacturer.
4. The variation in frequency was measured for the worst case.

3.6.5 Test Setup



3.6.6 Test Result of Temperature Variation

Please refer to Appendix A.



4 List of Measuring Equipment

Instrument	Manufacturer	Model No.	Serial No.	Characteristics	Calibration Date	Test Date	Due Date	Remark
Spectrum Analyzer	R&S	FSV40	101040	10Hz~40GHz	Oct. 14, 2021	Mar. 11, 2022	Oct. 13, 2022	Conducted (TH01-KS)
Power divider	STI	STI08-0055	-	0.5~40GHz	Aug. 26, 2021	Mar. 11, 2022	Aug. 25, 2022	Conducted (TH01-KS)
Temperature & humidity chamber	Hongzhan	LP-150U	H2014011440	-40~+150°C 20%~95%RH	Jul. 12, 2021	Mar. 11, 2022	Jul. 11, 2022	Conducted (TH01-KS)
EMI Test Receiver	R&S	ESR7	101403	9kHz~7GHz;Max 30dBm	Oct. 16, 2021	Mar. 18, 2022	Oct. 15, 2022	Radiation (03CH02-KS)
EXA Spectrum Analyzer	Keysight	N9010A	MY55370528	10Hz-44G,MAX 30dB	Oct. 16, 2021	Mar. 18, 2022	Oct. 15, 2022	Radiation (03CH02-KS)
Loop Antenna	R&S	HFH2-Z2	100321	9kHz~30MHz	Oct. 30, 2021	Mar. 18, 2022	Oct. 29, 2022	Radiation (03CH02-KS)
Bilog Antenna	TeseQ	CBL6111D	44483	30MHz-1GHz	Dec. 22, 2021	Mar. 18, 2022	Dec. 21, 2022	Radiation (03CH02-KS)
Double Ridge Horn Antenna	ETS-Lindgren	3117	75957	1GHz~18GHz	Oct. 30, 2021	Mar. 18, 2022	Oct. 29, 2022	Radiation (03CH02-KS)
SHF-EHF Horn	Com-power	AH-840	101070	18GHz~40GHz	Jan. 05, 2022	Mar. 18, 2022	Jan. 04, 2023	Radiation (03CH02-KS)
Amplifier	SONOMA	310N	187289	9KHz-1GHz	Apr. 13, 2021	Mar. 18, 2022	Apr. 12, 2022	Radiation (03CH02-KS)
high gain Amplifier	MITEQ	AMF-7D-00 101800-30-1 0P	2025788	1Ghz-18Ghz	Jul. 30, 2021	Mar. 18, 2022	Jul. 29, 2023	Radiation (03CH02-KS)
Amplifier	Keysight	83017A	MY53270316	500MHz~26.5GHz	Oct. 16, 2021	Mar. 18, 2022	Oct. 15, 2022	Radiation (03CH02-KS)
Amplifier	MITEQ	EM18G40G GA	060728	18~40GHz	Jan. 05, 2022	Mar. 18, 2022	Jan. 04, 2023	Radiation (03CH02-KS)
AC Power Source	Chroma	61601	616010002473	N/A	NCR	Mar. 18, 2022	NCR	Radiation (03CH02-KS)
Turn Table	MF	MF7802	N/A	0~360 degree	NCR	Mar. 18, 2022	NCR	Radiation (03CH02-KS)
Antenna Mast	MF	MF7802	N/A	1 m~4 m	NCR	Mar. 18, 2022	NCR	Radiation (03CH02-KS)

NCR: No Calibration Required



5 Uncertainty of Evaluation

The measurement uncertainties shown below were calculated in accordance with the requirements of ANSI 63.26-2015. All the measurement uncertainty value were shown with a coverage K=2 to indicate 95% level of confidence. The measurement data show herein meets or exceeds the CISPR measurement uncertainty values specified in CISPR 16-4-2 and can be compared directly to specified limit to determine compliance.

Uncertainty of Radiated Emission Measurement (30 MHz ~ 1000 MHz)

Measuring Uncertainty for a Level of Confidence of 95% (U = 2Uc(y))	2.5dB
---	-------

Uncertainty of Radiated Emission Measurement (1 GHz ~ 18 GHz)

Measuring Uncertainty for a Level of Confidence of 95% (U = 2Uc(y))	2.1dB
---	-------

----- THE END -----



Appendix A. Test Results of Conducted Test

Test Engineer :	Simle Wang	Temperature :	22~23°C
		Relative Humidity :	40~42%

Conducted Output Power (Average power)

BW [MHz]	Modulation	RB Size	RB Offset	Power Low Ch. / Freq.	Power Middle Ch. / Freq.	Power High Ch. / Freq.
Channel				26765		
Frequency (MHz)				821.5		
15	QPSK	1	0	23.97		
15	QPSK	1	37	23.86		
15	QPSK	1	74	24.09		
15	QPSK	36	0	22.99		
15	QPSK	36	20	22.80		
15	QPSK	36	39	22.73		
15	QPSK	75	0	22.93		
15	16QAM	1	0	23.28		
15	16QAM	1	37	23.11		
15	16QAM	1	74	23.04		
15	16QAM	36	0	22.04		
15	16QAM	36	20	22.15		
15	16QAM	36	39	21.98		
15	16QAM	75	0	21.88		
15	64QAM	1	0	22.14		
15	64QAM	1	37	21.95		
15	64QAM	1	74	21.96		
15	64QAM	36	0	21.05		
15	64QAM	36	20	20.89		
15	64QAM	36	39	20.97		
15	64QAM	75	0	20.87		
Channel					26740	
Frequency (MHz)					819	
10	QPSK	1	0		24.08	
10	QPSK	1	25		23.86	
10	QPSK	1	49		23.98	
10	QPSK	25	0		22.94	
10	QPSK	25	12		22.83	
10	QPSK	25	25		22.71	
10	QPSK	50	0		22.83	
10	16QAM	1	0		23.28	
10	16QAM	1	25		23.18	
10	16QAM	1	49		23.09	
10	16QAM	25	0		22.07	



10	16QAM	25	12		22.20	
10	16QAM	25	25		21.99	
10	16QAM	50	0		21.90	
10	64QAM	1	0		22.02	
10	64QAM	1	25		21.96	
10	64QAM	1	49		21.94	
10	64QAM	25	0		21.10	
10	64QAM	25	12		20.93	
10	64QAM	25	25		20.95	
10	64QAM	50	0		20.89	
Channel				26715	26740	26765
Frequency (MHz)				816.5	819	821.5
5	QPSK	1	0	23.90	24.07	23.95
5	QPSK	1	12	23.75	23.89	23.82
5	QPSK	1	24	23.85	23.92	23.90
5	QPSK	12	0	22.94	22.96	22.87
5	QPSK	12	7	22.70	22.86	22.73
5	QPSK	12	13	22.67	22.79	22.56
5	QPSK	25	0	22.84	22.85	22.82
5	16QAM	1	0	23.16	23.26	23.02
5	16QAM	1	12	23.04	23.15	23.03
5	16QAM	1	24	22.91	23.03	22.94
5	16QAM	12	0	21.89	22.10	22.10
5	16QAM	12	7	22.00	22.15	22.09
5	16QAM	12	13	21.95	22.03	21.85
5	16QAM	25	0	21.76	21.91	21.77
5	64QAM	1	0	22.06	22.04	22.08
5	64QAM	1	12	21.83	21.90	21.86
5	64QAM	1	24	21.89	21.96	21.88
5	64QAM	12	0	21.00	21.05	20.95
5	64QAM	12	7	20.81	20.84	20.84
5	64QAM	12	13	20.88	20.97	20.90
5	64QAM	25	0	20.82	20.92	20.80
Channel				26705	26740	26775
Frequency (MHz)				815.5	819	822.5
3	QPSK	1	0	23.88	24.05	23.97
3	QPSK	1	8	23.83	23.96	23.78
3	QPSK	1	14	23.85	24.00	23.84
3	QPSK	8	0	22.90	23.04	22.85
3	QPSK	8	4	22.67	22.83	22.65
3	QPSK	8	7	22.68	22.72	22.55
3	QPSK	15	0	22.81	22.92	22.81
3	16QAM	1	0	23.09	23.14	23.06
3	16QAM	1	8	23.02	23.11	23.04
3	16QAM	1	14	22.96	23.02	23.00
3	16QAM	8	0	21.97	22.07	22.11
3	16QAM	8	4	22.05	22.12	22.07



3	16QAM	8	7	21.85	22.00	21.95
3	16QAM	15	0	21.84	21.88	21.83
3	64QAM	1	0	22.11	22.08	22.05
3	64QAM	1	8	21.81	21.93	21.82
3	64QAM	1	14	21.89	21.99	21.83
3	64QAM	8	0	21.00	21.00	20.96
3	64QAM	8	4	20.84	20.89	20.81
3	64QAM	8	7	20.86	20.98	20.89
3	64QAM	15	0	20.75	20.91	20.78
Channel				26697	26740	26783
Frequency (MHz)				814.7	819	823.3
1.4	QPSK	1	0	23.90	24.00	23.92
1.4	QPSK	1	3	23.71	23.85	23.79
1.4	QPSK	1	5	23.90	23.95	23.87
1.4	QPSK	3	0	23.92	24.02	23.91
1.4	QPSK	3	1	23.66	23.80	23.75
1.4	QPSK	3	3	23.66	23.75	23.66
1.4	QPSK	6	0	22.86	22.84	22.77
1.4	16QAM	1	0	23.18	23.21	23.05
1.4	16QAM	1	3	23.02	23.14	23.03
1.4	16QAM	1	5	22.89	23.00	22.95
1.4	16QAM	3	0	22.94	23.13	23.05
1.4	16QAM	3	1	23.11	23.09	23.01
1.4	16QAM	3	3	22.84	23.00	22.89
1.4	16QAM	6	0	21.77	21.92	21.79
1.4	64QAM	1	0	22.08	22.08	22.08
1.4	64QAM	1	3	21.81	21.94	21.88
1.4	64QAM	1	5	21.85	22.01	21.88
1.4	64QAM	3	0	22.01	22.02	21.91
1.4	64QAM	3	1	21.74	21.87	21.87
1.4	64QAM	3	3	21.93	21.90	21.96
1.4	64QAM	6	0	20.80	20.91	20.72



26dB Bandwidth

Mode	LTE Band 26 : 26dB BW(MHz)	
BW	15MHz	
Mod.	QPSK	16QAM
Low CH	14.42	14.39

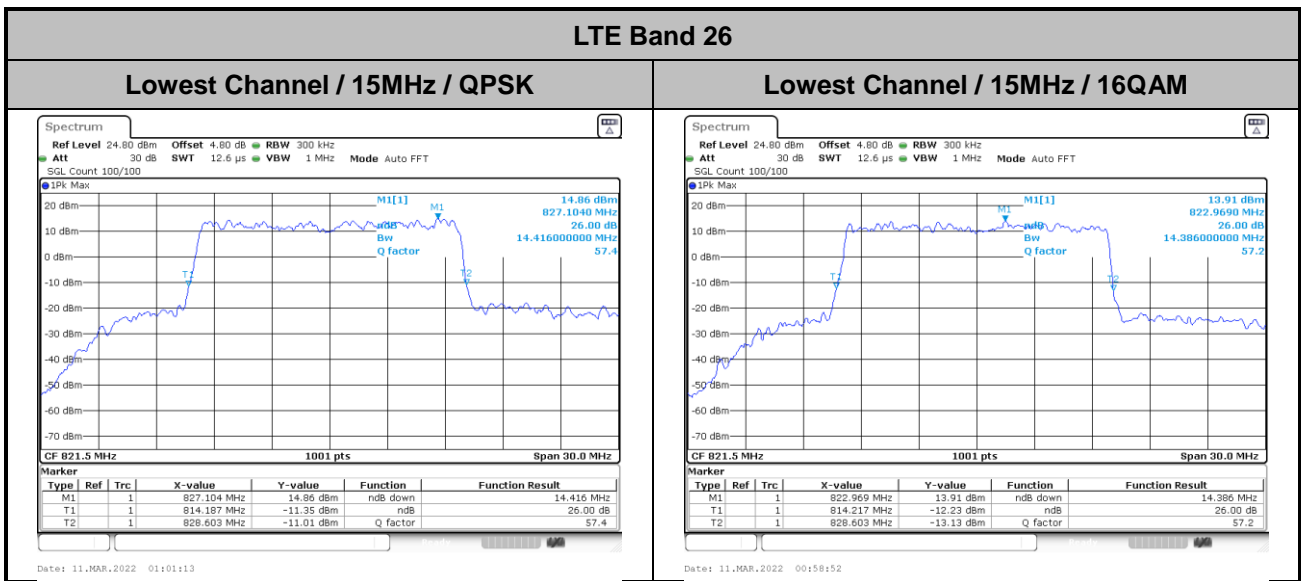



Mode	LTE Band 26 : 26dB BW(MHz)	
BW	10MHz	
Mod.	QPSK	16QAM
Mid CH	9.77	9.89

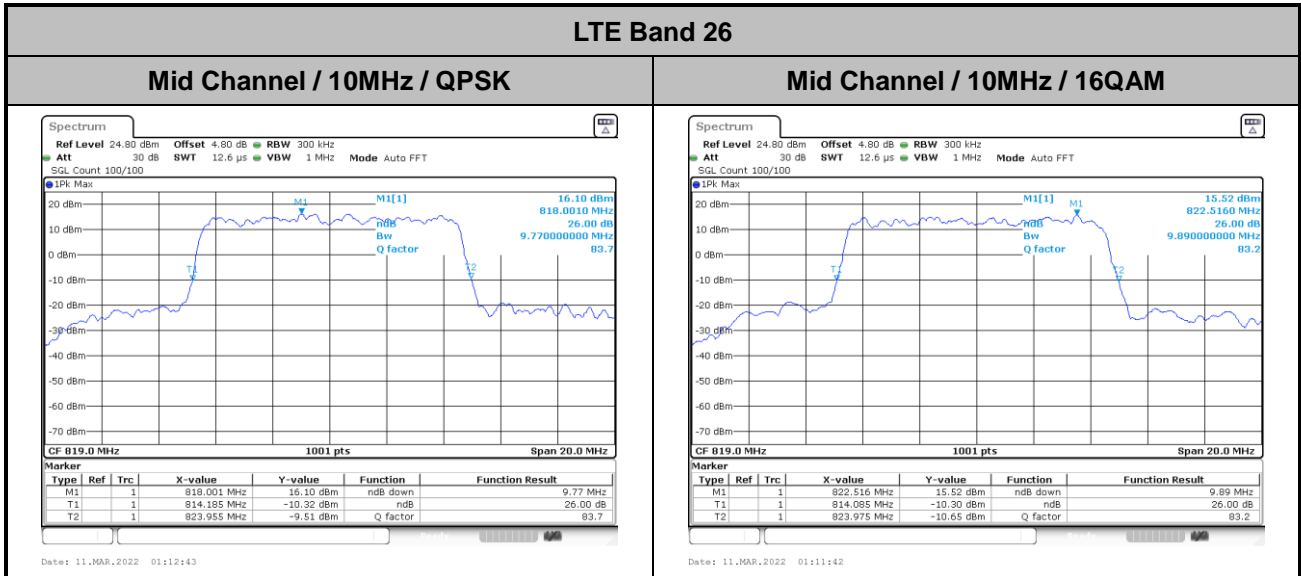



Occupied Bandwidth

Mode	LTE Band 26 : 99%OBW(MHz)	
BW	15MHz	
Mod.	QPSK	16QAM
Low CH	13.43	13.52

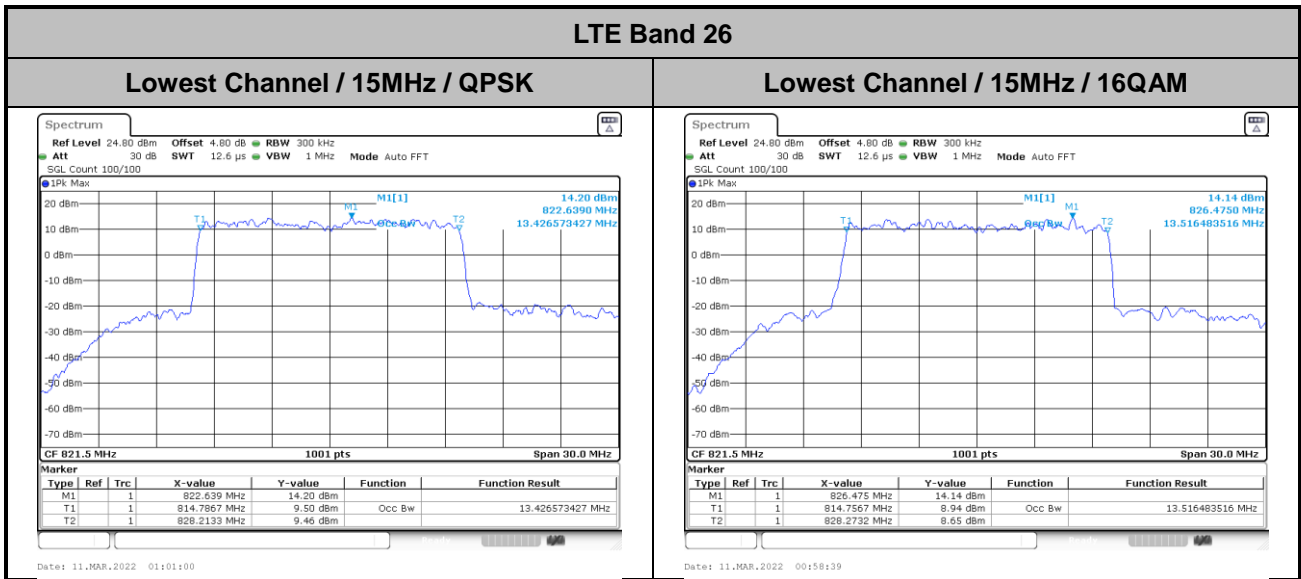



Mode	LTE Band 26 : 99%OBW(MHz)	
BW	10MHz	
Mod.	QPSK	16QAM
Mid CH	9.05	9.09

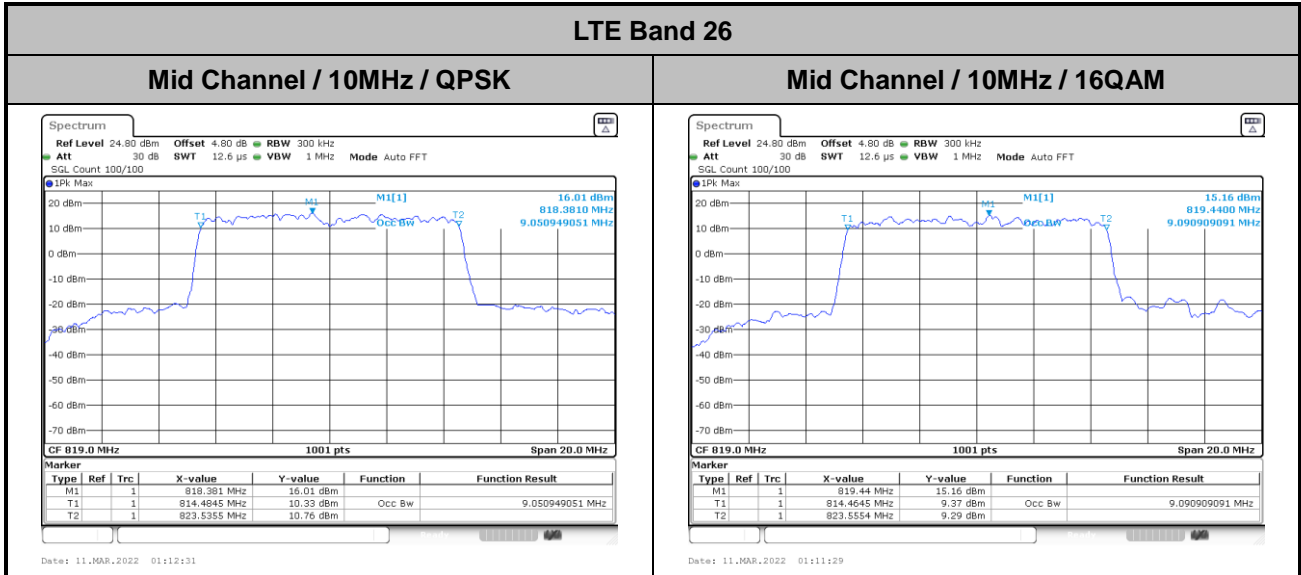



Conducted Band Edge

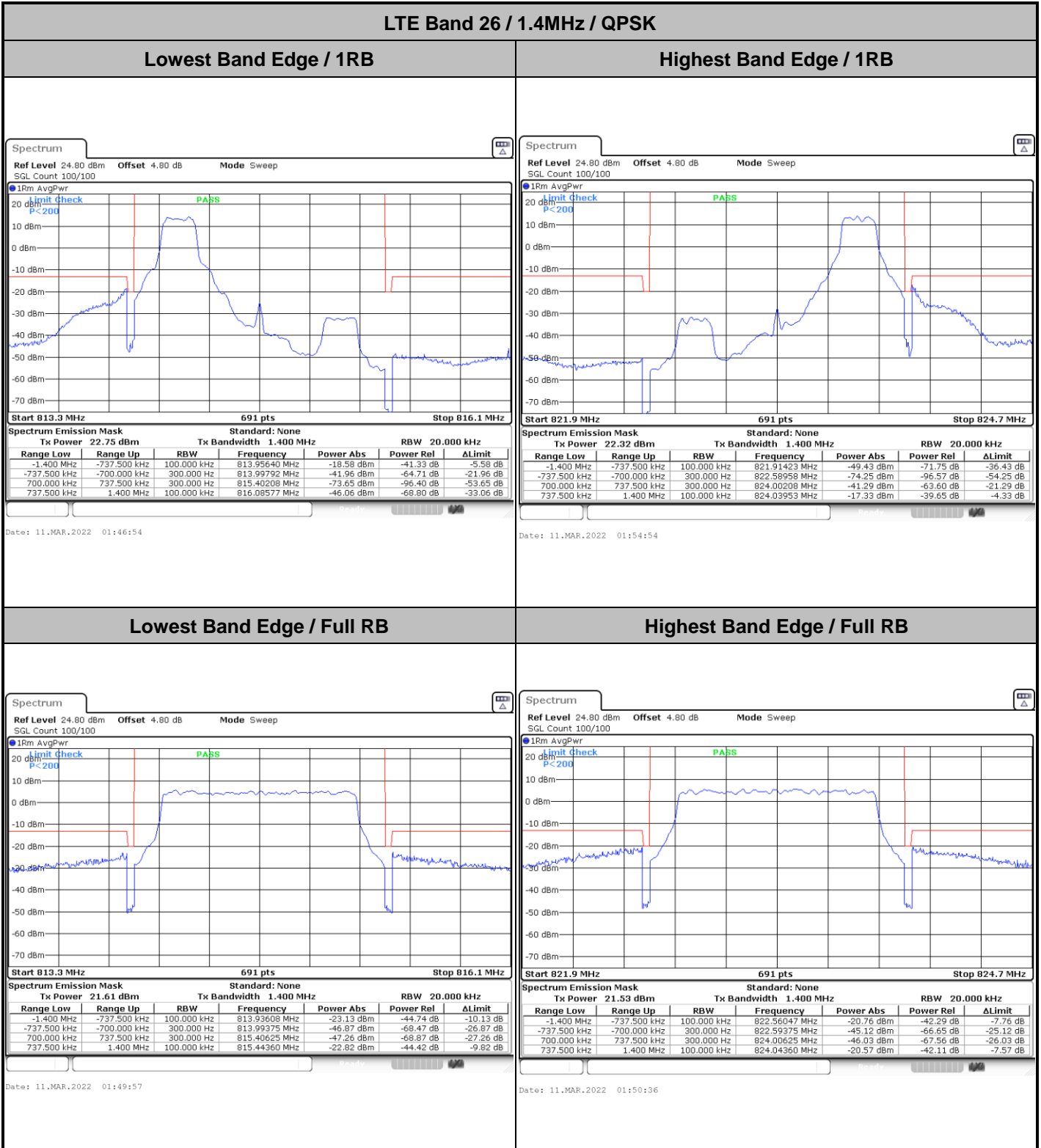



LTE Band 26 / 1.4MHz / 16QAM

Lowest Band Edge / 1 RB

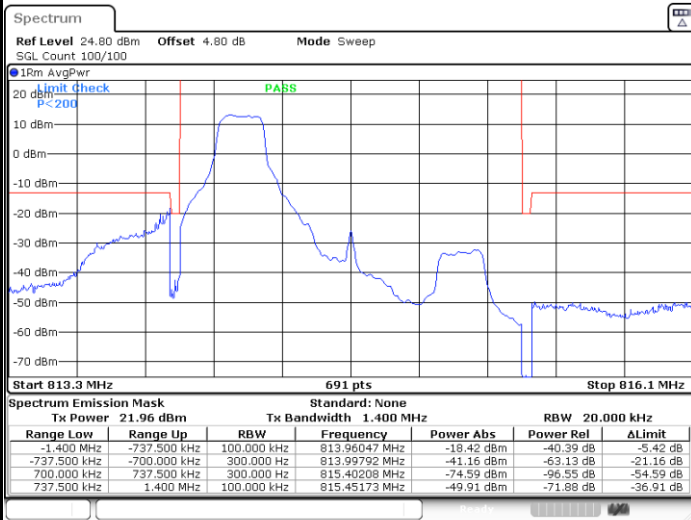

Date: 11.MAR.2022 01:47:31

Highest Band Edge / 1 RB

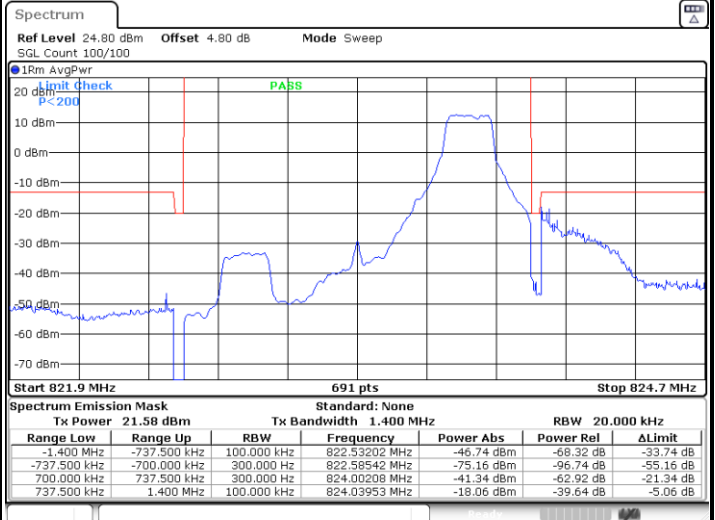

Date: 11.MAR.2022 01:54:15

Lowest Band Edge / Full RB

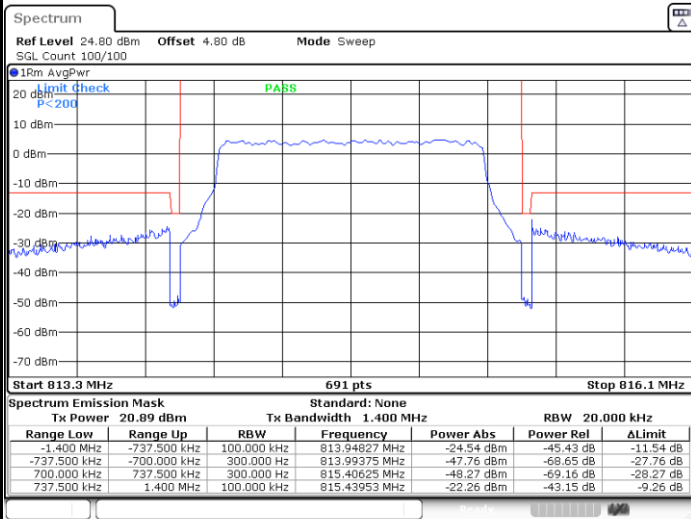

Date: 11.MAR.2022 01:49:25

Highest Band Edge / Full RB

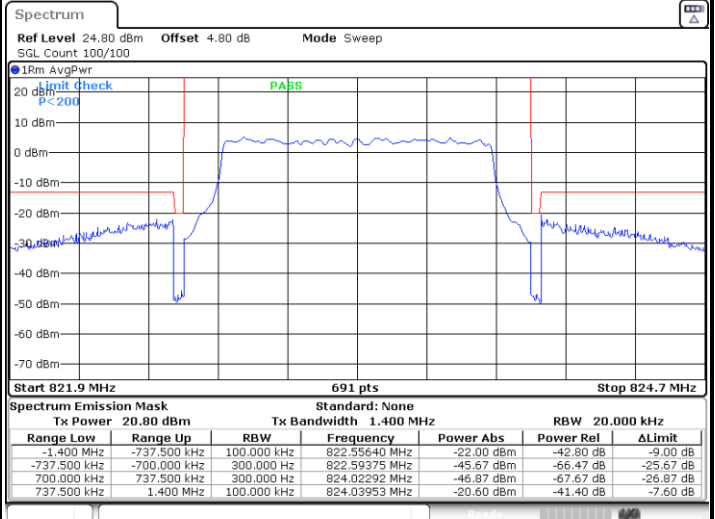

Date: 11.MAR.2022 01:52:23



LTE Band 26 / 1.4MHz / 64QAM

Lowest Band Edge / 1 RB

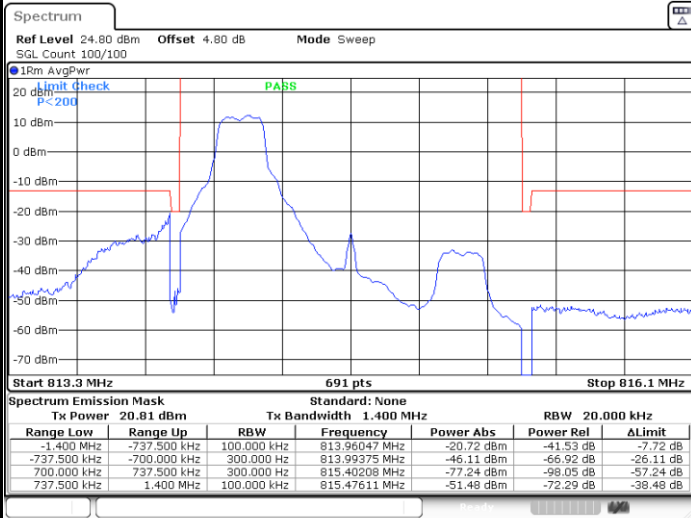

Date: 11.MAR.2022 01:48:05

Highest Band Edge / 1 RB

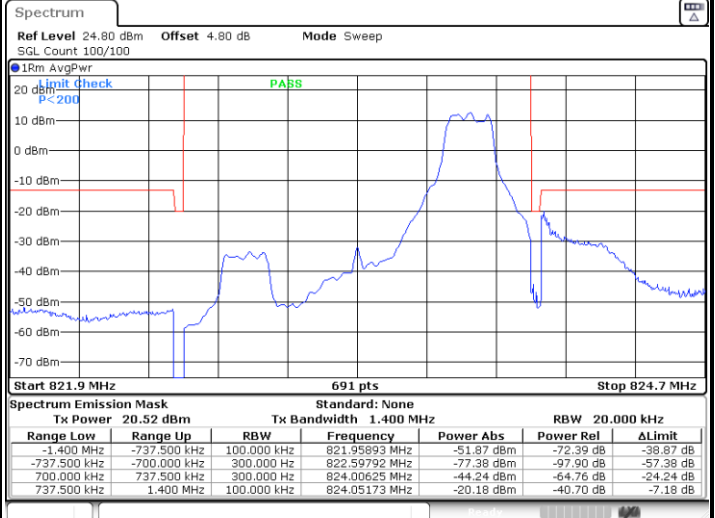

Date: 11.MAR.2022 01:53:39

Lowest Band Edge / Full RB

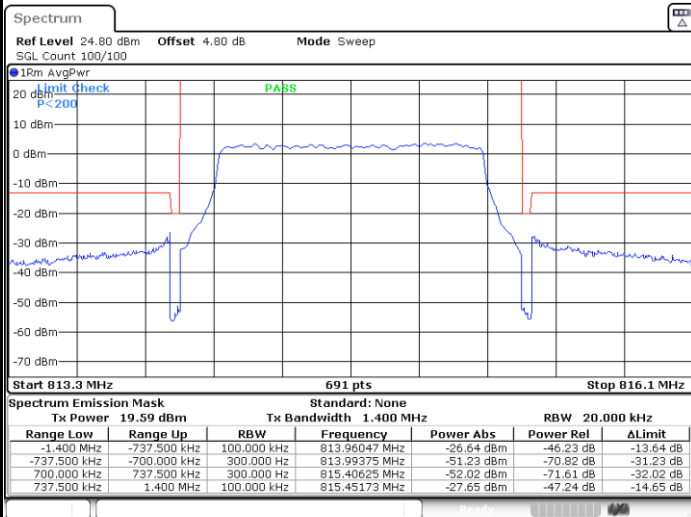

Date: 11.MAR.2022 01:48:43

Highest Band Edge / Full RB

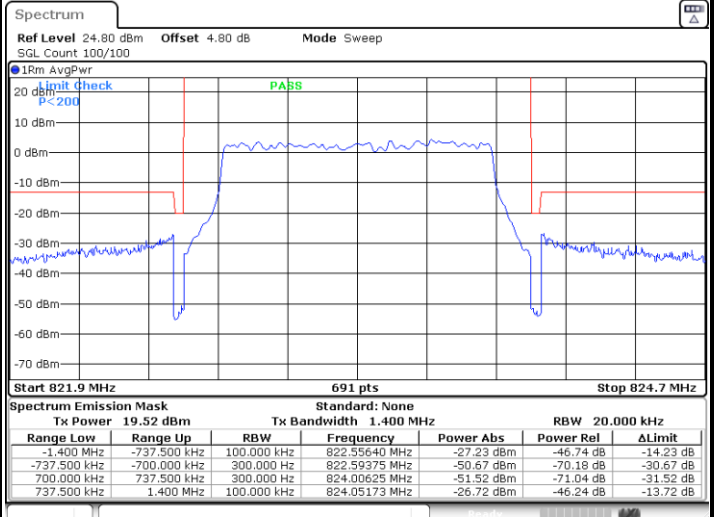

Date: 11.MAR.2022 01:52:56



LTE Band 26 / 3MHz / QPSK

Lowest Band Edge / 1RB

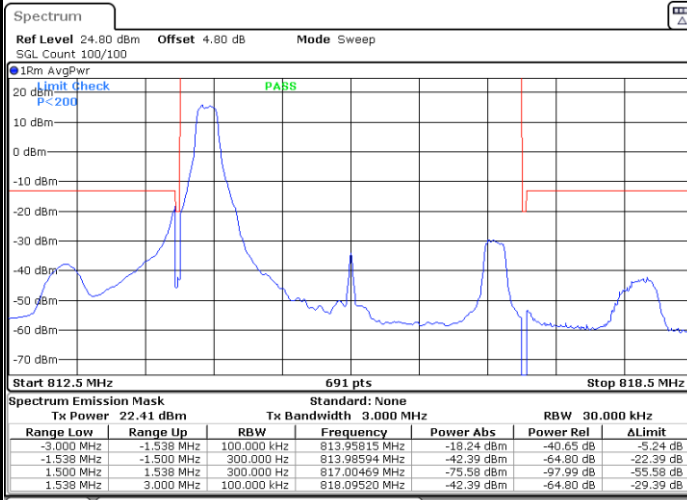

Date: 11.MAR.2022 01:31:19

Highest Band Edge / 1 RB

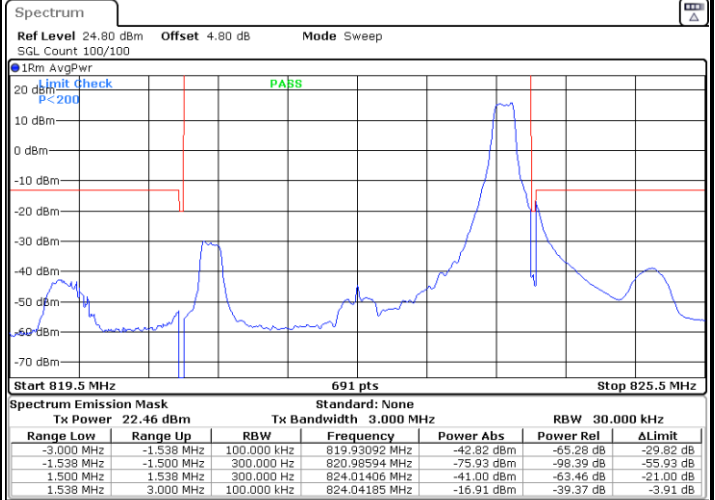

Date: 11.MAR.2022 01:41:05

Lowest Band Edge / Full RB

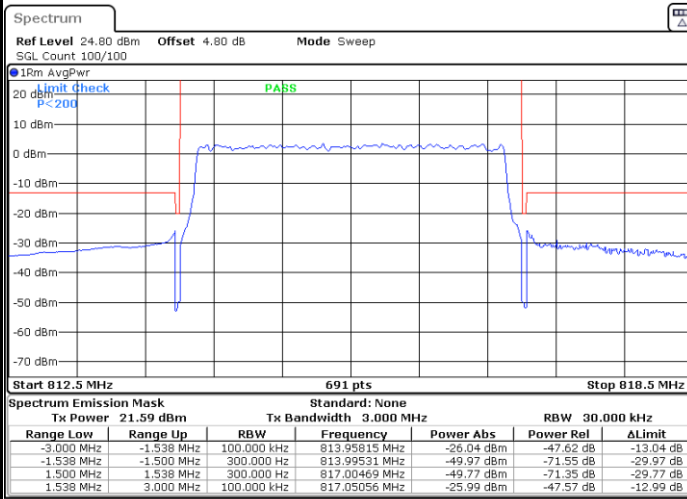

Date: 11.MAR.2022 01:35:19

Highest Band Edge / Full RB

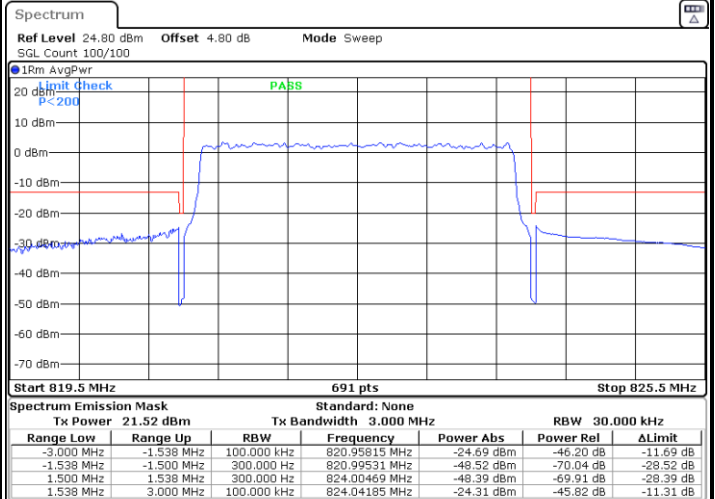

Date: 11.MAR.2022 01:36:25



LTE Band 26 / 3MHz / 16QAM

Lowest Band Edge / 1 RB

Highest Band Edge / 1 RB

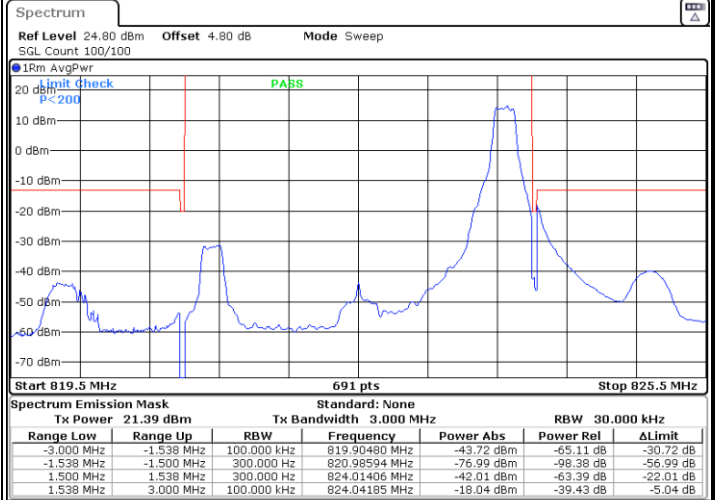
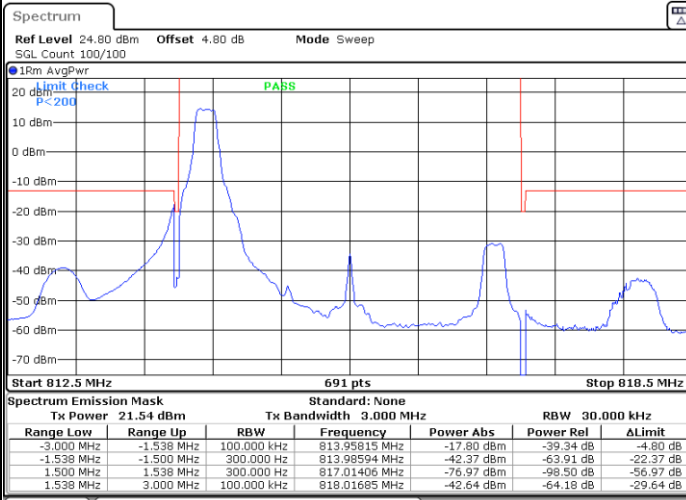

Date: 11.MAR.2022 01:32:06

Date: 11.MAR.2022 01:39:55

Lowest Band Edge / Full RB

Highest Band Edge / Full RB

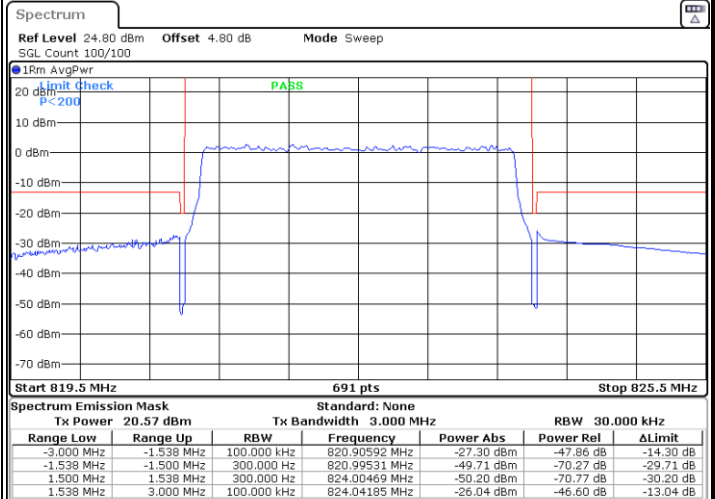
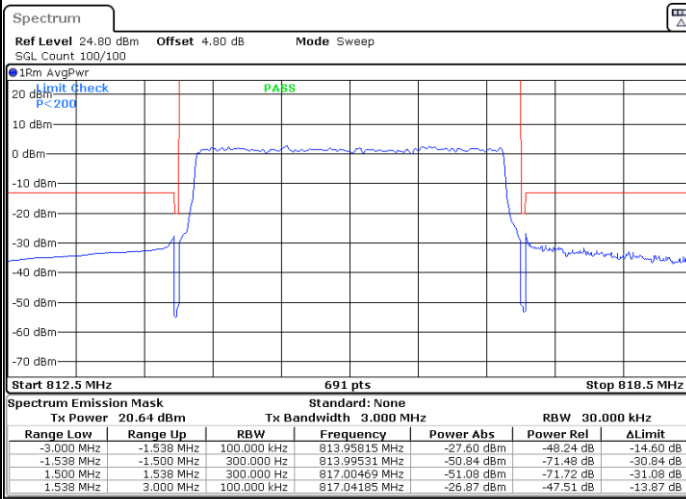

Date: 11.MAR.2022 01:34:34

Date: 11.MAR.2022 01:37:17



LTE Band 26 / 3MHz / 64QAM

Lowest Band Edge / 1 RB

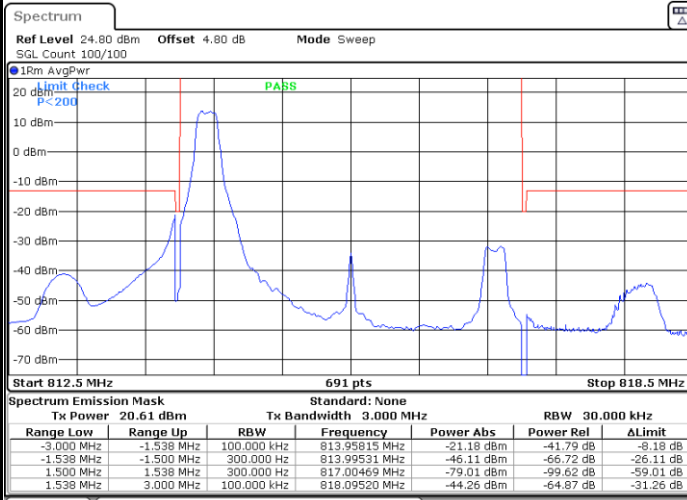

Date: 11.MAR.2022 01:32:53

Highest Band Edge / 1 RB

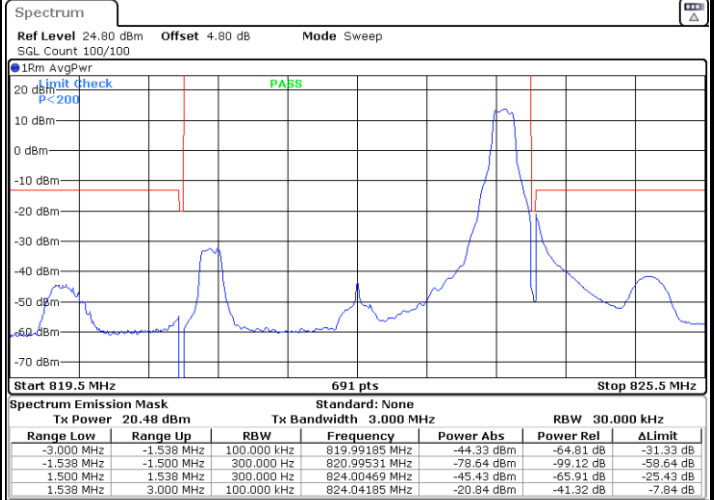

Date: 11.MAR.2022 01:39:02

Lowest Band Edge / Full RB

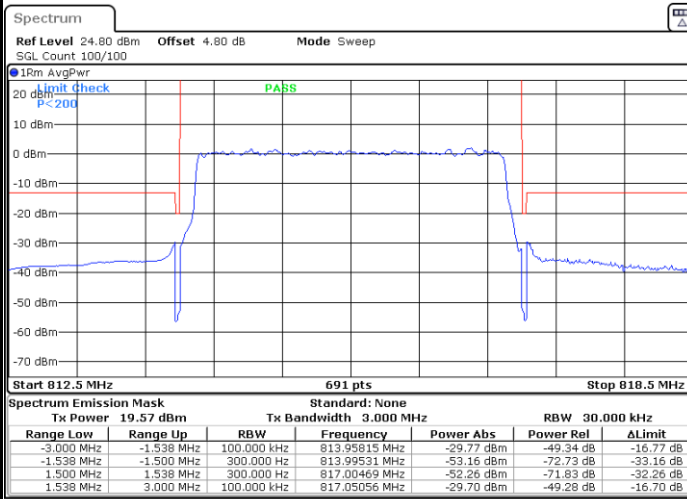

Date: 11.MAR.2022 01:33:43

Highest Band Edge / Full RB

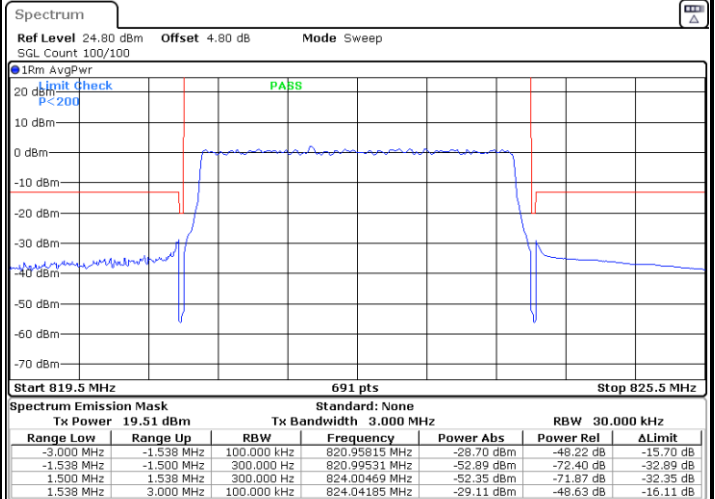

Date: 11.MAR.2022 01:38:09



LTE Band 26 / 5MHz / QPSK

Lowest Band Edge / 1 RB

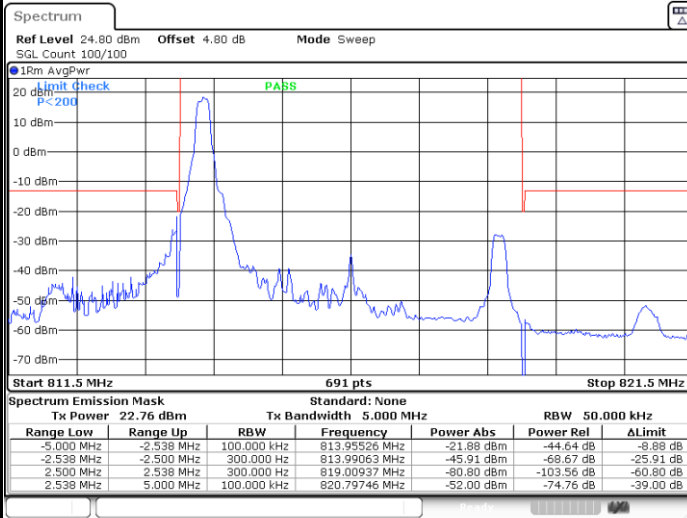

Highest Band Edge / 1 RB

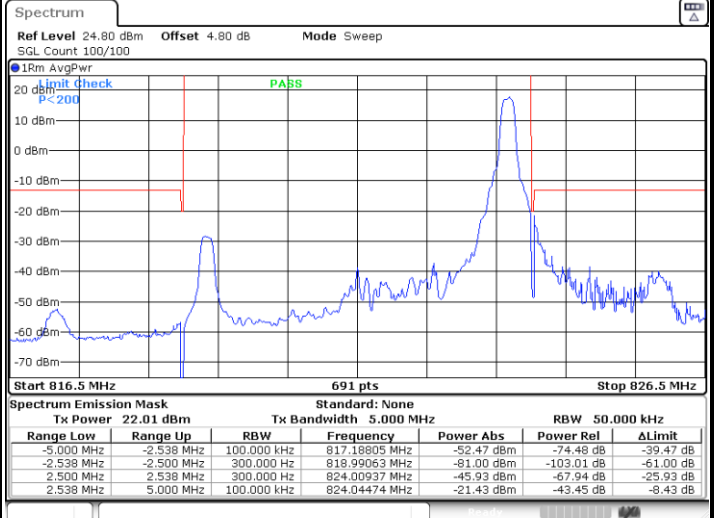

Lowest Band Edge / Full RB

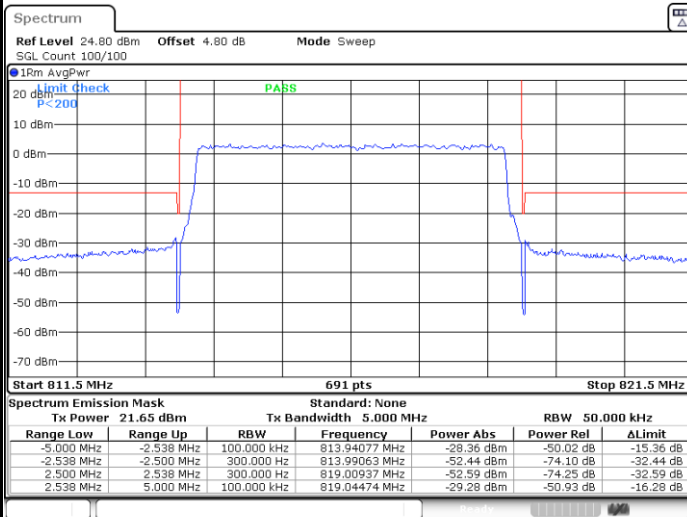

Highest Band Edge / Full RB

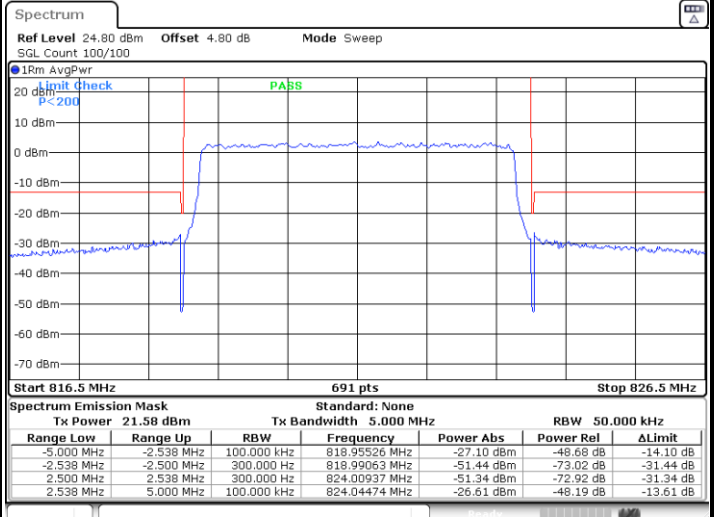



LTE Band 26 / 5MHz / 16QAM

Lowest Band Edge / 1RB

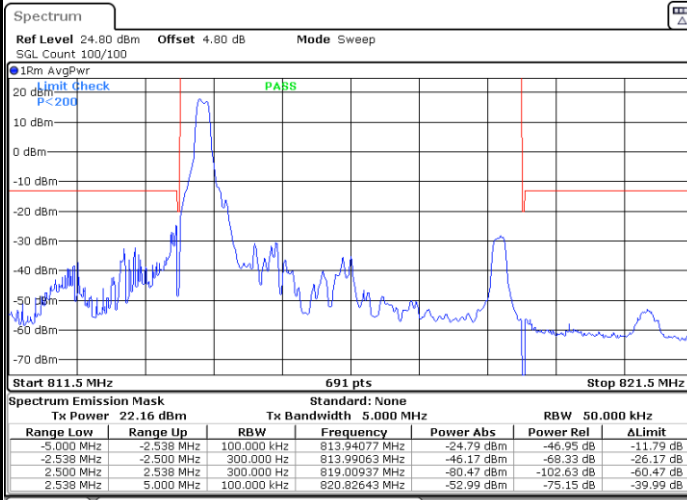

Date: 11.MAR.2022 01:20:48

Highest Band Edge / 1 RB

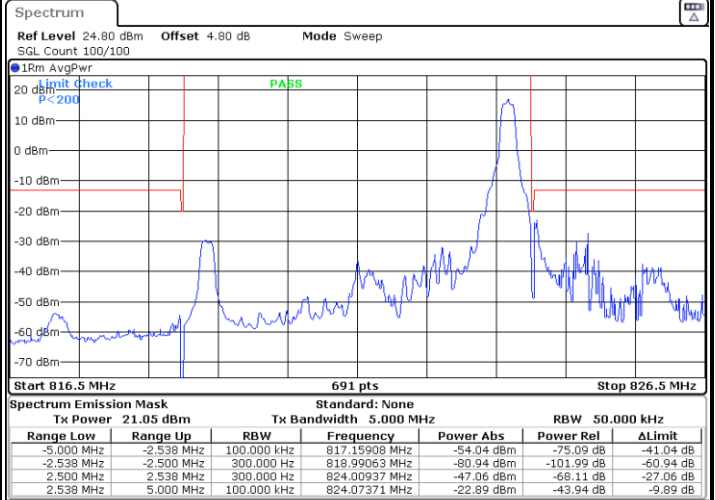

Date: 11.MAR.2022 01:27:03

Lowest Band Edge / Full RB

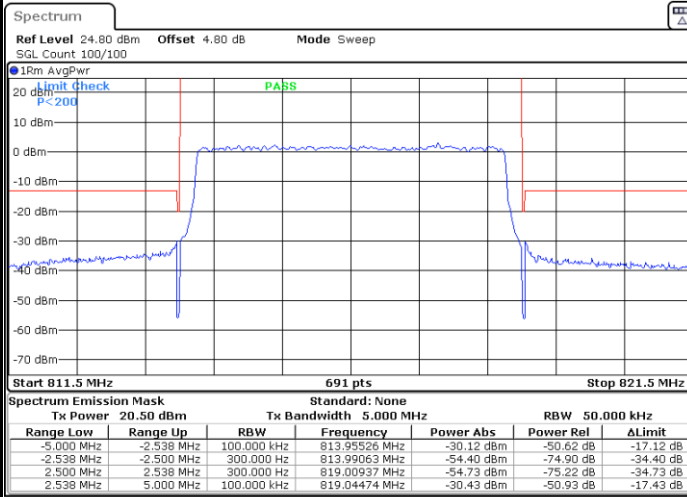

Date: 11.MAR.2022 01:22:38

Highest Band Edge / Full RB

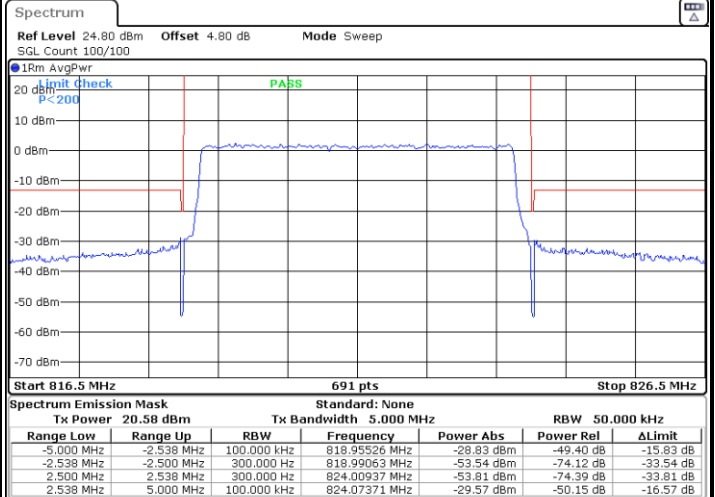

Date: 11.MAR.2022 01:24:33



LTE Band 26 / 5MHz / 64QAM

Lowest Band Edge / 1RB

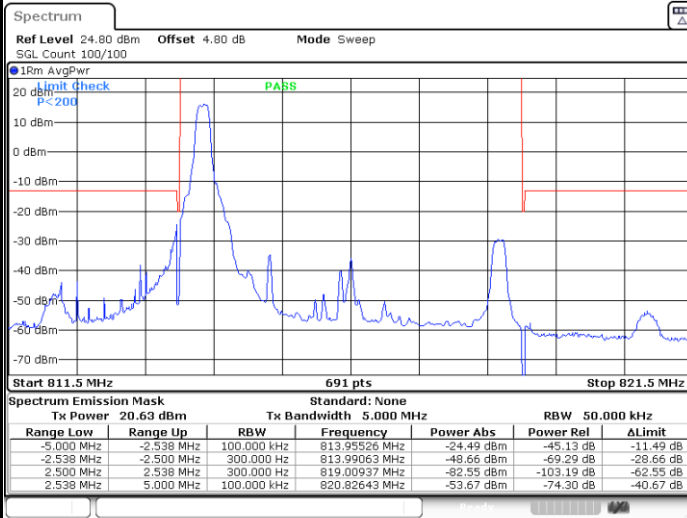

Date: 11.MAR.2022 01:21:27

Highest Band Edge / 1 RB

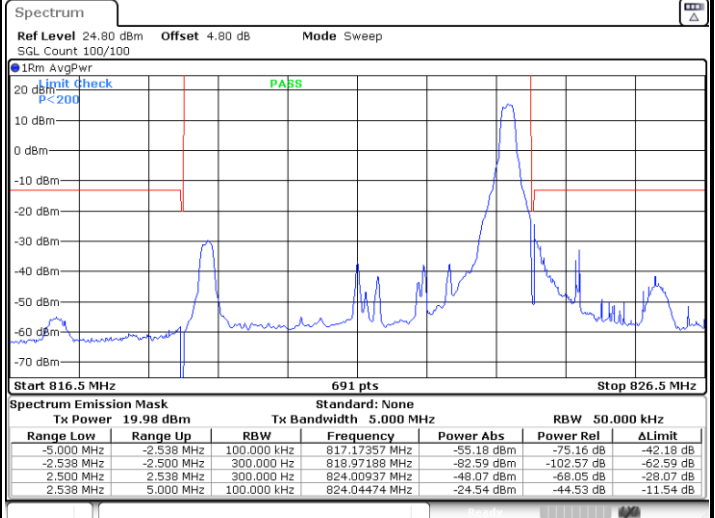

Date: 11.MAR.2022 01:26:27

Lowest Band Edge / Full RB

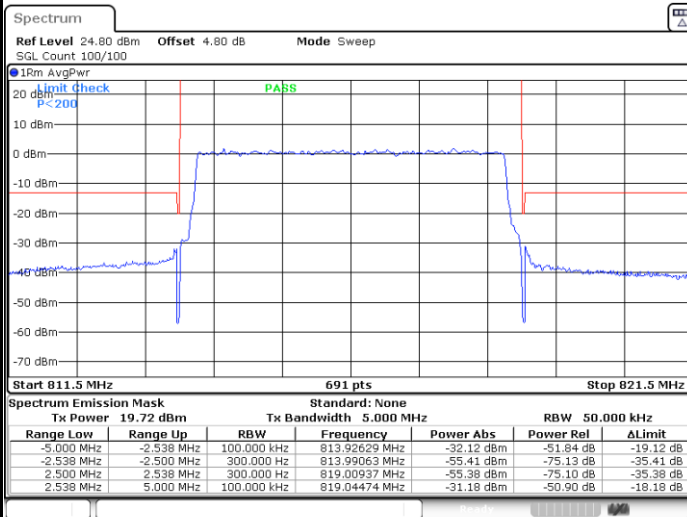

Date: 11.MAR.2022 01:22:08

Highest Band Edge / Full RB

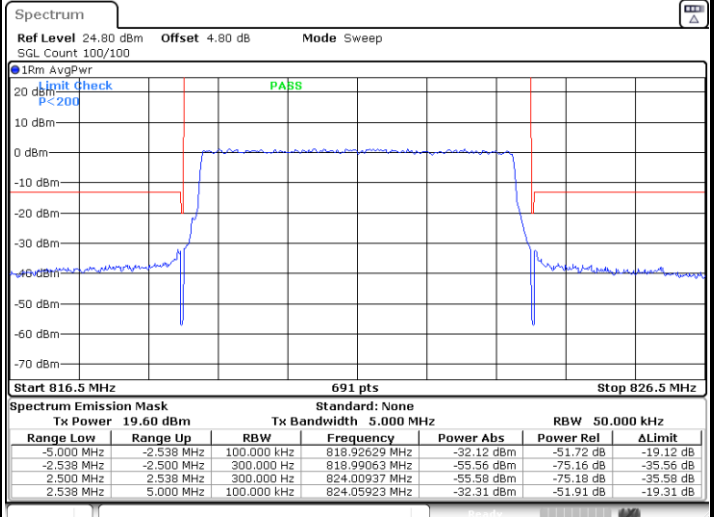

Date: 11.MAR.2022 01:25:46



LTE Band 26 / 10MHz / QPSK

Middle Band Edge / 1 RB

Middle Band Edge / 1 RB max

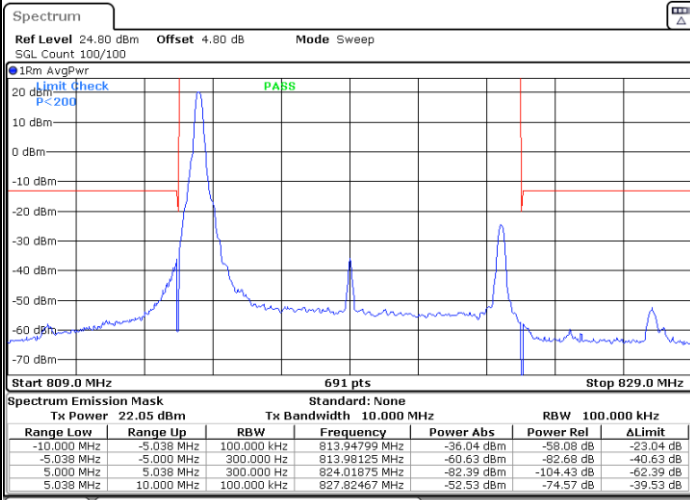

Date: 11.MAR.2022 01:08:06

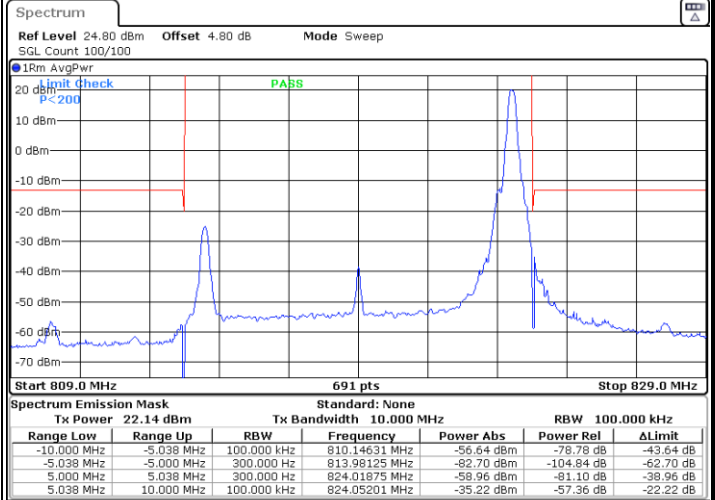

Date: 11.MAR.2022 01:13:57

Band Edge / Full RB

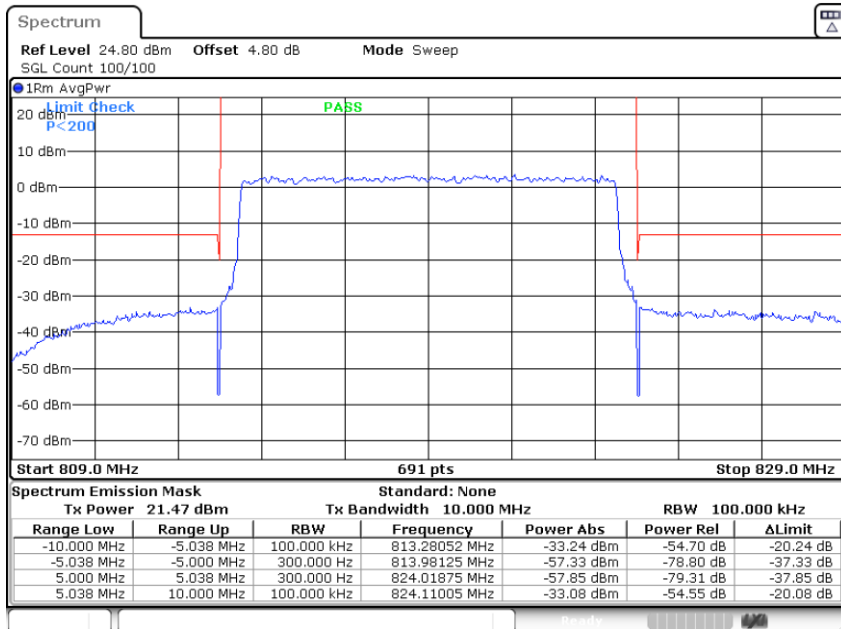

Date: 11.MAR.2022 01:13:12



LTE Band 26 / 10MHz / 16QAM

Middle Band Edge / 1 RB

Middle Band Edge / 1 RB max

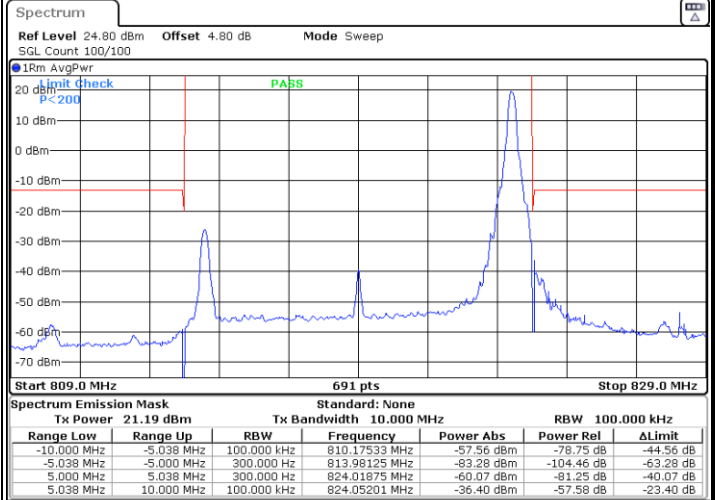
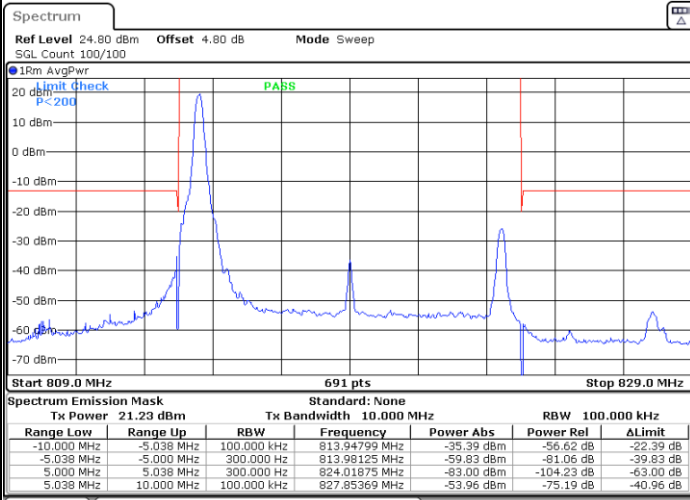

Date: 11.MAR.2022 01:08:45

Date: 11.MAR.2022 01:14:32

Band Edge / Full RB

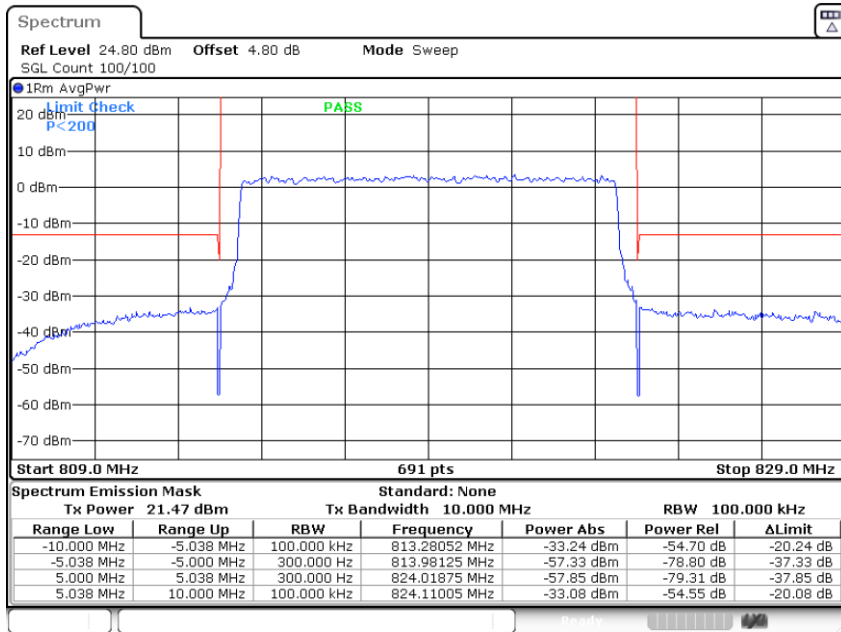

Date: 11.MAR.2022 01:13:12



LTE Band 26 / 10MHz / 64QAM

Middle Band Edge / 1 RB

Middle Band Edge / 1 RB max

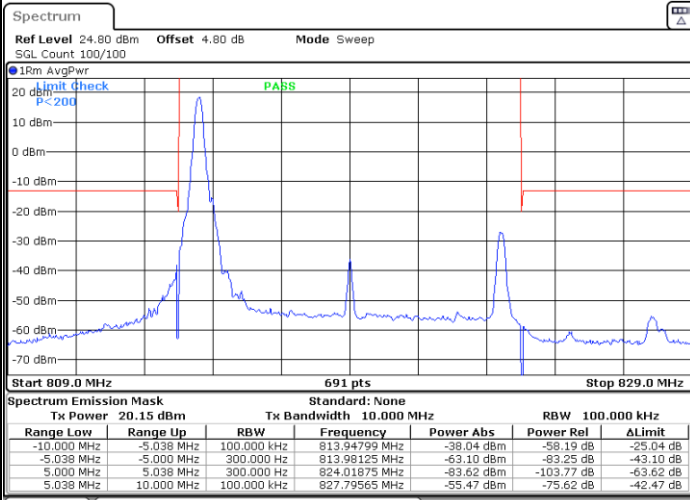

Date: 11.MAR.2022 01:09:19

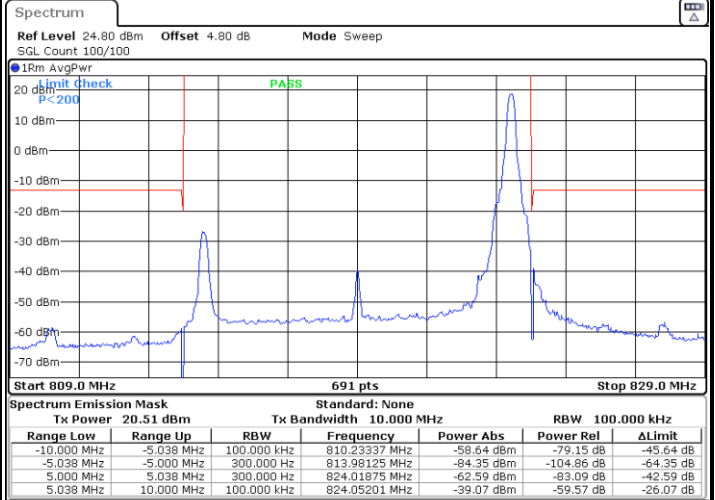

Date: 11.MAR.2022 01:15:16

Band Edge / Full RB

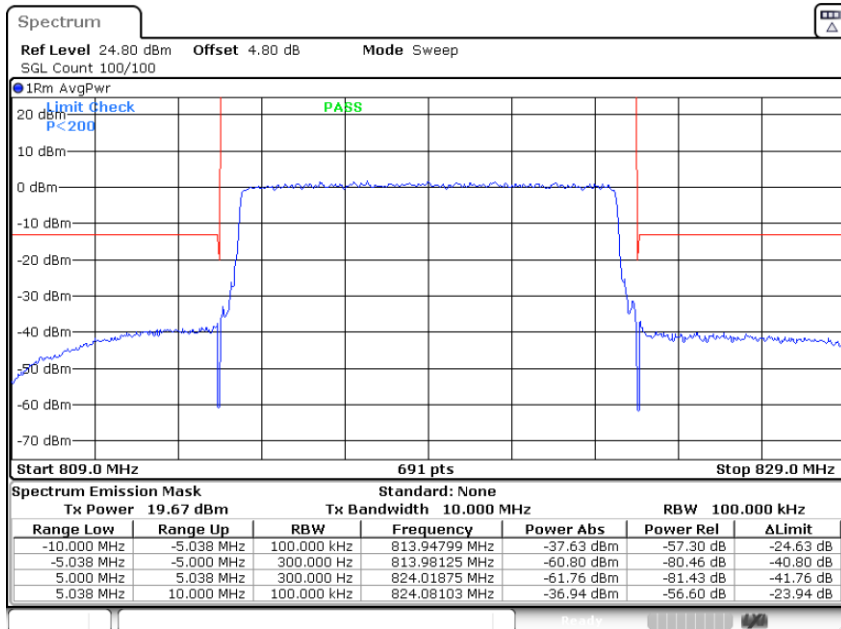

Date: 11.MAR.2022 01:11:04



LTE Band 26 / 15MHz / QPSK

Lowest Band Edge / 1 RB

Lowest Band Edge / 1 RB max

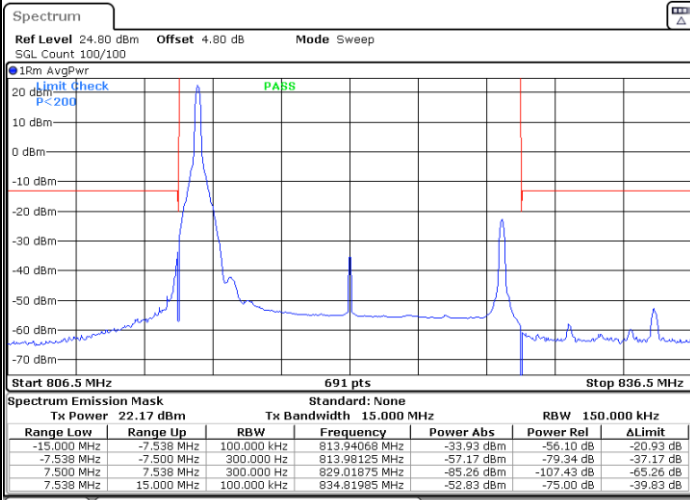

Date: 11.MAR.2022 00:53:47

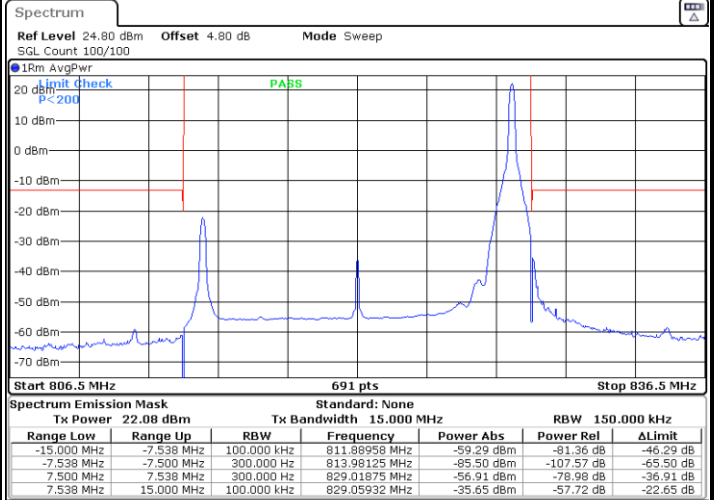

Date: 11.MAR.2022 01:02:52

Band Edge / Full RB

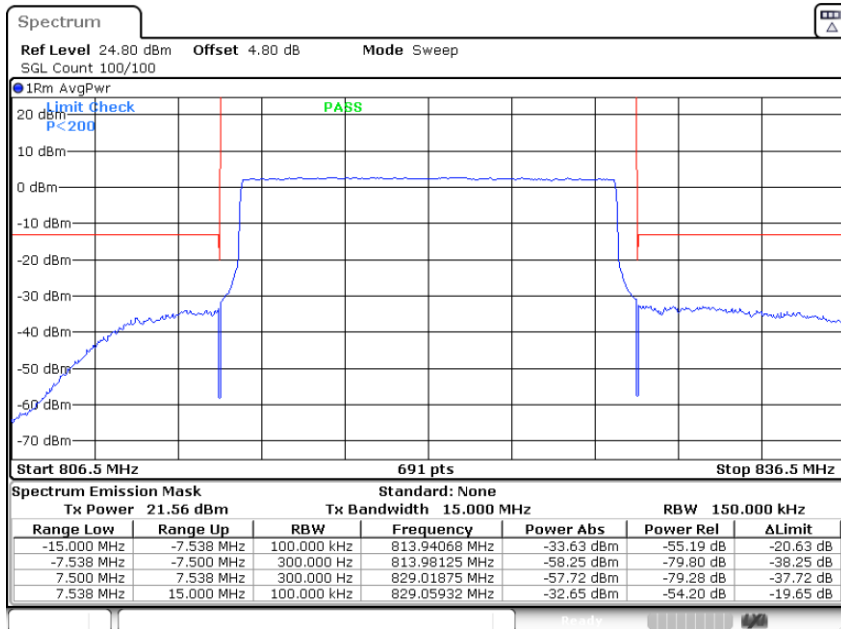

Date: 11.MAR.2022 00:57:53



LTE Band 26 / 15MHz / 16QAM

Lowest Band Edge / 1 RB

Lowest Band Edge / 1 RB max

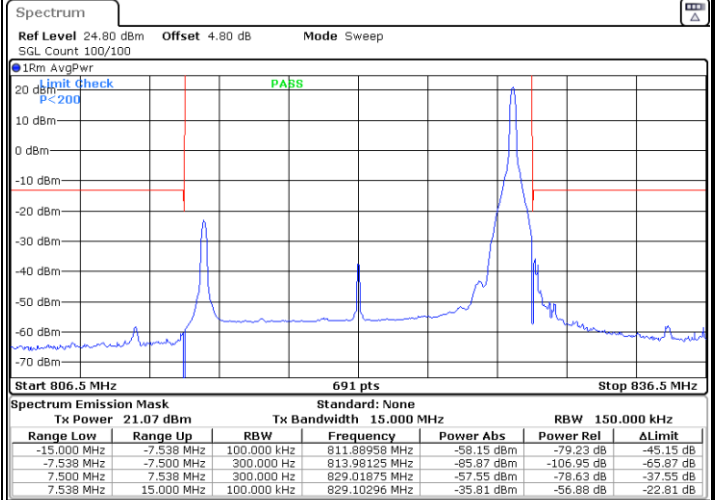
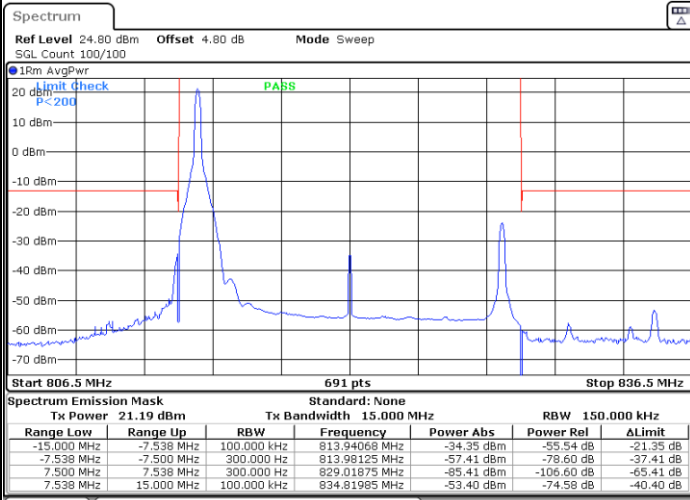

Date: 11.MAR.2022 00:54:39

Date: 11.MAR.2022 01:03:49

Band Edge / Full RB

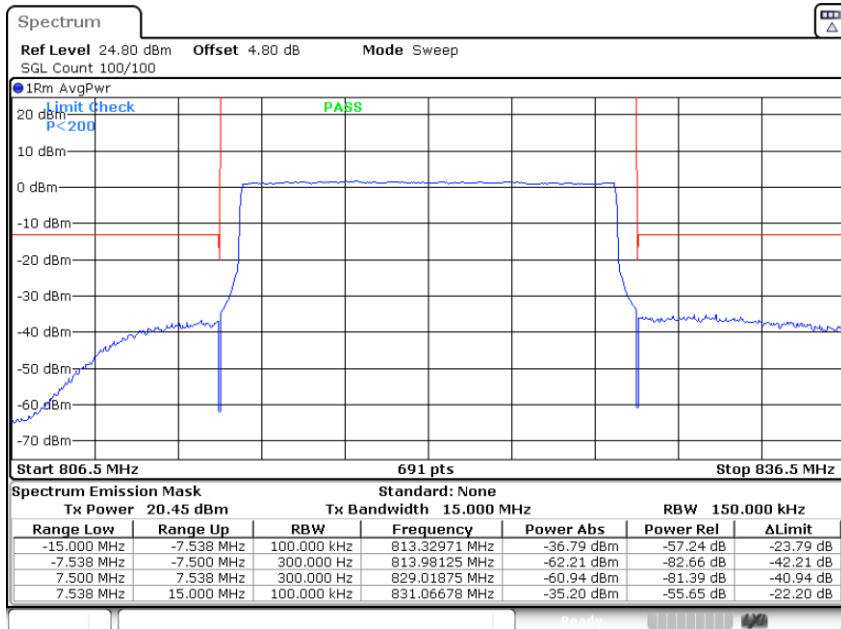

Date: 11.MAR.2022 00:59:34



LTE Band 26 / 15MHz / 64QAM

Lowest Band Edge / 1 RB

Lowest Band Edge / 1 RB max

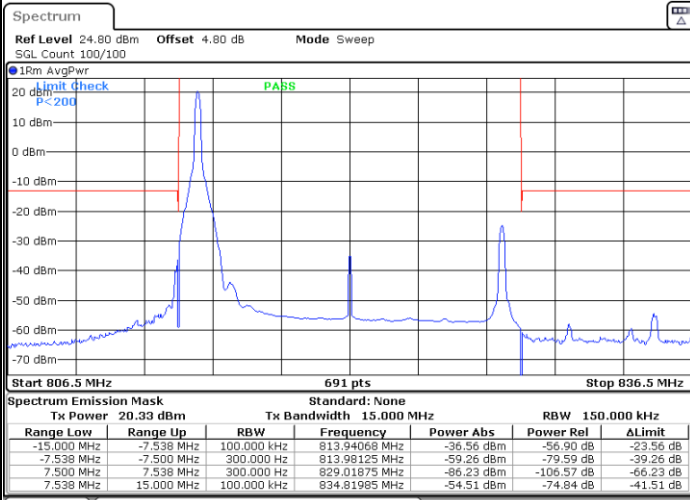

Date: 11.MAR.2022 00:55:31

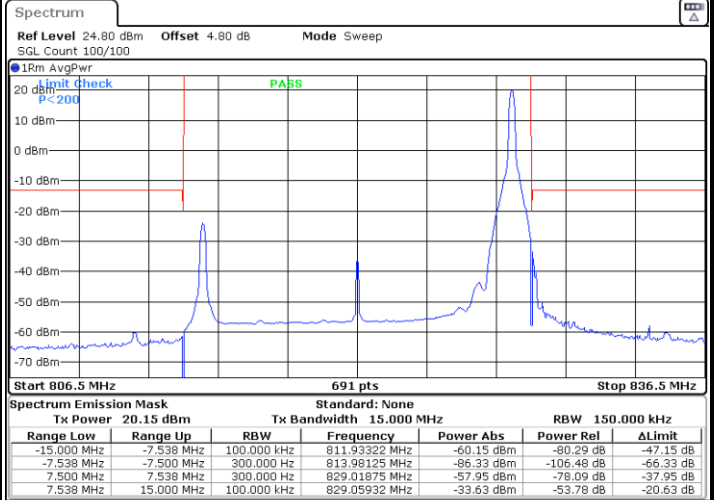

Date: 11.MAR.2022 01:04:48

Band Edge / Full RB

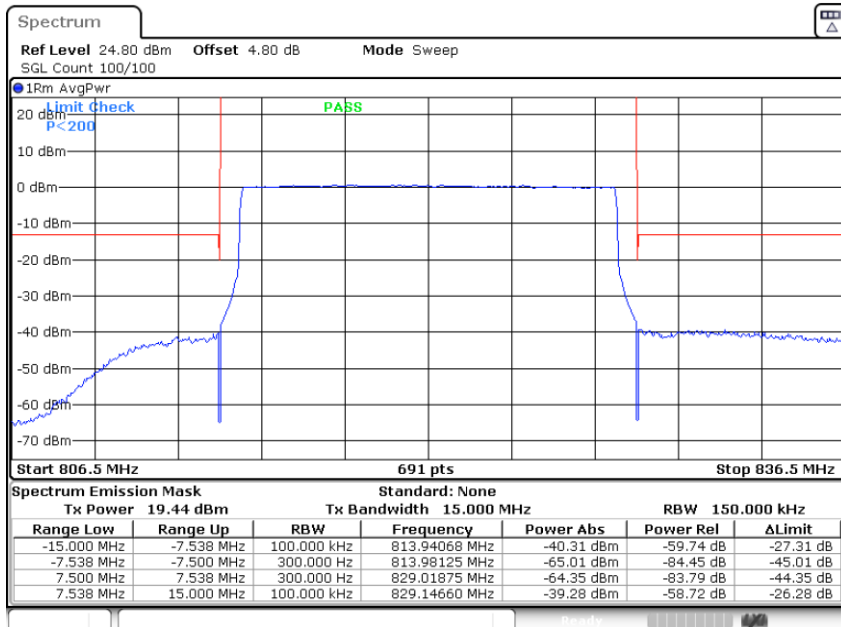

Date: 11.MAR.2022 01:00:24



Conducted Spurious Emission

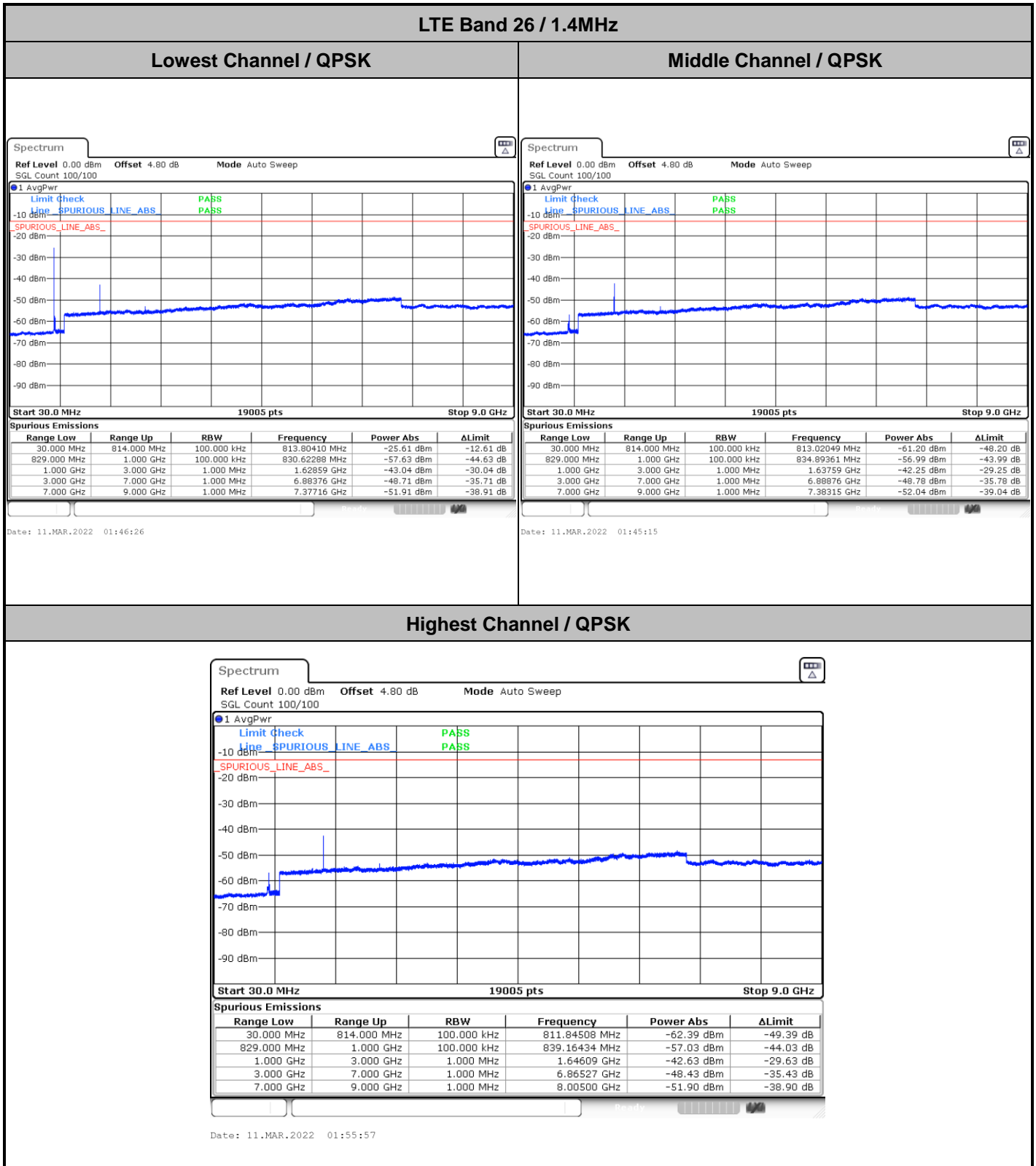

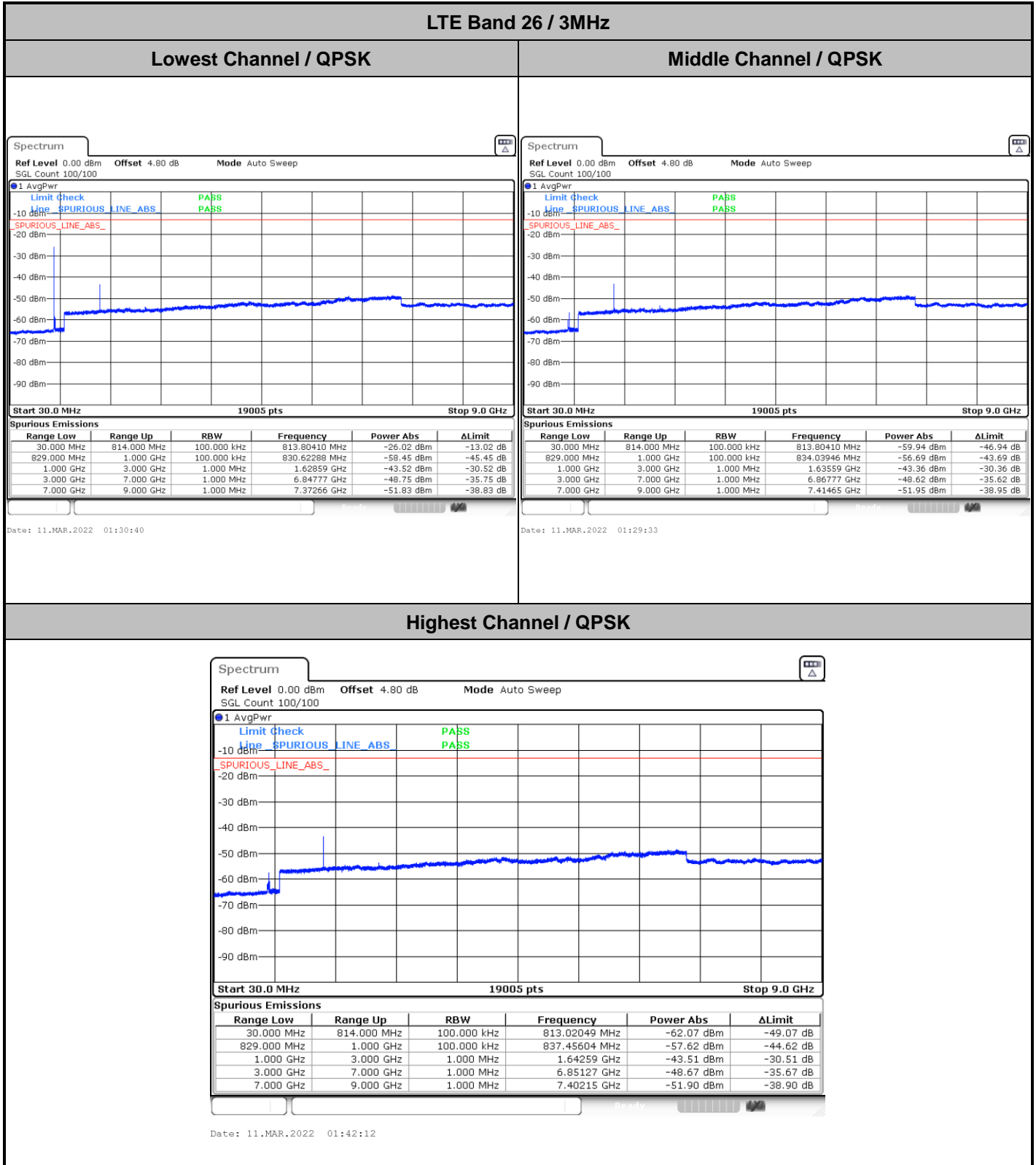



LTE Band 26 / 5MHz

Lowest Channel / QPSK

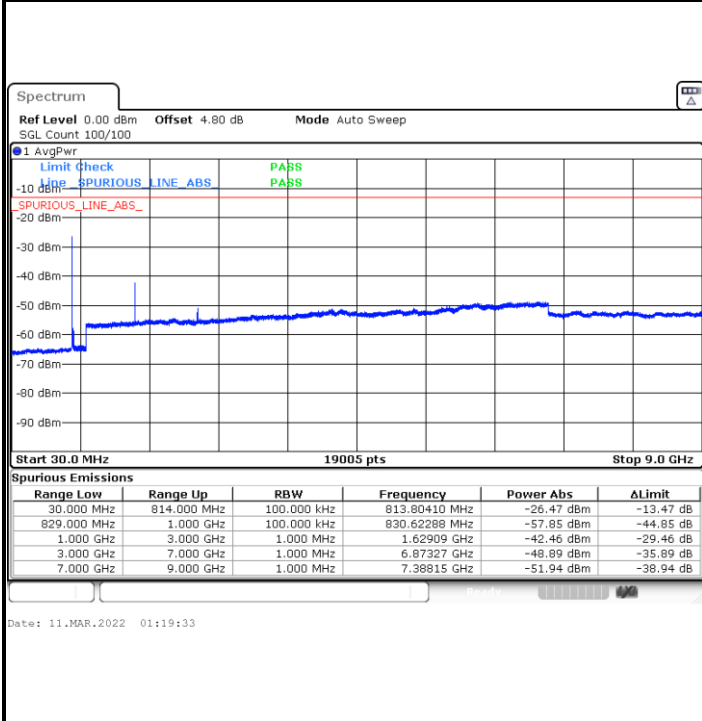

Middle Channel / QPSK

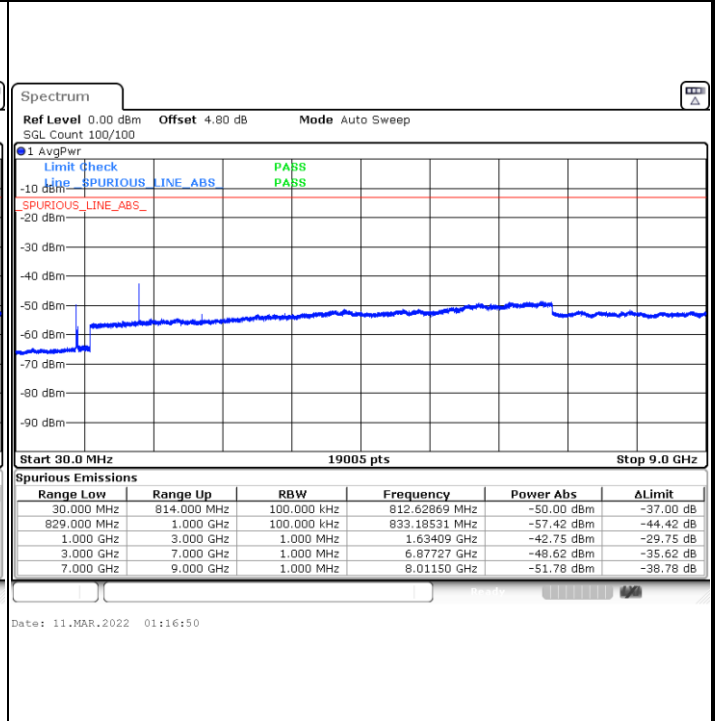

Highest Channel / QPSK

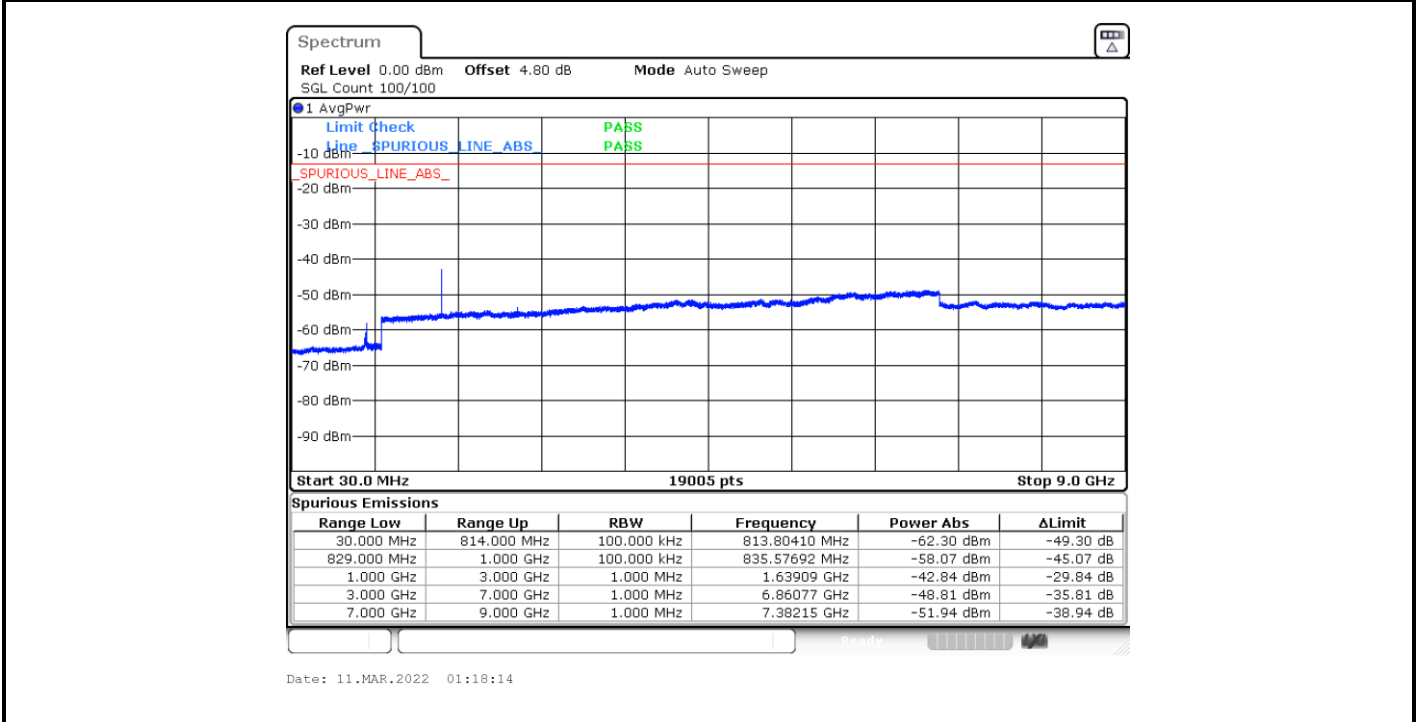



LTE Band 26 / 10MHz

Middle Channel / QPSK

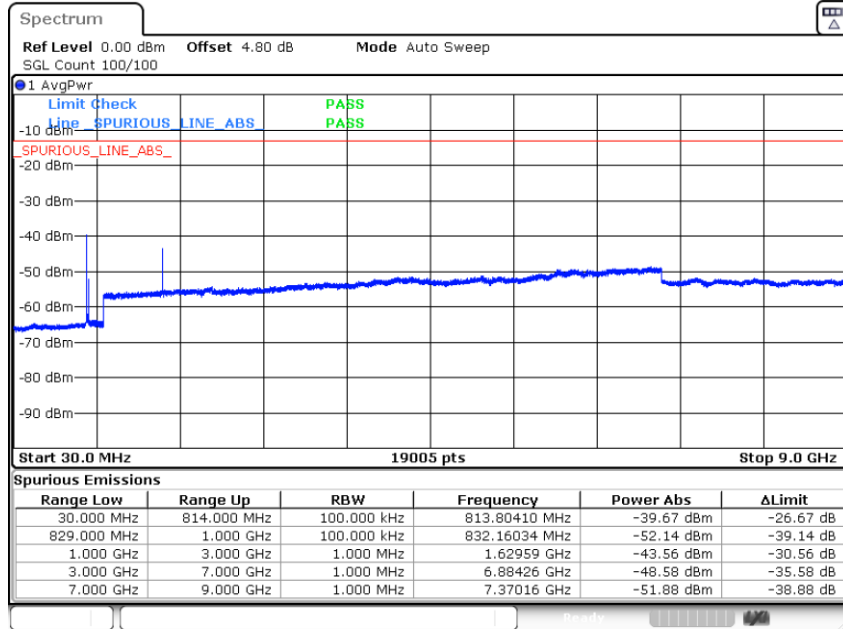

Date: 11.MAR.2022 01:07:18

LTE Band 26 / 15MHz

Lowest Channel / QPSK

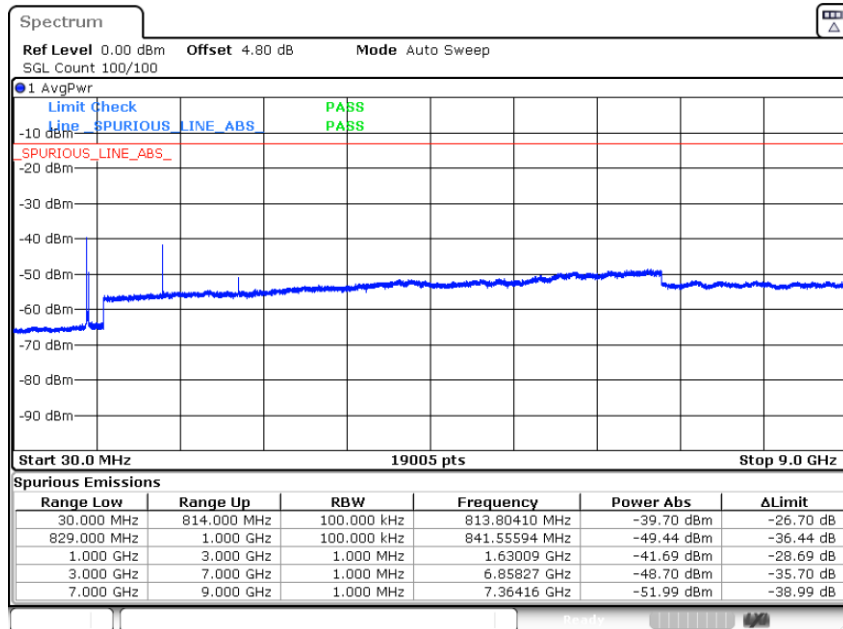

Date: 11.MAR.2022 00:56:36



Frequency Stability

Test Conditions		LTE Band 26 (QPSK) / Middle Channel	Limit
Temperature (°C)	Voltage (Volt)	BW 10MHz	2.5ppm
		Deviation (ppm)	Result
50	Normal Voltage	0.0032	PASS
40	Normal Voltage	0.0018	
30	Normal Voltage	0.0012	
20(Ref.)	Normal Voltage	0.0000	
10	Normal Voltage	0.0008	
0	Normal Voltage	0.0013	
-10	Normal Voltage	0.0025	
-20	Normal Voltage	0.0017	
-30	Normal Voltage	0.0021	
20	Maximum Voltage	0.0009	
20	Normal Voltage	0.0011	
20	Battery End Point	0.0015	

Note: Normal Voltage =3.86 V. ; Battery End Point (BEP) =3.6 V. ; Maximum Voltage =4.4 V.



Appendix B. Test Results of Radiated Test

Radiated Spurious Emission

Test Engineer :	Chris Chen	Temperature :	22~23°C
		Relative Humidity :	41~42%

LTE Band 26 / 10MHz / QPSK / RB Size 1 Offset 0								
Channel	Frequency (MHz)	ERP (dBm)	Limit (dBm)	Over Limit (dB)	S.G. Power (dBm)	TX Cable loss (dB)	TX Antenna Gain (dBi)	Polarization (H/V)
Middle	1632	-66.20	-13	-53.20	-73.17	1.58	10.70	H
	2440	-53.02	-13	-40.02	-61.27	2.102	12.50	H
	3256	-59.88	-13	-46.88	-68.77	2.856	13.90	H
	1632	-64.56	-13	-51.56	-71.53	1.58	10.70	V
	2440	-54.34	-13	-41.34	-62.59	2.10	12.50	V
	3256	-59.86	-13	-46.86	-68.75	2.86	13.90	V

Remark: Spurious emissions within 30-1000MHz were found more than 20dB below limit line.