



BUREAU
VERITAS

Test Report No.: RF160223W005-4



FCC TEST REPORT (PART 24)

Product: Portable Tablet Computer
Model No.: Lenovo TAB 2 A7-30GC
FCC ID: O57TAB2A730GC
Applicant: Lenovo (Shanghai) Electronics Technology Co., Ltd.
Address: No. 68 Building, 199 Fenju Road, Wai Gao Qiao FTZ ,
Shanghai , China
Manufacturer: Lenovo PC HK Limited
Address: 23/F, Lincoln House, Taikoo Place 979 King's Road, Quarry
Bay, Hong Kong
Prepared by: Bureau Veritas Shenzhen Co., Ltd. Dongguan Branch
Lab Location: No. 34, Chenwulu Section, Guantai Rd., Houjie Town,
Dongguan City, Guangdong 523942, China
TEL: +86 769 8593 5656
FAX: +86 769 8593 1080
E-MAIL: customerservice.dg@cn.bureauveritas.com
Report No.: RF160223W005-4
Received Date: Oct. 13, 2014
Oct. 13, 2014 ~ Nov. 03, 2014
Test Date: Aug. 10, 2015 ~ Aug. 20, 2015
Mar. 01, 2016 ~ Mar. 22, 2016
Issued Date: Mar. 23, 2016

This report should not be used by the client to claim product certification, approval, or endorsement by A2LA or any government agencies.

Any copying or replication of this report to or for any other person or entity, or use of our name or trademark, is permitted only with our prior written permission. This report sets forth our findings solely with respect to the test samples identified herein. The results set forth in this report are not indicative or representative of the quality or characteristics of the lot from which a test sample was taken or any similar or identical product unless specifically and expressly noted. Our report includes all of the tests requested by you and the results thereof based upon the information that you provided to us. You have 60 days from date of issuance of this report to notify us of any material error or omission caused by our negligence, provided, however, that such notice shall be in writing and shall specifically address the issue you wish to raise. A failure to raise such issue within the prescribed time shall constitute your unqualified acceptance of the completeness of this report, the tests conducted and the correctness of the report contents. Unless specific mention, the uncertainty of measurement has been explicitly taken into account to declare the compliance or non-compliance to the specification.



TABLE OF CONTENTS

RELEASE CONTROL RECORD	4
1 CERTIFICATION	5
2 SUMMARY OF TEST RESULTS.....	6
2.1 MEASUREMENT UNCERTAINTY	6
2.2 TEST SITE AND INSTRUMENTS.....	7
3 GENERAL INFORMATION.....	8
3.1 GENERAL DESCRIPTION OF EUT	8
3.2 CONFIGURATION OF SYSTEM UNDER TEST	10
3.3 DESCRIPTION OF SUPPORT UNITS.....	11
3.4 TEST ITEM AND TEST CONFIGURATION	11
3.5 EUT OPERATING CONDITIONS.....	14
3.6 GENERAL DESCRIPTION OF APPLIED STANDARDS	14
4 TEST TYPES AND RESULTS.....	15
4.1 OUTPUT POWER MEASUREMENT	15
4.1.1 LIMITS OF OUTPUT POWER MEASUREMENT	15
4.1.2 TEST PROCEDURES	15
4.1.3 TEST SETUP.....	16
4.1.4 TEST RESULTS	17
4.2 FREQUENCY STABILITY MEASUREMENT	19
4.2.1 LIMITS OF FREQUENCY STABILITY MEASUREMENT	19
4.2.2 TEST PROCEDURE.....	19
4.2.3 TEST SETUP.....	19
4.2.4 TEST RESULTS	20
4.3 OCCUPIED BANDWIDTH MEASUREMENT	21
4.3.1 TEST PROCEDURES	21
4.3.2 TEST SETUP	21
4.3.3 TEST RESULTS	22
4.4 BAND EDGE MEASUREMENT	24
4.4.1 LIMITS OF BAND EDGE MEASUREMENT	24
4.4.2 TEST SETUP.....	24
4.4.3 TEST PROCEDURES	24
4.4.4 TEST RESULTS.....	25
4.5 CONDUCTED SPURIOUS EMISSIONS	26
4.5.1 LIMITS OF CONDUCTED SPURIOUS EMISSIONS MEASUREMENT	26
4.5.2 TEST PROCEDURE.....	26
4.5.3 TEST SETUP.....	26
4.5.4 TEST RESULTS	27
4.6 RADIATED EMISSION MEASUREMENT.....	29
4.6.1 LIMITS OF RADIATED EMISSION MEASUREMENT	29
4.6.2 TEST PROCEDURES	29
4.6.3 DEVIATION FROM TEST STANDARD	29
4.6.4 TEST SETUP.....	30
4.6.5 TEST RESULTS	31
4.7 PEAK TO AVERAGE RATIO.....	37
4.7.1 LIMITS OF PEAK TO AVERAGE RATIO MEASUREMENT.....	37



4.7.2	TEST SETUP.....	37
4.7.3	TEST PROCEDURES	37
4.7.4	TEST RESULTS	38
5	INFORMATION ON THE TESTING LABORATORIES.....	40
6	APPENDIX A – MODIFICATIONS RECORDERS FOR ENGINEERING CHANGES TO THE EUT BY THE LAB	41



RELEASE CONTROL RECORD

ISSUE NO.	REASON FOR CHANGE	DATE ISSUED
RF141013N033-4	Original release	Nov. 04, 2014
RF150116N005-4	Based on the original report RF141013N033-4 adding the third source of Adapter and Emcp information.	Jan. 26, 2015
RF150806W001-4	Based on the original report RF150116N005-4 adding the third source of Emcp & LCD information.	Aug. 21, 2015
RF160223W005-4	Based on the original report RF150806W001-4 changing radio frequency power amplifier.	Mar. 23, 2016



1 CERTIFICATION

PRODUCT: Portable Tablet Computer
BRAND NAME: lenovo
MODEL NO.: Lenovo TAB 2 A7-30GC
APPLICANT: Lenovo (Shanghai) Electronics Technology Co., Ltd.
Oct. 13, 2014 ~ Nov. 03, 2014
TESTED: Aug. 10, 2015 ~ Aug. 20, 2015
Mar. 01, 2016 ~ Mar. 22, 2016
TEST SAMPLE: Production Unit
STANDARDS: **FCC Part 24, Subpart E**

The above equipment has been tested by **Bureau Veritas Shenzhen Co., Ltd. Dongguan Branch**, and found compliance with the requirement of the above standards. The test record, data evaluation & Equipment Under Test (EUT) configurations represented herein are true and accurate accounts of the measurements of the sample's EMC characteristics under the conditions specified in this report.

TESTED BY

:

(Amyee Qian / Engineer)

DATE: Mar. 23, 2016

APPROVED BY

:

(William Chung / Manager)

DATE: Mar. 23, 2016



2 SUMMARY OF TEST RESULTS

The EUT has been tested according to the following specifications:

APPLIED STANDARD: FCC Part 24 & Part 2			
STANDARD SECTION	TEST TYPE	RESULT	REMARK
2.1046 24.232	Equivalent Isotropic Radiated Power	PASS	Meet the requirement of limit.
2.1055 24.235	Frequency Stability	PASS	Meet the requirement of limit.
2.1049 24.238(b)	Occupied Bandwidth	PASS	Meet the requirement of limit.
24.232(d)	Peak to average ratio	PASS	Meet the requirement of limit.
24.238(b)	Band Edge Measurements	PASS	Meet the requirement of limit.
2.1051 24.238	Conducted Spurious Emissions	PASS	Meet the requirement of limit.
2.1053 24.238	Radiated Spurious Emissions	PASS	Meet the requirement of limit. Minimum passing margin is -33.69dB at 5640.00MHz.

2.1 MEASUREMENT UNCERTAINTY

Where relevant, the following measurement uncertainty levels have been estimated for tests performed on the EUT as specified in CISPR 16-4-2:

MEASUREMENT	FREQUENCY	UNCERTAINTY
Conducted emissions	9kHz~30MHz	2.66dB
Radiated emissions	9KHz ~ 30MHz	2.74dB
	30MHz ~ 1GHz	3.55dB
	1GHz ~ 18GHz	4.84dB
	18GHz ~ 40GHz	1.94dB

This uncertainty represents an expanded uncertainty expressed at approximately the 95% confidence level using a coverage factor of k=2.



2.2 TEST SITE AND INSTRUMENTS

Equipment	Manufacturer	Model No.	Serial No.	Last Cal.	Next Cal.
EMI Test Receiver	Rohde&Schwarz	ESR7	101494	Apr. 27,15	Apr. 26,16
Signal and Spectrum Analyzer	Rohde&Schwarz	FSV40	101094	Apr. 23,15	Apr. 22,16
Bilog Antenna	Teseq	CBL 6111D	30643	Jul. 16, 15	Jul. 15, 16
Horn Antenna	ETS-Lindgren	3117	00062558	May 30,14	May 29,16
Horn Antenna (15GHz-40GHz)	SCHWARZBECK	BBHA 9170	BBHA9170147	Jan. 21,14	Jan. 20,17
Amplifier (9kHz-1GHz)	SONOMA	310D	186955	Mar. 04,15	Mar. 03, 17
Pre-Amplifier (0.5~18GHz)	SCHWARZBECK	BBV 9718	9718-266	Mar 26,14	Mar. 25,16
Pre-Amplifier (18GHz-40GHz)	EMCI	EMC 184045	980102	Nov. 19,15	Nov. 18,16
GPS Generator+ Antenna	TOJOIN	GNSS-5000A	E1-010119	Aug. 08, 14	Aug. 07, 16
3m Semi-anechoic Chamber	ETS-LINDGREN	9m*6m*6m	NSEMC003	April. 19,14	April. 18,16
Test Software	ADT	ADT_Radiated_V7.6.15.9.2	N/A	N/A	N/A
Power Meter	Anritsu	ML2495A	1139001	Feb. 20,15	Feb. 19,17
Power Sensor	Anritsu	MA2411B	1126068	Feb. 20,15	Feb. 19,17
Power Sensor	Keysight	U2021XA	MY55060016	Feb. 18,15	Feb. 17,17
Power Sensor	Keysight	U2021XA	MY55060018	Feb. 18,15	Feb. 17,17
Digital Multimeter	FLUKE	15B	A1220010DG	Oct. 12, 15	Oct. 11, 16
Humid & Temp Programmable Tester	Haida	HD-2257	110807201	Sep.07,15	Sep. 06,16
Oscilloscope	Agilent	DSO9254A	MY51260160	Nov. 27,15	Nov. 26,16
Signal Analyzer	Rohde Schwarz &	FSV7	102331	Nov. 09,15	Nov. 08,16
Signal Generator	Agilent	N5183A	MY50140980	Nov. 09,15	Nov. 08,16
ESG Vector Signal Generator	Agilent	E4438C	MY49072505	Apr. 22, 15	Apr. 21, 16
BLUETOOTH TESTER	Rohde&Schwarz	CBT32	100811	Sep. 01,15	Aug. 31,16

- NOTE:**
1. The calibration interval of the above test instruments is 12 months or 24 months and the calibrations are traceable to CEPREI/CHINA, GRGT/CHINA and NIM/CHINA.
 2. The test was performed in Dongguan 966 Chamber.
 3. The horn antenna are used only for the measurement of emission frequency above 1GHz if tested.
 4. The FCC Site Registration No. is 502831.



3 GENERAL INFORMATION

3.1 GENERAL DESCRIPTION OF EUT

PRODUCT	Portable Tablet Computer	
MODEL NO.	Lenovo TAB 2 A7-30GC	
POWER SUPPLY	5.0Vdc (adapter or host equipment) 3.8Vdc (Li-ion battery)	
MODULATION TYPE	GSM, GPRS: GMSK EDGE: GMSK, 8PSK	
FREQUENCY RANGE	GSM, GPRS, EDGE: 1850.2MHz ~ 1909.8MHz	
MAX. EIRP POWER	GSM: 361mW	
	EDGE: 239mW	
EMISSION DESIGNATOR	GSM	247KGXW
	EDGE	251KG7W
ANTENNA TYPE	Fixed Internal antenna with 1.44dBi gain	
HW VERSION	A1990_MB_PCB_V2.0	
SW VERSION	A7-30GC_S000008_140930_ROW	
I/O PORTS	Refer to user's manual	
CABLE SUPPLIED	USB cable: shielded, detachable, 1.0m	

NOTE:

- For a more detailed features description, please refer to the manufacturer's specifications or the user's manual.
- The EUT was powered by the following adapters:

ADAPTER 1	
BRAND:	lenovo
MODEL:	C-P57
INPUT:	AC 100-240V, 150mA
OUTPUT:	DC 5V, 1000mA
MANUFACTURER:	Huntkey

ADAPTER 2	
BRAND:	lenovo
MODEL:	C-P57
INPUT:	AC 100-240V, 130mA
OUTPUT:	DC 5V, 1000mA
MANUFACTURER:	PI

ADAPTER 3	
BRAND:	lenovo
MODEL:	C-P57
INPUT:	AC 100-240V, 130mA
OUTPUT:	DC 5V, 1000mA
MANUFACTURER:	Acbel

- The EUT matched the following USB cable:



USB CABLE	
BRAND:	Li Qi
MODEL:	LQ-2BJ-HQ029-01
SIGNAL LINE:	1 meter

4. The new EUT contains the following components:

Parts	Brand	Model Name
Emcp (third source)	Samsung	KMF820012M-B305(8+16GB) KMF720012M-B214(8+8GB)
LCD Panel (third source)	Innolux	P070ACB-DB5
Front Camera	kingcome	G6PV-A1990FHQ
Rear Camera	kingcome	G7P2-A1990_2355HQ
spker	Haosheng	XHB151118B08-01-RH
PCB	RED BOARD (JIANGXI) LTD	A1990_MB_V2.0
Motor	Hongzhifa	HZF-Z04B-RL143B20-90
RF PA (second source)	vanchip	VC7590-21

5. For the test results, the EUT had been tested with all conditions. But only the worst case was shown in test report.



3.2 CONFIGURATION OF SYSTEM UNDER TEST

FOR RADIATION EMISSION TEST

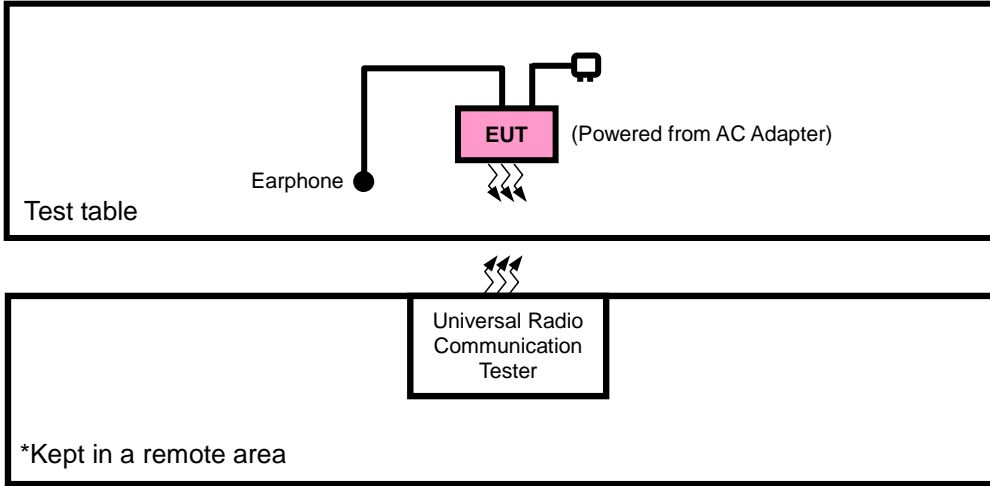

FOR E.I.R.P. TEST

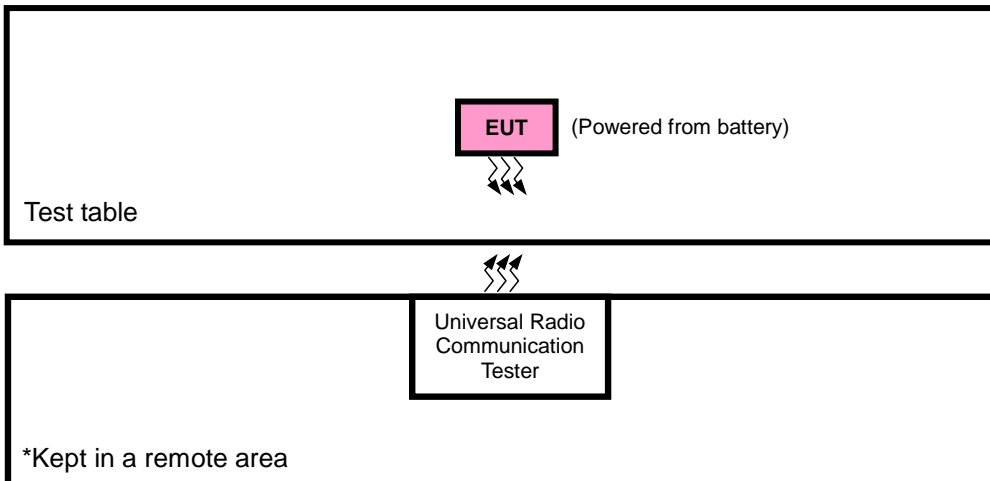



3.3 DESCRIPTION OF SUPPORT UNITS

The EUT has been tested as an independent unit together with other necessary accessories or support units. The following support units or accessories were used to form a representative test configuration during the tests.

NO.	PRODUCT	BRAND	MODEL NO.	SERIAL NO.	FCC ID
1	DC source	LONG WEI	PS-6403D	010934269	N/A
2	PC	HP	A6608CN	3CR83825X3	N/A

NO.	SIGNAL CABLE DESCRIPTION OF THE ABOVE SUPPORT UNITS
1	DC Line: Unshielded, Detachable 1.0m
2	AC Line :Unshielded, Detachable 1.5m

3.4 TEST ITEM AND TEST CONFIGURATION

Pre-Scan has been conducted to determine the worst-case mode from all possible combinations between available modulations, data rates, XYZ axis and antenna ports

The worst case was found when positioned on Y-plane for EIRP and X-axis for radiated emission. Following channel(s) was (were) selected for the final test as listed below:

EUT CONFIGURE MODE	DESCRIPTION
A	EUT + Adapter with GSM
B	EUT + Battery with GSM

GSM MODE

EUT CONFIGURE MODE	TEST ITEM	AVAILABLE CHANNEL	TESTED CHANNEL	MODE
B	EIRP	512 to 810	512, 661, 810	GSM, EDGE
B	FREQUENCY STABILITY	512 to 810	661	GSM, EDGE
B	OCCUPIED BANDWIDTH	512 to 810	512, 661, 810	GSM, EDGE
B	PEAK TO AVERAGE RATIO	512 to 810	661	GSM, EDGE
B	BAND EDGE	512 to 810	512, 810	GSM, EDGE
B	CONDCUDED EMISSION	512 to 810	661	GSM, EDGE
A	RADIATED EMISSION	512 to 810	661	GSM, EDGE



BUREAU
VERITAS

Test Report No.: RF160223W005-4



TEST CONDITION:

TEST ITEM	ENVIRONMENTAL CONDITIONS	INPUT POWER	TESTED BY
EIRP	25deg. C, 57%RH	5Vdc from adapter	Blue Zheng
FREQUENCY STABILITY	23deg. C, 61%RH	3.8Vdc from Battery	Yuqiang Yin
OCCUPIED BANDWIDTH	23deg. C, 61%RH	3.8Vdc from Battery	Yuqiang Yin
PEAK TO AVERAGE RATIO	23deg. C, 61%RH	3.8Vdc from Battery	Yuqiang Yin
BAND EDGE	23deg. C, 61%RH	3.8Vdc from Battery	Yuqiang Yin
CONDCUDED EMISSION	23deg. C, 61%RH	3.8Vdc from Battery	Yuqiang Yin
RADIATED EMISSION	25deg. C, 57%RH	5Vdc from adapter	Blue Zheng



3.5 EUT OPERATING CONDITIONS

The EUT makes a call to the communication simulator. The communication simulator station system controlled a EUT to export maximum output power under transmission mode and specific channel frequency

3.6 GENERAL DESCRIPTION OF APPLIED STANDARDS

The EUT is a RF product. According to the specifications of the manufacturer, it must comply with the requirements of the following standards:

FCC 47 CFR Part 2

FCC 47 CFR Part 24

ANSI/TIA/EIA-603-C 2004

NOTE: All test items have been performed and recorded as per the above standards.



4 TEST TYPES AND RESULTS

4.1 OUTPUT POWER MEASUREMENT

4.1.1 LIMITS OF OUTPUT POWER MEASUREMENT

Mobile and portable stations are limited to 2 watts EIRP

4.1.2 TEST PROCEDURES

EIRP MEASUREMENT:

- a. All measurements were done at low, middle and high operational frequency range. RBW and VBW is 1MHz for GSM, GPRS & EDGE ; 5MHz for WCDMA mode and 10MHz for LTE mode.
- b. Substitution method is used for E.I.R.P measurement. In the semi-anechoic chamber, EUT placed on the 0.8m height of Turn Table, rotated the table around 360 degrees to search the maximum radiation power and receiver antenna shall be rotated vertical and horizontal polarization and moved height from 1m to 4m to find the maximum polar radiated power. The “Read Value” is the spectrum reading the maximum power value.
- c. The substitution horn antenna is substituted for EUT at the same position and signals generator export the CW signal to the substitution antenna via a tx cable. Rotated the Turn Table and moved receiving antenna to find the maximum radiation power. Adjust output power level of S.G to get a Value of spectrum reading equal to “Read Value “ of step b. Record the power level of S.G
- d. $EIRP = \text{Output power level of S.G} - \text{TX cable loss} + \text{Antenna gain of substitution horn.}$

CONDUCTED POWER MEASUREMENT:

The EUT was set up for the maximum power with GSM, GPRS, EDGE & WCDMA link data modulation and link up with simulator. Set the EUT to transmit under low, middle and high channel and record the power level shown on simulator.



4.1.3 TEST SETUP

EIRP MEASUREMENT:

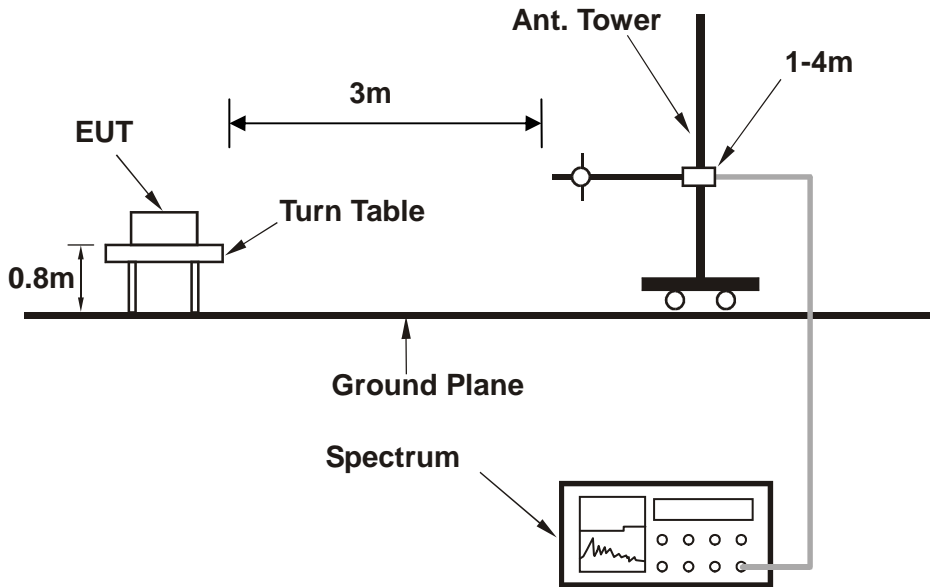

For the actual test configuration, please refer to the attached file (Test Setup Photo).

CONDUCTED POWER MEASUREMENT:



For the actual test configuration, please refer to the attached file (Test Setup Photo).



4.1.4 TEST RESULTS

CONDUCTED OUTPUT POWER (dBm)

Band	GSM1900		
	512	661	810
Channel	1850.2	1880.0	1909.8
Frequency (MHz)	1850.2	1880.0	1909.8
GSM	28.49	27.58	27.94
GPRS 8	28.48	27.57	27.93
GPRS 10	27.69	26.82	27.22
EDGE 8 (MCS1)	28.43	27.57	27.93
EDGE 10 (MCS1)	27.62	26.82	27.18
EDGE 8 (MCS9)	25.14	24.55	24.56
EDGE 10 (MCS9)	24.16	23.51	23.62



EIRP POWER (dBm)

GSM

Channel	Frequency (MHz)	LVL (dBm)	Correction Factor(dB)	EIRP(dBm)	EIRP(mW)	Polarization (H/V)
512	1850.2	-18.26	43.83	25.57	360.58	H
661	1880	-18.54	43.57	25.03	318.42	H
810	1909.3	-19.13	44.57	25.44	349.95	H
512	1850.2	-25.72	46.39	20.67	116.68	V
661	1880	-25.80	47.10	21.30	134.83	V
810	1909.3	-25.33	45.98	20.65	116.04	V

EDGE

Channel	Frequency (MHz)	LVL (dBm)	Correction Factor(dB)	EIRP(dBm)	EIRP(mW)	Polarization (H/V)
512	1850.2	-20.54	43.83	23.29	213.30	H
661	1880	-20.68	43.57	22.89	194.54	H
810	1909.3	-20.79	44.57	23.78	238.78	H
512	1850.2	-25.76	46.39	20.63	115.61	V
661	1880	-25.99	47.10	21.11	129.06	V
810	1909.3	-25.54	45.98	20.44	110.56	V



4.2 FREQUENCY STABILITY MEASUREMENT

4.2.1 LIMITS OF FREQUENCY STABILITY MEASUREMENT

The frequency stability shall be sufficient to ensure that the fundamental emission stays within the authorized frequency block.

4.2.2 TEST PROCEDURE

- Device is placed at the oven room. The oven room could control the temperatures and humidity. Power warm up is at least 15 min and power applied should perform before recording frequency error.
- EUT is connected the external power supply to control the DC input power. The test voltage range is from minimum to maximum working voltage. Each step shall be record the frequency error rate.
- The temperature range step is 10 degrees in this test items. All temperature levels shall be hold the $\pm 0.5^{\circ}\text{C}$ during the measurement testing. The each temperature step shall be at least 0.5 hours, consider the EUT could be test under the stability condition.

NOTE: The frequency error was recorded frequency error from the communication simulator.

4.2.3 TEST SETUP

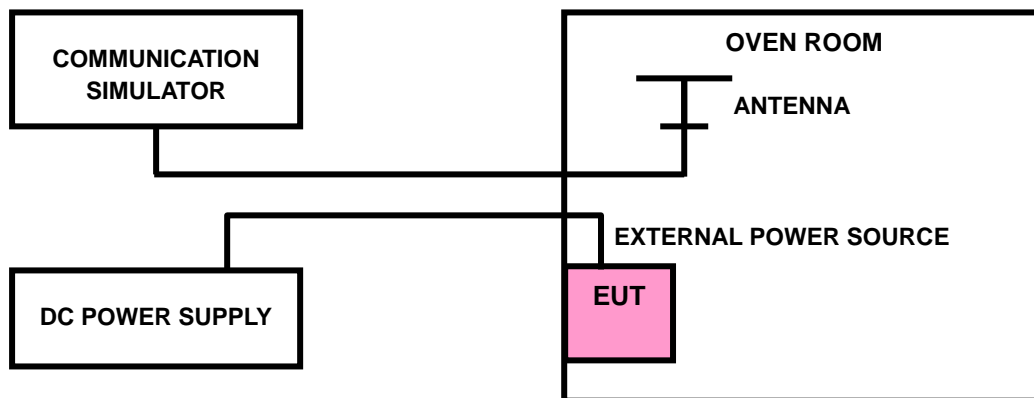



4.2.4 TEST RESULTS

FREQUENCY ERROR VS. VOLTAGE

Voltage (Volts)	Frequency Error (ppm)		Limit(ppm)
	GSM	EDGE	
3.7(normal)	0.0011	0.0010	2.5
3.4(Min.)	-0.0018	-0.0017	2.5
4.2(Max.)	-0.0017	-0.0021	2.5

NOTE: The applicant defined the normal working voltage of the battery is from 3.4Vdc to 4.2Vdc.

FREQUENCY ERROR vs. TEMPERATURE.

Voltage (Volts)	Frequency Error (ppm)		Limit (ppm)
	GSM	EDGE	
-30	-0.0060	-0.0063	2.5
-20	-0.0054	-0.0055	2.5
-10	-0.0046	-0.0049	2.5
0	-0.0034	-0.0040	2.5
10	-0.0028	-0.0034	2.5
20	-0.0020	-0.0025	2.5
30	-0.0012	-0.0017	2.5
40	-0.0007	-0.0012	2.5
50	-0.0005	-0.0005	2.5
60	-0.0001	-0.0004	2.5



4.3 OCCUPIED BANDWIDTH MEASUREMENT

4.3.1 TEST PROCEDURES

The EUT makes a call to the communication simulator. All measurements were done at low, middle and high operational frequency range. The communication simulator station system controlled a EUT to export maximum output power under transmission mode and specific channel frequency. Use OBW measurement function of Spectrum analyzer to measure 99 % occupied bandwidth.

4.3.2 TEST SETUP

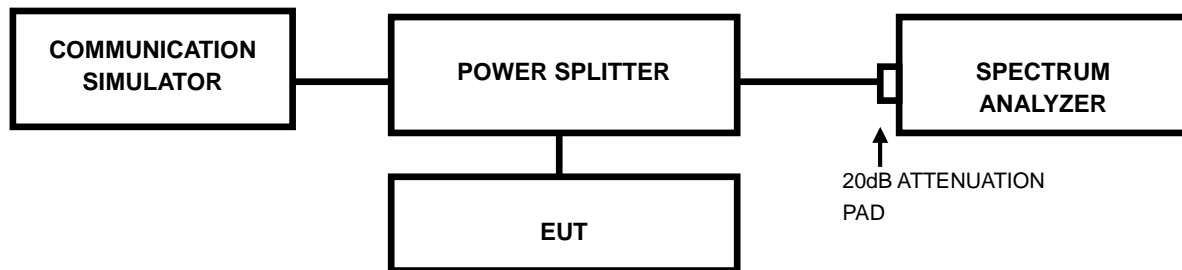



4.3.3 TEST RESULTS

CHANNEL	FREQUENCY (MHz)	99% OCCUPIED BANDWIDTH (kHz)	
		GSM	EDGE
512	1850.2	247.00	251.00
661	1880.0	245.00	249.00
810	1909.8	242.00	248.00

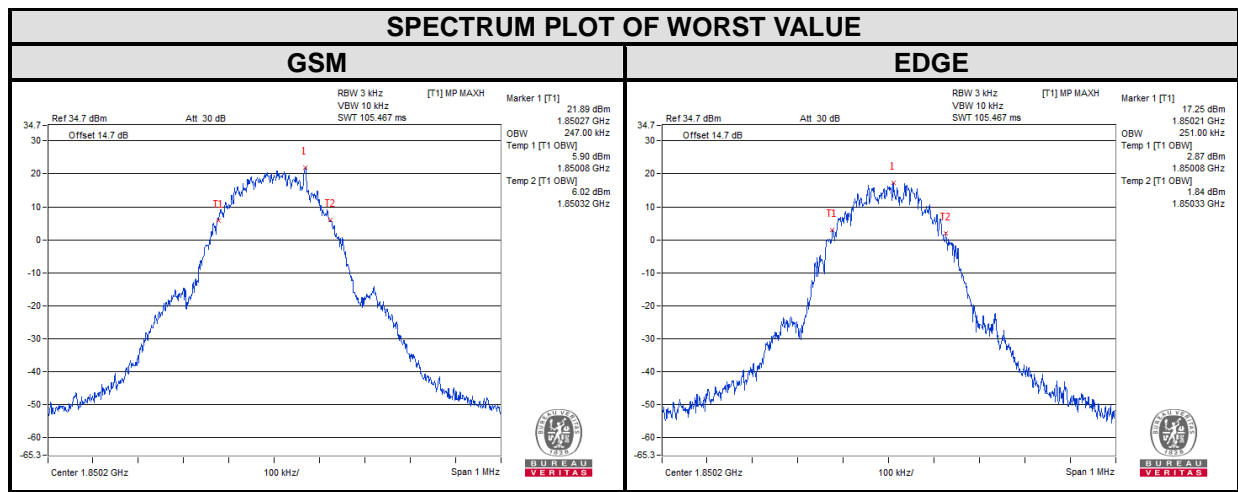



CHANNEL	FREQUENCY (MHz)	26dB BANDWIDTH (kHz)	
		GSM	EDGE
512	1850.2	318.979	326.035
661	1880.0	321.140	323.473
810	1909.8	316.661	323.521

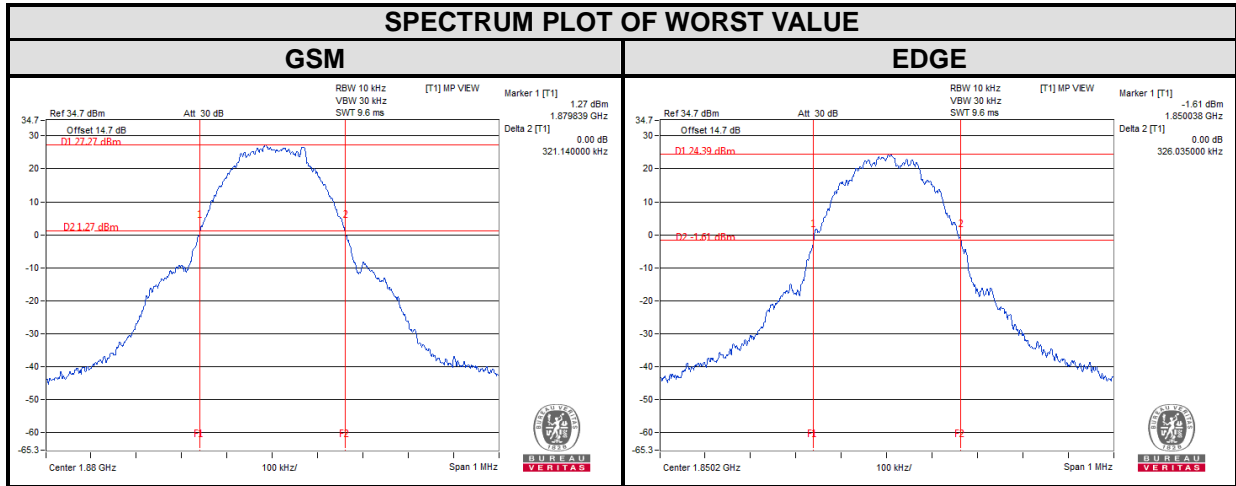



4.4 BAND EDGE MEASUREMENT

4.4.1 LIMITS OF BAND EDGE MEASUREMENT

Power of any emission outside of the authorized operating frequency ranges must be attenuated below the transmitting power (P) by a factor of at least $43 + 10 \log(P)$ dB. In the 1 MHz bands immediately outside and adjacent to the frequency block a resolution bandwidth of at least one percent of the emission bandwidth of the fundamental emission of the transmitter may be employed.

4.4.2 TEST SETUP

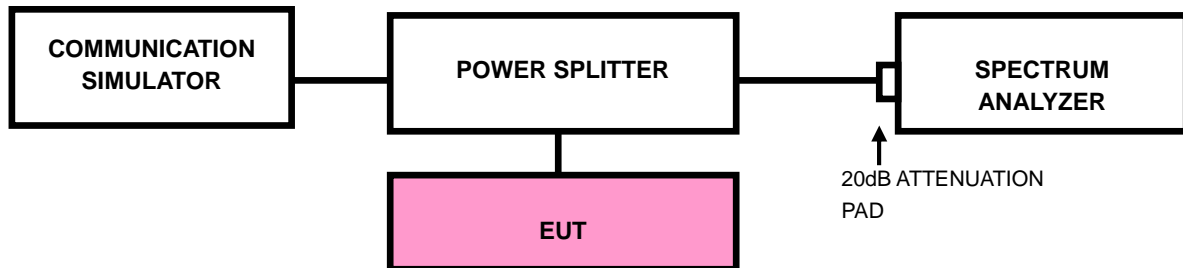

4.4.3 TEST PROCEDURES

- All measurements were done at low and high operational frequency range.
- The center frequency of spectrum is the band edge frequency and span is 1.5 MHz. RBW of the spectrum is 10kHz and VBW of the spectrum is 30kHz (GSM/GPRS/ EDGE).
- Record the max trace plot into the test report.



4.4.4. TEST RESULTS

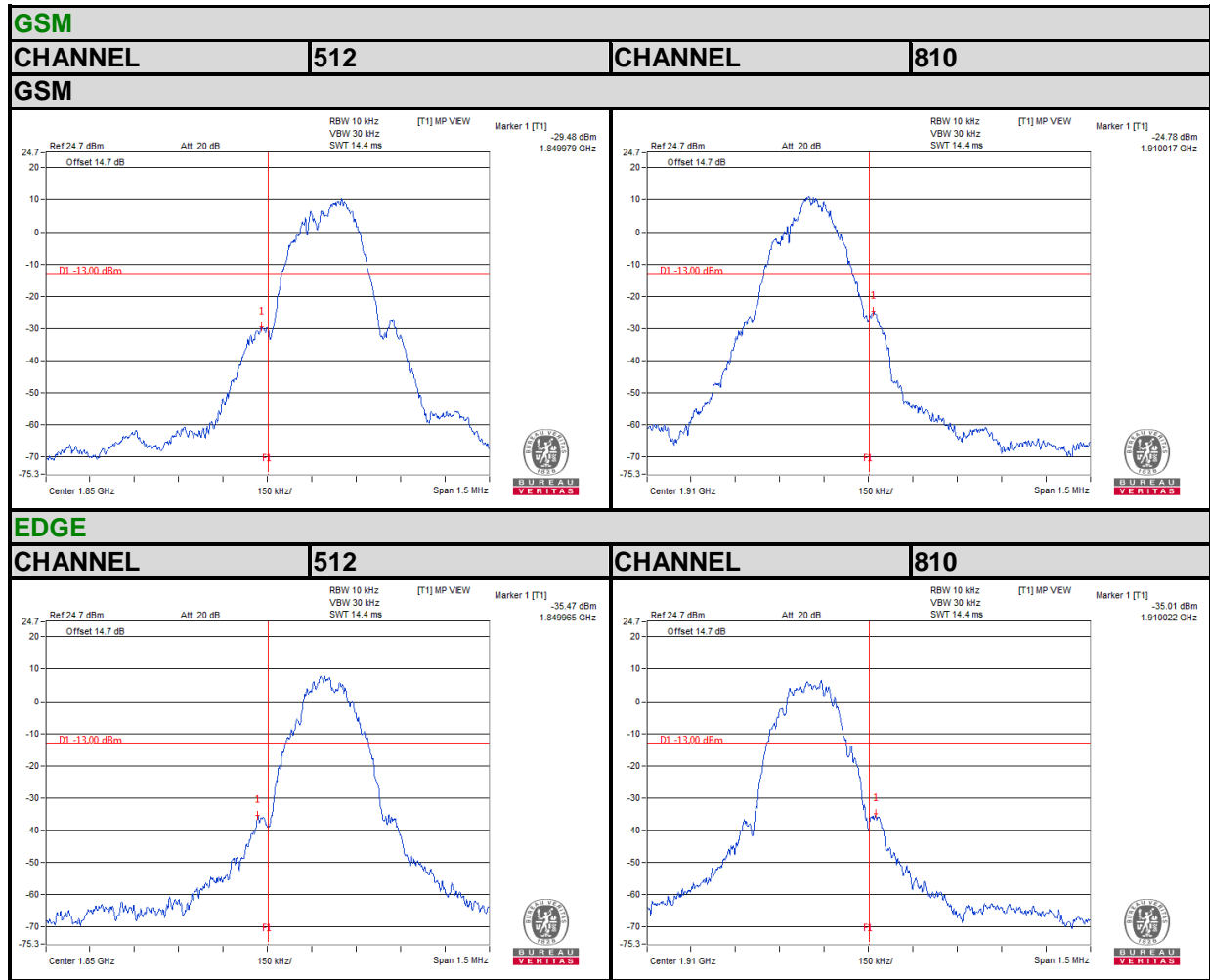



4.5 CONDUCTED SPURIOUS EMISSIONS

4.5.1 LIMITS OF CONDUCTED SPURIOUS EMISSIONS MEASUREMENT

The power of any emission outside of the authorized operating frequency ranges must be attenuated below the transmitting power (P) by a factor of at least $43 + 10 \log(P)$ dB. The emission limit equal to -13dBm .

4.5.2 TEST PROCEDURE

- a. The EUT makes a phone call to the communication simulator. All measurements were done at low, middle and high operational frequency range.
- b. Measuring frequency range is from 9 kHz to 19.1GHz. 20dB attenuation pad is connected with spectrum. RBW=1MHz and VBW=3MHz is used for conducted emission measurement.

4.5.3 TEST SETUP

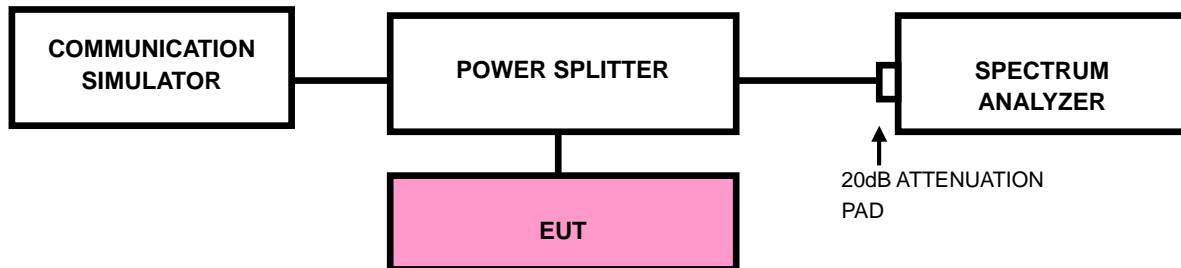



4.5.4 TEST RESULTS

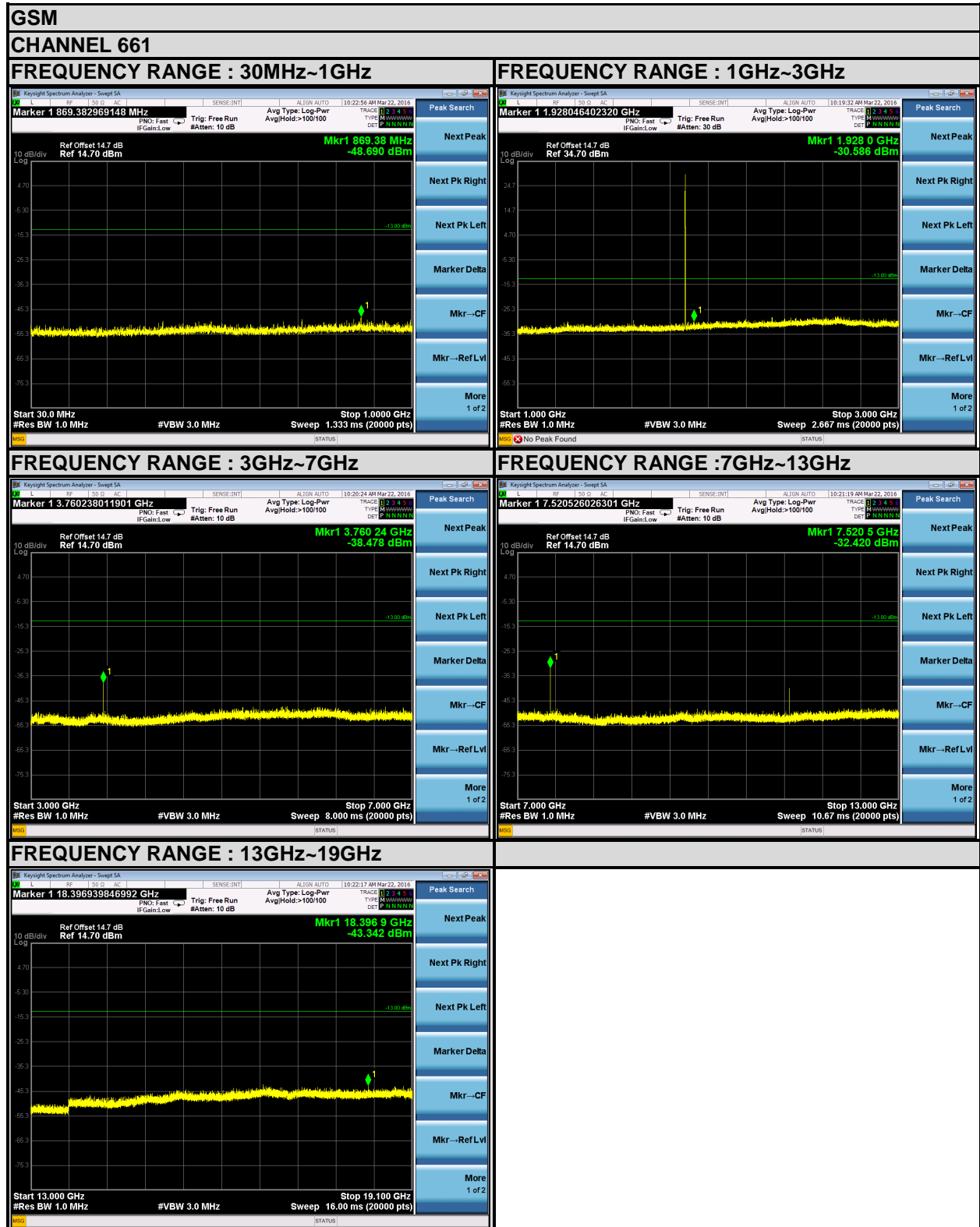

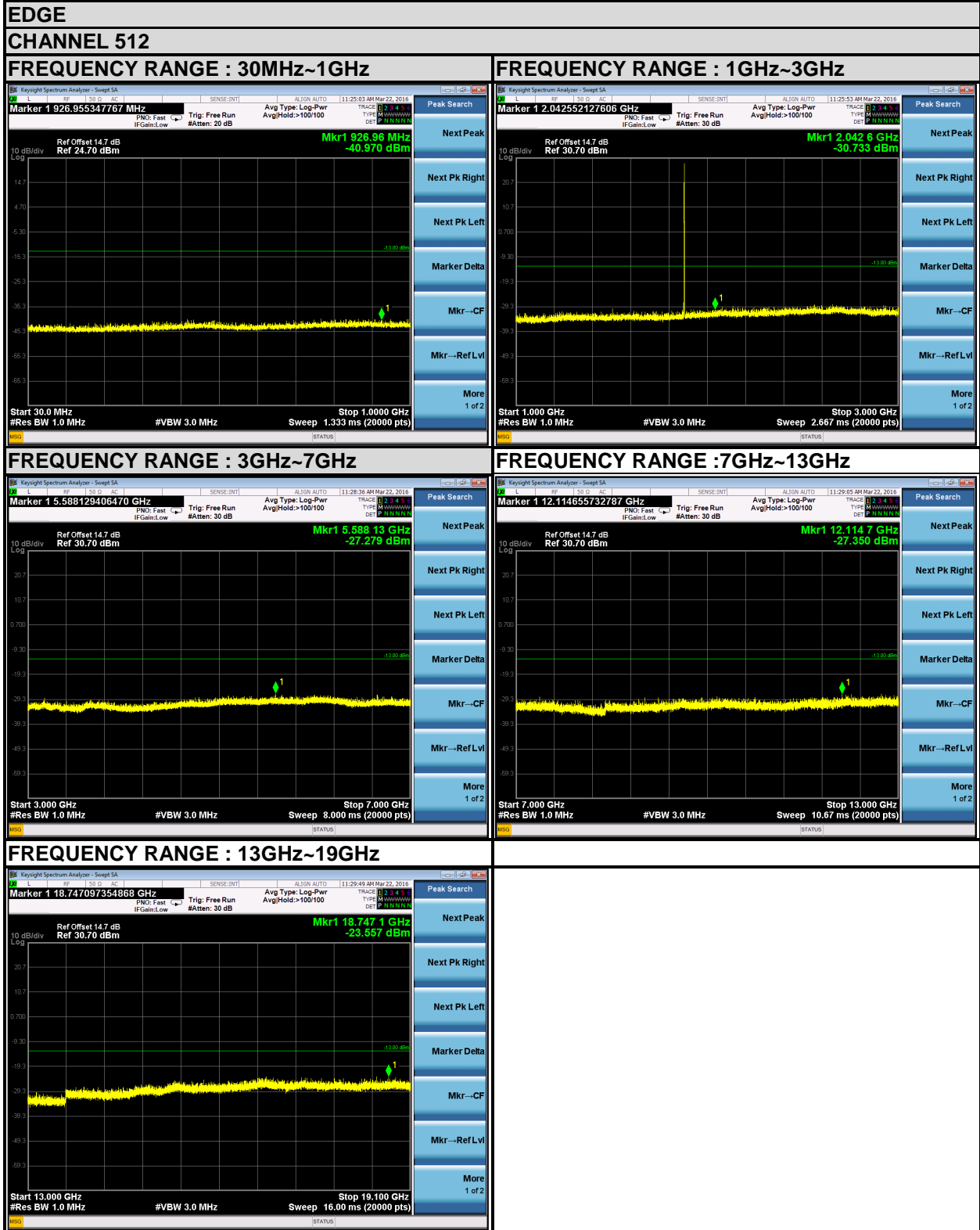



4.6 RADIATED EMISSION MEASUREMENT

4.6.1 LIMITS OF RADIATED EMISSION MEASUREMENT

The power of any emission outside of the authorized operating frequency ranges must be attenuated below the transmitting power (P) by a factor of at least $43 + 10 \log(P)$ dB. The emission limit equal to -13dBm .

4.6.2 TEST PROCEDURES

- a. Substitution method is used for E.I.R.P measurement. In the semi-anechoic chamber, EUT placed on the 0.8m height of Turn Table, rotated the table around 360 degrees to search the maximum radiation power and receiver antenna shall be rotated vertical and horizontal polarization and moved height from 1m to 4m to find the maximum polar radiated power. The “Read Value” is the spectrum reading the maximum power value.
- b. The substitution horn antenna is substituted for EUT at the same position and signals generator export the CW signal to the substitution antenna via a TX cable. Rotated the Turn Table and moved receiving antenna to find the maximum radiation power. Adjust output power level of S.G to get a Value of spectrum reading equal to “Read Value “ of step a. Record the power level of S.G
- c. $\text{EIRP} = \text{Output power level of S.G} - \text{TX cable loss} + \text{Antenna gain of substitution horn.}$

NOTE: The resolution bandwidth and video bandwidth of test receiver/spectrum analyzer is 1MHz/3MHz.

4.6.3 DEVIATION FROM TEST STANDARD

No deviation



4.6.4 TEST SETUP

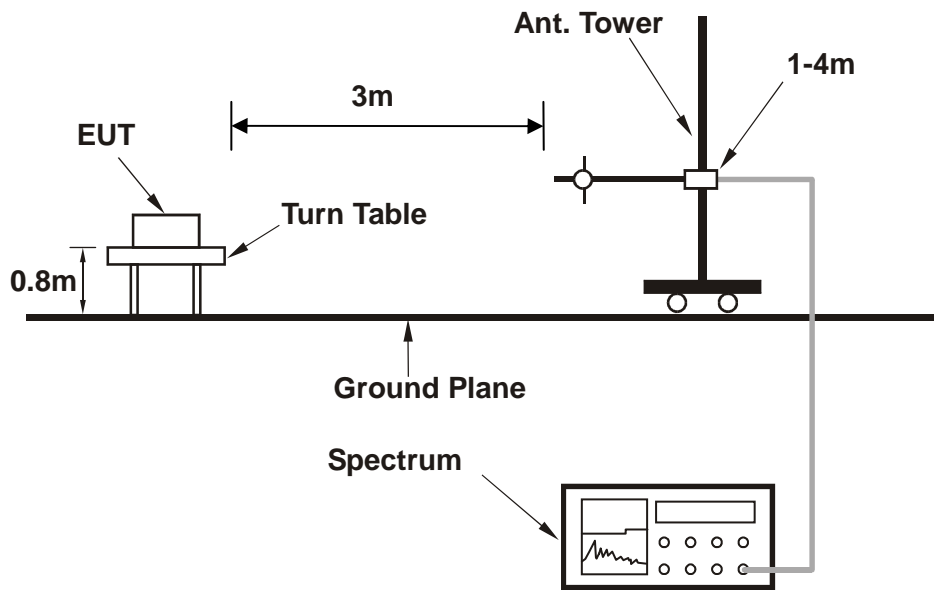

For the actual test configuration, please refer to the attached file (Test Setup Photo).



4.6.5 TEST RESULTS

BELOW 1GHz WORST-CASE DATA : GSM1900

PCS 1900:

MODE	TX channel 661	FREQUENCY RANGE	Below 1000MHz
ENVIRONMENTAL CONDITIONS	26deg. C, 56%RH	INPUT POWER	DC 5V from adapter
TESTED BY	Alex Chen		
ANTENNA POLARITY & TEST DISTANCE: HORIZONTAL AT 3 M			

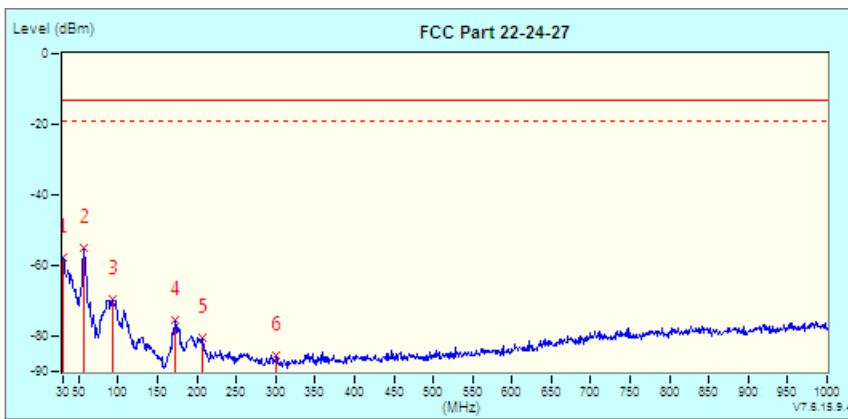

No.	Frequency MHz	Factor dB	Reading dBm	Emission dBm	Limit dBm	Margin dB	Tower / Table cm deg	
1	30.00	19.34	-77.08	-57.74	-13.00	-44.74	--	--
*	2	-4.25	-50.74	-54.99	-13.00	-41.99	--	--
3	93.05	-9.69	-59.71	-69.40	-13.00	-56.40	--	--
4	171.62	-18.06	-57.62	-75.68	-13.00	-62.68	--	--
5	206.54	-17.11	-63.49	-80.60	-13.00	-67.60	--	--
6	300.63	-13.79	-71.74	-85.53	-13.00	-72.53	--	--



MODE	TX channel 661	FREQUENCY RANGE	Below 1000MHz
ENVIRONMENTAL CONDITIONS	26deg. C, 56%RH	INPUT POWER	DC 5V from adapter
TESTED BY	Alex Chen		
ANTENNA POLARITY & TEST DISTANCE: VERTICAL AT 3 M			

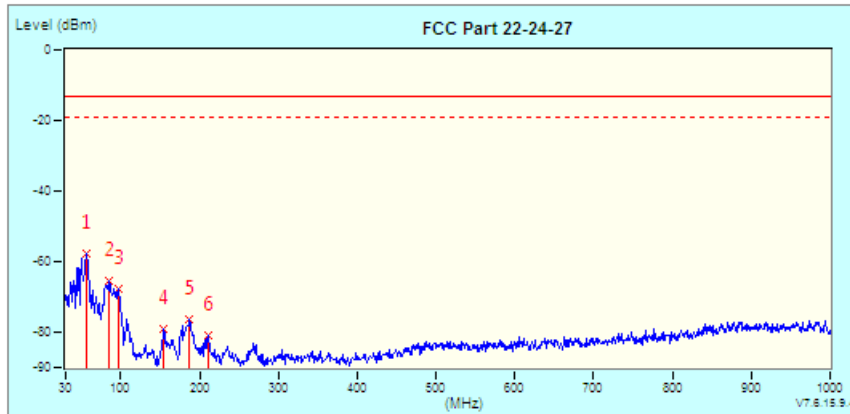

No.	Frequency MHz	Factor dB	Reading dBm	Emission dBm	Limit dBm	Margin dB	Tower / Table	
							cm	deg
* 1	57.16	-10.20	-47.74	-57.94	-13.00	-44.94	--	--
2	85.29	-10.40	-55.17	-65.57	-13.00	-52.57	--	--
3	96.93	-10.63	-57.01	-67.64	-13.00	-54.64	--	--
4	154.16	-15.69	-63.42	-79.11	-13.00	-66.11	--	--
5	187.14	-12.26	-63.90	-76.16	-13.00	-63.16	--	--
6	210.42	-10.82	-70.12	-80.94	-13.00	-67.94	--	--



ABOVE 1GHz DATA

PCS 1900:

MODE	TX channel 661	FREQUENCY RANGE	Above 1000MHz
ENVIRONMENTAL CONDITIONS	26deg. C, 56%RH	INPUT POWER	DC 5V from adapter
TESTED BY	Alex Chen		
ANTENNA POLARITY & TEST DISTANCE: HORIZONTAL AT 3 M			

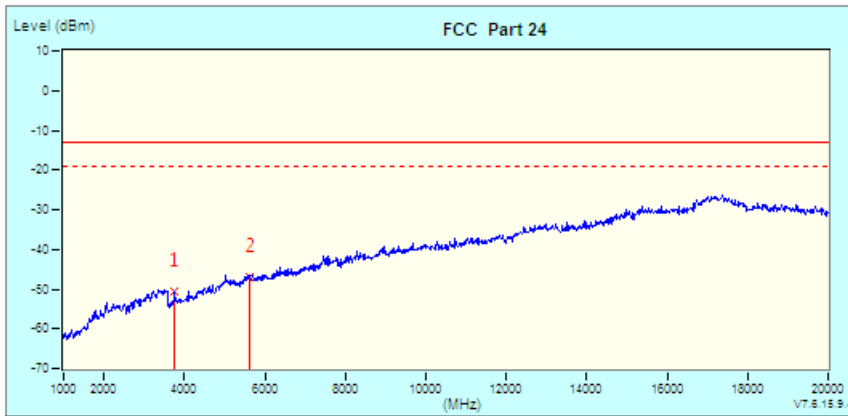

No.	Frequency MHz	Factor dB	Reading dBm	Emission dBm	Limit dBm	Margin dB	Tower / Table cm deg	
1	3760.00 (PK)	3.41	-53.97	-50.56	-13.00	-37.56	300	0
2	5640.00 (PK)	9.12	-56.01	-46.89	-13.00	-33.89	300	0



MODE	TX channel 661	FREQUENCY RANGE	Above 1000MHz
ENVIRONMENTAL CONDITIONS	26deg. C, 56%RH	INPUT POWER	DC 5V from adapter
TESTED BY	Alex Chen		
ANTENNA POLARITY & TEST DISTANCE: VERTICAL AT 3 M			

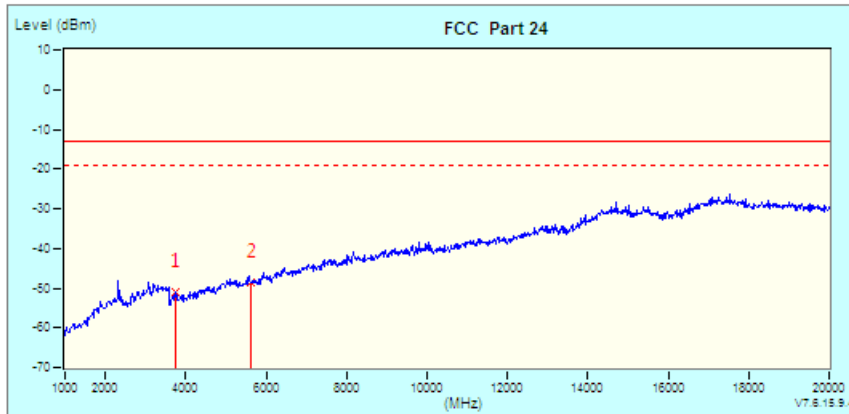

No.	Frequency MHz	Factor dB	Reading dBm	Emission dBm	Limit dBm	Margin dB	Tower / Table cm deg	
1	3760.00 (PK)	3.88	-55.06	-51.18	-13.00	-38.18	100	360
* 2	5640.00 (PK)	8.26	-56.79	-48.53	-13.00	-35.53	100	360



EDGE 1900:

MODE	TX channel 661	FREQUENCY RANGE	Above 1000MHz
ENVIRONMENTAL CONDITIONS	26deg. C, 56%RH	INPUT POWER	DC 5V from adapter
TESTED BY	Alex Chen		
ANTENNA POLARITY & TEST DISTANCE: HORIZONTAL AT 3 M			

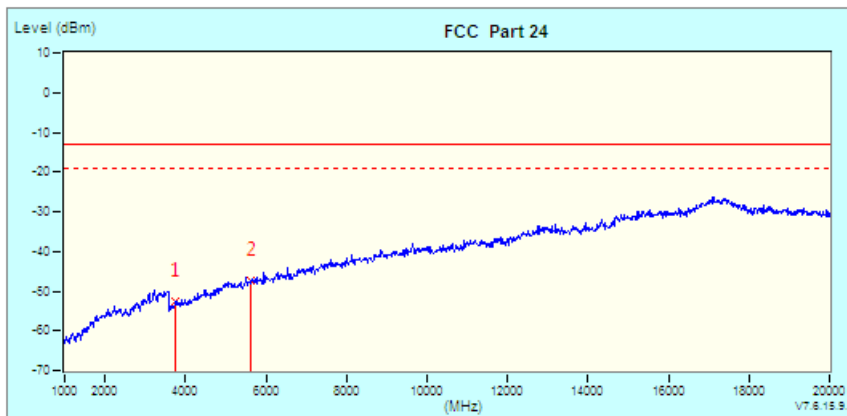

No.	Frequency MHz	Factor dB	Reading dBm	Emission dBm	Limit dBm	Margin dB	Tower / Table cm deg	
1	3760.00 (PK)	3.41	-56.10	-52.69	-13.00	-39.69	100	0
* 2	5640.00 (PK)	9.12	-56.47	-47.35	-13.00	-34.35	100	0



MODE	TX channel 661	FREQUENCY RANGE	Above 1000MHz
ENVIRONMENTAL CONDITIONS	26deg. C, 56%RH	INPUT POWER	DC 5V from adapter
TESTED BY	Alex Chen		
ANTENNA POLARITY & TEST DISTANCE: VERTICAL AT 3 M			

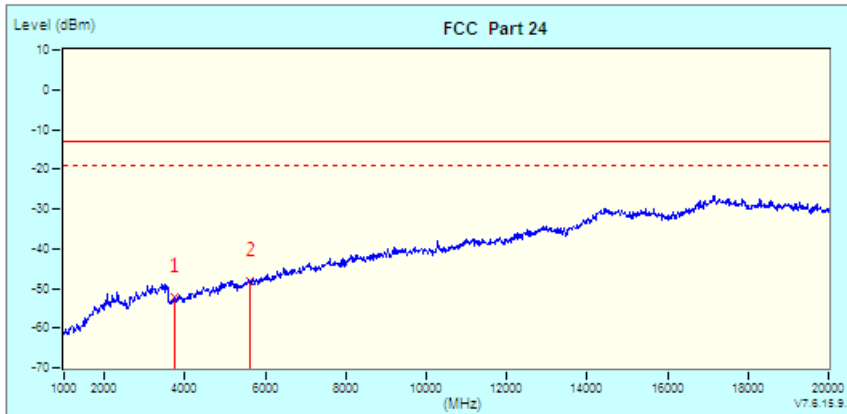

No.	Frequency MHz	Factor dB	Reading dBm	Emission dBm	Limit dBm	Margin dB	Tower / Table cm deg	
1	3760.00 (PK)	3.88	-55.91	-52.03	-13.00	-39.03	300	360
* 2	5640.00 (PK)	8.26	-56.59	-48.33	-13.00	-35.33	300	360



4.7 PEAK TO AVERAGE RATIO

4.7.1 LIMITS OF peak to average ratio MEASUREMENT

In measuring transmissions in this band using an average power technique, the peak to-average ratio (PAR) of the transmission may not exceed 13 dB

4.7.2 TEST SETUP

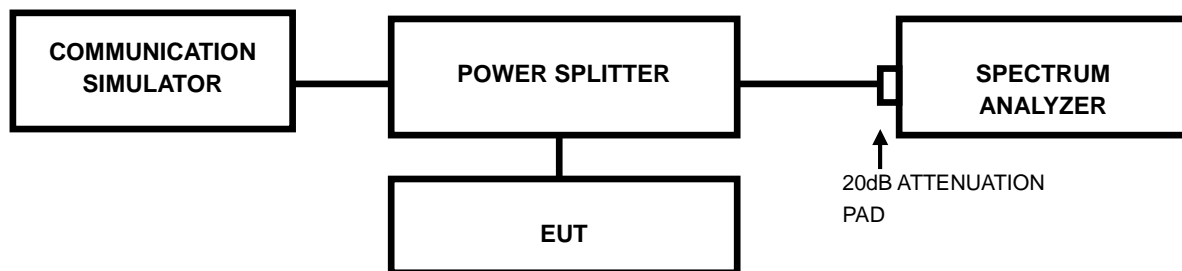

4.7.3 TEST PROCEDURES

1. Set resolution/measurement bandwidth \geq signal's occupied bandwidth;
2. Set the number of counts to a value that stabilizes the measured CCDF curve;
3. Record the maximum PAPR level associated with a probability of 0.1%.



4.7.4 TEST RESULTS

GSM

CHANNEL	FREQUENCY (MHz)	PEAK TO AVERAGE RATIO (dB)
661	1880	9.44

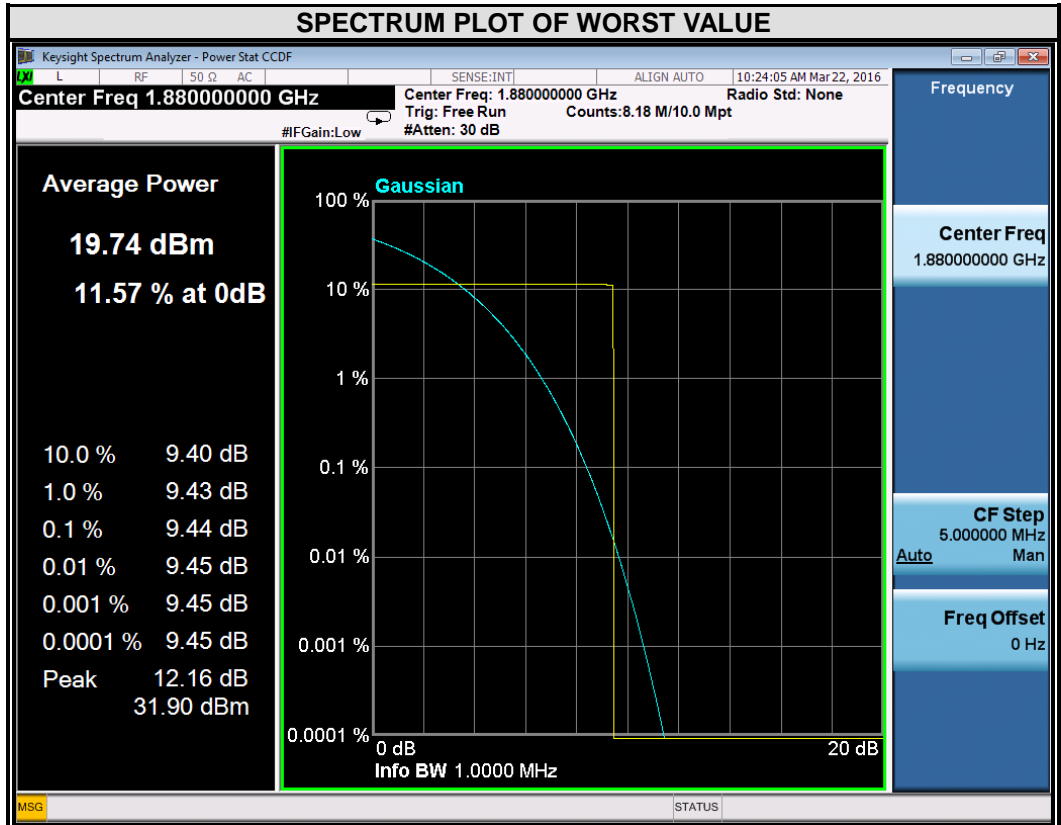



EDGE

CHANNEL	FREQUENCY (MHz)	PEAK TO AVERAGE RATIO (dB)
661	1880	9.48

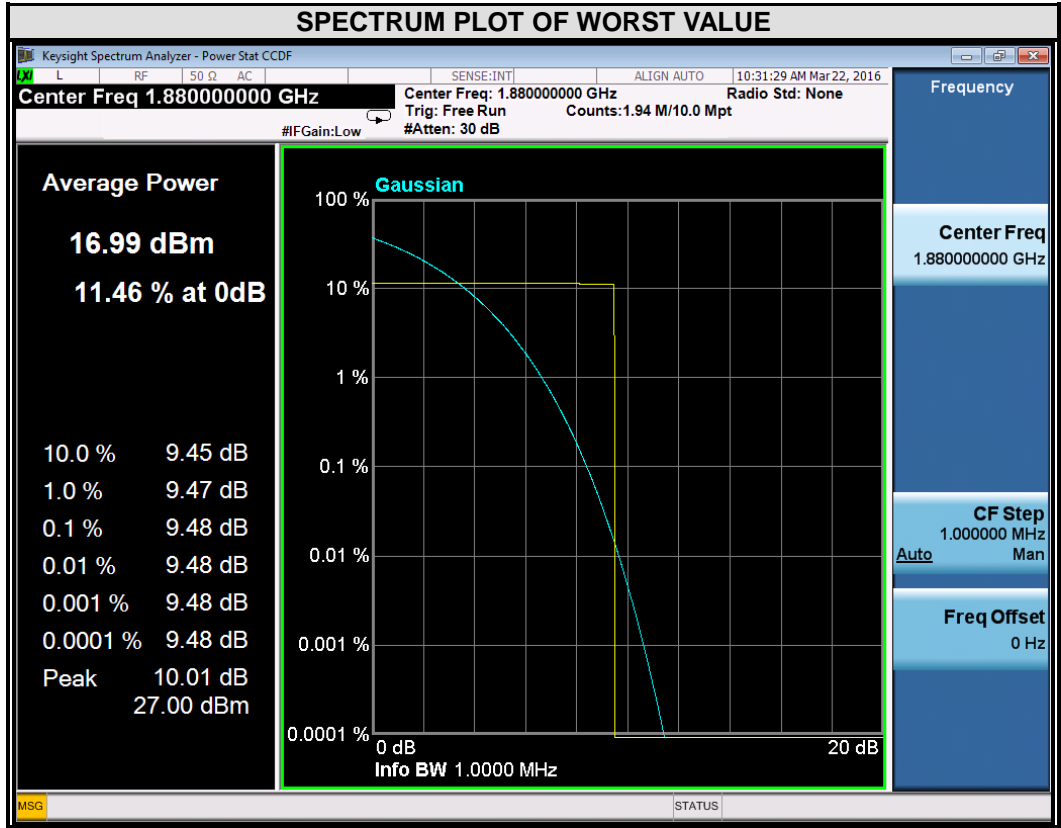



5 INFORMATION ON THE TESTING LABORATORIES

We, Bureau Veritas Shenzhen Co., Ltd. Dongguan Branch, were founded in 2002 to provide our best service in EMC, Radio, Telecom and Safety consultation. Our laboratories are accredited and approved according to ISO/IEC 17025.

If you have any comments, please feel free to contact us at the following:

Dongguan EMC/RF Lab:

Tel: +86-769-85935656

Fax: +86-769-85931080

Email: customerservice.dg@cn.bureauveritas.com

Web Site: www.adt.com.tw

The address and road map of all our labs can be found in our web site also.



6 APPENDIX A – MODIFICATIONS RECORDERS FOR ENGINEERING CHANGES TO THE EUT BY THE LAB

No any modifications are made to the EUT by the lab during the test.

---END---