

# FCC RF Test Report

**APPLICANT** : Lenovo (Shanghai) Electronics Technology Co., Ltd.  
**EQUIPMENT** : Tablet PC  
**BRAND NAME** : Vodafone  
**MODEL NAME** : Smart Tab III<sup>10</sup>  
**MARKETING NAME** : Vodafone Smart Tab III10  
**FCC ID** : O57S6000VDF3G  
**STANDARD** : FCC Part 15 Subpart C §15.247  
**CLASSIFICATION** : (DTS) Digital Transmission System

The product was received on Mar. 07, 2013 and completely tested on Mar. 23, 2013. We, SPORTON INTERNATIONAL (KUNSHAN) INC., would like to declare that the tested sample has been evaluated in accordance with the procedures and shown the compliance with the applicable technical standards.

The test results in this report apply exclusively to the tested model / sample. Without written approval of SPORTON INTERNATIONAL (KUNSHAN) INC., the test report shall not be reproduced except in full.



Reviewed by: Joseph Lin / Manager

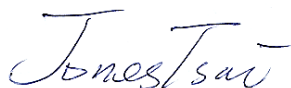

Approved by: Jones Tsai / Manager



Testing Laboratory  
2627

**SPORTON INTERNATIONAL (KUNSHAN) INC.**  
**No. 3-2, PingXiang Road, Kunshan, Jiangsu Province, P.R.C.**



## TABLE OF CONTENTS

REVISION HISTORY.....	3
SUMMARY OF TEST RESULT .....	4
<b>1 GENERAL DESCRIPTION.....</b>	<b>5</b>
1.1 Applicant.....	5
1.2 Manufacturer.....	5
1.3 Feature of Equipment Under Test.....	5
1.4 Product Specification of Equipment Under Test.....	5
1.5 Testing Site.....	6
1.6 Applied Standards .....	6
<b>2 TEST CONFIGURATION OF EQUIPMENT UNDER TEST.....</b>	<b>7</b>
2.1 Descriptions of Test Mode.....	7
2.2 Test Mode.....	8
2.3 Connection Diagram of Test System.....	9
2.4 Support Unit used in test configuration and system.....	10
2.5 Description of RF Function Operation Test Setup.....	10
2.6 Measurement Results Explanation Example.....	10
<b>3 TEST RESULT .....</b>	<b>11</b>
3.1 6dB Bandwidth Measurement .....	11
3.2 Peak Output Power Measurement .....	14
3.3 Power Spectral Density Measurement .....	17
3.4 Conducted Band Edges and Spurious Emission Measurement .....	23
3.5 Radiated Band Edges and Spurious Emission Measurement .....	28
3.6 AC Conducted Emission Measurement.....	44
3.7 Antenna Requirements.....	48
<b>4 LIST OF MEASURING EQUIPMENT.....</b>	<b>49</b>
<b>5 UNCERTAINTY OF EVALUATION.....</b>	<b>50</b>
<b>APPENDIX A. PHOTOGRAPHS OF EUT</b>	
<b>APPENDIX B. SETUP PHOTOGRAPHS</b>	



## SUMMARY OF TEST RESULT

Report Section	FCC Rule	Description	Limit	Result	Remark
3.1	15.247(a)(2)	6dB Bandwidth	$\geq 0.5\text{MHz}$	Pass	-
3.2	15.247(b)(1)	Peak Output Power	$\leq 30\text{dBm}$	Pass	-
3.5	15.247(e)	Power Spectral Density	$\leq 8\text{dBm}$	Pass	-
3.4	15.247(d)	Conducted Band Edges and Spurious Emission	$\leq 20\text{dBc}$	Pass	-
3.5	15.247(d)	Radiated Band Edges and Spurious Emission	15.209(a) & 15.247(d)	Pass	Under limit 9.06 dB at 2483.500 MHz
3.6	15.207	AC Conducted Emission	15.207(a)	Pass	Under limit 5.72 dB at 0.430 MHz
3.7	15.203 & 15.247(b)	Antenna Requirement	N/A	Pass	-

# 1 General Description

## 1.1 Applicant

**Lenovo (Shanghai) Electronics Technology Co., Ltd.**

No. 68 Building, 199 Fenju Road, Wai Gao Qiao FTZ, Shanghai, China

## 1.2 Manufacturer

**Lenovo PC HK Limited**

23/F, Lincoln House, Taikoo Place 979 King's Road, Quarry Bay, Hong Kong

## 1.3 Feature of Equipment Under Test

Product Feature	
Equipment	Tablet PC
Brand Name	Vodafone
Model Name	Smart Tab III <sup>10</sup>
Marketing Name	Vodafone Smart Tab III10
FCC ID	O57S6000VDF3G
EUT supports Radios application	GPRS/EGPRS/WCDMA/HSPA/HSPA+/WLAN 11bgn/ Bluetooth 3.0/4.0
HW Version	H401
SW Version	S6000-S3
EUT Stage	Identical Prototype

**Remark:** The above EUT's information was declared by manufacturer. Please refer to the specifications or user's manual for more detailed description.

## 1.4 Product Specification of Equipment Under Test

Product Specification subjective to this standard	
Tx/Rx Frequency Range	2402 MHz ~ 2480 MHz
Number of Channels	40
Carrier Frequency of Each Channel	2402+n*2 MHz; n=0~39
Maximum Output Power to Antenna	1.07 dBm (0.0013 W)
Antenna Type	Fixed Internal Antenna with gain 3.10 dBi
Type of Modulation	GFSK

### 1.5 Testing Site

<b>Test Site</b>	SPORTON INTERNATIONAL INC.	
<b>Test Site Location</b>	No. 52, Hwa Ya 1 <sup>st</sup> Rd., Hwa Ya Technology Park, Kwei-Shan Hsiang, Tao Yuan Hsien, Taiwan, R.O.C. TEL: +886-3-3273456 / FAX: +886-3-3284978	
<b>Test Site No.</b>	<b>Sporton Site No.</b>	<b>FCC/IC Registration No.</b>
	03CH07-HY	722060/4086B-1

<b>Test Site</b>	SPORTON INTERNATIONAL (KUNSHAN) INC.	
<b>Test Site Location</b>	No. 3-2, PingXiang Road, Kunshan, Jiangsu Province, P.R.C. TEL: +86-0512-5790-0158 FAX: +86-0512-5790-0958	
<b>Test Site No.</b>	<b>Sporton Site No.</b>	<b>FCC/IC Registration No.</b>
	TH01-KS	CO01-KS
		149928/4086E-1

The test site complies with ANSI C63.4 2003 requirement.

### 1.6 Applied Standards

According to the specifications of the manufacturer, the EUT must comply with the requirements of the following standards:

- FCC Part 15 Subpart C §15.247
- FCC KDB Publication No. 558074 D01 DTS Meas. Guidance v02
- ANSI C63.10-2009

**Remark:**

1. All test items were verified and recorded according to the standards and without any deviation during the test.
2. This EUT has also been tested and complied with the requirements of FCC Part 15, Subpart B, recorded in a separate test report.

## 2 Test Configuration of Equipment Under Test

### 2.1 Descriptions of Test Mode

The RF output power was recorded in the following table:

Channel	Frequency	Bluetooth 4.0 – LE RF Output Power
		Data Rate / Modulation
		GFSK
		1Mbps
Ch00	2402MHz	0.39 dBm
Ch19	2440MHz	0.65 dBm
Ch39	2480MHz	<b>1.07 dBm</b>

- a. The EUT has been associated with peripherals pursuant to ANSI C63.4-2003 and ANSI C63.10-2009 and configuration operated in a manner tended to maximize its emission characteristics in a typical application. Frequency range investigated: conduction (150 kHz to 30 MHz), radiation (9 kHz to the 10th harmonic of the highest fundamental frequency or to 40 GHz, whichever is lower). Pre-scanned tests, X, Y, Z in three orthogonal panels to determine the final configuration (X plane as worst plane) from all possible combinations.
- b. AC power line Conducted Emission was tested under maximum output power.

## 2.2 Test Mode

The following summary table is showing all test modes to demonstrate in compliance with the standard.

Summary table of Test Cases	
Test Item	Data Rate / Modulation
	Bluetooth 4.0 – LE / GFSK
Conducted TCs	Mode 1: Bluetooth Tx CH00_2402 MHz_1Mbps Mode 2: Bluetooth Tx CH19_2440 MHz_1Mbps Mode 3: Bluetooth Tx CH39_2480 MHz_1Mbps
Radiated TCs	Mode 1: Bluetooth Tx CH00_2402 MHz_1Mbps Mode 2: Bluetooth Tx CH19_2440 MHz_1Mbps Mode 3: Bluetooth Tx CH39_2480 MHz_1Mbps
AC Conducted Emission	Mode 1 :GPRS850 Idle + Bluetooth Link + WLAN Link + USB Cable 1 (Charging from Adapter) + Battery 1 + Earphone Mode 2 :GPRS850 Idle + Bluetooth Link + WLAN Link + USB Cable 2 (Charging from Adapter) + Battery 2 + Earphone
<b>Note:</b> The worst case of conducted emission is mode 1; only the test data of it was reported.	



## 2.3 Connection Diagram of Test System

<Bluetooth 4.0 – LE Tx Mode>

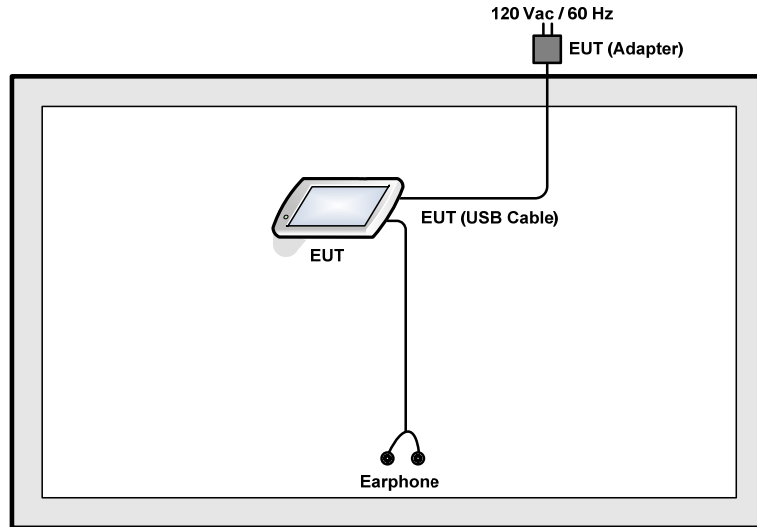

<AC Conducted Emission Mode>

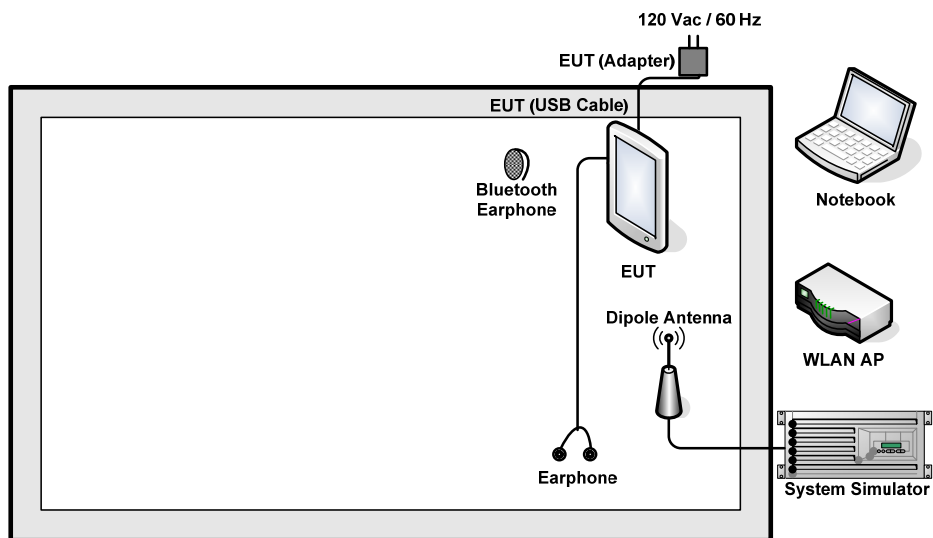

## 2.4 Support Unit used in test configuration and system

Item	Equipment	Trade Name	Model Name	FCC ID	Data Cable	Power Cord
1.	System Simulator	R&S	CMU 200	N/A	N/A	Unshielded, 1.8 m
2.	DC Power Supply	GWINSTEK	GPS-3030D	N/A	N/A	Unshielded, 1.8 m
3.	WLAN AP	D-Link	DIR-855	KA2DIR855A2	N/A	Unshielded, 1.8 m
4.	Notebook	Lenovo	G480	PPD-AR5B195	N/A	AC I/P: Unshielded, 1.8 m DC O/P: Shielded, 1.8 m
5.	Bluetooth Earphone	Lenovo	LBH301	N/A	N/A	N/A

## 2.5 Description of RF Function Operation Test Setup

For Bluetooth function, turn on “Enter Engmode” software on the EUT directly. Then, the EUT will get into the engineering modes to contact with Bluetooth base station for continuous transmitting and receiving signals.

## 2.6 Measurement Results Explanation Example

For conducted test items:

The offset level is set in the spectrum analyzer to compensate the RF cable loss and 10dB attenuator between EUT conducted output port and spectrum analyzer. With the offset compensation, the spectrum analyzer reading level is exactly the EUT RF output level.

The spectrum analyzer offset is derived from RF cable loss and 10dB attenuator factor.

*Offset = RF cable loss + attenuator factor.*

Following table shows an offset computation example with cable loss 5.60 dB.

Example :

$$\begin{aligned} \text{Offset(dB)} &= \text{RF cable loss(dB)} + \text{attenuator factor(dB)}. \\ &= 5.60 + 10 = 15.60 \text{ (dB)} \end{aligned}$$

### 3 Test Result

#### 3.1 6dB Bandwidth Measurement

##### 3.1.1 Limit of 6dB Bandwidth

The minimum 6 dB bandwidth shall be at least 500 kHz.

##### 3.1.2 Measuring Instruments

See list of measuring instruments of this test report.

##### 3.1.3 Test Procedures

1. The testing follows FCC KDB Publication No. 558074 D01 DTS Meas. Guidance v02.
2. The RF output of EUT was connected to the spectrum analyzer by RF cable and attenuator. The path loss was compensated to the results for each measurement.
3. Set to the maximum power setting and enable the EUT transmit continuously.
4. Make the measurement with the spectrum analyzer's resolution bandwidth (RBW) = 1-5% of DTS BW, not to exceed 100 kHz. Set the Video bandwidth (VBW)  $\geq 3 \times$  RBW. In order to make an accurate measurement. The 6 dB bandwidth must be greater than 500 kHz.
5. Measure and record the results in the test report.

##### 3.1.4 Test Setup

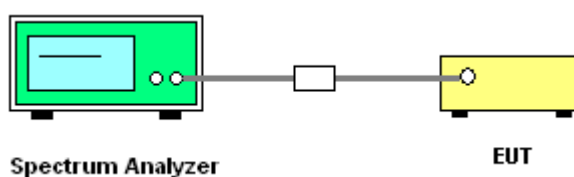

3.1.5 Test Result of 6dB Bandwidth

Test Mode :	Bluetooth 4.0 - LE	Temperature :	23~24°C
Test Engineer :	Lizy Li	Relative Humidity :	47~48%

Channel	Frequency (MHz)	6dB Bandwidth (MHz)
00	2402	0.652
19	2440	0.648
39	2480	0.628

6 dB Bandwidth Plot on Channel 00

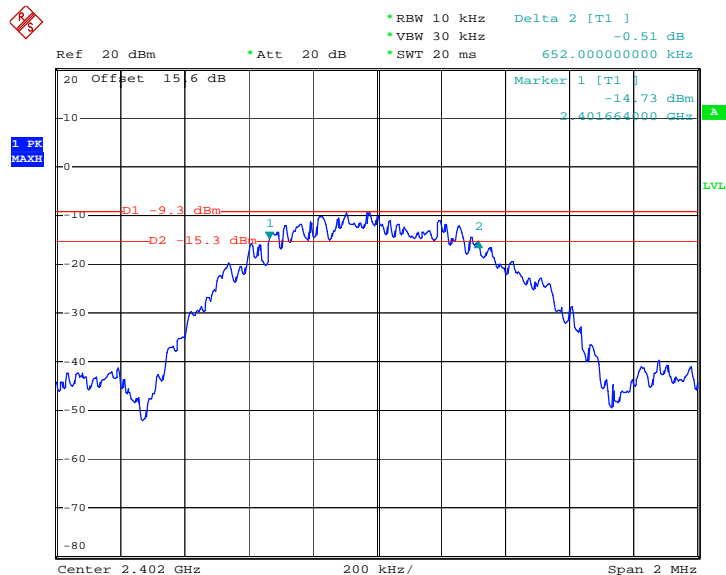

Date: 17.MAR.2013 07:16:31



6 dB Bandwidth Plot on Channel 19

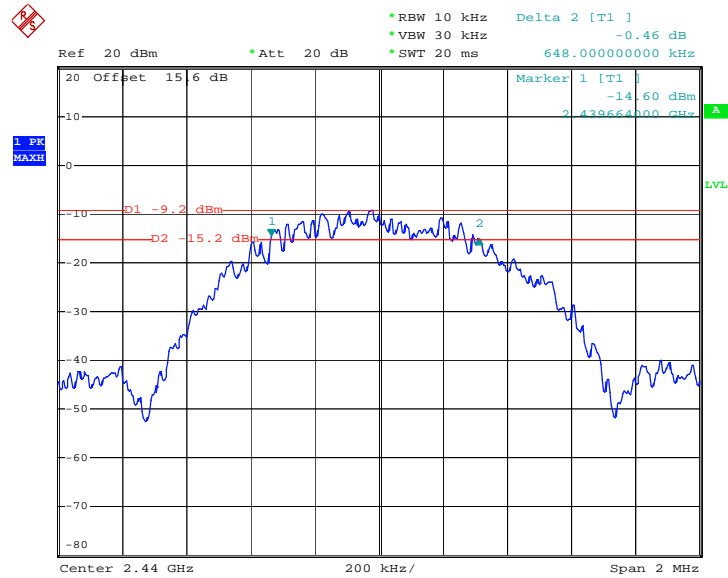

Date: 17.MAR.2013 07:17:45

6 dB Bandwidth Plot on Channel 39

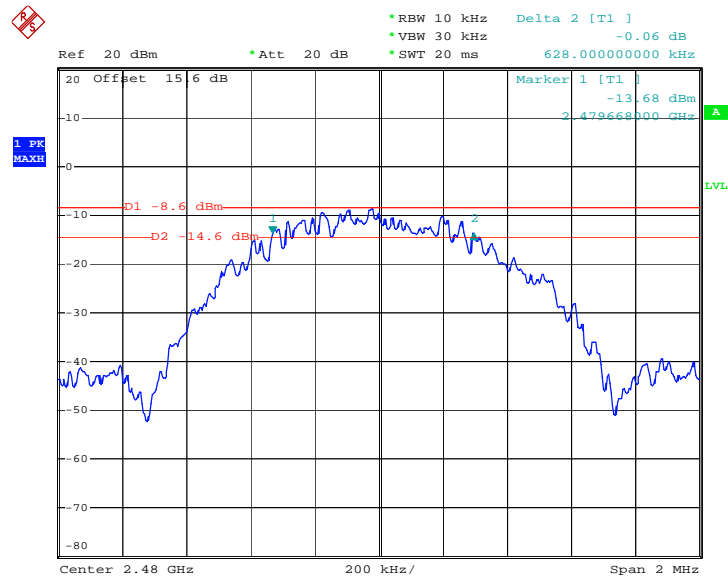

Date: 17.MAR.2013 07:18:35

## 3.2 Peak Output Power Measurement

### 3.2.1 Limit of Peak Output Power

For systems using digital modulation in the 2400-2483.5MHz, the limit for peak output power is 30dBm. If transmitting antenna of directional gain greater than 6dBi is used, the peak output power from the intentional radiator shall be reduced below the above stated value by the amount in dB that the directional gain of the antenna exceeds 6 dBi. In case of point-to-point operation, the limit has to be reduced by 1dB for every 3dB that the directional gain of the antenna exceeds 6dBi.

### 3.2.2 Measuring Instruments

See list of measuring instruments of this test report.

### 3.2.3 Test Procedures

1. The testing follows the Measurement Procedure of FCC KDB No. 558074 DTS D01 Meas. Guidance v02.
2. The RF output of EUT was connected to the spectrum analyzer by RF cable and attenuator. The path loss was compensated to the results for each measurement.
3. Set to the maximum power setting and enable the EUT transmit continuously.
4. Measure the conducted output power and record the results in the test report.

### 3.2.4 Test Setup

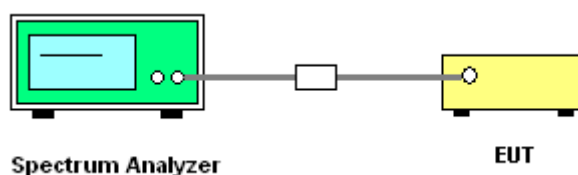



3.2.5 Test Result of Peak Output Power

Test Mode :	Bluetooth 4.0 - LE	Temperature :	23~24°C
Test Engineer :	Lizy Li	Relative Humidity :	47~48%

Channel	Frequency (MHz)	RF Power (dBm)		
		GFSK	Max. Limits (dBm)	Pass/Fail
00	2402	0.39	30.00	Pass
19	2440	0.65	30.00	Pass
39	2480	1.07	30.00	Pass

Peak Output Power Plot on Channel 00

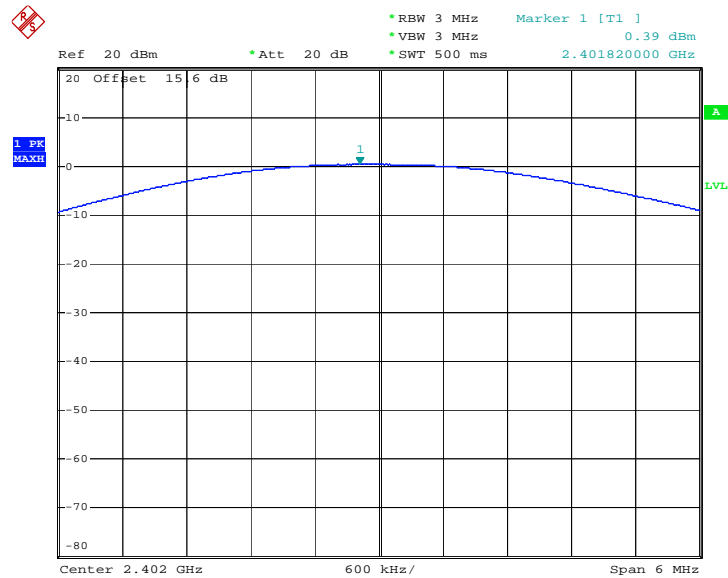

Date: 17.MAR.2013 07:28:02



Peak Output Power Plot on Channel 19

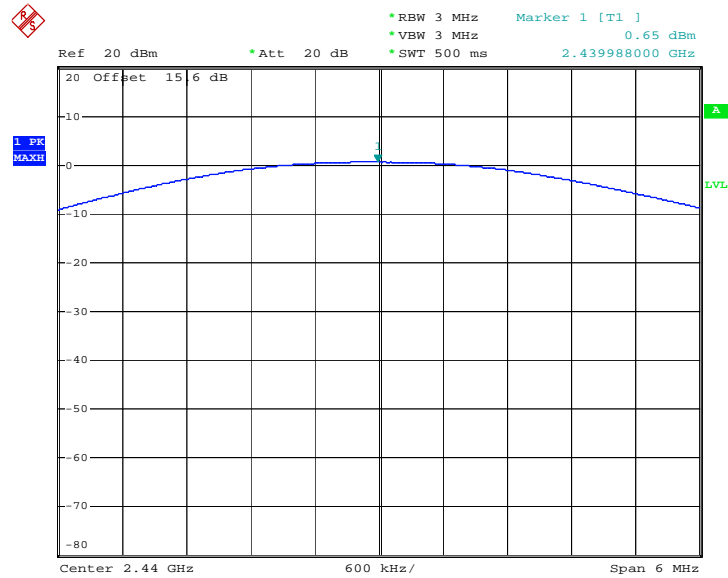

Date: 17.MAR.2013 07:45:31

Peak Output Power Plot on Channel 39

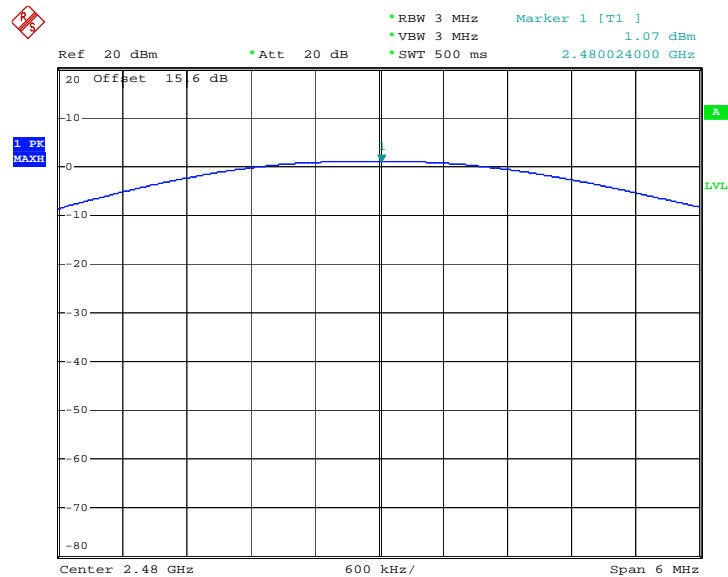

Date: 17.MAR.2013 07:27:30



### 3.3 Power Spectral Density Measurement

#### 3.3.1 Limit of Power Spectral Density

The peak power spectral density shall not be greater than 8dBm in any 3kHz band at any time interval of continuous transmission.

#### 3.3.2 Measuring Instruments

See list of measuring instruments of this test report.

#### 3.3.3 Test Procedures

1. The testing follows Measurement Procedure 9.1 Option 1 of FCC KDB Publication No. 558074 D01 DTS Meas. Guidance v02
2. The RF output of EUT was connected to the spectrum analyzer by RF cable and attenuator. The path loss was compensated to the results for each measurement.
3. Set to the maximum power setting and enable the EUT transmit continuously.
4. Make the measurement with the spectrum analyzer's resolution bandwidth (RBW) = 3 kHz. Video bandwidth VBW = 10 kHz In order to make an accurate measurement, set the span to 1.5 times DTS Channel Bandwidth. (6dB BW)
5. Detector = peak, Sweep time = auto couple, Trace mode = max hold, Allow trace to fully stabilize. Use the peak marker function to determine the maximum power level.
6. Measure and record the results in the test report.
7. The Measured power density (dBm)/ 100kHz is a reference level and used as 20dBc down limit line for Conducted Band Edges and Conducted Spurious Emission.

#### 3.3.4 Test Setup

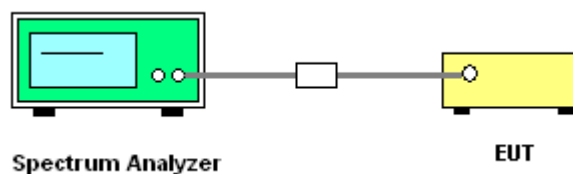

**3.3.5 Test Result of Power Spectral Density**

<b>Test Mode :</b>	Bluetooth 4.0 - LE	<b>Temperature :</b>	23~24°C
<b>Test Engineer :</b>	Lizy Li	<b>Relative Humidity :</b>	47~48%

Channel	Frequency (MHz)	Power Density		Max. Limits (dBm/3kHz)	Pass/Fail
		PSD/100kHz (dBm)	PSD/3kHz (dBm)		
00	2402	-0.09	-14.35	8	Pass
19	2440	0.07	-14.17	8	Pass
39	2480	0.61	-13.64	8	Pass

**Note:**

1. Measured power density (dBm) has offset with cable loss.
2. The Measured power density (dBm)/ 100kHz is reference level and used as 20dBc down for Conducted Band Edges and Conducted Spurious Emission limit line.

### 3.3.6 Test Result of Power Spectral Density Plots (100kHz)

PSD 100kHz Plot on Channel 00

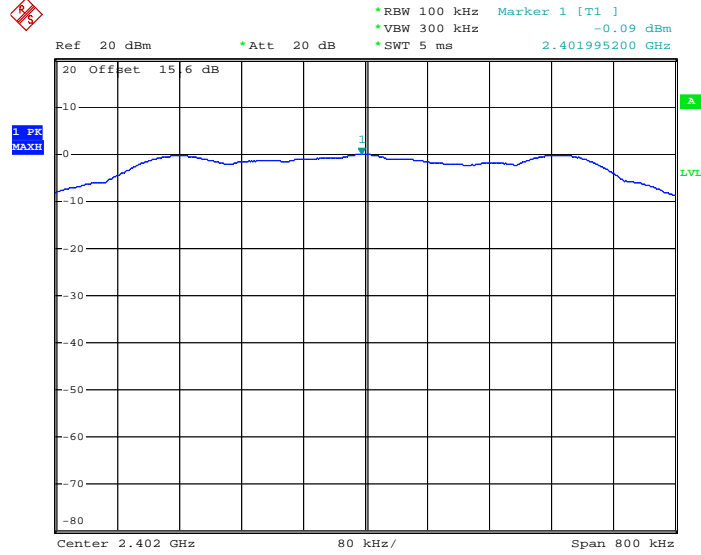

Date: 17.MAR.2013 07:22:26

PSD 100kHz Plot on Channel 19

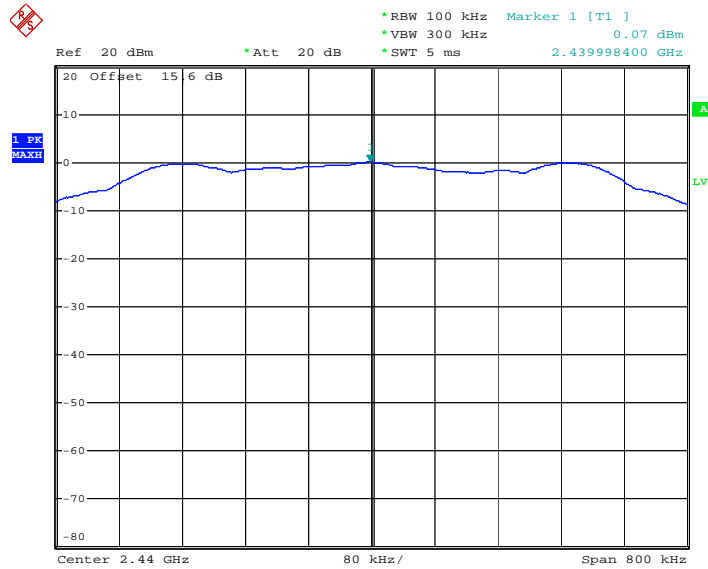

Date: 17.MAR.2013 07:22:53



PSD 100kHz Plot on Channel 39

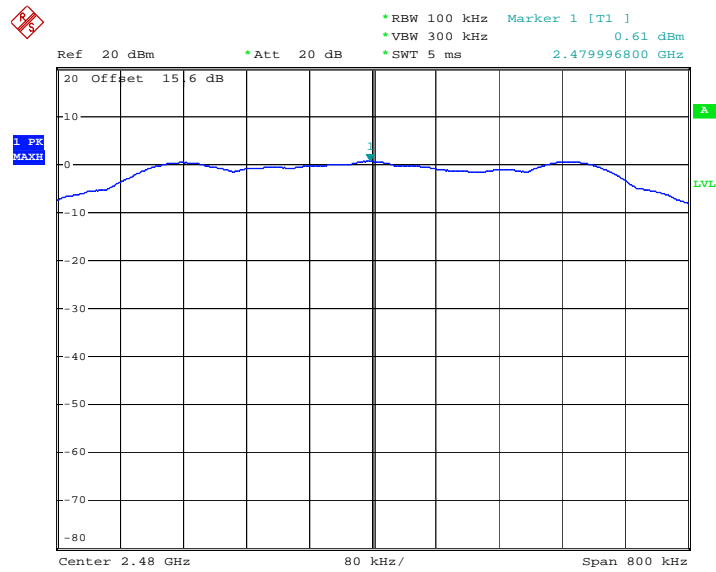

Date: 17.MAR.2013 07:23:17



### 3.3.7 Test Result of Power Spectral Density Plots (3kHz)

PSD 3kHz Plot on Channel 00

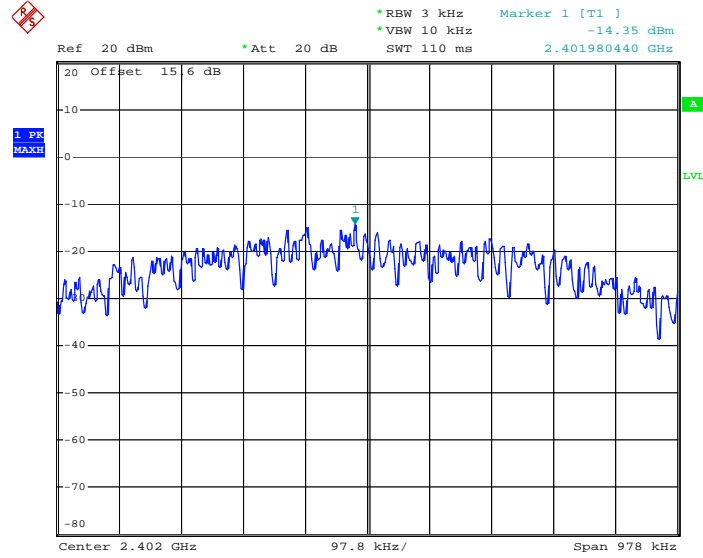

Date: 17.MAR.2013 07:28:56

PSD 3kHz Plot on Channel 19

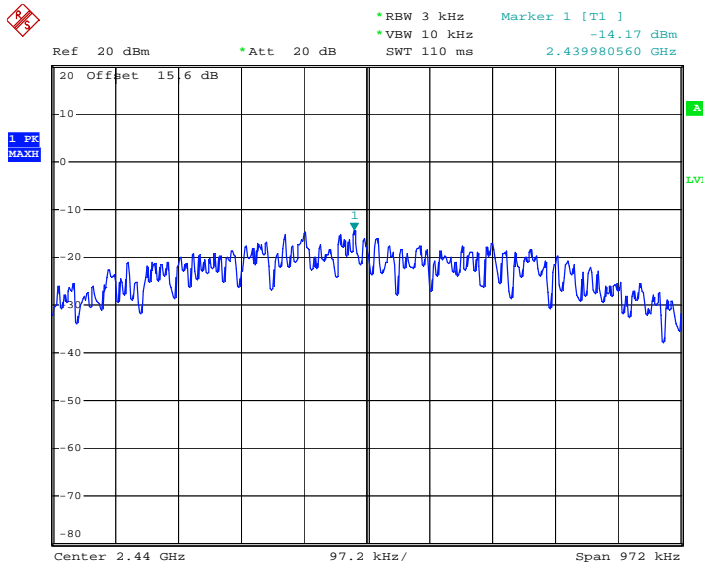

Date: 17.MAR.2013 07:29:33



PSD 3kHz Plot on Channel 39

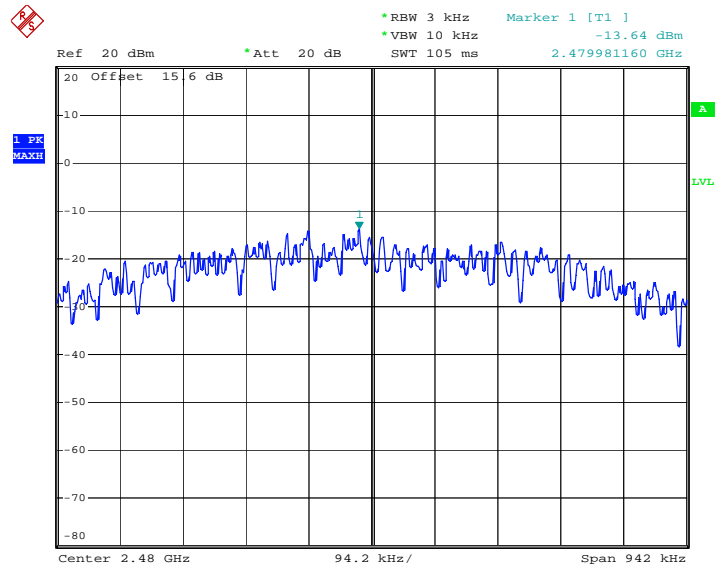

Date: 17.MAR.2013 07:30:08

### 3.4 Conducted Band Edges and Spurious Emission Measurement

#### 3.4.1 Limit of Conducted Band Edges and Spurious Emission

All harmonics/spurious must be at least 20 dB down from the highest emission level within the authorized band.

#### 3.4.2 Measuring Instruments

See list of measuring instruments of this test report.

#### 3.4.3 Test Procedure

1. The testing follows FCC KDB Publication No. 558074 D01 DTS Meas. Guidance v02.
2. The RF output of EUT was connected to the spectrum analyzer by RF cable and attenuator. The path loss was compensated to the results for each measurement.
3. Set to the maximum power setting and enable the EUT transmit continuously.
4. Set RBW = 100 kHz, VBW=300 kHz, Peak Detector. Unwanted Emissions measured in any 100 kHz bandwidth outside of the authorized frequency band shall be attenuated by at least 20 dB relative to the maximum in-band peak PSD level in 100 kHz when maximum peak conducted output power procedure is used. If the transmitter complies with the conducted power limits based on the use of RMS averaging over a time interval, the attenuation required under this paragraph shall be 30 dB instead of 20 dB per 15.247(d).
5. Measure and record the results in the test report.
6. The RF fundamental frequency should be excluded against the limit line in the operating frequency band.

#### 3.4.4 Test Setup

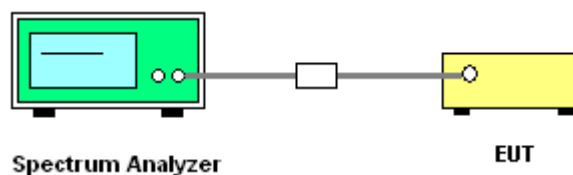

### 3.4.5 Test Result of Conducted Band Edges

Test Mode :	Bluetooth 4.0 - LE	Temperature :	23~24°C
Test Channel :	00 and 39	Relative Humidity :	47~48%
		Test Engineer :	Lizy Li

Low Band Edge Plot on Channel 00

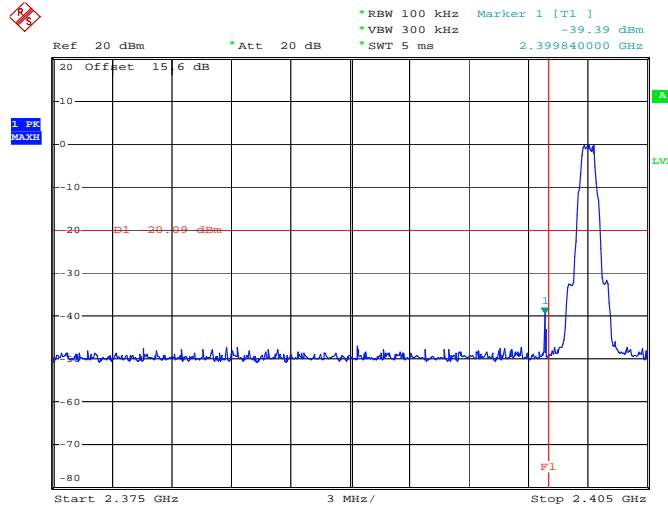

Date: 17.MAR.2013 07:32:09

High Band Edge Plot on Channel 39

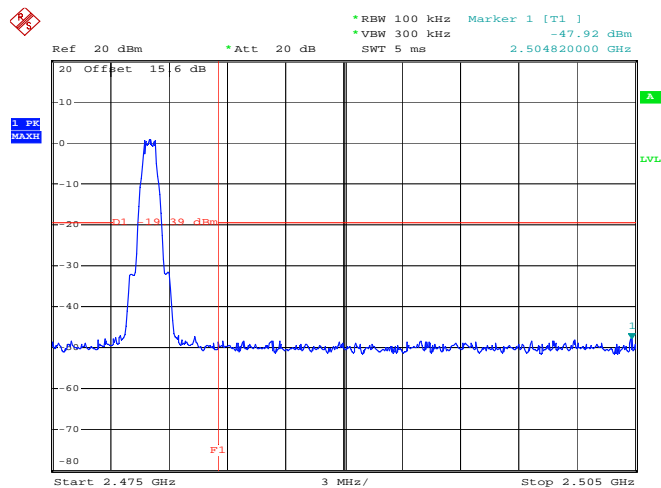

Date: 17.MAR.2013 07:42:21



### 3.4.6 Test Result of Conducted Spurious Emission

Test Mode :	Bluetooth 4.0 - LE	Temperature :	23~24°C
Test Channel :	00	Relative Humidity :	47~48%
		Test Engineer :	Lizy Li

Conducted Spurious Emission Plot on Bluetooth LE GFSK Channel 00

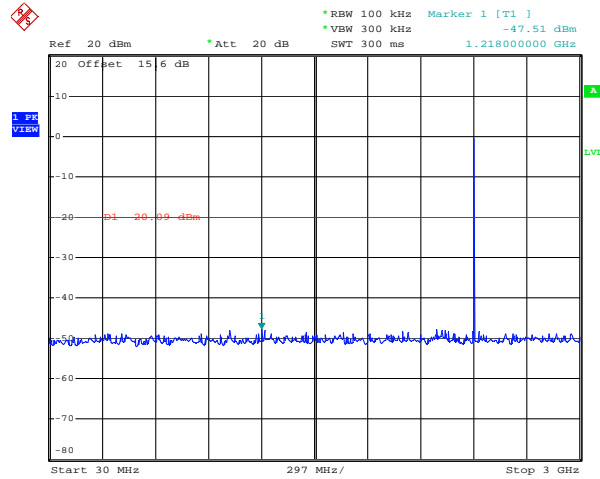

Date: 17.MAR.2013 07:39:09

Conducted Spurious Emission Plot on Bluetooth LE GFSK Channel 00

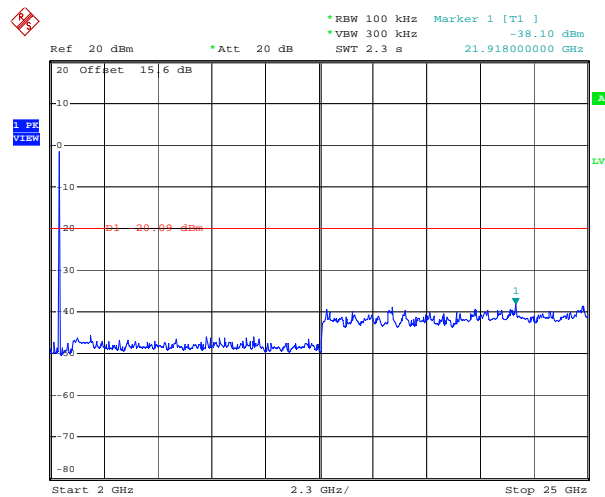

Date: 17.MAR.2013 07:39:35



Test Mode :	Bluetooth 4.0 - LE	Temperature :	23~24°C
Test Channel :	19	Relative Humidity :	47~48%
		Test Engineer :	Lizy Li

Conducted Spurious Emission Plot on Bluetooth LE GFSK Channel 19

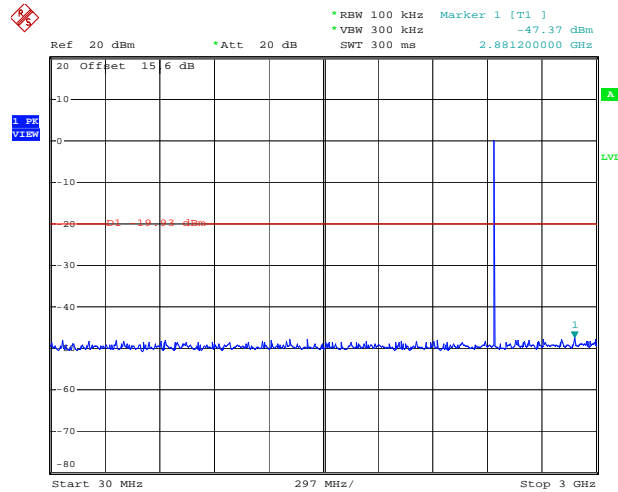

Date: 17.MAR.2013 07:40:24

Conducted Spurious Emission Plot on Bluetooth LE GFSK Channel 19

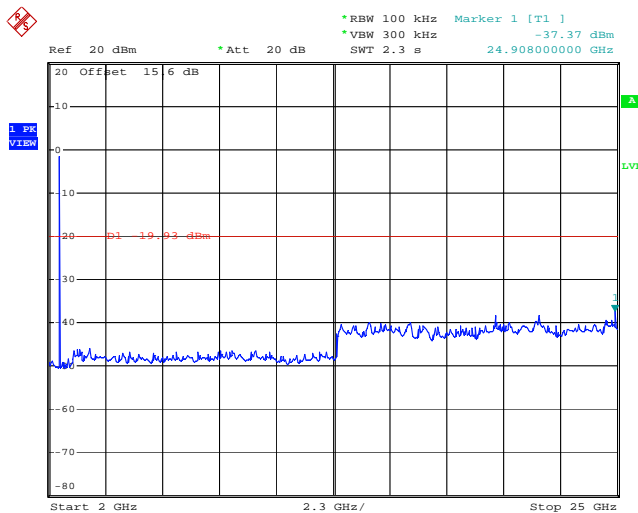

Date: 17.MAR.2013 07:40:50



Test Mode :	Bluetooth 4.0 - LE	Temperature :	23~24°C
Test Channel :	39	Relative Humidity :	47~48%
		Test Engineer :	Lizy Li

Conducted Spurious Emission Plot on Bluetooth LE GFSK Channel 39

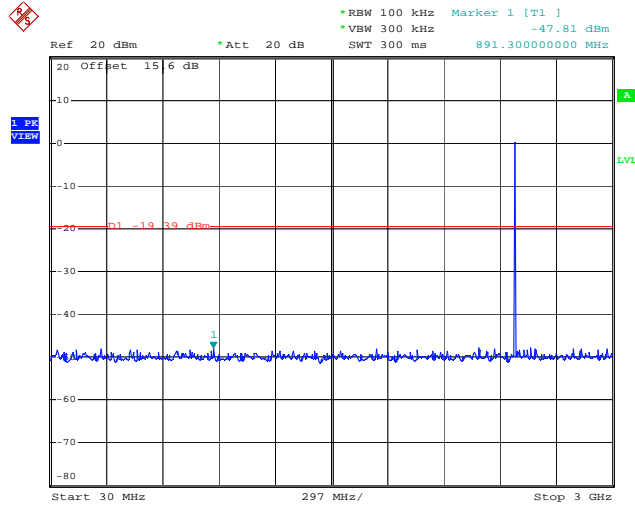

Date: 17.MAR.2013 07:37:24

Conducted Spurious Emission Plot on Bluetooth LE GFSK Channel 39

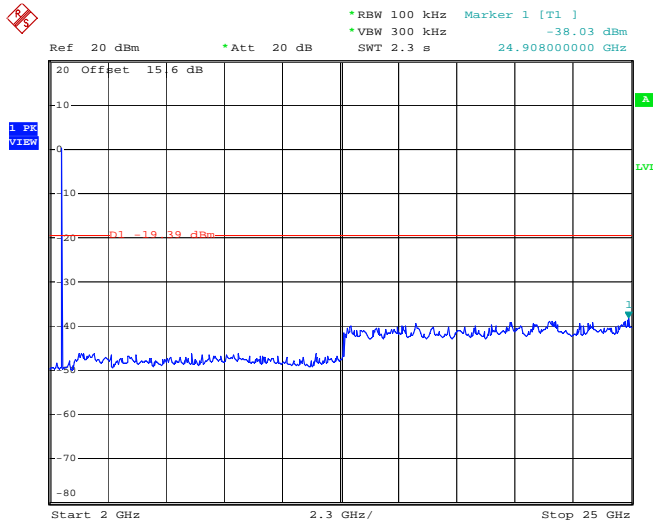

Date: 17.MAR.2013 07:36:52

### 3.5 Radiated Band Edges and Spurious Emission Measurement

#### 3.5.1 Limit of Radiated Band Edges and Spurious Emission

In any 100 kHz bandwidth outside the intentional radiator frequency band, all harmonics/spurious must be at least 20 dB below the highest emission level within the authorized band. If the output power of this device was measured by spectrum analyzer, the attenuation under this paragraph shall be 30 dB instead of 20 dB. In addition, radiated emissions which fall in the restricted bands must also comply with the FCC section 15.209 limits as below.

Frequency (MHz)	Field Strength (microvolts/meter)	Measurement Distance (meters)
0.009 – 0.490	2400/F(kHz)	300
0.490 – 1.705	24000/F(kHz)	30
1.705 – 30.0	30	30
30 – 88	100	3
88 – 216	150	3
216 - 960	200	3
Above 960	500	3

#### 3.5.2 Measuring Instruments

See list of measuring instruments of this test report.

**3.5.3 Test Procedures**

1. The testing follows the guidelines in ANSI C63.10-2009 and ANSI C63.4-2003 test site requirement.
2. The EUT was arranged to its worst case and then tune the antenna tower (from 1 m to 4 m) and turntable (from 0 degree to 360 degrees) to find the maximum reading. A pre-amp and a high pass filter are used for the test in order to get better signal level.
3. The EUT was placed on a turntable with 0.8 meter above ground.
4. The EUT was set 3 meters from the interference receiving antenna, which was mounted on the top of a variable height antenna tower.
5. Corrected Reading: Antenna Factor + Cable Loss + Read Level - Preamp Factor = Level
6. For measurement below 1GHz, If the emission level of the EUT measured by the peak detector is 3 dB lower than the applicable limit, the peak emission level will be reported. Otherwise, the emission measurement will be repeated using the quasi-peak detector and reported.
7. Use the following spectrum analyzer settings:
  - (1) Span shall wide enough to fully capture the emission being measured;
  - (2) Set RBW=100 kHz for  $f < 1$  GHz;  $VBW \geq RBW$ ; Sweep = auto; Detector function = peak; Trace = max hold;
  - (3) Set RBW = 1 MHz, VBW= 3MHz for  $f \geq 1$  GHz for peak measurement.  
 For average measurement:
    - $VBW = 10$  Hz, when duty cycle is no less than 98 percent.
    - $VBW \geq 1/T$ , when duty cycle is less than 98 percent where T is the minimum transmission duration over which the transmitter is on and is transmitting at its maximum power control level for the tested mode of operation.

Band	Duty Cycle(%)	T(ms)	1/T(kHz)	VBW Setting
Bluetooth 4.0 - LE	65.605	0.412	2.427	3kHz

**Note:** For average measurement with duty cycle < 98%, use reduced VBW measurement method 4.2.3.2.3 in ANSI C63.10.



**Marker-Delta method :**

- (1) Set RBW = 1 MHz, VBW = 3 MHz, peak detector.

Repeat the measurement with an average detector, use RBW = 1MHz

VBW = 10 Hz, when duty cycle is no less than 98 percent.

VBW  $\geq$  1/T, when duty cycle is less than 98 percent

- (2) Set span = 10MHz, that encompasses both the peak of the fundamental emission and the band-edge emission under investigation. Set RBW = 100kHz, 1% of the total span. Set VBW = 100kHz  $\geq$  RBW.

- (3) Subtract the delta measured in step (2) from the field strengths measured in step (1).

The resultant field strengths (peak/average) are then used to determine band-edge compliance as required by Section 15.205.

### 3.5.4 Test Setup

For radiated emissions below 30MHz

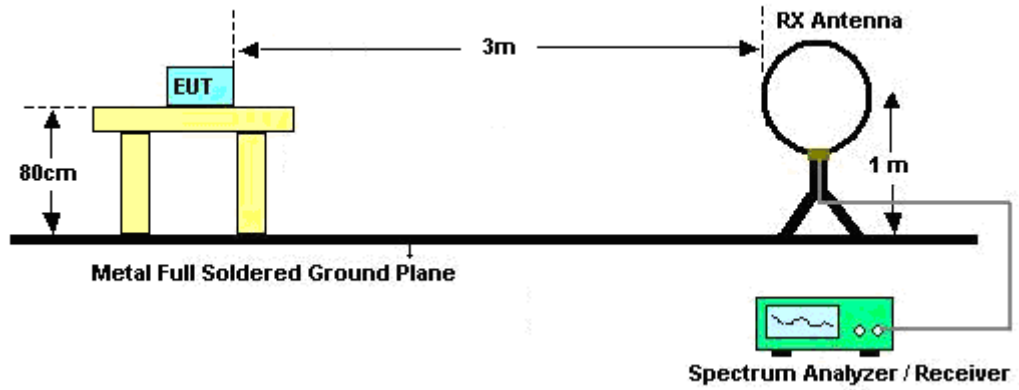

For radiated emissions from 30MHz to 1GHz

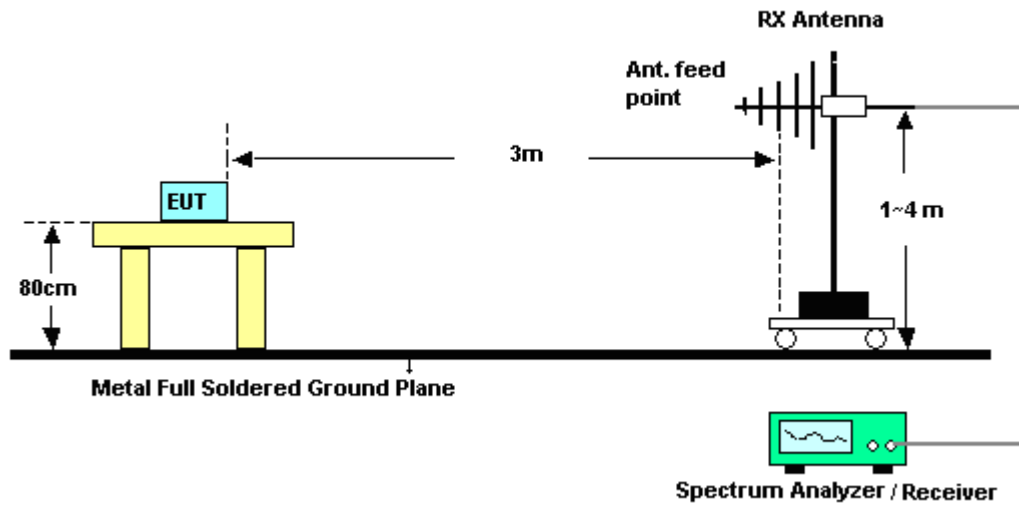

For radiated emissions above 1GHz

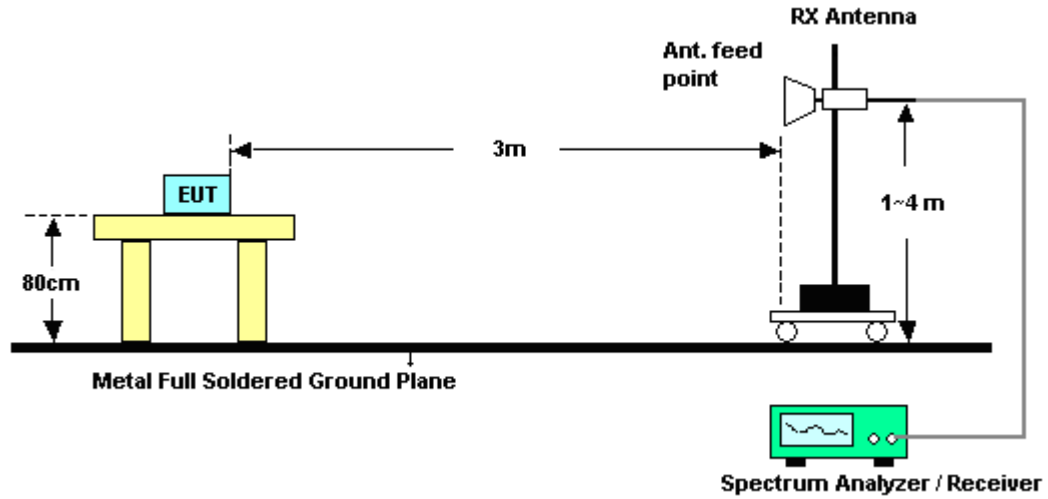

### 3.5.5 Test Results of Radiated Emissions (9 kHz ~ 30 MHz)

The low frequency, which started from 9 kHz to 30MHz, was pre-scanned and the result which was 20dB lower than the limit line per 15.31(o) was not reported.





3.5.6 Test Result of Radiated Band Edges

Test Mode :	Mode 1 + USB Cable 1 (Charging from Adapter) + Battery 1 + Earphone	Temperature :	21~23°C
Test Channel :	00	Relative Humidity :	51~53%
		Test Engineer :	Beer Huang

ANTENNA POLARITY : HORIZONTAL										
Frequency ( MHz )	Level ( dBμV /m )	Over Limit ( dB )	Limit Line ( dBμV /m )	Read Level ( dBμV )	Antenna Factor ( dB )	Cable Loss ( dB )	Preamp Factor ( dB )	Ant Pos ( cm )	Table Pos ( deg )	Remark
2386.14	49.92	-24.08	74	44.98	32.3	6.91	34.27	129	357	Peak
2385.87	38.86	-15.14	54	33.92	32.3	6.91	34.27	129	357	Average

ANTENNA POLARITY : VERTICAL										
Frequency ( MHz )	Level ( dBμV /m )	Over Limit ( dB )	Limit Line ( dBμV /m )	Read Level ( dBμV )	Antenna Factor ( dB )	Cable Loss ( dB )	Preamp Factor ( dB )	Ant Pos ( cm )	Table Pos ( deg )	Remark
2385.87	47.07	-26.93	74	42.13	32.3	6.91	34.27	166	269	Peak
2386.14	37.95	-16.05	54	33.01	32.3	6.91	34.27	166	269	Average



Test Mode :	Mode 3 + USB Cable 1 (Charging from Adapter) + Battery 1 + Earphone	Temperature :	21~23°C
Test Channel :	39	Relative Humidity :	51~53%
		Test Engineer :	Beer Huang

ANTENNA POLARITY : HORIZONTAL										
Frequency ( MHz )	Level ( dBμV /m )	Over Limit ( dB )	Limit Line ( dBμV /m )	Read Level ( dBμV )	Antenna Factor ( dB )	Cable Loss ( dB )	Preamp Factor ( dB )	Ant Pos ( cm )	Table Pos ( deg )	Remark
2483.5	64.67	-9.33	74	59.66	32.38	7.06	34.43	101	359	Peak
2483.5	61.75	7.75	54	56.74	32.38	7.06	34.43	101	359	Average
2483.5	45.76	-28.24	74	-	-	-	-	-	-	Peak
2483.5	44.94	-9.06	54	-	-	-	-	-	-	Average

Summary results of marker-delta method:

Test mode	Maximum field strength of the fundamental emission (dBμV/m)	Delta Result (dB)	Measurement Result (dBμV/m)	Limit (dBμV/m)	Margin (dB)	Result
Peak	102.51	56.75	45.76	74	-28.24	Pass
Average	101.69	56.75	44.94	54	-9.06	Pass

Note: Measurement result = Maximum field strength – Delta result

ANTENNA POLARITY : VERTICAL										
Frequency ( MHz )	Level ( dBμV /m )	Over Limit ( dB )	Limit Line ( dBμV /m )	Read Level ( dBμV )	Antenna Factor ( dB )	Cable Loss ( dB )	Preamp Factor ( dB )	Ant Pos ( cm )	Table Pos ( deg )	Remark
2483.5	58.11	-15.89	74	53.1	32.38	7.06	34.43	159	290	Peak
2483.5	54.86	0.86	54	49.85	32.38	7.06	34.43	159	290	Average
2483.5	44.18	-29.82	74	-	-	-	-	-	-	Peak
2483.5	43.32	-10.68	54	-	-	-	-	-	-	Average

Summary results of marker-delta method:

Test mode	Maximum field strength of the fundamental emission (dBμV/m)	Delta Result (dB)	Measurement Result (dBμV/m)	Limit (dBμV/m)	Margin (dB)	Result
Peak	95.58	51.4	44.18	74	-29.82	Pass
Average	94.72	51.4	43.32	54	-10.68	Pass

Note: Measurement result = Maximum field strength – Delta result



Test Mode :	Mode 3 + USB Cable 1 (Charging from Adapter) + Battery 1 + Earphone	Temperature :	21~23°C
Test Channel :	39	Relative Humidity :	51~53%
Test Engineer :	Beer Huang	Polarization :	Horizontal

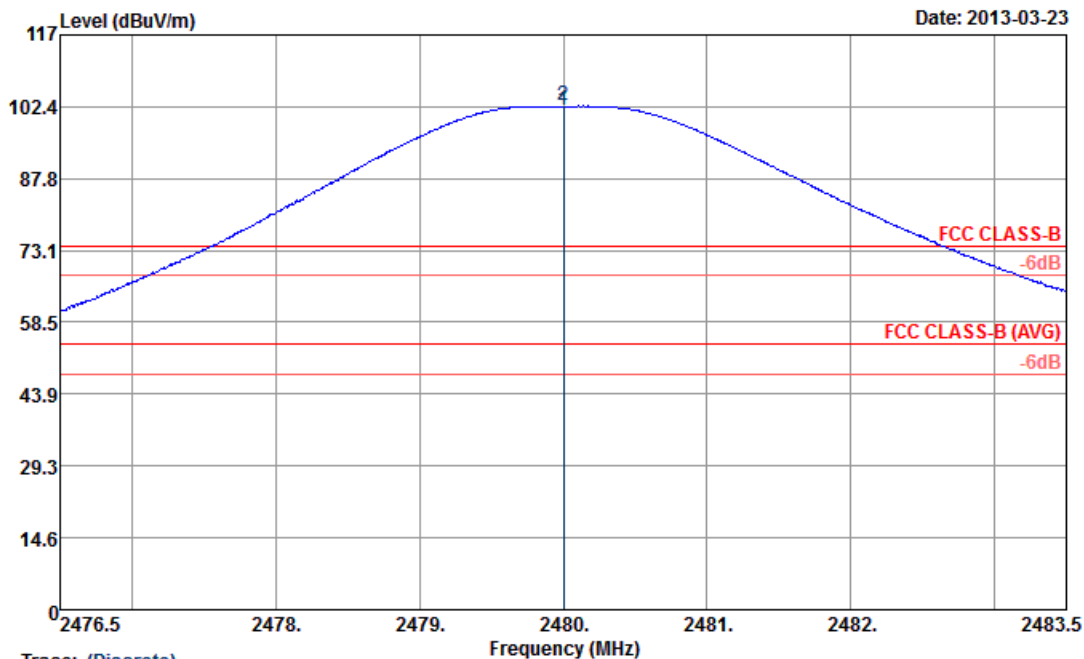

Trace: (Discrete)  
 Site : 03CH07-HY  
 Condition : FCC CLASS-B 3m HF-ANT\_120823 HORIZONTAL

	Freq	Level	Over Limit	Limit Line	ReadAntenna Level	Antenna Factor	Cable Loss	Preamp Factor	A/Pos	T/Pos	Remark
	MHz	dBuV/m	dB	dBuV/m	dBuV	dB/m	dB	dB	cm	deg	
1 *	2480.00	101.69	47.69	54.00	96.68	32.38	7.06	34.43	101	359	Average
2 *	2480.00	102.51	28.51	74.00	97.50	32.38	7.06	34.43	101	359	Peak

\* Maximum field strength of the fundamental emission



Test Mode :	Mode 3 + USB Cable 1 (Charging from Adapter) + Battery 1 + Earphone	Temperature :	21~23°C
Test Channel :	39	Relative Humidity :	51~53%
Test Engineer :	Beer Huang	Polarization :	Horizontal

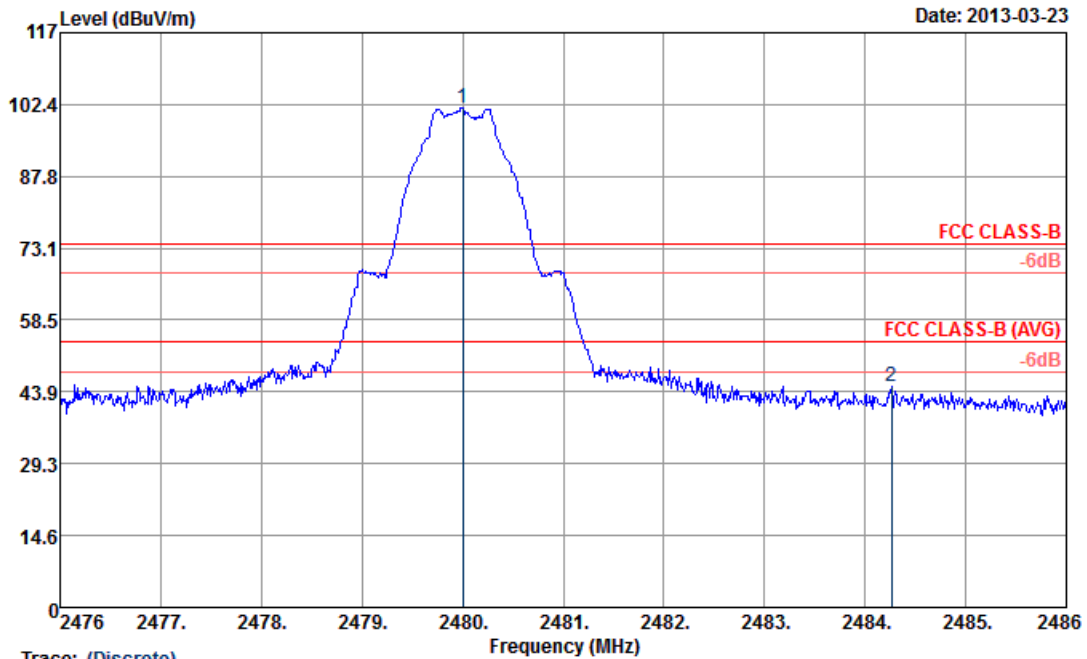

Trace: (Discrete)  
 Site : 03CH07-HY  
 Condition : FCC CLASS-B 3m HF-ANT\_120823 HORIZONTAL

	Freq	Level	Over Limit	Limit Line	ReadAntenna Level	Antenna Factor	Cable Loss	Preamplifier	A/Pos	T/Pos	Remark
	MHz	dBuV/m	dB	dBuV/m	dBuV	dB/m	dB	dB	cm	deg	
1 *	2480.00	101.71	27.71	74.00	96.70	32.38	7.06	34.43	101	359	Peak
2	2484.26	44.96	-29.04	74.00	39.95	32.38	7.06	34.43	101	359	Peak

\* Marker-Delta Method (RBW/VBW=100kHz): 56.75 dB , single carrier Mode



Test Mode :	Mode 3 + USB Cable 1 (Charging from Adapter) + Battery 1 + Earphone	Temperature :	21~23°C
Test Channel :	39	Relative Humidity :	51~53%
Test Engineer :	Beer Huang	Polarization :	Vertical

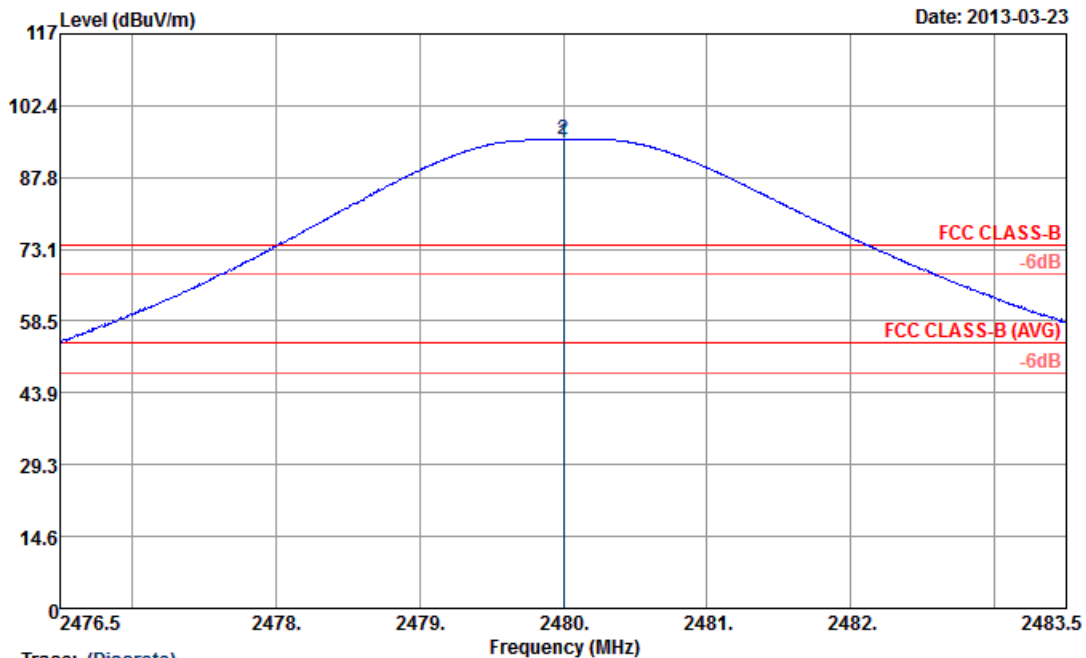

Trace: (Discrete)  
 Site : 03CH07-HY  
 Condition : FCC CLASS-B 3m HF-ANT\_120823 VERTICAL

	Freq	Level	Over	Limit	Read	Antenna	Cable	Preamp	A/Pos	T/Pos	Remark
	MHz	dBuV/m	dB	dBuV/m	dBuV	dB/m	dB	dB	cm	deg	
1 *	2480.00	94.72	40.72	54.00	89.71	32.38	7.06	34.43	159	290	Average
2 *	2480.00	95.58	21.58	74.00	90.57	32.38	7.06	34.43	159	290	Peak

\* Maximum field strength of the fundamental emission



Test Mode :	Mode 3 + USB Cable 1 (Charging from Adapter) + Battery 1 + Earphone	Temperature :	21~23°C
Test Channel :	39	Relative Humidity :	51~53%
Test Engineer :	Beer Huang	Polarization :	Vertical

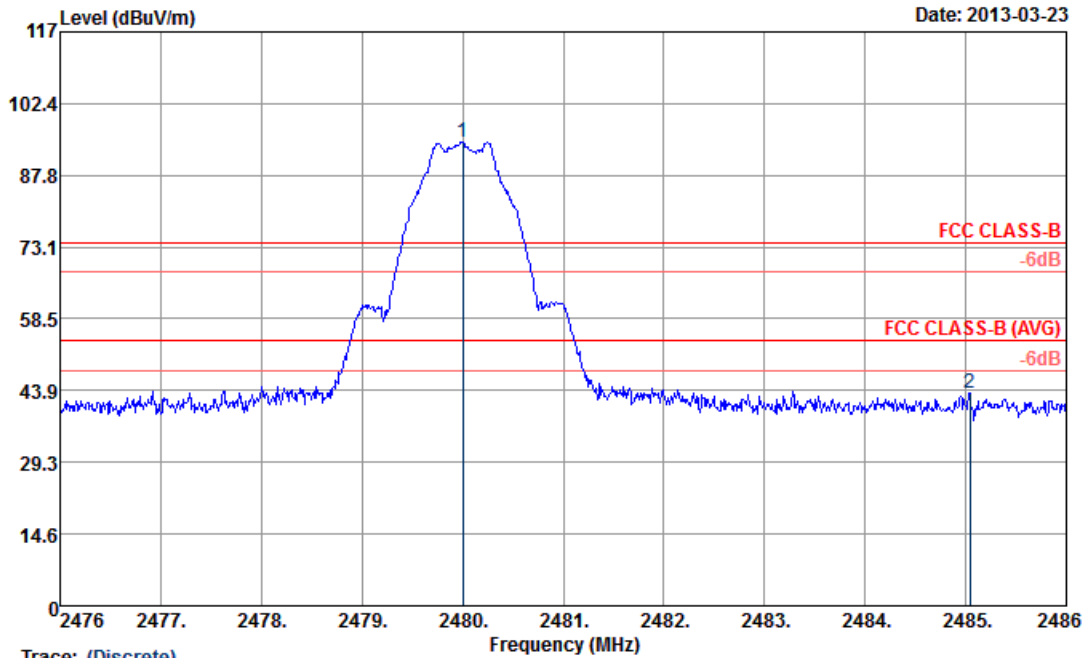

Trace: (Discrete)  
 Site : 03CH07-HY  
 Condition : FCC CLASS-B 3m HF-ANT\_120823 VERTICAL

	Freq	Level	Over Limit	Limit Line	ReadAntenna Level	Antenna Factor	Cable Loss	Preamp Factor	A/Pos	T/Pos	Remark
	MHz	dBuV/m	dB	dBuV/m	dBuV	dB/m	dB	dB	cm	deg	
1 *	2480.00	94.66	20.66	74.00	89.65	32.38	7.06	34.43	159	290	Peak
2	2485.04	43.26	-30.74	74.00	38.25	32.38	7.06	34.43	159	290	Peak

\* Marker-Delta Method (RBW/VBW=100kHz): 51.4 dB , single carrier Mode

**3.5.7 Test Result of Radiated Emission (30 MHz ~ 10<sup>th</sup> Harmonic)**

NOTE: Below 1GHz for radiated emission measurement, pre-scanned all test modes and only choose the worst case mode was recorded in the report.

<b>Test Mode :</b>	Mode 1 + USB Cable 1 (Charging from Adapter) + Battery 1 + Earphone	<b>Temperature :</b>	21~23°C
<b>Test Channel :</b>	00	<b>Relative Humidity :</b>	51~53%
<b>Test Engineer :</b>	Beer Huang	<b>Polarization :</b>	Horizontal
<b>Remark :</b>	1. 2402 MHz is fundamental signal which can be ignored. 2. 7206 MHz is not within a restricted band, and its limit line is 20dB below the highest emission level. For example, 100.64 dBµV/m - 20dB = 80.64dBµV/m. 3. Average measurement was not performed if peak level went lower than the average limit.		

Frequency ( MHz )	Level ( dBµV/m )	Over Limit ( dB )	Limit Line ( dBµV/m )	Read Level (dBµV)	Antenna Factor ( dB )	Cable Loss ( dB )	Preamp Factor ( dB )	Ant Pos ( cm )	Table Pos ( deg )	Remark
2402	99.77	-	-	94.86	32.3	6.91	34.3	129	357	Average
2402	100.64	-	-	95.72	32.31	6.91	34.3	129	357	Peak
4803	42.34	-31.66	74	57.08	33.98	8.75	57.47	100	0	Peak
7206	43.39	-37.25	80.64	54.98	35.56	10.81	57.96	100	0	Peak



<b>Test Mode :</b>	Mode 1 + USB Cable 1 (Charging from Adapter) + Battery 1 + Earphone	<b>Temperature :</b>	21~23°C
<b>Test Channel :</b>	00	<b>Relative Humidity :</b>	51~53%
<b>Test Engineer :</b>	Beer Huang	<b>Polarization :</b>	Vertical
<b>Remark :</b>	1. 2402 MHz is fundamental signal which can be ignored. 2. 7206 MHz is not within a restricted band, and its limit line is 20dB below the highest emission level. 3. Average measurement was not performed if peak level went lower than the average limit.		

Frequency ( MHz )	Level ( dBμV/m )	Over Limit ( dB )	Limit Line ( dBμV/m )	Read Level (dBμV)	Antenna Factor ( dB )	Cable Loss ( dB )	Preamp Factor ( dB )	Ant Pos ( cm )	Table Pos ( deg )	Remark
2402	96.83	-	-	91.92	32.3	6.91	34.3	166	269	Average
2402	97.72	-	-	92.81	32.3	6.91	34.3	166	269	Peak
4803	43.85	-30.15	74	58.59	33.98	8.75	57.47	100	0	Peak
7206	42.02	-35.7	77.72	53.61	35.56	10.81	57.96	100	0	Peak





<b>Test Mode :</b>	Mode 2 + USB Cable 1 (Charging from Adapter) + Battery 1 + Earphone	<b>Temperature :</b>	21~23°C
<b>Test Channel :</b>	19	<b>Relative Humidity :</b>	51~53%
<b>Test Engineer :</b>	Beer Huang	<b>Polarization :</b>	Horizontal
<b>Remark :</b>	1. 2440 MHz is fundamental signal which can be ignored. 2. Average measurement was not performed if peak level went lower than the average limit.		

Frequency ( MHz )	Level ( dBμV/m )	Over Limit ( dB )	Limit Line ( dBμV/m )	Read Level (dBμV)	Antenna Factor ( dB )	Cable Loss ( dB )	Preamp Factor ( dB )	Ant Pos ( cm )	Table Pos ( deg )	Remark
2440	99.05	-	-	94.06	32.35	6.99	34.35	130	11	Average
2440	99.92	-	-	94.93	32.35	6.99	34.35	130	11	Peak
4881	42.05	-31.95	74	56.73	33.95	8.85	57.48	100	0	Peak
7320	41.42	-32.58	74	53.02	35.53	10.91	58.04	100	0	Peak

<b>Test Mode :</b>	Mode 2 + USB Cable 1 (Charging from Adapter) + Battery 1 + Earphone	<b>Temperature :</b>	21~23°C
<b>Test Channel :</b>	19	<b>Relative Humidity :</b>	51~53%
<b>Test Engineer :</b>	Beer Huang	<b>Polarization :</b>	Vertical
<b>Remark :</b>	1. 2440 MHz is fundamental signal which can be ignored. 2. Average measurement was not performed if peak level went lower than the average limit.		

Frequency ( MHz )	Level ( dBμV/m )	Over Limit ( dB )	Limit Line ( dBμV/m )	Read Level (dBμV)	Antenna Factor ( dB )	Cable Loss ( dB )	Preamp Factor ( dB )	Ant Pos ( cm )	Table Pos ( deg )	Remark
2440	95.86	-	-	90.87	32.35	6.99	34.35	192	271	Average
2440	96.7	-	-	91.71	32.35	6.99	34.35	192	271	Peak
4881	42.14	-31.86	74	56.82	33.95	8.85	57.48	100	0	Peak
7320	41.96	-32.04	74	53.56	35.53	10.91	58.04	100	0	Peak



<b>Test Mode :</b>	Mode 3 + USB Cable 1 (Charging from Adapter) + Battery 1 + Earphone	<b>Temperature :</b>	21~23°C
<b>Test Channel :</b>	39	<b>Relative Humidity :</b>	51~53%
<b>Test Engineer :</b>	Beer Huang	<b>Polarization :</b>	Horizontal
<b>Remark :</b>	1. 2480 MHz is fundamental signal which can be ignored. 2. Average measurement was not performed if peak level went lower than the average limit.		

Frequency ( MHz )	Level ( dBμV/m )	Over Limit ( dB )	Limit Line ( dBμV/m )	Read Level ( dBμV )	Antenna Factor ( dB )	Cable Loss ( dB )	Preamp Factor ( dB )	Ant Pos ( cm )	Table Pos ( deg )	Remark
42.96	20.89	-19.11	40	40.3	11.7	0.64	31.75	-	-	Peak
194.97	21.89	-21.61	43.5	42.85	9.05	1.3	31.31	-	-	Peak
260.04	19	-27	46	35.93	12.74	1.59	31.26	-	-	Peak
389.6	20.76	-25.24	46	34.31	15.74	2.12	31.41	-	-	Peak
519.8	28.95	-17.05	46	39.07	18.43	2.49	31.04	-	-	Peak
780.2	32.96	-13.04	46	38.37	21.79	3.11	30.31	138	20	Peak
2480	101.69	-	-	96.68	32.38	7.06	34.43	101	359	Average
2480	102.33	-	-	97.32	32.38	7.06	34.43	101	359	Peak
4959	41.7	-32.3	74	56.36	33.91	8.92	57.49	100	0	Peak
7440	41.61	-32.39	74	53.18	35.51	11.04	58.12	100	0	Peak



<b>Test Mode :</b>	Mode 3 + USB Cable 1 (Charging from Adapter) + Battery 1 + Earphone	<b>Temperature :</b>	21~23°C
<b>Test Channel :</b>	39	<b>Relative Humidity :</b>	51~53%
<b>Test Engineer :</b>	Beer Huang	<b>Polarization :</b>	Vertical
<b>Remark :</b>	1. 2480 MHz is fundamental signal which can be ignored. 2. Average measurement was not performed if peak level went lower than the average limit.		

Frequency ( MHz )	Level ( dBμV/m )	Over Limit ( dB )	Limit Line ( dBμV/m )	Read Level ( dBμV )	Antenna Factor ( dB )	Cable Loss ( dB )	Preamp Factor ( dB )	Ant Pos ( cm )	Table Pos ( deg )	Remark
39.72	17.05	-22.95	40	34.72	13.5	0.62	31.79	-	-	Peak
93.18	13.59	-29.91	43.5	35.33	8.96	0.96	31.66	-	-	Peak
176.61	19.63	-23.87	43.5	40.57	9.03	1.24	31.21	-	-	Peak
388.2	15.54	-30.46	46	29.12	15.69	2.12	31.39	-	-	Peak
598.2	19.48	-26.52	46	27.6	19.77	2.68	30.57	-	-	Peak
853.7	23.88	-22.12	46	28.53	22.63	3.28	30.56	109	34	Peak
2480	94.7	-	-	89.69	32.38	7.06	34.43	159	290	Average
2480	95.46	-	-	90.45	32.38	7.06	34.43	159	290	Peak
4959	41.95	-32.05	74	56.61	33.91	8.92	57.49	100	0	Peak
7440	41.97	-32.03	74	53.54	35.51	11.04	58.12	100	0	Peak

### 3.6 AC Conducted Emission Measurement

#### 3.6.1 Limit of AC Conducted Emission

For equipment that is designed to be connected to the public utility (AC) power line, the radio frequency voltage that is conducted back onto the AC power line on any frequency or frequencies within the band 150 kHz to 30 MHz shall not exceed the limits in the following table.

Frequency of emission (MHz)	Conducted limit (dB $\mu$ V)	
	Quasi-peak	Average
0.15-0.5	66 to 56*	56 to 46*
0.5-5	56	46
5-30	60	50

\*Decreases with the logarithm of the frequency.

#### 3.6.2 Measuring Instruments

See list of measuring instruments of this test report.

#### 3.6.3 Test Procedures

1. The testing follows the guidelines in ANSI C63.10-2009 and ANSI C63.4-2003 test site requirement.
2. The EUT was placed 0.4 meter from the conducting wall of the shielding room was kept at least 80 centimeters from any other grounded conducting surface.
3. Connect EUT to the power mains through a line impedance stabilization network (LISN).
4. All the support units are connecting to the other LISN.
5. The LISN provides 50 ohm coupling impedance for the measuring instrument.
6. The FCC states that a 50 ohm, 50 microhenry LISN should be used.
7. Both sides of AC line were checked for maximum conducted interference.
8. The frequency range from 150 kHz to 30 MHz was searched.
9. Set the test-receiver system to Peak Detect Function and specified bandwidth with Maximum Hold Mode.

### 3.6.4 Test Setup

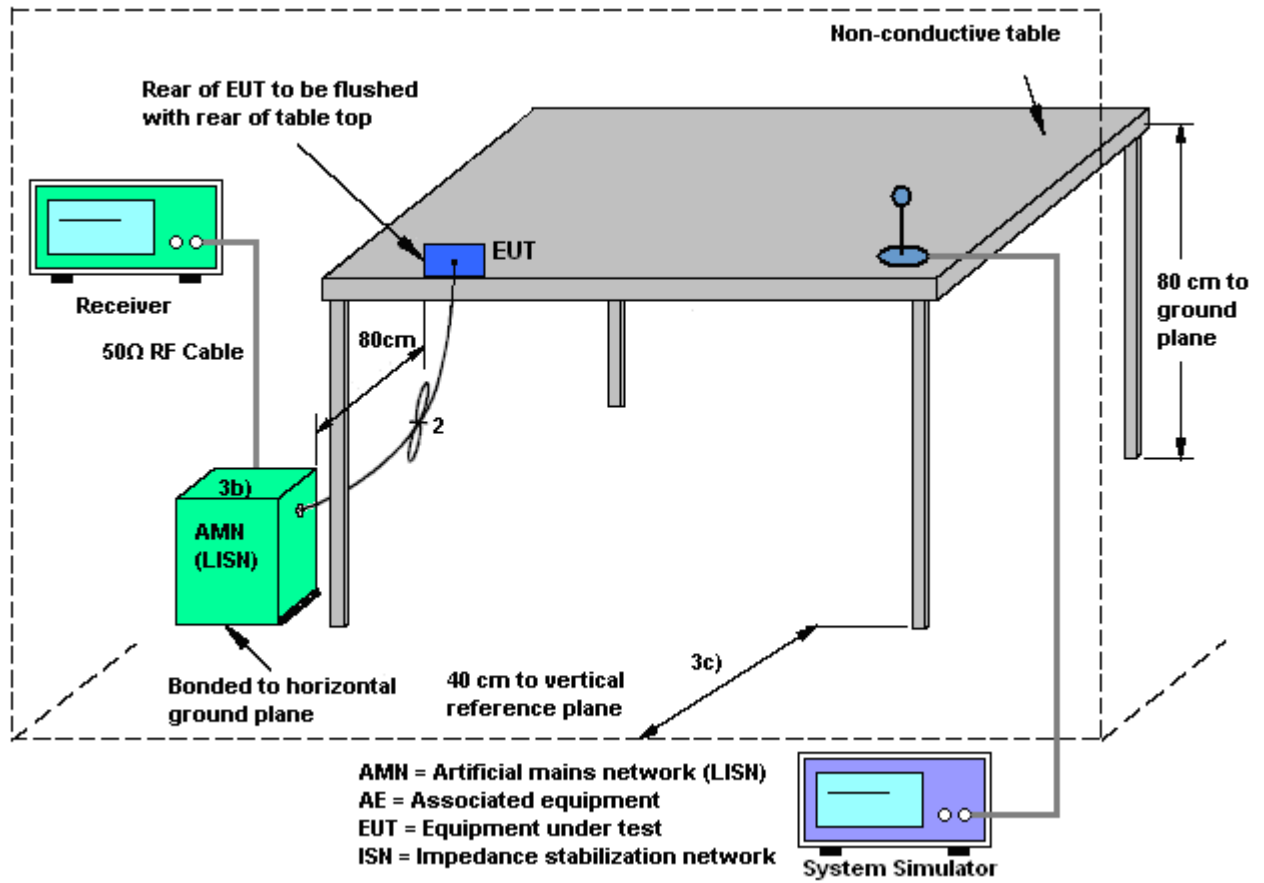



3.6.5 Test Result of AC Conducted Emission

Test Mode :	Mode 1	Temperature :	19~20°C
Test Engineer :	Tom Wang	Relative Humidity :	39~40%
Test Voltage :	120Vac / 60Hz	Phase :	Line
Function Type :	GPRS850 Idle + Bluetooth Link + WLAN Link + USB Cable 1 (Charging from Adapter) + Battery 1 + Earphone		

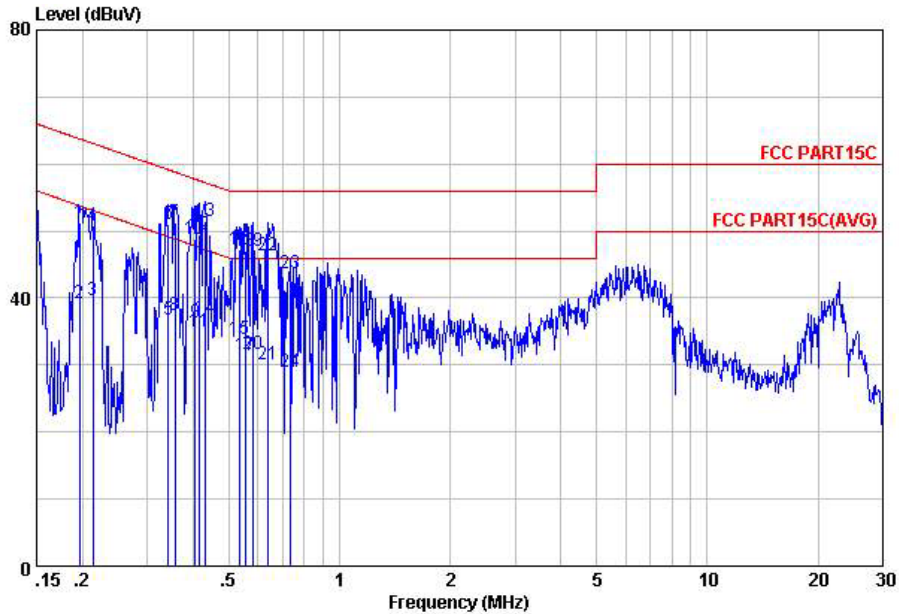

Site : C001-KS  
 Condition: FCC PART15C LISN-L20130306 LINE

mode : Mode 1

	Freq	Level	Over	Limit	Read	LISN	Cable	Remark
	MHz	dBuV	Limit	Line	Level	Factor	Loss	
			dB	dBuV	dBuV	dB	dB	
1	0.20	51.26	-12.50	63.76	40.00	1.04	10.22	QP
2	0.20	39.16	-14.60	53.76	27.90	1.04	10.22	Average
3	0.21	39.59	-13.46	53.05	28.40	0.97	10.22	Average
4	0.21	50.79	-12.26	63.05	39.60	0.97	10.22	QP
5	0.34	36.81	-12.32	49.13	26.10	0.46	10.25	Average
6	0.34	51.11	-8.02	59.13	40.40	0.46	10.25	QP
7	0.36	51.16	-7.62	58.78	40.50	0.41	10.25	QP
8	0.36	37.46	-11.32	48.78	26.80	0.41	10.25	Average
9	0.40	36.26	-11.51	47.77	25.70	0.31	10.25	Average
10	0.40	48.86	-8.91	57.77	38.30	0.31	10.25	QP
11	0.42	34.94	-12.57	47.51	24.40	0.29	10.25	Average
12	0.42	49.44	-8.07	57.51	38.90	0.29	10.25	QP
13	0.43	51.52	-5.72	57.24	41.00	0.27	10.25	QP
14	0.43	37.02	-10.22	47.24	26.50	0.27	10.25	Average
15	0.53	33.96	-12.04	46.00	23.50	0.20	10.26	Average
16	0.53	47.26	-8.74	56.00	36.80	0.20	10.26	QP
17	0.56	31.46	-14.54	46.00	21.00	0.20	10.26	Average
18	0.56	47.06	-8.94	56.00	36.60	0.20	10.26	QP
19	0.58	47.06	-8.94	56.00	36.60	0.20	10.26	QP
20	0.58	31.56	-14.44	46.00	21.10	0.20	10.26	Average
21	0.64	30.17	-15.83	46.00	19.70	0.20	10.27	Average
22	0.64	46.27	-9.73	56.00	35.80	0.20	10.27	QP
23	0.74	43.66	-12.34	56.00	33.20	0.19	10.27	QP
24	0.74	28.86	-17.14	46.00	18.40	0.19	10.27	Average



Test Mode :	Mode 1	Temperature :	19~20°C
Test Engineer :	Tom Wang	Relative Humidity :	39~40%
Test Voltage :	120Vac / 60Hz	Phase :	Neutral
Function Type :	GPRS850 Idle + Bluetooth Link + WLAN Link + USB Cable 1 (Charging from Adapter) + Battery 1 + Earphone		

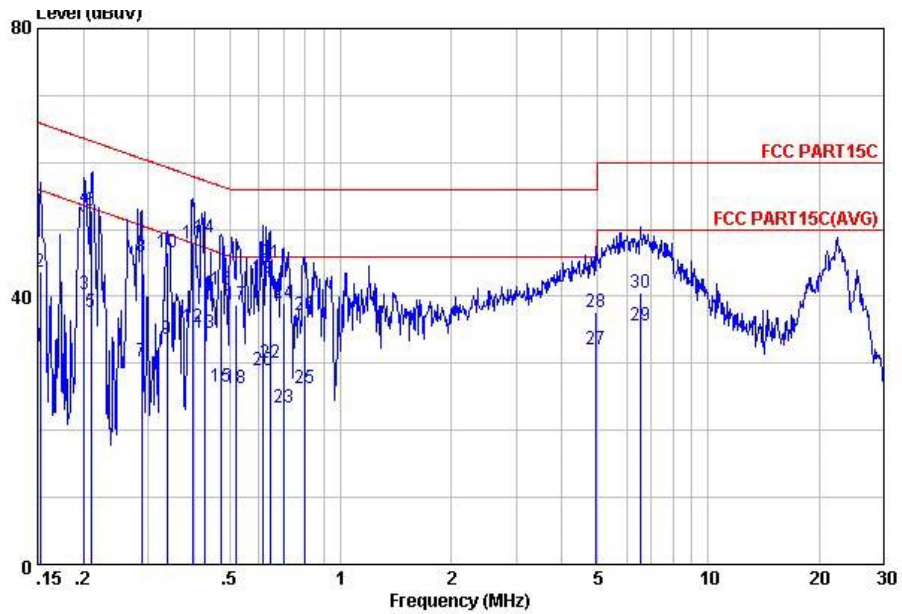

Site : C001-KS  
 Condition: FCC PART15C LISN-N20130306 NEUTRAL

mode : Mode 1

	Freq	Level	Over	Limit	Read	LISN	Cable	Remark
	MHz	dBuV	Limit	Line	Level	Factor	Loss	
			dB	dBuV	dBuV	dB	dB	
1	0.15	32.57	-23.30	55.87	20.50	1.87	10.20	Average
2	0.15	43.67	-22.20	65.87	31.60	1.87	10.20	QP
3	0.20	40.42	-13.16	53.58	29.20	1.00	10.22	Average
4	0.20	53.32	-10.26	63.58	42.10	1.00	10.22	QP
5	0.21	37.60	-15.63	53.23	26.40	0.98	10.22	Average
6	0.21	52.80	-10.43	63.23	41.60	0.98	10.22	QP
7	0.29	30.42	-20.17	50.59	19.40	0.78	10.24	Average
8	0.29	45.82	-14.77	60.59	34.80	0.78	10.24	QP
9	0.34	33.59	-15.68	49.27	22.79	0.55	10.25	Average
10	0.34	46.59	-12.68	59.27	35.79	0.55	10.25	QP
11	0.40	47.96	-9.94	57.90	37.30	0.41	10.25	QP
12	0.40	35.46	-12.44	47.90	24.80	0.41	10.25	Average
13	0.43	34.52	-12.77	47.29	23.90	0.37	10.25	Average
14	0.43	48.72	-8.57	57.29	38.10	0.37	10.25	QP
15	0.47	26.47	-19.98	46.45	15.90	0.32	10.25	Average
16	0.47	41.07	-15.38	56.45	30.50	0.32	10.25	QP
17	0.52	38.75	-17.25	56.00	28.20	0.29	10.26	QP
18	0.52	26.25	-19.75	46.00	15.70	0.29	10.26	Average
19	0.62	42.90	-13.10	56.00	32.41	0.23	10.26	QP
20	0.62	28.90	-17.10	46.00	18.41	0.23	10.26	Average
21	0.64	44.99	-11.01	56.00	34.50	0.22	10.27	QP
22	0.64	29.99	-16.01	46.00	19.50	0.22	10.27	Average
23	0.70	23.37	-22.63	46.00	12.90	0.20	10.27	Average
24	0.70	39.07	-16.93	56.00	28.60	0.20	10.27	QP
25	0.80	26.34	-19.66	46.00	15.89	0.17	10.28	Average
26	0.80	37.14	-18.86	56.00	26.69	0.17	10.28	QP
27	4.95	32.13	-13.87	46.00	21.60	0.20	10.33	Average
28	4.95	37.63	-18.37	56.00	27.10	0.20	10.33	QP
29	6.52	35.55	-14.45	50.00	25.00	0.20	10.35	Average
30	6.52	40.55	-19.45	60.00	30.00	0.20	10.35	QP



## **3.7 Antenna Requirements**

### **3.7.1 Standard Applicable**

If directional gain of transmitting antennas is greater than 6dBi, the power shall be reduced by the same level in dB comparing to gain minus 6dBi. The use of a permanently attached antenna or of an antenna that uses a unique coupling to the intentional radiator shall be considered sufficient to comply with the FCC rule.

### **3.7.2 Antenna Connected Construction**

Non-standard connector used.

### **3.7.3 Antenna Gain**

The antenna peak gain of EUT is less than 6 dBi. Therefore, it is not necessary to reduce maximum peak output power limit.



## 4 List of Measuring Equipment

Instrument	Manufacturer	Model No.	Serial No.	Characteristics	Calibration Date	Test Date	Due Date	Remark
Spectrum Analyzer	R&S	FSP40	100319	9kHz~40GHz	Dec. 29, 2012	Mar. 17, 2013	Dec. 28, 2013	Conducted (TH01-KS)
Power Meter	Agilent	E4416A	MY45101555	N/A	Aug. 22, 2012	Mar. 17, 2013	Aug. 21, 2013	Conducted (TH01-KS)
Power Sensor	Agilent	E9327A	MY44421198	N/A	Aug. 22, 2012	Mar. 17, 2013	Aug. 21, 2013	Conducted (TH01-KS)
Bilog Antenna	Schaffner	CBL6111C	2726	30MHz ~ 1GHz	Oct. 06, 2012	Mar. 23, 2013	Oct. 05, 2013	Radiation (03CH07-HY)
Spectrum Analyzer	Rohde & Schwarz	FSP30	101067	9kHz ~ 30GHz	Nov. 30, 2012	Mar. 23, 2013	Nov. 29, 2013	Radiation (03CH07-HY)
Double Ridge Horn Antenna	ESCO	3117	00075962	1GHz ~ 18GHz	Aug. 22, 2012	Mar. 23, 2013	Aug. 21, 2013	Radiation (03CH07-HY)
Preamplifier	Agilent	8449B	3008A02362	1GHz~ 26.5GHz	Dec. 01, 2012	Mar. 23, 2013	Nov. 30, 2013	Radiation (03CH07-HY)
Preamplifier	MITEQ	AMF-7D-001 01800-30-10 P	159088	1GHz ~ 18GHz	Feb. 27, 2013	Mar. 23, 2013	Feb. 26, 2014	Radiation (03CH07-HY)
Preamplifier	COM-POWER	PA-103A	161241	10-1000MHz. 32dB.GAIN	Feb. 26, 2013	Mar. 23, 2013	Feb. 25, 2014	Radiation (03CH07-HY)
EMI Test Receiver	Rohde & Schwarz	ESCI 7	100724	9kHz~7GHz	Sep. 03, 2012	Mar. 23, 2013	Sep. 02, 2013	Radiation (03CH07-HY)
SHF-EHF Horn Antenna	SCHWARZBECK	BBHA 9170	BBHA9170251	15GHz ~ 40GHz	Sep. 28, 2012	Mar. 23, 2013	Sep. 27, 2013	Radiation (03CH07-HY)
Loop Antenna	R&S	HFH2-Z2	860004/001	9kHz ~ 30MHz	Jul. 03, 2012	Mar. 23, 2013	Jul. 02, 2014	Radiation (03CH07-HY)
Turn Table	chaintek	T-200-S	420/650/00	0 ~ 360 degree	N/A	Mar. 23, 2013	N/A	Radiation (03CH07-HY)
Antenna Mast	chaintek	M-400-0	114/8000604/L	1 m - 4 m	N/A	Mar. 23, 2013	N/A	Radiation (03CH07-HY)
EMI Receiver	R&S	ESCI7	100768	9kHz~7GHz	Jun. 01, 2012	Mar. 22, 2013	May 31, 2013	Conduction (CO01-KS)
LISN (for auxiliary equipment)	MessTec	AN3016	60103	9kHz~30MHz	Dec. 29, 2012	Mar. 22, 2013	Dec. 28, 2013	Conduction (CO01-KS)
LISN	MessTec	AN3016	60105	9kHz~30MHz	Dec. 29, 2012	Mar. 22, 2013	Dec. 28, 2013	Conduction (CO01-KS)
AC Power Source	Chroma	61602	ABP000000811	N/A	Nov. 15, 2012	Mar. 22, 2013	Nov. 14, 2013	Conduction (CO01-KS)

## 5 Uncertainty of Evaluation

### Uncertainty of Conducted Emission Measurement (150 kHz ~ 30 MHz)

Measuring Uncertainty for a Level of Confidence of 95% ( $U = 2Uc(y)$ )	2.26
---	------

### Uncertainty of Radiated Emission Measurement (30 MHz ~ 1000 MHz)

Measuring Uncertainty for a Level of Confidence of 95% ( $U = 2Uc(y)$ )	2.54
---	------

### Uncertainty of Radiated Emission Measurement (1 GHz ~ 40 GHz)

Measuring Uncertainty for a Level of Confidence of 95% ( $U = 2Uc(y)$ )	4.72
---	------



## **Appendix A. Photographs of EUT**

Please refer to Sporton report number EP342901 as below.