

FCC RF Test Report

APPLICANT : Lenovo (Shanghai) Electronics
Technology Co., Ltd.
EQUIPMENT : Tablet PC IdeaTab S6000-H
BRAND NAME : lenovo
MODEL NAME : 60032, Z0A5
FCC ID : O57S6000H
STANDARD : FCC Part 15 Subpart C §15.247
CLASSIFICATION : (DTS) Digital Transmission System

The product was received on Mar. 07, 2013 and completely tested on Apr. 07, 2013. We, SPORTON INTERNATIONAL (KUNSHAN) INC., would like to declare that the tested sample has been evaluated in accordance with the procedures and shown the compliance with the applicable technical standards.

The test results in this report apply exclusively to the tested model / sample. Without written approval of SPORTON INTERNATIONAL (KUNSHAN) INC., the test report shall not be reproduced except in full.

Reviewed by:



Jones Tsai / Manager



SPORTON INTERNATIONAL (KUNSHAN) INC.
No. 3-2, PingXiang Road, Kunshan, Jiangsu Province, P.R.C.



TABLE OF CONTENTS

REVISION HISTORY..... 3

SUMMARY OF TEST RESULT 4

1 GENERAL DESCRIPTION 5

 1.1 Applicant 5

 1.2 Manufacturer 5

 1.3 Feature of Equipment Under Test 5

 1.4 Product Specification of Equipment Under Test..... 5

 1.5 Testing Site 6

 1.6 Applied Standards 6

2 TEST CONFIGURATION OF EQUIPMENT UNDER TEST 7

 2.1 Carrier Frequency Channel 7

 2.2 Pre-Scanned RF Power 8

 2.3 Test Mode 9

 2.4 Connection Diagram of Test System 10

 2.5 Support Unit used in test configuration and system 11

 2.6 RF Utility 11

 2.7 Measurement Results Explanation Example 11

3 TEST RESULT 12

 3.1 6dB Bandwidth Measurement 12

 3.2 Output Power Measurement..... 19

 3.3 Power Spectral Density Measurement 22

 3.4 Conducted Band Edges and Spurious Emission Measurement 34

 3.5 Radiated Emission Measurement..... 47

 3.6 AC Conducted Emission Measurement..... 69

 3.7 Antenna Requirements 73

4 LIST OF MEASURING EQUIPMENT 74

5 UNCERTAINTY OF EVALUATION 75

APPENDIX A. PHOTOGRAPHS OF EUT

APPENDIX B. SETUP PHOTOGRAPHS



REVISION HISTORY

REPORT NO.	VERSION	DESCRIPTION	ISSUED DATE
FR331304C	Rev. 01	Initial issue of report	Apr. 19, 2013

SUMMARY OF TEST RESULT

Report Section	FCC Rule	IC Rule	Description	Limit	Result	Remark
3.1	15.247(a)(2)	A8.2(a)	6dB Bandwidth	$\geq 0.5\text{MHz}$	Pass	-
3.2	15.247(b)	A8.4	Power Output Measurement	$\leq 30\text{dBm}$	Pass	-
3.3	15.247(e)	A8.2(b)	Power Spectral Density	$\leq 8\text{dBm}/3\text{kHz}$	Pass	-
3.4	15.247(d)	A8.5	Conducted Band Edges	$\leq 20\text{dBc}$	Pass	-
			Conducted Spurious Emission		Pass	-
3.5	15.247(d)	A8.5	Radiated Band Edges	15.209(a) & 15.247(d)	Pass	-
			Radiated Spurious Emission		Pass	Under limit 3.11 dB at 2388.030 MHz
3.6	15.207	Gen 7.2.4	AC Conducted Emission	15.207(a)	Pass	Under limit 5.72 dB at 0.430 MHz
3.7	15.203 & 15.247(b)	A8.4	Antenna Requirement	N/A	Pass	-

1 General Description

1.1 Applicant

Lenovo (Shanghai) Electronics Technology Co., Ltd.

No. 68 Building, 199 Fenju Road, Wai Gao Qiao FTZ, Shanghai, China

1.2 Manufacturer

Lenovo PC HK Limited

23/F, Lincoln House, Taikoo Place 979 King's Road, Quarry Bay, Hong Kong

1.3 Feature of Equipment Under Test

Product Feature	
Equipment	Tablet PC IdeaTab S6000-H
Brand Name	lenovo
Model Name	60032, Z0A5
FCC ID	O57S6000H
EUT supports Radios application	GPRS/EGPRS/WCDMA/HSPA/WLAN 11bgn/ Bluetooth/ Bluetooth 4.0 - LE
HW Version	lepad S6000-H
SW Version	S6000-130519
EUT Stage	Identical Prototype

Remark:

1. The above EUT's information was declared by manufacturer. Please refer to the specifications or user's manual for more detailed description.
2. There are two types of EUT Sample 1 and Sample 2. The differences between the two samples are only different supplier for EMMC card/Touch panel/LCD panel and the back camera. The others are the same including circuit design, PCB board, structure and other components.

1.4 Product Specification of Equipment Under Test

Product Specification subjective to this standard	
Tx/Rx Frequency Range	2412 MHz ~ 2462 MHz
Number of Channels	11
Carrier Frequency of Each Channel	2412+(n-1)*5 MHz; n=1~11
Maximum Output Power to Antenna	802.11b : 16.95 dBm (0.0495 W) 802.11g : 21.05 dBm (0.1274 W) 802.11n HT20 : 21.55 dBm (0.1429 W)
Antenna Type	Fixed Internal Antenna with gain 3.10 dBi
Type of Modulation	802.11b : DSSS (DBPSK / DQPSK / CCK) 802.11g/n : OFDM (BPSK / QPSK / 16QAM / 64QAM)

1.5 Testing Site

Test Site	SPORTON INTERNATIONAL INC.	
Test Site Location	No. 52, Hwa Ya 1 st Rd., Hwa Ya Technology Park, Kwei-Shan Hsiang, Tao Yuan Hsien, Taiwan, R.O.C. TEL: +886-3-3273456 / FAX: +886-3-3284978	
Test Site No.	Sporton Site No.	FCC/IC Registration No.
	03CH07-HY	722060/4086B-1

Test Site	SPORTON INTERNATIONAL (KUNSHAN) INC.		
Test Site Location	No. 3-2, PingXiang Road, Kunshan, Jiangsu Province, P.R.C. TEL: +86-0512-5790-0158 FAX: +86-0512-5790-0958		
Test Site No.	Sporton Site No.		FCC/IC Registration No.
	TH01-KS	CO01-KS	149928/4086E-1

The test site complies with ANSI C63.4 2003 requirement.

1.6 Applied Standards

According to the specifications of the manufacturer, the EUT must comply with the requirements of the following standards:

- FCC Part 15 Subpart C §15.247
- FCC KDB Publication No. 558074 D01 DTS Meas. Guidance v02
- ANSI C63.10-2009

Remark:

1. All test items were verified and recorded according to the standards and without any deviation during the test.
2. This EUT has also been tested and complied with the requirements of FCC Part 15, Subpart B, recorded in a separate test report.

2 Test Configuration of Equipment Under Test

The EUT has been associated with peripherals and configuration operated in a manner tended to maximize its emission characteristics in a typical application. Frequency range investigated: conducted emission (150 KHz to 30 MHz) and radiated emission (9 KHz to the 10th harmonic of the highest fundamental frequency or to 40 GHz, whichever is lower). For radiated measurement, pre-scanned in three orthogonal panels, X, Y, Z. The worst cases (X plane) were recorded in this report.

The final configuration from all the combinations and the worst-case data rates were investigated by measuring the maximum power across all the data rates and modulation modes under section 2.2.

Based on the worst configuration found above, the RF power setting is set individually to meet FCC compliance limit for the final conducted and radiated tests shown in section 2.3.

2.1 Carrier Frequency Channel

Frequency Band	Channel	Freq. (MHz)	Channel	Freq. (MHz)
2400-2483.5 MHz	1	2412	7	2442
	2	2417	8	2447
	3	2422	9	2452
	4	2427	10	2457
	5	2432	11	2462
	6	2437		

2.2 Pre-Scanned RF Power

Preliminary tests were performed in different data rate and antenna configurations as following table and the highest power data rates were chosen for full test in the following tables. Final Output Power equals to Measured Output Power adds the duty factor.

Channel	Frequency	2.4GHz 802.11b RF Power (dBm)			
		DSSS Data Rate			
		1 Mbps	2 Mbps	5.5 Mbps	11 Mbps
CH 01	2412 MHz	16.42	16.45	16.32	16.17
CH 06	2437 MHz	16.95	16.91	16.62	16.65
CH 11	2462 MHz	16.93	16.82	16.53	16.59

Channel	Frequency	2.4GHz 802.11g RF Power (dBm)							
		OFDM Data Rate							
		6 Mbps	9 Mbps	12 Mbps	18 Mbps	24 Mbps	36 Mbps	48 Mbps	54 Mbps
CH 01	2412 MHz	20.85	20.59	20.45	20.41	20.23	20.24	20.32	20.6
CH 06	2437 MHz	21.05	20.78	20.81	20.71	20.44	20.81	20.55	20.63
CH 11	2462 MHz	20.89	20.71	20.58	20.63	20.55	20.62	20.59	20.63

Channel	Frequency	2.4GHz 802.11n HT20 RF Power (dBm)							
		OFDM Data Rate							
		MCS0	MCS1	MCS2	MCS3	MCS4	MCS5	MCS6	MCS7
CH 01	2412 MHz	21.15	20.71	20.69	20.55	20.45	20.65	20.16	20.22
CH 06	2437 MHz	21.55	20.95	20.78	20.83	20.81	20.51	20.48	20.42
CH 11	2462 MHz	21.32	21.02	20.89	20.76	20.62	20.59	20.57	20.48

2.3 Test Mode

Final results of test modes, data rates and test channels are shown as following table.

Test Cases				
	Test Items	Mode	Data Rate	Test Channel
Conducted TCs	6dB BW Power Spectral Density	802.11b	1 Mbps	1/6/11
		802.11g	6 Mbps	1/6/11
		802.11n HT20	6.5 Mbps	1/6/11
	Output Power	802.11b	1 Mbps	1/6/11
		802.11g	6 Mbps	1/6/11
		802.11n HT20	6.5 Mbps	1/6/11
	Conducted Band Edge	802.11b	1 Mbps	1/11
		802.11g	6 Mbps	1/11
		802.11n HT20	6.5 Mbps	1/11
Conducted Spurious Emission	802.11b	1 Mbps	1/6/11	
	802.11g	6 Mbps	1/6/11	
	802.11n HT20	6.5 Mbps	1/6/11	
Radiated TCs	Radiated Band Edge	802.11b	1 Mbps	1/11
		802.11g	6 Mbps	1/11
		802.11n HT20	6.5 Mbps	1/11
	Radiated Spurious Emission	802.11b	1 Mbps	1/6/11
		802.11g	6 Mbps	1/6/11
		802.11n HT20	6.5 Mbps	1/6/11
AC Conducted Emission	Mode 1 : GPRS850 Idle + Bluetooth Link + WLAN Link + USB Cable 1 (Charging from Adapter 1) + Battery 1 + Earphone for Sample 1 Mode 2 : GPRS850 Idle + Bluetooth Link + WLAN Link + USB Cable 2 (Charging from Adapter 2) + Battery 2 + Earphone for Sample 2			
Remark: The worst case of conducted emission is mode 1; only the test data of it was reported.				

2.4 Connection Diagram of Test System

<WLAN Tx Mode>

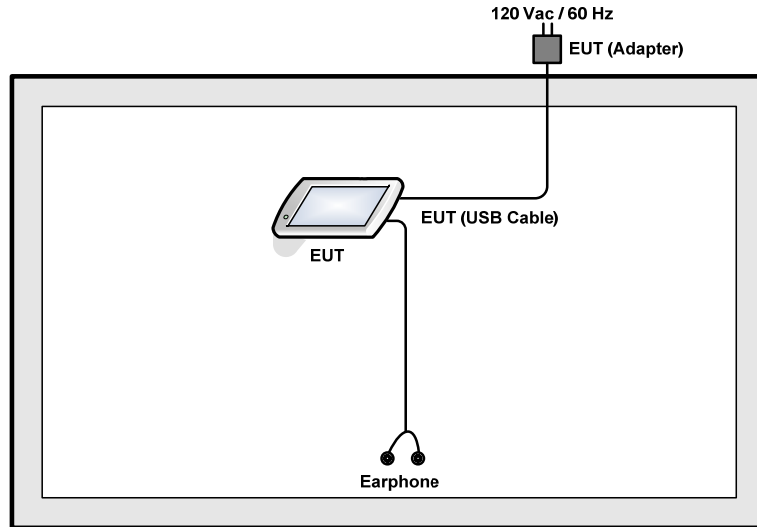

<AC Conducted Emission Mode>

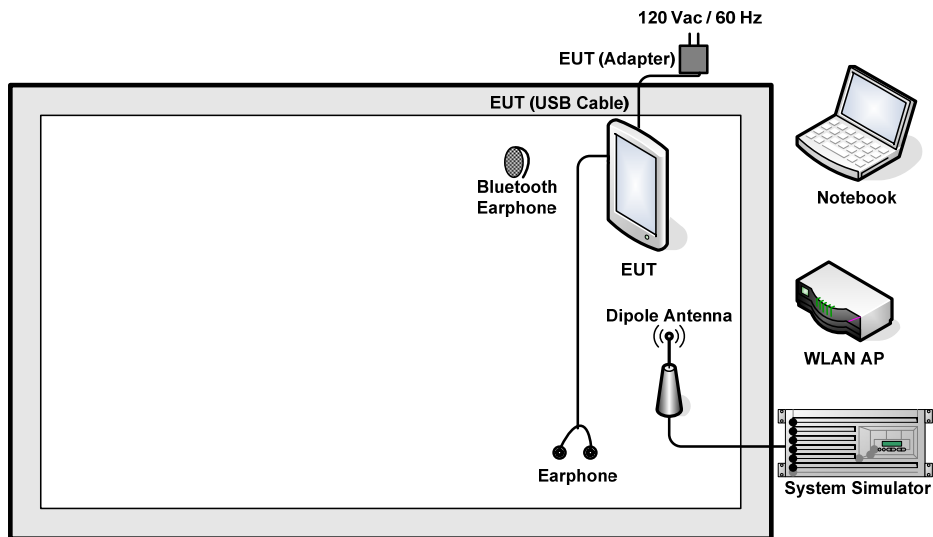

2.5 Support Unit used in test configuration and system

Item	Equipment	Trade Name	Model Name	FCC ID	Data Cable	Power Cord
1.	System Simulator	R&S	CMU 200	N/A	N/A	Unshielded, 1.8 m
2.	DC Power Supply	GWINSTEK	GPS-3030D	N/A	N/A	Unshielded, 1.8 m
3.	WLAN AP	D-Link	DIR-855	KA2DIR855A2	N/A	Unshielded, 1.8 m
4.	Notebook	DELL	P08S	QDS-BRCM1030	N/A	AC I/P: Unshielded, 0.9 m DC O/P: Shielded, 1.8 m
5.	Bluetooth Earphone	Lenovo	LBH301	N/A	N/A	N/A

2.6 RF Utility

For WLAN function, turn on “Enter Engmode” software on the EUT directly. Then, the EUT will get into the engineering modes to contact with WLAN AP for continuous transmitting and receiving signals.

2.7 Measurement Results Explanation Example

For conducted test items:

The offset level is set in the spectrum analyzer to compensate the RF cable loss and 10dB attenuator between EUT conducted output port and spectrum analyzer. With the offset compensation, the spectrum analyzer reading level is exactly the EUT RF output level.

The spectrum analyzer offset is derived from RF cable loss and 10dB attenuator factor.

Offset = RF cable loss + attenuator factor.

Following table shows an offset computation example with cable loss 5.6 dB.

Example :

$$\begin{aligned} \text{Offset(dB)} &= \text{RF cable loss(dB)} + \text{attenuator factor(dB)}. \\ &= 5.6 + 10 = 15.6 \text{ (dB)} \end{aligned}$$

3 Test Result

3.1 6dB Bandwidth Measurement

3.1.1 Limit of 6dB Bandwidth

The minimum 6 dB bandwidth shall be at least 500 KHz.

3.1.2 Measuring Instruments

See list of measuring instruments of this test report.

3.1.3 Test Procedures

1. The testing follows the Measurement Procedure of FCC KDB No. 558074 DTS D01 Meas. Guidance v02.
2. The RF output of EUT was connected to the spectrum analyzer by RF cable and attenuator. The path loss was compensated to the results for each measurement.
3. Set to the maximum power setting and enable the EUT transmit continuously.
4. Make the measurement with the spectrum analyzer's resolution bandwidth (RBW) = 100 kHz. Set the Video bandwidth (VBW) = 300 kHz. In order to make an accurate measurement. The 6 dB bandwidth must be greater than 500 KHz.
5. Measure and record the results in the test report.

3.1.4 Test Setup

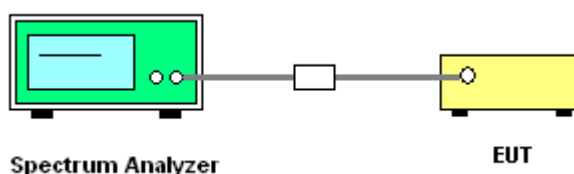



3.1.5 Test Result of 6dB Bandwidth

Test Mode :	802.11b	Temperature :	23~24°C
Test Engineer :	Lizy Li	Relative Humidity :	47~48%

Channel	Frequency (MHz)	802.11b 6dB Bandwidth (MHz)	6dB Bandwidth Min. Limit (MHz)	Pass/Fail
01	2412	9.08	0.5	Pass
06	2437	9.04	0.5	Pass
11	2462	9.04	0.5	Pass

6 dB Bandwidth Plot on 802.11b Channel 01

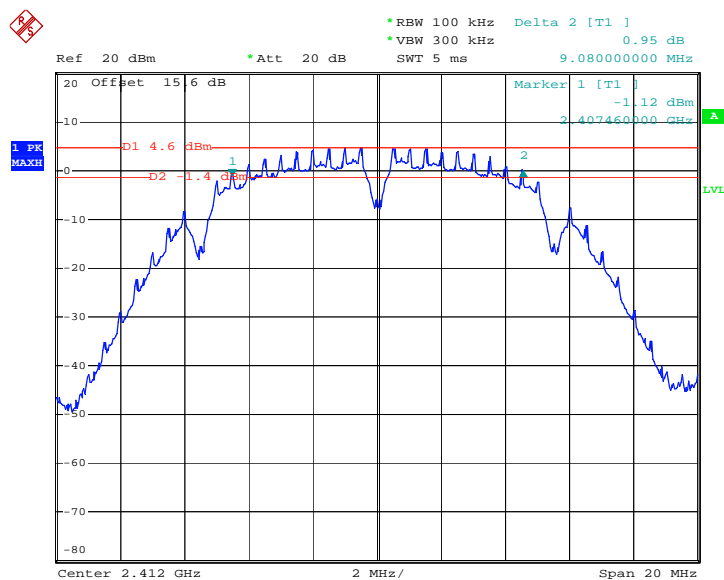

Date: 15.MAR.2013 23:13:50



6 dB Bandwidth Plot on 802.11b Channel 06

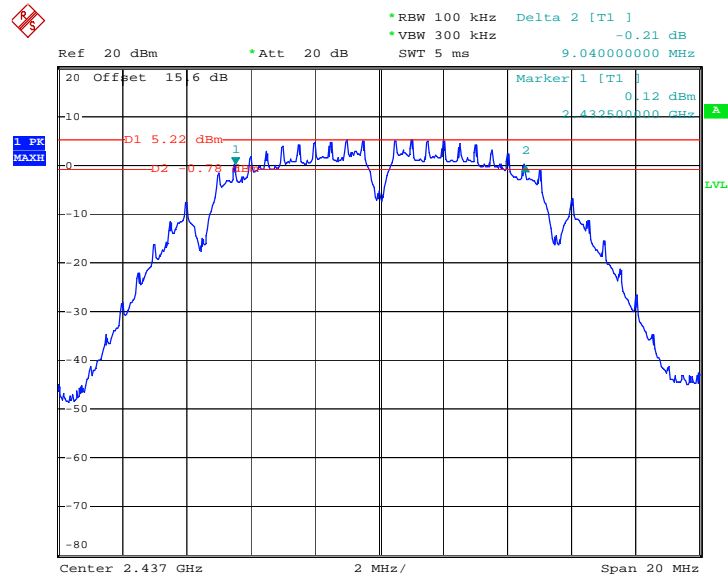

Date: 15.MAR.2013 23:18:18

6 dB Bandwidth Plot on 802.11b Channel 11

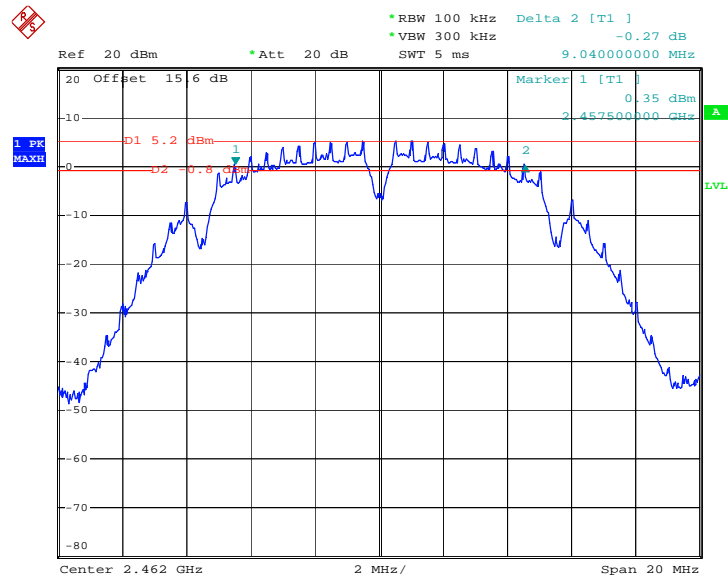

Date: 15.MAR.2013 23:21:48



Test Mode :	802.11g	Temperature :	23~24°C
Test Engineer :	Lizy Li	Relative Humidity :	47~48%

Channel	Frequency (MHz)	802.11g 6dB Bandwidth (MHz)	6dB Bandwidth Min. Limit (MHz)	Pass/Fail
01	2412	16.40	0.5	Pass
06	2437	16.36	0.5	Pass
11	2462	16.40	0.5	Pass

6 dB Bandwidth Plot on 802.11g Channel 01

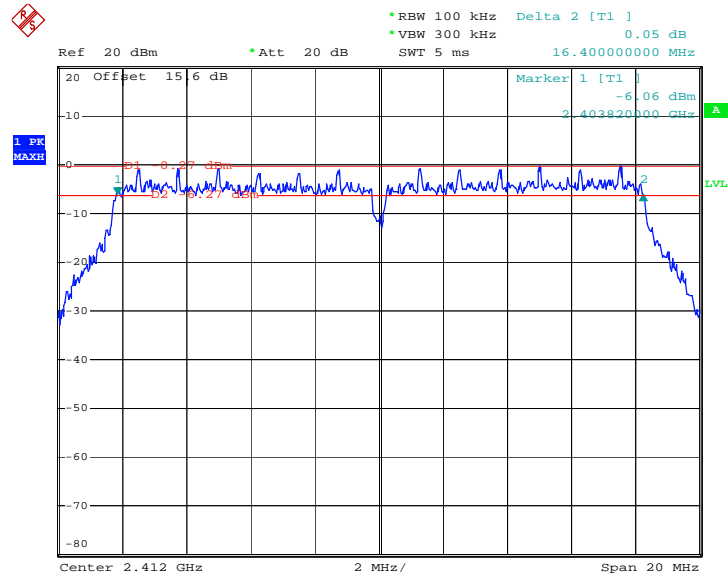

Date: 15.MAR.2013 23:25:38



6 dB Bandwidth Plot on 802.11g Channel 06

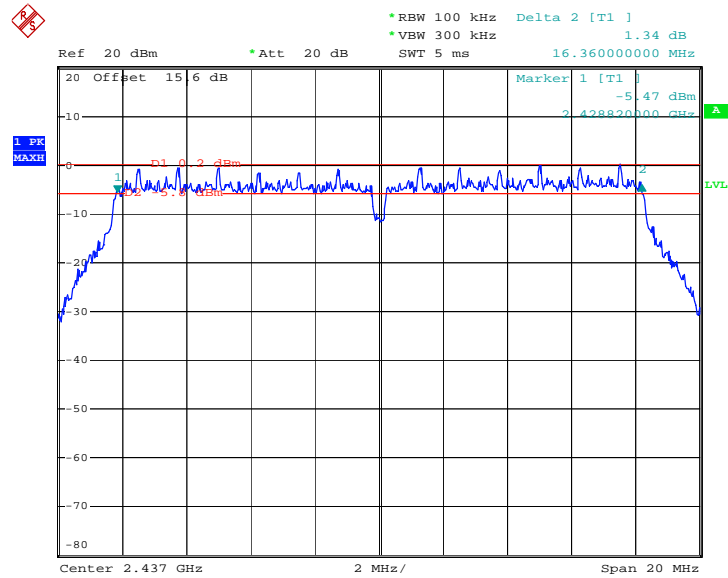

Date: 15.MAR.2013 23:29:30

6 dB Bandwidth Plot on 802.11g Channel 11

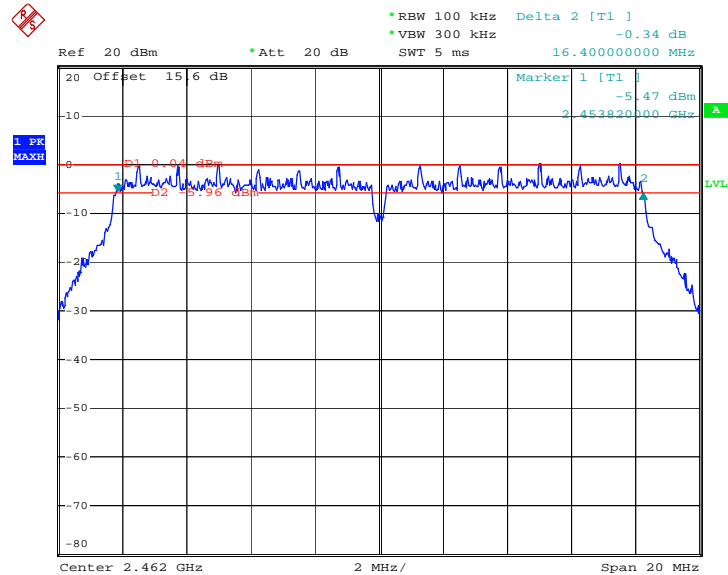

Date: 15.MAR.2013 23:31:52



Test Mode :	802.11n HT20	Temperature :	23~24°C
Test Engineer :	Lizy Li	Relative Humidity :	47~48%

Channel	Frequency (MHz)	2.4GHz 802.11n HT20 6dB Bandwidth (MHz)	6dB Bandwidth Min. Limit (MHz)	Pass/Fail
01	2412	17.60	0.5	Pass
06	2437	17.60	0.5	Pass
11	2462	17.60	0.5	Pass

6 dB Bandwidth Plot on 802.11n HT20 Channel 01

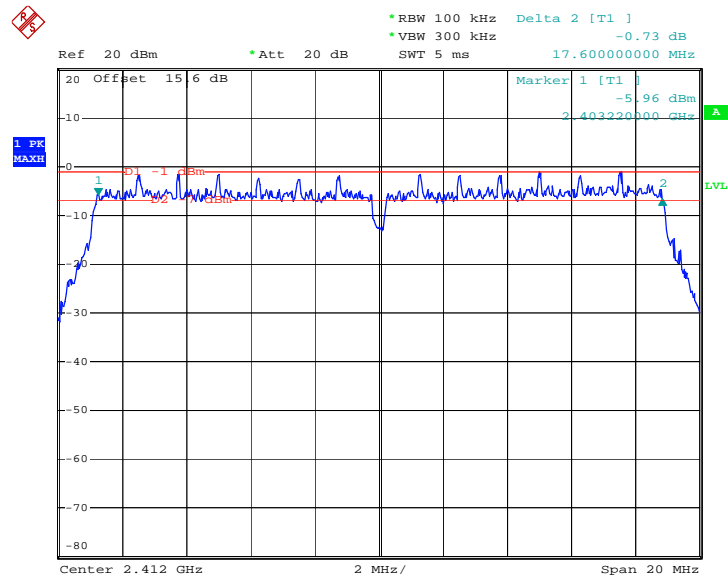

Date: 15.MAR.2013 23:36:57



6 dB Bandwidth Plot on 802.11n HT20 Channel 06

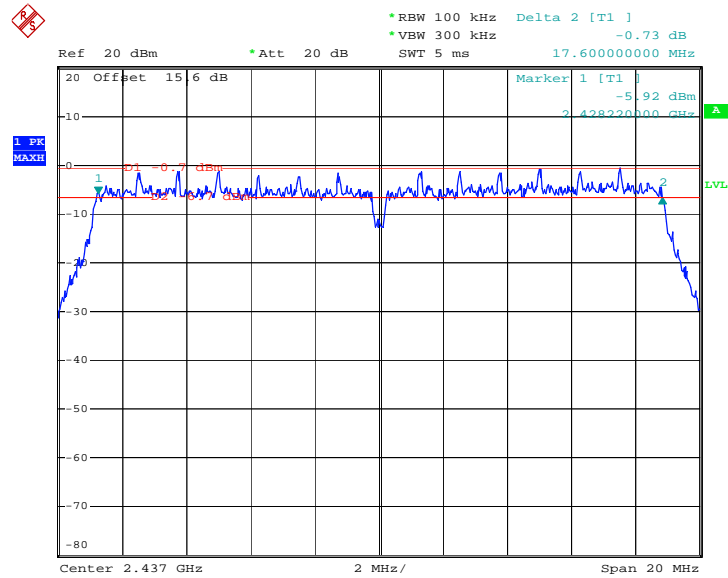

Date: 15.MAR.2013 23:40:16

6 dB Bandwidth Plot on 802.11n HT20 Channel 11

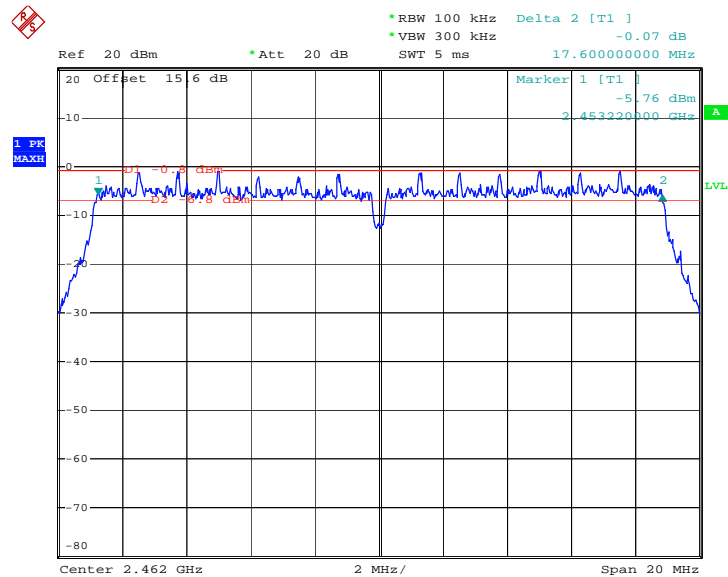

Date: 15.MAR.2013 23:42:47

3.2 Output Power Measurement

3.2.1 Limit of Output Power

For systems using digital modulation in the 2400-2483.5MHz, the limit for peak output power is 30dBm. If transmitting antenna of directional gain greater than 6dBi are used the peak output power from the intentional radiator shall be reduced below the above stated value by the amount in dB that the directional gain of the antenna exceeds 6 dBi. In case of point-to-point operation, the limit has to be reduced by 1dB for every 3dB that the directional gain of the antenna exceeds 6dBi.

3.2.2 Measuring Instruments

See list of measuring instruments of this test report.

3.2.3 Test Procedures

1. The testing follows the Measurement Procedure of FCC KDB No. 558074 DTS D01 Meas. Guidance v02.
2. The RF output of EUT was connected to the spectrum analyzer by RF cable and attenuator. The path loss was compensated to the results for each measurement.
3. Set to the maximum power setting and enable the EUT transmit continuously.
4. Measure the conducted output power and record the results in the test report.

3.2.4 Test Setup

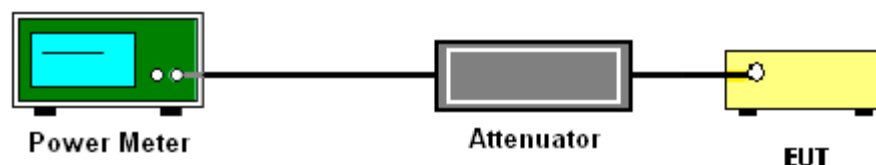



3.2.5 Test Result of Peak Output Power

Test Mode :	802.11b	Temperature :	23~24°C
Test Engineer :	Lizy Li	Relative Humidity :	47~48%

Channel	Frequency (MHz)	802.11b Peak Output Power (dBm)	Max. Limits (dBm)	Pass/Fail
01	2412	16.42	30	Pass
06	2437	16.95	30	Pass
11	2462	16.93	30	Pass

Test Mode :	802.11g	Temperature :	23~24°C
Test Engineer :	Lizy Li	Relative Humidity :	47~48%

Channel	Frequency (MHz)	802.11g Peak Output Power (dBm)	Max. Limits (dBm)	Pass/Fail
01	2412	20.85	30	Pass
06	2437	21.05	30	Pass
11	2462	20.89	30	Pass

Test Mode :	802.11n HT20	Temperature :	23~24°C
Test Engineer :	Lizy Li	Relative Humidity :	47~48%

Channel	Frequency (MHz)	2.4GHz 802.11n HT20 Peak Output Power (dBm)	Max. Limits (dBm)	Pass/Fail
01	2412	21.15	30	Pass
06	2437	21.55	30	Pass
11	2462	21.32	30	Pass



3.2.6 Test Result of Average output Power (Reporting Only)

Test Mode :	802.11b	Temperature :	23~24°C
Test Engineer :	Lizy Li	Relative Humidity :	47~48%
Duty Cycle:	99.06%	Duty Factor:	0.04dB

Channel	Frequency (MHz)	802.11b Average Output Power (dBm)
01	2412	13.17
06	2437	13.62
11	2462	13.61

Test Mode :	802.11g	Temperature :	23~24°C
Test Engineer :	Lizy Li	Relative Humidity :	47~48%
Duty Cycle:	92.67%	Duty Factor:	0.33dB

Channel	Frequency (MHz)	802.11g Average Output Power (dBm)
01	2412	10.31
06	2437	10.64
11	2462	10.46

Test Mode :	802.11n HT20	Temperature :	23~24°C
Test Engineer :	Lizy Li	Relative Humidity :	47~48%
Duty Cycle:	91.80%	Duty Factor:	0.37dB

Channel	Frequency (MHz)	802.11n HT20 Average Output Power (dBm)
01	2412	10.43
06	2437	10.92
11	2462	10.76

3.3 Power Spectral Density Measurement

3.3.1 Limit of Power Spectral Density

The peak power spectral density shall not be greater than 8dBm in any 3KHz band at any time interval of continuous transmission.

3.3.2 Measuring Instruments

See list of measuring instruments of this test report.

3.3.3 Test Procedures

1. The testing follows Measurement Procedure 9.1 Option 1 of FCC KDB Publication No. 558074 D01 DTS Meas. Guidance v02
2. The RF output of EUT was connected to the spectrum analyzer by RF cable and attenuator. The path loss was compensated to the results for each measurement.
3. Set to the maximum power setting and enable the EUT transmit continuously.
4. Make the measurement with the spectrum analyzer's resolution bandwidth (RBW) = 3 kHz. Video bandwidth VBW = 10 kHz In order to make an accurate measurement, set the span to 1.5 times DTS Channel Bandwidth. (6dB BW)
5. Detector = peak, Sweep time = auto couple, Trace mode = max hold, Allow trace to fully stabilize. Use the peak marker function to determine the maximum power level.
6. Measure and record the results in the test report.

3.3.4 Test Setup

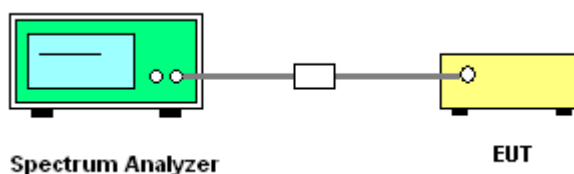

3.3.5 Test Result of Power Spectral Density

Test Mode :	802.11b	Temperature :	23~24°C
Test Engineer :	Lizy Li	Relative Humidity :	47~48%

Channel	Frequency (MHz)	802.11b Power Density		Max. Limits (dBm/3KHz)	Pass/Fail
		PSD/100KHz (dBm)	PSD/3KHz (dBm)		
01	2412	4.26	-9.56	8	Pass
06	2437	4.85	-4.93	8	Pass
11	2462	4.78	-6.74	8	Pass

Test Mode :	802.11g	Temperature :	23~24°C
Test Engineer :	Lizy Li	Relative Humidity :	47~48%

Channel	Frequency (MHz)	802.11g Power Density		Max. Limits (dBm/3KHz)	Pass/Fail
		PSD/100KHz (dBm)	PSD/3KHz (dBm)		
01	2412	-0.63	-14.83	8	Pass
06	2437	-0.37	-13.56	8	Pass
11	2462	-0.28	-12.42	8	Pass

Test Mode :	802.11n HT20	Temperature :	23~24°C
Test Engineer :	Lizy Li	Relative Humidity :	47~48%

Channel	Frequency (MHz)	802.11n HT20 Power Density		Max. Limits (dBm/3KHz)	Pass/Fail
		PSD/100KHz (dBm)	PSD/3KHz (dBm)		
01	2412	-1.61	-15.49	8	Pass
06	2437	-0.93	-14.60	8	Pass
11	2462	-0.81	-15.16	8	Pass

Note:

1. Measured power density (dBm) has offset with cable loss.
2. The Measured power density (dBm)/ 100KHz is reference level and used as 20dBc down for Conducted Band Edges and Conducted Spurious Emission limit line.



3.3.6 Test Result of Power Spectral Density Plots (100kHz)

PSD 100kHz Plot on 802.11b Channel 01

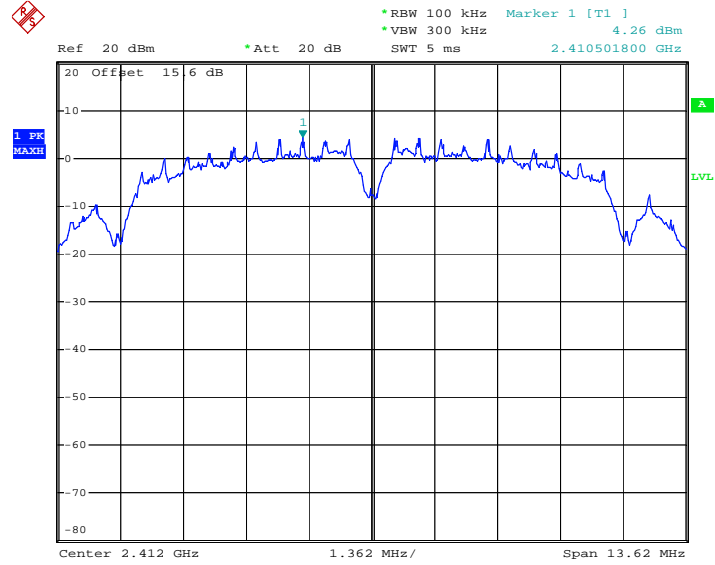

Date: 15.MAR.2013 23:14:20

PSD 100kHz Plot on 802.11b Channel 06

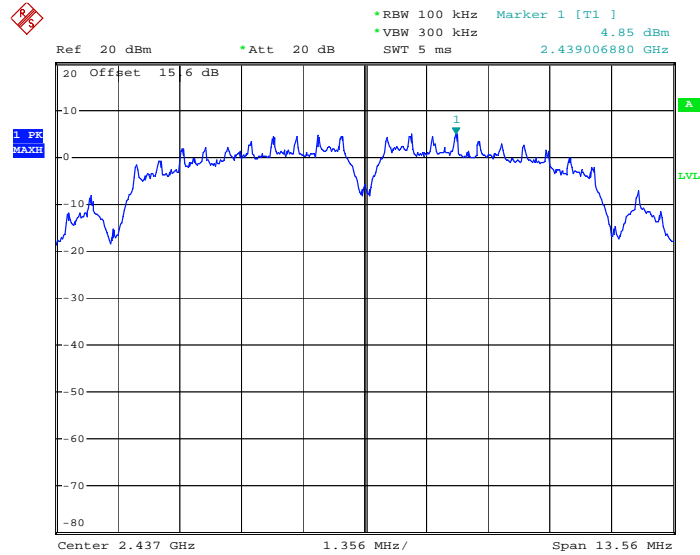

Date: 15.MAR.2013 23:18:47



PSD 100kHz Plot on 802.11b Channel 11

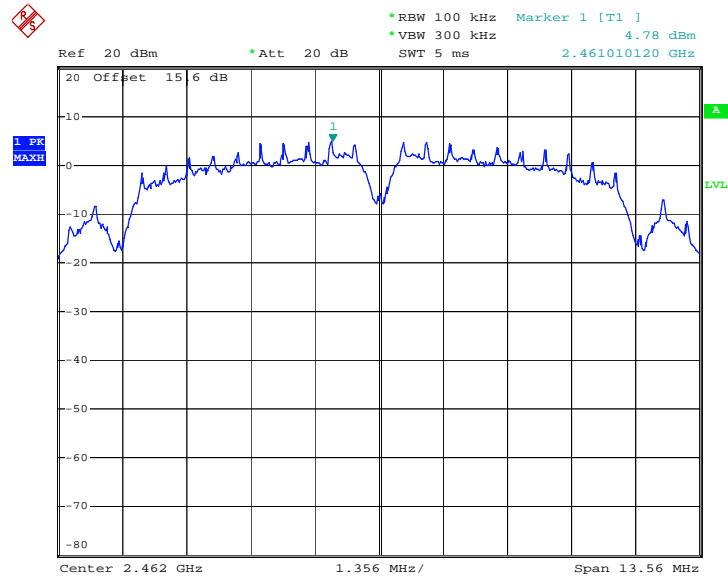

Date: 15.MAR.2013 23:22:18

PSD 100kHz Plot on 802.11g Channel 01

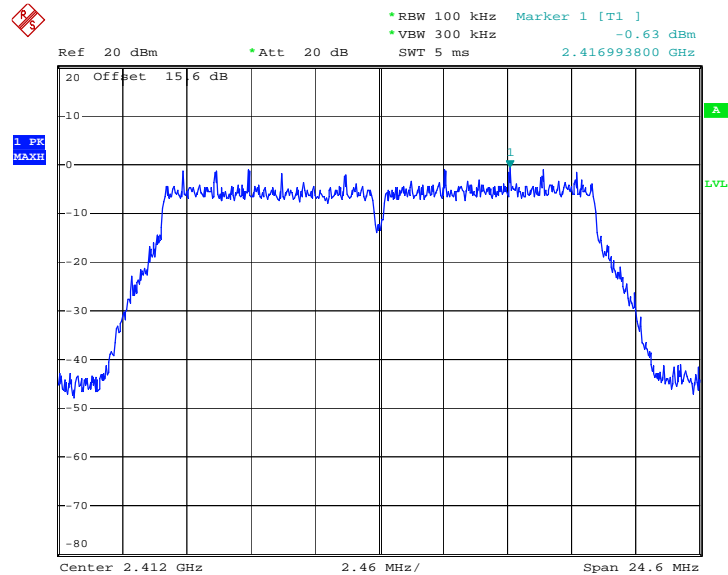

Date: 15.MAR.2013 23:26:09



PSD 100kHz Plot on 802.11g Channel 06

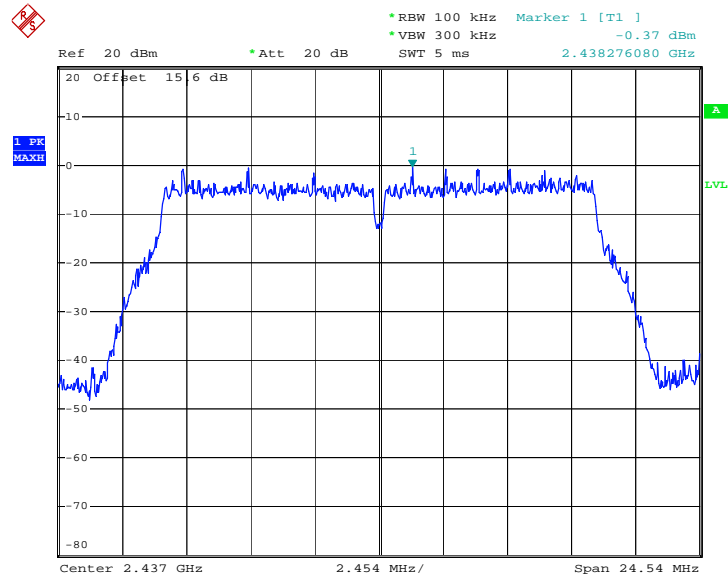

Date: 15.MAR.2013 23:30:00

PSD 100kHz Plot on 802.11g Channel 11

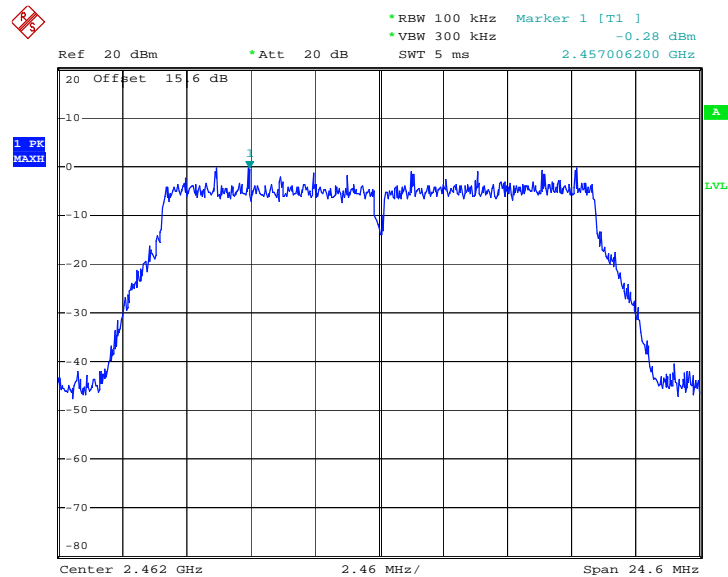

Date: 15.MAR.2013 23:32:23



PSD 100kHz Plot on 802.11n HT20 Channel 01

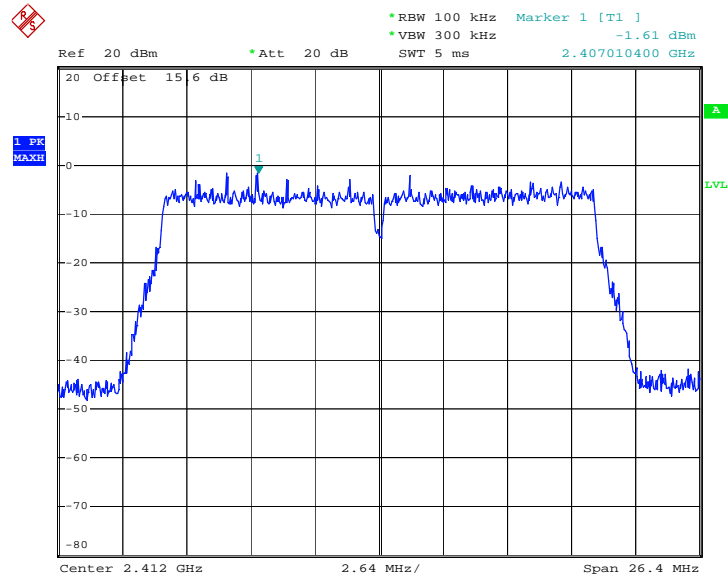

Date: 15.MAR.2013 23:37:28

PSD 100kHz Plot on 802.11n HT20 Channel 06

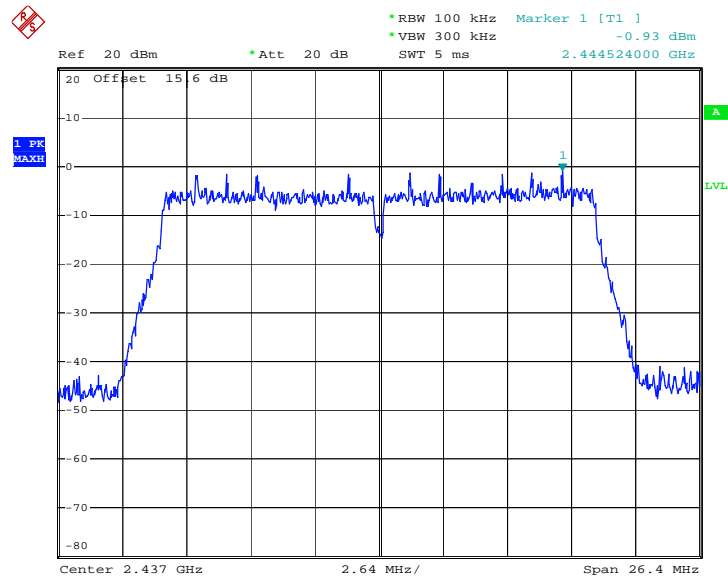

Date: 15.MAR.2013 23:40:47



PSD 100kHz Plot on 802.11n HT20 Channel 11

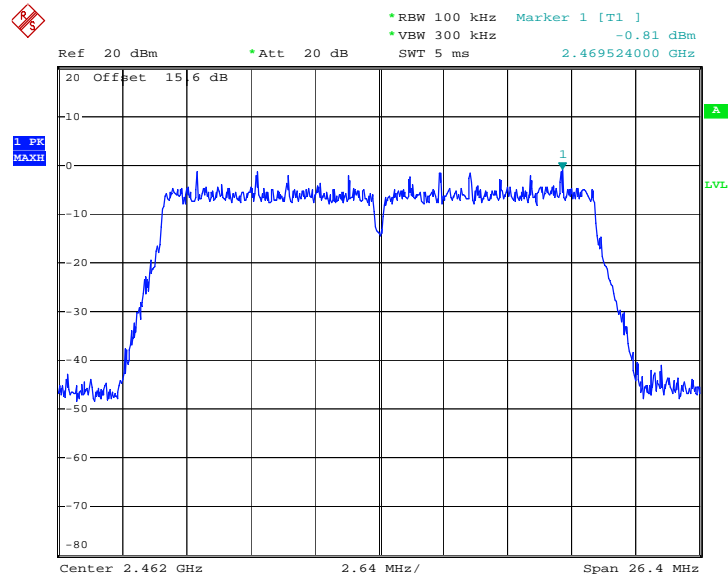

Date: 15.MAR.2013 23:43:18



3.3.7 Test Result of Power Spectral Density Plots (3kHz)

PSD 3kHz Plot on 802.11b Channel 01

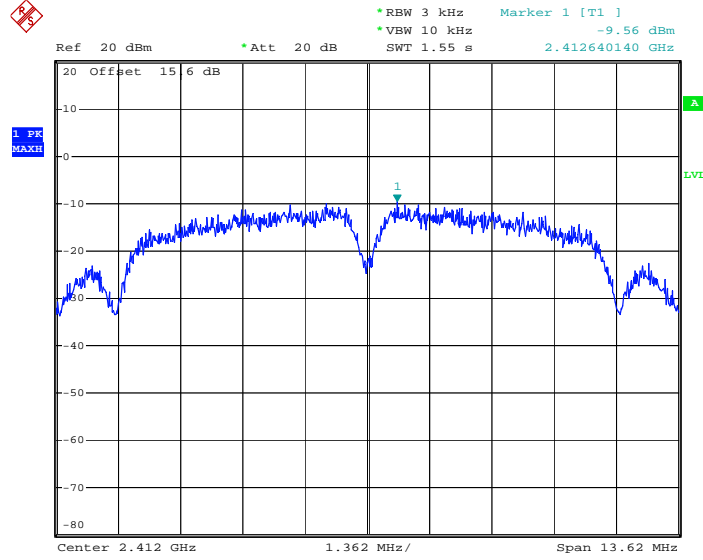

Date: 15.MAR.2013 23:14:10

PSD 3kHz Plot on 802.11b Channel 06

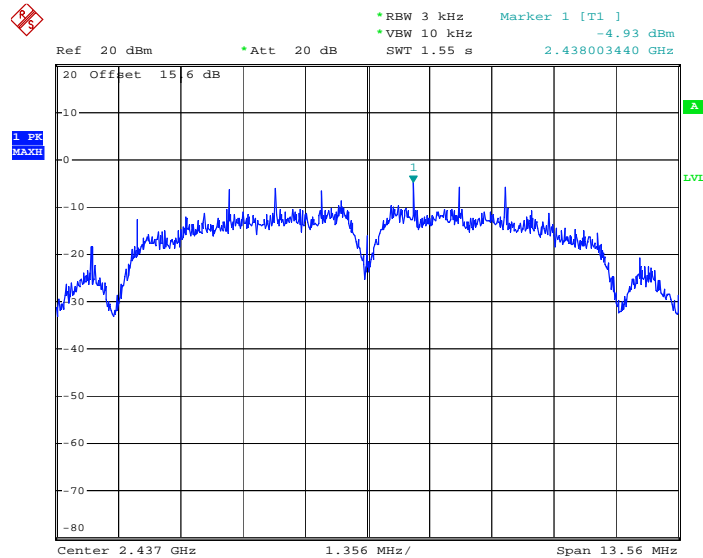

Date: 15.MAR.2013 23:18:37



PSD 3kHz Plot on 802.11b Channel 11

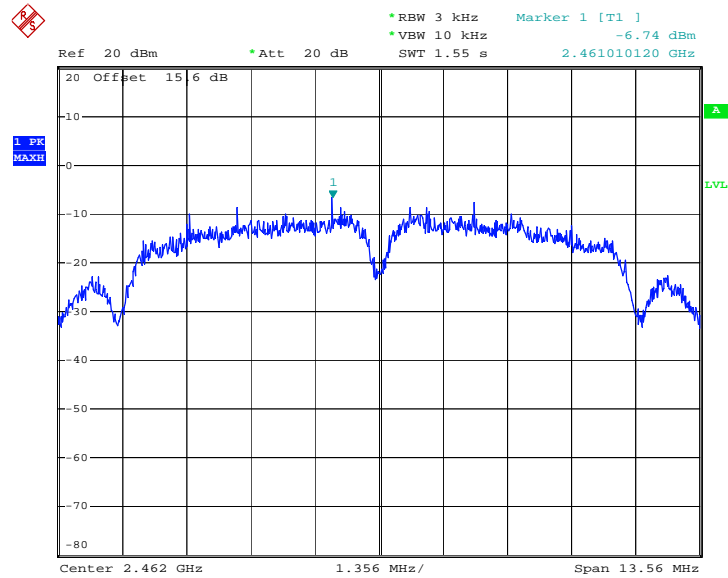

Date: 15.MAR.2013 23:22:08

PSD 3kHz Plot on 802.11g Channel 01

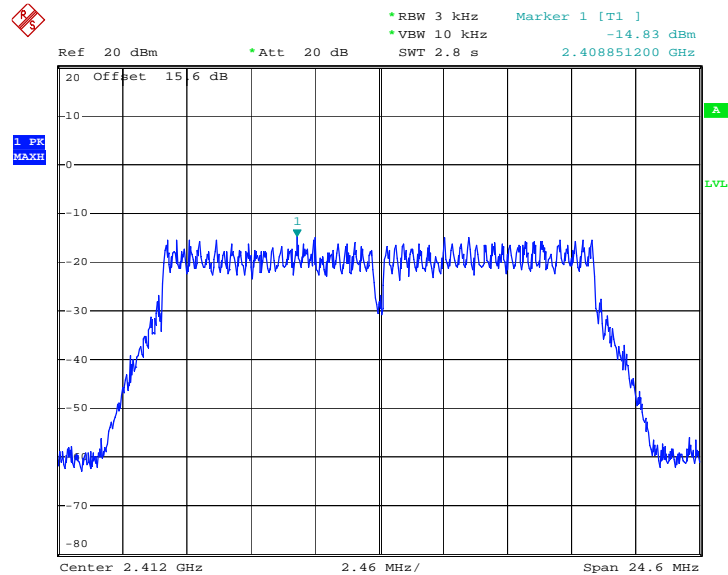

Date: 15.MAR.2013 23:25:59



PSD 3kHz Plot on 802.11g Channel 06

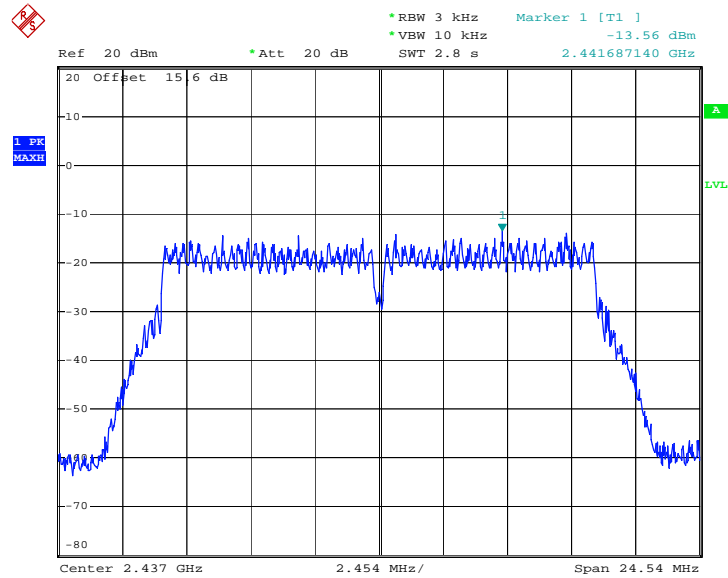

Date: 15.MAR.2013 23:29:50

PSD 3kHz Plot on 802.11g Channel 11

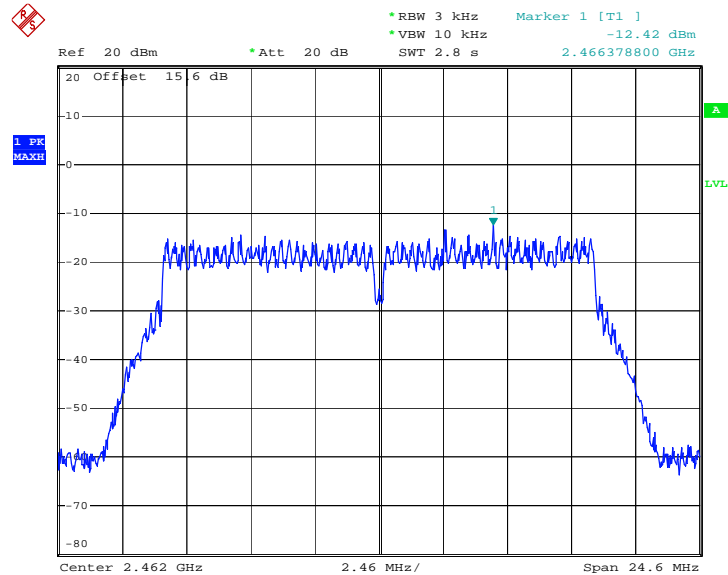

Date: 15.MAR.2013 23:32:13



PSD 3kHz Plot on 802.11n HT20 Channel 01

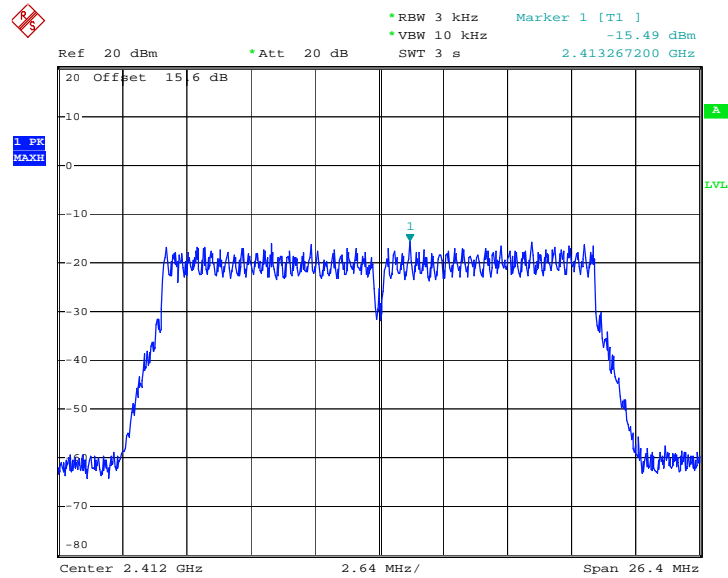

Date: 15.MAR.2013 23:37:18

PSD 3kHz Plot on 802.11n HT20 Channel 06

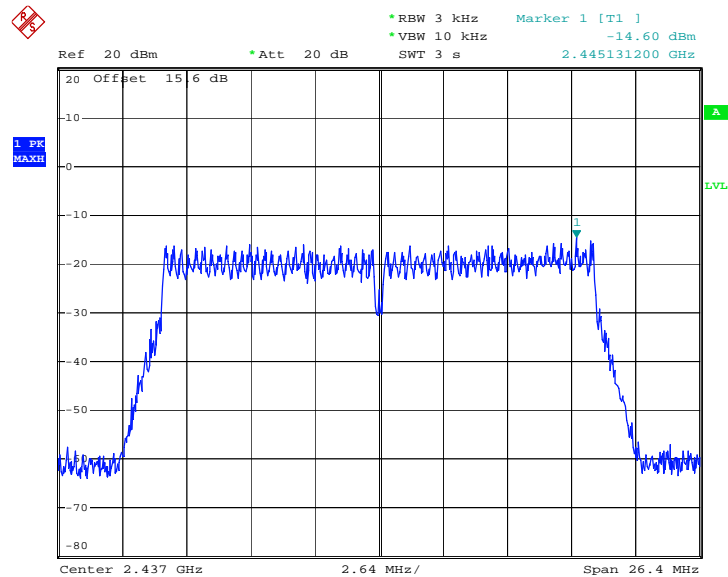

Date: 15.MAR.2013 23:40:37



PSD 3kHz Plot on 802.11n HT20 Channel 11

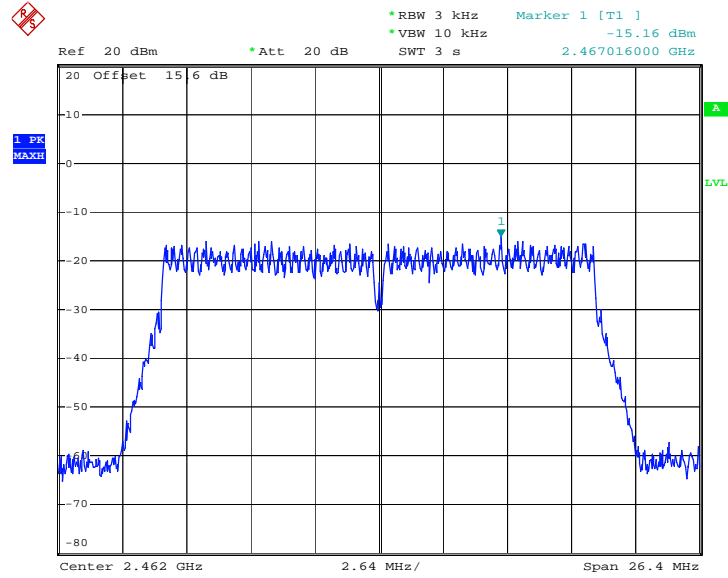

Date: 15.MAR.2013 23:43:08

3.4 Conducted Band Edges and Spurious Emission Measurement

3.4.1 Limit of Conducted Band Edges and Spurious Emission Measurement

In any 100 kHz bandwidth outside of the authorized frequency band, the emissions which fall in the non-restricted bands shall be attenuated at least 20 dB / 30dB relative to the maximum PSD level in 100 kHz by RF conducted measurement and radiated emissions which fall in the restricted bands, as defined in Section 15.205(a), must also comply with the radiated emission limits specified in Section 15.209(a).

3.4.2 Measuring Instruments

See list of measuring instruments of this test report.

3.4.3 Test Procedures

1. The testing follows the Measurement Procedure of FCC KDB No. 558074 DTS D01 Meas. Guidance v02.
2. The RF output of EUT was connected to the spectrum analyzer by RF cable and attenuator. The path loss was compensated to the results for each measurement.
3. Set to the maximum power setting and enable the EUT transmit continuously.
4. Set RBW = 100 KHz, VBW=300 KHz, Peak Detector. Unwanted Emissions measured in any 100 kHz bandwidth outside of the authorized frequency band shall be attenuated by at least 20 dB relative to the maximum in-band peak PSD level in 100 kHz, when maximum peak conducted output power procedure is used. The attenuation is set to 30dB, when maximum conducted output power procedure is used.
5. Measure and record the results in the test report.

3.4.4 Test Setup

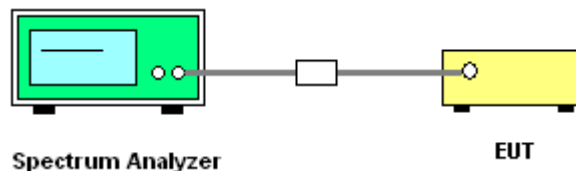

3.4.5 Test Plots of Conducted Band Edges

Test Mode :	802.11b	Temperature :	23~24°C
Test Band :	Low and High	Relative Humidity :	47~48%
Test Channel :	01 and 11	Test Engineer :	Lizy Li

Low Band Edge Plot on 802.11b Channel 01

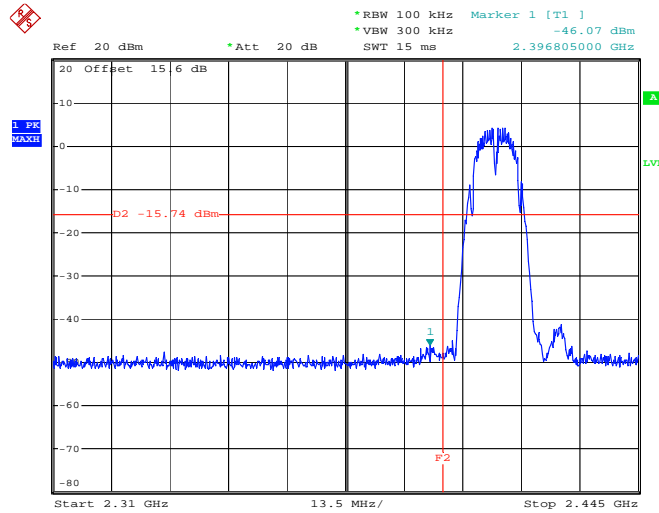

Date: 15.MAR.2013 23:14:36

High Band Edge Plot on 802.11b Channel 11

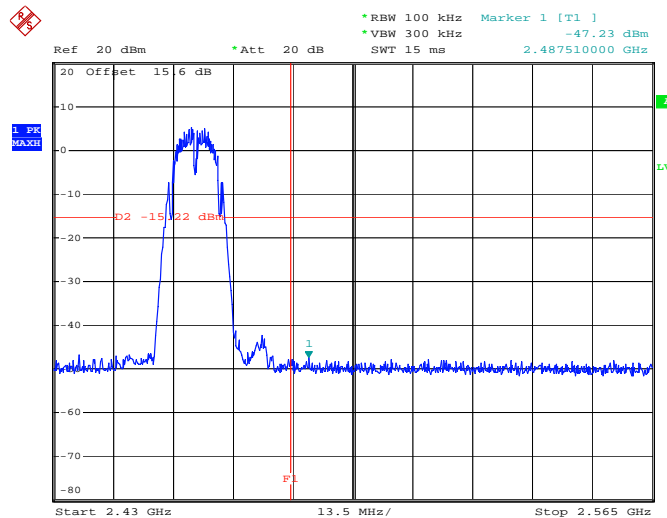

Date: 15.MAR.2013 23:22:34



Test Mode :	802.11g	Temperature :	23~24°C
Test Band :	Low and High	Relative Humidity :	47~48%
Test Channel :	01 and 11	Test Engineer :	Lizy Li

Low Band Edge Plot on 802.11g Channel 01

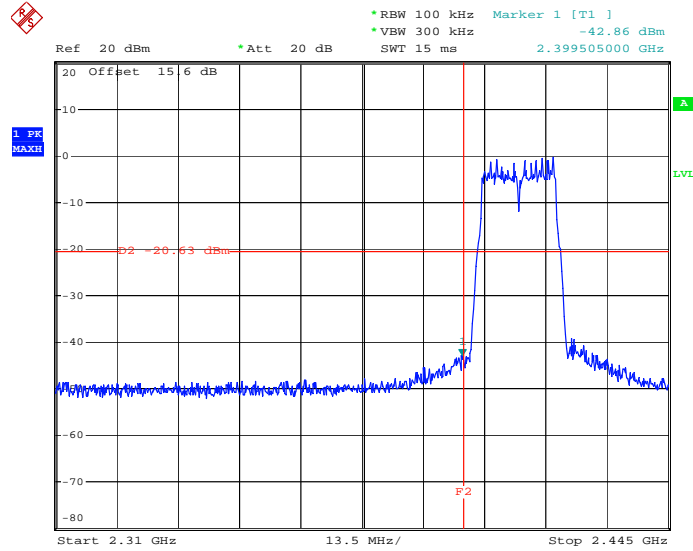

Date: 15.MAR.2013 23:26:25

High Band Edge Plot on 802.11g Channel 11

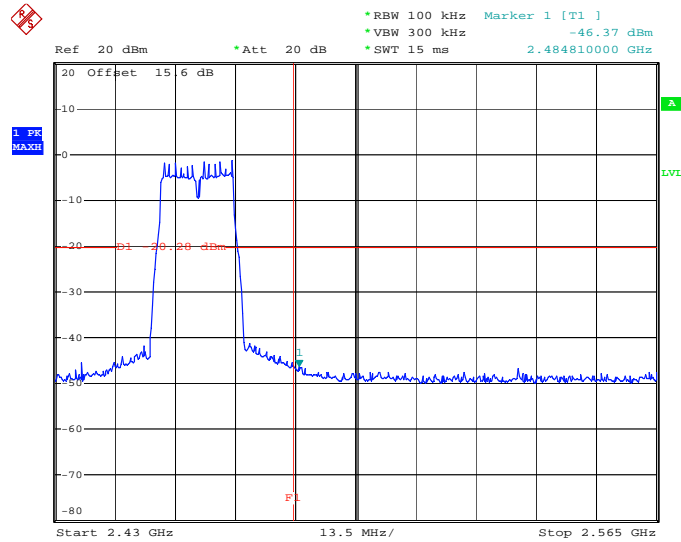

Date: 7.APR.2013 16:41:11



Test Mode :	802.11n HT20	Temperature :	23~24°C
Test Band :	Low and High	Relative Humidity :	47~48%
Test Channel :	01 and 11	Test Engineer :	Lizy Li

Low Band Edge Plot on 802.11n HT20 Channel 01

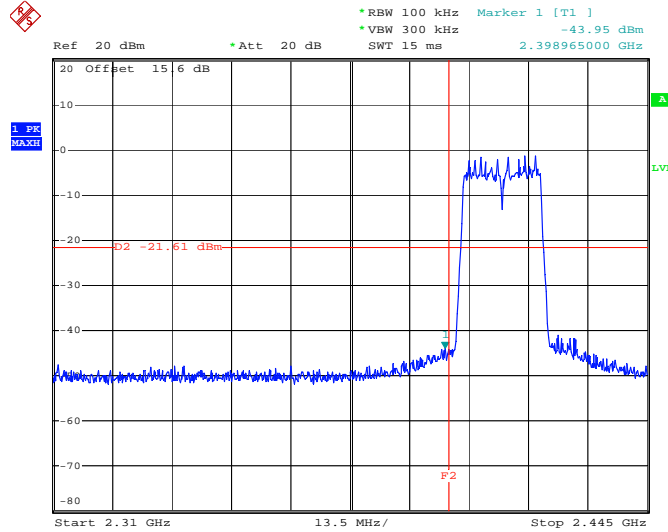

Date: 15.MAR.2013 23:37:44

High Band Edge Plot on 802.11n HT20 Channel 11

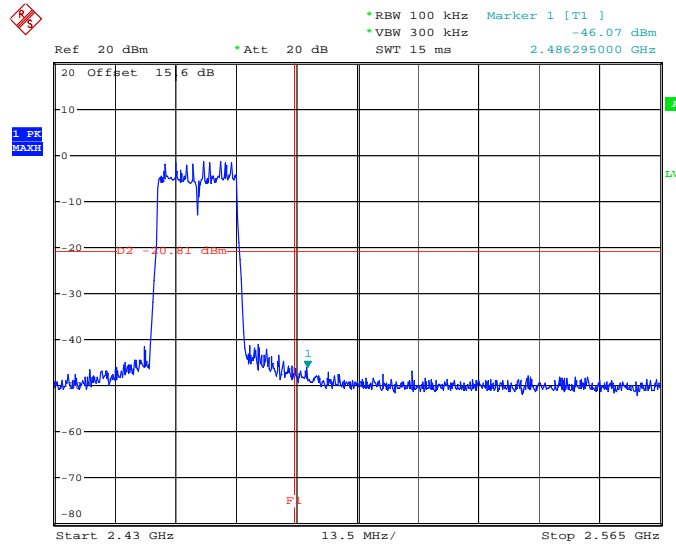

Date: 15.MAR.2013 23:43:34

3.4.6 Test Plots of Spurious Emission

Test Mode :	802.11b	Temperature :	23~24°C
Test Band :	30MHz-3GHz and 2G-25GHz	Relative Humidity :	47~48%
Test Channel :	01, 06, 11	Test Engineer :	Lizy Li

802.11b 30 MHz~3 GHz

Conducted Spurious Emission Plot on Channel 01

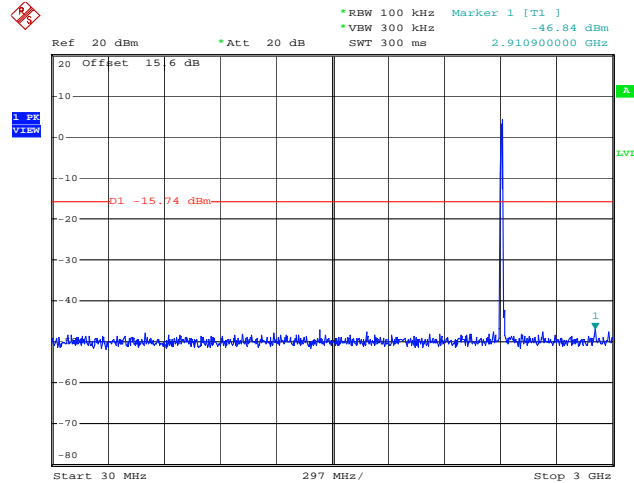

Date: 15.MAR.2013 23:14:54

802.11b 2 GHz~25 GHz

Conducted Spurious Emission Plot on Channel 01

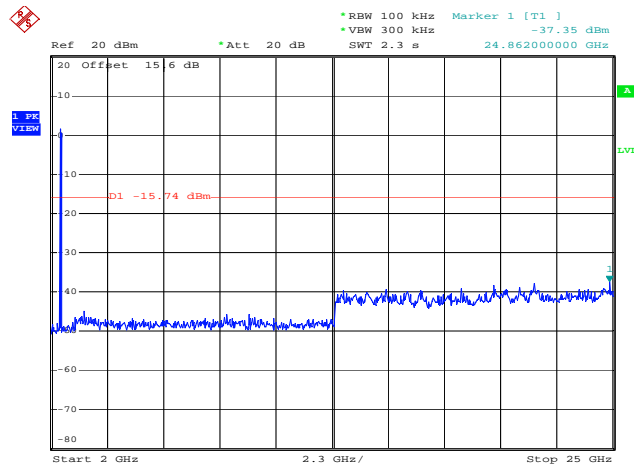

Date: 15.MAR.2013 23:15:13



802.11b 30 MHz~3 GHz

Conducted Spurious Emission Plot on Channel 06

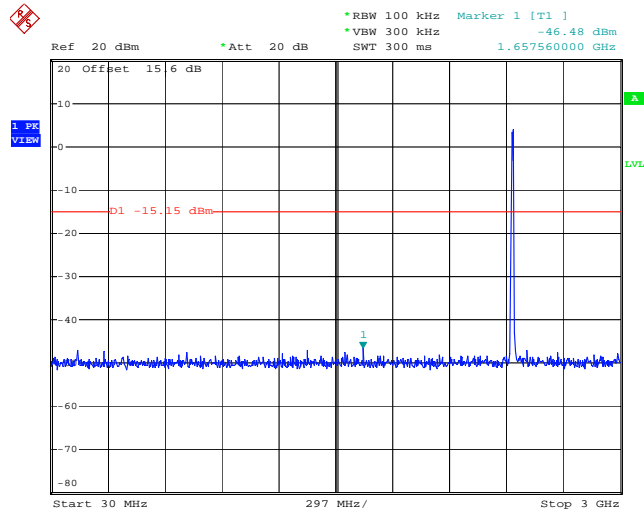

Date: 15.MAR.2013 23:20:03

802.11b 2 GHz~25 GHz

Conducted Spurious Emission Plot on Channel 06

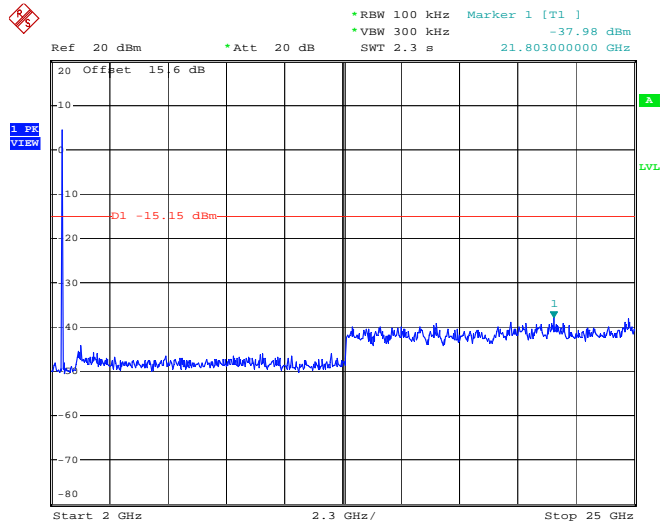

Date: 15.MAR.2013 23:20:22



802.11b 30 MHz~3 GHz

Conducted Spurious Emission Plot on Channel 11

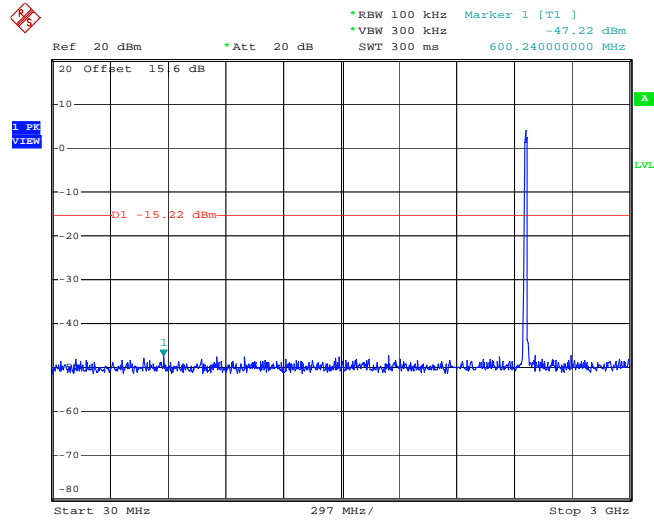

Date: 15.MAR.2013 23:23:54

802.11b 2 GHz~25 GHz

Conducted Spurious Emission Plot on Channel 11

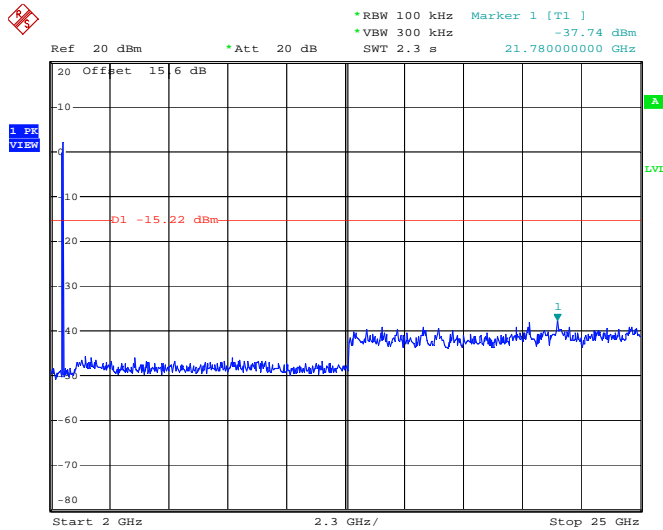

Date: 15.MAR.2013 23:24:12



Test Mode :	802.11g	Temperature :	23~24°C
Test Band :	30MHz-3GHz and 2G-25GHz	Relative Humidity :	47~48%
Test Channel :	01, 06, 11	Test Engineer :	Lizy Li

802.11g 30 MHz~3 GHz

Conducted Spurious Emission Plot on Channel 01

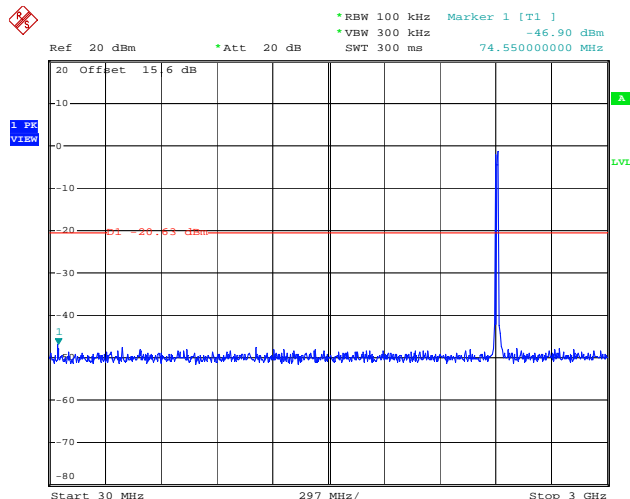

Date: 15.MAR.2013 23:27:42

802.11g 2 GHz~25 GHz

Conducted Spurious Emission Plot on Channel 01

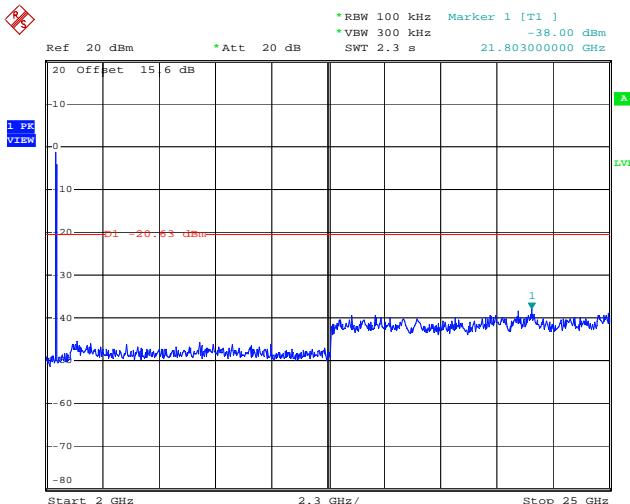

Date: 15.MAR.2013 23:28:01



802.11g 30 MHz~3 GHz

Conducted Spurious Emission Plot on Channel 06

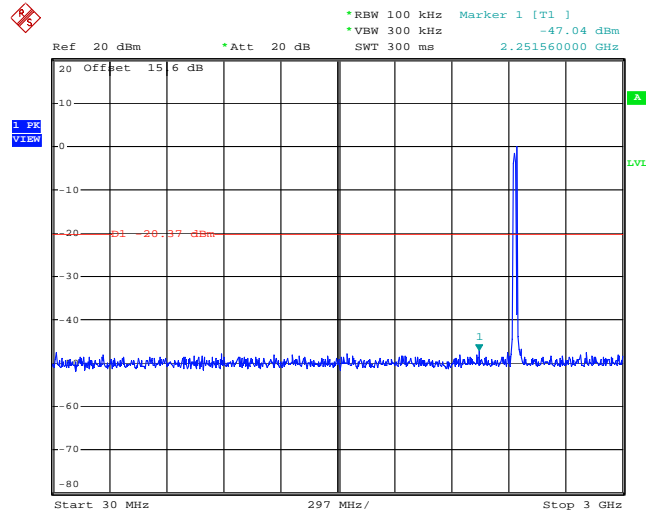

Date: 15.MAR.2013 23:30:22

802.11g 2 GHz~25 GHz

Conducted Spurious Emission Plot on Channel 06

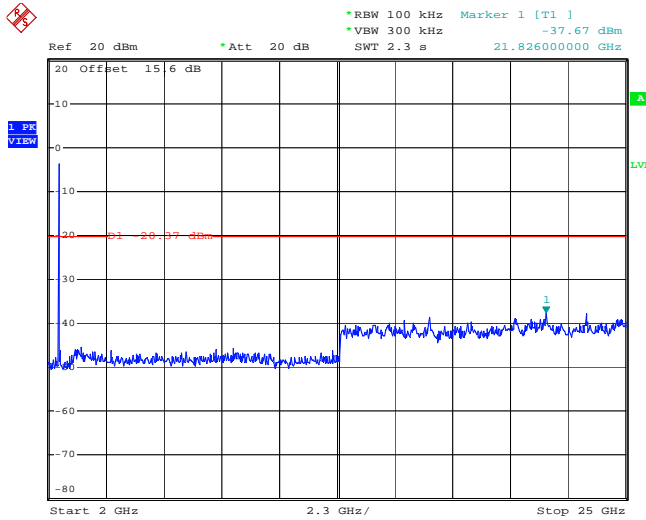

Date: 15.MAR.2013 23:30:40

802.11g 30 MHz~3 GHz

Conducted Spurious Emission Plot on Channel 11

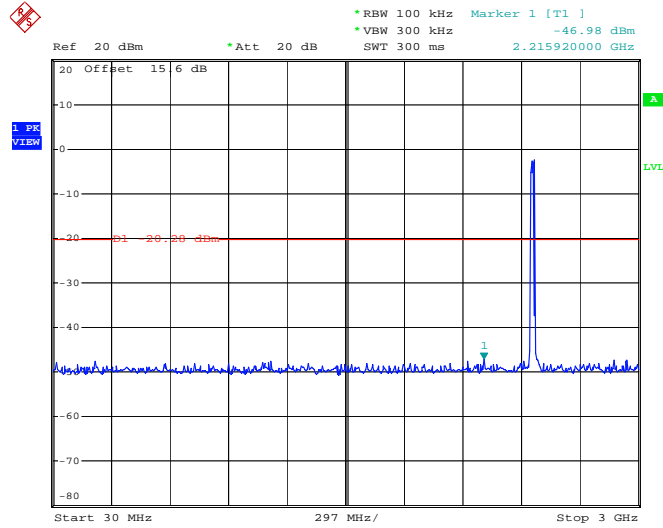

Date: 7.APR.2013 16:43:00

802.11g 2 GHz~25 GHz

Conducted Spurious Emission Plot on Channel 11

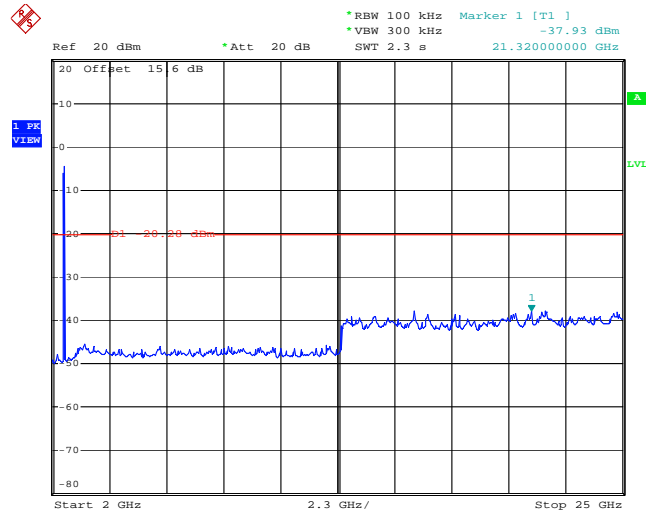

Date: 7.APR.2013 16:43:52



Test Mode :	802.11n HT20	Temperature :	23~24°C
Test Band :	30MHz-3GHz and 2G-25GHz	Relative Humidity :	47~48%
Test Channel :	01, 06, 11	Test Engineer :	Lizy Li

802.11n HT20 30 MHz~3 GHz

Conducted Spurious Emission Plot on Channel 01

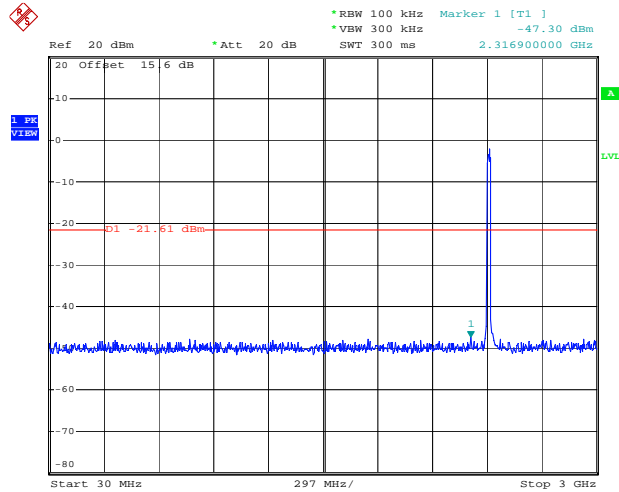

Date: 15.MAR.2013 23:38:03

802.11n HT20 2 GHz~25 GHz

Conducted Spurious Emission Plot on Channel 01

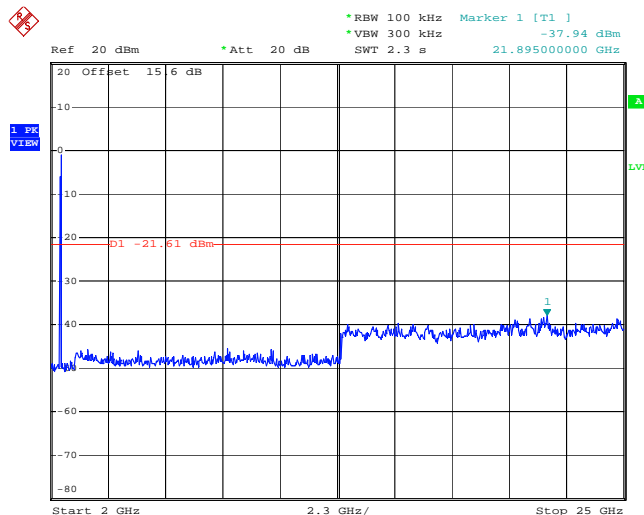

Date: 15.MAR.2013 23:38:21



802.11n HT20 30 MHz~3 GHz

Conducted Spurious Emission Plot on Channel 06

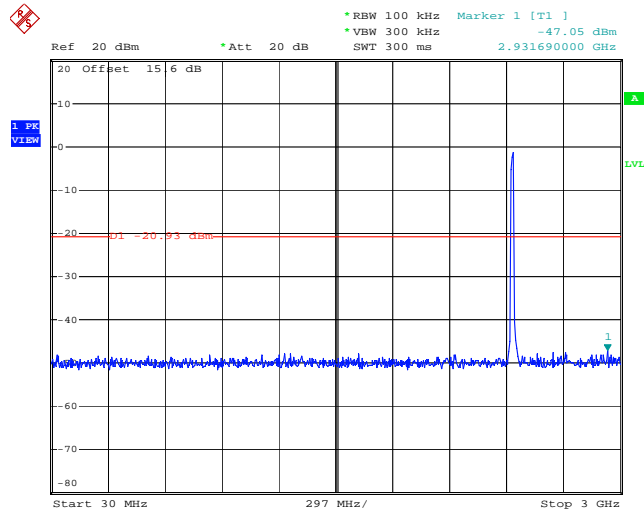

Date: 15.MAR.2013 23:41:09

802.11n HT20 2 GHz~25 GHz

Conducted Spurious Emission Plot on Channel 06

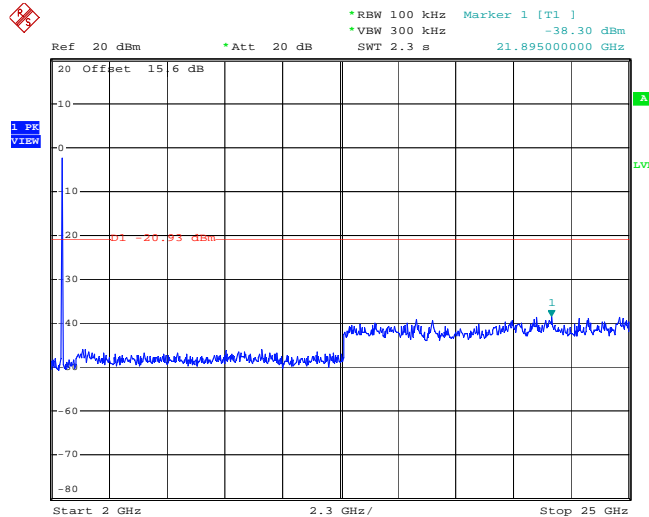

Date: 15.MAR.2013 23:41:27



802.11n HT20 30 MHz~3 GHz

Conducted Spurious Emission Plot on Channel 11

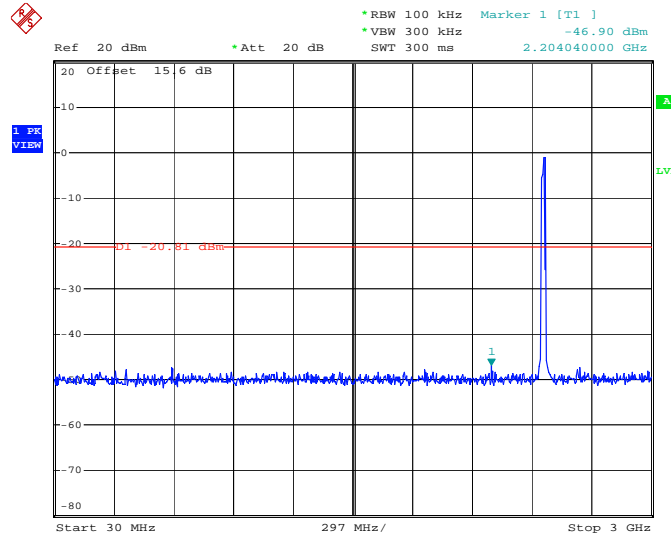

Date: 15.MAR.2013 23:43:52

802.11n HT20 2 GHz~25 GHz

Conducted Spurious Emission Plot on Channel 11

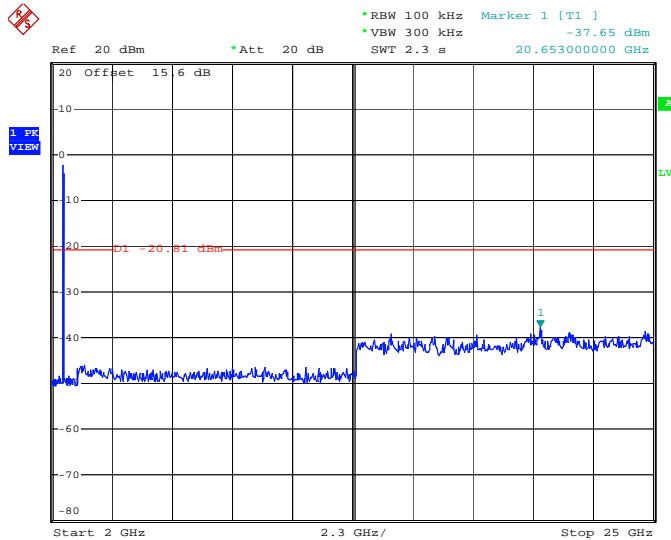

Date: 15.MAR.2013 23:44:11



3.5 Radiated Emission Measurement

3.5.1 Limit of Radiated Emission

In any 100 KHz bandwidth outside the intentional radiator frequency band, all harmonics/spurious must be at least 20 dB below the highest emission level within the authorized band. If the output power of this device was measured by spectrum analyzer, the attenuation under this paragraph shall be 30 dB instead of 20 dB. In addition, radiated emissions which fall in the restricted bands must also comply with the FCC section 15.209 limits as below.

Frequency (MHz)	Field Strength (microvolts/meter)	Measurement Distance (meters)
0.009 – 0.490	2400/F(KHz)	300
0.490 – 1.705	24000/F(KHz)	30
1.705 – 30.0	30	30
30 – 88	100	3
88 – 216	150	3
216 - 960	200	3
Above 960	500	3

3.5.2 Measuring Instruments

See list of measuring instruments of this test report.



3.5.3 Test Procedures

1. The testing follows the guidelines in ANSI C63. 10-2009
2. The EUT was arranged to its worst case and then tune the antenna tower (from 1 m to 4 m) and turntable (from 0 degree to 360 degrees) to find the maximum reading. A pre-amp and a high pass filter are used for the test in order to get better signal level.
3. The EUT was placed on a turntable with 0.8 meter above ground.
4. The EUT was set 3 meters from the interference receiving antenna, which was mounted on the top of a variable height antenna tower.
5. Corrected Reading: Antenna Factor + Cable Loss + Read Level - Preamp Factor = Level
6. For measurement below 1GHz, If the emission level of the EUT measured by the peak detector is 3 dB lower than the applicable limit, the peak emission level will be reported. Otherwise, the emission measurement will be repeated using the quasi-peak detector and reported.
7. Use the following spectrum analyzer settings:
 - (1) Span shall wide enough to fully capture the emission being measured;
 - (2) Set RBW=100 KHz for $f < 1$ GHz; $VBW \geq RBW$; Sweep = auto; Detector function = peak; Trace = max hold;
 - (3) Set RBW = 1 MHz, $VBW = 3$ MHz for $f \geq 1$ GHz for peak measurement.
For average measurement:
 - $VBW = 10$ Hz, when duty cycle is no less than 98 percent.
 - $VBW \geq 1/T$, when duty cycle is less than 98 percent where T is the minimum transmission duration over which the transmitter is on and is transmitting at its maximum power control level for the tested mode of operation.

Band	Duty Cycle(%)	T(ms)	1/T(KHz)	VBW Setting
802.11b	99.057	-	-	10Hz
802.11g	92.667	1.390	0.719	1KHz
2.4G 802.11n HT20	91.796	1.298	0.770	1KHz

Note: For average measurement with duty cycle < 98%, use reduced VBW measurement method 4.2.3.2.3 in ANSI C63.10.

3.5.4 Test Setup

For radiated emissions below 30MHz

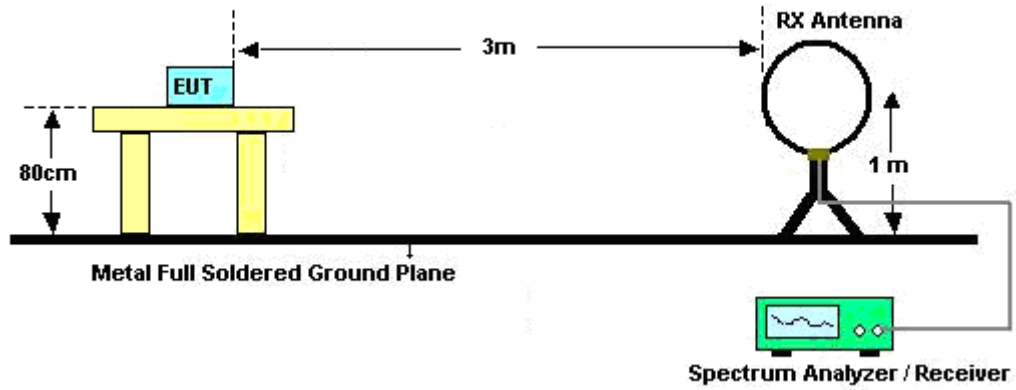

For radiated emissions from 30MHz to 1GHz

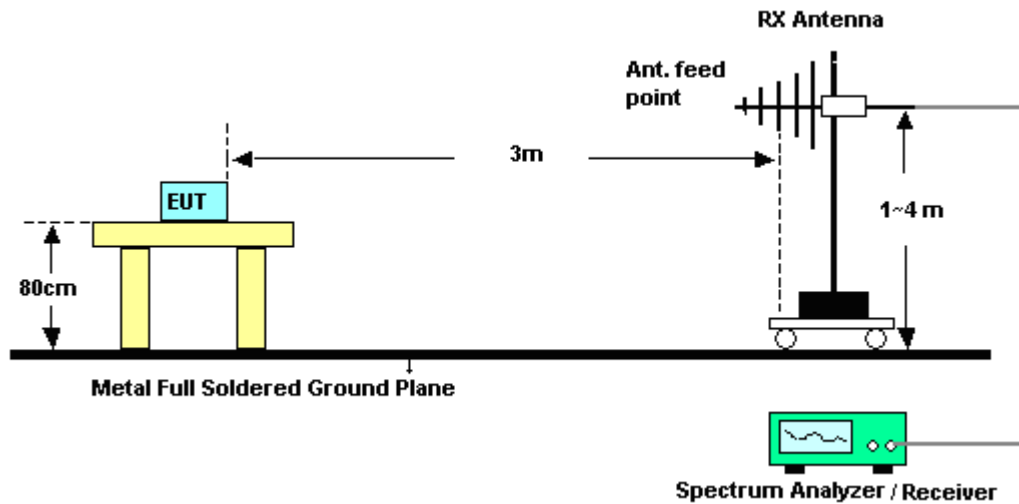

For radiated emissions above 1GHz

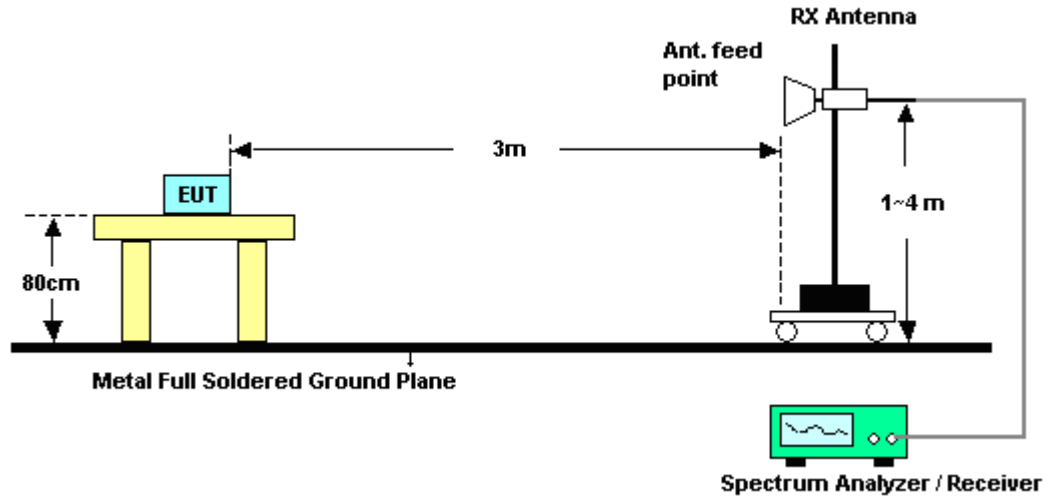

3.5.5 Test Results of Radiated Emissions (9 KHz ~ 30 MHz)

The low frequency, which started from 9 KHz to 30MHz, was pre-scanned and the result which was 20dB lower than the limit line per 15.31(o) was not reported.

3.5.6 Test Result of Radiated Band Edges

Test Mode :	802.11b + USB Cable 1 (Charging from Adapter 1) + Battery 1 + Earphone for Sample 1	Temperature :	21~23°C
Test Band :	Low	Relative Humidity :	51~53%
Test Channel :	01	Test Engineer :	Beer Huang

ANTENNA POLARITY : HORIZONTAL										
Frequency (MHz)	Level (dBμV/m)	Over Limit (dB)	Limit Line (dBμV/m)	Read Level (dBμV)	Antenna Factor (dB)	Cable Loss (dB)	Preamp Factor (dB)	Ant Pos (cm)	Table Pos (deg)	Remark
2384.88	58.67	-15.33	74	53.75	32.28	6.91	34.27	132	346	Peak
2386.32	45.96	-8.04	54	41.02	32.3	6.91	34.27	132	346	Average

ANTENNA POLARITY : VERTICAL										
Frequency (MHz)	Level (dBμV/m)	Over Limit (dB)	Limit Line (dBμV/m)	Read Level (dBμV)	Antenna Factor (dB)	Cable Loss (dB)	Preamp Factor (dB)	Ant Pos (cm)	Table Pos (deg)	Remark
2386.59	57.06	-16.94	74	52.12	32.3	6.91	34.27	100	255	Peak
2386.59	44.65	-9.35	54	39.71	32.3	6.91	34.27	100	255	Average

Test Mode :	802.11b + USB Cable 1 (Charging from Adapter 1) + Battery 1 + Earphone for Sample 1	Temperature :	21~23°C
Test Band :	High	Relative Humidity :	51~53%
Test Channel :	11	Test Engineer :	Beer Huang

ANTENNA POLARITY : HORIZONTAL										
Frequency (MHz)	Level (dBμV/m)	Over Limit (dB)	Limit Line (dBμV/m)	Read Level (dBμV)	Antenna Factor (dB)	Cable Loss (dB)	Preamp Factor (dB)	Ant Pos (cm)	Table Pos (deg)	Remark
2485.81	58.51	-15.49	74	53.5	32.38	7.06	34.43	126	349	Peak
2483.56	45.49	-8.51	54	40.48	32.38	7.06	34.43	126	349	Average

ANTENNA POLARITY : VERTICAL										
Frequency (MHz)	Level (dBμV/m)	Over Limit (dB)	Limit Line (dBμV/m)	Read Level (dBμV)	Antenna Factor (dB)	Cable Loss (dB)	Preamp Factor (dB)	Ant Pos (cm)	Table Pos (deg)	Remark
2494.84	57.32	-16.68	74	52.34	32.4	7.06	34.48	100	256	Peak
2483.5	44.41	-9.59	54	39.4	32.38	7.06	34.43	100	256	Average



Test Mode :	802.11g + USB Cable 1 (Charging from Adapter 1) + Battery 1 + Earphone for Sample 1	Temperature :	21~23°C
Test Band :	Low	Relative Humidity :	51~53%
Test Channel :	01	Test Engineer :	Beer Huang

ANTENNA POLARITY : HORIZONTAL										
Frequency (MHz)	Level (dBμV/m)	Over Limit (dB)	Limit Line (dBμV/m)	Read Level (dBμV)	Antenna Factor (dB)	Cable Loss (dB)	Preamp Factor (dB)	Ant Pos (cm)	Table Pos (deg)	Remark
2388.12	70.74	-3.26	74	65.8	32.3	6.91	34.27	104	348	Peak
2390	48.72	-5.28	54	43.81	32.3	6.91	34.3	104	348	Average

ANTENNA POLARITY : VERTICAL										
Frequency (MHz)	Level (dBμV/m)	Over Limit (dB)	Limit Line (dBμV/m)	Read Level (dBμV)	Antenna Factor (dB)	Cable Loss (dB)	Preamp Factor (dB)	Ant Pos (cm)	Table Pos (deg)	Remark
2380.29	67.64	-6.36	74	62.72	32.28	6.91	34.27	102	255	Peak
2389.83	46.65	-7.35	54	41.74	32.3	6.91	34.3	102	255	Average

Test Mode :	802.11g + USB Cable 1 (Charging from Adapter 1) + Battery 1 + Earphone for Sample 1	Temperature :	21~23°C
Test Band :	High	Relative Humidity :	51~53%
Test Channel :	11	Test Engineer :	Beer Huang

ANTENNA POLARITY : HORIZONTAL										
Frequency (MHz)	Level (dBμV/m)	Over Limit (dB)	Limit Line (dBμV/m)	Read Level (dBμV)	Antenna Factor (dB)	Cable Loss (dB)	Preamp Factor (dB)	Ant Pos (cm)	Table Pos (deg)	Remark
2484.28	70.49	-3.51	74	65.48	32.38	7.06	34.43	127	342	Peak
2483.53	49.63	-4.37	54	44.62	32.38	7.06	34.43	127	342	Average

ANTENNA POLARITY : VERTICAL										
Frequency (MHz)	Level (dBμV/m)	Over Limit (dB)	Limit Line (dBμV/m)	Read Level (dBμV)	Antenna Factor (dB)	Cable Loss (dB)	Preamp Factor (dB)	Ant Pos (cm)	Table Pos (deg)	Remark
2484.46	66.82	-7.18	74	61.81	32.38	7.06	34.43	100	256	Peak
2483.59	47.07	-6.93	54	42.06	32.38	7.06	34.43	100	256	Average



Test Mode :	802.11n HT20 + USB Cable 1 (Charging from Adapter 1) + Battery 1 + Earphone for Sample 1	Temperature :	21~23°C
Test Band :	Low	Relative Humidity :	51~53%
Test Channel :	01	Test Engineer :	Beer Huang

ANTENNA POLARITY : HORIZONTAL										
Frequency (MHz)	Level (dBμV/m)	Over Limit (dB)	Limit Line (dBμV/m)	Read Level (dBμV)	Antenna Factor (dB)	Cable Loss (dB)	Preamp Factor (dB)	Ant Pos (cm)	Table Pos (deg)	Remark
2388.03	70.89	-3.11	74	65.95	32.3	6.91	34.27	103	347	Peak
2390	49.27	-4.73	54	44.36	32.3	6.91	34.3	103	347	Average

ANTENNA POLARITY : VERTICAL										
Frequency (MHz)	Level (dBμV/m)	Over Limit (dB)	Limit Line (dBμV/m)	Read Level (dBμV)	Antenna Factor (dB)	Cable Loss (dB)	Preamp Factor (dB)	Ant Pos (cm)	Table Pos (deg)	Remark
2385.15	66.74	-7.26	74	61.82	32.28	6.91	34.27	100	254	Peak
2390	46.57	-7.43	54	41.66	32.3	6.91	34.3	100	254	Average

Test Mode :	802.11n HT20 + USB Cable 1 (Charging from Adapter 1) + Battery 1 + Earphone for Sample 1	Temperature :	21~23°C
Test Band :	High	Relative Humidity :	51~53%
Test Channel :	11	Test Engineer :	Beer Huang

ANTENNA POLARITY : HORIZONTAL										
Frequency (MHz)	Level (dBμV/m)	Over Limit (dB)	Limit Line (dBμV/m)	Read Level (dBμV)	Antenna Factor (dB)	Cable Loss (dB)	Preamp Factor (dB)	Ant Pos (cm)	Table Pos (deg)	Remark
2483.95	70.73	-3.27	74	65.72	32.38	7.06	34.43	155	344	Peak
2483.74	49.02	-4.98	54	44.01	32.38	7.06	34.43	155	344	Average

ANTENNA POLARITY : VERTICAL										
Frequency (MHz)	Level (dBμV/m)	Over Limit (dB)	Limit Line (dBμV/m)	Read Level (dBμV)	Antenna Factor (dB)	Cable Loss (dB)	Preamp Factor (dB)	Ant Pos (cm)	Table Pos (deg)	Remark
2483.53	63.6	-10.4	74	58.59	32.38	7.06	34.43	100	254	Peak
2483.68	46.05	-7.95	54	41.04	32.38	7.06	34.43	100	254	Average



Test Mode :	802.11n HT20 + USB Cable 2 (Charging from Adapter 2) + Battery 2 + Earphone for Sample 2	Temperature :	21~23°C
Test Band :	Low	Relative Humidity :	51~53%
Test Channel :	01	Test Engineer :	Beer Huang

ANTENNA POLARITY : HORIZONTAL										
Frequency (MHz)	Level (dBμV/m)	Over Limit (dB)	Limit Line (dBμV/m)	Read Level (dBμV)	Antenna Factor (dB)	Cable Loss (dB)	Preamp Factor (dB)	Ant Pos (cm)	Table Pos (deg)	Remark
2385.15	70	-4	74	65.08	32.28	6.91	34.27	106	282	Peak
2390	49.46	-4.54	54	44.55	32.3	6.91	34.3	106	282	Average

ANTENNA POLARITY : VERTICAL										
Frequency (MHz)	Level (dBμV/m)	Over Limit (dB)	Limit Line (dBμV/m)	Read Level (dBμV)	Antenna Factor (dB)	Cable Loss (dB)	Preamp Factor (dB)	Ant Pos (cm)	Table Pos (deg)	Remark
2381.73	66.66	-7.34	74	61.74	32.28	6.91	34.27	100	268	Peak
2390	46.09	-7.91	54	41.18	32.3	6.91	34.3	100	268	Average

3.5.7 Test Result of Radiated Emission (30 MHz ~ 10th Harmonic)

NOTE: Below 1GHz for radiated emission measurement, pre-scanned all test modes and only choose the worst case mode was recorded in the report.

Test Mode :	802.11b + USB Cable 1 (Charging from Adapter 1) + Battery 1 + Earphone for Sample 1	Temperature :	21~23°C
Test Channel :	01	Relative Humidity :	51~53%
Test Engineer :	Beer Huang	Polarization :	Horizontal
Remark :	1. 2412 MHz is fundamental signal which can be ignored. 2. 7236 MHz is not within a restricted band, and its limit line is 20dB below the highest emission level. For example, 112.39 dBuV/m - 20dB = 92.39 dBuV/m. 3. Average measurement was not performed if peak level went lower than the average limit.		

Frequency (MHz)	Level (dBμV/m)	Over Limit (dB)	Limit Line (dBμV/m)	Read Level (dBμV)	Antenna Factor (dB)	Cable Loss (dB)	Preamp Factor (dB)	Ant Pos (cm)	Table Pos (deg)	Remark
42.96	20.96	-19.04	40	40.37	11.7	0.64	31.75	-	-	Peak
129.9	18.77	-24.73	43.5	37.59	11.6	1.15	31.57	-	-	Peak
260.04	30.62	-15.38	46	47.55	12.74	1.59	31.26	-	-	Peak
519.8	38.09	-7.91	46	48.21	18.43	2.49	31.04	118	24	Peak
715.1	35.55	-10.45	46	42.25	20.82	2.98	30.5	-	-	Peak
780.2	36.5	-9.5	46	41.91	21.79	3.11	30.31	-	-	Peak
2412	107.03	-	-	102.07	32.31	6.95	34.3	132	346	Average
2412	112.39	-	-	107.43	32.31	6.95	34.3	132	346	Peak
4824	42.98	-31.02	74	57.71	33.97	8.77	57.47	100	0	Peak
7236	42.19	-50.2	92.39	53.79	35.55	10.83	57.98	100	0	Peak



Test Mode :	802.11b + USB Cable 1 (Charging from Adapter 1) + Battery 1 + Earphone for Sample 1	Temperature :	21~23°C
Test Channel :	01	Relative Humidity :	51~53%
Test Engineer :	Beer Huang	Polarization :	Vertical
Remark :	1. 2412 MHz is fundamental signal which can be ignored. 2. 7236 MHz is not within a restricted band, and its limit line is 20dB below the highest emission level. 3. Average measurement was not performed if peak level went lower than the average limit.		

Frequency (MHz)	Level (dBμV/m)	Over Limit (dB)	Limit Line (dBμV/m)	Read Level (dBμV)	Antenna Factor (dB)	Cable Loss (dB)	Preamp Factor (dB)	Ant Pos (cm)	Table Pos (deg)	Remark
72.12	17.69	-22.31	40	42.07	6.55	0.84	31.77	-	-	Peak
95.88	17	-26.5	43.5	38.37	9.32	0.98	31.67	-	-	Peak
260.04	23.4	-22.6	46	40.33	12.74	1.59	31.26	-	-	Peak
519.8	32.81	-13.19	46	42.93	18.43	2.49	31.04	123	58	Peak
584.9	31.21	-14.79	46	39.78	19.54	2.65	30.76	-	-	Peak
975.5	31.91	-22.09	54	34.81	24.24	3.49	30.63	-	-	Peak
2412	102.75	-	-	97.79	32.31	6.95	34.3	100	255	Average
2412	108.13	-	-	103.17	32.31	6.95	34.3	100	255	Peak
4824	42.51	-31.49	74	57.24	33.97	8.77	57.47	100	0	Peak
7236	42.37	-45.76	88.13	53.97	35.55	10.83	57.98	100	0	Peak



Test Mode :	802.11b + USB Cable 1 (Charging from Adapter 1) + Battery 1 + Earphone for Sample 1	Temperature :	21~23°C
Test Channel :	06	Relative Humidity :	51~53%
Test Engineer :	Beer Huang	Polarization :	Horizontal
Remark :	1. 2437 MHz is fundamental signal which can be ignored. 2. Average measurement was not performed if peak level went lower than the average limit.		

Frequency (MHz)	Level (dBμV/m)	Over Limit (dB)	Limit Line (dBμV/m)	Read Level (dBμV)	Antenna Factor (dB)	Cable Loss (dB)	Preamp Factor (dB)	Ant Pos (cm)	Table Pos (deg)	Remark
2437	107.44	-	-	102.45	32.35	6.99	34.35	129	345	Average
2437	112.74	-	-	107.75	32.35	6.99	34.35	129	345	Peak
4875	41.68	-32.32	74	56.39	33.95	8.82	57.48	100	0	Peak
7311	40.97	-33.03	74	52.54	35.54	10.91	58.02	100	0	Peak

Test Mode :	802.11b + USB Cable 1 (Charging from Adapter 1) + Battery 1 + Earphone for Sample 1	Temperature :	21~23°C
Test Channel :	06	Relative Humidity :	51~53%
Test Engineer :	Beer Huang	Polarization :	Vertical
Remark :	1. 2437 MHz is fundamental signal which can be ignored. 2. Average measurement was not performed if peak level went lower than the average limit.		

Frequency (MHz)	Level (dBμV/m)	Over Limit (dB)	Limit Line (dBμV/m)	Read Level (dBμV)	Antenna Factor (dB)	Cable Loss (dB)	Preamp Factor (dB)	Ant Pos (cm)	Table Pos (deg)	Remark
2437	102.95	-	-	97.96	32.35	6.99	34.35	100	257	Average
2437	108.22	-	-	103.23	32.35	6.99	34.35	100	257	Peak
4875	39.55	-34.45	74	56.56	33.95	8.82	59.78	100	0	Peak
7311	39.92	-34.08	74	52.92	35.54	10.91	59.45	100	0	Peak



Test Mode :	802.11b + USB Cable 1 (Charging from Adapter 1) + Battery 1 + Earphone for Sample 1	Temperature :	21~23°C
Test Channel :	11	Relative Humidity :	51~53%
Test Engineer :	Beer Huang	Polarization :	Horizontal
Remark :	1. 2462 MHz is fundamental signal which can be ignored. 2. Average measurement was not performed if peak level went lower than the average limit.		

Frequency (MHz)	Level (dBμV/m)	Over Limit (dB)	Limit Line (dBμV/m)	Read Level (dBμV)	Antenna Factor (dB)	Cable Loss (dB)	Preamp Factor (dB)	Ant Pos (cm)	Table Pos (deg)	Remark
2462	106.03	-	-	101.03	32.37	7.02	34.39	126	349	Average
2462	111.47	-	-	106.47	32.37	7.02	34.39	126	349	Peak
4923	41.24	-32.76	74	55.92	33.93	8.87	57.48	100	0	Peak
7386	42.26	-31.74	74	53.83	35.52	10.99	58.08	100	0	Peak

Test Mode :	802.11b + USB Cable 1 (Charging from Adapter 1) + Battery 1 + Earphone for Sample 1	Temperature :	21~23°C
Test Channel :	11	Relative Humidity :	51~53%
Test Engineer :	Beer Huang	Polarization :	Vertical
Remark :	1. 2462 MHz is fundamental signal which can be ignored. 2. Average measurement was not performed if peak level went lower than the average limit.		

Frequency (MHz)	Level (dBμV/m)	Over Limit (dB)	Limit Line (dBμV/m)	Read Level (dBμV)	Antenna Factor (dB)	Cable Loss (dB)	Preamp Factor (dB)	Ant Pos (cm)	Table Pos (deg)	Remark
2462	101.85	-	-	96.85	32.37	7.02	34.39	100	256	Average
2462	106.95	-	-	101.95	32.37	7.02	34.39	100	256	Peak
4923	39.86	-34.14	74	56.64	33.93	8.87	59.58	100	0	Peak
7386	40	-34	74	53.01	35.52	10.99	59.52	100	0	Peak



Test Mode :	802.11g + USB Cable 1 (Charging from Adapter 1) + Battery 1 + Earphone for Sample 1	Temperature :	21~23°C
Test Channel :	01	Relative Humidity :	51~53%
Test Engineer :	Beer Huang	Polarization :	Horizontal
Remark :	1. 2412 MHz is fundamental signal which can be ignored. 2. 7236 MHz is not within a restricted band, and its limit line is 20dB below the highest emission level. 3. Average measurement was not performed if peak level went lower than the average limit.		

Frequency (MHz)	Level (dBμV/m)	Over Limit (dB)	Limit Line (dBμV/m)	Read Level (dBμV)	Antenna Factor (dB)	Cable Loss (dB)	Preamp Factor (dB)	Ant Pos (cm)	Table Pos (deg)	Remark
42.96	14.22	-25.78	40	33.63	11.7	0.64	31.75	-	-	Peak
129.9	16.08	-27.42	43.5	34.9	11.6	1.15	31.57	-	-	Peak
260.04	29.71	-16.29	46	46.64	12.74	1.59	31.26	-	-	Peak
389.6	33.54	-12.46	46	47.09	15.74	2.12	31.41	-	-	Peak
715.1	35.94	-10.06	46	42.64	20.82	2.98	30.5	-	-	Peak
780.2	37.71	-8.29	46	43.12	21.79	3.11	30.31	241	39	Peak
2412	100.6	-	-	95.64	32.31	6.95	34.3	104	348	Average
2412	109.91	-	-	104.95	32.31	6.95	34.3	104	348	Peak
4824	41.83	-32.17	74	56.56	33.97	8.77	57.47	100	0	Peak
7236	42.35	-47.56	89.91	53.95	35.55	10.83	57.98	100	0	Peak



Test Mode :	802.11g + USB Cable 1 (Charging from Adapter 1) + Battery 1 + Earphone for Sample 1	Temperature :	21~23°C
Test Channel :	01	Relative Humidity :	51~53%
Test Engineer :	Beer Huang	Polarization :	Vertical
Remark :	1. 2412 MHz is fundamental signal which can be ignored. 2. 7236 MHz is not within a restricted band, and its limit line is 20dB below the highest emission level. 3. Average measurement was not performed if peak level went lower than the average limit.		

Frequency (MHz)	Level (dBμV/m)	Over Limit (dB)	Limit Line (dBμV/m)	Read Level (dBμV)	Antenna Factor (dB)	Cable Loss (dB)	Preamp Factor (dB)	Ant Pos (cm)	Table Pos (deg)	Remark
39.45	20.43	-19.57	40	38.12	13.5	0.62	31.81	-	-	Peak
96.42	18.42	-25.08	43.5	39.79	9.32	0.98	31.67	-	-	Peak
260.04	22.89	-23.11	46	39.82	12.74	1.59	31.26	-	-	Peak
519.8	33.15	-12.85	46	43.27	18.43	2.49	31.04	105	41	Peak
584.9	30.42	-15.58	46	38.99	19.54	2.65	30.76	-	-	Peak
975.5	32.05	-21.95	54	34.95	24.24	3.49	30.63	-	-	Peak
2412	95.93	-	-	90.97	32.31	6.95	34.3	102	255	Average
2412	105.88	-	-	100.92	32.31	6.95	34.3	102	255	Peak
4824	39.59	-34.41	74	56.84	33.97	8.77	59.99	100	0	Peak
7236	40.21	-45.67	85.88	53.22	35.55	10.83	59.39	100	0	Peak



Test Mode :	802.11g + USB Cable 1 (Charging from Adapter 1) + Battery 1 + Earphone for Sample 1	Temperature :	21~23°C
Test Channel :	06	Relative Humidity :	51~53%
Test Engineer :	Beer Huang	Polarization :	Horizontal
Remark :	1. 2437 MHz is fundamental signal which can be ignored. 2. Average measurement was not performed if peak level went lower than the average limit.		

Frequency (MHz)	Level (dBμV/m)	Over Limit (dB)	Limit Line (dBμV/m)	Read Level (dBμV)	Antenna Factor (dB)	Cable Loss (dB)	Preamp Factor (dB)	Ant Pos (cm)	Table Pos (deg)	Remark
2437	102.13	-	-	97.14	32.35	6.99	34.35	102	348	Average
2437	112.25	-	-	107.26	32.35	6.99	34.35	102	348	Peak
4875	41.31	-32.69	74	56.02	33.95	8.82	57.48	100	0	Peak
7311	42.04	-31.96	74	53.61	35.54	10.91	58.02	100	0	Peak

Test Mode :	802.11g + USB Cable 1 (Charging from Adapter 1) + Battery 1 + Earphone for Sample 1	Temperature :	21~23°C
Test Channel :	06	Relative Humidity :	51~53%
Test Engineer :	Beer Huang	Polarization :	Vertical
Remark :	1. 2437 MHz is fundamental signal which can be ignored. 2. Average measurement was not performed if peak level went lower than the average limit.		

Frequency (MHz)	Level (dBμV/m)	Over Limit (dB)	Limit Line (dBμV/m)	Read Level (dBμV)	Antenna Factor (dB)	Cable Loss (dB)	Preamp Factor (dB)	Ant Pos (cm)	Table Pos (deg)	Remark
2437	96.77	-	-	91.78	32.35	6.99	34.35	100	254	Average
2437	106.63	-	-	101.64	32.35	6.99	34.35	100	254	Peak
4875	39.84	-34.16	74	56.85	33.95	8.82	59.78	100	0	Peak
7311	40.12	-33.88	74	53.12	35.54	10.91	59.45	100	0	Peak



Test Mode :	802.11g + USB Cable 1 (Charging from Adapter 1) + Battery 1 + Earphone for Sample 1	Temperature :	21~23°C
Test Channel :	11	Relative Humidity :	51~53%
Test Engineer :	Beer Huang	Polarization :	Horizontal
Remark :	1. 2462 MHz is fundamental signal which can be ignored. 2. Average measurement was not performed if peak level went lower than the average limit.		

Frequency (MHz)	Level (dBμV/m)	Over Limit (dB)	Limit Line (dBμV/m)	Read Level (dBμV)	Antenna Factor (dB)	Cable Loss (dB)	Preamp Factor (dB)	Ant Pos (cm)	Table Pos (deg)	Remark
2462	100.56	-	-	95.56	32.37	7.02	34.39	127	342	Average
2462	110.92	-	-	105.92	32.37	7.02	34.39	127	342	Peak
4923	41.28	-32.72	74	55.96	33.93	8.87	57.48	100	0	Peak
7386	41.85	-32.15	74	53.42	35.52	10.99	58.08	100	0	Peak

Test Mode :	802.11g + USB Cable 1 (Charging from Adapter 1) + Battery 1 + Earphone for Sample 1	Temperature :	21~23°C
Test Channel :	11	Relative Humidity :	51~53%
Test Engineer :	Beer Huang	Polarization :	Vertical
Remark :	1. 2462 MHz is fundamental signal which can be ignored. 2. Average measurement was not performed if peak level went lower than the average limit.		

Frequency (MHz)	Level (dBμV/m)	Over Limit (dB)	Limit Line (dBμV/m)	Read Level (dBμV)	Antenna Factor (dB)	Cable Loss (dB)	Preamp Factor (dB)	Ant Pos (cm)	Table Pos (deg)	Remark
2462	95.7	-	-	90.7	32.37	7.02	34.39	100	256	Average
2462	105.84	-	-	100.84	32.37	7.02	34.39	100	256	Peak
4923	38.96	-35.04	74	55.74	33.93	8.87	59.58	100	0	Peak
7386	40.98	-33.02	74	53.99	35.52	10.99	59.52	100	0	Peak



Test Mode :	802.11n HT20 + USB Cable 1 (Charging from Adapter 1) + Battery 1 + Earphone for Sample 1	Temperature :	21~23°C
Test Channel :	01	Relative Humidity :	51~53%
Test Engineer :	Beer Huang	Polarization :	Horizontal
Remark :	1. 2412 MHz is fundamental signal which can be ignored. 2. 7236 MHz is not within a restricted band, and its limit line is 20dB below the highest emission level. 3. Average measurement was not performed if peak level went lower than the average limit.		

Frequency (MHz)	Level (dBμV/m)	Over Limit (dB)	Limit Line (dBμV/m)	Read Level (dBμV)	Antenna Factor (dB)	Cable Loss (dB)	Preamp Factor (dB)	Ant Pos (cm)	Table Pos (deg)	Remark
42.96	20	-20	40	39.41	11.7	0.64	31.75	-	-	Peak
169.86	19.44	-24.06	43.5	39.92	9.57	1.23	31.28	-	-	Peak
260.04	29.34	-16.66	46	46.27	12.74	1.59	31.26	-	-	Peak
389.6	32.28	-13.72	46	45.83	15.74	2.12	31.41	-	-	Peak
519.8	30.15	-15.85	46	40.27	18.43	2.49	31.04	-	-	Peak
780.2	36.26	-9.74	46	41.67	21.79	3.11	30.31	123	85	Peak
2412	99.79	-	-	94.83	32.31	6.95	34.3	103	347	Average
2412	109.82	-	-	104.86	32.31	6.95	34.3	103	347	Peak
4824	41.35	-32.65	74	56.08	33.97	8.77	57.47	100	0	Peak
7236	41.85	-47.97	89.82	53.45	35.55	10.83	57.98	100	0	Peak



Test Mode :	802.11n HT20 + USB Cable 1 (Charging from Adapter 1) + Battery 1 + Earphone for Sample 1	Temperature :	21~23°C
Test Channel :	01	Relative Humidity :	51~53%
Test Engineer :	Beer Huang	Polarization :	Vertical
Remark :	1. 2412 MHz is fundamental signal which can be ignored. 2. 7236 MHz is not within a restricted band, and its limit line is 20dB below the highest emission level. 3. Average measurement was not performed if peak level went lower than the average limit.		

Frequency (MHz)	Level (dBμV/m)	Over Limit (dB)	Limit Line (dBμV/m)	Read Level (dBμV)	Antenna Factor (dB)	Cable Loss (dB)	Preamp Factor (dB)	Ant Pos (cm)	Table Pos (deg)	Remark
39.72	18.58	-21.42	40	36.25	13.5	0.62	31.79	-	-	Peak
72.12	18.65	-21.35	40	43.03	6.55	0.84	31.77	-	-	Peak
260.04	22.2	-23.8	46	39.13	12.74	1.59	31.26	-	-	Peak
454.7	23.64	-22.36	46	35.34	17.15	2.31	31.16	-	-	Peak
519.8	32.57	-13.43	46	42.69	18.43	2.49	31.04	108	127	Peak
975.5	32.33	-21.67	54	35.23	24.24	3.49	30.63	-	-	Peak
2412	94.71	-	-	89.75	32.31	6.95	34.3	100	254	Average
2412	105.17	-	-	100.21	32.31	6.95	34.3	100	254	Peak
4824	39.26	-34.74	74	56.51	33.97	8.77	59.99	100	0	Peak
7236	40.6	-44.57	85.17	53.61	35.55	10.83	59.39	100	0	Peak



Test Mode :	802.11n HT20 + USB Cable 1 (Charging from Adapter 1) + Battery 1 + Earphone for Sample 1	Temperature :	21~23°C
Test Channel :	06	Relative Humidity :	51~53%
Test Engineer :	Beer Huang	Polarization :	Horizontal
Remark :	1. 2437 MHz is fundamental signal which can be ignored. 2. Average measurement was not performed if peak level went lower than the average limit.		

Frequency (MHz)	Level (dBμV/m)	Over Limit (dB)	Limit Line (dBμV/m)	Read Level (dBμV)	Antenna Factor (dB)	Cable Loss (dB)	Preamp Factor (dB)	Ant Pos (cm)	Table Pos (deg)	Remark
2437	100.45	-	-	95.46	32.35	6.99	34.35	102	348	Average
2437	110.52	-	-	105.53	32.35	6.99	34.35	102	348	Peak
4875	41.58	-32.42	74	56.29	33.95	8.82	57.48	100	0	Peak
7311	41.67	-32.33	74	53.24	35.54	10.91	58.02	100	0	Peak

Test Mode :	802.11n HT20 + USB Cable 1 (Charging from Adapter 1) + Battery 1 + Earphone for Sample 1	Temperature :	21~23°C
Test Channel :	06	Relative Humidity :	51~53%
Test Engineer :	Beer Huang	Polarization :	Vertical
Remark :	1. 2437 MHz is fundamental signal which can be ignored. 2. Average measurement was not performed if peak level went lower than the average limit.		

Frequency (MHz)	Level (dBμV/m)	Over Limit (dB)	Limit Line (dBμV/m)	Read Level (dBμV)	Antenna Factor (dB)	Cable Loss (dB)	Preamp Factor (dB)	Ant Pos (cm)	Table Pos (deg)	Remark
2437	95.43	-	-	90.44	32.35	6.99	34.35	100	254	Average
2437	105.21	-	-	100.22	32.35	6.99	34.35	100	254	Peak
4875	38.87	-35.13	74	55.88	33.95	8.82	59.78	100	0	Peak
7311	40.26	-33.74	74	53.26	35.54	10.91	59.45	100	0	Peak



Test Mode :	802.11n HT20 + USB Cable 1 (Charging from Adapter 1) + Battery 1 + Earphone for Sample 1	Temperature :	21~23°C
Test Channel :	11	Relative Humidity :	51~53%
Test Engineer :	Beer Huang	Polarization :	Horizontal
Remark :	1. 2462 MHz is fundamental signal which can be ignored. 2. Average measurement was not performed if peak level went lower than the average limit.		

Frequency (MHz)	Level (dBμV/m)	Over Limit (dB)	Limit Line (dBμV/m)	Read Level (dBμV)	Antenna Factor (dB)	Cable Loss (dB)	Preamp Factor (dB)	Ant Pos (cm)	Table Pos (deg)	Remark
2462	98.92	-	-	93.92	32.37	7.02	34.39	155	344	Average
2462	108.92	-	-	103.92	32.37	7.02	34.39	155	344	Peak
4923	41.49	-32.51	74	56.17	33.93	8.87	57.48	100	0	Peak
7386	41.24	-32.76	74	52.81	35.52	10.99	58.08	100	0	Peak

Test Mode :	802.11n HT20 + USB Cable 1 (Charging from Adapter 1) + Battery 1 + Earphone for Sample 1	Temperature :	21~23°C
Test Channel :	11	Relative Humidity :	51~53%
Test Engineer :	Beer Huang	Polarization :	Vertical
Remark :	1. 2462 MHz is fundamental signal which can be ignored. 2. Average measurement was not performed if peak level went lower than the average limit.		

Frequency (MHz)	Level (dBμV/m)	Over Limit (dB)	Limit Line (dBμV/m)	Read Level (dBμV)	Antenna Factor (dB)	Cable Loss (dB)	Preamp Factor (dB)	Ant Pos (cm)	Table Pos (deg)	Remark
2462	93.94	-	-	88.94	32.37	7.02	34.39	100	254	Average
2462	104.22	-	-	99.22	32.37	7.02	34.39	100	254	Peak
4923	38.88	-35.12	74	55.66	33.93	8.87	59.58	100	0	Peak
7386	40.13	-33.87	74	53.14	35.52	10.99	59.52	100	0	Peak



Test Mode :	802.11n HT20 + USB Cable 2 (Charging from Adapter 2) + Battery 2 + Earphone for Sample 2	Temperature :	21~23°C
Test Channel :	01	Relative Humidity :	51~53%
Test Engineer :	Beer Huang	Polarization :	Horizontal
Remark :	1. 2412 MHz is fundamental signal which can be ignored. 2. 7236 MHz is not within a restricted band, and its limit line is 20dB below the highest emission level. 3. Average measurement was not performed if peak level went lower than the average limit.		

Frequency (MHz)	Level (dBμV/m)	Over Limit (dB)	Limit Line (dBμV/m)	Read Level (dBμV)	Antenna Factor (dB)	Cable Loss (dB)	Preamp Factor (dB)	Ant Pos (cm)	Table Pos (deg)	Remark
100.47	22.67	-20.83	43.5	43.44	9.89	1	31.66	-	-	Peak
159.06	24.83	-18.67	43.5	44.43	10.57	1.22	31.39	-	-	Peak
211.44	29.52	-13.98	43.5	49.64	9.91	1.37	31.4	103	301	Peak
341.3	19.56	-26.44	46	34.64	14.43	1.9	31.41	-	-	Peak
678.7	20.78	-25.22	46	27.88	20.43	2.9	30.43	-	-	Peak
862.1	23.59	-22.41	46	28.19	22.72	3.29	30.61	-	-	Peak
2412	99.8	-	-	94.84	32.31	6.95	34.3	106	282	Average
2412	109.93	-	-	104.97	32.31	6.95	34.3	106	282	Peak
4824	41.36	-32.64	74	56.09	33.97	8.77	57.47	-	-	Peak
7236	43.23	-46.7	89.93	54.83	35.55	10.83	57.98	-	-	Peak



Test Mode :	802.11n HT20 + USB Cable 2 (Charging from Adapter 2) + Battery 2 + Earphone for Sample 2	Temperature :	21~23°C
Test Channel :	01	Relative Humidity :	51~53%
Test Engineer :	Beer Huang	Polarization :	Vertical
Remark :	<ol style="list-style-type: none"> 2412 MHz is fundamental signal which can be ignored. 7236 MHz is not within a restricted band, and its limit line is 20dB below the highest emission level. Average measurement was not performed if peak level went lower than the average limit. 		

Frequency (MHz)	Level (dBμV/m)	Over Limit (dB)	Limit Line (dBμV/m)	Read Level (dBμV)	Antenna Factor (dB)	Cable Loss (dB)	Preamp Factor (dB)	Ant Pos (cm)	Table Pos (deg)	Remark
30.27	25.17	-14.83	40	36.51	20	0.53	31.87	119	204	Peak
93.72	21.26	-22.24	43.5	42.88	9.08	0.97	31.67	-	-	Peak
203.07	26.86	-16.64	43.5	47.57	9.3	1.33	31.34	-	-	Peak
460.3	17.08	-28.92	46	28.66	17.27	2.32	31.17	-	-	Peak
661.2	21.23	-24.77	46	28.46	20.29	2.86	30.38	-	-	Peak
912.5	25.18	-20.82	46	29.35	23.29	3.37	30.83	-	-	Peak
2412	93.08	-	-	88.12	32.31	6.95	34.3	100	268	Average
2412	102.98	-	-	98.02	32.31	6.95	34.3	100	268	Peak
4824	41.77	-32.23	74	56.5	33.97	8.77	57.47	-	-	Peak
7236	42.37	-40.61	82.98	53.97	35.55	10.83	57.98	-	-	Peak

3.6 AC Conducted Emission Measurement

3.6.1 Limit of AC Conducted Emission

For equipment that is designed to be connected to the public utility (AC) power line, the radio frequency voltage that is conducted back onto the AC power line on any frequency or frequencies within the band 150 KHz to 30 MHz shall not exceed the limits in the following table.

Frequency of Emission (MHz)	Conducted Limit (dBuV)	
	Quasi-Peak	Average
0.15-0.5	66 to 56*	56 to 46*
0.5-5	56	46
5-30	60	50

*Decreases with the logarithm of the frequency.

3.6.2 Measuring Instruments

See list of measuring instruments of this test report.

3.6.3 Test Procedures

1. The testing follows the guidelines in ANSI C63.10-2009.
2. The EUT was placed 0.4 meter from the conducting wall of the shielding room, and it was kept at least 80 centimeters from any other grounded conducting surface.
3. Connect EUT to the power mains through a line impedance stabilization network (LISN).
4. All the support units are connecting to the other LISN.
5. The LISN provides 50 ohm coupling impedance for the measuring instrument.
6. The FCC states that a 50 ohm, 50 microhenry LISN should be used.
7. Both sides of AC line were checked for maximum conducted interference.
8. The frequency range from 150 KHz to 30 MHz was searched.
9. Set the test-receiver system to Peak Detect Function and specified bandwidth with Maximum Hold Mode.

3.6.4 Test Setup





3.6.5 Test Result of AC Conducted Emission

Test Mode :	Mode 1	Temperature :	19~20°C
Test Engineer :	Tom Wang	Relative Humidity :	39~40%
Test Voltage :	120Vac / 60Hz	Phase :	Line
Function Type :	GPRS850 Idle + Bluetooth Link + WLAN Link + USB Cable 1 (Charging from Adapter 1) + Battery 1 + Earphone for Sample 1		
Remark :	All emissions not reported here are more than 10 dB below the prescribed limit.		

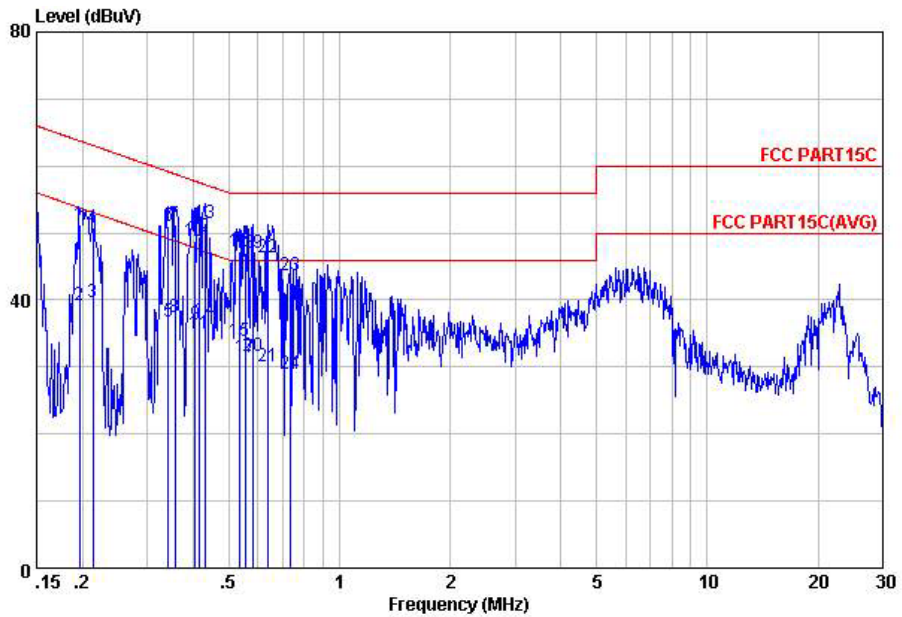

Site : C001-KS
 Condition: FCC PART15C LISN-L20130306 LINE
 mode : Mode 1

	Freq	Level	Over	Limit	Read	LISN	Cable	Remark
	MHz	dBuV	Limit	Line	Level	Factor	Loss	
		dBuV	dB	dBuV	dBuV	dB	dB	
1	0.20	51.26	-12.50	63.76	40.00	1.04	10.22	QP
2	0.20	39.16	-14.60	53.76	27.90	1.04	10.22	Average
3	0.21	39.59	-13.46	53.05	28.40	0.97	10.22	Average
4	0.21	50.79	-12.26	63.05	39.60	0.97	10.22	QP
5	0.34	36.81	-12.32	49.13	26.10	0.46	10.25	Average
6	0.34	51.11	-8.02	59.13	40.40	0.46	10.25	QP
7	0.36	51.16	-7.62	58.78	40.50	0.41	10.25	QP
8	0.36	37.46	-11.32	48.78	26.80	0.41	10.25	Average
9	0.40	36.26	-11.51	47.77	25.70	0.31	10.25	Average
10	0.40	48.86	-8.91	57.77	38.30	0.31	10.25	QP
11	0.42	34.94	-12.57	47.51	24.40	0.29	10.25	Average
12	0.42	49.44	-8.07	57.51	38.90	0.29	10.25	QP
13	0.43	51.52	-5.72	57.24	41.00	0.27	10.25	QP
14	0.43	37.02	-10.22	47.24	26.50	0.27	10.25	Average
15	0.53	33.96	-12.04	46.00	23.50	0.20	10.26	Average
16	0.53	47.26	-8.74	56.00	36.80	0.20	10.26	QP
17	0.56	31.46	-14.54	46.00	21.00	0.20	10.26	Average
18	0.56	47.06	-8.94	56.00	36.60	0.20	10.26	QP
19	0.58	47.06	-8.94	56.00	36.60	0.20	10.26	QP
20	0.58	31.56	-14.44	46.00	21.10	0.20	10.26	Average
21	0.64	30.17	-15.83	46.00	19.70	0.20	10.27	Average
22	0.64	46.27	-9.73	56.00	35.80	0.20	10.27	QP
23	0.74	43.66	-12.34	56.00	33.20	0.19	10.27	QP
24	0.74	28.86	-17.14	46.00	18.40	0.19	10.27	Average



Test Mode :	Mode 1	Temperature :	19~20°C
Test Engineer :	Tom Wang	Relative Humidity :	39~40%
Test Voltage :	120Vac / 60Hz	Phase :	Neutral
Function Type :	GPRS850 Idle + Bluetooth Link + WLAN Link + USB Cable 1 (Charging from Adapter 1) + Battery 1 + Earphone for Sample 1		
Remark :	All emissions not reported here are more than 10 dB below the prescribed limit.		

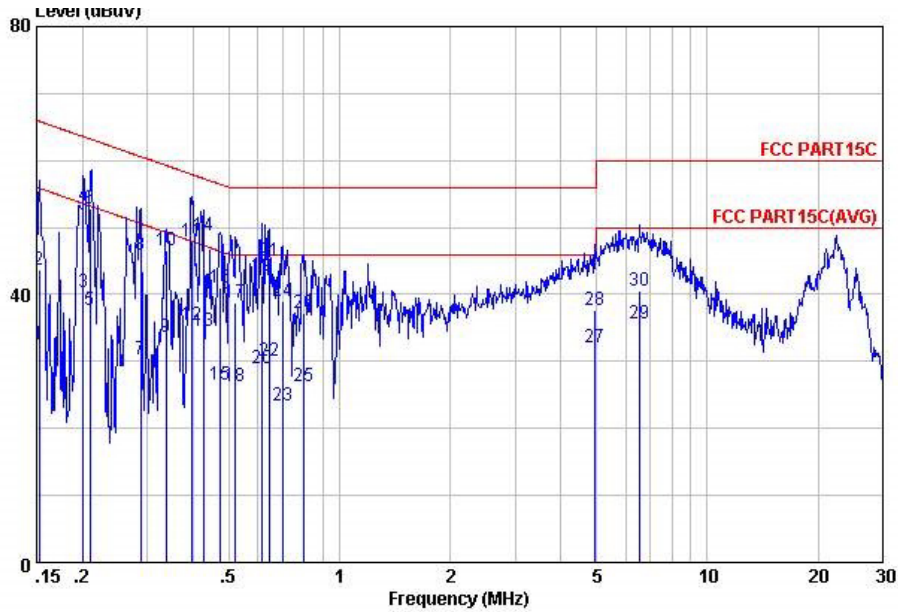

Site : C001-KS
 Condition: FCC PART15C LISN-N20130306 NEUTRAL

mode : Mode 1

	Freq	Level	Over	Limit	Read	LISN	Cable	Remark
	MHz	dBuV	dB	dBuV	dBuV	dB	dB	
1	0.15	32.57	-23.30	55.87	20.50	1.87	10.20	Average
2	0.15	43.67	-22.20	65.87	31.60	1.87	10.20	QP
3	0.20	40.42	-13.16	53.58	29.20	1.00	10.22	Average
4	0.20	53.32	-10.26	63.58	42.10	1.00	10.22	QP
5	0.21	37.60	-15.63	53.23	26.40	0.98	10.22	Average
6	0.21	52.80	-10.43	63.23	41.60	0.98	10.22	QP
7	0.29	30.42	-20.17	50.59	19.40	0.78	10.24	Average
8	0.29	45.82	-14.77	60.59	34.80	0.78	10.24	QP
9	0.34	33.59	-15.68	49.27	22.79	0.55	10.25	Average
10	0.34	46.59	-12.68	59.27	35.79	0.55	10.25	QP
11	0.40	47.96	-9.94	57.90	37.30	0.41	10.25	QP
12	0.40	35.46	-12.44	47.90	24.80	0.41	10.25	Average
13	0.43	34.52	-12.77	47.29	23.90	0.37	10.25	Average
14	0.43	48.72	-8.57	57.29	38.10	0.37	10.25	QP
15	0.47	26.47	-19.98	46.45	15.90	0.32	10.25	Average
16	0.47	41.07	-15.38	56.45	30.50	0.32	10.25	QP
17	0.52	38.75	-17.25	56.00	28.20	0.29	10.26	QP
18	0.52	26.25	-19.75	46.00	15.70	0.29	10.26	Average
19	0.62	42.90	-13.10	56.00	32.41	0.23	10.26	QP
20	0.62	28.90	-17.10	46.00	18.41	0.23	10.26	Average
21	0.64	44.99	-11.01	56.00	34.50	0.22	10.27	QP
22	0.64	29.99	-16.01	46.00	19.50	0.22	10.27	Average
23	0.70	23.37	-22.63	46.00	12.90	0.20	10.27	Average
24	0.70	39.07	-16.93	56.00	28.60	0.20	10.27	QP
25	0.80	26.34	-19.66	46.00	15.89	0.17	10.28	Average
26	0.80	37.14	-18.86	56.00	26.69	0.17	10.28	QP
27	4.95	32.13	-13.87	46.00	21.60	0.20	10.33	Average
28	4.95	37.63	-18.37	56.00	27.10	0.20	10.33	QP
29	6.52	35.55	-14.45	50.00	25.00	0.20	10.35	Average
30	6.52	40.55	-19.45	60.00	30.00	0.20	10.35	QP



3.7 Antenna Requirements

3.7.1 Standard Applicable

If directional gain of transmitting antennas is greater than 6dBi, the power shall be reduced by the same level in dB comparing to gain minus 6dBi. For the fixed point-to-point operation, the power shall be reduced by one dB for every 3 dB that the directional gain of the antenna exceeds 6 dBi. The use of a permanently attached antenna or of an antenna that uses a unique coupling to the intentional radiator shall be considered sufficient to comply with the FCC rule.

3.7.2 Antenna Connected Construction

Non-standard connector used.

3.7.3 Antenna Gain

The antenna peak gain of EUT is less than 6 dBi. Therefore, it is not necessary to reduce maximum peak output power limit.



4 List of Measuring Equipment

Instrument	Manufacturer	Model No.	Serial No.	Characteristics	Calibration Date	Test Date	Due Date	Remark
Spectrum Analyzer	R&S	FSP40	100319	9kHz~40GHz	Dec. 29, 2012	Mar. 15, 2013~ Apr. 07, 2013	Dec. 28, 2013	Conducted (TH01-KS)
Power Meter	Agilent	E4416A	MY45101555	N/A	Aug. 22, 2012	Mar. 15, 2013~ Apr. 07, 2013	Aug. 21, 2013	Conducted (TH01-KS)
Power Sensor	Agilent	E9327A	MY44421198	N/A	Aug. 22, 2012	Mar. 15, 2013~ Apr. 07, 2013	Aug. 21, 2013	Conducted (TH01-KS)
DC Power Supply	GWINSTEK	GPS-3030D	E1884515	N/A	Aug. 22, 2012	Mar. 15, 2013~ Apr. 07, 2013	Aug. 21, 2013	Conducted (TH01-KS)
Thermal Chamber	Ten Billion	TTC-B3S	TBN-960502	N/A	Dec. 29, 2012	Mar. 15, 2013~ Apr. 07, 2013	Dec. 28, 2013	Conducted (TH01-KS)
Bilog Antenna	Schaffner	CBL6111C	2726	30MHz ~ 1GHz	Oct. 06, 2012	Mar. 23, 2013	Oct. 05, 2013	Radiation (03CH07-HY)
Spectrum Analyzer	Rohde & Schwarz	FSP30	101067	9KHz ~ 30GHz	Nov. 30, 2012	Mar. 23, 2013	Nov. 29, 2013	Radiation (03CH07-HY)
Double Ridge Horn Antenna	ESCO	3117	00075962	1GHz ~ 18GHz	Aug. 22, 2012	Mar. 23, 2013	Aug. 21, 2013	Radiation (03CH07-HY)
Preamplifier	Agilent	8449B	3008A02362	1GHz~ 26.5GHz	Dec. 01, 2012	Mar. 23, 2013	Nov. 30, 2013	Radiation (03CH07-HY)
Preamplifier	MITEQ	AMF-7D-001 01800-30-10 P	159088	1GHz ~ 18GHz	Feb. 27, 2013	Mar. 23, 2013	Feb. 26, 2014	Radiation (03CH07-HY)
Preamplifier	COM-POWER	PA-103A	161241	10-1000MHz. 32dB.GAIN	Feb. 26, 2013	Mar. 23, 2013	Feb. 25, 2014	Radiation (03CH07-HY)
EMI Test Receiver	Rohde & Schwarz	ESCI 7	100724	9kHz~7GHz	Sep. 03, 2012	Mar. 23, 2013	Sep. 02, 2013	Radiation (03CH07-HY)
SHF-EHF Horn Antenna	SCHWARZBECK	BBHA 9170	BBHA9170251	15GHz ~ 40GHz	Sep. 28, 2012	Mar. 23, 2013	Sep. 27, 2013	Radiation (03CH07-HY)
Loop Antenna	R&S	HFH2-Z2	860004/001	9KHz ~ 30MHz	Jul. 03, 2012	Mar. 23, 2013	Jul. 02, 2014	Radiation (03CH07-HY)
EMI Receiver	R&S	ESCI7	100768	9kHz~7GHz	Jun. 01, 2012	Mar. 22, 2013	May 31, 2013	Conduction (CO01-KS)
LISN	MessTec	AN3016	60103	9kHz~30MHz	Dec. 29, 2012	Mar. 22, 2013	Dec. 28, 2013	Conduction (CO01-KS)
LISN	MessTec	AN3016	60105	9kHz~30MHz	Dec. 29, 2012	Mar. 22, 2013	Dec. 28, 2013	Conduction (CO01-KS)
AC Power Source	Chroma	61602	ABP000000811	N/A	Nov. 15, 2012	Mar. 22, 2013	Nov. 14, 2013	Conduction (CO01-KS)
System Simulator	R&S	CMU200	837587/066	2G Full-Band	Dec. 29, 2012	Mar. 22, 2013	Dec. 28, 2013	Conduction (CO01-KS)

5 Uncertainty of Evaluation

Uncertainty of Conducted Emission Measurement (150 KHz ~ 30 MHz)

Measuring Uncertainty for a Level of Confidence of 95% ($U = 2Uc(y)$)	2.26
---	------

Uncertainty of Radiated Emission Measurement (30 MHz ~ 1000 MHz)

Measuring Uncertainty for a Level of Confidence of 95% ($U = 2Uc(y)$)	2.54
---	------

Uncertainty of Radiated Emission Measurement (1 GHz ~ 40 GHz)

Measuring Uncertainty for a Level of Confidence of 95% ($U = 2Uc(y)$)	4.72
---	------



Appendix A. Photographs of EUT

Please refer to Sporton report number EP331304 as below.