

# FCC SAR Test Report

**APPLICANT** : Lenovo (Shanghai) Electronics Technology Co., Ltd.  
**EQUIPMENT** : Tablet PC IdeaTab S6000-H  
**BRAND NAME** : lenovo  
**MODEL NAME** : 60032, Z0A5  
**FCC ID** : O57S6000H  
**STANDARD** : FCC 47 CFR Part 2 (2.1093)  
ANSI/IEEE C95.1-1992  
IEEE 1528-2003  
FCC OET Bulletin 65 Supplement C (Edition 01-01)

The product was completely tested on Apr. 10, 2013. We, SPORTON INTERNATIONAL (KUNSHAN) INC., would like to declare that the tested sample has been evaluated in accordance with the procedures and shown the compliance with the applicable technical standards.

The test results in this report apply exclusively to the tested model / sample. Without written approval of SPORTON INTERNATIONAL (KUNSHAN) INC., the test report shall not be reproduced except in full.

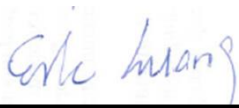

Reviewed by: Eric Huang / Deputy Manager



Approved by: Jones Tsai / Manager



**SPORTON INTERNATIONAL (KUNSHAN) INC.**  
**No. 3-2, PingXiang Road, Kunshan, Jiangsu Province, P.R.C.**



## Table of Contents

<b>1. Statement of Compliance</b>	<b>4</b>
<b>2. Administration Data</b>	<b>5</b>
2.1 Testing Laboratory	5
2.2 Applicant	5
2.3 Manufacturer	5
2.4 Application Details	5
<b>3. General Information</b>	<b>6</b>
3.1 Description of Equipment Under Test (EUT)	6
3.2 Maximum RF output power among production units	7
3.3 Applied Standard	9
3.4 Device Category and SAR Limits	9
3.5 Test Conditions	9
<b>4. Specific Absorption Rate (SAR)</b>	<b>13</b>
4.1 Introduction	13
4.2 SAR Definition	13
<b>5. SAR Measurement System</b>	<b>14</b>
5.1 E-Field Probe	15
5.2 Data Acquisition Electronics (DAE)	16
5.3 Robot	16
5.4 Measurement Server	16
5.5 Phantom	17
5.6 Device Holder	17
5.7 Data Storage and Evaluation	18
5.8 Test Equipment List	20
<b>6. Tissue Simulating Liquids</b>	<b>21</b>
<b>7. SAR System Verification</b>	<b>22</b>
7.1 Purpose of System Performance check	22
7.2 System Setup	22
7.3 SAR System Verification Results	23
<b>8. EUT Testing Position</b>	<b>24</b>
<b>9. Measurement Procedures</b>	<b>24</b>
9.1 Spatial Peak SAR Evaluation	25
9.2 Power Reference Measurement	25
9.3 Area & Zoom Scan Procedures	26
9.4 Volume Scan Procedures	27
9.5 SAR Averaged Methods	27
9.6 Power Drift Monitoring	27
<b>10. Conducted RF Output Power (Unit: dBm)</b>	<b>28</b>
<b>11. Exposure Positions Consideration</b>	<b>38</b>
<b>12. SAR Test Results</b>	<b>40</b>
12.1 Test Records for Body SAR Test	40
12.2 Repeated SAR Measurement	43
12.3 Highest SAR Plot	43
12.4 Simultaneous Multi-band Transmission Analysis	49
12.5 Simultaneous analysis - SPLSR calculation	52
<b>13. Uncertainty Assessment</b>	<b>55</b>
<b>14. References</b>	<b>57</b>
<b>Appendix A. Plots of System Performance Check</b>	
<b>Appendix B. Plots of SAR Measurement</b>	
<b>Appendix C. DASY Calibration Certificate</b>	
<b>Appendix D. Test Setup Photos</b>	





1. Statement of Compliance

The maximum results of Specific Absorption Rate (SAR) found during testing for Lenovo (Shanghai) Electronics Technology Co., Ltd. DUT: Tablet PC IdeaTab S6000-H, Brand Name: lenovo, Model Name: 60032, Z0A5 are as follows.

<Highest Reported standalone SAR Summary>

Table with 5 columns: Exposure Position, Frequency Band, Highest Reported 1g-SAR (W/kg), Equipment Class, Highest Reported 1g-SAR (W/kg). Rows include GSM850, GSM1900, WCDMA Band V, WCDMA Band II, WLAN 2.4GHz Band.

<Highest Simultaneous transmission SAR>

Table with 4 columns: Frequency Band, Equipment Class, Exposure Position, Highest Reported Simultaneous Transmission 1g-SAR (W/kg). Rows include GSM1900, WLAN 2.4GHz Band.

Table with 4 columns: Frequency Band, Equipment Class, Exposure Position, Highest Reported Simultaneous Transmission 1g-SAR (W/kg). Rows include WCDMA Band II, Bluetooth.

This device is in compliance with Specific Absorption Rate (SAR) for general population/uncontrolled exposure limits (1.6 W/kg) specified in FCC 47 CFR part 2 (2.1093) and ANSI/IEEE C95.1-1992, and had been tested in accordance with the measurement methods and procedures specified in IEEE 1528-2003 and FCC OET Bulletin 65 Supplement C (Edition 01-01).

## **2. Administration Data**

### **2.1 Testing Laboratory**

<b>Test Site</b>	SPORTON INTERNATIONAL (KUNSHAN) INC.
<b>Test Site Location</b>	No. 3-2, PingXiang Road, Kunshan, Jiangsu Province, P.R.C. TEL: +86-0512-5790-0158 FAX: +86-0512-5790-0958

### **2.2 Applicant**

<b>Company Name</b>	Lenovo (Shanghai) Electronics Technology Co., Ltd.
<b>Address</b>	No. 68 Building, 199 Fenju Road, Wai Gao Qiao FTZ , Shanghai , China

### **2.3 Manufacturer**

<b>Company Name</b>	Lenovo PC HK Limited
<b>Address</b>	23/F, Lincoln House, Taikoo Place 979 King's Road, Quarry Bay, Hong Kong

### **2.4 Application Details**

<b>Date of Start during the Test</b>	Apr. 08, 2013
<b>Date of End during the Test</b>	Apr. 10, 2013



### 3. General Information

#### 3.1 Description of Equipment Under Test (EUT)

Product Feature & Specification	
EUT	Tablet PC IdeaTab S6000-H
Brand Name	lenovo
Model Name	60032, Z0A5
FCC ID	O57S6000H
TX Frequency	GSM850: 824.2 MHz ~ 848.8 MHz GSM1900: 1850.2 MHz ~ 1909.8 MHz WCDMA Band V: 826.4 MHz ~ 846.6 MHz WCDMA Band II: 1852.4 MHz ~ 1907.6 MHz WLAN 2.4GHz Band: 2412 MHz ~ 2462 MHz Bluetooth: 2402 MHz ~ 2480 MHz
Antenna Type	WWAN: Fixed Internal Antenna WLAN: Fixed Internal Antenna Bluetooth: Fixed Internal Antenna
HW Version	lepad S6000-H
SW Version	S6000-130519
Uplink Modulations	GPRS: GMSK EDGE: GMSK / 8PSK WCDMA (Rel 99): QPSK HSDPA (Rel 6): QPSK HSUPA (Rel 6): QPSK HSPA+ (Rel 7): 16QAM 802.11b: DSSS (DBPSK / DQPSK / CCK) 802.11g/n: OFDM (BPSK / QPSK / 16QAM / 64QAM) Bluetooth BDR (1Mbps): GFSK Bluetooth EDR (2Mbps): $\pi/4$ -DQPSK Bluetooth EDR (3Mbps): 8-DPSK Bluetooth 4.0 - LE (1Mbps): GFSK
EUT Stage	Identical Prototype
Remark:	<ol style="list-style-type: none"><li>1. The above EUT's information was declared by manufacturer. Please refer to the specifications or user's manual for more detailed description.</li><li>2. Voice call is not supported.</li><li>3. There are two types of EUT Sample 1 and Sample 2. The differences between the two samples are only different supplier for EMMC card/Touch panel/LCD panel and the back camera. The others are the same including circuit design, PCB board, structure and other components.</li></ol>



**3.2 Maximum RF output power among production units**

Band	Average Power (dBm)			
	GSM 850		GSM 1900	
Output Power Status	Normal	Reduced	Normal	Reduced
GPRS/EDGE (GMSK, 1 Tx slot)	33.5	28.5	30	24.5
GPRS/EDGE (GMSK, 2 Tx slots)	32	25.5	28	22
GPRS/EDGE (GMSK, 3 Tx slots)	30	23.5	27	20.5
GPRS/EDGE (GMSK, 4 Tx slots)	29	22.5	26	19.5
EDGE (8PSK, 1 Tx slot)	27	22	26	21.5
EDGE (8PSK, 2 Tx slots)	26	19.5	25	19
EDGE (8PSK, 3 Tx slots)	24	17.5	23	16.5
EDGE (8PSK, 4 Tx slots)	23	16.5	21	14.5

Band	Average Power (dBm)			
	WCDMA Band V		WCDMA Band II	
Output Power Status	Normal	Reduced	Normal	Reduced
RMC 12.2k	23	18	22.5	17.5
HSDPA Subtest-1	22	18	21.5	17.5
HSDPA Subtest-2	22	18	21.5	17.5
HSDPA Subtest-3	21.5	17.5	21	17
HSDPA Subtest-4	21.5	17.5	21	17
DC-HSDPA Subtest-1	22	18	21.5	17.5
DC-HSDPA Subtest-2	22	18	21.5	17.5
DC-HSDPA Subtest-3	21.5	17.5	21	17
DC-HSDPA Subtest-4	21.5	17.5	21	17
HSUPA Subtest-1	22	17	21.5	16.5
HSUPA Subtest-2	20	15	19.5	14.5
HSUPA Subtest-3	21	16	20.5	15.5
HSUPA Subtest-4	20	15	19.5	14.5
HSUPA Subtest-5	22	17	21.5	16.5
HSPA+ (16QAM) Subtest-1	21	16.5	20.5	16



Band	Average Power (dBm)			
	IEEE 802.11			
	a	b	g	n-HT20
WLAN 2.4GHz Band		14	11	11

Band	Average Power (dBm)			
	1Mbps (GFSK)	2Mbps ( $\pi/4$ -DQPSK)	3Mbps (8-DPSK)	BT4.0-LE (GFSK)
Bluetooth	8	6.5	6.5	1





### 3.3 Applied Standard

The Specific Absorption Rate (SAR) testing specification, method, and procedure for this device is in accordance with the following standards:

- FCC 47 CFR Part 2 (2.1093)
- ANSI/IEEE C95.1-1992
- IEEE 1528-2003
- FCC OET Bulletin 65 Supplement C (Edition 01-01)
- FCC KDB 447498 D01 v05
- FCC KDB 248227 D01 v01r02
- FCC KDB 616217 D04 v01
- FCC KDB 941225 D01 v02
- FCC KDB 941225 D02 v02r01
- FCC KDB 941225 D03 v01
- FCC KDB 865664 D01 v01

### 3.4 Device Category and SAR Limits

This device belongs to portable device category because its radiating structure is allowed to be used within 20 centimeters of the body of the user. Limit for General Population/Uncontrolled exposure should be applied for this device, it is 1.6 W/kg as averaged over any 1 gram of tissue.

### 3.5 Test Conditions

#### 3.5.1 Ambient Condition

Ambient Temperature	20 to 24 °C
Humidity	< 60 %

#### 3.5.2 Test Configuration

For WWAN SAR testing, the device was controlled by using a base station emulator. Communication between the device and the emulator was established by air link. The distance between the EUT and the antenna of the emulator is larger than 50 cm and the output power radiated from the emulator antenna is at least 30 dB smaller than the output power of EUT.

The EUT was set from the emulator to radiate maximum WWAN output power during all tests. For Bottom-Face testing at 0cm separation, the proximity sensor will activate the power reduction and the maximum power is limited at the pre-defined level implemented in this device.

During WLAN SAR testing EUT is configured with the WLAN continuous TX tool, and the transmission duty factor was monitored on the spectrum analyzer with zero-span setting

For WLAN SAR testing, WLAN engineering testing software installed on the EUT can provide continuous transmitting RF signal.

**Target Power reduction applied for each wireless mode and orientation**

Exposure Position / wireless mode	Bottom Face <sup>(1)</sup>	Edge 1 <sup>(1)</sup>	Edge 2	Edge 3	Edge 4
GSM850 GPRS/EDGE (GMSK 1 Tx slot) - CS1/MCS1	5 dB	5 dB	0 dB	0 dB	0 dB
GSM850 GPRS/EDGE (GMSK 2 Tx slots) - CS1/MCS1	6.5 dB	6.5 dB	0 dB	0 dB	0 dB
GSM850 GPRS/EDGE (GMSK 3 Tx slots) - CS1/MCS1	6.5 dB	6.5 dB	0 dB	0 dB	0 dB
GSM850 GPRS/EDGE (GMSK 4 Tx slots) - CS1/MCS1	6.5 dB	6.5 dB	0 dB	0 dB	0 dB
GSM850 EDGE (8PSK 1 Tx slot) - MCS5	5 dB	5 dB	0 dB	0 dB	0 dB
GSM850 EDGE (8PSK 2 Tx slots) - MCS5	6.5 dB	6.5 dB	0 dB	0 dB	0 dB
GSM850 EDGE (8PSK 3 Tx slots) - MCS5	6.5 dB	6.5 dB	0 dB	0 dB	0 dB
GSM850 EDGE (8PSK 4 Tx slots) - MCS5	6.5 dB	6.5 dB	0 dB	0 dB	0 dB
GSM1900 GPRS/EDGE (GMSK 1 Tx slot) - CS1/MCS1	5.5 dB	5.5 dB	0 dB	0 dB	0 dB
GSM1900 GPRS/EDGE (GMSK 2 Tx slots) - CS1/MCS1	6 dB	6 dB	0 dB	0 dB	0 dB
GSM1900 GPRS/EDGE (GMSK 3 Tx slots) - CS1/MCS1	6.5 dB	6.5 dB	0 dB	0 dB	0 dB
GSM1900 GPRS/EDGE (GMSK 4 Tx slots) - CS1/MCS1	6.5 dB	6.5 dB	0 dB	0 dB	0 dB
GSM1900 EDGE (8PSK 1 Tx slot) - MCS5	4.5 dB	4.5 dB	0 dB	0 dB	0 dB
GSM1900 EDGE (8PSK 2 Tx slots) - MCS5	6 dB	6 dB	0 dB	0 dB	0 dB
GSM1900 EDGE (8PSK 3 Tx slots) - MCS5	6.5 dB	6.5 dB	0 dB	0 dB	0 dB
GSM1900 EDGE (8PSK 4 Tx slots) - MCS5	6.5 dB	6.5 dB	0 dB	0 dB	0 dB
WCDMA Band V RMC 12.2kbps	5 dB	5 dB	0 dB	0 dB	0 dB
WCDMA Band II RMC 12.2kbps	5 dB	5 dB	0 dB	0 dB	0 dB

**Remark:**

1. <sup>(1)</sup>: Reduced maximum limit applied by activation of proximity sensor.
2. Power reduction is not applicable for WLAN and Bluetooth.



Measurement on EUT:

Band/Mode	Ch #	Measured power reduction (dBm)		Reduction Levels (dB)
		Normal	Reduced	
GSM850 GPRS/EDGE (GMSK 4 Tx slots) - CS1/MCS1	189	28.94	22.25	6.69
GSM1900 GPRS/EDGE (GMSK 4 Tx slots) - CS1/MCS1	661	25.16	18.54	6.62
WCDMA Band V RMC 12.2kbps	4182	22.59	17.53	5.06
WCDMA Band II RMC 12.2kbps	9400	22.05	16.92	5.13

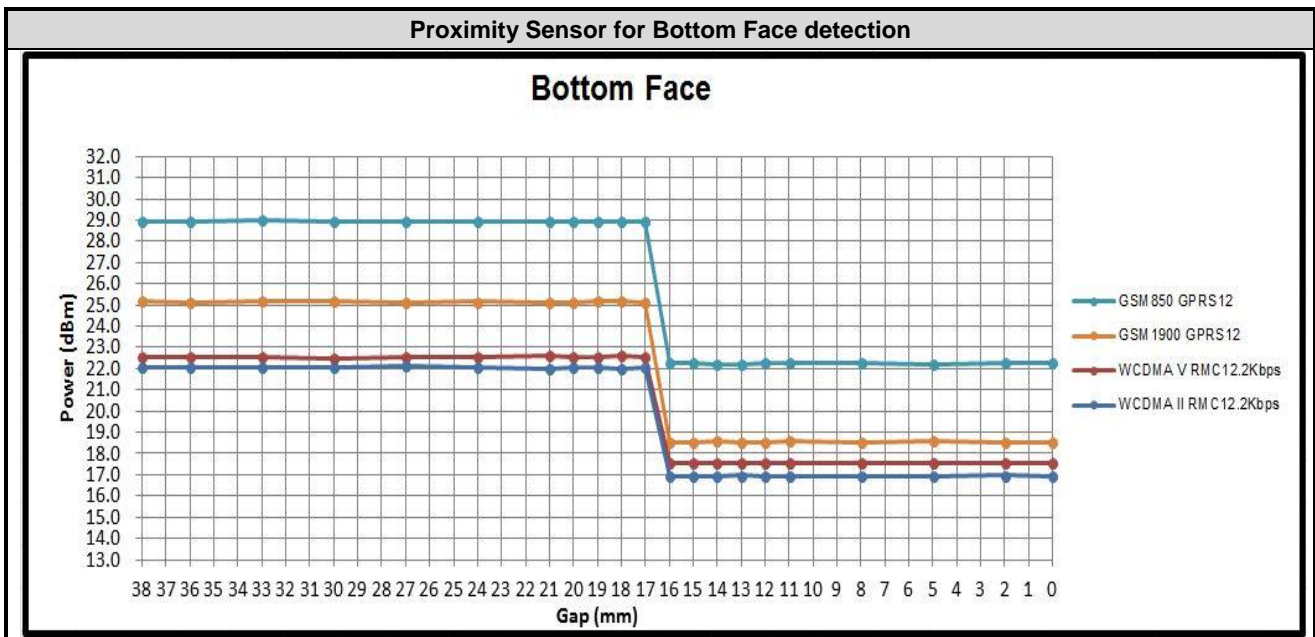

Proximity Sensor for Edge1 detection

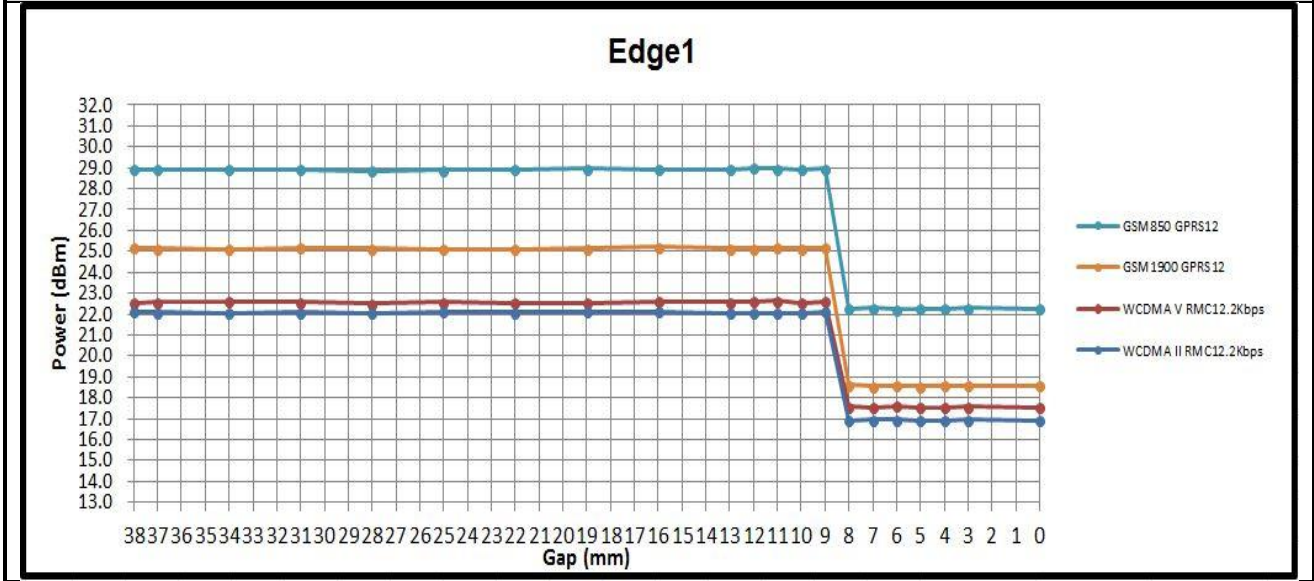

## **4. Specific Absorption Rate (SAR)**

### **4.1 Introduction**

SAR is related to the rate at which energy is absorbed per unit mass in an object exposed to a radio field. The SAR distribution in a biological body is complicated and is usually carried out by experimental techniques or numerical modeling. The standard recommends limits for two tiers of groups, occupational/controlled and general population/uncontrolled, based on a person's awareness and ability to exercise control over his or her exposure. In general, occupational/controlled exposure limits are higher than the limits for general population/uncontrolled.

### **4.2 SAR Definition**

The SAR definition is the time derivative (rate) of the incremental energy (dW) absorbed by (dissipated in) an incremental mass (dm) contained in a volume element (dv) of a given density ( $\rho$ ). The equation description is as below:

$$\text{SAR} = \frac{d}{dt} \left( \frac{dW}{dm} \right) = \frac{d}{dt} \left( \frac{dW}{\rho dv} \right)$$

SAR is expressed in units of Watts per kilogram (W/kg)

SAR measurement can be either related to the temperature elevation in tissue by

$$\text{SAR} = C \left( \frac{\delta T}{\delta t} \right)$$

Where: C is the specific heat capacity,  $\delta T$  is the temperature rise and  $\delta t$  is the exposure duration, or related to the electrical field in the tissue by

$$\text{SAR} = \frac{\sigma |E|^2}{\rho}$$

Where:  $\sigma$  is the conductivity of the tissue,  $\rho$  is the mass density of the tissue and E is the RMS electrical field strength.

However for evaluating SAR of low power transmitter, electrical field measurement is typically applied.

## 5. SAR Measurement System

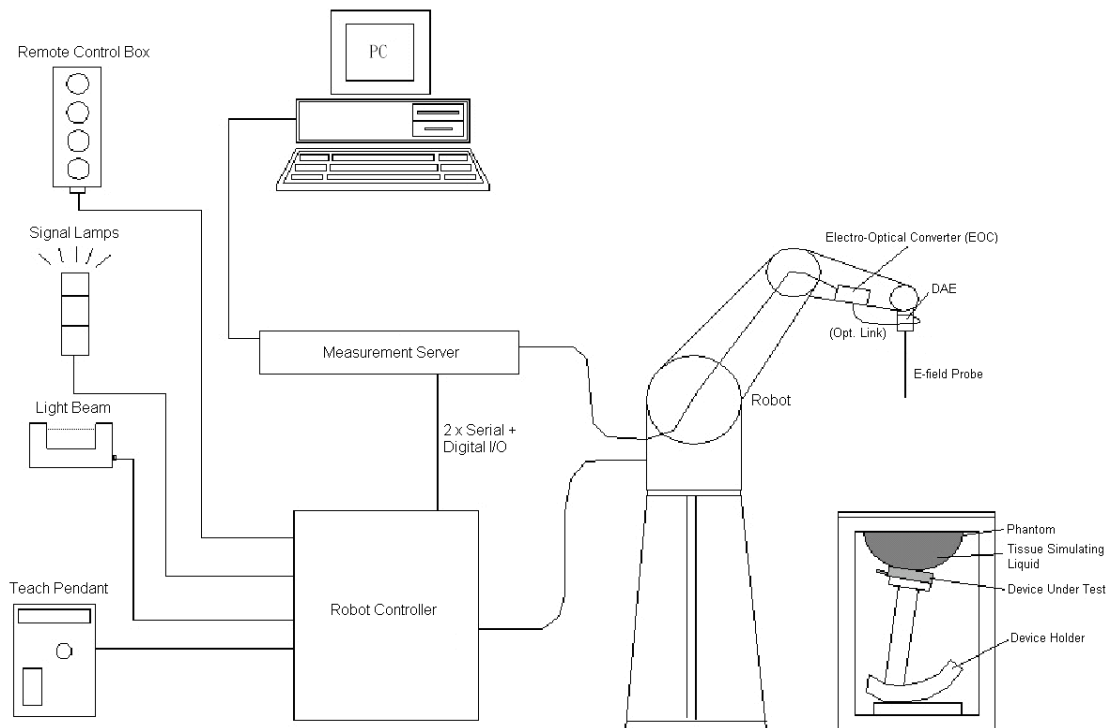

**Fig 5.1 SPEAG DASY System Configurations**

The DASY system for performance compliance tests is illustrated above graphically. This system consists of the following items:

- A standard high precision 6-axis robot with controller, a teach pendant and software
- A data acquisition electronic (DAE) attached to the robot arm extension
- A dosimetric probe equipped with an optical surface detector system
- The electro-optical converter (EOC) performs the conversion between optical and electrical signals
- A measurement server performs the time critical tasks such as signal filtering, control of the robot operation and fast movement interrupts.
- A probe alignment unit which improves the accuracy of the probe positioning
- A computer operating Windows XP
- DASY software
- Remote control with teach pendant and additional circuitry for robot safety such as warning lamps, etc.
- The SAM twin phantom
- A device holder
- Tissue simulating liquid
- Dipole for evaluating the proper functioning of the system

Component details are described in in the following sub-sections.

### 5.1 E-Field Probe

The SAR measurement is conducted with the dosimetric probe (manufactured by SPEAG). The probe is specially designed and calibrated for use in liquid with high permittivity. The dosimetric probe has special calibration in liquid at different frequency. This probe has a built in optical surface detection system to prevent from collision with phantom.

#### 5.1.1 E-Field Probe Specification

##### <EX3DV4 Probe>

<b>Construction</b>	Symmetrical design with triangular core Built-in shielding against static charges PEEK enclosure material (resistant to organic solvents, e.g., DGBE)	
<b>Frequency</b>	10 MHz to 6 GHz; Linearity: $\pm 0.2$ dB	
<b>Directivity</b>	$\pm 0.3$ dB in HSL (rotation around probe axis) $\pm 0.5$ dB in tissue material (rotation normal to probe axis)	
<b>Dynamic Range</b>	10 $\mu$ W/g to 100 mW/g; Linearity: $\pm 0.2$ dB (noise: typically $< 1$ $\mu$ W/g)	
<b>Dimensions</b>	Overall length: 330 mm (Tip: 20 mm) Tip diameter: 2.5 mm (Body: 12 mm) Typical distance from probe tip to dipole centers: 1 mm	

**Fig 5.2 Photo of EX3DV4**

#### 5.1.2 E-Field Probe Calibration

Each probe needs to be calibrated according to a dosimetric assessment procedure with accuracy better than  $\pm 10\%$ . The spherical isotropy shall be evaluated and within  $\pm 0.25$ dB. The sensitivity parameters (NormX, NormY, and NormZ), the diode compression parameter (DCP) and the conversion factor (ConvF) of the probe are tested. The calibration data can be referred to appendix C of this report.

## **5.2 Data Acquisition Electronics (DAE)**

The data acquisition electronics (DAE) consists of a highly sensitive electrometer-grade preamplifier with auto-zeroing, a channel and gain-switching multiplexer, a fast 16 bit AD-converter and a command decoder and control logic unit. Transmission to the measurement server is accomplished through an optical downlink for data and status information as well as an optical uplink for commands and the clock. The input impedance of the DAE is 200 MOhm; the inputs are symmetrical and floating. Common mode rejection is above 80 dB.



**Fig 5.3 Photo of DAE**

## **5.3 Robot**

The SPEAG DASY system uses the high precision robots (DASY5: TX90XL) type from Stäubli SA (France). For the 6-axis controller system, the robot controller version (DASY5: CS8c) from Stäubli is used. The Stäubli robot series have many features that are important for our application:

- High precision (repeatability  $\pm 0.035$  mm)
- High reliability (industrial design)
- Jerk-free straight movements
- Low ELF interference (the closed metallic construction shields against motor control fields)



**Fig 5.4 Photo of DASY5**

## **5.4 Measurement Server**

The measurement server is based on a PC/104 CPU board with CPU (DASY5: 400 MHz, Intel Celeron), chipdisk (DASY5: 128 MB), RAM (DASY5: 128 MB). The necessary circuits for communication with the DAE electronic box, as well as the 16 bit AD converter system for optical detection and digital I/O interface are contained on the DASY I/O board, which is directly connected to the PC/104 bus of the CPU board.

The measurement server performs all the real-time data evaluation for field measurements and surface detection, controls robot movements and handles safety operations.



**Fig 5.5 Photo of Server for DASY5**



**5.5 Phantom**

**<ELI4 Phantom>**

<b>Shell Thickness</b>	2 ± 0.2 mm (sagging: <1%)
<b>Filling Volume</b>	Approx. 30 liters
<b>Dimensions</b>	Major ellipse axis: 600 mm Minor axis: 400 mm



**Fig 5.6 Photo of ELI4 Phantom**

The ELI4 phantom is intended for compliance testing of handheld and body-mounted wireless devices in the frequency range of 30 MHz to 6 GHz. ELI4 is fully compatible with standard and all known tissue simulating liquids.

**5.6 Device Holder**

**<Laptop Extension Kit>**

The extension is lightweight and made of POM, acrylic glass and foam. It fits easily on the upper part of the mounting device in place of the phone positioned. The extension is fully compatible with the SAM Twin and ELI phantoms.

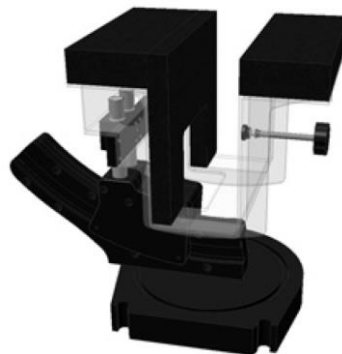

**Fig 5.7 Laptop Extension Kit**

## **5.7 Data Storage and Evaluation**

### **5.7.1 Data Storage**

The DASY software stores the assessed data from the data acquisition electronics as raw data (in microvolt readings from the probe sensors), together with all the necessary software parameters for the data evaluation (probe calibration data, liquid parameters and device frequency and modulation data) in measurement files. The post-processing software evaluates the desired unit and format for output each time the data is visualized or exported. This allows verification of the complete software setup even after the measurement and allows correction of erroneous parameter settings. For example, if a measurement has been performed with an incorrect crest factor parameter in the device setup, the parameter can be corrected afterwards and the data can be reevaluated.

The measured data can be visualized or exported in different units or formats, depending on the selected probe type (e.g., [V/m], [A/m], [mW/g]). Some of these units are not available in certain situations or give meaningless results, e.g., a SAR-output in a non-lose media, will always be zero. Raw data can also be exported to perform the evaluation with other software packages.

### **5.7.2 Data Evaluation**

The DASY post-processing software (SEMCAD) automatically executes the following procedures to calculate the field units from the microvolt readings at the probe connector. The parameters used in the evaluation are stored in the configuration modules of the software :

<b>Probe parameters :</b>	- Sensitivity	Norm <sub>i</sub> , a <sub>i0</sub> , a <sub>i1</sub> , a <sub>i2</sub>
	- Conversion factor	ConvF <sub>i</sub>
	- Diode compression point	dcp <sub>i</sub>
<b>Device parameters :</b>	- Frequency	f
	- Crest factor	cf
<b>Media parameters :</b>	- Conductivity	σ
	- Density	ρ

These parameters must be set correctly in the software. They can be found in the component documents or they can be imported into the software from the configuration files issued for the DASY components. In the direct measuring mode of the multi-meter option, the parameters of the actual system setup are used. In the scan visualization and export modes, the parameters stored in the corresponding document files are used.

The first step of the evaluation is a linearization of the filtered input signal to account for the compression characteristics of the detector diode. The compensation depends on the input signal, the diode type and the DC-transmission factor from the diode to the evaluation electronics. If the exciting field is pulsed, the crest factor of the signal must be known to correctly compensate for peak power.

The formula for each channel can be given as :

$$V_i = U_i + U_i^2 \cdot \frac{cf}{dcp_i}$$

with  $V_i$  = compensated signal of channel i, (i = x, y, z)  
 $U_i$  = input signal of channel i, (i = x, y, z)  
 cf = crest factor of exciting field (DASY parameter)  
 dcp<sub>i</sub> = diode compression point (DASY parameter)

From the compensated input signals, the primary field data for each channel can be evaluated :

$$\text{E-field Probes : } E_i = \sqrt{\frac{V_i}{\text{Norm}_i \cdot \text{ConvF}}}$$

$$\text{H-field Probes : } H_i = \sqrt{V_i \cdot \frac{a_{i0} + a_{i1}f + a_{i2}f^2}{f}}$$

with  $V_i$  = compensated signal of channel i, (i = x, y, z)  
 $\text{Norm}_i$  = sensor sensitivity of channel i, (i = x, y, z),  $\mu\text{V}/(\text{V/m})^2$  for E-field Probes  
 ConvF = sensitivity enhancement in solution  
 $a_{ij}$  = sensor sensitivity factors for H-field probes  
 f = carrier frequency [GHz]  
 $E_i$  = electric field strength of channel i in V/m  
 $H_i$  = magnetic field strength of channel i in A/m

The RSS value of the field components gives the total field strength (Hermitian magnitude) :

$$E_{\text{tot}} = \sqrt{E_x^2 + E_y^2 + E_z^2}$$

The primary field data are used to calculate the derived field units.

$$\text{SAR} = E_{\text{tot}}^2 \cdot \frac{\sigma}{\rho \cdot 1000}$$

with SAR = local specific absorption rate in mW/g  
 $E_{\text{tot}}$  = total field strength in V/m  
 $\sigma$  = conductivity in [mho/m] or [Siemens/m]  
 $\rho$  = equivalent tissue density in  $\text{g}/\text{cm}^3$

Note that the density is set to 1, to account for actual head tissue density rather than the density of the tissue simulating liquid.



**5.8 Test Equipment List**

Manufacturer	Name of Equipment	Type/Model	Serial Number	Calibration	
				Last Cal.	Due Date
SPEAG	835MHz System Validation Kit	D835V2	4d091	Nov. 18, 2011	Nov. 16, 2013
SPEAG	1900MHz System Validation Kit	D1900V2	5d118	Nov. 21, 2011	Nov. 16, 2013
SPEAG	2450MHz System Validation Kit	D2450V2	736	Jul. 25, 2011	Jul. 24, 2013
SPEAG	Data Acquisition Electronics	DAE4	1210	Dec. 05, 2012	Dec. 04, 2013
SPEAG	Dosimetric E-Field Probe	EX3DV4	3857	Jun. 20, 2012	Jun. 19, 2013
SPEAG	ELI4 Phantom	QD OVA 001 BB	1079	NCR	NCR
SPEAG	Phone Positioner	N/A	N/A	NCR	NCR
Agilent	Wireless Communication Test Set	E5515E	MY52112100	Oct. 25, 2012	Oct. 24, 2013
R&S	Universal Radio Communication Tester	CMU200	116456	Sep. 19, 2012	Sep. 18, 2013
Agilent	ENA Series Network Analyzer	E5071C	MY46111157	Apr. 13, 2012	Apr. 12, 2013
R&S	Signal Generator	SMR40	100455	Jan. 18, 2013	Jan. 17, 2014
Agilent	Power Meter	E4416A	MY45101555	Aug. 22, 2012	Aug. 21, 2013
Agilent	Power Sensor	E9327A	MY44421198	Aug. 22, 2012	Aug. 21, 2013
Woken	Attenuator 1	WK0602-XX	N/A	Note 4	
PE	Attenuator 2	PE7005-10	N/A	Note 4	
PE	Attenuator 3	PE7005- 3	N/A	Note 4	
Agilent	Dual Directional Coupler	778D	50422	Note 4	
Agilent	Dielectric Probe Kit	85070D	US01440205	Note 5	
AR	Power Amplifier	5S1G4M2	0328767	Note 6	
R&S	Spectrum Analyzer	FSP30	101399	Jun. 01, 2012	May 31, 2013

**Table 5.1 Test Equipment List**

**Note:**

1. The calibration certificate of DASY can be referred to appendix C of this report.
2. Referring to KDB 865664 D01v01, the dipole calibration interval can be extended to 3 years with justification. The dipoles are also not physically damaged, or repaired during the interval.
3. The justification data of dipole D835V2, SN: 4d091; D1900V2, SN: 5d118, D2450V2, SN: 736 can be found in appendix C. The return loss is < -20dB, within 20% of prior calibration, the impedance is within 5 ohm of prior calibration.
4. The Insertion Loss calibration of Dual Directional Coupler and Attenuator were characterized via the network analyzer and compensated during system check.
5. The dielectric probe kit was calibrated via the network analyzer, with the specified procedure (calibrated in pure water) and calibration kit (standard) short circuit, before the dielectric measurement. The specific procedure and calibration kit are provided by Agilent.
6. In system check we need to monitor the level on the power meter, and adjust the power amplifier level to have precise power level to the dipole; the measured SAR will be normalized to 1W input power according to the ratio of 1W to the input power to the dipole. For system check, the calibration of the power amplifier is deemed not critically required for correct measurement; the power meter is critical and we do have calibration for it
7. Attenuator 1 insertion loss is calibrated by the network Analyzer, which the calibration is valid, before system check.

## 6. Tissue Simulating Liquids

For the measurement of the field distribution inside the SAM phantom with DASY, the phantom must be filled with around 25 liters of homogeneous body tissue simulating liquid. For head SAR testing, the liquid height from the ear reference point (ERP) of the phantom to the liquid top surface is larger than 15 cm, which is shown in Fig. 6.1. For body SAR testing, the liquid height from the center of the flat phantom to the liquid top surface is larger than 15 cm, which is shown in Fig. 6.2.



Fig 6.1 Photo of Liquid Height for Body SAR

The following table gives the recipes for tissue simulating liquid.

Frequency (MHz)	Water (%)	Sugar (%)	Cellulose (%)	Salt (%)	Preventol (%)	DGBE (%)	Conductivity ( $\sigma$ )	Permittivity ( $\epsilon_r$ )
835	50.8	48.2	0	0.9	0.1	0	0.97	55.2
1800, 1900, 2000	70.2	0	0	0.4	0	29.4	1.52	53.3
2450	68.6	0	0	0	0	31.4	1.95	52.7

Table 6.1 Recipes of Tissue Simulating Liquid

The dielectric parameters of the liquids were verified prior to the SAR evaluation using an Agilent 85070D Dielectric Probe Kit and an Agilent Network Analyzer.

The following table shows the measuring results for simulating liquid.

Frequency (MHz)	Liquid Type	Liquid Temp. (°C)	Conductivity ( $\sigma$ )	Permittivity ( $\epsilon_r$ )	Conductivity Target ( $\sigma$ )	Permittivity Target ( $\epsilon_r$ )	Delta ( $\sigma$ ) (%)	Delta ( $\epsilon_r$ ) (%)	Limit (%)	Date
835	Body	21.1	0.983	54.851	0.97	55.2	1.34	-0.63	±5	Apr. 08, 2013
1900	Body	21.3	1.55	53.363	1.52	53.3	1.97	0.12	±5	Apr. 08, 2013
2450	Body	21.5	2.002	53.464	1.95	52.7	2.67	1.45	±5	Apr. 10, 2013

Table 6.2 Measuring Results for Simulating Liquid

## 7. SAR System Verification

Each DASY system is equipped with one or more system validation kits. These units, together with the predefined measurement procedures within the DASY software, enable the user to conduct the system performance check and system validation. System validation kit includes a dipole, tripod holder to fix it underneath the flat phantom and a corresponding distance holder.

### 7.1 Purpose of System Performance check

The system performance check verifies that the system operates within its specifications. System and operator errors can be detected and corrected. It is recommended that the system performance check be performed prior to any usage of the system in order to guarantee reproducible results. The system performance check uses normal SAR measurements in a simplified setup with a well characterized source. This setup was selected to give a high sensitivity to all parameters that might fail or vary over time. The system check does not intend to replace the calibration of the components, but indicates situations where the system uncertainty is exceeded due to drift or failure.

### 7.2 System Setup

In the simplified setup for system evaluation, the EUT is replaced by a calibrated dipole and the power source is replaced by a continuous wave that comes from a signal generator. The calibrated dipole must be placed beneath the flat phantom section of the SAM twin phantom with the correct distance holder. The distance holder should touch the phantom surface with a light pressure at the reference marking and be oriented parallel to the long side of the phantom. The equipment setup is shown below:

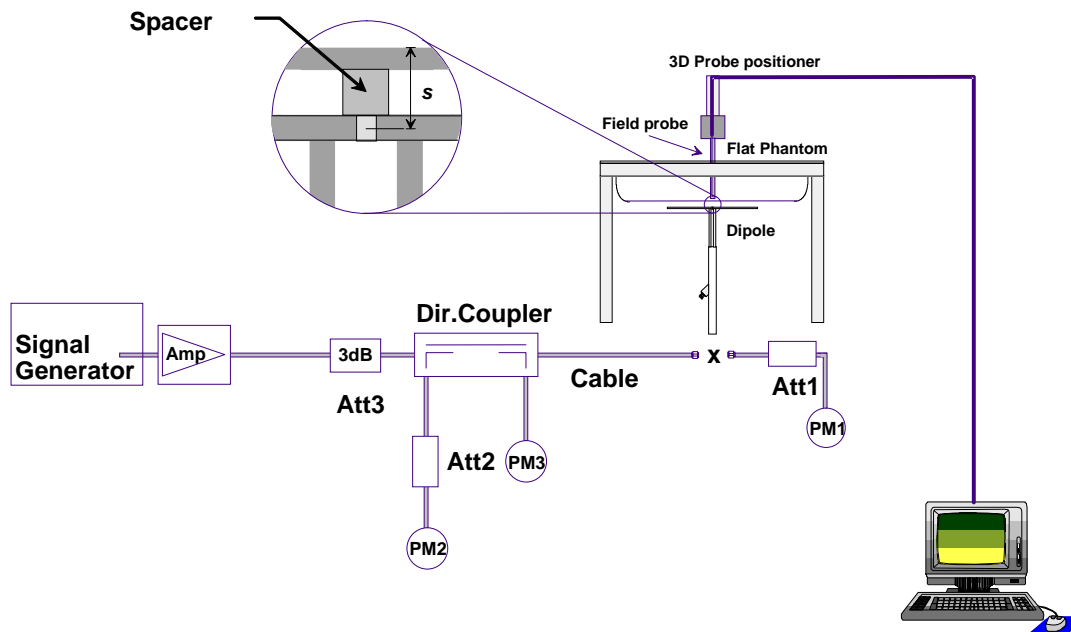

Fig 7.1 System Setup for System Evaluation

1. Signal Generator
2. Amplifier
3. Directional Coupler
4. Power Meter
5. Calibrated Dipole



**Fig 7.2 Photo of Dipole Setup**

**7.3 SAR System Verification Results**

Comparing to the original SAR value provided by SPEAG, the verification data should be within its specification of 10 %. Table 7.1 shows the target SAR and measured SAR after normalized to 1W input power. The table below indicates the system performance check can meet the variation criterion and the plots can be referred to Appendix A of this report.

Date	Frequency (MHz)	Liquid Type	Power fed onto reference dipole (mW)	Targeted SAR <sub>1g</sub> (W/kg)	Measured SAR <sub>1g</sub> (W/kg)	Normalized SAR <sub>1g</sub> (W/kg)	Deviation (%)
Apr. 08, 2013	835	Body	250	9.42	2.35	9.4	-0.21
Apr. 08, 2013	1900	Body	250	41.8	10.4	41.6	-0.48
Apr. 10, 2013	2450	Body	250	52.3	13.4	53.6	2.49

**Table 7.1 Target and Measurement SAR after Normalized**

## 8. EUT Testing Position

This EUT was tested in three different positions. They are bottom-face of tablet PC, Edge1 and Edge2. EUT has proximity sensor function, it would be on bottom-face and Edge1 active, the sensor trigger distance is 1 cm for bottom-face and 0.6 cm for Edge1, EUT transmitting full power in normal mode was performed. Additional the surface of EUT is touching with phantom 0 cm for bottom-face and Edge1 reduce power, and Edge2 full power was performed. Please refer to Appendix E for the test setup photos.

## 9. Measurement Procedures

The measurement procedures are as follows:

### <Conducted power measurement>

- (a) For WWAN power measurement, use base station simulator to configure EUT WWAN transmission in conducted connection with RF cable, at maximum power in each supported wireless interface and frequency band.
- (b) Read the WWAN RF power level from the base station simulator.
- (c) For WLAN/BT power measurement, use engineering software to configure EUT WLAN/BT continuously transmission, at maximum RF power in each supported wireless interface and frequency band
- (d) Connect EUT RF port through RF cable to the power meter, and measure WLAN/BT output power

### <SAR measurement>

- (a) Use base station simulator to configure EUT WWAN transmission in radiated connection, and engineering software to configure EUT WLAN/BT continuously transmission, at maximum RF power, in the highest power channel.
- (b) Place the EUT in the positions as Appendix E demonstrates.
- (c) Set scan area, grid size and other setting on the DASY software.
- (d) Measure SAR results for the highest power channel on each testing position.
- (e) Find out the largest SAR result on these testing positions of each band
- (f) Measure SAR results for other channels in worst SAR testing position if the reported SAR of highest power channel is larger than 0.8 W/kg

According to the test standard, the recommended procedure for assessing the peak spatial-average SAR value consists of the following steps:

- (a) Power reference measurement
- (b) Area scan
- (c) Zoom scan
- (d) Power drift measurement





### **9.1 Spatial Peak SAR Evaluation**

The procedure for spatial peak SAR evaluation has been implemented according to the test standard. It can be conducted for 1g and 10g, as well as for user-specific masses. The DASY software includes all numerical procedures necessary to evaluate the spatial peak SAR value.

The base for the evaluation is a "cube" measurement. The measured volume must include the 1g and 10g cubes with the highest averaged SAR values. For that purpose, the center of the measured volume is aligned to the interpolated peak SAR value of a previously performed area scan.

The entire evaluation of the spatial peak values is performed within the post-processing engine (SEMCAD). The system always gives the maximum values for the 1g and 10g cubes. The algorithm to find the cube with highest averaged SAR is divided into the following stages:

- (a) Extraction of the measured data (grid and values) from the Zoom Scan
- (b) Calculation of the SAR value at every measurement point based on all stored data (A/D values and measurement parameters)
- (c) Generation of a high-resolution mesh within the measured volume
- (d) Interpolation of all measured values from the measurement grid to the high-resolution grid
- (e) Extrapolation of the entire 3-D field distribution to the phantom surface over the distance from sensor to surface
- (f) Calculation of the averaged SAR within masses of 1g and 10g

### **9.2 Power Reference Measurement**

The Power Reference Measurement and Power Drift Measurements are for monitoring the power drift of the device under test in the batch process. The minimum distance of probe sensors to surface determines the closest measurement point to phantom surface. This distance cannot be smaller than the distance of sensor calibration points to probe tip as defined in the probe properties.

### 9.3 Area & Zoom Scan Procedures

First Area Scan is used to locate the approximate location(s) of the local peak SAR value(s). The measurement grid within an Area Scan is defined by the grid extent, grid step size and grid offset. Next, in order to determine the EM field distribution in a three-dimensional spatial extension, Zoom Scan is required. The Zoom Scan is performed around the highest E-field value to determine the averaged SAR-distribution over 10 g. Area scan and zoom scan resolution setting follows KDB 865664 D01v01 quoted below.

For any secondary peaks found in the area scan which are within 2 dB of the maximum peak and are not within this zoom scan, the zoom scan should be repeated

		$\leq 3$ GHz	$> 3$ GHz	
Maximum distance from closest measurement point (geometric center of probe sensors) to phantom surface		$5 \pm 1$ mm	$\frac{1}{2} \cdot \delta \cdot \ln(2) \pm 0.5$ mm	
Maximum probe angle from probe axis to phantom surface normal at the measurement location		$30^\circ \pm 1^\circ$	$20^\circ \pm 1^\circ$	
Maximum area scan spatial resolution: $\Delta x_{Area}, \Delta y_{Area}$		$\leq 2$ GHz: $\leq 15$ mm 2 – 3 GHz: $\leq 12$ mm	3 – 4 GHz: $\leq 12$ mm 4 – 6 GHz: $\leq 10$ mm	
		When the x or y dimension of the test device, in the measurement plane orientation, is smaller than the above, the measurement resolution must be $\leq$ the corresponding x or y dimension of the test device with at least one measurement point on the test device.		
Maximum zoom scan spatial resolution: $\Delta x_{Zoom}, \Delta y_{Zoom}$		$\leq 2$ GHz: $\leq 8$ mm 2 – 3 GHz: $\leq 5$ mm*	3 – 4 GHz: $\leq 5$ mm* 4 – 6 GHz: $\leq 4$ mm*	
Maximum zoom scan spatial resolution, normal to phantom surface	uniform grid: $\Delta z_{Zoom}(n)$	$\leq 5$ mm	3 – 4 GHz: $\leq 4$ mm 4 – 5 GHz: $\leq 3$ mm 5 – 6 GHz: $\leq 2$ mm	
	graded grid	$\Delta z_{Zoom}(1)$ : between 1 <sup>st</sup> two points closest to phantom surface	$\leq 4$ mm	3 – 4 GHz: $\leq 3$ mm 4 – 5 GHz: $\leq 2.5$ mm 5 – 6 GHz: $\leq 2$ mm
		$\Delta z_{Zoom}(n>1)$ : between subsequent points	$\leq 1.5 \cdot \Delta z_{Zoom}(n-1)$	
Minimum zoom scan volume	x, y, z	$\geq 30$ mm	3 – 4 GHz: $\geq 28$ mm 4 – 5 GHz: $\geq 25$ mm 5 – 6 GHz: $\geq 22$ mm	
<p>Note: <math>\delta</math> is the penetration depth of a plane-wave at normal incidence to the tissue medium; see draft standard IEEE P1528-2011 for details.</p> <p>* When zoom scan is required and the <u>reported</u> SAR from the area scan based <i>1-g SAR estimation</i> procedures of KDB 447498 is <math>\leq 1.4</math> W/kg, <math>\leq 8</math> mm, <math>\leq 7</math> mm and <math>\leq 5</math> mm zoom scan resolution may be applied, respectively, for 2 GHz to 3 GHz, 3 GHz to 4 GHz and 4 GHz to 6 GHz.</p>				



### **9.4 Volume Scan Procedures**

The volume scan is used for assess overlapping SAR distributions for antennas transmitting in different frequency bands. It is equivalent to an oversized zoom scan used in standalone measurements. The measurement volume will be used to enclose all the simultaneous transmitting antennas. For antennas transmitting simultaneously in different frequency bands, the volume scan is measured separately in each frequency band. In order to sum correctly to compute the 1g aggregate SAR, the EUT remain in the same test position for all measurements and all volume scan use the same spatial resolution and grid spacing. When all volume scan were completed, the software, SEMCAD postprocessor can combine and subsequently superpose these measurement data to calculating the multiband SAR.

### **9.5 SAR Averaged Methods**

In DASy, the interpolation and extrapolation are both based on the modified Quadratic Shepard's method. The interpolation scheme combines a least-square fitted function method and a weighted average method which are the two basic types of computational interpolation and approximation.

Extrapolation routines are used to obtain SAR values between the lowest measurement points and the inner phantom surface. The extrapolation distance is determined by the surface detection distance and the probe sensor offset. The uncertainty increases with the extrapolation distance. To keep the uncertainty within 1% for the 1 g and 10 g cubes, the extrapolation distance should not be larger than 5 mm.

### **9.6 Power Drift Monitoring**

All SAR testing is under the EUT install full charged battery and transmit maximum output power. In DASy measurement software, the power reference measurement and power drift measurement procedures are used for monitoring the power drift of EUT during SAR test. Both these procedures measure the field at a specified reference position before and after the SAR testing. The software will calculate the field difference in dB. If the power drifts more than 5%, the SAR will be retested.

### 10. Conducted RF Output Power (Unit: dBm)

**<GSM Conducted Power>**

**Note:** Per KDB 447498 D01v05, the maximum output power channel is used for SAR testing and for further SAR test reduction.

**Maximum Average RF Power (Proximity Sensor Inactive)**

Band GSM850 TX Channel	Burst Average Power (dBm)			Frame-Average Power (dBm)		
	128	189	251	128	189	251
Frequency (MHz)	<b>824.2</b>	<b>836.4</b>	<b>848.8</b>	<b>824.2</b>	<b>836.4</b>	<b>848.8</b>
GPRS (GMSK, 1 Tx slot) – CS1	32.13	32.34	32.36	23.13	23.34	23.36
GPRS (GMSK, 2 Tx slots) – CS1	31.20	31.40	31.43	25.20	25.40	25.43
GPRS (GMSK, 3 Tx slots) – CS1	29.49	29.68	29.71	25.23	25.42	25.45
GPRS (GMSK, 4 Tx slots) – CS1	28.75	28.94	28.97	25.75	25.94	25.97
EDGE (GMSK, 1 Tx slot) – MCS1	32.12	32.34	32.35	23.12	23.34	23.35
EDGE (GMSK, 2 Tx slots) – MCS1	31.20	31.39	31.42	25.20	25.39	25.42
EDGE (GMSK, 3 Tx slots) – MCS1	29.49	29.68	29.70	25.23	25.42	25.44
EDGE (GMSK, 4 Tx slots) – MCS1	28.74	28.93	28.96	25.74	25.93	25.96
EDGE (8PSK, 1 Tx slot) – MCS5	26.75	26.35	26.20	17.75	17.35	17.20
EDGE (8PSK, 2 Tx slots) – MCS5	25.51	25.08	24.98	19.51	19.08	18.98
EDGE (8PSK, 3 Tx slots) – MCS5	23.22	22.80	22.66	18.96	18.54	18.40
EDGE (8PSK, 4 Tx slots) – MCS5	22.03	21.63	21.48	19.03	18.63	18.48

**Remark:** The frame-averaged power is linearly scaled the maximum burst averaged power over 8 time slots.

The calculated method are shown as below:

Frame-averaged power = Maximum burst averaged power (1 Tx Slot) - 9 dB

Frame-averaged power = Maximum burst averaged power (2 Tx Slots) - 6 dB

Frame-averaged power = Maximum burst averaged power (3 Tx Slots) - 4.26 dB

Frame-averaged power = Maximum burst averaged power (4 Tx Slots) - 3 dB

Band GSM1900 Tx Channel	Burst Average Power (dBm)			Frame-Average Power (dBm)		
	512	661	810	512	661	810
Frequency (MHz)	<b>1850.2</b>	<b>1880</b>	<b>1909.8</b>	<b>1850.2</b>	<b>1880</b>	<b>1909.8</b>
GPRS (GMSK, 1 Tx slot) – CS1	28.30	28.60	28.47	19.30	19.60	19.47
GPRS (GMSK, 2 Tx slots) – CS1	27.34	27.64	27.54	21.34	21.64	21.54
GPRS (GMSK, 3 Tx slots) – CS1	25.59	25.92	25.82	21.33	21.66	21.56
GPRS (GMSK, 4 Tx slots) – CS1	24.82	25.16	25.06	21.82	22.16	22.06
EDGE (GMSK, 1 Tx slot) – MCS1	28.28	28.58	28.45	19.28	19.58	19.45
EDGE (GMSK, 2 Tx slots) – MCS1	27.32	27.62	27.52	21.32	21.62	21.52
EDGE (GMSK, 3 Tx slots) – MCS1	25.57	25.90	25.80	21.31	21.64	21.54
EDGE (GMSK, 4 Tx slots) – MCS1	24.81	25.15	25.04	21.81	22.15	22.04
EDGE (8PSK, 1 Tx slot) – MCS5	25.70	25.50	25.08	16.70	16.50	16.08
EDGE (8PSK, 2 Tx slots) – MCS5	24.33	24.40	24.01	18.33	18.40	18.01
EDGE (8PSK, 3 Tx slots) – MCS5	22.23	22.06	21.66	17.97	17.80	17.40
EDGE (8PSK, 4 Tx slots) – MCS5	20.97	20.92	20.55	17.97	17.92	17.55

**Remark:** The frame-averaged power is linearly scaled the maximum burst averaged power over 8 time slots.

The calculated method are shown as below:

Frame-averaged power = Maximum burst averaged power (1 Tx Slot) - 9 dB

Frame-averaged power = Maximum burst averaged power (2 Tx Slots) - 6 dB

Frame-averaged power = Maximum burst averaged power (3 Tx Slots) - 4.26 dB

Frame-averaged power = Maximum burst averaged power (4 Tx Slots) - 3 dB



Reduced Average RF Power (Proximity Sensor active)

Band GSM850 TX Channel	Burst Average Power (dBm)			Frame-Average Power (dBm)		
	128	189	251	128	189	251
Frequency (MHz)	824.2	836.4	848.8	824.2	836.4	848.8
GPRS (GMSK, 1 Tx slot) – CS1	27.94	28.15	28.18	18.94	19.15	19.18
GPRS (GMSK, 2 Tx slots) – CS1	24.98	25.16	25.21	18.98	19.16	19.21
GPRS (GMSK, 3 Tx slots) – CS1	23.21	23.47	23.49	18.95	19.21	19.23
GPRS (GMSK, 4 Tx slots) – CS1	22.01	22.25	22.27	19.01	19.25	19.27
EDGE (GMSK, 1 Tx slot) – MCS1	27.90	28.11	28.14	18.90	19.11	19.14
EDGE (GMSK, 2 Tx slots) – MCS1	24.94	25.13	25.18	18.94	19.13	19.18
EDGE (GMSK, 3 Tx slots) – MCS1	23.19	23.44	23.50	18.93	19.18	19.24
EDGE (GMSK, 4 Tx slots) – MCS1	21.98	22.23	22.24	18.98	19.23	19.24
EDGE (8PSK, 1 Tx slot) – MCS5	21.59	21.04	20.90	12.59	12.04	11.90
EDGE (8PSK, 2 Tx slots) – MCS5	18.38	17.99	17.88	12.38	11.99	11.88
EDGE (8PSK, 3 Tx slots) – MCS5	16.60	16.31	16.17	12.34	12.05	11.91
EDGE (8PSK, 4 Tx slots) – MCS5	15.44	15.05	14.98	12.44	12.05	11.98

**Remark:** The frame-averaged power is linearly scaled the maximum burst averaged power over 8 time slots.

The calculated method are shown as below:

Frame-averaged power = Maximum burst averaged power (1 Tx Slot) - 9 dB

Frame-averaged power = Maximum burst averaged power (2 Tx Slots) - 6 dB

Frame-averaged power = Maximum burst averaged power (3 Tx Slots) - 4.26 dB

Frame-averaged power = Maximum burst averaged power (4 Tx Slots) - 3 dB

Band GSM1900 Tx Channel	Burst Average Power (dBm)			Frame-Average Power (dBm)		
	512	661	810	512	661	810
Frequency (MHz)	1850.2	1880	1909.8	1850.2	1880	1909.8
GPRS (GMSK, 1 Tx slot) – CS1	24.08	24.41	24.36	15.08	15.41	15.36
GPRS (GMSK, 2 Tx slots) – CS1	21.02	21.43	21.39	15.02	15.43	15.39
GPRS (GMSK, 3 Tx slots) – CS1	19.28	19.74	19.74	15.02	15.48	15.48
GPRS (GMSK, 4 Tx slots) – CS1	18.28	18.54	18.49	15.28	15.54	15.49
EDGE (GMSK, 1 Tx slot) – MCS1	24.04	24.37	24.31	15.04	15.37	15.31
EDGE (GMSK, 2 Tx slots) – MCS1	21.00	21.40	21.35	15.00	15.40	15.35
EDGE (GMSK, 3 Tx slots) – MCS1	19.25	19.71	19.70	14.99	15.45	15.44
EDGE (GMSK, 4 Tx slots) – MCS1	18.26	18.51	18.47	15.26	15.51	15.47
EDGE (8PSK, 1 Tx slot) – MCS5	20.41	20.20	19.82	11.41	11.20	10.82
EDGE (8PSK, 2 Tx slots) – MCS5	17.46	17.25	17.14	11.46	11.25	11.14
EDGE (8PSK, 3 Tx slots) – MCS5	15.45	15.31	15.00	11.19	11.05	10.74
EDGE (8PSK, 4 Tx slots) – MCS5	14.46	14.19	13.88	11.46	11.19	10.88

**Remark:** The frame-averaged power is linearly scaled the maximum burst averaged power over 8 time slots.

The calculated method are shown as below:

Frame-averaged power = Maximum burst averaged power (1 Tx Slot) - 9 dB

Frame-averaged power = Maximum burst averaged power (2 Tx Slots) - 6 dB

Frame-averaged power = Maximum burst averaged power (3 Tx Slots) - 4.26 dB

Frame-averaged power = Maximum burst averaged power (4 Tx Slots) - 3 dB

**Note:** Following KDB 941225 D03, for Body SAR testing, the EUT operating without power back-off was set in GPRS (4 Tx slots) and the EUT operating with power back-off was set in GPRS (4 Tx slots) due to its highest frame-average power.



**<WCDMA Conducted Power>**

The following tests were conducted according to the test requirements outlines in 3GPP TS 34.121 specification.

A summary of these settings are illustrated below:

**HSDPA Setup Configuration:**

- a. The EUT was connected to Base Station Agilent E5515C referred to the Setup Configuration.
- b. The RF path losses were compensated into the measurements.
- c. A call was established between EUT and Base Station with following setting:
  - i. Set Gain Factors ( $\beta_c$  and  $\beta_d$ ) and parameters were set according to each
  - ii. Specific sub-test in the following table, C10.1.4, quoted from the TS 34.121
  - iii. Set RMC 12.2Kbps + HSDPA mode.
  - iv. Set Cell Power = -86 dBm
  - v. Set HS-DSCH Configuration Type to FRC (H-set 1, QPSK)
  - vi. Select HSDPA Uplink Parameters
  - vii. Set Delta ACK, Delta NACK and Delta CQI = 8
  - viii. Set Ack-Nack Repetition Factor to 3
  - ix. Set CQI Feedback Cycle (k) to 4 ms
  - x. Set CQI Repetition Factor to 2
  - xi. Power Ctrl Mode = All Up bits
- d. The transmitted maximum output power was recorded.

**Table C.10.1.4:  $\beta$  values for transmitter characteristics tests with HS-DPCCH**

Sub-test	$\beta_c$	$\beta_d$	$\beta_d$ (SF)	$\beta_c/\beta_d$	$\beta_{HS}$ (Note 1, Note 2)	CM (dB) (Note 3)	MPR (dB) (Note 3)
1	2/15	15/15	64	2/15	4/15	0.0	0.0
2	12/15 (Note 4)	15/15 (Note 4)	64	12/15 (Note 4)	24/15	1.0	0.0
3	15/15	8/15	64	15/8	30/15	1.5	0.5
4	15/15	4/15	64	15/4	30/15	1.5	0.5

Note 1:  $\Delta_{ACK}, \Delta_{NACK}$  and  $\Delta_{CQI} = 30/15$  with  $\beta_{HS} = 30/15 * \beta_c$ .

Note 2: For the HS-DPCCH power mask requirement test in clause 5.2C, 5.7A, and the Error Vector Magnitude (EVM) with HS-DPCCH test in clause 5.13.1A, and HSDPA EVM with phase discontinuity in clause 5.13.1AA,  $\Delta_{ACK}$  and  $\Delta_{NACK} = 30/15$  with  $\beta_{HS} = 30/15 * \beta_c$ , and  $\Delta_{CQI} = 24/15$  with  $\beta_{HS} = 24/15 * \beta_c$ .

Note 3: CM = 1 for  $\beta_c/\beta_d = 12/15, \beta_{HS}/\beta_c = 24/15$ . For all other combinations of DPDCH, DPCCH and HS-DPCCH the MPR is based on the relative CM difference. This is applicable for only UEs that support HSDPA in release 6 and later releases.

Note 4: For subtest 2 the  $\beta_c/\beta_d$  ratio of 12/15 for the TFC during the measurement period (TF1, TF0) is achieved by setting the signalled gain factors for the reference TFC (TF1, TF1) to  $\beta_c = 11/15$  and  $\beta_d = 15/15$ .

**Setup Configuration**

**HSUPA Setup Configuration:**

- a. The EUT was connected to Base Station Agilent E5515C referred to the Setup Configuration.
- b. The RF path losses were compensated into the measurements.
- c. A call was established between EUT and Base Station with following setting \* :
  - i. Call Configs = 5.2B, 5.9B, 5.10B, and 5.13.2B with QPSK
  - ii. Set the Gain Factors ( $\beta_c$  and  $\beta_d$ ) and parameters (AG Index) were set according to each specific sub-test in the following table, C11.1.3, quoted from the TS 34.121
  - iii. Set Cell Power = -86 dBm
  - iv. Set Channel Type = 12.2k + HSPA
  - v. Set UE Target Power
  - vi. Power Ctrl Mode= Alternating bits
  - vii. Set and observe the E-TFCl
  - viii. Confirm that E-TFCl is equal to the target E-TFCl of 75 for sub-test 1, and other subtest's E-TFCl
- d. The transmitted maximum output power was recorded.

**Table C.11.1.3:  $\beta$  values for transmitter characteristics tests with HS-DPCCH and E-DCH**

Sub-test	$\beta_c$	$\beta_d$	$\beta_d$ (SF)	$\beta_c/\beta_d$	$\beta_{HS}$ (Note 1)	$\beta_{ec}$	$\beta_{ed}$ (Note 5) (Note 6)	$\beta_{ed}$ (SF)	$\beta_{ed}$ (Codes)	CM (dB) (Note 2)	MPR (dB) (Note 2)	AG Index (Note 6)	E-TFCl
1	11/15 (Note 3)	15/15 (Note 3)	64	11/15 (Note 3)	22/15	209/225	1309/225	4	1	1.0	0.0	20	75
2	6/15	15/15	64	6/15	12/15	12/15	94/75	4	1	3.0	2.0	12	67
3	15/15	9/15	64	15/9	30/15	30/15	$\beta_{ed1}: 47/15$ $\beta_{ed2}: 47/15$	4	2	2.0	1.0	15	92
4	2/15	15/15	64	2/15	4/15	2/15	56/75	4	1	3.0	2.0	17	71
5	15/15 (Note 4)	15/15 (Note 4)	64	15/15 (Note 4)	30/15	24/15	134/15	4	1	1.0	0.0	21	81

Note 1:  $\Delta_{ACK}, \Delta_{NACK}$  and  $\Delta_{CQI} = 30/15$  with  $\beta_{hs} = 30/15 * \beta_c$ .

Note 2: CM = 1 for  $\beta_c/\beta_d = 12/15, \beta_{hs}/\beta_c = 24/15$ . For all other combinations of DPDCH, DPCCH, HS- DPCCH, E-DPDCH and E-DPCCH the MPR is based on the relative CM difference.

Note 3: For subtest 1 the  $\beta_c/\beta_d$  ratio of 11/15 for the TFC during the measurement period (TF1, TF0) is achieved by setting the signalled gain factors for the reference TFC (TF1, TF1) to  $\beta_c = 10/15$  and  $\beta_d = 15/15$ .

Note 4: For subtest 5 the  $\beta_c/\beta_d$  ratio of 15/15 for the TFC during the measurement period (TF1, TF0) is achieved by setting the signalled gain factors for the reference TFC (TF1, TF1) to  $\beta_c = 14/15$  and  $\beta_d = 15/15$ .

Note 5: In case of testing by UE using E-DPDCH Physical Layer category 1, Sub-test 3 is omitted according to TS25.306 Table 5.1g.

Note 6:  $\beta_{ed}$  can not be set directly, it is set by Absolute Grant Value.

**Setup Configuration**

**HSPA+ 3GPP release 7 (uplink category 7) 16QAM, Setup Configuration:**

- a. The EUT was connected to Base Station Agilent E5515C referred to the Setup Configuration.
- b. The RF path losses were compensated into the measurements.
- c. A call was established between EUT and Base Station with following setting \* :
  - i. Call Configs = 5.2E:HSPA+:UL with 16QAM
  - ii. Set the Gain Factors ( $\beta_c$  and  $\beta_d$ ) and parameters (AG Index) were set according to each specific sub-test in the following table, C11.1.4, quoted from the TS 34.121-1 s5.2E
  - iii. Set Channel Params
  - iv. Set Cell Power = -86 dBm
  - v. Set Channel Type = HSPA
  - vi. Set UE Target Power =21 dBm
  - vii. Power Ctrl Mode= All Up Bits
  - viii. Set Manual Uplink DPCH Bc/Bd = Manual
  - ix. Set Manual Uplink DPCH Bc and Bd=15,15(for 34.121-1 v8.10.0 table C11.1.4 sub-test 1)
  - x. Set HSPA Conn DL Channel Levels
  - xi. Set HS-SCCH Configs
  - xii. Set RB Test Mode Setup
  - xiii. Set Common HSUPA Parameters
  - xiv. Set Serving Grant
  - xv. Confirm that E-TFCI is equal to the target E-TFCI of 105 for sub-test 1, and other subtest's E-TFCI
- d. The transmitted maximum output power was recorded.

**Table C.11.1.4:  $\beta$  values for transmitter characteristics tests with HS-DPCCH and E-DCH with 16QAM**

Sub-test	$\beta_c$ (Note3)	$\beta_d$	$\beta_{HS}$ (Note1)	$\beta_{ec}$	$\beta_{ed}$ (2xSF2) (Note 4)	$\beta_{ed}$ (2xSF4) (Note 4)	CM (dB) (Note 2)	MPR (dB) (Note 2)	AG Index (Note 4)	E-TFCI (Note 5)	E-TFCI (boost)
1	1	0	30/15	30/15	$\beta_{ed1}$ : 30/15 $\beta_{ed2}$ : 30/15	$\beta_{ed3}$ : 24/15 $\beta_{ed4}$ : 24/15	3.5	2.5	14	105	105

Note 1:  $\Delta_{ACK}, \Delta_{NACK}$  and  $\Delta_{CQI} = 30/15$  with  $\beta_{fs} = 30/15 * \beta_c$ .

Note 2: CM = 3.5 and the MPR is based on the relative CM difference, MPR = MAX(CM-1,0).

Note 3: DPDCH is not configured, therefore the  $\beta_c$  is set to 1 and  $\beta_d = 0$  by default.

Note 4:  $\beta_{ed}$  can not be set directly; it is set by Absolute Grant Value.

Note 5: All the sub-tests require the UE to transmit 2SF2+2SF4 16QAM EDCH and they apply for UE using E-DPDCH category 7. E-DCH TTI is set to 2ms TTI and E-DCH table index = 2. To support these E-DCH configurations DPDCH is not allocated. The UE is signaled to use the extrapolation algorithm.

**Setup Configuration**



**DC-HSDPA 3GPP release 8 Setup Configuration:**

- a. The EUT was connected to Base Station Agilent E5515C referred to the Setup Configuration below
- b. The RF path losses were compensated into the measurements.
- c. A call was established between EUT and Base Station with following setting:
  - i. Set RMC 12.2Kbps + HSDPA mode.
  - ii. Set Cell Power = -25 dBm
  - iii. Set HS-DSCH Configuration Type to FRC (H-set 12, QPSK)
  - iv. Select HSDPA Uplink Parameters
  - v. Set Gain Factors ( $\beta_c$  and  $\beta_d$ ) and parameters were set according to each Specific sub-test in the following table, C10.1.4, quoted from the TS 34.121
    - a). Subtest 1:  $\beta_c/\beta_d=2/15$
    - b). Subtest 2:  $\beta_c/\beta_d=12/15$
    - c). Subtest 3:  $\beta_c/\beta_d=15/8$
    - d). Subtest 4:  $\beta_c/\beta_d=15/4$
  - vi. Set Delta ACK, Delta NACK and Delta CQI = 8
  - vii. Set Ack-Nack Repetition Factor to 3
  - viii. Set CQI Feedback Cycle (k) to 4 ms
  - ix. Set CQI Repetition Factor to 2
  - x. Power Ctrl Mode = All Up bits
- d. The transmitted maximum output power was recorded.

The following tests were conducted according to the test requirements outlines in 3GPP TS 34.121 specification. A summary of these settings are illustrated below:

**C.8.1.12 Fixed Reference Channel Definition H-Set 12**

**Table C.8.1.12: Fixed Reference Channel H-Set 12**

Parameter	Unit	Value
Nominal Avg. Inf. Bit Rate	kbps	60
Inter-TTI Distance	TTI's	1
Number of HARQ Processes	Processes	6
Information Bit Payload ( $N_{INF}$ )	Bits	120
Number Code Blocks	Blocks	1
Binary Channel Bits Per TTI	Bits	960
Total Available SML's in UE	SML's	19200
Number of SML's per HARQ Proc.	SML's	3200
Coding Rate		0.15
Number of Physical Channel Codes	Codes	1
Modulation		QPSK
Note 1: The RMC is intended to be used for DC-HSDPA mode and both cells shall transmit with identical parameters as listed in the table. Note 2: Maximum number of transmission is limited to 1, i.e., retransmission is not allowed. The redundancy and constellation version 0 shall be used.		

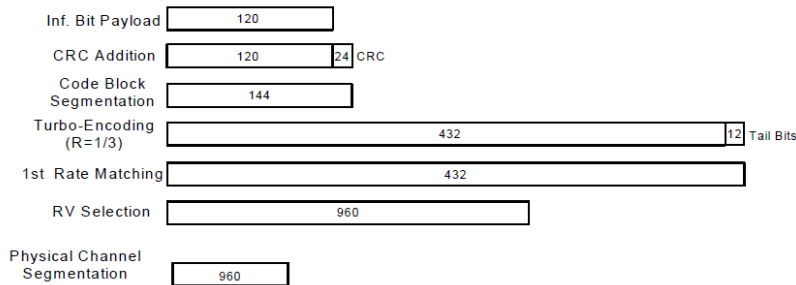

**Figure C.8.19: Coding rate for Fixed reference Channel H-Set 12 (QPSK)**

**Setup Configuration**



<WCDMA Conducted Power>

Note: By design, HSDPA/HSUPA/DC-HSDPA and HSPA+ RF power will not be larger than RMC 12.2kbps.

Maximum Average RF Power (Proximity Sensor Inactive)

		Average power (dBm)					
Band		WCDMA Band V			WCDMA Band II		
TX Channel		4132	4182	4233	9262	9400	9538
RX Channel		4357	4407	4458	9662	9800	9938
Frequency (MHz)		826.4	836.4	846.6	1852.4	1880	1907.6
3GPP Rel 99	RMC 12.2kbps	22.44	22.59	22.40	22.24	22.05	22.25
3GPP Rel 7	HSDPA Subtest-1	21.56	21.46	21.41	21.07	21.11	20.83
3GPP Rel 7	HSDPA Subtest-2	21.52	21.44	21.40	21.05	21.17	20.81
3GPP Rel 7	HSDPA Subtest-3	21.05	20.99	20.91	20.54	20.59	20.37
3GPP Rel 7	HSDPA Subtest-4	20.98	20.98	20.90	20.50	20.57	20.35
3GPP Rel 8	DC-HSDPA Subtest-1	21.39	21.28	21.26	21.02	21.09	20.77
3GPP Rel 8	DC-HSDPA Subtest-2	21.39	21.33	21.19	20.89	20.77	20.72
3GPP Rel 8	DC-HSDPA Subtest-3	20.92	20.81	20.93	20.66	20.39	20.22
3GPP Rel 8	DC-HSDPA Subtest-4	20.78	20.78	20.88	20.51	20.33	20.31
3GPP Rel 7	HSUPA Subtest-1	20.03	20.14	20.01	19.72	19.79	19.63
3GPP Rel 7	HSUPA Subtest-2	19.51	19.64	19.52	18.94	19.00	18.80
3GPP Rel 7	HSUPA Subtest-3	20.58	20.65	20.55	20.00	20.07	19.77
3GPP Rel 7	HSUPA Subtest-4	19.04	19.13	18.97	18.46	18.44	18.24
3GPP Rel 7	HSUPA Subtest-5	21.06	21.12	21.03	20.48	21.00	20.26
3GPP Rel 7	HSPA+ (16QAM) Subtest-1	20.62	20.51	20.33	20.19	20.00	19.89
		MPR result (dB)					
3GPP MPR specification		WCDMA Band V			WCDMA Band II		
0	HSDPA Subtest-1	0.00	0.00	0.00	0.00	0.00	0.00
0	HSDPA Subtest-2	0.04	0.02	0.01	0.02	-0.06	0.02
≤0.5	HSDPA Subtest-3	0.51	0.47	0.50	0.53	0.52	0.46
≤0.5	HSDPA Subtest-4	0.58	0.48	0.51	0.57	0.54	0.48
0	DC-HSDPA Subtest-1	0.00	0.00	0.00	0.00	0.00	0.00
0	DC-HSDPA Subtest-2	0.00	-0.05	0.07	0.13	0.32	0.05
≤0.5	DC-HSDPA Subtest-3	0.47	0.47	0.33	0.36	0.70	0.55
≤0.5	DC-HSDPA Subtest-4	0.61	0.50	0.38	0.51	0.76	0.46
≤0	HSUPA Subtest-1	1.03	0.98	1.02	0.76	1.21	0.63
≤2	HSUPA Subtest-2	1.55	1.48	1.51	1.54	2.00	1.46
≤1	HSUPA Subtest-3	0.48	0.47	0.48	0.48	0.93	0.49
≤2	HSUPA Subtest-4	2.02	1.99	2.06	2.02	2.56	2.02
≤0	HSUPA Subtest-5	0.00	0.00	0.00	0.00	0.00	0.00
≤2.5	HSPA+ (16QAM) Subtest-1	0.44	0.61	0.70	0.29	1.00	0.37



Reduced Average RF Power (Proximity Sensor active)

		Average power (dBm)					
Band		WCDMA Band V			WCDMA Band II		
TX Channel		4132	4182	4233	9262	9400	9538
RX Channel		4357	4407	4458	9662	9800	9938
Frequency (MHz)		826.4	836.4	846.6	1852.4	1880	1907.6
3GPP Rel 99	RMC 12.2kbps	17.40	17.53	17.41	17.27	16.92	17.28
3GPP Rel 7	HSDPA Subtest-1	17.46	17.44	17.34	16.96	16.92	16.83
3GPP Rel 7	HSDPA Subtest-2	17.47	17.38	17.34	16.96	16.97	16.81
3GPP Rel 7	HSDPA Subtest-3	17.00	16.95	16.88	16.52	16.52	16.34
3GPP Rel 7	HSDPA Subtest-4	17.03	16.89	16.84	16.50	16.58	16.32
3GPP Rel 8	DC-HSDPA Subtest-1	17.33	17.29	17.31	16.91	16.93	16.89
3GPP Rel 8	DC-HSDPA Subtest-2	17.38	17.19	17.21	16.88	16.85	16.82
3GPP Rel 8	DC-HSDPA Subtest-3	16.89	16.71	16.93	16.39	16.48	16.29
3GPP Rel 8	DC-HSDPA Subtest-4	16.82	16.68	16.88	16.41	16.39	16.17
3GPP Rel 7	HSUPA Subtest-1	15.24	15.26	15.16	15.07	15.11	15.09
3GPP Rel 7	HSUPA Subtest-2	14.76	14.75	14.70	14.41	14.39	14.36
3GPP Rel 7	HSUPA Subtest-3	15.76	15.74	15.69	15.46	15.37	15.32
3GPP Rel 7	HSUPA Subtest-4	14.20	14.25	14.22	13.98	13.99	13.86
3GPP Rel 7	HSUPA Subtest-5	16.70	16.69	16.63	16.46	16.36	16.28
3GPP Rel 7	HSPA+ (16QAM) Subtest-1	16.12	16.02	16.11	15.79	15.62	15.51
		MPR result (dB)					
3GPP MPR specification		WCDMA Band V			WCDMA Band II		
0	HSDPA Subtest-1	0.00	0.00	0.00	0.00	0.00	0.00
0	HSDPA Subtest-2	-0.01	0.06	0.00	0.00	-0.05	0.02
≤0.5	HSDPA Subtest-3	0.46	0.49	0.46	0.44	0.40	0.49
≤0.5	HSDPA Subtest-4	0.43	0.55	0.50	0.46	0.34	0.51
0	DC-HSDPA Subtest-1	0.00	0.00	0.00	0.00	0.00	0.00
0	DC-HSDPA Subtest-2	-0.05	0.10	0.10	0.03	0.08	0.07
≤0.5	DC-HSDPA Subtest-3	0.44	0.58	0.38	0.52	0.45	0.60
≤0.5	DC-HSDPA Subtest-4	0.51	0.61	0.43	0.50	0.54	0.72
≤0	HSUPA Subtest-1	1.46	1.43	1.47	1.39	1.25	1.19
≤2	HSUPA Subtest-2	1.94	1.94	1.93	2.05	1.97	1.92
≤1	HSUPA Subtest-3	0.94	0.95	0.94	1.00	0.99	0.96
≤2	HSUPA Subtest-4	2.50	2.44	2.41	2.48	2.37	2.42
≤0	HSUPA Subtest-5	0.00	0.00	0.00	0.00	0.00	0.00
≤2.5	HSPA+ (16QAM) Subtest-1	0.58	0.67	0.52	0.67	0.74	0.77



<WLAN 2.4GHz Band Conducted Power>

802.11b Average Power (dBm)					
Channel	Frequency (MHz)	Data Rate (bps)			
		1M bps	2M bps	5.5M bps	11M bps
CH 01	2412	13.17	13.12	13.15	13.10
CH 06	2437	13.62	13.51	13.53	13.46
CH 11	2462	13.61	13.38	13.40	13.45

802.11g Average Power (dBm)									
Channel	Frequency (MHz)	Data Rate (bps)							
		6M bps	9M bps	12M bps	18M bps	24M bps	36M bps	48M bps	54M bps
CH 01	2412	10.31	10.32	10.28	10.08	10.15	10.17	10.22	10.08
CH 06	2437	10.64	10.58	10.57	10.62	10.59	10.63	10.52	10.55
CH 11	2462	10.46	10.51	10.40	10.50	10.50	10.55	10.61	10.49

WLAN 2.4GHz Band 802.11n-HT20 Average Power (dBm)									
Channel	Frequency (MHz)	MCS Index							
		MCS0	MCS1	MCS2	MCS3	MCS4	MCS5	MCS6	MCS7
CH 01	2412	10.43	10.39	10.41	10.27	10.22	10.32	10.28	10.28
CH 06	2437	10.92	10.67	10.75	10.74	10.72	10.81	10.76	10.78
CH 11	2462	10.76	10.80	10.55	10.62	10.56	10.65	10.60	10.69

Note:

1. Per KDB 248227 D01 v01r02, choose the highest output power channel to test SAR and determine further SAR exclusion
2. For each frequency band, testing at higher data rates and higher order modulations is not required when the maximum average output power for each of these configurations is less than 1/4dB higher than those measured at the lowest data rate
3. Per KDB 248227 D01 v01r02, 11g and 11n-HT20 output power is less than 1/4dB higher than 11b mode, thus the SAR can be excluded.



<Bluetooth Conducted Power>

Bluetooth Average Power (dBm)										
Channel	Frequency (MHz)	Data Rate								
		DH1	DH3	DH5	2DH1	2DH3	2DH5	3DH1	3DH3	3DH5
CH 00	2402	6.34	7.06	6.56	6.44	6.24	6.14	6.40	6.16	6.16
CH 39	2441	6.88	6.93	6.98	5.72	5.39	5.30	5.54	5.30	5.27
CH 78	2480	7.16	7.37	7.52	5.87	5.60	5.57	5.80	5.60	5.50

Channel	Frequency (MHz)	Average power (dBm)
		Mode
		BT v4.0 LE, GFSK
CH 00	2402	0.31
CH 19	2440	0.55
CH 39	2480	0.97

Note:

- Per KDB 447498 D01v05, the 1-g and 10-g SAR test exclusion thresholds for 100 MHz to 6 GHz at test separation distances  $\leq 50$  mm are determined by:  

$$[(\text{max. power of channel, including tune-up tolerance, mW}) / (\text{min. test separation distance, mm})] \cdot [\sqrt{f(\text{GHz})}] \leq 3.0$$
 for 1-g SAR and  $\leq 7.5$  for 10-g extremity SAR
  - f(GHz) is the RF channel transmit frequency in GHz
  - Power and distance are rounded to the nearest mW and mm before calculation
  - The result is rounded to one decimal place for comparison

Bluetooth Max Power (dBm)	mW	Test Distance (mm)	Frequency (GHz)	exclusion thresholds
8	6.31	5	2.48	1.99

- Per KDB 447498 D01v05 exclusion thresholds is  $1.99 < 3$ , RF exposure evaluation is not required.

## 11. Exposure Positions Consideration

<Tablet PC>

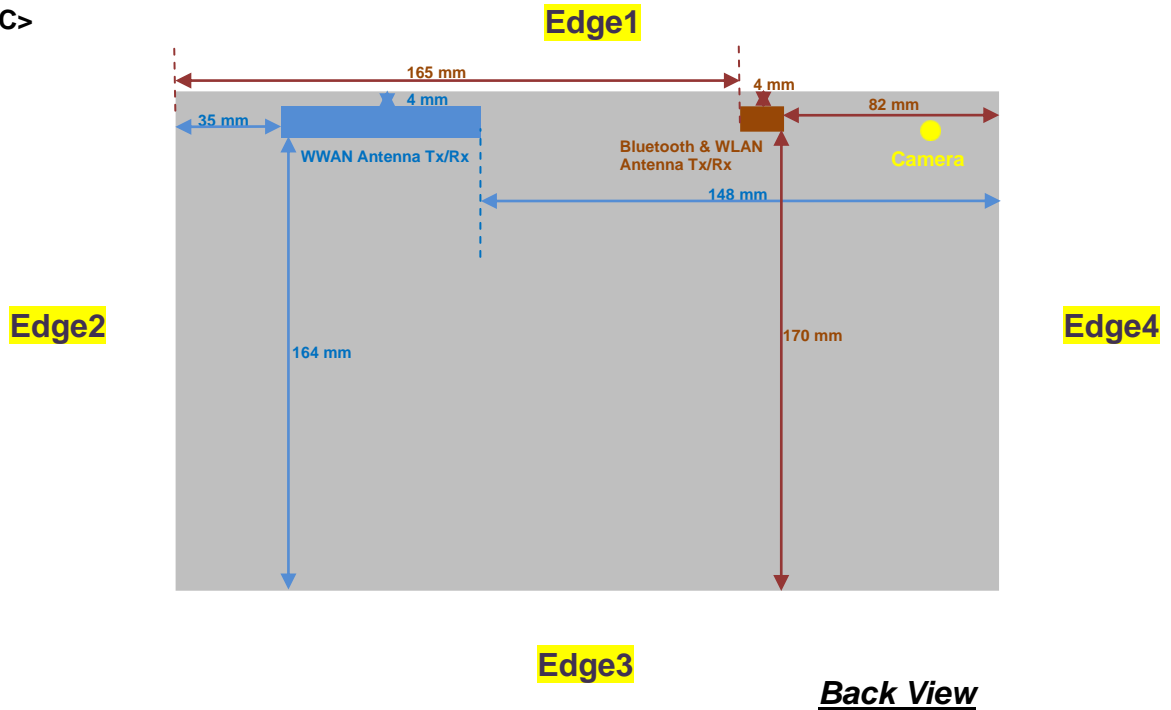

Antennas	Wireless Interface
WWAN Main Antenna (Tx / Rx)	GSM850 GSM1900 WCDMA Band V WCDMA Band II
Bluetooth & WLAN Antenna (Tx / Rx)	WLAN 2.4GHz Band Bluetooth



**SAR test exclusion table distance is ≤ 50mm**

Exposure Position	Wireless Interface	GPRS850 Class 10	GPRS1900 Class 10	WCDMA Band V	WCDMA Band II	802.11b
	Tune-up Maximum power	26	23	23	22.5	14
	Tune-up Maximum rated power(mW)	398.11	199.53	199.53	177.83	25.12
Bottom Face	Antenna to user (mm)	5				5
	SAR exclusion threshold	73.32	55.14	36.7	49.11	7.88
	SAR testing required?	Yes	Yes	Yes	Yes	Yes
Edge 1	Antenna to user (mm)	5				5
	SAR exclusion threshold	73.32	55.14	36.7	49.11	7.88
	SAR testing required?	Yes	Yes	Yes	Yes	Yes
Edge 2	Antenna to user (mm)	35				
	SAR exclusion threshold	10.47	7.88	5.24	7.02	
	SAR testing required?	Yes	Yes	Yes	Yes	

**SAR test exclusion table distance is > 50mm**

Exposure Position	Wireless Interface	GPRS850 Class 10	GPRS1900 Class 10	WCDMA Band V	WCDMA Band II	802.11b
	Tune-up Maximum power	26	23	23	22.5	14
	Tune-up Maximum rated power(mW)	398.11	199.53	199.53	177.83	25.12
Edge 2	Antenna to user (mm)					165
	SAR exclusion threshold					1245.6
	SAR testing required?					No
Edge 3	Antenna to user (mm)	164				170
	SAR exclusion threshold	807.37	1248.56	806.04	1248.62	1295.6
	SAR testing required?	No	No	No	No	No
Edge 4	Antenna to user (mm)	148				82
	SAR exclusion threshold	716.92	1088.56	715.8	1088.62	415.6
	SAR testing required?	No	No	No	No	No

**Note:**

- Maximum power is the source-based time-average power and represents the maximum RF output power among production units
- Per KDB 447498 D01v05, for larger devices, the *test separation distance* is determined by the closest separation between the antenna and the user.
- Per KDB 447498 D01v05, standalone SAR test exclusion threshold is applied; If the distance of the antenna to the user is < 5mm, 5mm is used to determine SAR exclusion threshold
- Per KDB 447498 D01v05, the 1-g and 10-g SAR test exclusion thresholds for 100 MHz to 6 GHz at *test separation distances* ≤ 50 mm are determined by:  

$$[(max. power of channel, including tune-up tolerance, mW)/(min. test separation distance, mm)] \cdot [\sqrt{f(GHz)}] \leq 3.0$$
 for 1-g SAR and ≤ 7.5 for 10-g extremity SAR
  - f(GHz) is the RF channel transmit frequency in GHz
  - Power and distance are rounded to the nearest mW and mm before calculation
  - The result is rounded to one decimal place for comparison
  - if SAR exclusion threshold > 3, RF Exposure evaluation is necessary
- Per KDB 447498 D01v05, at 100 MHz to 6 GHz and for *test separation distances* > 50 mm, the SAR test exclusion threshold is determined according to the following
  - Threshold at 50 mm in step 1) + (test separation distance - 50 mm) · ( f(MHz)/150) mW, at 100 MHz to 1500 MHz
  - Threshold at 50 mm in step 1) + (test separation distance - 50 mm) · 10] mW at > 1500 MHz and ≤ 6 GHz
- For the bottom-face that proximity sensor power reduction is applied for SAR compliance, additional SAR testing at “sensor trigger distance – 10mm for Bottom face and 6mm for Edge1” with EUT transmitting full power in normal mode was performed.



## 12. SAR Test Results

**Note:**

- Per KDB 447498 D01v05, the reported SAR is the measured SAR value adjusted for maximum tune-up tolerance.  
 $Scaling\ Factor = \frac{tune-up\ limit\ power\ (mW)}{EUT\ RF\ power\ (mW)}$ , where tune-up limit is the maximum rated power among all production units.  
 $Reported\ SAR(W/kg) = Measured\ SAR(W/kg) * Scaling\ Factor$
- For the exposure positions that proximity sensor power reduction is applied for SAR compliance, additional SAR testing with EUT transmitting full power in normal mode was performed; 1cm for bottom face and 0.6cm for edge1.
- Per KDB 447498 D01v05, for each exposure position, if the highest output channel reported SAR  $\leq 0.8W/kg$ , other channels SAR testing is not necessary.

### 12.1 Test Records for Body SAR Test

**<GSM SAR>**

Plot No.	Band	Mode	Test Position	Gap (cm)	Power Back-off	Ch.	Freq. (MHz)	Average Power (dBm)	Tune-up Limit (dBm)	Tune-up Scaling Factor	Power Drift (dB)	Measured SAR <sub>1g</sub> (W/kg)	Reported SAR <sub>1g</sub> (W/kg)
#01	GSM850	GPRS (4 Tx slots)	Bottom Face	0	On	251	848.8	22.27	22.5	1.054	0.12	0.573	0.604
#02	GSM850	GPRS (4 Tx slots)	Bottom Face	1	Off	251	848.8	28.97	29	1.007	-0.023	0.567	0.571
#03	GSM850	GPRS (4 Tx slots)	Edge1	0	On	251	848.8	22.27	22.5	1.054	0.15	0.656	0.692
#04	<b>GSM850</b>	<b>GPRS (4 Tx slots)</b>	<b>Edge1</b>	<b>0.6</b>	<b>Off</b>	<b>251</b>	<b>848.8</b>	<b>28.97</b>	<b>29</b>	<b>1.007</b>	<b>0.04</b>	<b>0.824</b>	<b>0.830</b>
#05	GSM850	GPRS (4 Tx slots)	Edge2	0	Off	251	848.8	28.97	29	1.007	0.0051	0.222	0.224
#06	GSM850	GPRS (4 Tx slots)	Edge1	0.6	Off	128	824.2	28.75	29	1.059	0.03	0.586	0.621
#07	GSM850	GPRS (4 Tx slots)	Edge1	0.6	Off	189	836.4	28.94	29	1.014	0.07	0.666	0.675
#08	GSM1900	GPRS (4 Tx slots)	Bottom Face	0	On	661	1880	18.54	19.5	1.247	-0.0086	0.752	0.938
#09	GSM1900	GPRS (4 Tx slots)	Bottom Face	1	Off	661	1880	25.16	26	1.213	0.03	0.807	0.979
#10	GSM1900	GPRS (4 Tx slots)	Edge1	0	On	661	1880	18.54	19.5	1.247	0.027	0.382	0.477
#11	GSM1900	GPRS (4 Tx slots)	Edge1	0.6	Off	661	1880	25.16	26	1.213	-0.02	1.02	1.238
#12	GSM1900	GPRS (4 Tx slots)	Edge2	0	Off	661	1880	25.16	26	1.213	-0.04	0.117	0.142
#13	GSM1900	GPRS (4 Tx slots)	Bottom Face	0	On	512	1850.2	18.28	19.5	1.324	0.031	0.734	0.972
#14	GSM1900	GPRS (4 Tx slots)	Bottom Face	0	On	810	1909.8	18.49	19.5	1.262	0.024	0.715	0.902
#15	GSM1900	GPRS (4 Tx slots)	Bottom Face	1	Off	512	1850.2	24.82	26	1.312	0.06	0.768	1.008
#16	GSM1900	GPRS (4 Tx slots)	Bottom Face	1	Off	810	1909.8	25.06	26	1.242	-0.06	0.706	0.877
#17	<b>GSM1900</b>	<b>GPRS (4 Tx slots)</b>	<b>Edge1</b>	<b>0.6</b>	<b>Off</b>	<b>512</b>	<b>1850.2</b>	<b>24.82</b>	<b>26</b>	<b>1.312</b>	<b>0.07</b>	<b>0.983</b>	<b>1.290</b>
#18	GSM1900	GPRS (4 Tx slots)	Edge1	0.6	Off	810	1909.8	25.06	26	1.242	0.02	0.87	1.080





<WCDMA SAR>

Plot No.	Band	Mode	Test Position	Gap (cm)	Power Back-off	Ch.	Freq. (MHz)	Average Power (dBm)	Tune-up Limit (dBm)	Tune-up Scaling Factor	Power Drift (dB)	Measured SAR <sub>1q</sub> (W/kg)	Reported SAR <sub>1q</sub> (W/kg)
#19	WCDMA Band V	RMC12.2K	Bottom Face	0	On	4182	836.4	17.53	18	1.114	-0.06	0.346	0.386
#20	WCDMA Band V	RMC12.2K	Bottom Face	1	Off	4182	836.4	22.59	23	1.099	-0.13	0.320	0.352
#21	<b>WCDMA Band V</b>	<b>RMC12.2K</b>	<b>Edge1</b>	<b>0</b>	<b>On</b>	<b>4182</b>	<b>836.4</b>	<b>17.53</b>	<b>18</b>	<b>1.114</b>	<b>-0.03</b>	<b>0.396</b>	<b>0.441</b>
#22	WCDMA Band V	RMC12.2K	Edge1	0.6	Off	4182	836.4	22.59	23	1.099	-0.04	0.318	0.349
#23	WCDMA Band V	RMC12.2K	Edge2	0	Off	4182	836.4	22.59	23	1.099	-0.08	0.108	0.119
#26	WCDMA Band II	RMC12.2K	Bottom Face	0	On	9538	1907.6	17.28	17.5	1.052	0.02	1.14	1.199
#27	WCDMA Band II	RMC12.2K	Bottom Face	1	Off	9538	1907.6	22.25	22.5	1.059	0.09	0.704	0.746
#28	WCDMA Band II	RMC12.2K	Edge1	0	On	9538	1907.6	17.28	17.5	1.052	0.12	0.584	0.614
#29	WCDMA Band II	RMC12.2K	Edge1	0.6	Off	9538	1907.6	22.25	22.5	1.059	-0.07	0.986	1.044
#30	WCDMA Band II	RMC12.2K	Edge2	0	Off	9538	1907.6	22.25	22.5	1.059	0.02	0.115	0.122
#31	<b>WCDMA Band II</b>	<b>RMC12.2K</b>	<b>Bottom Face</b>	<b>0</b>	<b>On</b>	<b>9262</b>	<b>1852.4</b>	<b>17.27</b>	<b>17.5</b>	<b>1.054</b>	<b>0.04</b>	<b>1.37</b>	<b>1.445</b>
#33	WCDMA Band II	RMC12.2K	Bottom Face	0	On	9400	1880	16.92	17.5	1.143	0.07	1.05	1.200
#34	WCDMA Band II	RMC12.2K	Edge1	0.6	Off	9262	1852.4	22.24	22.5	1.062	-0.08	1.29	1.370
#35	WCDMA Band II	RMC12.2K	Edge1	0.6	Off	9400	1880	22.05	22.5	1.109	-0.04	1.01	1.120
#36	WCDMA Band II	HSDPA Subtest-1	Bottom Face	0	On	9262	1852.4	16.96	17.5	1.132	0.03	1.26	1.427
#37	WCDMA Band II	HSDPA Subtest-1	Bottom Face	0	On	9400	1880	16.92	17.5	1.143	0.09	0.964	1.102
#38	WCDMA Band II	HSDPA Subtest-1	Bottom Face	0	On	9538	1907.6	16.83	17.5	1.167	0.01	1.05	1.225
#49	WCDMA Band II	DC-HSDPA Subtest-1	Bottom Face	0	On	9262	1852.4	16.91	17.5	1.146	0.1	1.23	1.409
#50	WCDMA Band II	DC-HSDPA Subtest-1	Bottom Face	0	On	9400	1880	16.93	17.5	1.140	-0.07	0.987	1.125
#51	WCDMA Band II	DC-HSDPA Subtest-1	Bottom Face	0	On	9538	1907.6	16.89	17.5	1.151	-0.08	0.938	1.079
#39	WCDMA Band II	HSUPA Subtest-5	Bottom Face	0	On	9262	1852.4	16.46	16.5	1.009	0.01	1.13	1.140
#40	WCDMA Band II	HSUPA Subtest-5	Bottom Face	0	On	9400	1880	16.36	16.5	1.033	0.04	0.855	0.883
#41	WCDMA Band II	HSUPA Subtest-5	Bottom Face	0	On	9538	1907.6	16.28	16.5	1.052	0.05	0.932	0.980
#52	WCDMA Band II	HSPA+ Subtest-1	Bottom Face	0	On	9262	1852.4	15.79	16	1.050	0.07	1.08	1.134
#53	WCDMA Band II	HSPA+ Subtest-1	Bottom Face	0	On	9400	1880	15.62	16	1.091	0.04	0.789	0.861
#54	WCDMA Band II	HSPA+ Subtest-1	Bottom Face	0	On	9538	1907.6	15.51	16	1.119	-0.06	0.86	0.963

**Note:** Per KDB 941225 D01, RMC 12.2kbps setting is used to evaluate SAR. If HSDPA/DC-HSDPA/HSUPA /HSPA+ output power is < 0.25dB higher than RMC, and reported SAR with RMC 12.2kbps setting is ≤ 1.2W/kg, HSDPA/DC-HSDPA/HSUPA/HSPA+ SAR evaluation can be excluded. If Reported SAR with RMC 12.2kbps setting is > 1.2W/kg, HSDPA/DC-HSDPA/HSPA+ subtest-1 and HSUPA subtest-5 SAR is additionally tested at that exposure position.



<WLAN 2.4GHz Band SAR>

Plot No.	Band	Mode	Test Position	Gap (cm)	Power Back-off	Ch.	Freq. (MHz)	Average Power (dBm)	Tune-up Limit (dBm)	Tune-up Scaling Factor	Power Drift (dB)	Measured SAR <sub>1g</sub> (W/kg)	Reported SAR <sub>1g</sub> (W/kg)
#42	WLAN 2.4GHz Band	802.11b	Bottom Face	0	-	6	2437	13.62	14	1.091	0.01	0.886	0.976
#43	WLAN 2.4GHz Band	802.11b	Edge1	0	-	6	2437	13.62	14	1.091	0.05	0.566	0.623
#44	<b>WLAN 2.4GHz Band</b>	<b>802.11b</b>	<b>Bottom Face</b>	<b>0</b>	<b>-</b>	<b>1</b>	<b>2412</b>	<b>13.17</b>	<b>14</b>	<b>1.211</b>	<b>0.05</b>	<b>0.936</b>	<b>1.144</b>
#46	WLAN 2.4GHz Band	802.11b	Bottom Face	0	-	11	2462	13.61	14	1.094	-0.08	0.811	0.896
#47	WLAN 2.4GHz Band	802.11b	Bottom Face	1	-	1	2412	13.17	14	1.211	0.16	0.167	0.205
#48	WLAN 2.4GHz Band	802.11b	Edge1	0.6	-	6	2437	13.62	14	1.091	0.08	0.227	0.250



**12.2 Repeated SAR Measurement**

Plot No.	Band	Mode	Test Position	Gap (cm)	Power Back-off	Ch.	Freq. (MHz)	Average Power (dBm)	Tune-up Limit (dBm)	Tune-up Scaling Factor	Power Drift (dB)	Measured SAR <sub>1g</sub> (W/kg)	Ratio	Reported SAR <sub>1g</sub> (W/kg)
#04	GSM850	GPRS (4 Tx slots)	Edge1	0.6	Off	251	848.8	28.97	29	1.007	0.04	0.824	1	0.830
#55	GSM850	GPRS (4 Tx slots)	Edge1	0.6	Off	251	848.8	28.97	29	1.007	0.02	0.811	1.016	0.817
#31	WCDMA Band II	RMC12.2K	Bottom Face	0	On	9262	1852.4	17.27	17.5	1.054	0.04	1.370	1	1.445
#32	WCDMA Band II	RMC12.2K	Bottom Face	0	On	9262	1852.4	17.27	17.5	1.054	-0.05	1.370	1	1.445
#44	WLAN 2.4GHz Band	802.11b	Bottom Face	0	-	1	2412	13.17	14	1.211	0.05	0.936	1	1.144
#45	WLAN 2.4GHz Band	802.11b	Bottom Face	0	-	1	2412	13.17	14	1.211	-0.06	0.932	1.001	1.139

**Note:**

1. Per KDB 865664 D01v01, for each frequency band, repeated SAR measurement is required only when the measured SAR is  $\geq 0.8$ W/kg
2. Per KDB 865664 D01v01, if the ratio among the repeated measurement is  $\leq 1.2$  and the measured SAR  $< 1.45$ W/kg, only one repeated measurement is required.
3. The ratio is the difference in percentage between original and repeated *measured* SAR.
4. All measurement SAR result is scaled-up to account for tune-up tolerance and is compliant.

**12.3 Highest SAR Plot**

Plot No.	Band	Mode	Test Position	Gap (cm)	Power Back-off	Ch.	Freq. (MHz)	Average Power (dBm)	Tune-up Limit (dBm)	Tune-up Scaling Factor	Power Drift (dB)	Measured SAR <sub>1g</sub> (W/kg)	Reported SAR <sub>1g</sub> (W/kg)
#04	GSM850	GPRS (4 Tx slots)	Edge1	0.6	Off	251	848.8	28.97	29	1.007	0.04	0.824	0.830
#17	GSM1900	GPRS (4 Tx slots)	Edge1	0.6	Off	512	1850.2	24.82	26	1.312	0.07	0.983	1.290
#21	WCDMA Band V	RMC12.2K	Edge1	0	On	4182	836.4	17.53	18	1.114	-0.03	0.396	0.441
#31	WCDMA Band II	RMC12.2K	Bottom Face	0	On	9262	1852.4	17.27	17.5	1.054	0.04	1.370	1.445
#44	WLAN 2.4GHz Band	802.11b	Bottom Face	0	-	1	2412	13.17	14	1.211	0.05	0.936	1.144

Test Laboratory: Sporton International Inc. SAR/HAC Testing Lab

Date: 2013-4-8

**#04 GSM850\_GPRS (4 Tx slots)\_Edge1 0.6cm\_Ch251\_Sensor off**

**DUT: 331304**

Communication System: GPRS/EDGE (4 Tx slots); Frequency: 848.8 MHz; Duty Cycle: 1:2  
Medium: MSL\_835\_130408 Medium parameters used:  $f = 849$  MHz;  $\sigma = 0.997$  mho/m;  $\epsilon_r = 54.707$ ;  
 $\rho = 1000$  kg/m<sup>3</sup>  
Ambient Temperature : 23.2 °C; Liquid Temperature : 21.1 °C

**DASY5 Configuration:**

- Probe: EX3DV4 - SN3857; ConvF(8.98, 8.98, 8.98); Calibrated: 2012-6-20
- Sensor-Surface: 2mm (Mechanical Surface Detection)
- Electronics: DAE4 Sn1210; Calibrated: 2012-12-5
- Phantom: SAM3; Type: SAM; Serial: TP-1079
- Measurement SW: DASY52, Version 52.8 (4); SEMCAD X Version 14.4.5 (3634)

**Ch251/Area Scan (31x201x1):** Measurement grid: dx=15mm, dy=15mm  
Maximum value of SAR (interpolated) = 1.068 mW/g

**Ch251/Zoom Scan (5x5x7)/Cube 0:** Measurement grid: dx=8mm, dy=8mm, dz=5mm  
Reference Value = 10.000 V/m; Power Drift = 0.04 dB  
Peak SAR (extrapolated) = 1.461 W/kg  
**SAR(1 g) = 0.824 mW/g; SAR(10 g) = 0.464 mW/g**  
Maximum value of SAR (measured) = 1.149 mW/g

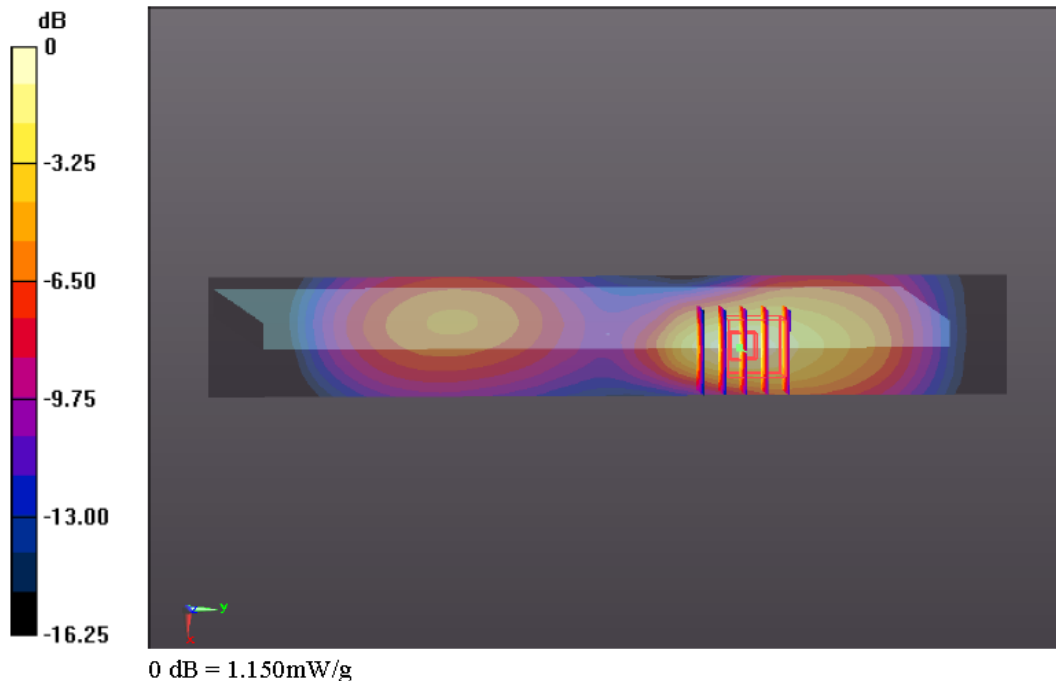

Test Laboratory: Sporton International Inc. SAR/HAC Testing Lab

Date: 2013-4-8

#17 GSM1900\_GPRS (4 Tx slots)\_Edge1 0.6cm\_Ch512\_Sensor Off

DUT: 331304

Communication System: GPRS/EDGE (4 Tx slots); Frequency: 1850.2 MHz; Duty Cycle: 1:2  
Medium: MSL\_1900\_130408 Medium parameters used:  $f = 1850.2$  MHz;  $\sigma = 1.489$  mho/m;  $\epsilon_r = 53.481$ ;  $\rho = 1000$  kg/m<sup>3</sup>  
Ambient Temperature : 23.2 °C; Liquid Temperature : 21.3 °C

DASY5 Configuration:

- Probe: EX3DV4 - SN3857; ConvF(7.35, 7.35, 7.35); Calibrated: 2012-6-20
- Sensor-Surface: 2mm (Mechanical Surface Detection)
- Electronics: DAE4 Sn1210; Calibrated: 2012-12-5
- Phantom: SAM3; Type: SAM; Serial: TP-1079
- Measurement SW: DASY52, Version 52.8 (4); SEMCAD X Version 14.4.5 (3634)

Ch512/Area Scan (31x201x1): Measurement grid: dx=15mm, dy=15mm  
Maximum value of SAR (interpolated) = 1.271 mW/g

Ch512/Zoom Scan (5x5x7)/Cube 0: Measurement grid: dx=8mm, dy=8mm, dz=5mm  
Reference Value = 11.707 V/m; Power Drift = 0.07 dB  
Peak SAR (extrapolated) = 1.749 W/kg  
SAR(1 g) = 0.983 mW/g; SAR(10 g) = 0.520 mW/g  
Maximum value of SAR (measured) = 1.385 mW/g

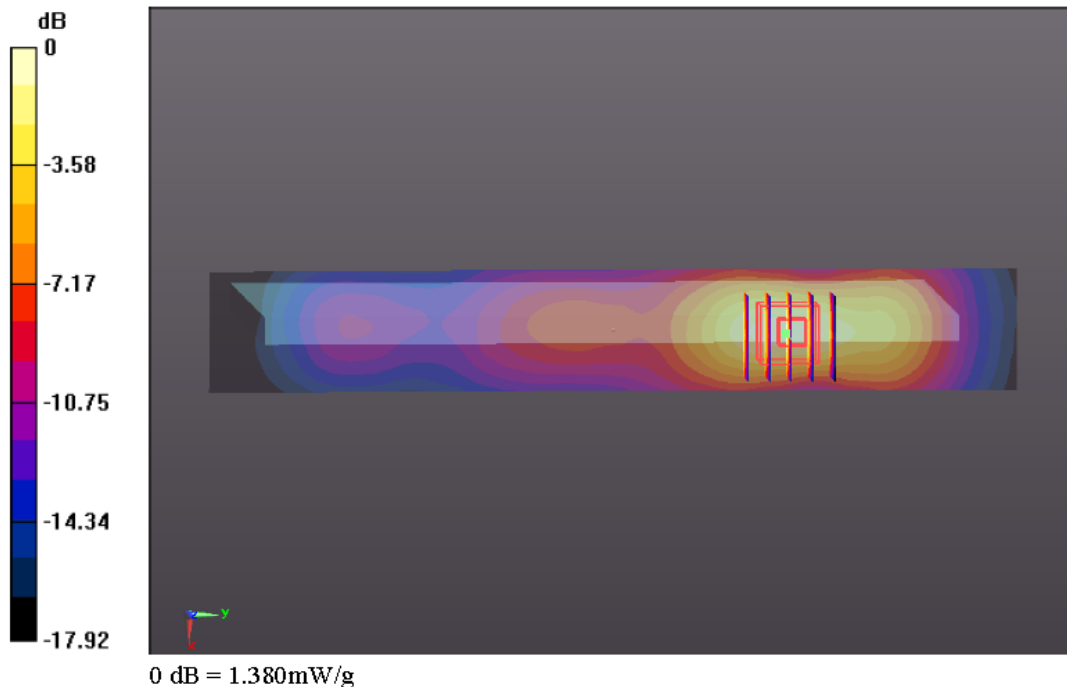

Test Laboratory: Sporton International Inc. SAR/HAC Testing Lab

Date: 2013-4-8

**#21 WCDMA Band V\_RMC12.2K\_Edge1 0cm\_Ch4182\_P-Sensor On**

**DUT: 331304**

Communication System: UMTS; Frequency: 836.4 MHz; Duty Cycle: 1:1

Medium: MSL\_835\_130408 Medium parameters used:  $f = 836.4$  MHz;  $\sigma = 0.984$  mho/m;  $\epsilon_r =$

$54.837$ ;  $\rho = 1000$  kg/m<sup>3</sup>

Ambient Temperature : 23.2 °C; Liquid Temperature : 21.1 °C

DASY5 Configuration:

- Probe: EX3DV4 - SN3857; ConvF(8.98, 8.98, 8.98); Calibrated: 2012-6-20
- Sensor-Surface: 2mm (Mechanical Surface Detection)
- Electronics: DAE4 Sn1210; Calibrated: 2012-12-5
- Phantom: SAM3; Type: SAM; Serial: TP-1079
- Measurement SW: DASY52, Version 52.8 (4); SEMCAD X Version 14.4.5 (3634)

**Ch4182/Area Scan (31x201x1):** Measurement grid: dx=15mm, dy=15mm

Maximum value of SAR (interpolated) = 0.525 mW/g

**Ch4182/Zoom Scan (5x5x7)/Cube 0:** Measurement grid: dx=8mm, dy=8mm, dz=5mm

Reference Value = 5.347 V/m; Power Drift = -0.03 dB

Peak SAR (extrapolated) = 0.848 W/kg

**SAR(1 g) = 0.396 mW/g; SAR(10 g) = 0.196 mW/g**

Maximum value of SAR (measured) = 0.598 mW/g

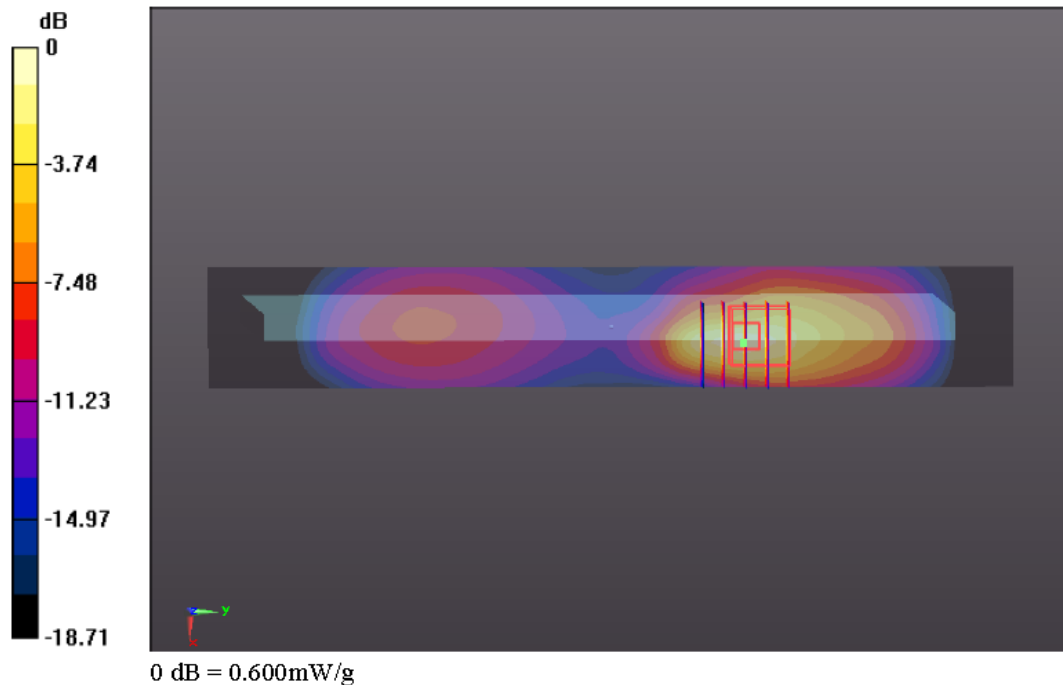

Test Laboratory: Sporton International Inc. SAR/HAC Testing Lab

Date: 2013-4-8

**#31 WCDMA Band II\_RMC12.2K\_Bottom Face 0cm\_Ch9262\_P-Sensor on**

**DUT: 331304**

Communication System: UMTS; Frequency: 1852.4 MHz; Duty Cycle: 1:1

Medium: MSL\_1900\_130408 Medium parameters used:  $f = 1852.4$  MHz;  $\sigma = 1.491$  mho/m;  $\epsilon_r =$

53.474;  $\rho = 1000$  kg/m<sup>3</sup>

Ambient Temperature : 23.2 °C; Liquid Temperature : 21.3 °C

DASY5 Configuration:

- Probe: EX3DV4 - SN3857; ConvF(7.35, 7.35, 7.35); Calibrated: 2012-6-20
- Sensor-Surface: 2mm (Mechanical Surface Detection)
- Electronics: DAE4 Sn1210; Calibrated: 2012-12-5
- Phantom: SAM3; Type: SAM; Serial: TP-1079
- Measurement SW: DASY52, Version 52.8 (4); SEMCAD X Version 14.4.5 (3634)

**Ch9262/Area Scan (151x201x1):** Measurement grid: dx=15mm, dy=15mm

Maximum value of SAR (interpolated) = 1.815 mW/g

**Ch9262/Zoom Scan (5x5x7)/Cube 0:** Measurement grid: dx=8mm, dy=8mm, dz=5mm

Reference Value = 3.410 V/m; Power Drift = 0.04 dB

Peak SAR (extrapolated) = 2.795 W/kg

**SAR(1 g) = 1.370 mW/g; SAR(10 g) = 0.681 mW/g**

Maximum value of SAR (measured) = 2.067 mW/g



Test Laboratory: Sporton International Inc. SAR/HAC Testing Lab

Date: 2013-4-10

**#44 WLAN 2.4GHz Band\_802.11b\_Bottom Face 0cm\_Ch1**

**DUT: 331304**

Communication System: WIFI; Frequency: 2412 MHz; Duty Cycle: 1:1

Medium: MSL\_2450\_130410 Medium parameters used:  $f = 2412$  MHz;  $\sigma = 1.933$  mho/m;  $\epsilon_r =$

53.535;  $\rho = 1000$  kg/m<sup>3</sup>

Ambient Temperature : 23.4 °C; Liquid Temperature : 21.5 °C

**DASY5 Configuration:**

- Probe: EX3DV4 - SN3857; ConvF(6.94, 6.94, 6.94); Calibrated: 2012-6-20
- Sensor-Surface: 2mm (Mechanical Surface Detection)
- Electronics: DAE4 Sn1210; Calibrated: 2012-12-5
- Phantom: SAM3; Type: SAM; Serial: TP-1079
- Measurement SW: DASY52, Version 52.8 (4); SEMCAD X Version 14.4.5 (3634)

**Ch1/Area Scan (181x251x1):** Measurement grid: dx=12mm, dy=12mm

Maximum value of SAR (interpolated) = 0.734 mW/g

**Ch1/Zoom Scan (7x7x7)/Cube 0:** Measurement grid: dx=5mm, dy=5mm, dz=5mm

Reference Value = 1.067 V/m; Power Drift = 0.05 dB

Peak SAR (extrapolated) = 2.615 W/kg

**SAR(1 g) = 0.936 mW/g; SAR(10 g) = 0.353 mW/g**

Maximum value of SAR (measured) = 1.700 mW/g

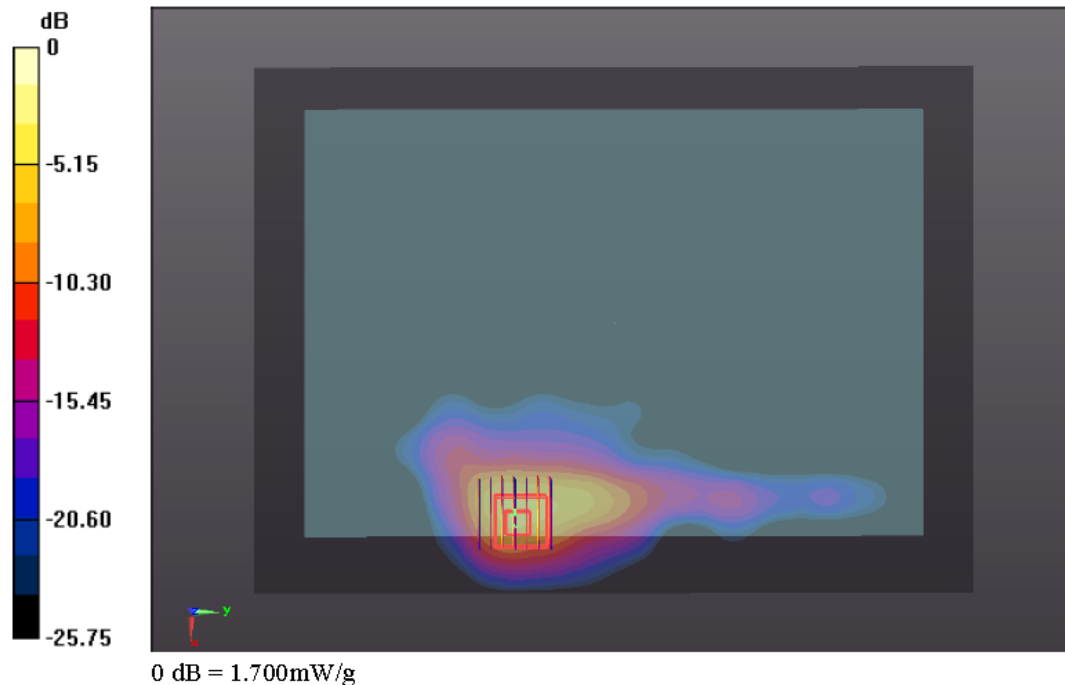



**12.4 Simultaneous Multi-band Transmission Analysis**

No.	Applicable Simultaneous Transmission Combination
1.	GSM/WCDMA (data) + WLAN 2.4GHz Band
2.	GSM/WCDMA (data) + Bluetooth

**Note:**

1. WLAN 2.4GHz Band and Bluetooth share the same antenna, and cannot transmit simultaneously.
2. EUT will choose either GSM/WCDMA according to the network signal condition; therefore, GSM/WCDMA cannot transmit simultaneously.
3. The Reported SAR summation is calculated based on the same configuration and test position.
4. For simultaneous transmission analysis, Bluetooth SAR is estimated per KDB 447498 D01v05 based on the formula below.
  - i)  $(\text{max. power of channel, including tune-up tolerance, mW}) / (\text{min. test separation distance, mm}) \cdot [\sqrt{f(\text{GHz})/x}] \text{ W/kg}$  for test separation distances  $\leq 50 \text{ mm}$ ; where  $x = 7.5$  for 1-g SAR, and  $x = 18.75$  for 10-g SAR.
  - ii)  $0.4 \text{ W/kg}$  for 1-g SAR and  $1.0 \text{ W/kg}$  for 10-g SAR, when the test separation distances is  $> 50 \text{ mm}$ .
5. Per KDB 447498 D01v05, simultaneous transmission SAR is compliant if,
  - i) Scalar SAR summation  $< 1.6 \text{ W/kg}$ .
  - ii)  $\text{SPLSR} = (\text{SAR}_1 + \text{SAR}_2)^{1.5} / (\text{min. separation distance, mm})$ , and the peak separation distance is determined from the square root of  $[(x_1-x_2)^2 + (y_1-y_2)^2 + (z_1-z_2)^2]$ , where  $(x_1, y_1, z_1)$  and  $(x_2, y_2, z_2)$  are the coordinates of the extrapolated peak SAR locations in the zoom scan  
If  $\text{SPLSR} \leq 0.04$ , simultaneously transmission SAR measurement is not necessary
  - iii) Simultaneously transmission SAR measurement, and the reported multi-band SAR  $< 1.6 \text{ W/kg}$

**Bluetooth SAR is estimated below.**

Max Power	Exposure Position	Bottom Face	Bottom Face	Edge1	Edge1	Edge2
	Test separation	0 mm	10 mm	0 mm	6 mm	0 mm
8 dBm	Antenna to user distance	5 mm	10 mm	5 mm	10 mm	165 mm
	Estimated SAR (W/kg)	0.265	0.132	0.265	0.132	0.026

In this report, 50mm separation is applied to conservatively estimate SAR value for separation distance  $> 50 \text{ mm}$ .



<Tablet SAR>

<WWAN-PCB+WLAN2.4GHz-DTS>

Position	WWAN			WLAN		WWAN + WLAN	SPLSR	Case No
	WWAN Band	Plot No	SAR (W/kg)	Plot No	SAR (W/kg)			
Bottom Face At 1cm	GSM850	2	0.571	47	0.205	<b>0.78</b>		
	GSM1900	15	1.008	47	0.205	<b>1.21</b>		
	WCDMA V	20	0.352	47	0.205	<b>0.56</b>		
	WCDMA II	27	0.704	47	0.205	<b>0.91</b>		
Edge1 At 0.6cm	GSM850	4	0.83	48	0.25	<b>1.08</b>		
	GSM1900	17	1.29	48	0.25	<b>1.54</b>		
	WCDMA V	22	0.349	48	0.25	<b>0.60</b>		
	WCDMA II	35	1.37	48	0.25	<b>1.62</b>	0.02	Case 4
Bottom Face At 0cm	GSM850	1	0.604	44	1.144	<b>1.75</b>	0.02	Case 1
	GSM1900	13	0.972	44	1.144	<b>2.12</b>	0.03	Case 2
	WCDMA V	19	0.386	44	1.144	<b>1.53</b>		
	WCDMA II	31	1.445	44	1.144	<b>2.59</b>	0.04	Case 3
Edge1 At 0cm	GSM850	3	0.692	43	0.623	<b>1.32</b>		
	GSM1900	10	0.477	43	0.623	<b>1.10</b>		
	WCDMA V	21	0.441	43	0.623	<b>1.06</b>		
	WCDMA II	28	0.614	43	0.623	<b>1.24</b>		
Edge2 At 0cm	GSM850	5	0.224			<b>0.22</b>		
	GSM1900	12	0.142			<b>0.14</b>		
	WCDMA V	23	0.119			<b>0.12</b>		
	WCDMA II	30	0.122			<b>0.12</b>		



<WWAN-PCB + Bluetooth-DSS>

Position	WWAN			Bluetooth	WWAN + Bluetooth	SPLSR	Case No
	WWAN Band	Plot No	SAR (W/kg)	Estimated SAR (W/kg)			
Bottom Face At 1cm	GSM850	2	0.571	0.132	<b>0.70</b>		
	GSM1900	15	1.008	0.132	<b>1.14</b>		
	WCDMA V	20	0.352	0.132	<b>0.48</b>		
	WCDMA II	27	0.704	0.132	<b>0.84</b>		
Edge1 At 0.6cm	GSM850	4	0.83	0.132	<b>0.96</b>		
	GSM1900	17	1.29	0.132	<b>1.42</b>		
	WCDMA V	22	0.349	0.132	<b>0.48</b>		
	WCDMA II	35	1.37	0.132	<b>1.50</b>		
Bottom Face At 0cm	GSM850	1	0.604	0.265	<b>0.87</b>		
	GSM1900	13	0.972	0.265	<b>1.24</b>		
	WCDMA V	19	0.386	0.265	<b>0.65</b>		
	WCDMA II	31	1.445	0.265	<b>1.71</b>	0.02	Case 5
Edge1 At 0cm	GSM850	3	0.692	0.265	<b>0.96</b>		
	GSM1900	10	0.477	0.265	<b>0.74</b>		
	WCDMA V	21	0.441	0.265	<b>0.71</b>		
	WCDMA II	28	0.614	0.265	<b>0.88</b>		
Edge2 At 0cm	GSM850	5	0.224	0.026	<b>0.25</b>		
	GSM1900	12	0.142	0.026	<b>0.17</b>		
	WCDMA V	23	0.119	0.026	<b>0.15</b>		
	WCDMA II	30	0.122	0.026	<b>0.15</b>		

12.5 Simultaneous analysis - SPLSR calculation

Case No. #1	Band	Position	SAR (W/kg)	Gap (cm)	SAR peak location (m)			3D distance (mm)	Pair SAR sum (W/kg)	SPLSR	Simultaneous SAR
					X	Y	Z				
#01	GSM850	Bottom Face	0.604	0	0.0905	0.052	-0.179	94.3	1.75	0.02	Not required
#44	WLAN 2.4GHz Band		1.144	0	0.0835	-0.042	-0.178				

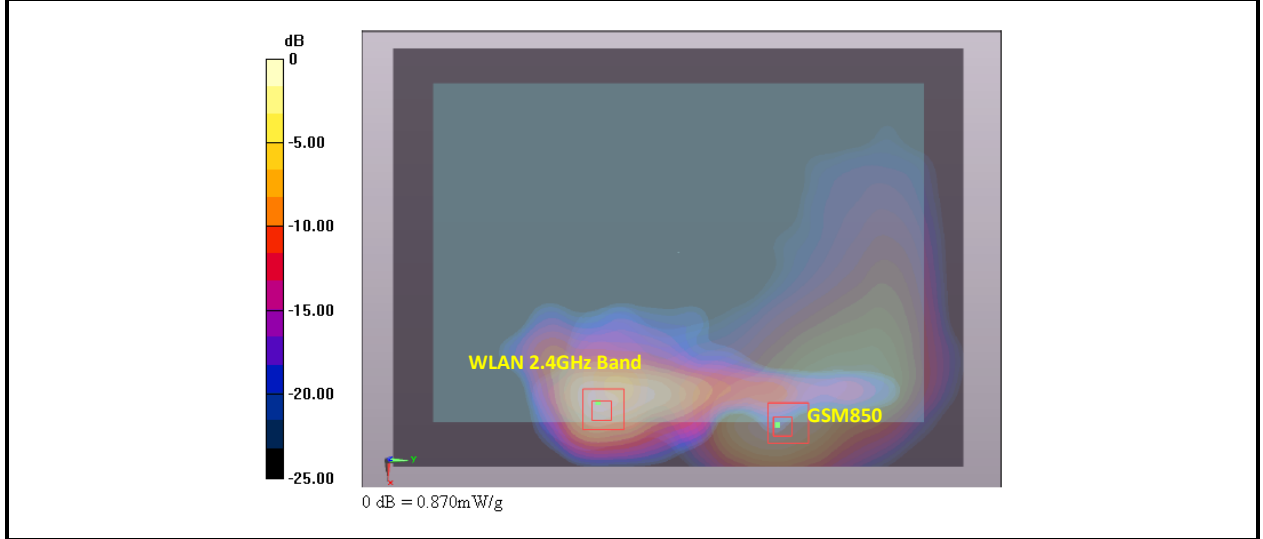

Case No. #2	Band	Position	SAR (W/kg)	Gap (cm)	SAR peak location (m)			3D distance (mm)	Pair SAR sum (W/kg)	SPLSR	Simultaneous SAR
					X	Y	Z				
#13	GSM1900	Bottom Face	0.972	0	0.0825	0.068	-0.178	110.0	2.12	0.03	Not required
#44	WLAN 2.4GHz Band		1.144	0	0.0835	-0.042	-0.178				



Case No. #3	Band	Position	SAR (W/kg)	Gap (cm)	SAR peak location (m)			3D distance (mm)	Pair SAR sum (W/kg)	SPLSR	Simultaneous SAR
					X	Y	Z				
#31	WCDMA Band II	Bottom Face	1.445	0	0.0765	0.068	-0.178	110.2	2.59	0.04	Not required
#44	WLAN 2.4GHz Band		1.144	0	0.0835	-0.042	-0.178				

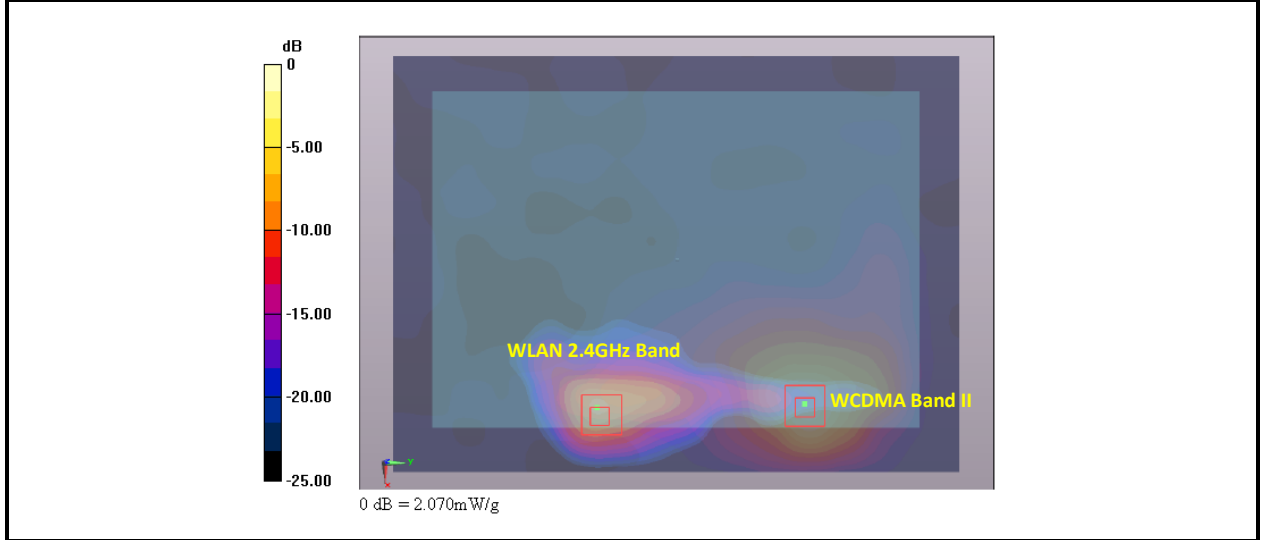

Case No. #4	Band	Position	SAR (W/kg)	Gap (cm)	SAR peak location (m)			3D distance (mm)	Pair SAR sum (W/kg)	SPLSR	Simultaneous SAR
					X	Y	Z				
#34	WCDMA Band II	Edge 1	1.370	0.6	0.0045	0.066	-0.179	82.8	1.62	0.02	Not required
#48	WLAN 2.4GHz Band		0.250	0.6	-0.003	-0.0165	-0.179				

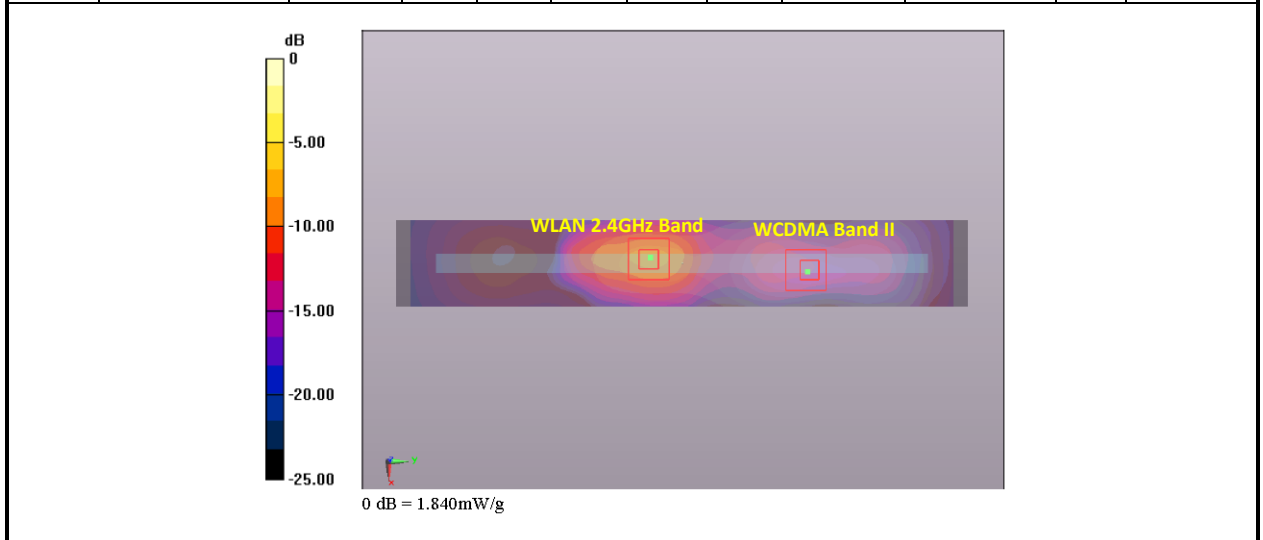

Case No. #5	Band	Position	SAR (W/kg)	Gap (cm)	SAR peak location (m)			3D distance (mm)	Pair SAR sum (W/kg)	SPLSR	Simultaneous SAR
					X	Y	Z				
#31	WCDMA Band II	Bottom Face	1.445	0	0.0765	0.068	-0.178	110.2	1.71	0.02	Not required
Plot No	Bluetooth		0.265	0	0.0835	-0.042	-0.178				

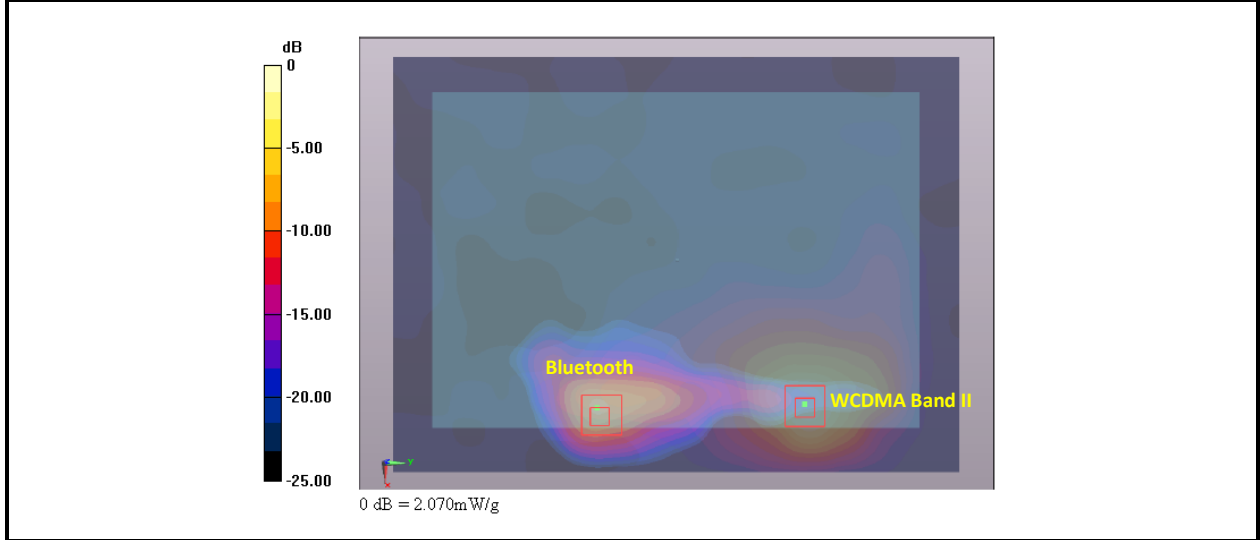

**Remark:**

1. Per KDB 447498 D01v05, SAR test exclusion is determined by the SAR to peak location separation ratio, SPLSR.
2. For SPLSR calculation Bluetooth SAR peak position is estimated using WLAN 2.4GHz peak location, due to the WLAN and Bluetooth shares the same RF trace to the same antenna, and the operational frequency range is the same.
3. If  $SPLSR \leq 0.04$ , simultaneously transmission SAR is not necessary.

Test Engineer : Fulu Hu

### **13. Uncertainty Assessment**

The component of uncertainty may generally be categorized according to the methods used to evaluate them. The evaluation of uncertainty by the statistical analysis of a series of observations is termed a Type A evaluation of uncertainty. The evaluation of uncertainty by means other than the statistical analysis of a series of observations is termed a Type B evaluation of uncertainty. Each component of uncertainty, however evaluated, is represented by an estimated standard deviation, termed standard uncertainty, which is determined by the positive square root of the estimated variance.

A Type A evaluation of standard uncertainty may be based on any valid statistical method for treating data. This includes calculating the standard deviation of the mean of a series of independent observations; using the method of least squares to fit a curve to the data in order to estimate the parameter of the curve and their standard deviations; or carrying out an analysis of variance in order to identify and quantify random effects in certain kinds of measurement.

A type B evaluation of standard uncertainty is typically based on scientific judgment using all of the relevant information available. These may include previous measurement data, experience, and knowledge of the behavior and properties of relevant materials and instruments, manufacture’s specification, data provided in calibration reports and uncertainties assigned to reference data taken from handbooks. Broadly speaking, the uncertainty is either obtained from an outdoor source or obtained from an assumed distribution, such as the normal distribution, rectangular or triangular distributions indicated in Table 12.1

<b>Uncertainty Distributions</b>	<b>Normal</b>	<b>Rectangular</b>	<b>Triangular</b>	<b>U-Shape</b>
Multi-plying Factor <sup>(a)</sup>	1/k <sup>(b)</sup>	1/√3	1/√6	1/√2

(a) standard uncertainty is determined as the product of the multiplying factor and the estimated range of variations in the measured quantity

(b)  $\kappa$  is the coverage factor

**Table 13.1 Standard Uncertainty for Assumed Distribution**

The combined standard uncertainty of the measurement result represents the estimated standard deviation of the result. It is obtained by combining the individual standard uncertainties of both Type A and Type B evaluation using the usual “root-sum-squares” (RSS) methods of combining standard deviations by taking the positive square root of the estimated variances.

Expanded uncertainty is a measure of uncertainty that defines an interval about the measurement result within which the measured value is confidently believed to lie. It is obtained by multiplying the combined standard uncertainty by a coverage factor. Typically, the coverage factor ranges from 2 to 3. Using a coverage factor allows the true value of a measured quantity to be specified with a defined probability within the specified uncertainty range. For purpose of this document, a coverage factor two is used, which corresponds to confidence interval of about 95 %. The DASY uncertainty Budget is shown in the following tables.



Error Description	Uncertainty Value (±%)	Probability Distribution	Divisor	Ci (1g)	Ci (10g)	Standard Uncertainty (1g)	Standard Uncertainty (10g)
<b>Measurement System</b>							
Probe Calibration	6.0	Normal	1	1	1	± 6.0 %	± 6.0 %
Axial Isotropy	4.7	Rectangular	√3	0.7	0.7	± 1.9 %	± 1.9 %
Hemispherical Isotropy	9.6	Rectangular	√3	0.7	0.7	± 3.9 %	± 3.9 %
Boundary Effects	1.0	Rectangular	√3	1	1	± 0.6 %	± 0.6 %
Linearity	4.7	Rectangular	√3	1	1	± 2.7 %	± 2.7 %
System Detection Limits	1.0	Rectangular	√3	1	1	± 0.6 %	± 0.6 %
Readout Electronics	0.3	Normal	1	1	1	± 0.3 %	± 0.3 %
Response Time	0.8	Rectangular	√3	1	1	± 0.5 %	± 0.5 %
Integration Time	2.6	Rectangular	√3	1	1	± 1.5 %	± 1.5 %
RF Ambient Noise	3.0	Rectangular	√3	1	1	± 1.7 %	± 1.7 %
RF Ambient Reflections	3.0	Rectangular	√3	1	1	± 1.7 %	± 1.7 %
Probe Positioner	0.4	Rectangular	√3	1	1	± 0.2 %	± 0.2 %
Probe Positioning	2.9	Rectangular	√3	1	1	± 1.7 %	± 1.7 %
Max. SAR Eval.	1.0	Rectangular	√3	1	1	± 0.6 %	± 0.6 %
<b>Test Sample Related</b>							
Device Positioning	2.9	Normal	1	1	1	± 2.9 %	± 2.9 %
Device Holder	3.6	Normal	1	1	1	± 3.6 %	± 3.6 %
Power Drift	5.0	Rectangular	√3	1	1	± 2.9 %	± 2.9 %
<b>Phantom and Setup</b>							
Phantom Uncertainty	4.0	Rectangular	√3	1	1	± 2.3 %	± 2.3 %
Liquid Conductivity (Target)	5.0	Rectangular	√3	0.64	0.43	± 1.8 %	± 1.2 %
Liquid Conductivity (Meas.)	2.5	Normal	1	0.64	0.43	± 1.6 %	± 1.1 %
Liquid Permittivity (Target)	5.0	Rectangular	√3	0.6	0.49	± 1.7 %	± 1.4 %
Liquid Permittivity (Meas.)	2.5	Normal	1	0.6	0.49	± 1.5 %	± 1.2 %
<b>Combined Standard Uncertainty</b>						± 11.0 %	± 10.8 %
<b>Coverage Factor for 95 %</b>						K=2	
<b>Expanded Uncertainty</b>						± 22.0 %	± 21.5 %

Table 13.2 Uncertainty Budget of DASY for frequency range 300 MHz to 3 GHz from IEEE Std 1528™-2003





## **14. References**

- [1] FCC 47 CFR Part 2 “Frequency Allocations and Radio Treaty Matters; General Rules and Regulations”
- [2] ANSI/IEEE Std. C95.1-1992, “IEEE Standard for Safety Levels with Respect to Human Exposure to Radio Frequency Electromagnetic Fields, 3 kHz to 300 GHz”, September 1992
- [3] IEEE Std. 1528-2003, “Recommended Practice for Determining the Peak Spatial-Average Specific Absorption Rate (SAR) in the Human Head from Wireless Communications Devices: Measurement Techniques”, December 2003
- [4] FCC OET Bulletin 65 (Edition 97-01) Supplement C (Edition 01-01), “Evaluating Compliance with FCC Guidelines for Human Exposure to Radiofrequency Electromagnetic Fields”, June 2001
- [5] SPEAG DASY System Handbook
- [6] FCC KDB 248227 D01 v01r02, “SAR Measurement Procedures for 802.11 a/b/g Transmitters”, May 2007
- [7] FCC KDB 447498 D01 v05, “Mobile and Portable Device RF Exposure Procedures and Equipment Authorization Policies”, October 2012
- [8] FCC KDB 616217 D04 v01, “SAR Evaluation Considerations for Laptop, Notebook, Netbook and Tablet Computers”, October 2012
- [9] FCC KDB 941225 D01 v02, “SAR Measurement Procedures for 3G Devices – CDMA 2000 / Ev-Do / WCDMA / HSDPA / HSPA”, October 2007
- [10] FCC KDB 941225 D02 v02 "3GPP R6 HSPA and R7 HSPA+ SAR Guidance", December 2009.
- [11] FCC KDB 941225 D03 v01, “Recommended SAR Test Reduction Procedures for GSM / GPRS / EDGE”, December 2008
- [12] FCC KDB 865664 D01 v01, “SAR Measurement Requirements for 100MHz to 6GHz”, October 2012