



FCC RF Test Report

APPLICANT : Lenovo(Shanghai) Electronics Technology Co., Ltd.
EQUIPMENT : Portable Tablet Computer
BRAND NAME : Lenovo
MODEL NAME : Lenovo PB-6505M, Lenovo PB-6505MC
FCC ID : O57PB6505M
STANDARD : 47 CFR Part 2, 22(H), 24(E), 27(L), 27(M)
CLASSIFICATION : PCS Licensed Transmitter Held to Ear (PCE)

The product was received on Oct. 27, 2018 and completely tested on Dec. 28, 2018. We, Sporton International (Kunshan) Inc., would like to declare that the tested sample has been evaluated in accordance with the procedures given in ANSI C63.26-2015 and shown compliance with the applicable technical standards.

The test results in this report apply exclusively to the tested model / sample. Without written approval of Sporton International (Kunshan) Inc., the test report shall not be reproduced except in full.



Approved by: James Huang / Manager

Sporton International (Kunshan) Inc.
No. 1098, Pengxi North Road, Kunshan Economic Development Zone,
Jiangsu Province 215335, China



TABLE OF CONTENTS

REVISION HISTORY... 3
SUMMARY OF TEST RESULT ... 4
1 GENERAL DESCRIPTION ... 5
1.1 Applicant ... 5
1.2 Manufacturer ... 5
1.3 Product Feature of Equipment Under Test ... 5
1.4 Product Specification of Equipment Under Test ... 6
1.5 Modification of EUT ... 6
1.6 Specification of Accessory ... 7
1.7 Maximum ERP/EIRP Power, Frequency Tolerance, and Emission Designator ... 8
1.8 Testing Location ... 11
1.9 Applicable Standards ... 11
2 TEST CONFIGURATION OF EQUIPMENT UNDER TEST ... 12
2.1 Test Mode ... 12
2.2 Connection Diagram of Test System ... 14
2.3 Support Unit used in test configuration and system ... 14
2.4 Measurement Results Explanation Example ... 14
2.5 Frequency List of Low/Middle/High Channels ... 15
3 CONDUCTED TEST ITEMS ... 18
3.1 Measuring Instruments ... 18
3.2 Test Setup ... 18
3.3 Test Result of Conducted Test ... 18
3.4 Conducted Output Power and ERP/EIRP ... 19
3.5 Peak-to-Average Ratio ... 20
3.6 Occupied Bandwidth ... 21
3.7 Conducted Band Edge ... 22
3.8 Conducted Spurious Emission ... 24
3.9 Frequency Stability ... 25
4 RADIATED TEST ITEMS ... 26
4.1 Measuring Instruments ... 26
4.2 Test Setup ... 26
4.3 Test Result of Radiated Test ... 26
4.4 Radiated Spurious Emission ... 27
5 LIST OF MEASURING EQUIPMENT ... 28
6 UNCERTAINTY OF EVALUATION ... 29
APPENDIX A. TEST RESULTS OF CONDUCTED TEST
APPENDIX B. TEST RESULTS OF RADIATED TEST
APPENDIX C. TEST SETUP PHOTOGRAPHS



REVISION HISTORY

REPORT NO.	VERSION	DESCRIPTION	ISSUED DATE
FG8O2704B	Rev. 01	Initial issue of report	Jan. 21, 2019



SUMMARY OF TEST RESULT

Report Section	FCC Rule	Description	Limit	Result	Remark
3.4	§2.1046	Conducted Output Power	Reporting Only	PASS	-
	§22.913(a)(5)	Effective Radiated Power (Band 5)	ERP < 7 Watt	PASS	-
	§24.232(c) §27.50(h)(2)	Equivalent Isotropic Radiated Power (Band 2) (Band 7) (Band 38)	EIRP < 2Watt	PASS	-
	§27.50(d)(4)	Equivalent Isotropic Radiated Power (Band 4)	EIRP < 1Watt	PASS	-
3.5	§24.232(d)	Peak-to-Average Ratio	<13 dB	PASS	-
3.6	§2.1049	Occupied Bandwidth	Reporting Only	PASS	-
3.7	§2.1051 §22.917(a) §24.238(a) §27.53(h)	Conducted Band Edge Measurement (Band 2) (Band 4) (Band 5)	< 43+10log ₁₀ (P[Watts])	PASS	-
	§27.53(m)(4)	Conducted Band Edge Measurement (Band 7) (Band 38)	§27.53(m)(4)		
3.8	§2.1051 §22.917(a) §24.238(a) §27.53(h)	Conducted Spurious Emission (Band 2) (Band 4) (Band 5)	< 43+10log ₁₀ (P[Watts])	PASS	-
	§2.1051 §27.53(m)(4)	Conducted Spurious Emission (Band 7) (Band 38)	< 55+10log ₁₀ (P[Watts])		
3.9	§2.1055 §22.355	Frequency Stability Temperature & Voltage	< 2.5 ppm for Part 22H	PASS	-
	§2.1055 §24.235 §27.54		Within Authorized Band		
4.4	§2.1053 §22.917(a) §24.238(a) §27.53(h)	Radiated Spurious Emission (Band 2) (Band 4) (Band 5)	< 43+10log ₁₀ (P[Watts])	PASS	Under limit 12.54 dB at 7576.000 MHz
	§2.1053 §27.53(m)(4)	Radiated Spurious Emission (Band 7) (Band 38)	< 55+10log ₁₀ (P[Watts])		



1 General Description

1.1 Applicant

Lenovo(Shanghai) Electronics Technology Co., Ltd.
NO.68 BUILDING, 199 FENJU RD, Pilot Free Trade Zone, 200131, China

1.2 Manufacturer

Lenovo PC HK Limited
23/F, Lincoln House, Taikoo Place 979 King's Road, Quarry Bay, Hong Kong

1.3 Product Feature of Equipment Under Test

Product Feature	
Equipment	Portable Tablet Computer
Brand Name	Lenovo
Model Name	Lenovo PB-6505M, Lenovo PB-6505MC
FCC ID	O57PB6505M
EUT supports Radios application	GSM/GPRS/EGPRS/WCDMA/HSPA/ DC-HSDPA/ HSPA+ (16QAM uplink is not supported)/LTE WLAN 2.4GHz 802.11b/g/n HT20 WLAN 5GHz 802.11a/n HT20/HT40 WLAN 5GHz 802.11ac VHT20/VHT40 Bluetooth BR/EDR/LE
IMEI Code	Conducted: 868922040019370/868922040019388 Radiation: 868922040015519/868922040015527 for LTE Band 2/4/7/38 868922040015238/868922040015246 for LTE Band 5
HW Version	Lenovo Tablet PB-6505M Lenovo Tablet PB-6505MC
SW Version	PB-6505M_RF01_190214 PB-6505MC_RF01_190214
EUT Stage	Identical Prototype

Remark:

1. The above EUT's information was declared by manufacturer. Please refer to the specifications or user's manual for more detailed description.
2. There are two models Lenovo PB-6505M & Lenovo PB-6505MC: Lenovo PB-6505M is ROW SKU, Lenovo PB-6505MC is India SKU.
3. There are six samples, the detailed differences of six samples are shown in the product equality declaration which is exhibit separately. According to the differences, sample 1 is assessed to perform full test.



1.4 Product Specification of Equipment Under Test

Standards-related Product Specification	
Tx Frequency	LTE Band 2 : 1850.7 MHz ~ 1909.3 MHz LTE Band 4 : 1710.7 MHz ~ 1754.3 MHz LTE Band 5 : 824.7 MHz ~ 848.3 MHz LTE Band 7 : 2502.5 MHz ~ 2567.5 MHz LTE Band 38 : 2572.5MHz ~ 2617.5MHz
Rx Frequency	LTE Band 2 : 1930.7 MHz ~ 1989.3 MHz LTE Band 4 : 2110.7 MHz ~ 2154.3 MHz LTE Band 5 : 869.7 MHz ~ 893.3 MHz LTE Band 7 : 2622.5MHz ~ 2687.5 MHz LTE Band 38 : 2572.5MHz ~ 2617.5MHz
Bandwidth	LTE Band 2 : 1.4MHz / 3MHz / 5MHz / 10MHz / 15MHz / 20MHz LTE Band 4 : 1.4MHz / 3MHz / 5MHz / 10MHz / 15MHz / 20MHz LTE Band 5 : 1.4MHz / 3MHz / 5MHz / 10MHz LTE Band 7 : 5MHz / 10MHz / 15MHz / 20MHz LTE Band 38 : 5MHz / 10MHz / 15MHz / 20MHz
Maximum Output Power to Antenna	LTE Band 2 : 23.96 dBm LTE Band 4 : 23.97 dBm LTE Band 5 : 23.40 dBm LTE Band 7 : 23.98 dBm LTE Band 38 : 23.51 dBm
Antenna Gain	LTE Band 2 : -2.80 dBi LTE Band 4 : -2.70 dBi LTE Band 5 : -3.70 dBi LTE Band 7 : 0.31 dBi LTE Band 38 : 0.59 dBi
Type of Modulation	QPSK / 16QAM / 64QAM

1.5 Modification of EUT

No modifications are made to the EUT during all test items.

1.6 Specification of Accessory

Specification of Accessory			
AC Adapter 1 (US)	Brand Name	Lenovo (Salom)	Model Name SC-41
	Power Rating	I/P: 100 - 240 Vac, 300mA, O/P: 5Vdc, 2000mA	
AC Adapter 1 (UK)	Brand Name	Lenovo (Salom)	Model Name SC-43
	Power Rating	I/P: 100 - 240 Vac, 300mA, O/P: 5Vdc, 2000mA	
AC Adapter 1 (AR)	Brand Name	Lenovo (Salom)	Model Name SC-46
	Power Rating	I/P: 100 - 240 Vac, 300mA, O/P: 5Vdc, 2000mA	
AC Adapter 2 (US)	Brand Name	Lenovo (Acbel)	Model Name SC-41
	Power Rating	I/P: 100 - 240 Vac, 300mA, O/P: 5Vdc, 2000mA	
AC Adapter 2 (UK)	Brand Name	Lenovo (Acbel)	Model Name SC-43
	Power Rating	I/P: 100 - 240 Vac, 300mA, O/P: 5Vdc, 2000mA	
AC Adapter 2 (AR)	Brand Name	Lenovo (Acbel)	Model Name SC-46
	Power Rating	I/P: 100 - 240 Vac, 300mA, O/P: 5Vdc, 2000mA	
Battery 1	Brand Name	Lenovo (NVT)	Model Name L18D1P33
	Power Rating	3.85Vdc,5180mAh	Type Li-ion
Battery 2	Brand Name	Lenovo (Sunwoda)	Model Name L18D1P33
	Power Rating	3.85Vdc,5180mAh	Type Li-ion
USB Cable 1	Brand Name	Lenovo (Leagtech)	Model Name 711300000371
	Signal Line	1.0 meter, shielded cable, without ferrite core	
USB Cable 2	Brand Name	Lenovo (Chinapysind)	Model Name 711300000441
	Signal Line	1.0 meter, shielded cable, without ferrite core	



1.7 Maximum ERP/EIRP Power, Frequency Tolerance, and Emission Designator

LTE Band 2		QPSK			16QAM		
BW (MHz)	Frequency Range (MHz)	Emission Designator (99%OBW)	Frequency Tolerance (ppm)	Maximum EIRP(W)	Emission Designator (99%OBW)	Frequency Tolerance (ppm)	Maximum EIRP(W)
1.4	1850.7 ~ 1909.3	1M10G7D	-	0.1227	1M10W7D	-	0.1007
3	1851.5 ~ 1908.5	2M72G7D	-	0.1219	2M73W7D	-	0.0975
5	1852.5 ~ 1907.5	4M49G7D	-	0.1294	4M49W7D	-	0.0979
10	1855.0 ~ 1905.0	9M03G7D	0.0034	0.1285	8M97W7D	-	0.0964
15	1857.5 ~ 1902.5	13M4G7D	-	0.1285	13M4W7D	-	0.1021
20	1860.0 ~ 1900.0	18M2G7D	-	0.1306	18M4W7D	-	0.0916
LTE Band 2		64QAM					
BW (MHz)	Frequency Range (MHz)	Emission Designator (99%OBW)		Frequency Tolerance (ppm)	Maximum EIRP(W)		
1.4	1850.7 ~ 1909.3	1M09W7D		-	0.0753		
3	1851.5 ~ 1908.5	2M72W7D		-	0.0736		
5	1852.5 ~ 1907.5	4M50W7D		-	0.0773		
10	1855.0 ~ 1905.0	9M01W7D		-	0.0719		
15	1857.5 ~ 1902.5	13M4W7D		-	0.0789		
20	1860.0 ~ 1900.0	18M4W7D		-	0.0757		
LTE Band 4		QPSK			16QAM		
BW (MHz)	Frequency Range (MHz)	Emission Designator (99%OBW)	Frequency Tolerance (ppm)	Maximum EIRP(W)	Emission Designator (99%OBW)	Frequency Tolerance (ppm)	Maximum EIRP(W)
1.4	1710.7 ~ 1754.3	1M10G7D	-	0.1318	1M09W7D	-	0.1069
3	1711.5 ~ 1753.5	2M73G7D	-	0.1205	2M73W7D	-	0.0948
5	1712.5 ~ 1752.5	4M49G7D	-	0.1337	4M50W7D	-	0.1002
10	1715.0 ~ 1750.0	8M99G7D	0.0042	0.1334	9M01W7D	-	0.1028
15	1717.5 ~ 1747.5	13M5G7D	-	0.1315	13M4W7D	-	0.1019
20	1720.0 ~ 1745.0	18M5G7D	-	0.1340	18M4W7D	-	0.0977



LTE Band 4		64QAM					
BW (MHz)	Frequency Range (MHz)	Emission Designator (99%OBW)	Frequency Tolerance (ppm)		Maximum EIRP(W)		
1.4	1710.7 ~ 1754.3	1M09W7D	-		0.0849		
3	1711.5 ~ 1753.5	2M73W7D	-		0.0748		
5	1712.5 ~ 1752.5	4M51W7D	-		0.0811		
10	1715.0 ~ 1750.0	9M03W7D	-		0.0845		
15	1717.5 ~ 1747.5	13M4W7D	-		0.0787		
20	1720.0 ~ 1745.0	18M5W7D	-		0.0824		
LTE Band 5		QPSK			16QAM		
BW (MHz)	Frequency Range (MHz)	Emission Designator (99%OBW)	Frequency Tolerance (ppm)	Maximum ERP(W)	Emission Designator (99%OBW)	Frequency Tolerance (ppm)	Maximum ERP(W)
1.4	824.7 ~ 848.3	1M10G7D	-	0.0568	1M10W7D	-	0.0446
3	825.5 ~ 847.5	2M73G7D	-	0.0551	2M73W7D	-	0.0453
5	826.5 ~ 846.5	4M49G7D	-	0.0557	4M51W7D	-	0.0417
10	829.0 ~ 844.0	9M05G7D	0.0069	0.0569	9M01W7D	-	0.0431
LTE Band 5		64QAM					
BW (MHz)	Frequency Range (MHz)	Emission Designator (99%OBW)	Frequency Tolerance (ppm)		Maximum ERP(W)		
1.4	824.7 ~ 848.3	1M09W7D	-		0.0432		
3	825.5 ~ 847.5	2M72W7D	-		0.0452		
5	826.5 ~ 846.5	4M51W7D	-		0.0453		
10	829.0 ~ 844.0	8M99W7D	-		0.0455		
LTE Band 7		QPSK			16QAM		
BW (MHz)	Frequency Range (MHz)	Emission Designator (99%OBW)	Frequency Tolerance (ppm)	Maximum EIRP(W)	Emission Designator (99%OBW)	Frequency Tolerance (ppm)	Maximum EIRP(W)
5	2502.5 ~ 2567.5	4M52G7D	-	0.2661	4M50W7D	-	0.2080
10	2505.0 ~ 2565.0	9M09G7D	0.0026	0.2661	9M07W7D	-	0.1932
15	2507.5 ~ 2562.5	13M5G7D	-	0.2630	13M5W7D	-	0.1977
20	2510.0 ~ 2560.0	18M4G7D	-	0.2685	18M5W7D	-	0.1991



LTE Band 7		64QAM					
BW (MHz)	Frequency Range (MHz)	Emission Designator (99%OBW)	Frequency Tolerance (ppm)		Maximum EIRP(W)		
5	2502.5 ~ 2567.5	4M50W7D	-		0.1694		
10	2505.0 ~ 2565.0	9M01W7D	-		0.1545		
15	2507.5 ~ 2562.5	13M5W7D	-		0.1683		
20	2510.0 ~ 2560.0	18M3W7D	-		0.1521		
LTE Band 38		QPSK			16QAM		
BW (MHz)	Frequency Range (MHz)	Emission Designator (99%OBW)	Frequency Tolerance (ppm)	Maximum EIRP(W)	Emission Designator (99%OBW)	Frequency Tolerance (ppm)	Maximum EIRP(W)
5	2572.5 ~ 2617.5	4M49G7D	-	0.2535	4M51W7D	-	0.1879
10	2575.0 ~ 2615.0	9M03G7D	0.0026	0.2541	9M03W7D	-	0.2046
15	2577.5 ~ 2612.5	13M4G7D	-	0.2564	13M5W7D	-	0.2070
20	2580.0 ~ 2610.0	18M3G7D	-	0.2570	18M4W7D	-	0.2089
LTE Band 38		64QAM					
BW (MHz)	Frequency Range (MHz)	Emission Designator (99%OBW)	Frequency Tolerance (ppm)		Maximum EIRP(W)		
5	2572.5 ~ 2617.5	4M47W7D	-		0.1507		
10	2575.0 ~ 2615.0	9M03W7D	-		0.1496		
15	2577.5 ~ 2612.5	13M5W7D	-		0.1531		
20	2580.0 ~ 2610.0	18M4W7D	-		0.1439		



1.8 Testing Location

Sporton International (Kunshan) Inc. is accredited to ISO 17025 by National Voluntary Laboratory Accreditation Program (NVLAP code: 600155-0).

Test Site	Sporton International (Kunshan) Inc.		
Test Site Location	No. 1098, Pengxi North Road, Kunshan Economic Development Zone, Jiangsu Province 215335, China TEL : 86-512-57900158 FAX : 86-512-57900958		
Test Site No.	Sporton Site No.	FCC designation No.	FCC Test Firm Registration No.
	TH01-KS 03CH04-KS 03CH06-KS	CN5013	630927

1.9 Applicable Standards

According to the specifications of the manufacturer, the EUT must comply with the requirements of the following standards:

- 47 CFR Part 2, 22(H), 24(E), 27(L), 27(M)
- ANSI C63.26-2015
- FCC KDB 971168 D01 Power Meas License Digital Systems v03r01
- FCC KDB 412172 D01 Determining ERP and EIRP v01r01

Remark:

1. All test items were verified and recorded according to the standards and without any deviation during the test.
2. This EUT has also been tested and complied with the requirements of FCC Part 15, Subpart B, recorded in a separate test report.



2 Test Configuration of Equipment Under Test

2.1 Test Mode

Antenna port conducted and radiated test items listed below are performed according to KDB 971168 D01 Power Meas License Digital Systems v03r01 with maximum output power.

Radiated measurements are performed by rotating the EUT in three different orthogonal test planes to find the maximum emission.

Test Items	Band	Bandwidth (MHz)						Modulation			RB #			Test Channel		
		1.4	3	5	10	15	20	QPSK	16QAM	64QAM	1	Half	Full	L	M	H
Max. Output Power	2	v	v	v	v	v	v	v	v	v	v	v	v	v	v	v
	4	v	v	v	v	v	v	v	v	v	v	v	v	v	v	v
	5	v	v	v	v	-	-	v	v	v	v	v	v	v	v	v
	7	-	-	v	v	v	v	v	v	v	v	v	v	v	v	v
	38	-	-	v	v	v	v	v	v	v	v	v	v	v	v	v
Peak-to-Average Ratio	2						v	v	v	v	v		v	v	v	v
	4						v	v	v	v	v		v	v	v	v
	5				v	-	-	v	v	v	v		v	v	v	v
	7	-	-				v	v	v	v	v		v	v	v	v
	38	-	-				v	v	v	v	v		v	v	v	v
26dB and 99% Bandwidth	2	v	v	v	v	v	v	v	v	v			v	v	v	v
	4	v	v	v	v	v	v	v	v	v			v	v	v	v
	5	v	v	v	v	-	-	v	v	v			v	v	v	v
	7	-	-	v	v	v	v	v	v	v			v	v	v	v
	38	-	-	v	v	v	v	v	v	v			v	v	v	v
Conducted Band Edge	2	v	v	v	v	v	v	v	v	v	v		v	v		v
	4	v	v	v	v	v	v	v	v	v	v		v	v		v
	5	v	v	v	v	-	-	v	v	v	v		v	v		v
	7	-	-	v	v	v	v	v	v	v	v		v	v		v
	38	-	-	v	v	v	v	v	v	v	v		v	v		v



Test Items	Band	Bandwidth (MHz)						Modulation			RB #			Test Channel		
		1.4	3	5	10	15	20	QPSK	16QAM	64QAM	1	Half	Full	L	M	H
Conducted Spurious Emission	2	v	v	v	v	v	v	v	v	v	v			v	v	v
	4	v	v	v	v	v	v	v	v	v	v			v	v	v
	5	v	v	v	v	-	-	v	v	v	v			v	v	v
	7	-	-	v	v	v	v	v	v	v	v			v	v	v
	38	-	-	v	v	v	v	v	v	v	v			v	v	v
Frequency Stability	2				v			v					v		v	
	4				v			v					v		v	
	5				v	-	-	v					v		v	
	7	-	-		v			v					v		v	
	38	-	-		v			v					v		v	
E.R.P / E.I.R.P	2	v	v	v	v	v	v	v	v	v	v			v	v	v
	4	v	v	v	v	v	v	v	v	v	v			v	v	v
	5	v	v	v	v	-	-	v	v	v	v			v	v	v
	7	-	-	v	v	v	v	v	v	v	v			v	v	v
	38	-	-	v	v	v	v	v	v	v	v			v	v	v
Radiated Spurious Emission	2	Worst Case													v	
	4	Worst Case													v	
	5	Worst Case													v	
	7	Worst Case													v	
	38	Worst Case													v	
Note	1. The mark "v" means that this configuration is chosen for testing 2. The mark "-" means that this bandwidth is not supported. 3. The device is investigated from 30MHz to 10 times of fundamental signal for radiated spurious emission test under different RB size/offset and modulations in exploratory test. Subsequently, only the worst case emissions are reported.															

2.2 Connection Diagram of Test System

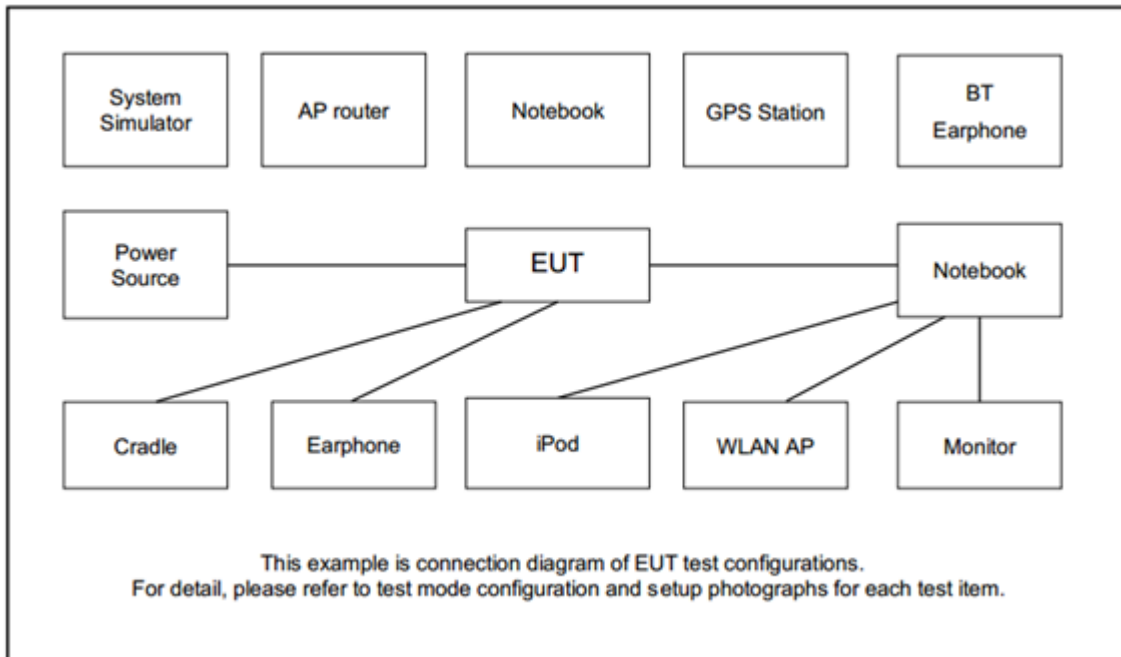

2.3 Support Unit used in test configuration and system

Item	Equipment	Trade Name	Model No.	FCC ID	Data Cable	Power Cord
1.	DC Power Supply	GW	GPS-3030D	N/A	N/A	Unshielded, 1.8 m
2.	LTE Base Station	Anritsu	MT8820C	N/A	N/A	Unshielded, 1.8 m
3.	Earphone	Lenovo	SH100	N/A	Unshielded, 1.2m	N/A

2.4 Measurement Results Explanation Example

For all conducted test items:

The offset level is set in the spectrum analyzer to compensate the RF cable loss between EUT conducted output port and spectrum analyzer. With the offset compensation, the spectrum analyzer reading level is exactly the EUT RF output level.

The spectrum analyzer offset is derived from RF cable loss.

$Offset = RF\ cable\ loss.$

Following shows an offset computation example with cable loss 5.0 dB.

Example :

$$Offset(dB) = RF\ cable\ loss(dB).$$

$$= 5.0\ (dB)$$



2.5 Frequency List of Low/Middle/High Channels

LTE Band 2 Channel and Frequency List				
BW [MHz]	Channel/Frequency(MHz)	Lowest	Middle	Highest
20	Channel	18700	18900	19100
	Frequency	1860	1880	1900
15	Channel	18675	18900	19125
	Frequency	1857.5	1880	1902.5
10	Channel	18650	18900	19150
	Frequency	1855	1880	1905
5	Channel	18625	18900	19175
	Frequency	1852.5	1880	1907.5
3	Channel	18615	18900	19185
	Frequency	1851.5	1880	1908.5
1.4	Channel	18607	18900	19193
	Frequency	1850.7	1880	1909.3

LTE Band 4 Channel and Frequency List				
BW [MHz]	Channel/Frequency(MHz)	Lowest	Middle	Highest
20	Channel	20050	20175	20300
	Frequency	1720	1732.5	1745
15	Channel	20025	20175	20325
	Frequency	1717.5	1732.5	1747.5
10	Channel	20000	20175	20350
	Frequency	1715	1732.5	1750
5	Channel	19975	20175	20375
	Frequency	1712.5	1732.5	1752.5
3	Channel	19965	20175	20385
	Frequency	1711.5	1732.5	1753.5
1.4	Channel	19957	20175	20393
	Frequency	1710.7	1732.5	1754.3



LTE Band 5 Channel and Frequency List				
BW [MHz]	Channel/Frequency(MHz)	Lowest	Middle	Highest
10	Channel	20450	20525	20600
	Frequency	829	836.5	844
5	Channel	20425	20525	20625
	Frequency	826.5	836.5	846.5
3	Channel	20415	20525	20635
	Frequency	825.5	836.5	847.5
1.4	Channel	20407	20525	20643
	Frequency	824.7	836.5	848.3

LTE Band 7 Channel and Frequency List				
BW [MHz]	Channel/Frequency(MHz)	Lowest	Middle	Highest
20	Channel	20850	21100	21350
	Frequency	2510	2535	2560
15	Channel	20825	21100	21375
	Frequency	2507.5	2535	2562.5
10	Channel	20800	21100	21400
	Frequency	2505	2535	2565
5	Channel	20775	21100	21425
	Frequency	2502.5	2535	2567.5



LTE Band 38 Channel and Frequency List				
BW [MHz]	Channel/Frequency(MHz)	Lowest	Middle	Highest
20	Channel	37850	38000	38150
	Frequency	2580	2595	2610
15	Channel	37825	38000	38175
	Frequency	2577.5	2595	2612.5
10	Channel	37800	38000	38200
	Frequency	2575	2595	2615
5	Channel	37775	38000	38225
	Frequency	2572.5	2595	2617.5

3 Conducted Test Items

3.1 Measuring Instruments

See list of measuring instruments of this test report.

3.2 Test Setup

3.2.1 Conducted Output Power

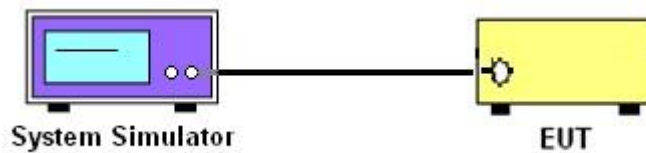

3.2.2 Peak-to-Average Ratio, Occupied Bandwidth ,Conducted Band-Edge and Conducted Spurious Emission

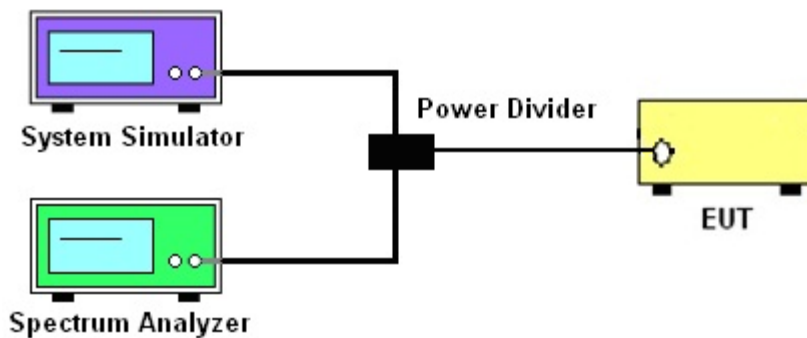

3.2.3 Frequency Stability

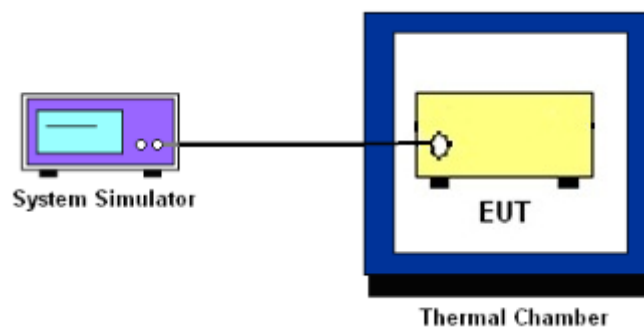

3.3 Test Result of Conducted Test

Please refer to Appendix A.



3.4 Conducted Output Power and ERP/EIRP

3.4.1 Description of the Conducted Output Power Measurement and ERP/EIRP Measurement

A system simulator was used to establish communication with the EUT. Its parameters were set to force the EUT transmitting at maximum output power. The measured power in the radio frequency on the transmitter output terminals shall be reported.

The ERP of mobile transmitters must not exceed 7 Watts for LTE Band 5.

The EIRP of mobile transmitters must not exceed 2 Watts for LTE Band 2 and Band 7 and Band 38.

The EIRP of mobile transmitters must not exceed 1 Watts for LTE Band 4.

According to KDB 412172 D01 Power Approach,

$EIRP = P_T + G_T - L_C$, $ERP = EIRP - 2.15$, where

P_T = transmitter output power in dBm

G_T = gain of the transmitting antenna in dBi

L_C = signal attenuation in the connecting cable between the transmitter and antenna in dB

3.4.2 Test Procedures

1. The testing follows ANSI C63.26 Section 5.2
2. The transmitter output port was connected to the system simulator.
3. Set EUT at maximum power through the system simulator.
4. Select lowest, middle, and highest channels for each band and different modulation.
5. Measure and record the power level from the system simulator.



3.5 Peak-to-Average Ratio

3.5.1 Description of the PAR Measurement

Power Complementary Cumulative Distribution Function (CCDF) curves provide a means for characterizing the power peaks of a digitally modulated signal on a statistical basis. A CCDF curve depicts the probability of the peak signal amplitude exceeding the average power level. Most contemporary measurement instrumentation include the capability to produce CCDF curves for an input signal provided that the instrument's resolution bandwidth can be set wide enough to accommodate the entire input signal bandwidth. In measuring transmissions in this band using an average power technique, the peak-to-average ratio (PAR) of the transmission may not exceed 13 dB.

3.5.2 Test Procedures

1. The testing follows ANSI C63.26 Section 5.2.3.4 (CCDF).
2. The EUT was connected to spectrum and system simulator via a power divider.
3. Set the CCDF (Complementary Cumulative Distribution Function) option in spectrum analyzer.
4. The highest RF powers were measured and recorded the maximum PAPR level associated with a probability of 0.1 %.
5. Record the deviation as Peak to Average Ratio.



3.6 Occupied Bandwidth

3.6.1 Description of Occupied Bandwidth Measurement

The occupied bandwidth is the width of a frequency band such that, below the lower and above the upper frequency limits, the mean powers emitted are each equal to a specified percentage 0.5% of the total mean transmitted power.

The 26 dB emission bandwidth is defined as the frequency range between two points, one above and one below the carrier frequency, at which the spectral density of the emission is attenuated 26 dB below the maximum in-band spectral density of the modulated signal. Spectral density (power per unit bandwidth) is to be measured with a detector of resolution bandwidth equal to approximately 1.0% of the emission bandwidth.

3.6.2 Test Procedures

1. The testing follows ANSI C63.26 Section 5.4
2. The EUT was connected to spectrum analyzer and system simulator via a power divider.
3. The spectrum analyzer center frequency is set to the nominal EUT channel center frequency. The span range for the spectrum analyzer shall be between two and five times the anticipated OBW.
4. The nominal resolution bandwidth (RBW) shall be in the range of 1 to 5 % of the anticipated OBW, and the VBW shall be at least 3 times the RBW.
5. Set the detection mode to peak, and the trace mode to max hold.
6. Determine the reference value: Set the EUT to transmit a modulated signal. Allow the trace to stabilize. Set the spectrum analyzer marker to the highest level of the displayed trace.
(this is the reference value)
7. Determine the “-26 dB down amplitude” as equal to (Reference Value – X).
8. Place two markers, one at the lowest and the other at the highest frequency of the envelope of the spectral display such that each marker is at or slightly below the “-X dB down amplitude” determined in step 6. If a marker is below this “-X dB down amplitude” value it shall be placed as close as possible to this value. The OBW is the positive frequency difference between the two markers.
9. Use the 99 % power bandwidth function of the spectrum analyzer and report the measured bandwidth.



3.7 Conducted Band Edge

3.7.1 Description of Conducted Band Edge Measurement

22.917(a)

For operations in the 824 – 849 MHz band, the FCC limit is $43 + 10\log_{10}(P[\text{Watts}])$ dB below the transmitter power P(Watts) in a 100kHz bandwidth. However, in the 1MHz bands immediately outside and adjacent to the licensee's frequency block, a resolution bandwidth of at least one percent of the emission bandwidth of the fundamental emission of the transmitter may be employed.

24.238 (a)

For operations in the 1850-1910 and 1930-1990 MHz band, the FCC limit is $43 + 10\log_{10}(P[\text{Watts}])$ dB below the transmitter power P(Watts) in a 1MHz bandwidth. However, in the 1 MHz bands immediately outside and adjacent to the frequency block a resolution bandwidth of at least one percent of the emission bandwidth of the fundamental emission of the transmitter may be employed.

27.53 (h)

For operations in the 1710 – 1755 MHz band, the FCC limit is $43 + 10\log_{10}(P[\text{Watts}])$ dB below the transmitter power P(Watts) in a 1 MHz bandwidth. However, in the 1MHz bands immediately outside and adjacent to the licensee's frequency block, a resolution bandwidth of at least one percent of the emission bandwidth of the fundamental emission of the transmitter may be employed.

27.53(m)(4)

For mobile digital stations, the attenuation factor shall be not less than $40 + 10 \log (P)$ dB on all frequencies between the channel edge and 5 megahertz from the channel edge, $43 + 10 \log (P)$ dB on all frequencies between 5 megahertz and X megahertz from the channel edge, and $55 + 10 \log (P)$ dB on all frequencies more than X megahertz from the channel edge, where X is the greater of 6 megahertz or the actual emission bandwidth as defined in paragraph (m)(6) of this section. In addition, the attenuation factor shall not be less that $43 + 10 \log (P)$ dB on all frequencies between 2490.5 MHz and 2496 MHz and $55 + 10 \log (P)$ dB at or below 2490.5 MHz. Mobile Satellite Service licensees operating on frequencies below 2495 MHz may also submit a documented interference complaint against BRS licensees operating on channel BRS Channel 1 on the same terms and conditions as adjacent channel BRS or EBS licensees.



3.7.2 Test Procedures

1. The testing follows ANSI C63.26 section 5.7
2. The EUT was connected to spectrum analyzer and system simulator via a power divider.
3. The band edges of low and high channels for the highest RF powers were measured.
4. Set RBW \geq 1% EBW in the 1MHz band immediately outside and adjacent to the band edge.
5. Beyond the 1 MHz band from the band edge, RBW=1MHz was used.
6. Set spectrum analyzer with RMS detector.
7. The RF fundamental frequency should be excluded against the limit line in the operating frequency band.
8. Offset has included the duty factor for LTE Band 38. Duty factor = $10 \log (1/x)$, where x is the measured duty cycle.
9. Checked that all the results comply with the emission limit line.

Example:

The limit line is derived from $43 + 10\log(P)$ dB below the transmitter power P(Watts)

$$= P(W) - [43 + 10\log(P)] \text{ (dB)}$$

$$= [30 + 10\log(P)] \text{ (dBm)} - [43 + 10\log(P)] \text{ (dB)} = -13\text{dBm}.$$

10. For LTE Band 7, 38, the other 40 dB, and 55 dB have additionally applied same calculation above.



3.8 Conducted Spurious Emission

3.8.1 Description of Conducted Spurious Emission Measurement

The power of any emission outside of the authorized operating frequency ranges must be lower than the transmitter power (P) by a factor of at least $43 + 10 \log (P)$ dB.

For Band 7,38:

The power of any emission outside of the authorized operating frequency ranges must be lower than the transmitter power (P) by a factor of at least $55 + 10 \log (P)$ dB.

It is measured by means of a calibrated spectrum analyzer and scanned from 30 MHz up to a frequency including its 10th harmonic.

3.8.2 Test Procedures

1. The testing follows ANSI C63.26 section 5.7
2. The EUT was connected to spectrum analyzer and system simulator via a power divider.
3. The RF output of EUT was connected to the spectrum analyzer by RF cable and attenuator. The path loss was compensated to the results for each measurement.
4. The middle channel for the highest RF power within the transmitting frequency was measured.
5. The conducted spurious emission for the whole frequency range was taken.
6. Make the measurement with the spectrum analyzer's RBW = 1MHz, VBW = 3MHz.
7. Set spectrum analyzer with RMS detector.
8. Offset has included the duty factor for LTE Band 38. Duty factor = $10 \log (1/x)$, where x is the measured duty cycle.
9. Taking the record of maximum spurious emission.
10. The RF fundamental frequency should be excluded against the limit line in the operating frequency band.
11. The limit line is derived from $43 + 10 \log (P)$ dB below the transmitter power P(Watts)
= $P(W) - [43 + 10 \log (P)]$ (dB)
= $[30 + 10 \log (P)]$ (dBm) - $[43 + 10 \log (P)]$ (dB)
= -13dBm.
12. For Band 7, 38
The limit line is derived from $55 + 10 \log (P)$ dB below the transmitter power P(Watts)
= $P(W) - [55 + 10 \log (P)]$ (dB)
= $[30 + 10 \log (P)]$ (dBm) - $[55 + 10 \log (P)]$ (dB)
= -25dBm.



3.9 Frequency Stability

3.9.1 Description of Frequency Stability Measurement

The frequency stability shall be measured by variation of ambient temperature and variation of primary supply voltage to ensure that the fundamental emission stays within the authorized frequency block. The frequency stability of the transmitter shall be maintained within $\pm 0.00025\%$ ($\pm 2.5\text{ppm}$) of the center frequency.

3.9.2 Test Procedures for Temperature Variation

1. The testing follows ANSI C63.26 section 5.6.4
2. The EUT was set up in the thermal chamber and connected with the system simulator.
3. With power OFF, the temperature was decreased to -30°C and the EUT was stabilized before testing. Power was applied and the maximum change in frequency was recorded within one minute.
4. With power OFF, the temperature was raised in 10°C step up to 50°C . The EUT was stabilized at each step for at least half an hour. Power was applied and the maximum frequency change was recorded within one minute.

3.9.3 Test Procedures for Voltage Variation

1. The testing follows ANSI C63.26 section 5.6.5
2. The EUT was placed in a temperature chamber at $20\pm 5^{\circ}\text{C}$ and connected with the system simulator.
3. The power supply voltage to the EUT was varied from 85% to 115% of the nominal value for other than hand carried battery equipment.
4. For hand carried, battery powered equipment, reduce the primary ac or dc supply voltage to the battery operating end point, which shall be specified by the manufacturer.
5. The variation in frequency was measured for the worst case.

4 Radiated Test Items

4.1 Measuring Instruments

See list of measuring instruments of this test report.

4.2 Test Setup

4.2.1 For radiated test from 30MHz to 1GHz

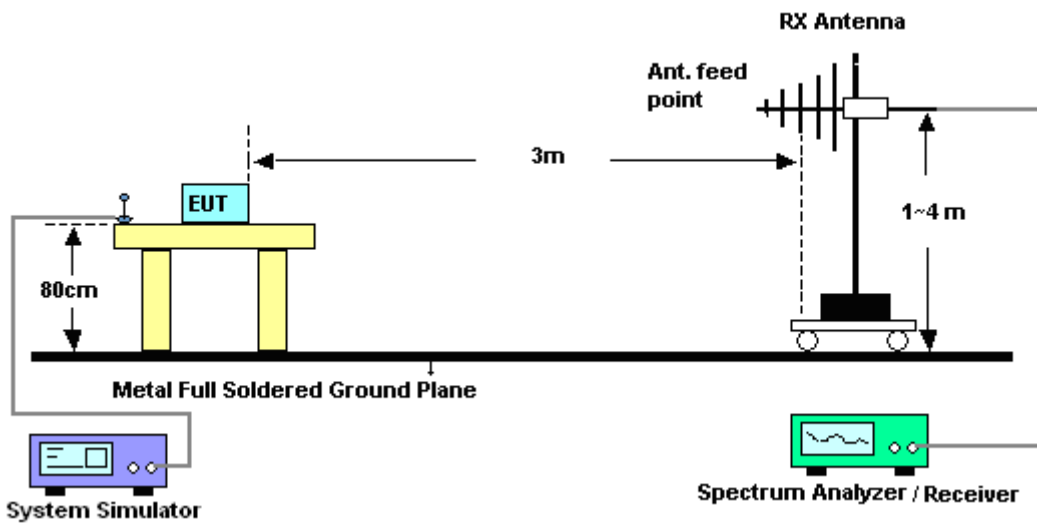

4.2.2 For radiated test above 1GHz

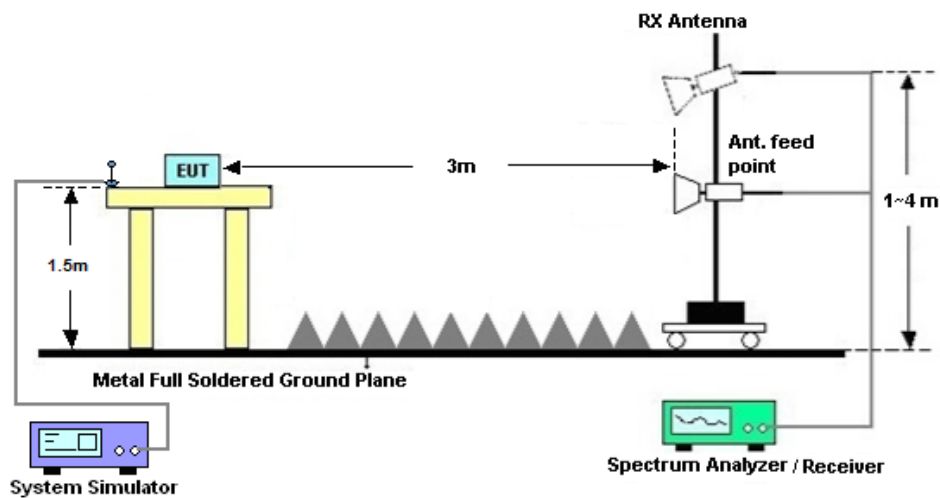

4.3 Test Result of Radiated Test

Please refer to Appendix B.



4.4 Radiated Spurious Emission

4.4.1 Description of Radiated Spurious Emission

The radiated spurious emission was measured by substitution method according to ANSI C63.26. The power of any emission outside of the authorized operating frequency ranges must be attenuated below the transmitter power (P) by a factor of at least $43 + 10 \log (P)$ dB.

For Band 7, 38

The power of any emission outside of the authorized operating frequency ranges must be attenuated below the transmitter power (P) by a factor of at least $55 + 10 \log (P)$ dB.

The spectrum is scanned from 30 MHz up to a frequency including its 10th harmonic.

4.4.2 Test Procedures

1. The testing follows ANSI C63.26 Section 5.5
2. The EUT was placed on a turntable with 0.8 meter height for frequency below 1GHz and 1.5 meter height for frequency above 1GHz respectively above ground.
3. The EUT was set 3 meters from the receiving antenna mounted on the antenna tower.
4. The table was rotated 360 degrees to determine the position of the highest spurious emission.
5. The height of the receiving antenna is varied between 1m to 4m to search the maximum spurious emission for both horizontal and vertical polarizations.
6. During the measurement, the system simulator parameters were set to force the EUT transmitting at maximum output power.
7. Make the measurement with the spectrum analyzer's RBW = 1MHz, VBW = 3MHz, taking the record of maximum spurious emission.
8. A horn antenna was substituted in place of the EUT and was driven by a signal generator.
9. Tune the output power of signal generator to the same emission level with EUT maximum spurious emission.
10. $EIRP (dBm) = S.G. Power - Tx Cable Loss + Tx Antenna Gain$
11. $ERP (dBm) = EIRP - 2.15$
12. The RF fundamental frequency should be excluded against the limit line in the operating frequency band.

The limit line is derived from $43 + 10\log(P)$ dB below the transmitter power P(Watts)
 $= P(W) - [43 + 10\log(P)] (dB)$
 $= [30 + 10\log(P)] (dBm) - [43 + 10\log(P)] (dB)$
 $= -13dBm.$

13. For Band 7, 38:

The limit line is derived from $55 + 10\log(P)$ dB below the transmitter power P(Watts)



5 List of Measuring Equipment

Instrument	Manufacturer	Model No.	Serial No.	Characteristics	Calibration Date	Test Date	Due Date	Remark
Spectrum Analyzer	R&S	FSV40	101040	10Hz~40GHz	Aug. 07, 2018	Dec. 25, 2018~ Dec. 28, 2018	Aug. 06, 2019	Conducted (TH01-KS)
Thermal Chamber	Ten Billion	TTC-B3S	TBN-960502	-40~+150°C	Nov. 19, 2018	Dec. 25, 2018~ Dec. 28, 2018	Nov. 18, 2019	Conducted (TH01-KS)
EXA Spectrum Analyzer	Keysight	N9010A	MY55150208	10Hz-44GHz	Apr. 17, 2018	Dec. 25, 2018	Apr. 16, 2019	Radiation (03CH04-KS)
Bilog Antenna	TeseQ	CBL6111D	44483	30MHz-1GHz	Jan. 29, 2018	Dec. 25, 2018	Jan. 28, 2019	Radiation (03CH04-KS)
Horn Antenna	Schwarzbeck	BBHA9120D	1648	1GHz~18GHz	Jan. 27, 2018	Dec. 25, 2018	Jan. 26, 2019	Radiation (03CH04-KS)
SHF-EHF Horn	Schwarzbeck	BBHA 9170	BBHA170249	15GHz~40GHz	Feb. 07, 2018	Dec. 25, 2018	Feb. 06, 2019	Radiation (03CH04-KS)
Amplifier	Burgeon	BPA-530	102219	0.01MHz~3000MHz	Dec. 15, 2018	Dec. 25, 2018	Dec. 14, 2019	Radiation (03CH04-KS)
Amplifier	MITEQ	TTA1840-35-HG	2014749	18~40GHz	Feb. 08, 2018	Dec. 25, 2018	Feb. 07, 2019	Radiation (03CH04-KS)
high gain Amplifier	MITEQ	AMF-7D-00 101800-30-1 QP	2025788	1Ghz-18Ghz	Apr. 17, 2018	Dec. 25, 2018	Apr. 16, 2019	Radiation (03CH04-KS)
Amplifier	Keysight	83017A	MY53270319	500MHz~26.5GHz	Oct. 12, 2018	Dec. 25, 2018	Oct. 11, 2019	Radiation (03CH04-KS)
AC Power Source	Chroma	61601	F104090004	N/A	NCR	Dec. 25, 2018	NCR	Radiation (03CH04-KS)
Turn Table	ChamPro	EM 1000-T	060762-T	0~360 degree	NCR	Dec. 25, 2018	NCR	Radiation (03CH04-KS)
Antenna Mast	ChamPro	EM 1000-A	060762-A	1 m~4 m	NCR	Dec. 25, 2018	NCR	Radiation (03CH04-KS)
EXA Spectrum Analyzer	Keysight	N9010B	MY57471084	10Hz-44GHz	Jun. 25, 2018	Dec. 27, 2018	Jun. 24, 2019	Radiation (03CH06-KS)
Bilog Antenna	TeseQ	CBL6111D	44483	30MHz-1GHz	Jan. 29, 2018	Dec. 27, 2018	Jan. 28, 2019	Radiation (03CH06-KS)
Double Ridge Horn Antenna	ETS-Lindgren	3117	75957	1GHz~18GHz	Oct. 20, 2018	Dec. 27, 2018	Oct. 19, 2019	Radiation (03CH06-KS)
SHF-EHF Horn	Schwarzbeck	BBHA 9170	BBHA170249	15GHz~40GHz	Feb. 07, 2018	Dec. 27, 2018	Feb. 06, 2019	Radiation (03CH06-KS)
Amplifier	SONOMA	310N	187289	9KHz ~1GHZ	Aug. 06, 2018	Dec. 27, 2018	Aug. 05, 2019	Radiation (03CH06-KS)
Amplifier	MITEQ	TTA1840-35-HG	2014749	18~40GHz	Feb. 08, 2018	Dec. 27, 2018	Feb. 07, 2019	Radiation (03CH06-KS)
high gain Amplifier	MITEQ	AMF-7D-00 101800-30-1	2025788	1Ghz-18Ghz	Apr. 17, 2018	Dec. 27, 2018	Apr. 16, 2019	Radiation (03CH06-KS)
Amplifier	Keysight	83017A	MY53270203	500MHz~26.5GHz	Apr. 18, 2018	Dec. 27, 2018	Apr. 17, 2019	Radiation (03CH06-KS)
AC Power Source	Chroma	61601	F104090004	N/A	NCR	Dec. 27, 2018	NCR	Radiation (03CH06-KS)
Turn Table	ChamPro	EM 1000-T	060762-T	0~360 degree	NCR	Dec. 27, 2018	NCR	Radiation (03CH06-KS)
Antenna Mast	ChamPro	EM 1000-A	060762-A	1 m~4 m	NCR	Dec. 27, 2018	NCR	Radiation (03CH06-KS)

NCR: No Calibration Required



6 Uncertainty of Evaluation

The measurement uncertainties shown below were calculated in accordance with the requirements of ANSI 63.26-2015. All the measurement uncertainty value were shown with a coverage K=2 to indicate 95% level of confidence. The measurement data show herein meets or exceeds the CISPR measurement uncertainty values specified in CISPR 16-4-2 and can be compared directly to specified limit to determine compliance.

Uncertainty of Radiated Emission Measurement (30 MHz ~ 1000 MHz) for 03CH04-KS

Measuring Uncertainty for a Level of Confidence of 95% (U = 2Uc(y))	3.3dB
---	-------

Uncertainty of Radiated Emission Measurement (1 GHz ~ 18 GHz) for 03CH04-KS

Measuring Uncertainty for a Level of Confidence of 95% (U = 2Uc(y))	2.8dB
---	-------

Uncertainty of Radiated Emission Measurement (18 GHz ~ 40 GHz) for 03CH04-KS

Measuring Uncertainty for a Level of Confidence of 95% (U = 2Uc(y))	2.8dB
---	-------

Uncertainty of Radiated Emission Measurement (30 MHz ~ 1000 MHz) for 03CH06-KS

Measuring Uncertainty for a Level of Confidence of 95% (U = 2Uc(y))	2.5dB
---	-------

Uncertainty of Radiated Emission Measurement (1 GHz ~ 18 GHz) for 03CH06-KS

Measuring Uncertainty for a Level of Confidence of 95% (U = 2Uc(y))	2.0dB
---	-------

Uncertainty of Radiated Emission Measurement (18 GHz ~ 40 GHz) for 03CH06-KS

Measuring Uncertainty for a Level of Confidence of 95% (U = 2Uc(y))	2.0dB
---	-------



Appendix A. Test Results of Conducted Test

Conducted Output Power(Average power)

LTE Band 2 Maximum Average Power [dBm]						
BW [MHz]	RB Size	RB Offset	Mod	Lowest	Middle	Highest
20	1	0	QPSK	23.45	23.38	23.35
20	1	49		23.96	23.88	23.94
20	1	99		23.43	23.43	23.01
20	50	0		22.75	22.74	22.68
20	50	24		22.62	22.64	22.57
20	50	50		22.55	22.58	22.57
20	100	0		22.62	22.62	22.60
20	1	0	16-QAM	22.35	22.22	22.42
20	1	49		22.24	22.21	22.35
20	1	99		22.23	21.96	22.11
20	50	0		21.77	21.68	21.71
20	50	24		21.67	21.69	21.50
20	50	50		21.59	21.47	21.55
20	100	0		21.56	21.55	21.51
20	1	0	64QAM	21.29	21.33	21.36
20	1	49		21.28	21.59	21.50
20	1	99		21.05	21.21	21.05
20	50	0		20.44	20.48	20.44
20	50	24		20.42	20.49	20.38
20	50	50		20.45	20.46	20.45
20	100	0		20.48	20.43	20.34
15	1	0	QPSK	23.73	23.73	23.59
15	1	37		23.89	23.86	23.70
15	1	74		23.66	23.46	23.68
15	36	0		22.65	22.73	22.59
15	36	20		22.60	22.60	22.58
15	36	39		22.60	22.64	22.55
15	75	0		22.67	22.70	22.57



15	1	0	16-QAM	22.89	22.86	22.38
15	1	37		22.67	22.75	22.35
15	1	74		22.69	22.19	22.06
15	36	0		21.61	21.63	21.50
15	36	20		21.65	21.67	21.55
15	36	39		21.57	21.61	21.35
15	75	0		21.71	21.72	21.67
15	1	0	64QAM	21.16	21.24	21.07
15	1	37		21.69	21.77	21.70
15	1	74		21.13	21.22	21.24
15	36	0		20.61	20.40	20.40
15	36	20		20.54	20.45	20.30
15	36	39		20.54	20.36	20.19
15	75	0		20.64	20.32	20.31



LTE Band 2 Maximum Average Power [dBm]						
BW [MHz]	RB Size	RB Offset	Mod	Lowest	Middle	Highest
10	1	0	QPSK	23.46	23.44	23.06
10	1	25		23.89	23.80	23.42
10	1	49		23.48	23.15	23.10
10	25	0		22.73	22.69	22.63
10	25	12		22.62	22.71	22.60
10	25	25		22.57	22.69	22.43
10	50	0		22.59	22.67	22.50
10	1	0	16-QAM	22.40	22.46	22.13
10	1	25		22.64	22.39	22.29
10	1	49		22.48	22.28	22.03
10	25	0		21.72	21.82	21.48
10	25	12		21.54	21.71	21.45
10	25	25		21.87	21.53	21.26
10	50	0		21.56	21.57	21.38
10	1	0	64QAM	21.10	21.12	21.37
10	1	25		21.18	21.11	20.85
10	1	49		20.98	20.80	20.46
10	25	0		20.53	20.30	20.20
10	25	12		20.54	20.37	20.19
10	25	25		20.43	20.25	20.11
10	50	0		20.52	20.46	20.31
5	1	0	QPSK	23.63	23.61	23.28
5	1	12		23.92	23.84	23.52
5	1	24		23.34	23.51	23.05
5	12	0		22.66	22.55	22.45
5	12	7		22.65	22.63	22.39
5	12	13		22.73	22.62	22.42
5	25	0		22.71	22.59	22.51
5	1	0	16-QAM	22.71	22.30	22.13
5	1	12		22.28	22.59	21.64
5	1	24		22.10	22.52	21.64
5	12	0		21.72	21.70	21.64
5	12	7		21.82	21.55	21.60



5	12	13		21.60	21.77	21.43
5	25	0		21.69	21.76	21.49
5	1	0	64QAM	21.23	20.97	20.86
5	1	12		21.68	21.42	21.14
5	1	24		21.05	20.90	21.63
5	12	0		20.37	20.26	20.06
5	12	7		20.60	20.25	20.11
5	12	13		20.54	20.13	20.06
5	25	0		20.70	20.40	19.94



LTE Band 2 Maximum Average Power [dBm]						
BW [MHz]	RB Size	RB Offset	Mod	Lowest	Middle	Highest
3	1	0	QPSK	23.46	23.25	23.66
3	1	8		23.37	23.57	23.37
3	1	14		23.54	23.60	22.96
3	8	0		22.56	22.62	22.41
3	8	4		22.63	22.51	22.50
3	8	7		22.57	22.53	22.42
3	15	0		22.52	22.57	22.45
3	1	0	16-QAM	22.69	22.33	22.10
3	1	8		22.57	22.20	22.03
3	1	14		22.67	22.60	21.80
3	8	0		21.67	21.60	21.47
3	8	4		21.51	21.50	21.41
3	8	7		21.66	21.60	21.49
3	15	0		21.45	21.54	21.52
3	1	0	64QAM	21.18	20.95	20.76
3	1	8		21.47	20.95	20.77
3	1	14		21.47	20.97	20.76
3	8	0		20.42	20.33	20.07
3	8	4		20.42	20.34	19.99
3	8	7		20.61	20.24	20.27
3	15	0		20.49	20.21	19.99
1.4	1	0	QPSK	23.43	23.40	23.32
1.4	1	3		23.43	23.56	23.38
1.4	1	5		23.31	23.55	23.06
1.4	3	0		23.67	23.51	23.42
1.4	3	1		23.69	23.51	23.44
1.4	3	3		23.64	23.66	23.47
1.4	6	0		22.51	22.57	22.34
1.4	1	0	16-QAM	22.31	22.34	22.33
1.4	1	3		22.48	22.83	22.65
1.4	1	5		22.58	22.80	22.66
1.4	3	0		22.58	22.61	22.42
1.4	3	1		22.62	22.64	22.43



1.4	3	3	64QAM	22.55	22.66	22.22
1.4	6	0		21.53	21.44	21.45
1.4	1	0		21.15	20.66	21.17
1.4	1	3		21.04	20.79	20.95
1.4	1	5		20.90	20.87	20.76
1.4	3	0		21.14	21.47	21.35
1.4	3	1		21.57	21.40	21.20
1.4	3	3		21.40	21.52	21.41
1.4	6	0		20.50	20.53	19.98



LTE Band 4 Maximum Average Power [dBm]						
BW [MHz]	RB Size	RB Offset	Mod	Lowest	Middle	Highest
20	1	0	QPSK	23.20	23.20	23.65
20	1	49		23.80	23.78	23.97
20	1	99		23.13	23.03	23.73
20	50	0		22.58	22.68	22.73
20	50	24		22.50	22.58	22.68
20	50	50		22.51	22.51	22.60
20	100	0		22.54	22.59	22.60
20	1	0	16-QAM	22.26	22.53	22.54
20	1	49		22.18	22.34	22.35
20	1	99		22.18	22.17	22.60
20	50	0		21.51	21.73	21.62
20	50	24		21.46	21.62	21.52
20	50	50		21.37	21.41	21.62
20	100	0		21.52	21.36	21.48
20	1	0	64QAM	21.80	21.46	21.15
20	1	49		21.71	21.46	21.15
20	1	99		21.78	21.86	21.62
20	50	0		20.77	20.77	20.95
20	50	24		20.72	20.88	20.80
20	50	50		20.64	20.67	20.82
20	100	0		20.73	20.58	20.61
15	1	0	QPSK	23.51	23.57	23.65
15	1	37		23.64	23.89	23.76
15	1	74		23.61	23.56	23.55
15	36	0		22.48	22.73	22.65
15	36	20		22.54	22.59	22.61
15	36	39		22.54	22.45	22.60
15	75	0		22.48	22.57	22.63
15	1	0	16-QAM	22.19	22.37	22.78
15	1	37		22.01	22.20	22.73
15	1	74		22.11	22.49	22.64
15	36	0		21.45	21.61	21.51
15	36	20		21.43	21.50	21.58



15	36	39	64QAM	21.42	21.38	21.51
15	75	0		21.54	21.51	21.69
15	1	0		21.19	21.14	21.17
15	1	37		21.64	21.56	21.66
15	1	74		20.91	21.00	21.06
15	36	0		20.67	20.71	20.72
15	36	20		20.65	20.61	20.70
15	36	39		20.67	20.57	20.79
15	75	0		20.81	20.54	20.86



LTE Band 4 Maximum Average Power [dBm]						
BW [MHz]	RB Size	RB Offset	Mod	Lowest	Middle	Highest
10	1	0	QPSK	23.42	23.29	23.30
10	1	25		23.78	23.95	23.80
10	1	49		23.16	23.17	23.50
10	25	0		22.69	22.64	22.70
10	25	12		22.55	22.67	22.72
10	25	25		22.48	22.48	22.59
10	50	0		22.59	22.64	22.67
10	1	0	16-QAM	22.59	22.30	22.17
10	1	25		22.49	22.21	22.20
10	1	49		22.43	22.11	22.82
10	25	0		21.62	21.63	21.87
10	25	12		21.61	21.61	21.69
10	25	25		21.52	21.35	21.35
10	50	0		21.50	21.55	21.59
10	1	0	64QAM	21.97	21.38	21.19
10	1	25		21.55	21.13	20.98
10	1	49		21.52	21.73	20.89
10	25	0		20.77	20.70	20.83
10	25	12		20.90	20.73	20.85
10	25	25		20.62	20.47	20.84
10	50	0		20.90	20.79	20.76
5	1	0	QPSK	23.29	23.53	23.23
5	1	12		23.96	23.95	23.48
5	1	24		23.21	23.29	23.26
5	12	0		22.56	22.60	22.68
5	12	7		22.70	22.61	22.63
5	12	13		22.64	22.62	22.79
5	25	0		22.54	22.55	22.68
5	1	0	16-QAM	22.43	22.05	22.40
5	1	12		22.41	21.87	22.71
5	1	24		22.23	22.48	22.57
5	12	0		21.67	21.50	21.51
5	12	7		21.57	21.80	21.53



5	12	13	64QAM	21.71	21.63	21.70
5	25	0		21.65	21.54	21.48
5	1	0		20.96	21.19	21.53
5	1	12		21.79	21.00	21.03
5	1	24		21.03	20.77	21.11
5	12	0		20.57	20.93	20.60
5	12	7		20.75	20.94	20.66
5	12	13		20.70	20.63	20.57
5	25	0		20.71	20.52	20.69



LTE Band 4 Maximum Average Power [dBm]						
BW [MHz]	RB Size	RB Offset	Mod	Lowest	Middle	Highest
3	1	0	QPSK	23.26	23.51	23.29
3	1	8		23.35	23.45	23.30
3	1	14		23.10	23.38	23.25
3	8	0		22.63	22.64	22.61
3	8	4		22.68	22.61	22.60
3	8	7		22.57	22.52	22.57
3	15	0		22.54	22.52	22.63
3	1	0	16-QAM	21.91	22.02	22.47
3	1	8		21.82	21.86	22.47
3	1	14		21.97	21.93	22.30
3	8	0		21.66	21.78	21.67
3	8	4		21.78	21.68	21.42
3	8	7		21.51	21.54	21.65
3	15	0		21.69	21.68	21.39
3	1	0	64QAM	20.88	21.26	21.44
3	1	8		20.97	20.96	21.10
3	1	14		21.05	20.92	20.97
3	8	0		20.54	20.66	20.56
3	8	4		20.59	20.55	20.54
3	8	7		20.72	20.56	20.51
3	15	0		20.69	20.52	20.55
1.4	1	0	QPSK	23.26	23.49	23.53
1.4	1	3		23.62	23.67	23.75
1.4	1	5		23.52	23.50	23.56
1.4	3	0		23.50	23.57	23.67
1.4	3	1		23.57	23.62	23.69
1.4	3	3		23.50	23.69	23.90
1.4	6	0		22.57	22.61	22.63
1.4	1	0	16-QAM	22.99	22.65	22.48
1.4	1	3		22.47	22.77	22.16
1.4	1	5		22.49	22.07	22.18
1.4	3	0		22.64	22.61	22.71
1.4	3	1		22.34	22.64	22.59



1.4	3	3	64QAM	22.61	22.62	22.73
1.4	6	0		21.61	21.55	21.76
1.4	1	0		21.10	21.13	21.07
1.4	1	3		21.33	21.07	21.01
1.4	1	5		20.76	21.35	21.02
1.4	3	0		21.87	21.90	21.74
1.4	3	1		21.90	21.60	21.99
1.4	3	3		21.76	21.62	21.83
1.4	6	0		21.00	20.95	20.64



LTE Band 5 Maximum Average Power [dBm]						
BW [MHz]	RB Size	RB Offset	Mod	Lowest	Middle	Highest
10	1	0	QPSK	22.85	23.03	22.88
10	1	25		23.40	23.00	23.07
10	1	49		22.69	22.73	22.82
10	25	0		22.25	22.18	22.16
10	25	12		22.21	22.15	22.08
10	25	25		22.07	22.12	22.04
10	50	0		22.16	22.12	22.09
10	1	0	16-QAM	21.69	21.55	21.94
10	1	25		22.19	21.48	22.01
10	1	49		22.12	21.79	21.90
10	25	0		21.43	21.11	21.07
10	25	12		21.43	21.03	20.99
10	25	25		21.11	21.06	21.05
10	50	0		21.05	21.00	21.09
10	1	0	64QAM	22.43	22.26	21.80
10	1	25		21.81	22.02	21.71
10	1	49		21.84	21.96	21.32
10	25	0		21.28	21.15	21.16
10	25	12		21.36	21.19	21.05
10	25	25		21.10	21.12	21.25
10	50	0		21.24	21.17	21.10
5	1	0	QPSK	22.62	22.67	22.71
5	1	12		23.03	23.31	23.03
5	1	24		22.76	22.73	22.61
5	12	0		22.29	22.11	22.01
5	12	7		22.33	22.22	22.09
5	12	13		22.27	22.15	22.10
5	25	0		22.23	22.15	22.03
5	1	0	16-QAM	21.51	21.63	22.02
5	1	12		21.80	21.50	21.76
5	1	24		21.72	22.05	21.49
5	12	0		20.97	21.07	20.82
5	12	7		21.32	21.19	21.08



5	12	13	64QAM	21.42	20.98	20.82
5	25	0		21.30	21.20	21.08
5	1	0		21.65	21.40	21.72
5	1	12		22.40	22.41	22.18
5	1	24		21.47	21.61	21.05
5	12	0		20.97	20.82	20.87
5	12	7		21.10	21.27	20.90
5	12	13		20.91	20.96	20.94
5	25	0		21.23	20.97	21.17



LTE Band 5 Maximum Average Power [dBm]						
BW [MHz]	RB Size	RB Offset	Mod	Lowest	Middle	Highest
3	1	0	QPSK	23.26	22.91	22.83
3	1	8		23.05	22.98	22.93
3	1	14		23.25	22.97	22.90
3	8	0		22.25	22.04	22.09
3	8	4		22.32	22.14	22.12
3	8	7		22.25	22.17	22.06
3	15	0		22.24	22.05	22.03
3	1	0	16-QAM	22.38	21.95	21.62
3	1	8		22.41	22.01	21.99
3	1	14		22.38	21.96	21.79
3	8	0		21.49	21.11	21.10
3	8	4		20.95	21.03	21.00
3	8	7		20.94	21.25	21.16
3	15	0		21.21	21.09	20.97
3	1	0	64QAM	22.29	21.96	21.71
3	1	8		21.77	21.99	21.55
3	1	14		22.40	21.60	21.90
3	8	0		21.20	21.43	20.77
3	8	4		21.16	21.34	21.00
3	8	7		21.12	21.29	20.88
3	15	0		21.08	20.90	20.81
1.4	1	0	QPSK	23.14	23.01	23.01
1.4	1	3		23.24	23.06	23.06
1.4	1	5		23.09	23.05	22.95
1.4	3	0		23.20	23.15	23.13
1.4	3	1		23.24	23.25	23.02
1.4	3	3		23.39	23.08	22.97
1.4	6	0		22.25	22.02	22.04
1.4	1	0	16-QAM	21.56	21.63	21.65
1.4	1	3		21.91	21.56	21.88
1.4	1	5		22.34	21.30	21.75
1.4	3	0		22.11	21.55	21.79
1.4	3	1		22.14	22.17	21.84



1.4	3	3	64QAM	22.15	22.10	21.98
1.4	6	0		21.00	20.72	20.80
1.4	1	0		22.06	21.97	21.56
1.4	1	3		22.11	21.98	21.95
1.4	1	5		21.73	21.75	21.93
1.4	3	0		22.00	21.86	22.20
1.4	3	1		22.08	22.20	22.17
1.4	3	3		22.14	22.04	22.20
1.4	6	0		21.10	21.03	20.94



LTE Band 7 Maximum Average Power [dBm]						
BW [MHz]	RB Size	RB Offset	Mod	Lowest	Middle	Highest
20	1	0	QPSK	23.16	23.15	22.99
20	1	49		23.98	23.72	23.71
20	1	99		23.38	23.53	23.32
20	50	0		22.78	22.64	22.68
20	50	24		22.58	22.69	22.70
20	50	50		22.59	22.69	22.76
20	100	0		22.70	22.68	22.62
20	1	0	16-QAM	22.55	22.64	22.49
20	1	49		22.62	22.10	22.54
20	1	99		22.56	22.29	22.68
20	50	0		21.70	21.74	21.84
20	50	24		21.72	21.79	21.78
20	50	50		21.94	21.75	21.79
20	100	0		21.69	21.76	21.69
20	1	0	64QAM	21.26	20.94	20.73
20	1	49		21.12	20.88	21.51
20	1	99		21.45	21.17	20.99
20	50	0		20.95	20.71	20.89
20	50	24		20.84	20.90	20.91
20	50	50		20.91	20.98	20.87
20	100	0		20.64	20.72	20.61
15	1	0	QPSK	23.54	23.56	23.50
15	1	37		23.89	23.87	23.76
15	1	74		23.70	23.75	23.72
15	36	0		22.76	22.72	22.74
15	36	20		22.66	22.73	22.80
15	36	39		22.70	22.79	22.75
15	75	0		22.69	22.77	22.74
15	1	0	16-QAM	22.28	22.34	22.30
15	1	37		22.22	22.65	22.36
15	1	74		22.37	22.20	22.28
15	36	0		21.81	21.73	21.74
15	36	20		21.72	21.75	21.79



15	36	39	64QAM	21.76	21.78	21.75
15	75	0		21.83	21.87	21.85
15	1	0		21.14	21.29	20.92
15	1	37		21.71	21.53	21.95
15	1	74		21.32	21.12	20.74
15	36	0		20.85	20.82	20.67
15	36	20		20.86	20.79	20.85
15	36	39		20.89	20.86	20.79
15	75	0		20.90	20.89	20.84



LTE Band 7 Maximum Average Power [dBm]						
BW [MHz]	RB Size	RB Offset	Mod	Lowest	Middle	Highest
10	1	0	QPSK	23.23	23.15	23.20
10	1	25		23.94	23.87	23.59
10	1	49		23.54	23.59	23.30
10	25	0		22.78	22.70	22.82
10	25	12		22.75	22.70	22.82
10	25	25		22.69	22.77	22.71
10	50	0		22.70	22.76	22.80
10	1	0	16-QAM	22.34	22.34	22.40
10	1	25		22.45	22.55	22.50
10	1	49		22.38	22.45	22.53
10	25	0		21.98	21.72	21.79
10	25	12		21.94	21.93	21.89
10	25	25		21.88	21.73	22.00
10	50	0		21.78	21.80	21.94
10	1	0	64QAM	21.05	21.58	21.06
10	1	25		21.28	21.19	21.22
10	1	49		21.21	21.07	20.76
10	25	0		20.95	20.84	20.86
10	25	12		20.74	20.86	20.90
10	25	25		20.60	20.85	20.80
10	50	0		20.96	20.84	20.75
5	1	0	QPSK	23.18	23.21	23.14
5	1	12		23.94	23.77	23.69
5	1	24		23.80	23.24	23.19
5	12	0		22.67	22.66	22.71
5	12	7		22.74	22.70	22.66
5	12	13		22.67	22.64	22.69
5	25	0		22.70	22.69	22.67
5	1	0	16-QAM	22.38	22.61	22.66
5	1	12		22.54	22.47	22.87
5	1	24		22.48	22.53	22.64
5	12	0		21.69	21.76	21.64
5	12	7		21.75	21.78	21.93



5	12	13	64QAM	21.92	21.96	21.91
5	25	0		21.71	21.57	21.63
5	1	0		20.55	21.15	21.25
5	1	12		20.27	21.97	21.98
5	1	24		20.20	21.46	21.48
5	12	0		19.66	20.59	20.62
5	12	7		19.81	20.71	20.68
5	12	13		19.82	20.76	20.68
5	25	0		20.82	20.80	20.64



LTE Band 38 Maximum Average Power [dBm]						
BW [MHz]	RB Size	RB Offset	Mod	Lowest	Middle	Highest
20	1	0	QPSK	23.10	23.26	23.17
20	1	49		23.51	23.46	23.41
20	1	99		23.01	23.28	23.30
20	50	0		22.46	22.35	22.57
20	50	24		22.38	22.37	22.39
20	50	50		22.39	22.42	22.38
20	100	0		22.36	22.37	22.33
20	1	0	16-QAM	21.98	21.96	22.14
20	1	49		22.15	22.61	22.23
20	1	99		22.13	22.16	22.08
20	50	0		21.42	21.37	21.69
20	50	24		21.37	21.33	21.60
20	50	50		21.68	21.45	21.61
20	100	0		21.27	21.32	21.60
20	1	0	64QAM	20.60	20.35	20.61
20	1	49		20.99	20.84	20.98
20	1	99		20.50	20.54	20.72
20	50	0		20.66	20.42	20.40
20	50	24		20.70	20.37	20.46
20	50	50		20.63	20.48	20.30
20	100	0		20.69	20.46	20.49
15	1	0	QPSK	23.15	23.27	23.14
15	1	37		23.50	23.45	23.38
15	1	74		23.44	23.20	23.28
15	36	0		22.73	22.32	22.71
15	36	20		22.35	22.35	22.37
15	36	39		22.42	22.44	22.32
15	75	0		22.41	22.35	22.44
15	1	0	16-QAM	21.85	21.99	22.21
15	1	37		22.23	22.57	22.52
15	1	74		21.98	21.60	22.18
15	36	0		21.56	21.29	21.37
15	36	20		21.49	21.39	21.45



15	36	39	64QAM	21.57	21.45	21.21
15	75	0		21.34	21.30	21.36
15	1	0		21.06	20.86	20.85
15	1	37		21.26	21.15	21.09
15	1	74		21.09	20.81	20.83
15	36	0		20.81	20.51	20.64
15	36	20		20.90	20.54	20.57
15	36	39		20.78	20.66	20.33
15	75	0		20.95	20.39	20.45



LTE Band 38 Maximum Average Power [dBm]						
BW [MHz]	RB Size	RB Offset	Mod	Lowest	Middle	Highest
10	1	0	QPSK	23.18	23.26	23.24
10	1	25		23.46	23.26	23.13
10	1	49		23.38	23.45	23.24
10	25	0		22.66	22.64	22.44
10	25	12		22.78	22.69	22.38
10	25	25		22.39	22.44	22.31
10	50	0		22.40	22.38	22.31
10	1	0	16-QAM	22.05	22.18	22.32
10	1	25		22.25	22.52	22.02
10	1	49		22.06	21.75	21.84
10	25	0		21.55	21.58	21.36
10	25	12		21.61	21.55	21.50
10	25	25		21.83	21.57	21.53
10	50	0		21.38	21.24	21.33
10	1	0	64QAM	20.99	20.84	20.81
10	1	25		21.16	20.86	20.78
10	1	49		21.00	20.88	20.81
10	25	0		20.89	20.54	20.41
10	25	12		20.98	20.46	20.43
10	25	25		20.93	20.52	20.67
10	50	0		20.62	20.46	20.49
5	1	0	QPSK	23.18	23.21	23.10
5	1	12		23.35	23.45	23.37
5	1	24		23.05	23.31	23.03
5	12	0		22.22	22.51	22.25
5	12	7		22.31	22.30	22.28
5	12	13		22.31	22.39	22.39
5	25	0		22.21	22.36	22.27
5	1	0	16-QAM	22.06	22.11	22.15
5	1	12		22.08	22.13	22.04
5	1	24		22.11	22.13	21.75
5	12	0		21.27	21.17	21.13
5	12	7		21.27	21.30	21.36



5	12	13		21.35	21.33	21.34
5	25	0		21.75	21.57	21.54
5	1	0	64QAM	20.80	20.72	20.63
5	1	12		21.19	21.11	20.98
5	1	24		20.84	20.71	20.68
5	12	0		20.41	20.43	20.28
5	12	7		20.64	20.47	20.35
5	12	13		20.72	20.56	20.36
5	25	0		20.81	20.70	20.67



ERP/EIRP

LTE Band 2 (GT - LC = -2.80 dB) QPSK									
Bandwidth	1.4M			3M			5M		
Channel	18607	18900	19193	18615	18900	19185	18625	18900	19175
	(Low)	(Mid)	(High)	(Low)	(Mid)	(High)	(Low)	(Mid)	(High)
Frequency	1850.7	1880	1909.3	1851.5	1880	1908.5	1852.5	1880	1907.5
(MHz)									
Conducted Power (dBm)	23.69	23.51	23.44	23.46	23.25	23.66	23.92	23.84	23.52
Conducted Power (Watts)	0.2339	0.2244	0.2208	0.2218	0.2113	0.2323	0.2466	0.2421	0.2249
EIRP(dBm)	20.89	20.71	20.64	20.66	20.45	20.86	21.12	21.04	20.72
EIRP(Watts)	0.1227	0.1178	0.1159	0.1164	0.1109	0.1219	0.1294	0.1271	0.1180

LTE Band 2 (GT - LC = -2.80 dB) QPSK									
Bandwidth	10M			15M			20M		
Channel	18650	18900	19150	18675	18900	19125	18650	18900	19100
	(Low)	(Mid)	(High)	(Low)	(Mid)	(High)	(Low)	(Mid)	(High)
Frequency	1855	1880	1905	1857.5	1880	1902.5	1860	1880	1900
(MHz)									
Conducted Power (dBm)	23.89	23.80	23.42	23.89	23.86	23.70	23.96	23.88	23.94
Conducted Power (Watts)	0.2449	0.2399	0.2198	0.2449	0.2432	0.2344	0.2489	0.2443	0.2477
EIRP(dBm)	21.09	21.00	20.62	21.09	21.06	20.90	21.16	21.08	21.14
EIRP(Watts)	0.1285	0.1259	0.1153	0.1285	0.1276	0.1230	0.1306	0.1282	0.1300



LTE Band 2 (GT - LC = -2.80 dB) 16QAM									
Bandwidth	1.4M			3M			5M		
Channel	18607	18900	19193	18615	18900	19185	18625	18900	19175
	(Low)	(Mid)	(High)	(Low)	(Mid)	(High)	(Low)	(Mid)	(High)
Frequency (MHz)	1850.7	1880	1909.3	1851.5	1880	1908.5	1852.5	1880	1907.5
Conducted Power (dBm)	22.48	22.83	22.65	22.69	22.33	22.10	22.71	22.30	22.13
Conducted Power (Watts)	0.1770	0.1919	0.1841	0.1858	0.1710	0.1622	0.1866	0.1698	0.1633
EIRP(dBm)	19.68	20.03	19.85	19.89	19.53	19.30	19.91	19.50	19.33
EIRP(Watts)	0.0929	0.1007	0.0966	0.0975	0.0897	0.0851	0.0979	0.0891	0.0857

LTE Band 2 (GT - LC = -2.80 dB) 16QAM									
Bandwidth	10M			15M			20M		
Channel	18650	18900	19150	18675	18900	19125	18650	18900	19100
	(Low)	(Mid)	(High)	(Low)	(Mid)	(High)	(Low)	(Mid)	(High)
Frequency (MHz)	1855	1880	1905	1857.5	1880	1902.5	1860	1880	1900
Conducted Power (dBm)	22.64	22.39	22.29	22.89	22.86	22.38	22.35	22.22	22.42
Conducted Power (Watts)	0.1837	0.1734	0.1694	0.1945	0.1932	0.1730	0.1718	0.1667	0.1746
EIRP(dBm)	19.84	19.59	19.49	20.09	20.06	19.58	19.55	19.42	19.62
EIRP(Watts)	0.0964	0.0910	0.0889	0.1021	0.1014	0.0908	0.0902	0.0875	0.0916



LTE Band 2 (GT - LC = -2.80 dB) 64QAM									
Bandwidth	1.4M			3M			5M		
Channel	18607	18900	19193	18615	18900	19185	18625	18900	19175
	(Low)	(Mid)	(High)	(Low)	(Mid)	(High)	(Low)	(Mid)	(High)
Frequency (MHz)	1850.7	1880	1909.3	1851.5	1880	1908.5	1852.5	1880	1907.5
Conducted Power (dBm)	21.57	21.40	21.20	21.47	20.97	20.76	21.68	21.42	21.14
Conducted Power (Watts)	0.1435	0.1380	0.1318	0.1403	0.1250	0.1191	0.1472	0.1387	0.1300
EIRP(dBm)	18.77	18.60	18.40	18.67	18.17	17.96	18.88	18.62	18.34
EIRP(Watts)	0.0753	0.0724	0.0692	0.0736	0.0656	0.0625	0.0773	0.0728	0.0682

LTE Band 2 (GT - LC = -2.80 dB) 64QAM									
Bandwidth	10M			15M			20M		
Channel	18650	18900	19150	18675	18900	19125	18650	18900	19100
	(Low)	(Mid)	(High)	(Low)	(Mid)	(High)	(Low)	(Mid)	(High)
Frequency (MHz)	1855	1880	1905	1857.5	1880	1902.5	1860	1880	1900
Conducted Power (dBm)	21.10	21.12	21.37	21.69	21.77	21.70	21.28	21.59	21.50
Conducted Power (Watts)	0.1288	0.1294	0.1371	0.1476	0.1503	0.1479	0.1343	0.1442	0.1413
EIRP(dBm)	18.30	18.32	18.57	18.89	18.97	18.90	18.48	18.79	18.70
EIRP(Watts)	0.0676	0.0679	0.0719	0.0774	0.0789	0.0776	0.0705	0.0757	0.0741



LTE Band 4 (GT - LC = -2.70 dB) QPSK									
Bandwidth	1.4M			3M			5M		
Channel	19957	20175	20393	19965	20175	20385	19975	20175	20375
	(Low)	(Mid)	(High)	(Low)	(Mid)	(High)	(Low)	(Mid)	(High)
Frequency (MHz)	1710.7	1732.5	1754.3	1711.5	1732.5	1753.5	1712.5	1732.5	1752.5
Conducted Power (dBm)	23.50	23.69	23.90	23.26	23.51	23.29	23.96	23.95	23.48
Conducted Power (Watts)	0.2239	0.2339	0.2455	0.2118	0.2244	0.2133	0.2489	0.2483	0.2228
EIRP(dBm)	20.80	20.99	21.20	20.56	20.81	20.59	21.26	21.25	20.78
EIRP(Watts)	0.1202	0.1256	0.1318	0.1138	0.1205	0.1146	0.1337	0.1334	0.1197

LTE Band 4 (GT - LC = -2.70 dB) QPSK									
Bandwidth	10M			15M			20M		
Channel	20000	20175	20350	20025	20175	20325	20050	20175	20300
	(Low)	(Mid)	(High)	(Low)	(Mid)	(High)	(Low)	(Mid)	(High)
Frequency (MHz)	1715	1732.5	1750	1717.5	1732.5	1747.5	1720	1732.5	1745
Conducted Power (dBm)	23.78	23.95	23.80	23.64	23.89	23.76	23.80	23.78	23.97
Conducted Power (Watts)	0.2388	0.2483	0.2399	0.2312	0.2449	0.2377	0.2399	0.2388	0.2495
EIRP(dBm)	21.08	21.25	21.10	20.94	21.19	21.06	21.10	21.08	21.27
EIRP(Watts)	0.1282	0.1334	0.1288	0.1242	0.1315	0.1276	0.1288	0.1282	0.1340



LTE Band 4 (GT - LC = -2.70 dB) 16QAM									
Bandwidth	1.4M			3M			5M		
Channel	19957	20175	20393	19965	20175	20385	19975	20175	20375
	(Low)	(Mid)	(High)	(Low)	(Mid)	(High)	(Low)	(Mid)	(High)
Frequency (MHz)	1710.7	1732.5	1754.3	1711.5	1732.5	1753.5	1712.5	1732.5	1752.5
Conducted Power (dBm)	22.99	22.65	22.48	21.82	21.86	22.47	22.41	21.87	22.71
Conducted Power (Watts)	0.1991	0.1841	0.1770	0.1521	0.1535	0.1766	0.1742	0.1538	0.1866
EIRP(dBm)	20.29	19.95	19.78	19.12	19.16	19.77	19.71	19.17	20.01
EIRP(Watts)	0.1069	0.0989	0.0951	0.0817	0.0824	0.0948	0.0935	0.0826	0.1002

LTE Band 4 (GT - LC = -2.70 dB) 16QAM									
Bandwidth	10M			15M			20M		
Channel	20000	20175	20350	20025	20175	20325	20050	20175	20300
	(Low)	(Mid)	(High)	(Low)	(Mid)	(High)	(Low)	(Mid)	(High)
Frequency (MHz)	1715	1732.5	1750	1717.5	1732.5	1747.5	1720	1732.5	1745
Conducted Power (dBm)	22.43	22.11	22.82	22.19	22.37	22.78	22.18	22.17	22.60
Conducted Power (Watts)	0.1750	0.1626	0.1914	0.1656	0.1726	0.1897	0.1652	0.1648	0.1820
EIRP(dBm)	19.73	19.41	20.12	19.49	19.67	20.08	19.48	19.47	19.90
EIRP(Watts)	0.0940	0.0873	0.1028	0.0889	0.0927	0.1019	0.0887	0.0885	0.0977



LTE Band 4 (GT - LC = -2.70 dB) 64QAM									
Bandwidth	1.4M			3M			5M		
Channel	19957	20175	20393	19965	20175	20385	19975	20175	20375
	(Low)	(Mid)	(High)	(Low)	(Mid)	(High)	(Low)	(Mid)	(High)
Frequency (MHz)	1710.7	1732.5	1754.3	1711.5	1732.5	1753.5	1712.5	1732.5	1752.5
Conducted Power (dBm)	21.90	21.60	21.99	20.88	21.26	21.44	21.79	21.00	21.03
Conducted Power (Watts)	0.1549	0.1445	0.1581	0.1225	0.1337	0.1393	0.1510	0.1259	0.1268
EIRP(dBm)	19.20	18.90	19.29	18.18	18.56	18.74	19.09	18.30	18.33
EIRP(Watts)	0.0832	0.0776	0.0849	0.0658	0.0718	0.0748	0.0811	0.0676	0.0681

LTE Band 4 (GT - LC = -2.70 dB) 64QAM									
Bandwidth	10M			15M			20M		
Channel	20000	20175	20350	20025	20175	20325	20050	20175	20300
	(Low)	(Mid)	(High)	(Low)	(Mid)	(High)	(Low)	(Mid)	(High)
Frequency (MHz)	1715	1732.5	1750	1717.5	1732.5	1747.5	1720	1732.5	1745
Conducted Power (dBm)	21.97	21.38	21.19	21.64	21.56	21.66	21.78	21.86	21.62
Conducted Power (Watts)	0.1574	0.1374	0.1315	0.1459	0.1432	0.1466	0.1507	0.1535	0.1452
EIRP(dBm)	19.27	18.68	18.49	18.94	18.86	18.96	19.08	19.16	18.92
EIRP(Watts)	0.0845	0.0738	0.0706	0.0783	0.0769	0.0787	0.0809	0.0824	0.0780



LTE Band 5 (GT - LC = -3.70 dB) QPSK									
Bandwidth	1.4M			3M			5M		
Channel	20407	20525	20643	20415	20525	20635	20425	20525	20625
	(Low)	(Mid)	(High)	(Low)	(Mid)	(High)	(Low)	(Mid)	(High)
Frequency (MHz)	824.7	836.5	848.3	825.5	836.5	847.5	826.5	836.5	846.5
Conducted Power (dBm)	23.39	23.08	22.97	23.26	22.91	22.83	23.03	23.31	23.03
Conducted Power (Watts)	0.2183	0.2032	0.1982	0.2118	0.1954	0.1919	0.2009	0.2143	0.2009
ERP(dBm)	17.54	17.23	17.12	17.41	17.06	16.98	17.18	17.46	17.18
ERP(Watts)	0.0568	0.0528	0.0515	0.0551	0.0508	0.0499	0.0522	0.0557	0.0522

LTE Band 5 (GT - LC = -3.70 dB) QPSK			
Bandwidth	10M		
Channel	20450	20525	20600
	(Low)	(Mid)	(High)
Frequency (MHz)	829	836.5	844
Conducted Power (dBm)	23.40	23.00	23.07
Conducted Power (Watts)	0.2188	0.1995	0.2028
ERP(dBm)	17.55	17.15	17.22
ERP(Watts)	0.0569	0.0519	0.0527



LTE Band 5 (GT - LC = -3.70 dB) 16QAM									
Bandwidth	1.4M			3M			5M		
Channel	20407	20525	20643	20415	20525	20635	20425	20525	20625
	(Low)	(Mid)	(High)	(Low)	(Mid)	(High)	(Low)	(Mid)	(High)
Frequency (MHz)	824.7	836.5	848.3	825.5	836.5	847.5	826.5	836.5	846.5
Conducted Power (dBm)	22.34	21.30	21.75	22.41	22.01	21.99	21.72	22.05	21.49
Conducted Power (Watts)	0.1714	0.1349	0.1496	0.1742	0.1589	0.1581	0.1486	0.1603	0.1409
ERP(dBm)	16.49	15.45	15.90	16.56	16.16	16.14	15.87	16.20	15.64
ERP(Watts)	0.0446	0.0351	0.0389	0.0453	0.0413	0.0411	0.0386	0.0417	0.0366

LTE Band 5 (GT - LC = -3.70 dB) 16QAM			
Bandwidth	10M		
Channel	20450	20525	20600
	(Low)	(Mid)	(High)
Frequency (MHz)	829	836.5	844
Conducted Power (dBm)	22.19	21.48	22.01
Conducted Power (Watts)	0.1656	0.1406	0.1589
ERP(dBm)	16.34	15.63	16.16
ERP(Watts)	0.0431	0.0366	0.0413



LTE Band 5 (GT - LC = -3.70 dB) 64QAM									
Bandwidth	1.4M			3M			5M		
Channel	20407	20525	20643	20415	20525	20635	20425	20525	20625
	(Low)	(Mid)	(High)	(Low)	(Mid)	(High)	(Low)	(Mid)	(High)
Frequency (MHz)	824.7	836.5	848.3	825.5	836.5	847.5	826.5	836.5	846.5
Conducted Power (dBm)	22.00	21.86	22.20	22.40	21.60	21.90	22.40	22.41	22.18
Conducted Power (Watts)	0.1585	0.1535	0.1660	0.1738	0.1445	0.1549	0.1738	0.1742	0.1652
ERP(dBm)	16.15	16.01	16.35	16.55	15.75	16.05	16.55	16.56	16.33
ERP(Watts)	0.0412	0.0399	0.0432	0.0452	0.0376	0.0403	0.0452	0.0453	0.0430

LTE Band 5 (GT - LC = -3.70 dB) 64QAM			
Bandwidth	10M		
Channel	20450	20525	20600
	(Low)	(Mid)	(High)
Frequency (MHz)	829	836.5	844
Conducted Power (dBm)	22.43	22.26	21.80
Conducted Power (Watts)	0.1750	0.1683	0.1514
ERP(dBm)	16.58	16.41	15.95
ERP(Watts)	0.0455	0.0438	0.0394



LTE Band 7 (GT - LC = 0.31 dB) QPSK			
Bandwidth	5M		
Channel	20775	21100	21425
	(Low)	(Mid)	(High)
Frequency	2502.5	2535	2567.5
(MHz)			
Conducted Power (dBm)	23.94	23.77	23.69
Conducted Power (Watts)	0.2477	0.2382	0.2339
EIRP(dBm)	24.25	24.08	24.00
EIRP(Watts)	0.2661	0.2559	0.2512

LTE Band 7 (GT - LC = 0.31 dB) QPSK									
Bandwidth	10M			15M			20M		
Channel	20800	21100	21400	20825	21100	21375	20850	21100	21350
	(Low)	(Mid)	(High)	(Low)	(Mid)	(High)	(Low)	(Mid)	(High)
Frequency	2505	2535	2565	2507.5	2535	2562.5	2510	2535	2560
(MHz)									
Conducted Power (dBm)	23.94	23.87	23.59	23.89	23.87	23.76	23.98	23.72	23.71
Conducted Power (Watts)	0.2477	0.2438	0.2286	0.2449	0.2438	0.2377	0.2500	0.2355	0.2350
EIRP(dBm)	24.25	24.18	23.90	24.20	24.18	24.07	24.29	24.03	24.02
EIRP(Watts)	0.2661	0.2618	0.2455	0.2630	0.2618	0.2553	0.2685	0.2529	0.2523



LTE Band 7 (GT - LC = 0.31 dB) 16QAM			
Bandwidth	5M		
Channel	20775	21100	21425
	(Low)	(Mid)	(High)
Frequency (MHz)	2502.5	2535	2567.5
	Conducted Power (dBm)	22.54	22.47
Conducted Power (Watts)	0.1795	0.1766	0.1936
EIRP(dBm)	22.85	22.78	23.18
EIRP(Watts)	0.1928	0.1897	0.2080

LTE Band 7 (GT - LC = 0.31 dB) 16QAM									
Bandwidth	10M			15M			20M		
Channel	20800	21100	21400	20825	21100	21375	20850	21100	21350
	(Low)	(Mid)	(High)	(Low)	(Mid)	(High)	(Low)	(Mid)	(High)
Frequency (MHz)	2505	2535	2565	2507.5	2535	2562.5	2510	2535	2560
	Conducted Power (dBm)	22.45	22.55	22.50	22.22	22.65	22.36	22.56	22.29
Conducted Power (Watts)	0.1758	0.1799	0.1778	0.1667	0.1841	0.1722	0.1803	0.1694	0.1854
EIRP(dBm)	22.76	22.86	22.81	22.53	22.96	22.67	22.87	22.60	22.99
EIRP(Watts)	0.1888	0.1932	0.1910	0.1791	0.1977	0.1849	0.1936	0.1820	0.1991



LTE Band 7 (GT - LC = 0.31 dB) 64QAM			
Bandwidth	5M		
Channel	20775	21100	21425
	(Low)	(Mid)	(High)
Frequency (MHz)	2502.5	2535	2567.5
	Conducted Power (dBm)	20.27	21.97
Conducted Power (Watts)	0.1064	0.1574	0.1578
EIRP(dBm)	20.58	22.28	22.29
EIRP(Watts)	0.1143	0.1690	0.1694

LTE Band 7 (GT - LC = 0.31 dB) 64QAM									
Bandwidth	10M			15M			20M		
Channel	20800	21100	21400	20825	21100	21375	20850	21100	21350
	(Low)	(Mid)	(High)	(Low)	(Mid)	(High)	(Low)	(Mid)	(High)
Frequency (MHz)	2505	2535	2565	2507.5	2535	2562.5	2510	2535	2560
	Conducted Power (dBm)	21.05	21.58	21.06	21.71	21.53	21.95	21.12	20.88
Conducted Power (Watts)	0.1274	0.1439	0.1276	0.1483	0.1422	0.1567	0.1294	0.1225	0.1416
EIRP(dBm)	21.36	21.89	21.37	22.02	21.84	22.26	21.43	21.19	21.82
EIRP(Watts)	0.1368	0.1545	0.1371	0.1592	0.1528	0.1683	0.1390	0.1315	0.1521



LTE Band 38 (GT - LC = 0.59 dB) QPSK			
Bandwidth	5M		
Channel	37775	38000	38225
	(Low)	(Mid)	(High)
Frequency	2572.5	2595	2617.5
(MHz)			
Conducted Power (dBm)	23.35	23.45	23.37
Conducted Power (Watts)	0.2163	0.2213	0.2173
EIRP(dBm)	23.94	24.04	23.96
EIRP(Watts)	0.2477	0.2535	0.2489

LTE Band 38 (GT - LC = 0.59 dB) QPSK									
Bandwidth	10M			15M			20M		
Channel	37800	38000	38200	37825	38000	38175	37850	38000	38150
	(Low)	(Mid)	(High)	(Low)	(Mid)	(High)	(Low)	(Mid)	(Mid)
Frequency	2575	2595	2615	2577.5	2595	2612.5	2580	2595	2610
(MHz)									
Conducted Power (dBm)	23.46	23.26	23.13	23.50	23.45	23.38	23.51	23.46	23.41
Conducted Power (Watts)	0.2218	0.2118	0.2056	0.2239	0.2213	0.2178	0.2244	0.2218	0.2193
EIRP(dBm)	24.05	23.85	23.72	24.09	24.04	23.97	24.10	24.05	24.00
EIRP(Watts)	0.2541	0.2427	0.2355	0.2564	0.2535	0.2495	0.2570	0.2541	0.2512



LTE Band 38 (GT - LC = 0.59 dB) 16QAM			
Bandwidth	5M		
Channel	37775	38000	38225
	(Low)	(Mid)	(High)
Frequency	2572.5	2595	2617.5
(MHz)			
Conducted Power (dBm)	22.06	22.11	22.15
Conducted Power (Watts)	0.1607	0.1626	0.1641
EIRP(dBm)	22.65	22.70	22.74
EIRP(Watts)	0.1841	0.1862	0.1879

LTE Band 38 (GT - LC = 0.59 dB) 16QAM									
Bandwidth	10M			15M			20M		
Channel	37800	38000	38200	37825	38000	38175	37850	38000	38150
	(Low)	(Mid)	(High)	(Low)	(Mid)	(High)	(Low)	(Mid)	(Mid)
Frequency	2575	2595	2615	2577.5	2595	2612.5	2580	2595	2610
(MHz)									
Conducted Power (dBm)	22.25	22.52	22.02	22.23	22.57	22.52	22.15	22.61	22.23
Conducted Power (Watts)	0.1679	0.1786	0.1592	0.1671	0.1807	0.1786	0.1641	0.1824	0.1671
EIRP(dBm)	22.84	23.11	22.61	22.82	23.16	23.11	22.74	23.20	22.82
EIRP(Watts)	0.1923	0.2046	0.1824	0.1914	0.2070	0.2046	0.1879	0.2089	0.1914



LTE Band 38 (GT - LC = 0.59 dB) 64QAM			
Bandwidth	5M		
Channel	37775	38000	38225
	(Low)	(Mid)	(High)
Frequency	2572.5	2595	2617.5
(MHz)			
Conducted Power (dBm)	21.19	21.11	20.98
Conducted Power (Watts)	0.1315	0.1291	0.1253
EIRP(dBm)	21.78	21.70	21.57
EIRP(Watts)	0.1507	0.1479	0.1435

LTE Band 38 (GT - LC = 0.59 dB) 64QAM									
Bandwidth	10M			15M			20M		
Channel	37800	38000	38200	37825	38000	38175	37850	38000	38150
	(Low)	(Mid)	(High)	(Low)	(Mid)	(High)	(Low)	(Mid)	(Mid)
Frequency	2575	2595	2615	2577.5	2595	2612.5	2580	2595	2610
(MHz)									
Conducted Power (dBm)	21.16	20.86	20.78	21.26	21.15	21.09	20.99	20.84	20.98
Conducted Power (Watts)	0.1306	0.1219	0.1197	0.1337	0.1303	0.1285	0.1256	0.1213	0.1253
EIRP(dBm)	21.75	21.45	21.37	21.85	21.74	21.68	21.58	21.43	21.57
EIRP(Watts)	0.1496	0.1396	0.1371	0.1531	0.1493	0.1472	0.1439	0.1390	0.1435



Peak-to-Average Ratio

Mode	LTE Band 2 / 20MHz				
Mod.	QPSK		16QAM		Limit: 13dB
RB Size	1RB	Full RB	1RB	Full RB	Result
Lowest CH	3.74	4.81	4.81	5.86	PASS
Middle CH	3.71	4.61	4.64	5.57	
Highest CH	3.83	4.75	4.55	5.80	
Mod.	64QAM		Limit: 13dB		
RB Size	1RB	Full RB	Result		
Lowest CH	4.46	5.83	PASS		
Middle CH	4.46	5.57			
Highest CH	4.67	5.83			

Mode	LTE Band 4 / 20MHz				
Mod.	QPSK		16QAM		Limit: 13dB
RB Size	1RB	Full RB	1RB	Full RB	Result
Lowest CH	5.10	5.07	5.97	6.20	PASS
Middle CH	4.67	5.16	5.62	6.20	
Highest CH	5.07	5.25	5.80	6.35	
Mod.	64QAM		Limit: 13dB		
RB Size	1RB	Full RB	Result		
Lowest CH	6.84	6.67	PASS		
Middle CH	6.49	6.75			
Highest CH	7.10	6.87			

Mode	LTE Band 5 / 10MHz				
Mod.	QPSK		16QAM		Limit: 13dB
RB Size	1RB	Full RB	1RB	Full RB	Result
Lowest CH	4.29	4.78	5.10	5.74	PASS
Middle CH	4.17	4.84	5.13	5.88	
Highest CH	4.38	4.81	5.51	5.77	
Mod.	64QAM		Limit: 13dB		
RB Size	1RB	Full RB	Result		
Lowest CH	6.17	6.26	PASS		
Middle CH	6.17	6.35			
Highest CH	6.26	6.20			



Mode	LTE Band 7 / 20MHz				
Mod.	QPSK		16QAM		Limit: 13dB
RB Size	1RB	Full RB	1RB	Full RB	Result
Lowest CH	3.54	4.12	4.29	5.10	PASS
Middle CH	3.57	4.49	4.67	5.45	
Highest CH	3.74	4.35	4.49	5.33	
Mod.	64QAM		Limit: 13dB		
RB Size	1RB	Full RB	Result		
Lowest CH	5.42	5.57	PASS		
Middle CH	5.42	5.94			
Highest CH	5.39	5.74			

Mode	LTE Band 38 / 20MHz				
Mod.	QPSK		16QAM		Limit: 13dB
RB Size	1RB	Full RB	1RB	Full RB	Result
Lowest CH	4.64	5.45	5.54	5.91	PASS
Middle CH	5.71	5.01	5.54	5.91	
Highest CH	4.46	4.99	5.88	5.94	
Mod.	64QAM		Limit: 13dB		
RB Size	1RB	Full RB	Result		
Lowest CH	6.58	6.32	PASS		
Middle CH	6.55	6.32			
Highest CH	6.26	6.84			



LTE Band 2 / 20MHz / QPSK

Lowest Channel / 1RB

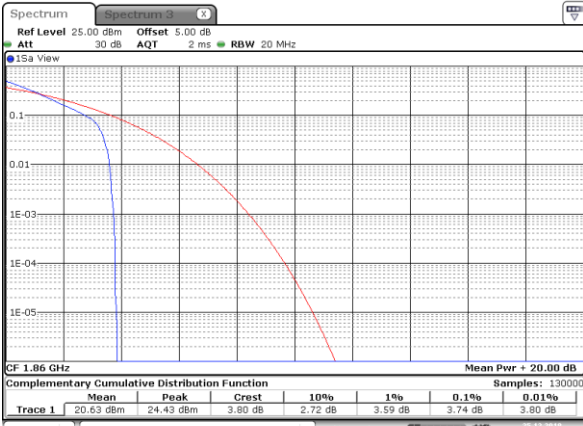

Date: 25 DEC 2018 16:01:27

Lowest Channel / Full RB

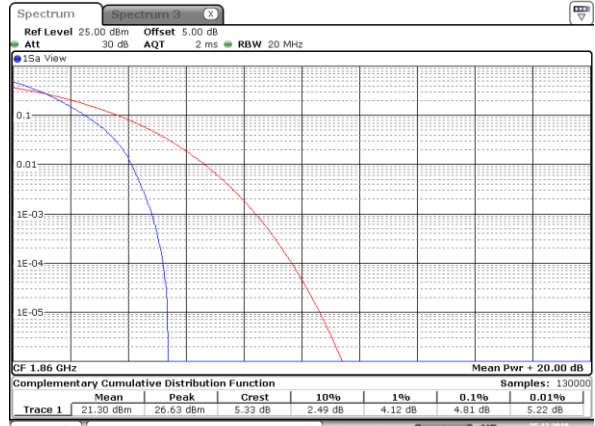

Date: 25 DEC 2018 16:02:39

Middle Channel / 1RB

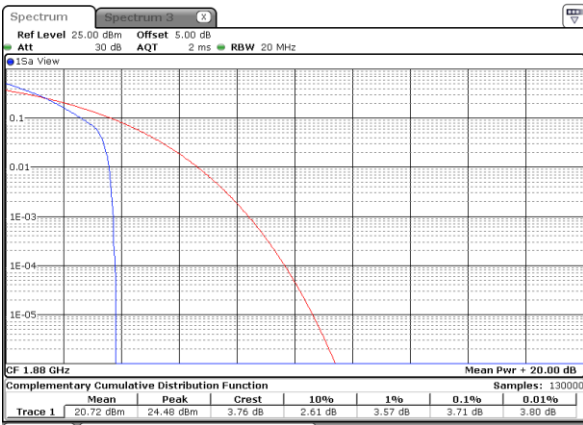

Date: 25 DEC 2018 16:03:25

Middle Channel / Full RB

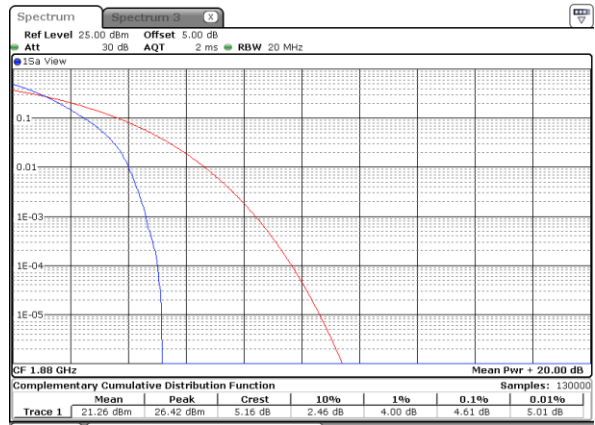

Date: 25 DEC 2018 16:02:51

Highest Channel / 1RB

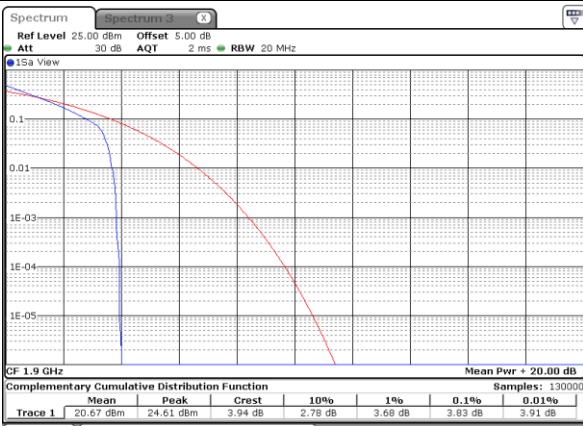

Date: 25 DEC 2018 16:03:38

Highest Channel / Full RB

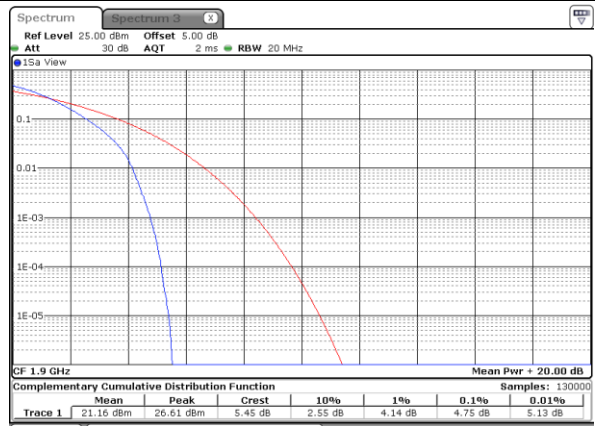

Date: 25 DEC 2018 16:04:13



LTE Band 2 / 20MHz / 16QAM

Lowest Channel / 1RB

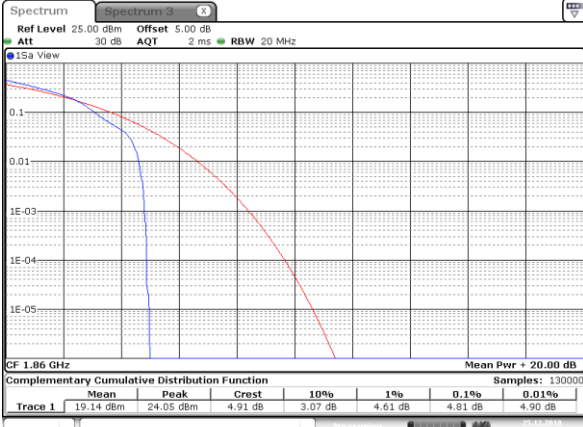

Date: 25.DEC.2018 15:06:56

Lowest Channel / Full RB

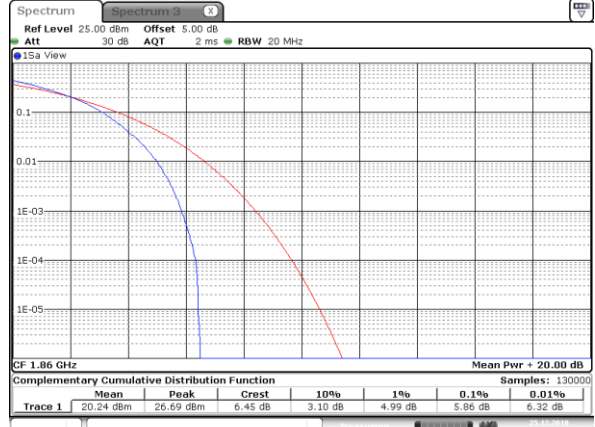

Date: 25.DEC.2018 15:07:06

Middle Channel / 1RB

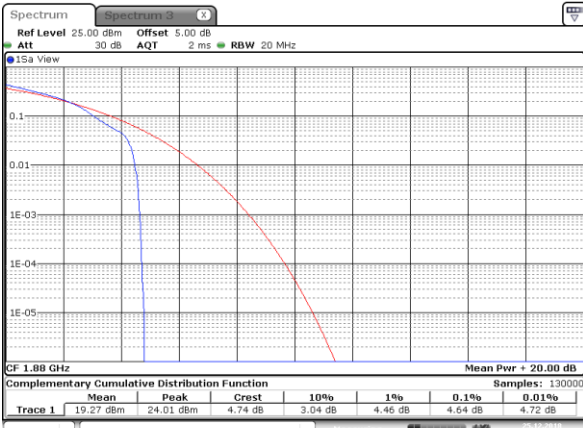

Date: 25.DEC.2018 15:07:16

Middle Channel / Full RB

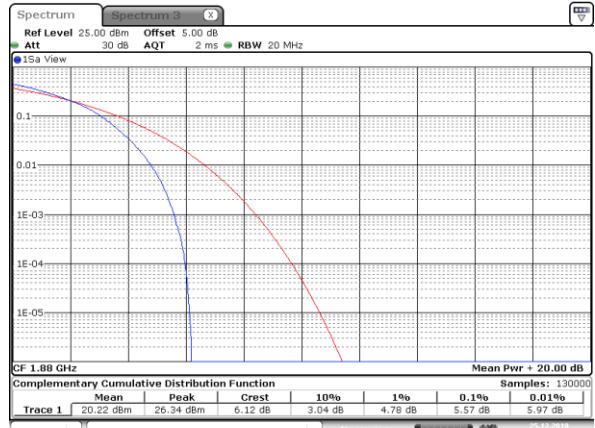

Date: 25.DEC.2018 15:07:25

Highest Channel / 1RB

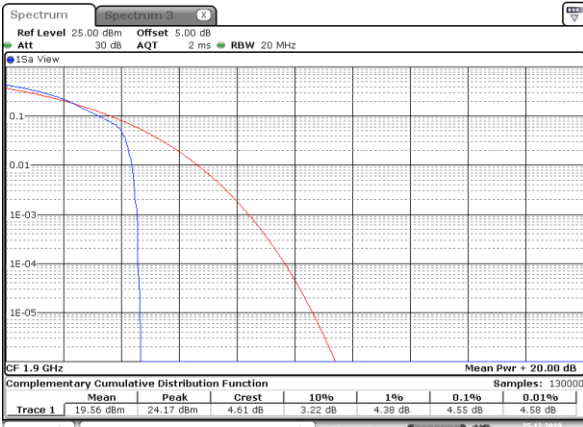

Date: 25.DEC.2018 15:07:35

Highest Channel / Full RB

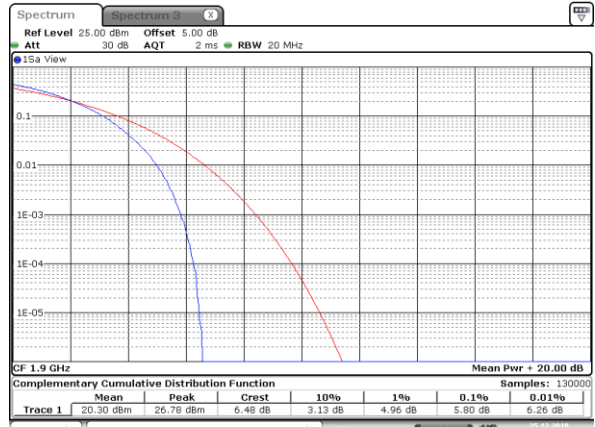

Date: 25.DEC.2018 15:07:45



LTE Band 2 / 20MHz / 64QAM

Lowest Channel / 1RB

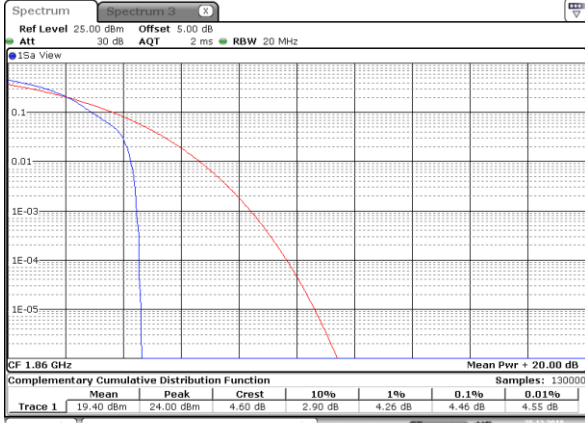

Date: 25 DEC 2018 16:01:38

Lowest Channel / Full RB

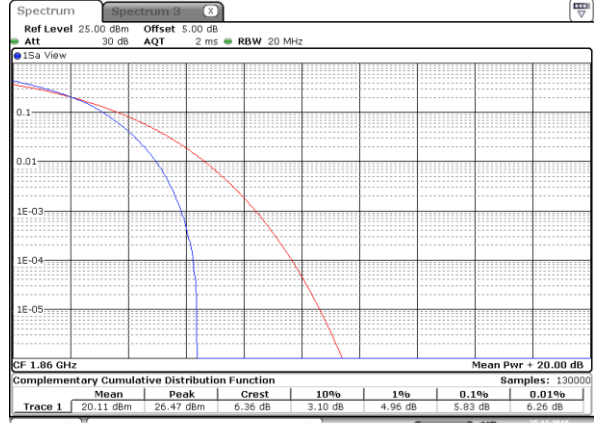

Date: 25 DEC 2018 16:01:50

Middle Channel / 1RB

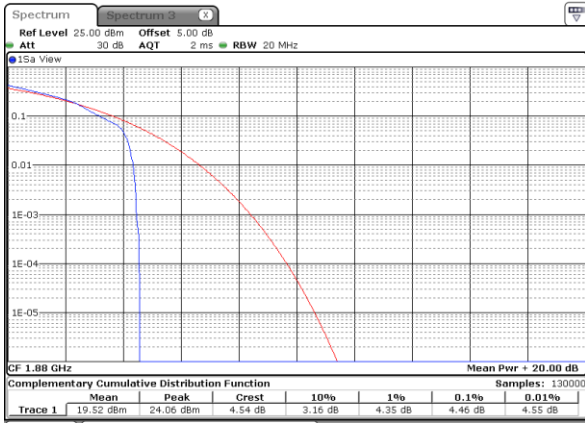

Date: 25 DEC 2018 16:03:14

Middle Channel / Full RB

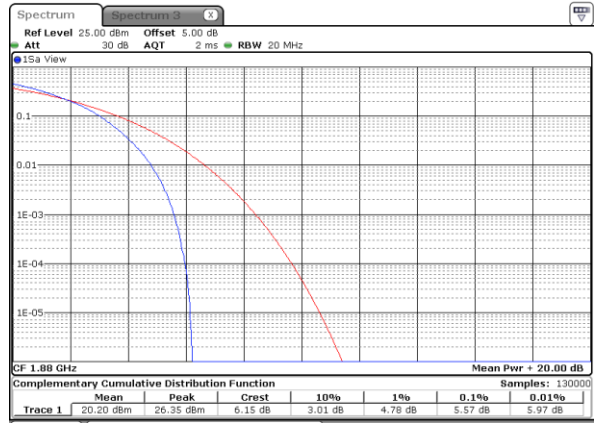

Date: 25 DEC 2018 16:03:03

Highest Channel / 1RB

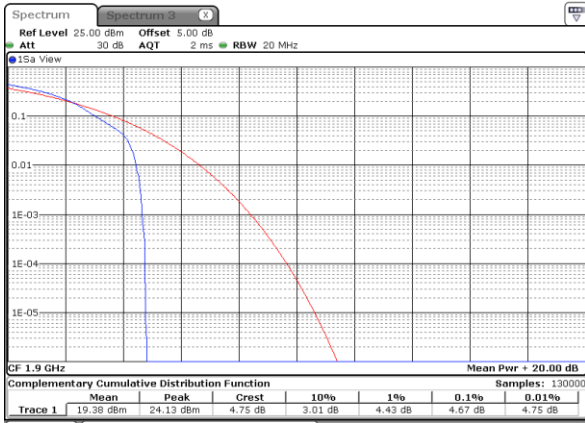

Date: 25 DEC 2018 16:03:50

Highest Channel / Full RB

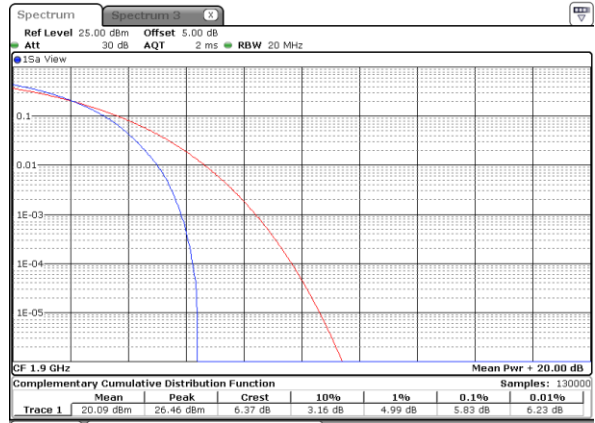

Date: 25 DEC 2018 16:04:02



LTE Band 4 / 20MHz / QPSK

Lowest Channel / 1RB

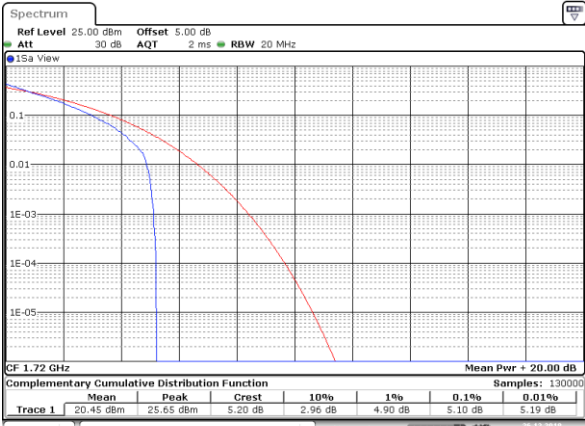

Date: 26 DEC 2018 09:37:27

Lowest Channel / Full RB

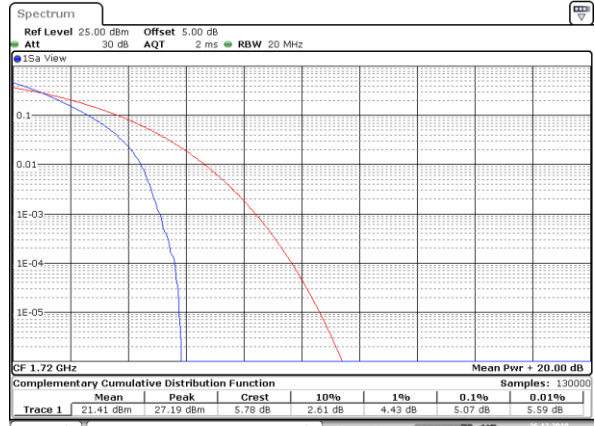

Date: 26 DEC 2018 09:37:38

Middle Channel / 1RB

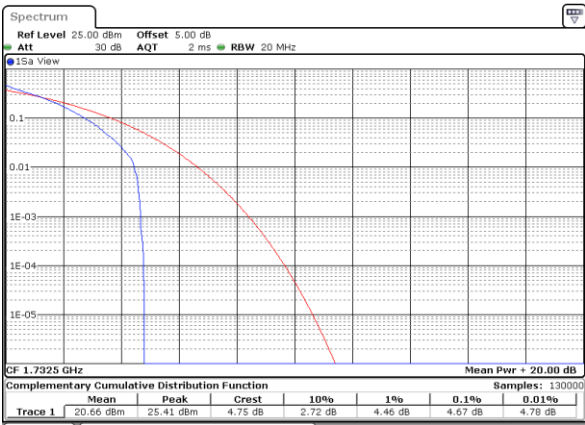

Date: 26 DEC 2018 09:38:02

Middle Channel / Full RB

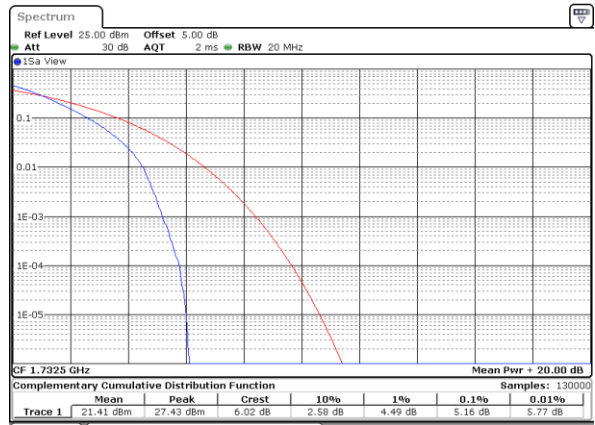

Date: 26 DEC 2018 09:37:49

Highest Channel / 1RB



Date: 26 DEC 2018 09:38:12

Highest Channel / Full RB

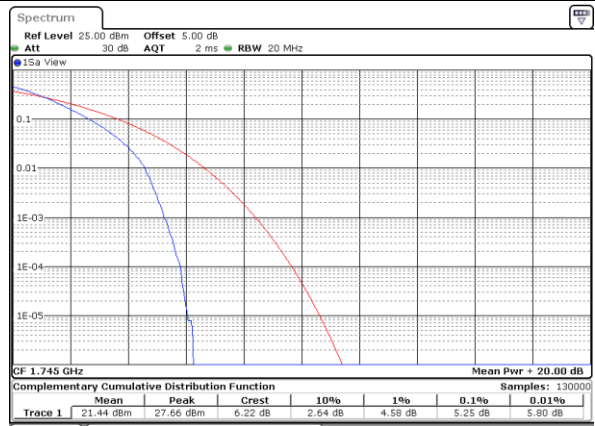

Date: 26 DEC 2018 09:38:24



LTE Band 4 / 20MHz / 16QAM

Lowest Channel / 1RB

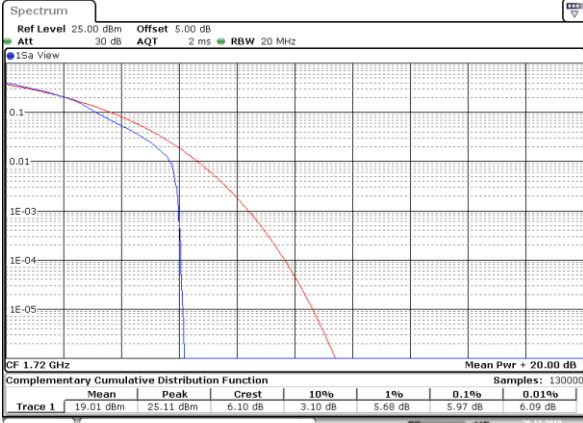

Date: 26 DEC 2018 09:35:33

Lowest Channel / Full RB

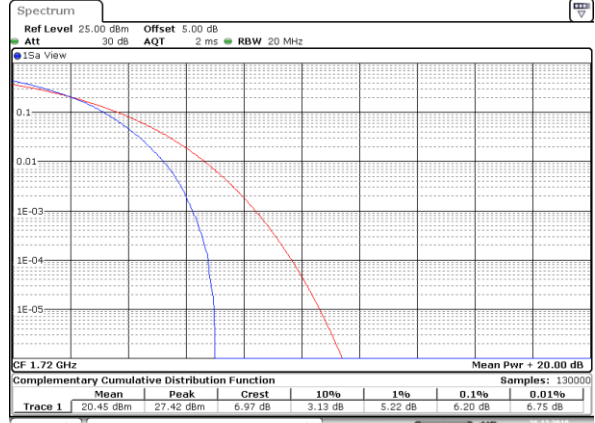

Date: 26 DEC 2018 09:35:42

Middle Channel / 1RB

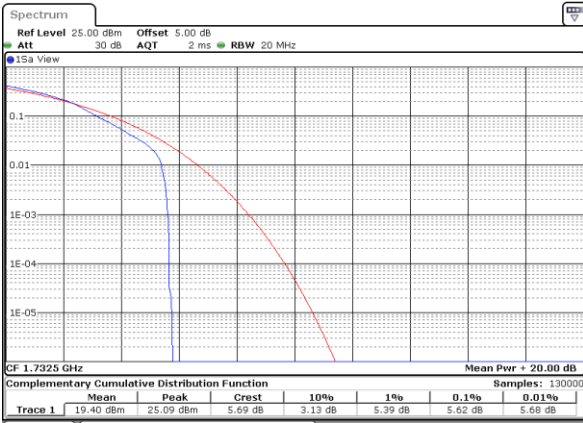

Date: 26 DEC 2018 09:35:50

Middle Channel / Full RB

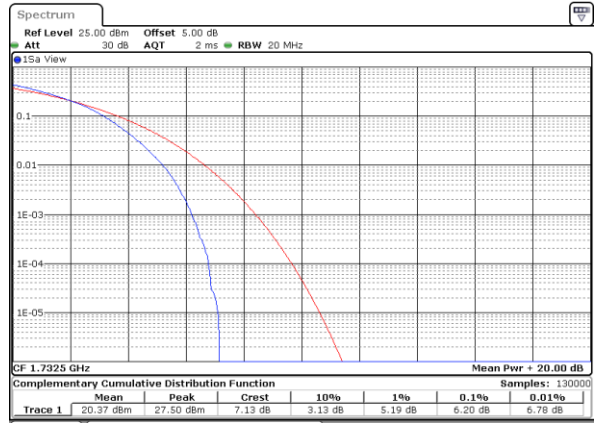

Date: 26 DEC 2018 09:35:59

Highest Channel / 1RB

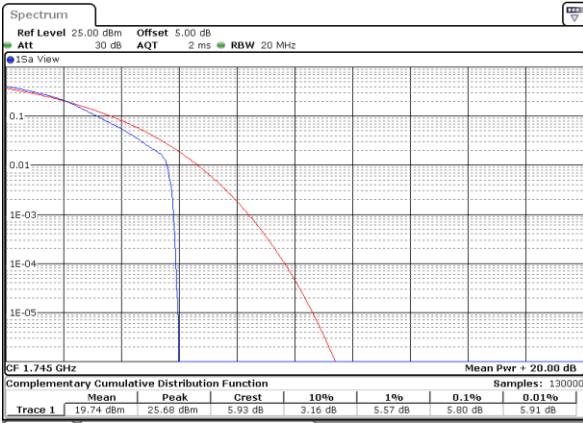

Date: 26 DEC 2018 09:36:08

Highest Channel / Full RB

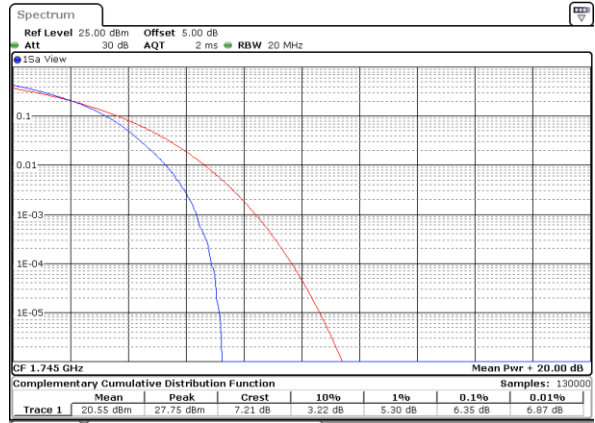

Date: 26 DEC 2018 09:36:17



LTE Band 4 / 20MHz / 64QAM

Lowest Channel / 1RB

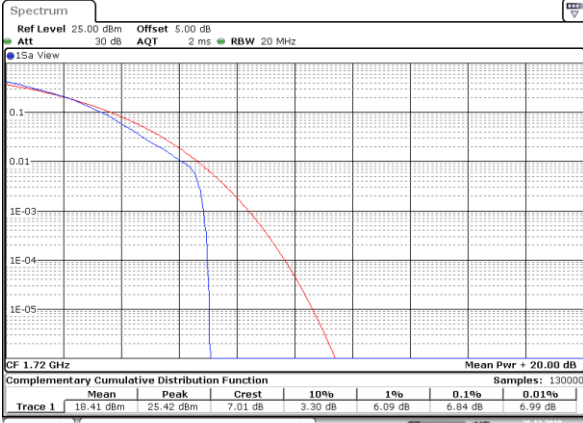

Date: 26 DEC 2018 10:41:31

Lowest Channel / Full RB

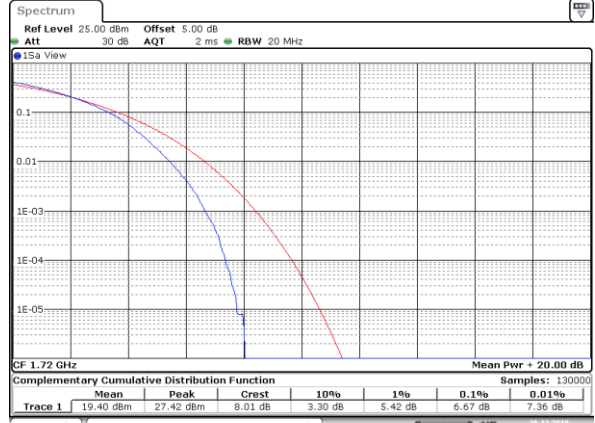

Date: 26 DEC 2018 10:41:40

Middle Channel / 1RB

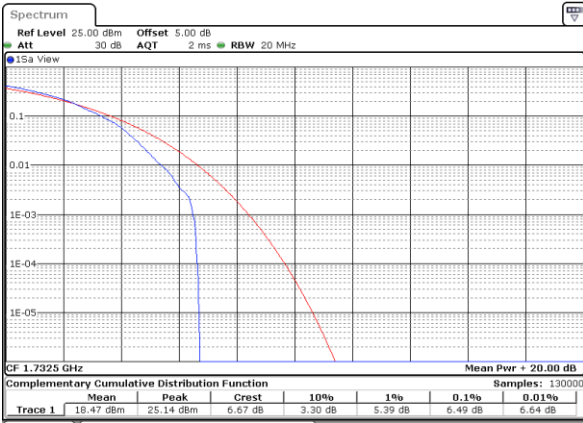

Date: 26 DEC 2018 10:41:49

Middle Channel / Full RB

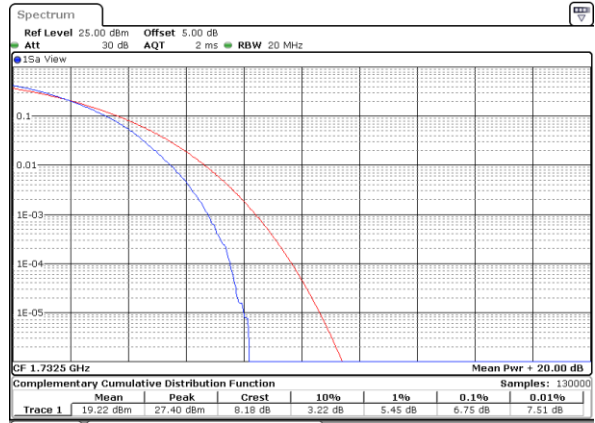

Date: 26 DEC 2018 10:41:58

Highest Channel / 1RB

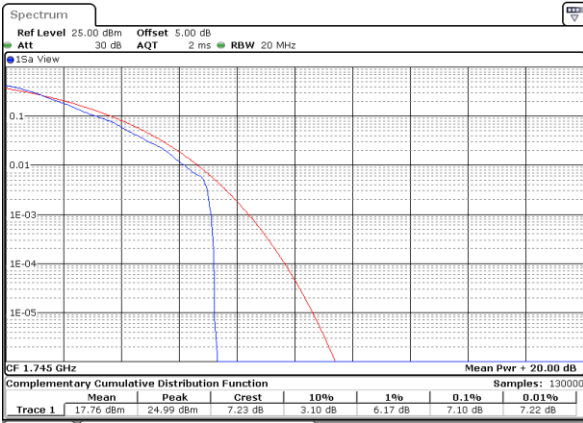

Date: 26 DEC 2018 10:42:07

Highest Channel / Full RB

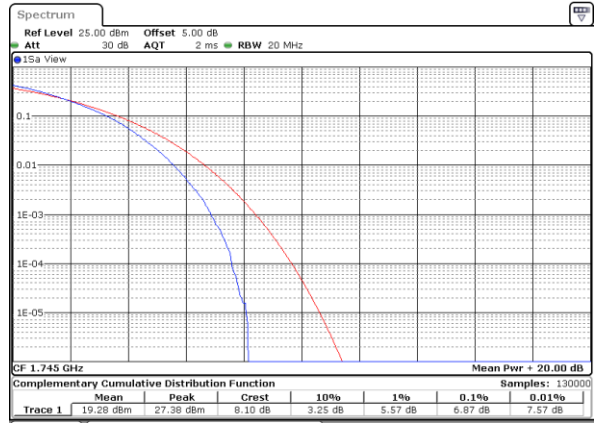

Date: 26 DEC 2018 10:42:16



LTE Band 5 / 10MHz / QPSK

Lowest Channel / 1RB

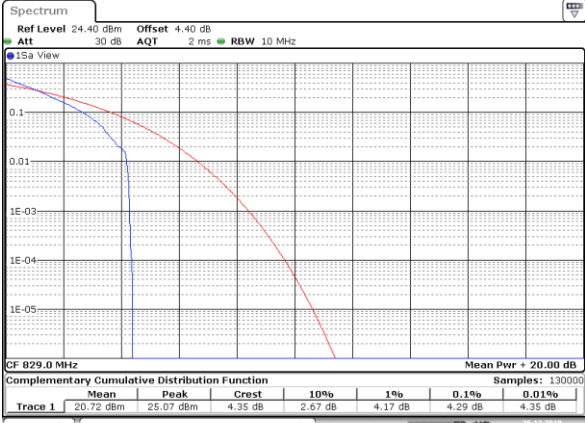

Date: 26 DEC 2018 12:51:33

Lowest Channel / Full RB

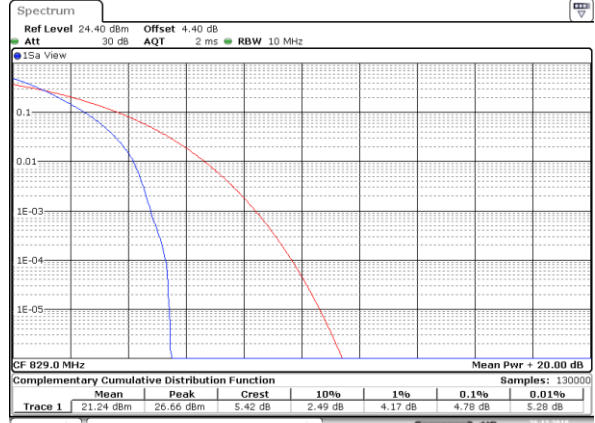

Date: 26 DEC 2018 12:51:01

Middle Channel / 1RB

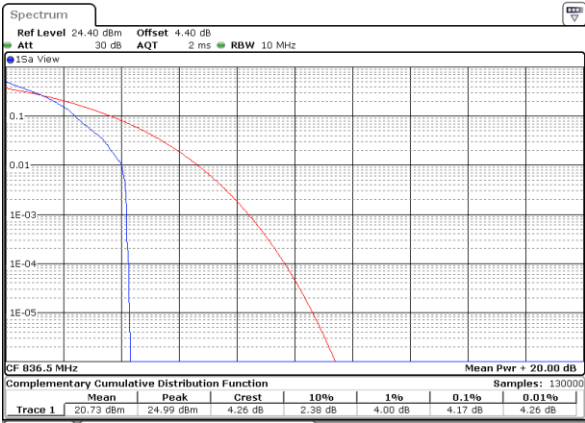

Date: 26 DEC 2018 12:51:47

Middle Channel / Full RB

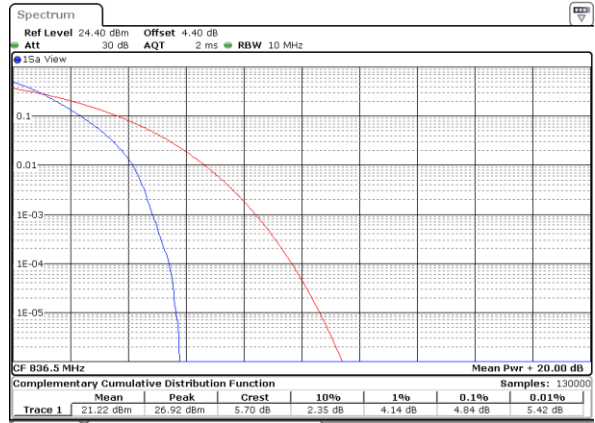

Date: 26 DEC 2018 12:52:19

Highest Channel / 1RB

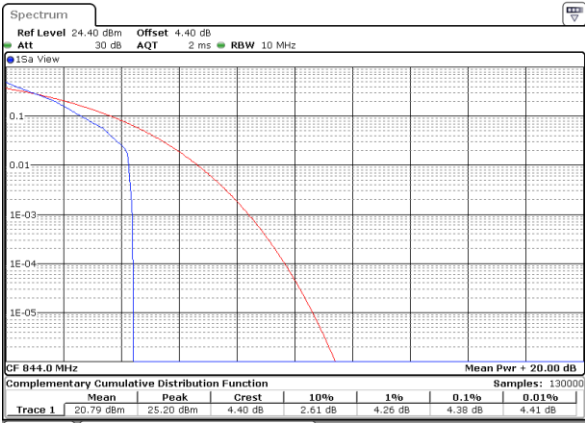

Date: 26 DEC 2018 12:53:05

Highest Channel / Full RB

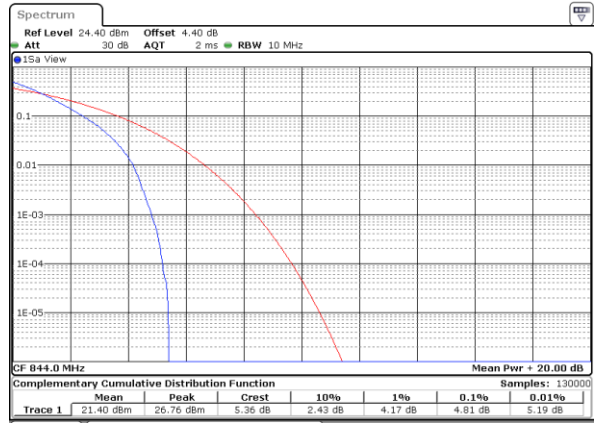

Date: 26 DEC 2018 12:52:33



LTE Band 5 / 10MHz / 16QAM

Lowest Channel / 1RB

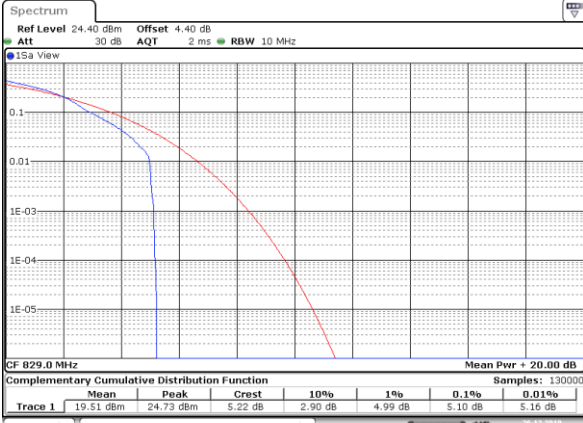

Date: 26 DEC 2018 12:51:23

Lowest Channel / Full RB

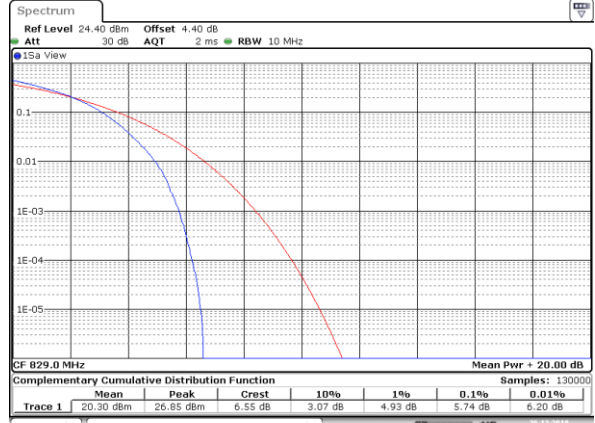

Date: 26 DEC 2018 12:51:12

Middle Channel / 1RB

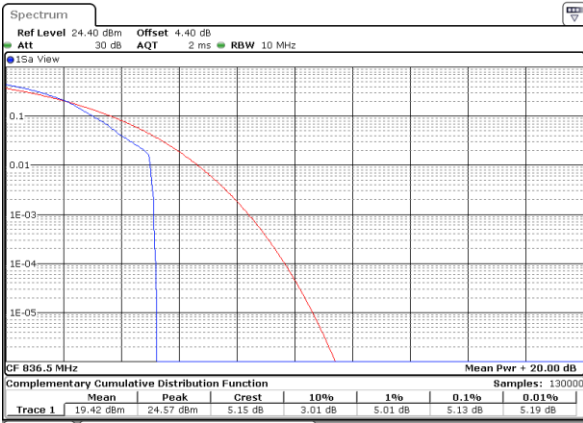

Date: 26 DEC 2018 12:51:58

Middle Channel / Full RB

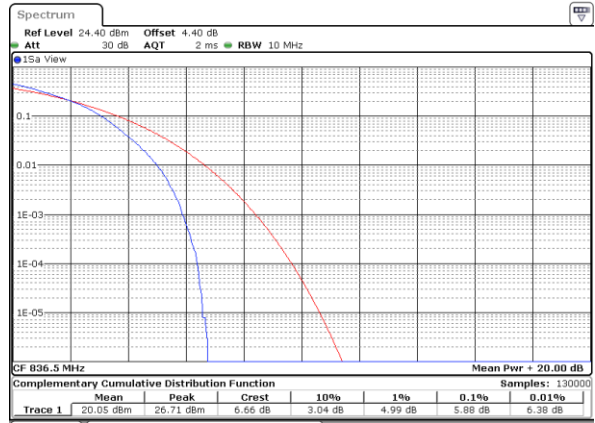

Date: 26 DEC 2018 12:52:09

Highest Channel / 1RB

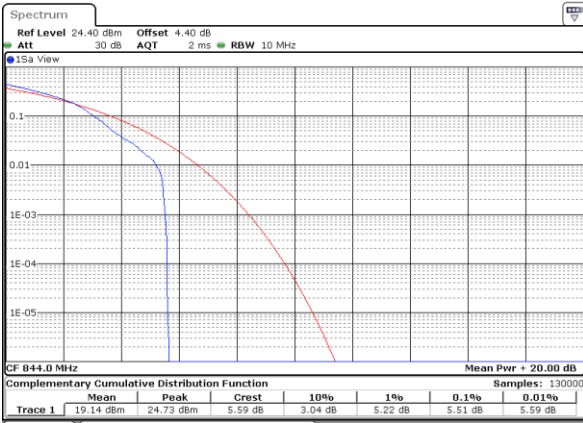

Date: 26 DEC 2018 12:52:54

Highest Channel / Full RB

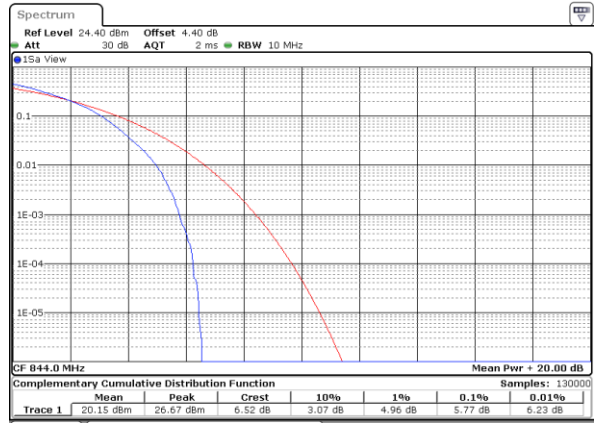

Date: 26 DEC 2018 12:52:44



LTE Band 5 / 10MHz / 64QAM

Lowest Channel / 1RB

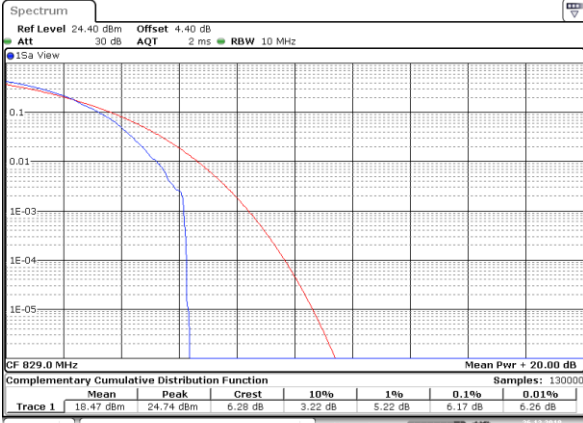

Date: 26 DEC 2018 12:50:16

Lowest Channel / Full RB

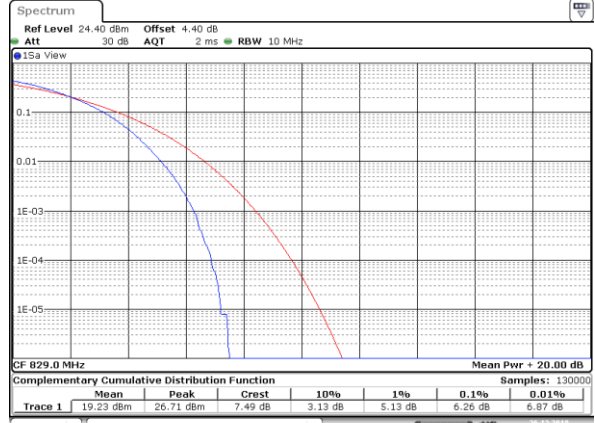

Date: 26 DEC 2018 12:50:25

Middle Channel / 1RB

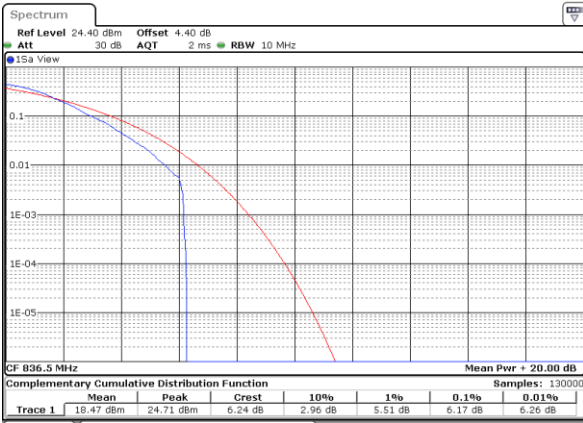

Date: 26 DEC 2018 12:50:06

Middle Channel / Full RB

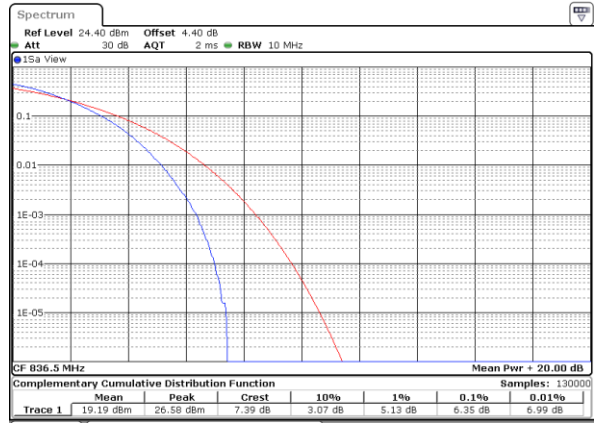

Date: 26 DEC 2018 12:49:57

Highest Channel / 1RB

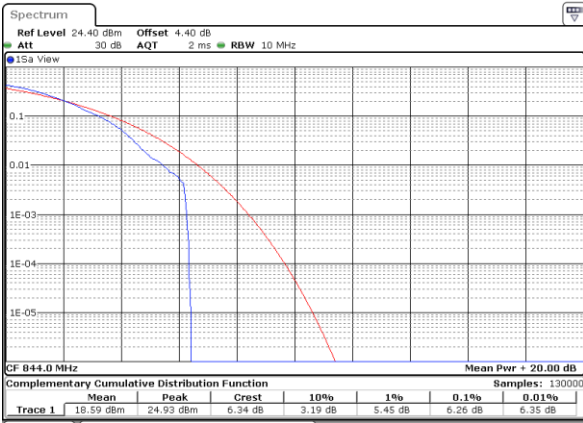

Date: 26 DEC 2018 12:49:40

Highest Channel / Full RB

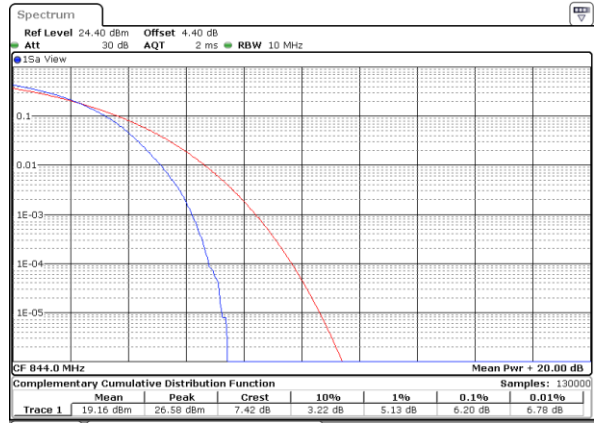

Date: 26 DEC 2018 12:49:49



LTE Band 7 / 20MHz / QPSK

Lowest Channel / 1RB

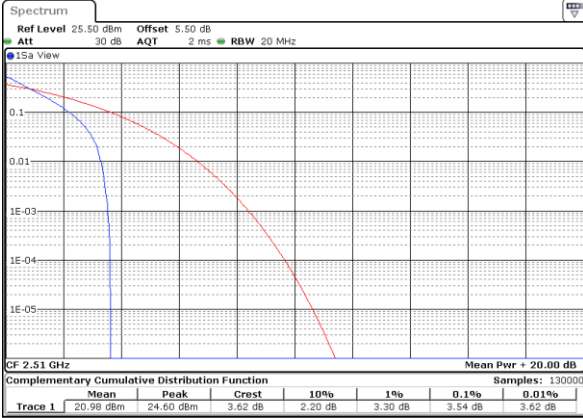

Date: 26 DEC 2018 15:02:50

Lowest Channel / Full RB

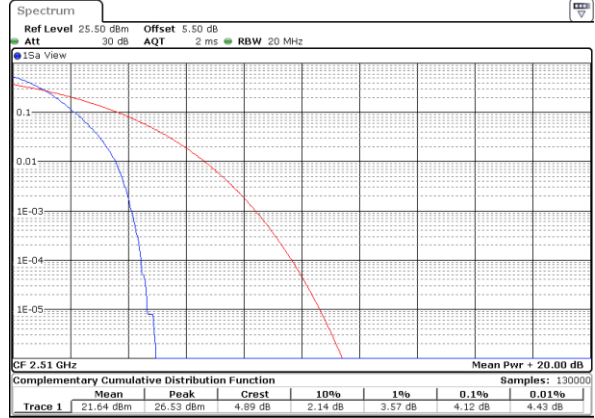

Date: 26 DEC 2018 15:02:59

Middle Channel / 1RB

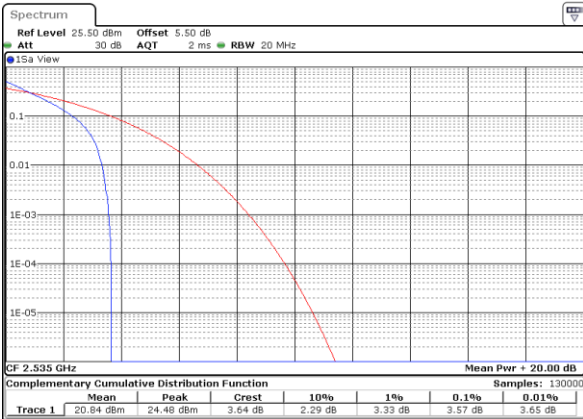

Date: 26 DEC 2018 15:03:34

Middle Channel / Full RB

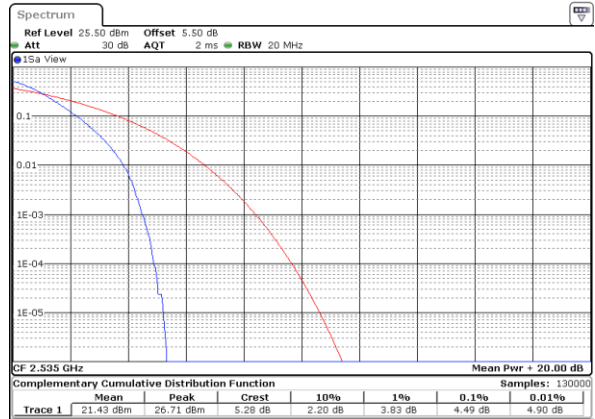

Date: 26 DEC 2018 15:03:25

Highest Channel / 1RB

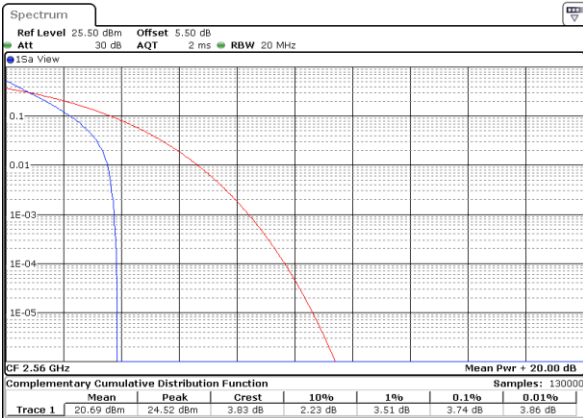

Date: 26 DEC 2018 15:03:59

Highest Channel / Full RB

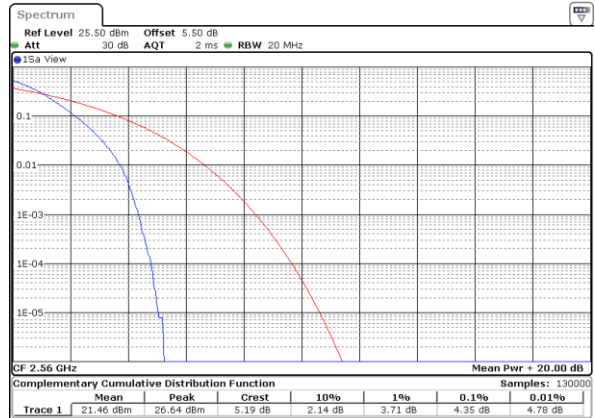

Date: 26 DEC 2018 15:04:08



LTE Band 7 / 20MHz / 16QAM

Lowest Channel / 1RB

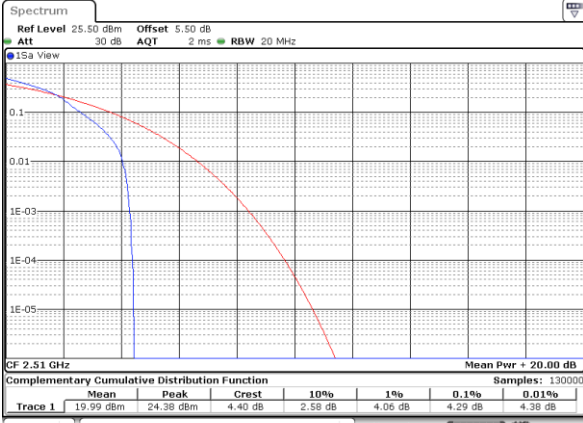

Date: 26 DEC 2018 15:02:41

Lowest Channel / Full RB

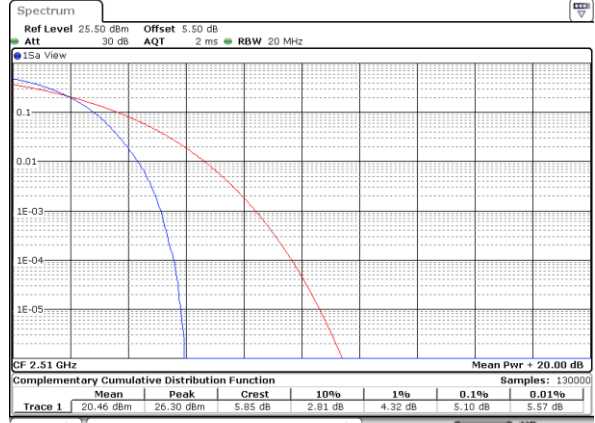

Date: 26 DEC 2018 15:03:08

Middle Channel / 1RB

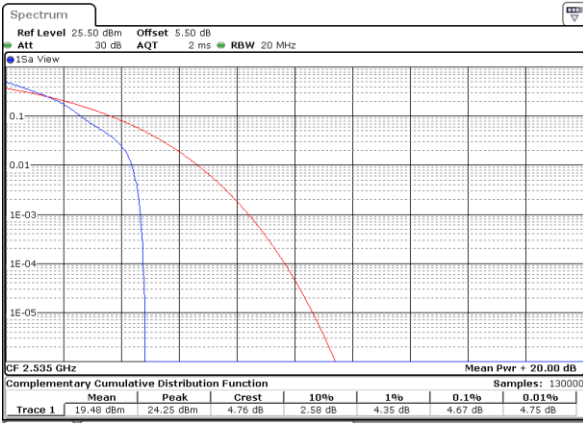

Date: 26 DEC 2018 15:03:42

Middle Channel / Full RB

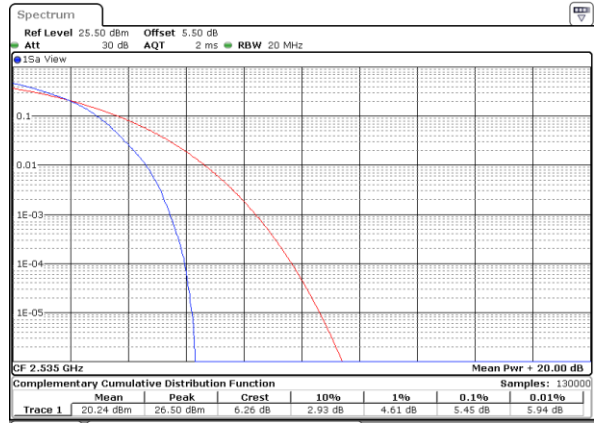

Date: 26 DEC 2018 15:03:16

Highest Channel / 1RB

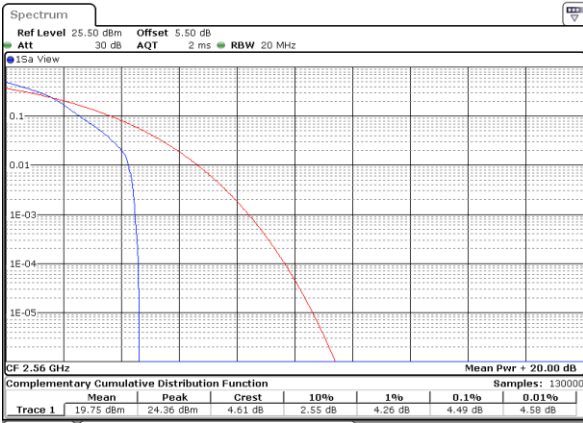

Date: 26 DEC 2018 15:03:51

Highest Channel / Full RB

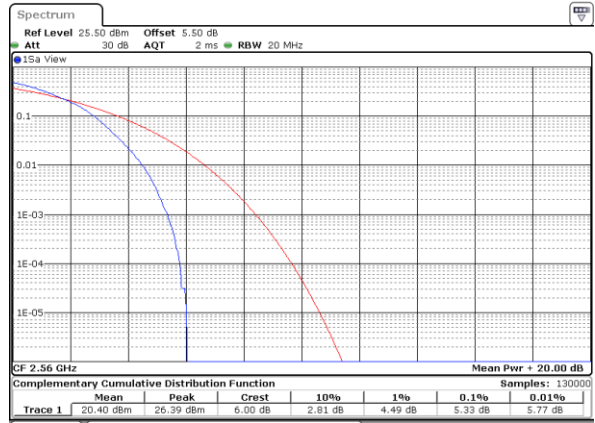

Date: 26 DEC 2018 15:04:17



LTE Band 7 / 20MHz / 64QAM

Lowest Channel / 1RB

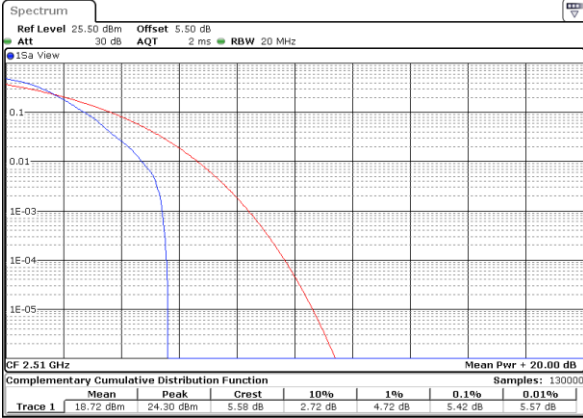

Date: 26 DEC 2018 15:41:02

Lowest Channel / Full RB

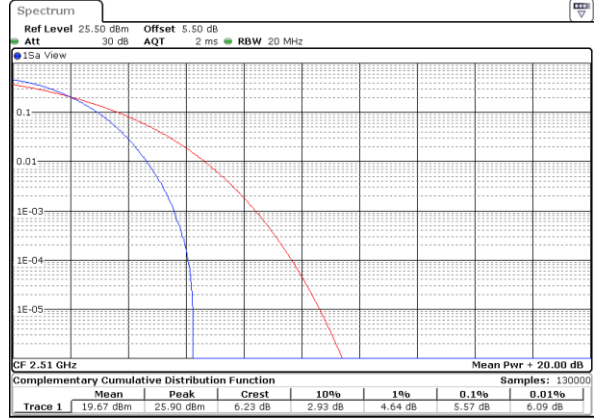

Date: 26 DEC 2018 15:41:11

Middle Channel / 1RB

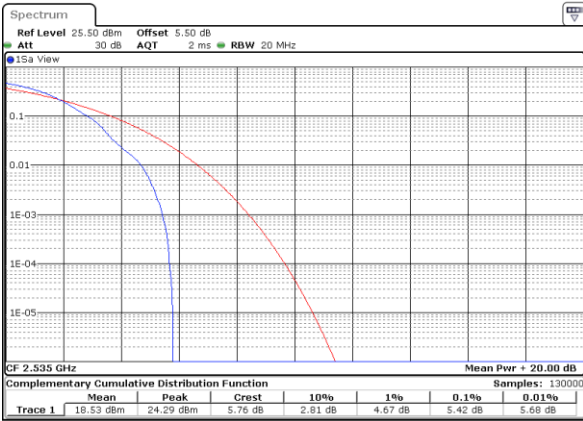

Date: 26 DEC 2018 15:41:30

Middle Channel / Full RB

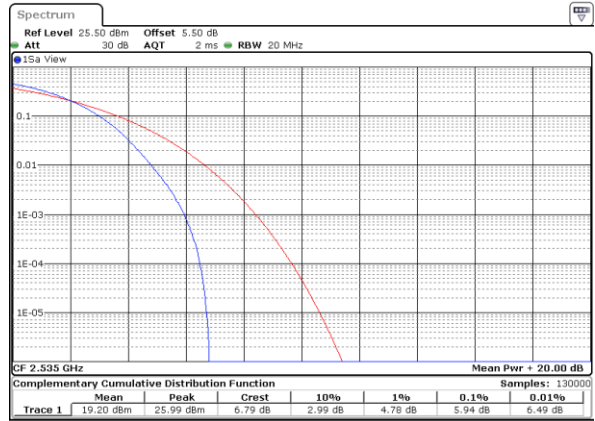

Date: 26 DEC 2018 15:41:21

Highest Channel / 1RB

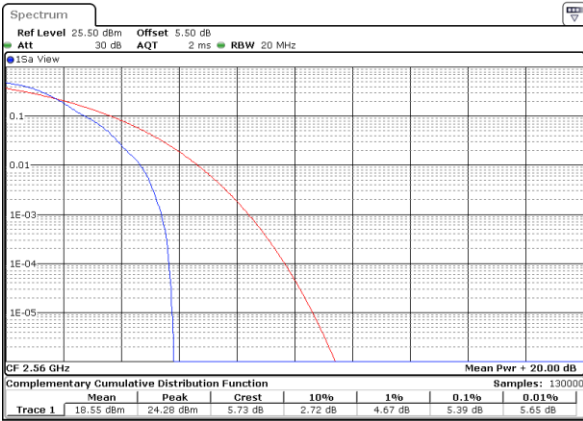

Date: 26 DEC 2018 15:41:40

Highest Channel / Full RB

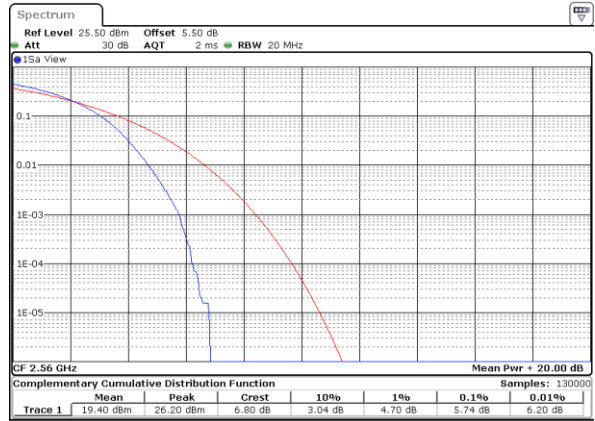

Date: 26 DEC 2018 15:41:49



LTE Band 38 / 20MHz / QPSK

Lowest Channel / 1RB

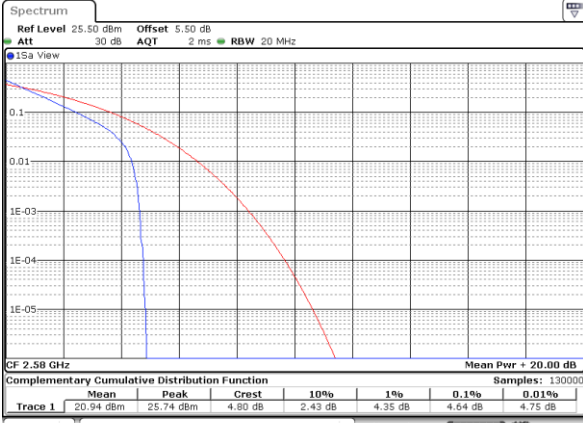

Date: 28 DEC 2018 10:53:48

Lowest Channel / Full RB

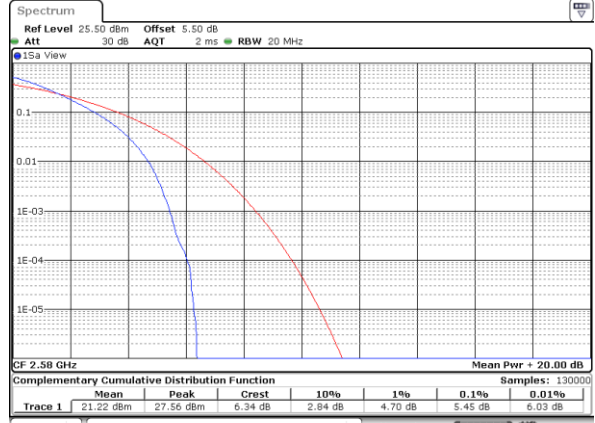

Date: 28 DEC 2018 10:54:07

Middle Channel / 1RB

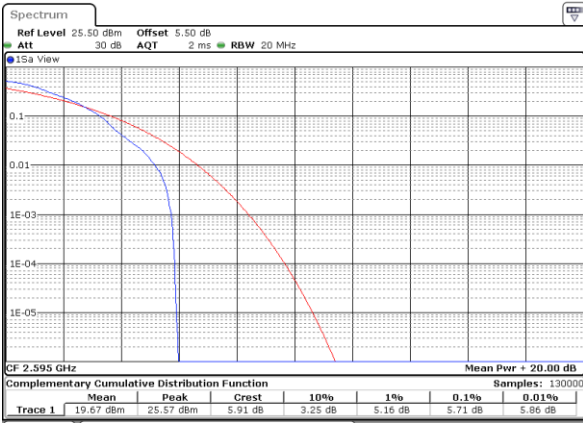

Date: 28 DEC 2018 10:55:48

Middle Channel / Full RB

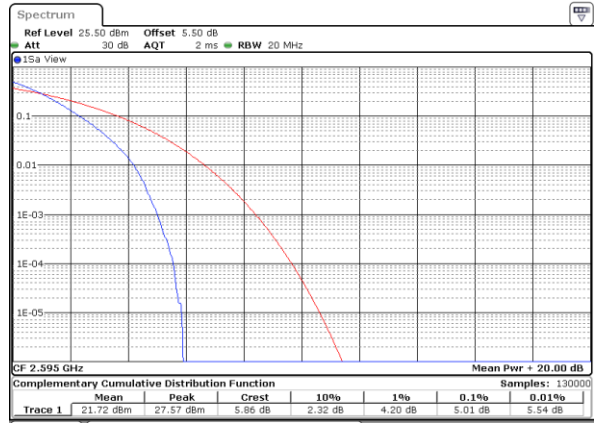

Date: 28 DEC 2018 10:56:59

Highest Channel / 1RB

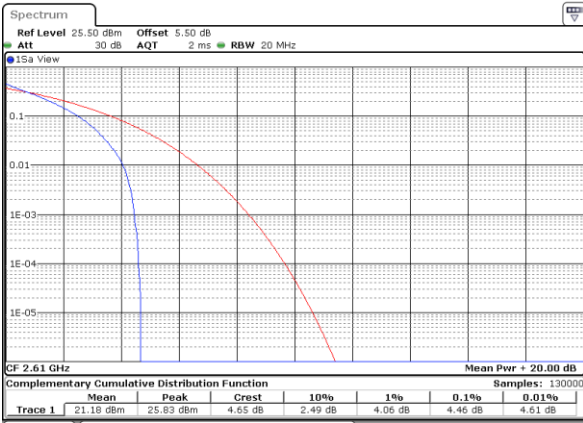

Date: 28 DEC 2018 10:59:08

Highest Channel / Full RB

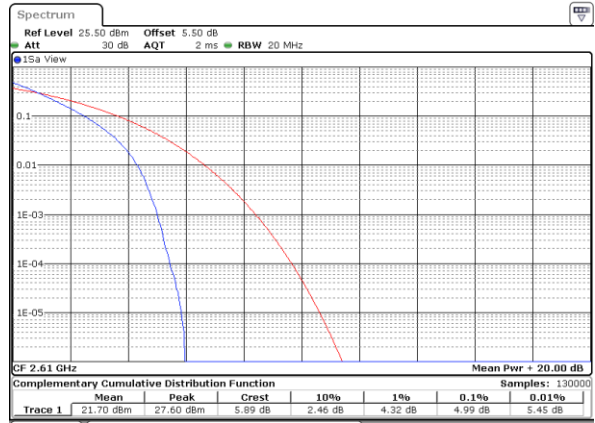

Date: 28 DEC 2018 10:57:32



LTE Band 38 / 20MHz / 16QAM

Lowest Channel / 1RB

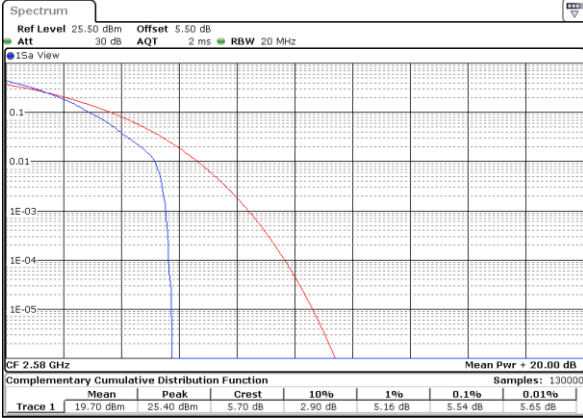

Date: 28 DEC 2018 10:54:41

Lowest Channel / Full RB

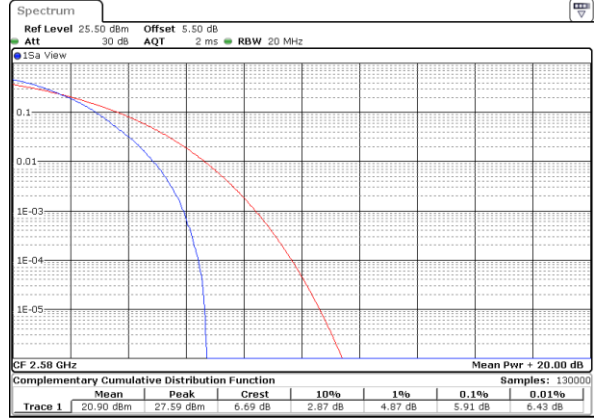

Date: 28 DEC 2018 10:54:23

Middle Channel / 1RB

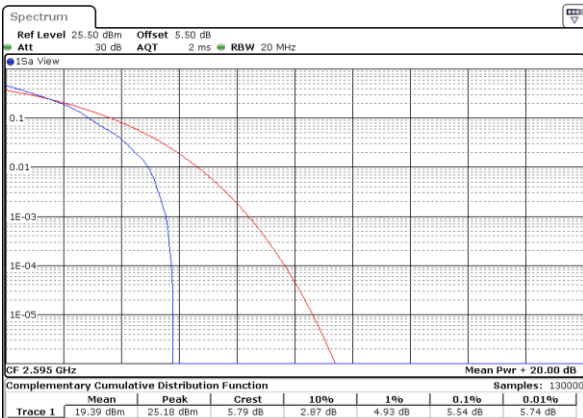

Date: 28 DEC 2018 10:55:59

Middle Channel / Full RB

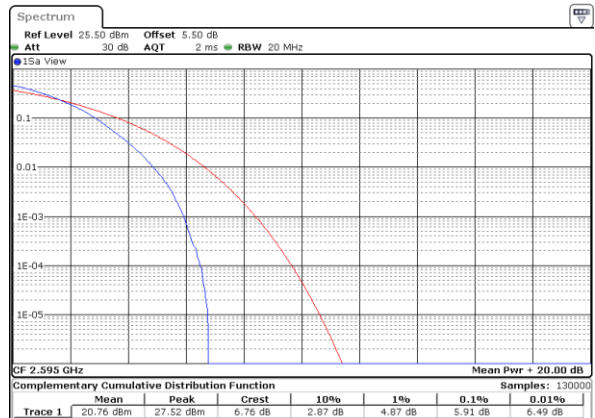

Date: 28 DEC 2018 10:56:41

Highest Channel / 1RB

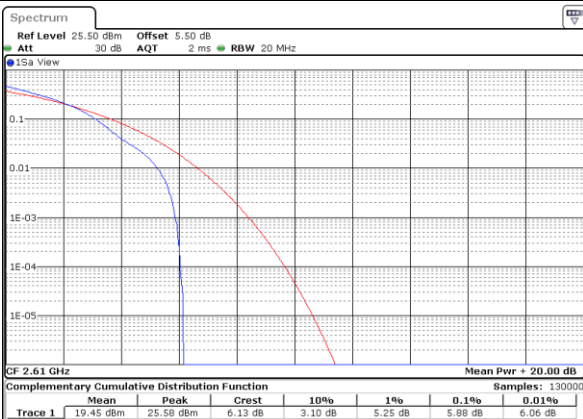

Date: 28 DEC 2018 10:58:57

Highest Channel / Full RB



Date: 28 DEC 2018 10:57:51



LTE Band 38 / 20MHz / 64QAM

Lowest Channel / 1RB

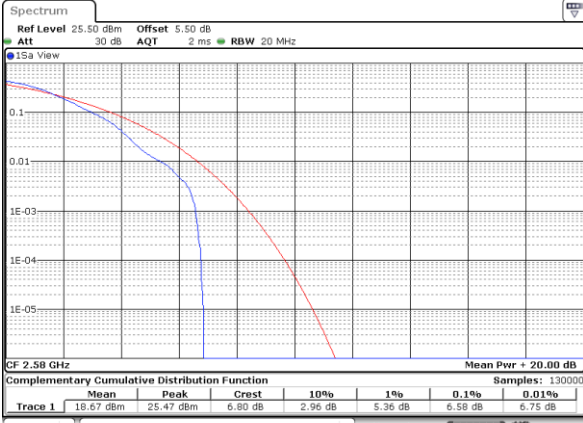

Date: 28 DEC 2018 10:55:02

Lowest Channel / Full RB



Date: 28 DEC 2018 10:55:22

Middle Channel / 1RB

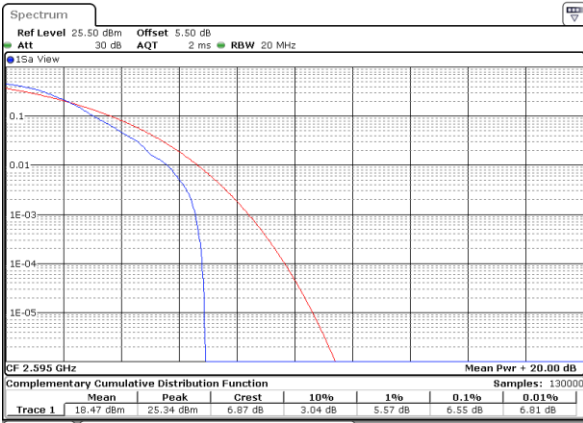

Date: 28 DEC 2018 10:56:11

Middle Channel / Full RB

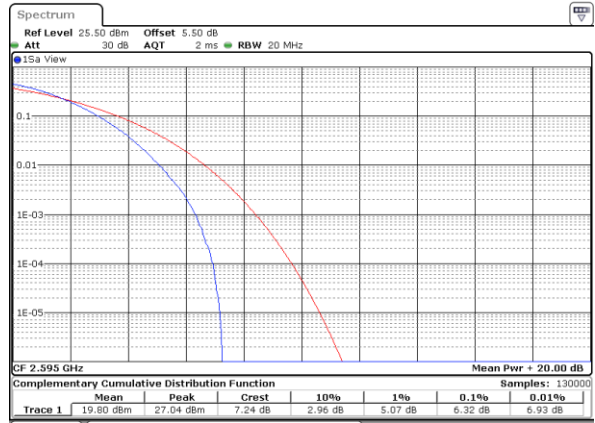

Date: 28 DEC 2018 10:56:29

Highest Channel / 1RB

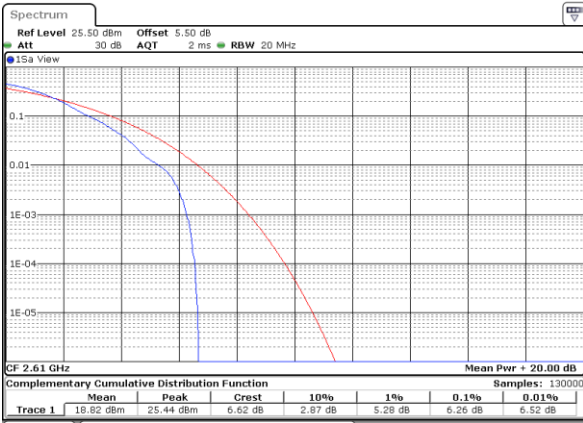

Date: 28 DEC 2018 10:58:45

Highest Channel / Full RB

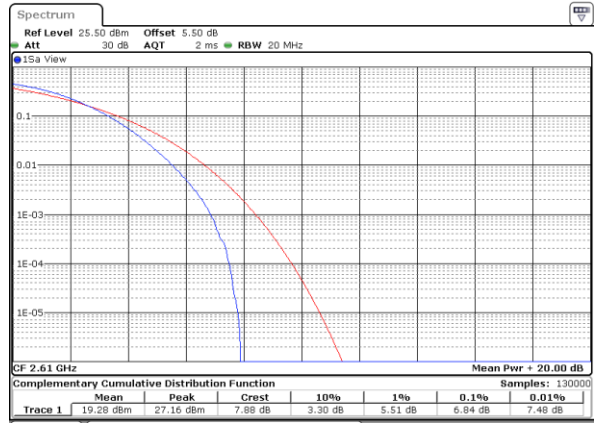

Date: 28 DEC 2018 10:58:24



26dB Bandwidth

Mode	LTE Band 2 : 26dB BW(MHz)											
	1.4MHz		3MHz		5MHz		10MHz		15MHz		20MHz	
BW	1.4MHz		3MHz		5MHz		10MHz		15MHz		20MHz	
Mod.	QPSK	16QAM	QPSK	16QAM	QPSK	16QAM	QPSK	16QAM	QPSK	16QAM	QPSK	16QAM
Lowest CH	1.2951	1.3175	3.003	3.009	4.935	4.945	9.81	9.79	14.446	14.356	20.14	20.14
Middle CH	1.2839	1.3147	3.003	3.033	4.915	4.895	9.71	10.01	14.446	14.326	20.06	20.06
Highest CH	1.3119	1.2811	3.015	2.9491	4.975	4.905	9.67	9.67	14.296	14.655	20.18	20.06
BW	1.4MHz		3MHz		5MHz		10MHz		15MHz		20MHz	
Mod.	64QAM		64QAM		64QAM		64QAM		64QAM		64QAM	
Lowest CH	1.3007		3.039		4.945		9.81		14.326		20.22	
Middle CH	1.2811		2.991		4.935		9.91		14.356		20.14	
Highest CH	1.2951		3.045		4.835		9.71		14.356		20.18	

Mode	LTE Band 4 : 26dB BW(MHz)											
	1.4MHz		3MHz		5MHz		10MHz		15MHz		20MHz	
BW	1.4MHz		3MHz		5MHz		10MHz		15MHz		20MHz	
Mod.	QPSK	16QAM	QPSK	16QAM	QPSK	16QAM	QPSK	16QAM	QPSK	16QAM	QPSK	16QAM
Lowest CH	1.2643	1.2671	3.039	3.033	4.925	4.955	10.05	9.85	14.476	14.535	20.3	20.22
Middle CH	1.2699	1.3119	3.039	3.027	4.855	4.835	9.91	9.71	14.266	14.296	20.1	20.14
Highest CH	1.2839	1.2392	3.0689	2.985	4.865	4.895	9.65	9.63	14.476	14.296	20.34	20.38
BW	1.4MHz		3MHz		5MHz		10MHz		15MHz		20MHz	
Mod.	64QAM		64QAM		64QAM		64QAM		64QAM		64QAM	
Lowest CH	1.2867		2.967		4.845		9.71		14.296		20.18	
Middle CH	1.2839		3.027		4.855		10.09		14.356		20.18	
Highest CH	1.2503		3.021		4.945		9.85		14.296		20.18	

Mode	LTE Band 5 : 26dB BW(MHz)											
	1.4MHz		3MHz		5MHz		10MHz		15MHz		20MHz	
BW	1.4MHz		3MHz		5MHz		10MHz		15MHz		20MHz	
Mod.	QPSK	16QAM	QPSK	16QAM	QPSK	16QAM	QPSK	16QAM	QPSK	16QAM	QPSK	16QAM
Lowest CH	1.2755	1.2755	3.003	2.973	4.925	4.975	9.73	9.79				
Middle CH	1.2699	1.2783	3.015	3.009	4.945	4.785	9.83	9.81				
Highest CH	1.2587	1.2699	2.973	2.955	4.915	4.895	9.71	9.79				
BW	1.4MHz		3MHz		5MHz		10MHz		15MHz		20MHz	
Mod.	64QAM		64QAM		64QAM		64QAM		64QAM		64QAM	
Lowest CH	1.2895		2.9491		4.975		9.81					
Middle CH	1.2783		3.015		4.975		9.97					
Highest CH	1.2755		2.985		4.985		9.93					



Mode	LTE Band 7 : 26dB BW(MHz)											
BW	1.4MHz		3MHz		5MHz		10MHz		15MHz		20MHz	
Mod.	QPSK	16QAM	QPSK	16QAM	QPSK	16QAM	QPSK	16QAM	QPSK	16QAM	QPSK	16QAM
Lowest CH					4.965	4.975	9.89	9.71	14.296	14.296	20.26	20.14
Middle CH					4.945	4.885	9.67	10.11	14.266	14.386	20.22	20.1
Highest CH					5.035	4.975	9.89	9.91	14.535	14.446	20.34	20.3
BW	1.4MHz		3MHz		5MHz		10MHz		15MHz		20MHz	
Mod.	64QAM		64QAM		64QAM		64QAM		64QAM		64QAM	
Lowest CH					4.925		9.81		14.176		20.10	
Middle CH					4.915		9.97		14.326		20.14	
Highest CH					4.955		9.89		14.416		20.14	

Mode	LTE Band 38 : 26dB BW(MHz)											
BW	1.4MHz		3MHz		5MHz		10MHz		15MHz		20MHz	
Mod.	QPSK	16QAM	QPSK	16QAM	QPSK	16QAM	QPSK	16QAM	QPSK	16QAM	QPSK	16QAM
Lowest CH					4.925	4.855	9.63	9.95	14.326	14.206	19.98	20.26
Middle CH					4.765	4.845	9.85	9.91	14.356	14.116	20.06	20.10
Highest CH					4.905	4.865	9.69	9.75	14.715	14.296	20.10	20.14
BW	1.4MHz		3MHz		5MHz		10MHz		15MHz		20MHz	
Mod.	64QAM		64QAM		64QAM		64QAM		64QAM		64QAM	
Lowest CH					4.785		9.67		14.266		20.22	
Middle CH					4.805		9.93		14.386		19.98	
Highest CH					4.925		9.71		14.266		19.98	