



FCC RF Test Report

APPLICANT : LENOVO (SHANGHAI) ELECTRONICS
TECHNOLOGY CO LTD.
EQUIPMENT : Lenovo Mobile Phone
BRAND NAME : Lenovo
MODEL NAME : Lenovo PB2-670Y
FCC ID : O57PB2670Y
STANDARD : 47 CFR Part 2, 22(H), 24(E), 27(L), 27(M), 27(H), 27(F)
CLASSIFICATION : PCS Licensed Transmitter Held to Ear (PCE)

The product was received on May 13, 2016 and completely tested on Jun. 22, 2016. We, SPORTON INTERNATIONAL (KUNSHAN) INC., would like to declare that the tested sample has been evaluated in accordance with the test procedures given in ANSI / TIA / EIA-603-D-2010 and the testing has shown the tested sample to be in compliance with the applicable technical standards.

The test results in this report apply exclusively to the tested model / sample. Without written approval of SPORTON INTERNATIONAL (KUNSHAN) INC., the test report shall not be reproduced except in full.

Prepared by: James Huang / Manager



Approved by: Jones Tsai / Manager

SPORTON INTERNATIONAL (KUNSHAN) INC.
No. 3-2, PingXiang Road, Kunshan, Jiangsu Province, P. R. China



TABLE OF CONTENTS

REVISION HISTORY..... 4
SUMMARY OF TEST RESULT 5
1 GENERAL DESCRIPTION 7
1.1 Applicant 7
1.2 Manufacturer 7
1.3 Product Feature of Equipment Under Test..... 7
1.4 Product Specification of Equipment Under Test..... 8
1.5 Modification of EUT 8
1.6 Maximum ERP/EIRP Power, Frequency Tolerance, and Emission Designator 9
1.7 Component List..... 10
1.8 Testing Location 11
1.9 Applicable Standards..... 11
2 TEST CONFIGURATION OF EQUIPMENT UNDER TEST 12
2.1 Test Mode 12
2.2 Connection Diagram of Test System 15
2.3 Support Unit used in test configuration and system 16
2.4 Measurement Results Explanation Example..... 16
2.5 Frequency List of Low/Middle/High Channels 17
3 CONDUCTED TEST ITEMS 20
3.1 Measuring Instruments 20
3.2 Test Setup 20
3.3 Test Result of Conducted Test 21
3.4 Conducted Output Power 21
3.5 Peak-to-Average Ratio 21
3.6 Occupied Bandwidth 22
3.7 Conducted Band Edge 23
3.8 Conducted Spurious Emission 26
3.9 Frequency Stability 27
4 RADIATED TEST ITEMS 28
4.1 Measuring Instruments 28
4.2 Test Setup 28
4.3 Test Result of Radiated Test 28
4.4 Effective Radiated Power and Effective Isotropic Radiated Power 29
4.5 Radiated Spurious Emission 31
5 LIST OF MEASURING EQUIPMENT 32
6 UNCERTAINTY OF EVALUATION 33



APPENDIX A. TEST RESULTS OF CONDUCTED TEST

APPENDIX B. TEST RESULTS OF RADIATED TEST

APPENDIX C. TEST SETUP PHOTOGRAPHS



SUMMARY OF TEST RESULT

Report Section	FCC Rule	IC Rule	Description	Limit	Result	Remark
3.4	§2.1046	RSS-Gen(6.12) RSS-130(4.4) RSS-132 (5.4) RSS-133 (6.4) RSS-139 (6.5) RSS-199 (4.4)	Conducted Output Power	Reporting Only	PASS	-
3.5	§24.232(d)	RSS-130(4.4) RSS-132 (5.4) RSS-133 (6.4) RSS-139 (6.5)	Peak-to-Average Ratio	<13 dB	PASS	-
3.6	§2.1049	RSS-GEN(6.6) RSS-132 (3.1) RSS-133 (3.1) RSS-130 (3.1) RSS-139 (3.1) RSS-199 (4.2)	Occupied Bandwidth	Reporting Only	PASS	-
3.7	§2.1051 §22.917(a) §24.238(a) §27.53(c)(2)(4) §27.53(g) §27.53(h)	RSS-132 (5.5) RSS-133 (6.5.1) RSS-130(4.6) RSS-139 (6.6)	Conducted Band Edge Measurement (Band 2) (Band 4) (Band 5) (Band 12) (Band 13) (Band 17)	< 43+10log10(P[Watts])	PASS	-
	§27.53(m)(4)	RSS-199 (4.6)	Conducted Band Edge Measurement	§27.53(m)(4)		



3.8	§2.1051 §22.917(a) §24.238(a) §27.53(c)(2) §27.53(g) §27.53(h)	RSS-132 (5.5) RSS-133 (6.5.1) RSS-130(4.6) RSS-139 (6.6)	Conducted Spurious Emission (Band 2) (Band 4) (Band 5) (Band 12) (Band 13) (Band 17)	$< 43+10\log_{10}(P[\text{Watts}])$	PASS	-
	§2.1051 §27.53(m)(4)	RSS-199 (4.6)	Conducted Spurious Emission (Band 7)	$< 55+10\log_{10}(P[\text{Watts}])$		
3.9	§2.1055 §22.355	RSS-GEN(6.11) RSS-132(5.3) RSS-133(6.3)	Frequency Stability Temperature & Voltage	< 2.5 ppm for Part 22H	PASS	-
	§2.1055 §24.235 §27.54	RSS-130(4.3) RSS-139 (6.4) RSS-199 (4.3)		Within Authorized Band		
4.4	§22.913(a)(2)	RSS-132(5.4) SRSP-503(5.1.3)	Effective Radiated Power (Band 5)	ERP < 7 Watt	PASS	-
	§27.50(b)(10) §27.50(c)(10)	N/A	Effective Radiated Power (Band 12) (Band 13) (Band 17)	ERP < 3 Watt		
	§24.232(c) §27.50(h)(2)	RSS-133 (6.4) SRSP-510(5.1.2) RSS-199 (4.4)	Equivalent Isotropic Radiated Power (Band 2) (Band 7)	EIRP < 2Watt		
	§27.50(d)(4)	RSS-139 (6.5) SRSP-513(5.1.2)	Equivalent Isotropic Radiated Power (Band 4)	EIRP < 1Watt		
4.5	§2.1053 §22.917(a) §24.238(a) §27.53(c)(2) §27.53(f) §27.53(g) §27.53(h)	RSS-132 (5.5) RSS-133 (6.5.1) RSS-130(4.6) RSS-139 (6.6)	Radiated Spurious Emission (Band 2) (Band 4) (Band 5) (Band 12) (Band 13) (Band 17)	$< 43+10\log_{10}(P[\text{Watts}])$	PASS	Under limit 13.76 dB at 7598.520 MHz
	§2.1053 §27.53(m)(4)	RSS-199 (4.6)	Radiated Spurious Emission (Band 7)	$< 55+10\log_{10}(P[\text{Watts}])$		



1 General Description

1.1 Applicant

LENOVO (SHANGHAI) ELECTRONICS TECHNOLOGY CO LTD.

NO 68 BUILDING 199 FENJU RD, CHINA (SHANGHAI) PILOT FREE TRADE ZONE, SHANGHAI, 200131 CHINA

1.2 Manufacturer

Lenovo PC HK Limited

23/F, Lincoln House, Taikoo Place 979 King's Road, Quarry Bay, Hong Kong

1.3 Product Feature of Equipment Under Test

Product Feature	
Equipment	Lenovo Mobile Phone
Brand Name	Lenovo
Model Name	Lenovo PB2-670Y
FCC ID	O57PB2670Y
EUT supports Radios application	GSM/GPRS/EGPRS/WCDMA/HSPA/HSPA+/DC-HSDPA/LTE WLAN2.4GHz 802.11b/g/n HT20/HT40 WLAN5GHz 802.11a/n HT20/HT40 WLAN5GHz 802.11ac VHT20/VHT40/VHT80 Bluetooth v3.0+EDR/Bluetooth v4.0 LE
IMEI Code	Conducted:860995030005763/860995030006969 Radiation: 860995030005961/860995030007165 ERP/EIRP: 860995030006332/860995030007538
HW Version	LenovoPad PB2_670Y
SW Version	PB2-670Y_160904
EUT Stage	Identical Prototype



1.4 Product Specification of Equipment Under Test

Standards-related Product Specification	
Tx Frequency	LTE Band 2 : 1850.7 MHz ~ 1909.3 MHz LTE Band 4 : 1710.7 MHz ~ 1754.3 MHz LTE Band 5 : 824.7 MHz ~ 848.3 MHz LTE Band 7 : 2502.5 MHz ~ 2567.5 MHz LTE Band 12 : 699.7 MHz ~ 715.3 MHz LTE Band 13 : 779.5 MHz ~ 784.5 MHz LTE Band 17 : 706.5 MHz ~ 713.5 MHz
Rx Frequency	LTE Band 2 : 1930.7 MHz ~ 1989.3 MHz LTE Band 4 : 2110.7 MHz ~ 2154.3 MHz LTE Band 5 : 869.7 MHz ~ 893.3 MHz LTE Band 7 : 2622.5MHz ~ 2687.5 MHz LTE Band 12 : 729.7 MHz ~ 745.3 MHz LTE Band 13 : 748.5 MHz ~ 753.5 MHz LTE Band 17 : 736.5 MHz ~ 743.5 MHz
Bandwidth	LTE Band 2 : 1.4MHz / 3MHz / 5MHz / 10MHz / 15MHz / 20MHz LTE Band 4 : 1.4MHz / 3MHz / 5MHz / 10MHz / 15MHz / 20MHz LTE Band 5 : 1.4MHz / 3MHz / 5MHz / 10MHz LTE Band 7 : 5MHz/ 10MHz / 15MHz / 20MHz LTE Band 12 : 1.4MHz / 3MHz / 5MHz / 10MHz LTE Band 13 : 5MHz / 10MHz LTE Band 17 : 5MHz / 10MHz
Maximum Output Power to Antenna	LTE Band 2 : 22.40 dBm LTE Band 4 : 23.21 dBm LTE Band 5 : 23.69 dBm LTE Band 7 : 23.35 dBm LTE Band 12 : 23.85 dBm LTE Band 13 : 23.45 dBm LTE Band 17 : 23.83 dBm
Type of Modulation	QPSK / 16QAM

1.5 Modification of EUT

No modifications are made to the EUT during all test items.



1.6 Maximum ERP/EIRP Power, Frequency Tolerance, and Emission Designator

LTE Band 2		QPSK		16QAM		
BW(MHz)	Emission Designator (99%OBW)	Frequency Tolerance (ppm)	Maximum EIRP(W)	Emission Designator (99%OBW)	Frequency Tolerance (ppm)	Maximum EIRP(W)
1.4	1M09G7D	-	0.1936	1M10W7D	-	0.1514
3	2M72G7D	-	0.1888	2M72W7D	-	0.1528
5	4M52G7D	-	0.1910	4M51W7D	-	0.1545
10	9M09G7D	0.0056	0.1919	9M05W7D	-	0.1545
15	13M5G7D	-	0.1932	13M6W7D	-	0.1556
20	18M4G7D	-	0.1936	18M5W7D	-	0.1560
LTE Band 4		QPSK		16QAM		
BW(MHz)	Emission Designator (99%OBW)	Frequency Tolerance (ppm)	Maximum EIRP(W)	Emission Designator (99%OBW)	Frequency Tolerance (ppm)	Maximum EIRP(W)
1.4	1M09G7D	-	0.4634	1M10W7D	-	0.3776
3	2M72G7D	-	0.4560	2M73W7D	-	0.3793
5	4M50G7D	-	0.4571	4M51W7D	-	0.3811
10	9M05G7D	0.0057	0.4581	9M05W7D	-	0.3819
15	13M6G7D	-	0.4603	13M5W7D	-	0.3837
20	18M5G7D	-	0.4667	18M5W7D	-	0.3873
LTE Band 5		QPSK		16QAM		
BW(MHz)	Emission Designator (99%OBW)	Frequency Tolerance (ppm)	Maximum ERP(W)	Emission Designator (99%OBW)	Frequency Tolerance (ppm)	Maximum ERP(W)
1.4	1M10G7D	-	0.0649	1M09W7D	-	0.0525
3	2M73G7D	-	0.0603	2M72W7D	-	0.0511
5	4M52G7D	-	0.0568	4M51W7D	-	0.0516
10	9M05G7D	0.0066	0.0505	9M09W7D	-	0.0481
LTE Band 7		QPSK		16QAM		
BW(MHz)	Emission Designator (99%OBW)	Frequency Tolerance (ppm)	Maximum EIRP(W)	Emission Designator (99%OBW)	Frequency Tolerance (ppm)	Maximum EIRP(W)
5	4M54G7D	-	0.1021	4M52W7D	-	0.0824
10	9M11G7D	0.0030	0.1216	9M03W7D	-	0.0871
15	13M5G7D	-	0.1337	13M6W7D	-	0.1091
20	18M5G7D	-	0.1337	18M6W7D	-	0.1109



LTE Band 12		QPSK			16QAM		
BW(MHz)	Emission Designator (99%OBW)	Frequency Tolerance (ppm)	Maximum ERP(W)	Emission Designator (99%OBW)	Frequency Tolerance (ppm)	Maximum ERP(W)	
1.4	1M10G7D	-	0.0528	1M09W7D	-	0.0459	
3	2M73G7D	-	0.0514	2M72W7D	-	0.0457	
5	4M52G7D	-	0.0530	4M52W7D	-	0.0452	
10	9M05G7D	0.0068	0.0541	9M07W7D	-	0.0421	
LTE Band 13		QPSK			16QAM		
BW(MHz)	Emission Designator (99%OBW)	Frequency Tolerance (ppm)	Maximum ERP(W)	Emission Designator (99%OBW)	Frequency Tolerance (ppm)	Maximum ERP(W)	
5	4M51G7D	-	0.0453	4M50W7D	-	0.0376	
10	9M07G7D	0.0086	0.0431	8M97W7D	-	0.0373	
LTE Band 17		QPSK			16QAM		
BW(MHz)	Emission Designator (99%OBW)	Frequency Tolerance (ppm)	Maximum ERP(W)	Emission Designator (99%OBW)	Frequency Tolerance (ppm)	Maximum ERP(W)	
5	4M52G7D	-	0.0516	4M51W7D	-	0.0437	
10	9M11G7D	0.0100	0.0502	9M03W7D	-	0.0429	

1.7 Component List

Note: there are two types of EUT, the details refer the following table. According to the difference, we evaluate it is not affect RF performance, so only choose sample 1 to perform RF test.

Component	Sample 1	Sample 2
LCM	Tianma TL064VVXP02-00IPS(Golden) TL064VVXP01-00IPS(Black)	Oflim MCF-065-2517-02 IPS(Golden) MCF-065-2517-01 IPS(Black)
Back_camera	Sunny Y13S03A-200	GuangBao 2-52-13147-00A
Battery	SUCD+ATL L16D1P32	XWD+Coslight L16D1P32



1.8 Testing Location

Test Site	SPORTON INTERNATIONAL (KUNSHAN) INC.	
Test Site Location	No. 3-2, PingXiang Road, Kunshan, Jiangsu Province, P. R. China TEL: +86-0512-5790-0158 FAX: +86-0512-5790-0958	
Test Site No.	Sporton Site No.	
	TH01-KS	

Test Site	SPORTON INTERNATIONAL (SHENZHEN) INC.	
Test Site Location	No. 3 Building, the third floor of south, Shahe River west, Fengzeyuan warehouse, Nanshan District, Shenzhen, Guangdong, P. R. China TEL: +86-755- 3320-2398	
Test Site No.	Sporton Site No.	FCC/IC Registration No.
	03CH02-SZ	566869/4086F

1.9 Applicable Standards

According to the specifications of the manufacturer, the EUT must comply with the requirements of the following standards:

- 47 CFR Part 2, 22(H), 24(E), 27(L), 27(M), 27(H), 27(F)
- ANSI / TIA / EIA-603-D-2010
- FCC KDB 971168 D01 Power Meas. License Digital Systems v02r02

Remark:

1. All test items were verified and recorded according to the standards and without any deviation during the test.
2. This EUT has also been tested and complied with the requirements of FCC Part 15, Subpart B, recorded in a separate test report.



2 Test Configuration of Equipment Under Test

2.1 Test Mode

Antenna port conducted and radiated test items listed below are performed according to KDB 971168 D01 Power Meas. License Digital Systems v02r02 with maximum output power.

Radiated measurements are performed by rotating the EUT in three different orthogonal test planes to find the maximum emission.

Test Items	Band	Bandwidth (MHz)						Modulation		RB #			Test Channel		
		1.4	3	5	10	15	20	QPSK	16QAM	1	Half	Full	L	M	H
Max. Output Power	2	✓	✓	✓	✓	✓	✓	✓	✓	✓	✓	✓	✓	✓	✓
	4	✓	✓	✓	✓	✓	✓	✓	✓	✓	✓	✓	✓	✓	✓
	5	✓	✓	✓	✓	-	-	✓	✓	✓	✓	✓	✓	✓	✓
	7	-	-	✓	✓	✓	✓	✓	✓	✓	✓	✓	✓	✓	✓
	12	✓	✓	✓	✓	-	-	✓	✓	✓	✓	✓	✓	✓	✓
	13	-	-	✓		-	-	✓	✓	✓	✓	✓	✓	✓	✓
		-	-		✓	-	-	✓	✓	✓	✓	✓		✓	
17	-	-	✓	✓	-	-	✓	✓	✓	✓	✓	✓	✓	✓	
Peak-to-Average Ratio	2						✓	✓	✓	✓		✓	✓	✓	
	4						✓	✓	✓	✓		✓	✓	✓	
	5				✓	-	-	✓	✓	✓		✓	✓	✓	
	7	-	-				✓	✓	✓	✓		✓	✓	✓	
	12				✓	-	-	✓	✓	✓		✓	✓	✓	
	13	-	-		✓	-	-	✓	✓	✓		✓		✓	
		-	-		✓	-	-	✓	✓	✓		✓		✓	
17	-	-		✓	-	-	✓	✓	✓		✓	✓	✓	✓	
26dB and 99% Bandwidth	2	✓	✓	✓	✓	✓	✓	✓	✓			✓	✓	✓	
	4	✓	✓	✓	✓	✓	✓	✓	✓			✓	✓	✓	
	5	✓	✓	✓	✓	-	-	✓	✓			✓	✓	✓	
	7	-	-	✓	✓	✓	✓	✓	✓			✓	✓	✓	
	12	✓	✓	✓	✓	-	-	✓	✓			✓	✓	✓	
	13	-	-	✓		-	-	✓	✓			✓	✓	✓	
		-	-		✓	-	-	✓	✓			✓		✓	
17	-	-	✓	✓	-	-	✓	✓			✓	✓	✓		
Conducted Band Edge	2	✓	✓	✓	✓	✓	✓	✓	✓	✓		✓		✓	
	4	✓	✓	✓	✓	✓	✓	✓	✓	✓		✓		✓	
	5	✓	✓	✓	✓	-	-	✓	✓	✓		✓		✓	



	7	-	-	✓	✓	✓	✓	✓	✓	✓		✓	✓		✓
	12	✓	✓	✓	✓	-	-	✓	✓	✓		✓	✓		✓
	13	-	-	✓		-	-	✓	✓	✓		✓	✓		✓
					✓			✓	✓	✓		✓		✓	
17	-	-	✓	✓	-	-	✓	✓	✓		✓	✓		✓	

Test Items	Band	Bandwidth (MHz)						Modulation		RB #			Test Channel		
		1.4	3	5	10	15	20	QPSK	16QAM	1	Half	Full	L	M	H
Conducted Spurious Emission	2	✓	✓	✓	✓	✓	✓	✓	✓	✓			✓	✓	✓
	4	✓	✓	✓	✓	✓	✓	✓	✓	✓			✓	✓	✓
	5	✓	✓	✓	✓	-	-	✓	✓	✓			✓	✓	✓
	7	-	-	✓	✓	✓	✓	✓	✓	✓			✓	✓	✓
	12	✓	✓	✓	✓	-	-	✓	✓	✓			✓	✓	✓
	13	-	-	✓		-	-	✓	✓	✓			✓	✓	✓
		-	-		✓	-	-	✓	✓	✓				✓	
17	-	-	✓	✓	-	-	✓	✓	✓			✓	✓	✓	
Frequency Stability	2				✓			✓				✓		✓	
	4				✓			✓				✓		✓	
	5				✓	-	-	✓				✓		✓	
	7	-	-		✓			✓				✓		✓	
	12				✓	-	-	✓				✓		✓	
	13	-	-		✓	-	-	✓				✓		✓	
	17	-	-		✓	-	-	✓				✓		✓	
E.R.P./E.I.R.P.	2	✓	✓	✓	✓	✓	✓	✓	✓	✓			✓	✓	✓
	4	✓	✓	✓	✓	✓	✓	✓	✓	✓			✓	✓	✓
	5	✓	✓	✓	✓	-	-	✓	✓	✓			✓	✓	✓
	7	-	-	✓	✓	✓	✓	✓	✓	✓			✓	✓	✓
	12	✓	✓	✓	✓	-	-	✓	✓	✓			✓	✓	✓
	13	-	-	✓		-	-	✓	✓	✓			✓	✓	✓
		-	-		✓	-	-	✓	✓	✓				✓	
17	-	-	✓	✓	-	-	✓	✓	✓			✓	✓	✓	
Radiated Spurious Emission	2	✓	✓	✓	✓	✓	✓	✓		✓			✓	✓	✓
	4	✓	✓	✓	✓	✓	✓	✓		✓			✓	✓	✓
	5	✓	✓	✓	✓	-	-	✓		✓			✓	✓	✓
	7	-	-	✓	✓	✓	✓	✓		✓			✓	✓	✓



	12	√	√	√	√	-	-	√		√			√	√	√
	13	-	-	√		-	-	√		√			√	√	√
		-	-		√	-	-	√		√				√	
17	-	-	√	√	-	-	√		√			√	√	√	
Note	<ol style="list-style-type: none"> 1. The mark “√ “ means that this configuration is chosen for testing 2. The mark “-“ means that this bandwidth is not supported. 3. The device is investigated from 30MHz to 10 times of fundamental signal for radiated spurious emission test under different RB size/offset and modulations in exploratory test. Subsequently, only the worst case emissions are reported. 														

2.2 Connection Diagram of Test System

LTE Band 2 / 5 / 7 / 12 / 13 / 17

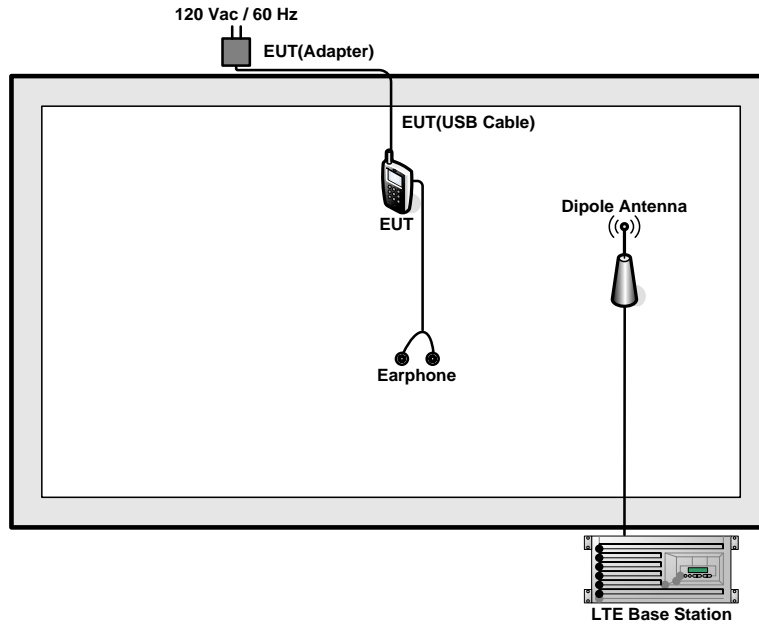

LTE Band 4

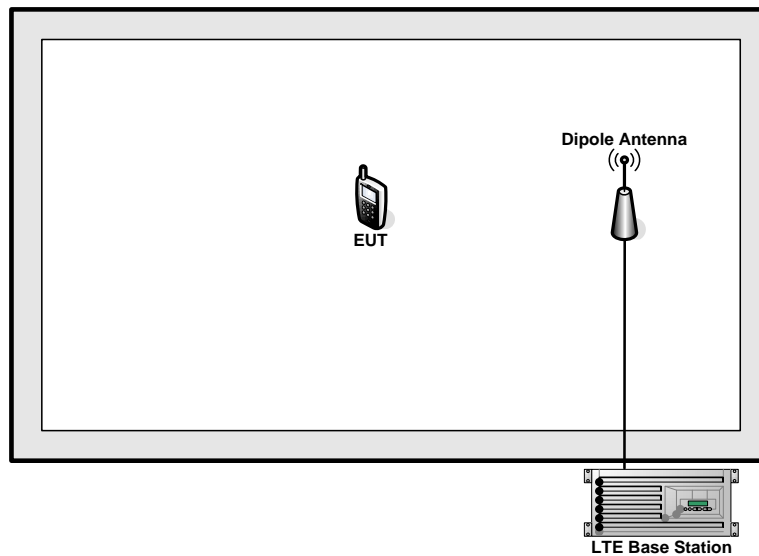



2.3 Support Unit used in test configuration and system

Item	Equipment	Trade Name	Model No.	FCC ID	Data Cable	Power Cord
1.	LTE Base Station	Anritsu	MT8820C	N/A	N/A	Unshielded, 1.8 m
2.	DC Power Supply	GW INSTRON	GPS-3030D	N/A	N/A	Unshielded, 1.8 m

2.4 Measurement Results Explanation Example

For all conducted test items:

The offset level is set in the spectrum analyzer to compensate the RF cable loss and attenuator factor between EUT conducted output port and spectrum analyzer. With the offset compensation, the spectrum analyzer reading level is exactly the EUT RF output level.

The spectrum analyzer offset is derived from RF cable loss.

Offset = RF cable loss.

Following shows an offset computation example with cable loss 4.8dB.

Example :

$$\begin{aligned} \text{Offset(dB)} &= \text{RF cable loss(dB)}. \\ &= 4.8 \text{ (dB)} \end{aligned}$$



2.5 Frequency List of Low/Middle/High Channels

LTE Band 2 Channel and Frequency List				
BW [MHz]	Channel/Frequency(MHz)	Lowest	Middle	Highest
20	Channel	18700	18900	19100
	Frequency	1860	1880	1900
15	Channel	18675	18900	19125
	Frequency	1857.5	1880	1902.5
10	Channel	18650	18900	19150
	Frequency	1855	1880	1905
5	Channel	18625	18900	19175
	Frequency	1852.5	1880	1907.5
3	Channel	18615	18900	19185
	Frequency	1851.5	1880	1908.5
1.4	Channel	18607	18900	19193
	Frequency	1850.7	1880	1909.3

LTE Band 4 Channel and Frequency List				
BW [MHz]	Channel/Frequency(MHz)	Lowest	Middle	Highest
20	Channel	20050	20175	20300
	Frequency	1720	1732.5	1745
15	Channel	20025	20175	20325
	Frequency	1717.5	1732.5	1747.5
10	Channel	20000	20175	20350
	Frequency	1715	1732.5	1750
5	Channel	19975	20175	20375
	Frequency	1712.5	1732.5	1752.5
3	Channel	19965	20175	20385
	Frequency	1711.5	1732.5	1753.5
1.4	Channel	19957	20175	20393
	Frequency	1710.7	1732.5	1754.3



LTE Band 5 Channel and Frequency List				
BW [MHz]	Channel/Frequency(MHz)	Lowest	Middle	Highest
10	Channel	20450	20525	20600
	Frequency	829	836.5	844
5	Channel	20425	20525	20625
	Frequency	826.5	836.5	846.5
3	Channel	20415	20525	20635
	Frequency	825.5	836.5	847.5
1.4	Channel	20407	20525	20643
	Frequency	824.7	836.5	848.3

LTE Band 7 Channel and Frequency List				
BW [MHz]	Channel/Frequency(MHz)	Lowest	Middle	Highest
20	Channel	20850	21100	21350
	Frequency	2510	2535	2560
15	Channel	20825	21100	21375
	Frequency	2507.5	2535	2562.5
10	Channel	20800	21100	21400
	Frequency	2505	2535	2565
5	Channel	20775	21100	21425
	Frequency	2502.5	2535	2567.5



LTE Band 12 Channel and Frequency List				
BW [MHz]	Channel/Frequency(MHz)	Lowest	Middle	Highest
10	Channel	23060	23095	23130
	Frequency	704	707.5	711
5	Channel	23035	23095	23155
	Frequency	701.5	707.5	713.5
3	Channel	23025	23095	23165
	Frequency	700.5	707.5	714.5
1.4	Channel	23017	23095	23173
	Frequency	699.7	707.5	715.3

LTE Band 13 Channel and Frequency List				
BW [MHz]	Channel/Frequency(MHz)	Lowest	Middle	Highest
10	Channel	-	23230	-
	Frequency	-	782	-
5	Channel	23205	23230	23255
	Frequency	779.5	782	784.5

LTE Band 17 Channel and Frequency List				
BW [MHz]	Channel/Frequency(MHz)	Lowest	Middle	Highest
10	Channel	23780	23790	23800
	Frequency	709	710	711
5	Channel	23755	23790	23825
	Frequency	706.5	710	713.5

3 Conducted Test Items

3.1 Measuring Instruments

See list of measuring instruments of this test report.

3.2 Test Setup

3.2.1 Conducted Output Power

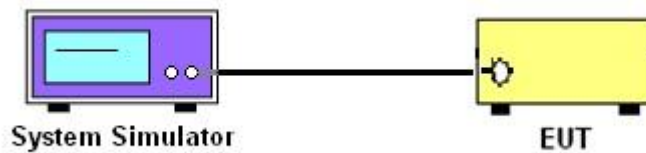

3.2.2 Peak-to-Average Ratio, Occupied Bandwidth ,Conducted Band-Edge and Conducted Spurious Emission

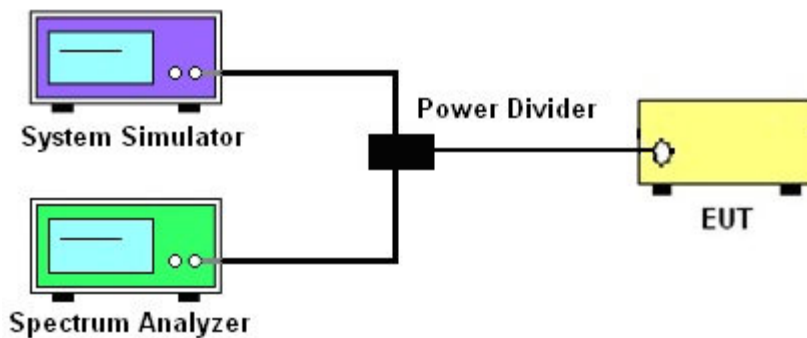

3.2.3 Frequency Stability

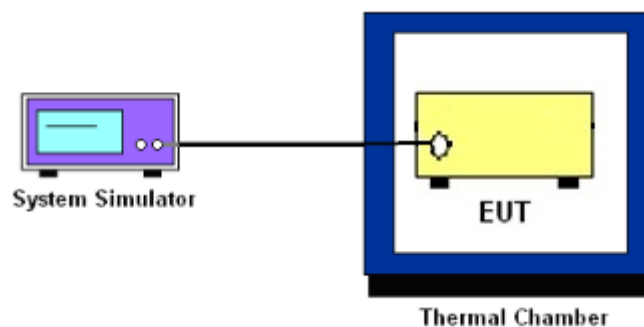



3.3 Test Result of Conducted Test

Please refer to Appendix A.

3.4 Conducted Output Power

3.4.1 Description of the Conducted Output Power Measurement

A system simulator was used to establish communication with the EUT. Its parameters were set to force the EUT transmitting at maximum output power. The measured power in the radio frequency on the transmitter output terminals shall be reported.

3.4.2 Test Procedures

1. The transmitter output port was connected to the system simulator.
2. Set EUT at maximum power through the system simulator.
3. Select lowest, middle, and highest channels for each band and different modulation.
4. Measure and record the power level from the system simulator.

3.5 Peak-to-Average Ratio

3.5.1 Description of the PAR Measurement

Power Complementary Cumulative Distribution Function (CCDF) curves provide a means for characterizing the power peaks of a digitally modulated signal on a statistical basis. A CCDF curve depicts the probability of the peak signal amplitude exceeding the average power level. Most contemporary measurement instrumentation include the capability to produce CCDF curves for an input signal provided that the instrument's resolution bandwidth can be set wide enough to accommodate the entire input signal bandwidth. In measuring transmissions in this band using an average power technique, the peak-to-average ratio (PAR) of the transmission may not exceed 13 dB.

3.5.2 Test Procedures

1. The testing follows FCC KDB 971168 v02r02 Section 5.7.1.
2. The EUT was connected to spectrum and system simulator via a power divider.
3. Set the CCDF (Complementary Cumulative Distribution Function) option in spectrum analyzer.
4. The highest RF powers were measured and recorded the maximum PAPR level associated with a probability of 0.1 %.
5. Record the deviation as Peak to Average Ratio.



3.6 Occupied Bandwidth

3.6.1 Description of Occupied Bandwidth Measurement

The occupied bandwidth is the width of a frequency band such that, below the lower and above the upper frequency limits, the mean powers emitted are each equal to a specified percentage 0.5% of the total mean transmitted power.

The 26 dB emission bandwidth is defined as the frequency range between two points, one above and one below the carrier frequency, at which the spectral density of the emission is attenuated 26 dB below the maximum in-band spectral density of the modulated signal. Spectral density (power per unit bandwidth) is to be measured with a detector of resolution bandwidth equal to approximately 1.0% of the emission bandwidth.

3.6.2 Test Procedures

1. The testing follows FCC KDB 971168 v02r02 Section 4.2.
2. The EUT was connected to spectrum analyzer and system simulator via a power divider.
3. The spectrum analyzer center frequency is set to the nominal EUT channel center frequency. The span range for the spectrum analyzer shall be between two and five times the anticipated OBW.
4. The nominal resolution bandwidth (RBW) shall be in the range of 1 to 5 % of the anticipated OBW, and the VBW shall be at least 3 times the RBW.
5. Set the detection mode to peak, and the trace mode to max hold.
6. Determine the reference value: Set the EUT to transmit a modulated signal. Allow the trace to stabilize. Set the spectrum analyzer marker to the highest level of the displayed trace.
(this is the reference value)
7. Determine the “-26 dB down amplitude” as equal to (Reference Value – X).
8. Place two markers, one at the lowest and the other at the highest frequency of the envelope of the spectral display such that each marker is at or slightly below the “-X dB down amplitude” determined in step 6. If a marker is below this “-X dB down amplitude” value it shall be placed as close as possible to this value. The OBW is the positive frequency difference between the two markers.
9. Use the 99 % power bandwidth function of the spectrum analyzer and report the measured bandwidth.



3.7 Conducted Band Edge

3.7.1 Description of Conducted Band Edge Measurement

22.917(a) and RSS – 132

For operations in the 824 – 849 MHz band, the FCC limit is $43 + 10\log_{10}(P[\text{Watts}])$ dB below the transmitter power $P(\text{Watts})$ in a 100kHz bandwidth. However, in the 1MHz bands immediately outside and adjacent to the licensee's frequency block, a resolution bandwidth of at least one percent of the emission bandwidth of the fundamental emission of the transmitter may be employed.

24.238 (a) and RSS – 133

For operations in the 1850-1910 and 1930-1990 MHz band, the FCC limit is $43 + 10\log_{10}(P[\text{Watts}])$ dB below the transmitter power $P(\text{Watts})$ in a 1MHz bandwidth. However, in the 1 MHz bands immediately outside and adjacent to the frequency block a resolution bandwidth of at least one percent of the emission bandwidth of the fundamental emission of the transmitter may be employed.

27.53 (c) and RSS – 130

For operations in the 776-788 MHz band, the FCC limit is $43 + 10\log_{10}(P[\text{Watts}])$ dB below the transmitter power $P(\text{Watts})$ in a 100 kHz bandwidth. However, in the 100 kHz bands immediately outside and adjacent to the frequency block, a resolution bandwidth of at least 30 kHz may be employed. In addition, the power of any unwanted emissions in any 6.25 kHz bandwidth for all frequencies between 763-775 MHz and 793-806 MHz shall be attenuated below the transmitter power, P (dBW), by at least $65 + 10 \log_{10} p(\text{watts})$, dB, for mobile and portable equipment.

27.53 (g) and RSS – 130

For operations in the 698 -746 MHz band, the FCC limit is $43 + 10\log_{10}(P[\text{Watts}])$ dB below the transmitter power $P(\text{Watts})$ in a 100 kHz bandwidth. However, in the 100 kilohertz bands immediately outside and adjacent to a licensee's frequency block, a resolution bandwidth of at least 30 kHz may be employed.

27.53 (h) and RSS – 139

For operations in the 1710 – 1755 MHz band, the FCC limit is $43 + 10\log_{10}(P[\text{Watts}])$ dB below the transmitter power $P(\text{Watts})$ in a 1 MHz bandwidth. However, in the 1MHz bands immediately outside and adjacent to the licensee's frequency block, a resolution bandwidth of at least one percent of the emission bandwidth of the fundamental emission of the transmitter may be employed.



27.53(m)(4)

For mobile digital stations, the attenuation factor shall be not less than $40 + 10 \log (P)$ dB on all frequencies between the channel edge and 5 megahertz from the channel edge, $43 + 10 \log (P)$ dB on all frequencies between 5 megahertz and X megahertz from the channel edge, and $55 + 10 \log (P)$ dB on all frequencies more than X megahertz from the channel edge, where X is the greater of 6 megahertz or the actual emission bandwidth as defined in paragraph (m)(6) of this section. In addition, the attenuation factor shall not be less that $43 + 10 \log (P)$ dB on all frequencies between 2490.5 MHz and 2496 MHz and $55 + 10 \log (P)$ dB at or below 2490.5 MHz. Mobile Satellite Service licensees operating on frequencies below 2495 MHz may also submit a documented interference complaint against BRS licensees operating on channel BRS Channel 1 on the same terms and conditions as adjacent channel BRS or EBS licensees.

3.7.2 Test Procedures

1. The testing follows FCC KDB 971168 v02r02 Section 6.0.
2. The EUT was connected to spectrum analyzer and system simulator via a power divider.
3. The band edges of low and high channels for the highest RF powers were measured.
4. Set RBW \geq 1% EBW in the 1MHz band immediately outside and adjacent to the band edge.
5. Beyond the 1 MHz band from the band edge, RBW=1MHz was used or a narrower RBW was used and the measured power was integrated over the full required measurement bandwidth of 1 MHz.
6. Set spectrum analyzer with RMS detector.
7. The RF fundamental frequency should be excluded against the limit line in the operating frequency band.
8. Checked that all the results comply with the emission limit line.

Example:

The limit line is derived from $43 + 10\log(P)$ dB below the transmitter power P(Watts)
= $P(W) - [43 + 10\log(P)]$ (dB)
= $[30 + 10\log(P)]$ (dBm) - $[43 + 10\log(P)]$ (dB) = -13dBm.

9. For LTE Band 7, the other 40 dB, and 55 dB have additionally applied same calculation above.

The limit line is derived from $40 + 10\log(P)$ dB below the transmitter power P(Watts)
= $P(W) - [40 + 10\log(P)]$ (dB)
= $[30 + 10\log(P)]$ (dBm) - $[40 + 10\log(P)]$ (dB)
= -10dBm

The limit line is derived from $43 + 10\log(P)$ dB below the transmitter power P(Watts)
= $P(W) - [43 + 10\log(P)]$ (dB)



$$\begin{aligned} &= [30 + 10\log(P)] \text{ (dBm)} - [43 + 10\log(P)] \text{ (dB)} \\ &= -13\text{dBm}. \end{aligned}$$

The limit line is derived from 55+ 10log(P)dB below the transmitter power P(Watts)

$$\begin{aligned} &= P(\text{W}) - [55 + 10\log(P)] \text{ (dB)} \\ &= [55 + 10\log(P)] \text{ (dBm)} - [55 + 10\log(P)] \text{ (dB)} \\ &= -25\text{dBm} \end{aligned}$$



3.8 Conducted Spurious Emission

3.8.1 Description of Conducted Spurious Emission Measurement

The power of any emission outside of the authorized operating frequency ranges must be lower than the transmitter power (P) by a factor of at least $43 + 10 \log (P)$ dB.

For Band 7:

The power of any emission outside of the authorized operating frequency ranges must be lower than the transmitter power (P) by a factor of at least $55 + 10 \log (P)$ dB.

It is measured by means of a calibrated spectrum analyzer and scanned from 30 MHz up to a frequency including its 10th harmonic.

3.8.2 Test Procedures

1. The testing follows FCC KDB 971168 v02r02 Section 6.0.
2. The EUT was connected to spectrum analyzer and system simulator via a power divider.
3. The RF output of EUT was connected to the spectrum analyzer by RF cable and attenuator. The path loss was compensated to the results for each measurement.
4. The middle channel for the highest RF power within the transmitting frequency was measured.
5. The conducted spurious emission for the whole frequency range was taken.
6. Make the measurement with the spectrum analyzer's RBW = 1MHz, VBW = 3MHz.
7. Set spectrum analyzer with RMS detector.
8. Taking the record of maximum spurious emission.
9. The RF fundamental frequency should be excluded against the limit line in the operating frequency band.
10. The limit line is derived from $43 + 10\log(P)$ dB below the transmitter power P(Watts)
= $P(W) - [43 + 10\log(P)]$ (dB)
= $[30 + 10\log(P)]$ (dBm) - $[43 + 10\log(P)]$ (dB)
= -13dBm.
11. For Band 7
The limit line is derived from $55 + 10\log(P)$ dB below the transmitter power P(Watts)
= $P(W) - [55 + 10\log(P)]$ (dB)
= $[30 + 10\log(P)]$ (dBm) - $[55 + 10\log(P)]$ (dB)
= -25dBm.



3.9 Frequency Stability

3.9.1 Description of Frequency Stability Measurement

The frequency stability shall be measured by variation of ambient temperature and variation of primary supply voltage to ensure that the fundamental emission stays within the authorized frequency block. The frequency stability of the transmitter shall be maintained within $\pm 0.00025\%$ ($\pm 2.5\text{ppm}$) of the center frequency.

3.9.2 Test Procedures for Temperature Variation

1. The testing follows FCC KDB 971168 v02r02 Section 9.0.
2. The EUT was set up in the thermal chamber and connected with the system simulator.
3. With power OFF, the temperature was decreased to -30°C and the EUT was stabilized before testing. Power was applied and the maximum change in frequency was recorded within one minute.
4. With power OFF, the temperature was raised in 10°C step up to 50°C . The EUT was stabilized at each step for at least half an hour. Power was applied and the maximum frequency change was recorded within one minute.

3.9.3 Test Procedures for Voltage Variation

1. The testing follows FCC KDB 971168 v02r02 Section 9.0.
2. The EUT was placed in a temperature chamber at $20\pm 5^{\circ}\text{C}$ and connected with the system simulator.
3. The power supply voltage to the EUT was varied from 85% to 115% of the nominal value measured at the input to the EUT.
4. The variation in frequency was measured for the worst case.

4 Radiated Test Items

4.1 Measuring Instruments

See list of measuring instruments of this test report.

4.2 Test Setup

4.2.1 For radiated test from 30MHz to 1GHz

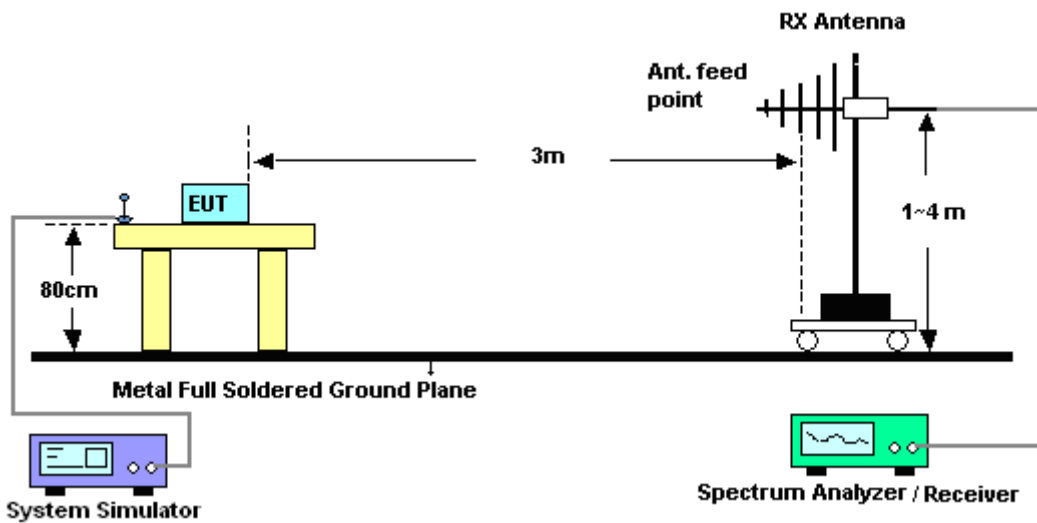

4.2.2 For radiated test above 1GHz

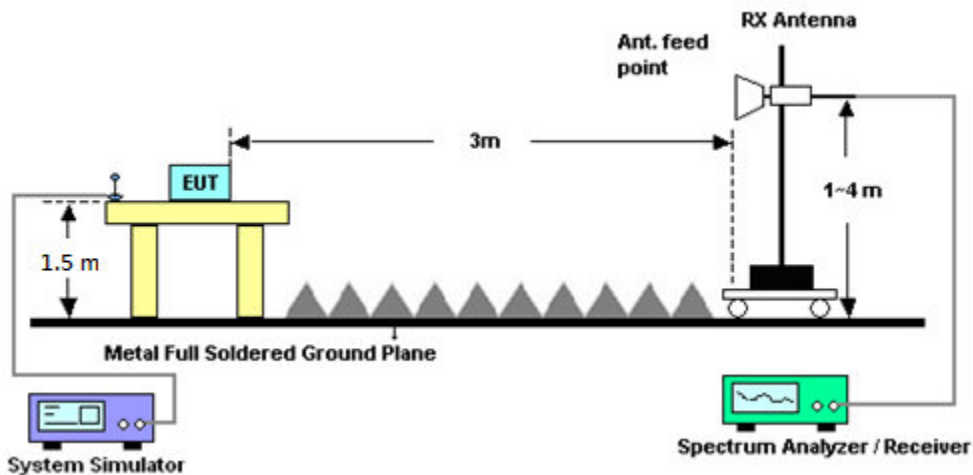

4.3 Test Result of Radiated Test

Please refer to Appendix B.



4.4 Effective Radiated Power and Effective Isotropic Radiated Power

4.4.1 Description of the ERP/EIRP Measurement

Effective radiated power output measurements by substitution method according to ANSI / TIA / EIA-603-D-2010, and the spectrum analyzer configuration follows KDB 971168 D01 Power Meas. License Digital Systems v02r02. Mobile and portable (hand-held) stations operating are limited to average ERP of 7 watts with LTE band 5 and 3 watts with LTE band 12 / 13 / 17.

Equivalent isotropic radiated power output measurements by substitution method according to ANSI / TIA / EIA-603-D-2010, and the spectrum analyzer configuration follows KDB 971168 D01 Power Meas. License Digital Systems v02r02. Mobile and portable (hand-held) stations operating are limited to average EIRP of 2 watts with LTE band 2 / 7 and 1 watt with LTE band 4.

4.4.2 Test Procedures

1. The EUT was placed on a non-conductive rotating platform (0.8 meters for frequency below 1GHz and 1.5 meter for frequency above 1GHz) in a semi-anechoic chamber. The radiated emission at the fundamental frequency was measured at 3 m with a test antenna and a spectrum analyzer with RMS detector per section 5. of KDB 971168 D01.
2. During the measurement, the system simulator parameters were set to force the EUT transmitting at maximum output power. The maximum emission was recorded from analyzer power level (LVL) from the 360 degrees rotation of the turntable and the test antenna raised and lowered over a range from 1 to 4 meters in both horizontally and vertically polarized orientations.
3. Effective Isotropic Radiated Power (EIRP) was measured by substitution method according to TIA/EIA-603-D. The EUT was replaced by the substitution antenna at same location, and then a known power from S.G. was applied into the dipole antenna through a Tx cable, and then recorded the maximum Analyzer reading through raised and lowered the test antenna. The correction factor (in dB) = S.G. - Tx Cable loss + Substitution antenna gain - Analyzer reading. Then the EUT's EIRP was calculated with the correction factor, $EIRP = LVL + \text{Correction factor}$ and $ERP = EIRP - 2.15$. Take the record of the output power at substitution antenna.



	LTE Average					
LTE BW	1.4M	3M	5M	10M	15M	20M
Span	3MHz	6MHz	10MHz	20MHz	30MHz	40MHz
RBW	30kHz	100kHz	100kHz	300kHz	300kHz	300kHz
VBW	100kHz	300kHz	300kHz	1MHz	1MHz	1MHz
Detector	RMS	RMS	RMS	RMS	RMS	RMS
Trace	Average	Average	Average	Average	Average	Average
Average Type	Power	Power	Power	Power	Power	Power
Sweep Count	100	100	100	100	100	100



4.5 Radiated Spurious Emission

4.5.1 Description of Radiated Spurious Emission

The radiated spurious emission was measured by substitution method according to ANSI / TIA / EIA-603-D-2010. The power of any emission outside of the authorized operating frequency ranges must be attenuated below the transmitter power (P) by a factor of at least $43 + 10 \log (P)$ dB.

For Band 7

The power of any emission outside of the authorized operating frequency ranges must be attenuated below the transmitter power (P) by a factor of at least $55 + 10 \log (P)$ dB.

For LTE Band 12,13,17

For operations in the 746-758 MHz, 775-788 MHz, and 805-806 MHz bands, emissions in the band 1559-1610 MHz shall be limited to -70 dBW/MHz equivalent isotropically radiated power (EIRP) for wideband signals, and -80 dBW EIRP for discrete emissions of less than 700 Hz bandwidth.

The spectrum is scanned from 30 MHz up to a frequency including its 10th harmonic.

4.5.2 Test Procedures

1. The testing follows FCC KDB 971168 v02r02 Section 5.8 and ANSI / TIA-603-D-2010 Section 2.2.12.
2. The EUT was placed on a turntable with 0.8 meter for frequency below 1GHz and 1.5 meter for frequency above 1GHz respectively above ground.
3. The EUT was set 3 meters from the receiving antenna, which was mounted on the antenna tower.
4. The table was rotated 360 degrees to determine the position of the highest spurious emission.
5. The height of the receiving antenna is varied between one meter and four meters to search the maximum spurious emission for both horizontal and vertical polarizations.
6. Make the measurement with the spectrum analyzer's RBW = 1MHz, VBW = 3MHz, taking the record of maximum spurious emission.
7. A horn antenna was substituted in place of the EUT and was driven by a signal generator.
8. Tune the output power of signal generator to the same emission level with EUT maximum spurious emission.
9. Taking the record of output power at antenna port.
10. Repeat step 7 to step 8 for another polarization.
11. The RF fundamental frequency should be excluded against the limit line in the operating frequency band.

The limit line is derived from $43 + 10\log(P)$ dB below the transmitter power P(Watts)

$$= P(W) - [43 + 10\log(P)] \text{ (dB)}$$

$$= [30 + 10\log(P)] \text{ (dBm)} - [43 + 10\log(P)] \text{ (dB)}$$

$$= -13\text{dBm.}$$

For Band 7 The limit line is derived from $55 + 10\log(P)$ dB below the transmitter power P(Watts)

$$12. \text{ EIRP (dBm)} = \text{S.G. Power} - \text{Tx Cable Loss} + \text{Tx Antenna Gain}$$

$$13. \text{ ERP (dBm)} = \text{EIRP} - 2.15$$



5 List of Measuring Equipment

Instrument	Manufacturer	Model No.	Serial No.	Characteristics	Calibration Date	Test Date	Due Date	Remark
Spectrum Analyzer	R&S	FSV40	101040	10Hz~40GHz	Sep. 10, 2015	Jun. 06, 2016~ Jun. 22, 2016	Sep. 09, 2016	Conducted (TH01-KS)
Thermal Chamber	Ten Billion	TTC-B3S	TBN-960502	-40~+150°C	Oct. 24, 2015	Jun. 06, 2016~ Jun. 22, 2016	Oct. 23, 2016	Conducted (TH01-KS)
Spectrum Analyzer	R&S	FSV40	101041	10kHz~40GHz;Ma x 30dBm	Oct. 20, 2015	Jun. 07, 2016~ Jun. 12, 2016	Oct. 19, 2016	Radiation (03CH02-SZ)
Bilog Antenna	TeseQ	CBL6112D	35407	30MHz~2GHz	May 21, 2016	Jun. 07, 2016~ Jun. 12, 2016	May 20, 2017	Radiation (03CH02-SZ)
Double Ridge Horn Antenna	SCHWARZBECK	BBHA 9120D	9120D-1285	1GHz~18GHz	Jan. 11, 2016	Jun. 07, 2016~ Jun. 12, 2016	Jan. 10, 2017	Radiation (03CH02-SZ)
SHF-EHF Horn	com-power	AH-840	101071	18GHz~40GHz	Aug. 17, 2015	Jun. 07, 2016~ Jun. 12, 2016	Aug. 16, 2016	Radiation (03CH02-SZ)
Amplifier	HP	8447F	3113A04622	9kHz~1300MHz / 30 dB	Aug. 07, 2015	Jun. 07, 2016~ Jun. 12, 2016	Aug. 06, 2016	Radiation (03CH02-SZ)
Amplifier	Agilent	8449B	3008A01023	1GHz~26.5GHz	Oct. 20, 2015	Jun. 07, 2016~ Jun. 12, 2016	Oct. 19, 2016	Radiation (03CH02-SZ)
AC Power Source	Chroma	61601	616010002470	N/A	NCR	Jun. 07, 2016~ Jun. 12, 2016	NCR	Radiation (03CH02-SZ)
Turn Table	Chaintek	T-200	N/A	0~360 degree	NCR	Jun. 07, 2016~ Jun. 12, 2016	NCR	Radiation (03CH02-SZ)
Antenna Mast	Chaintek	MBS-400	N/A	1 m~4 m	NCR	Jun. 07, 2016~ Jun. 12, 2016	NCR	Radiation (03CH02-SZ)

NCR: No Calibration Required



6 Uncertainty of Evaluation

Uncertainty of Radiated Emission Measurement (30 MHz ~ 1000 MHz)

Measuring Uncertainty for a Level of Confidence of 95% ($U = 2Uc(y)$)	5.0dB
-------------------------------------------------------------------------	-------

Uncertainty of Radiated Emission Measurement (1GHz ~ 18GHz)

Measuring Uncertainty for a Level of Confidence of 95% ($U = 2Uc(y)$)	4.9dB
-------------------------------------------------------------------------	-------

Uncertainty of Radiated Emission Measurement (18GHz ~ 40GHz)

Measuring Uncertainty for a Level of Confidence of 95% ($U = 2Uc(y)$)	5.1dB
-------------------------------------------------------------------------	-------



Appendix A. Test Results of Conducted Test

Conducted Output Power(Average power)

LTE Band 2 Maximum Average Power [dBm]						
BW [MHz]	RB Size	RB Offset	Mod	Lowest	Middle	Highest
20	1	0	QPSK	22.27	22.33	22.40
20	1	49		22.18	22.20	22.29
20	1	99		22.06	22.05	22.19
20	50	0		21.30	21.35	21.41
20	50	24		21.27	21.26	21.29
20	50	50		21.22	21.21	21.32
20	100	0		21.23	21.27	21.35
20	1	0	16-QAM	21.44	21.06	21.43
20	1	49		21.39	21.03	21.05
20	1	99		21.32	21.39	21.45
20	50	0		20.28	20.38	20.46
20	50	24		20.26	20.30	20.40
20	50	50		20.22	20.28	20.33
20	100	0		20.23	20.31	20.38
15	1	0	QPSK	22.26	22.33	22.36
15	1	37		22.20	22.23	22.26
15	1	74		22.12	22.10	22.20
15	36	0		21.31	21.37	21.41
15	36	20		21.30	21.33	21.37
15	36	39		21.27	21.28	21.36
15	75	0		21.29	21.30	21.35
15	1	0	16-QAM	21.43	21.06	21.06
15	1	37		21.40	21.36	21.45
15	1	74		21.38	21.42	21.43
15	36	0		20.30	20.43	20.47
15	36	20		20.29	20.37	20.43
15	36	39		20.27	20.33	20.41
15	75	0		20.28	20.34	20.41



LTE Band 2 Maximum Average Power [dBm]						
BW [MHz]	RB Size	RB Offset	Mod	Lowest	Middle	Highest
10	1	0	QPSK	22.26	22.25	22.33
10	1	25		22.24	22.25	22.31
10	1	49		22.16	22.13	22.23
10	25	0		21.33	21.31	21.36
10	25	12		21.29	21.28	21.37
10	25	25		21.30	21.26	21.34
10	50	0		21.33	21.31	21.40
10	1	0	16-QAM	21.41	21.08	21.05
10	1	25		21.46	21.09	21.06
10	1	49		21.39	21.47	21.42
10	25	0		20.31	20.34	20.42
10	25	12		20.28	20.31	20.40
10	25	25		20.28	20.30	20.38
10	50	0		20.32	20.35	20.42
5	1	0	QPSK	22.27	22.23	22.14
5	1	12		22.32	22.23	21.94
5	1	24		22.22	22.13	21.85
5	12	0		21.37	21.35	21.03
5	12	7		21.35	21.32	21.03
5	12	13		21.34	21.31	21.03
5	25	0		21.31	21.29	20.99
5	1	0	16-QAM	21.44	21.36	21.20
5	1	12		21.46	21.39	21.17
5	1	24		21.37	21.44	21.07
5	12	0		20.34	20.40	20.10
5	12	7		20.33	20.38	20.09
5	12	13		20.32	20.36	20.09
5	25	0		20.28	20.32	20.04



LTE Band 2 Maximum Average Power [dBm]						
BW [MHz]	RB Size	RB Offset	Mod	Lowest	Middle	Highest
3	1	0	QPSK	22.26	22.15	21.85
3	1	8		22.31	22.22	21.87
3	1	14		22.24	22.13	21.82
3	8	0		21.39	21.31	20.97
3	8	4		21.38	21.30	21.00
3	8	7		21.37	21.29	20.97
3	15	0		21.40	21.30	21.01
3	1	0	16-QAM	21.46	21.47	21.15
3	1	8		21.50	21.25	21.16
3	1	14		21.39	21.43	21.11
3	8	0		20.44	20.39	20.08
3	8	4		20.44	20.39	20.05
3	8	7		20.44	20.38	20.09
3	15	0		20.41	20.34	20.03
1.4	1	0	QPSK	22.30	22.21	21.86
1.4	1	3		22.34	22.27	21.96
1.4	1	5		22.30	22.12	21.86
1.4	3	0		22.39	22.30	21.98
1.4	3	1		22.38	22.24	21.92
1.4	3	3		22.31	22.24	21.93
1.4	6	0		21.38	21.30	21.00
1.4	1	0	16-QAM	21.47	21.49	21.13
1.4	1	3		21.39	21.36	21.21
1.4	1	5		21.50	21.46	21.12
1.4	3	0		21.34	21.37	20.98
1.4	3	1		21.30	21.29	20.94
1.4	3	3		21.28	21.29	20.91
1.4	6	0		20.44	20.43	20.10



LTE Band 4 Maximum Average Power [dBm]						
BW [MHz]	RB Size	RB Offset	Mod	Lowest	Middle	Highest
20	1	0	QPSK	23.09	22.92	23.21
20	1	49		22.91	22.74	22.93
20	1	99		22.71	22.73	22.96
20	50	0		22.09	21.91	22.15
20	50	24		22.01	21.84	22.05
20	50	50		21.89	21.81	22.12
20	100	0		21.96	21.84	22.01
20	1	0	16-QAM	22.31	22.13	22.15
20	1	49		22.13	21.95	22.23
20	1	99		21.91	21.99	22.33
20	50	0		21.10	20.92	21.00
20	50	24		21.00	20.83	21.07
20	50	50		20.90	20.82	21.15
20	100	0		20.96	20.85	21.04
15	1	0	QPSK	23.01	22.86	22.85
15	1	37		22.93	22.75	23.01
15	1	74		22.73	22.72	23.11
15	36	0		22.05	21.90	22.02
15	36	20		22.01	21.84	22.09
15	36	39		21.96	21.83	22.16
15	75	0		21.98	21.86	22.10
15	1	0	16-QAM	22.28	22.08	22.12
15	1	37		22.18	21.99	22.29
15	1	74		21.97	22.00	22.28
15	36	0		21.07	20.89	21.05
15	36	20		21.04	20.84	21.14
15	36	39		20.95	20.83	21.18
15	75	0		21.01	20.85	21.12



LTE Band 4 Maximum Average Power [dBm]						
BW [MHz]	RB Size	RB Offset	Mod	Lowest	Middle	Highest
10	1	0	QPSK	23.00	22.81	22.98
10	1	25		22.97	22.73	23.08
10	1	49		22.87	22.67	23.11
10	25	0		22.03	21.82	22.09
10	25	12		21.97	21.78	22.12
10	25	25		21.95	21.78	22.16
10	50	0		22.03	21.82	22.18
10	1	0	16-QAM	22.25	22.00	22.26
10	1	25		22.22	21.95	22.33
10	1	49		22.09	21.93	22.29
10	25	0		21.07	20.81	21.15
10	25	12		21.01	20.80	21.17
10	25	25		20.99	20.79	21.20
10	50	0		21.04	20.84	21.21
5	1	0	QPSK	22.96	22.72	23.06
5	1	12		22.96	22.73	23.14
5	1	24		22.85	22.63	23.09
5	12	0		22.04	21.83	22.18
5	12	7		22.00	21.79	22.22
5	12	13		22.00	21.79	22.22
5	25	0		21.97	21.78	22.17
5	1	0	16-QAM	22.19	21.95	22.33
5	1	12		22.20	21.96	22.38
5	1	24		22.10	21.89	22.28
5	12	0		21.08	20.83	21.24
5	12	7		21.05	20.81	21.27
5	12	13		21.05	20.82	21.26
5	25	0		21.01	20.78	21.21



LTE Band 4 Maximum Average Power [dBm]						
BW [MHz]	RB Size	RB Offset	Mod	Lowest	Middle	Highest
3	1	0	QPSK	22.89	22.68	23.09
3	1	8		22.94	22.72	23.14
3	1	14		22.84	22.61	23.08
3	8	0		22.03	21.81	22.22
3	8	4		21.99	21.79	22.24
3	8	7		22.00	21.80	22.24
3	15	0		22.02	21.82	22.29
3	1	0	16-QAM	22.16	21.95	22.32
3	1	8		22.23	21.94	22.39
3	1	14		22.10	21.94	22.31
3	8	0		21.11	20.87	21.32
3	8	4		21.07	20.83	21.32
3	8	7		21.10	20.86	21.31
3	15	0		21.07	20.82	21.30
1.4	1	0	QPSK	22.90	22.71	23.09
1.4	1	3		22.99	22.76	23.05
1.4	1	5		22.88	22.69	23.09
1.4	3	0		23.00	22.79	23.11
1.4	3	1		22.97	22.72	23.01
1.4	3	3		22.96	22.71	23.03
1.4	6	0		21.99	21.83	22.30
1.4	1	0	16-QAM	22.18	21.99	22.33
1.4	1	3		22.28	22.07	22.48
1.4	1	5		22.17	21.97	22.32
1.4	3	0		21.98	21.79	22.20
1.4	3	1		21.97	21.70	22.16
1.4	3	3		21.95	21.70	22.16
1.4	6	0		21.10	20.88	21.33



LTE Band 5 Maximum Average Power [dBm]						
BW [MHz]	RB Size	RB Offset	Mod	Lowest	Middle	Highest
10	1	0	QPSK	23.65	23.48	23.69
10	1	25		23.62	23.39	23.65
10	1	49		23.42	23.40	23.56
10	25	0		22.73	22.52	22.85
10	25	12		22.69	22.47	22.72
10	25	25		22.63	22.48	22.65
10	50	0		22.70	22.53	22.73
10	1	0	16-QAM	22.88	22.77	22.72
10	1	25		22.90	22.69	22.92
10	1	49		22.76	22.69	22.39
10	25	0		21.73	21.54	21.61
10	25	12		21.70	21.49	21.72
10	25	25		21.64	21.49	21.91
10	50	0		21.69	21.53	21.77
5	1	0	QPSK	23.32	23.44	23.52
5	1	12		23.51	23.40	23.14
5	1	24		23.41	23.36	23.51
5	12	0		22.77	22.55	22.85
5	12	7		22.76	22.50	22.94
5	12	13		22.76	22.50	22.99
5	25	0		22.74	22.46	22.87
5	1	0	16-QAM	22.86	22.73	22.93
5	1	12		22.88	22.68	22.96
5	1	24		22.83	22.64	22.95
5	12	0		21.77	21.57	21.90
5	12	7		21.76	21.52	22.00
5	12	13		21.77	21.50	21.93
5	25	0		21.72	21.48	21.92



LTE Band 5 Maximum Average Power [dBm]						
BW [MHz]	RB Size	RB Offset	Mod	Lowest	Middle	Highest
3	1	0	QPSK	23.41	23.31	23.51
3	1	8		23.61	23.34	23.51
3	1	14		23.52	23.28	23.51
3	8	0		22.73	22.46	22.92
3	8	4		22.73	22.44	22.96
3	8	7		22.70	22.45	22.97
3	15	0		22.74	22.47	22.94
3	1	0	16-QAM	22.80	22.63	22.96
3	1	8		22.85	22.66	22.95
3	1	14		22.78	22.56	22.93
3	8	0		21.76	21.53	21.92
3	8	4		21.76	21.51	21.96
3	8	7		21.74	21.53	21.62
3	15	0		21.72	21.49	21.35
1.4	1	0	QPSK	23.61	23.31	23.51
1.4	1	3		23.51	23.41	23.61
1.4	1	5		23.59	23.32	23.52
1.4	3	0		23.51	23.42	23.61
1.4	3	1		23.52	23.37	23.52
1.4	3	3		23.66	23.37	23.14
1.4	6	0		22.75	22.45	22.98
1.4	1	0	16-QAM	22.81	22.63	22.96
1.4	1	3		22.91	22.74	22.95
1.4	1	5		22.81	22.63	22.00
1.4	3	0		22.71	22.48	22.63
1.4	3	1		22.67	22.44	22.94
1.4	3	3		22.66	22.42	22.94
1.4	6	0		21.80	21.53	21.96



LTE Band 7 Maximum Average Power [dBm]						
BW [MHz]	RB Size	RB Offset	Mod	Lowest	Middle	Highest
20	1	0	QPSK	22.70	23.26	23.19
20	1	49		22.86	23.29	23.12
20	1	99		23.05	23.35	23.21
20	50	0		21.93	22.42	22.23
20	50	24		22.00	22.42	22.21
20	50	50		22.10	22.45	22.36
20	100	0		21.99	22.39	22.19
20	1	0	16-QAM	21.98	22.48	22.42
20	1	49		21.40	22.23	22.33
20	1	99		22.29	22.31	22.35
20	50	0		20.92	21.40	21.25
20	50	24		20.98	21.37	21.21
20	50	50		21.07	21.42	21.23
20	100	0		20.96	21.36	21.20
15	1	0	QPSK	22.73	23.26	23.15
15	1	37		22.83	23.27	23.09
15	1	74		22.98	23.32	23.13
15	36	0		21.89	22.41	22.18
15	36	20		21.95	22.43	22.16
15	36	39		22.02	22.42	22.18
15	75	0		21.94	22.40	22.14
15	1	0	16-QAM	21.89	22.48	22.26
15	1	37		22.02	22.49	22.24
15	1	74		22.17	22.14	22.28
15	36	0		20.86	21.40	21.21
15	36	20		20.92	21.42	21.16
15	36	39		20.96	21.42	21.22
15	75	0		20.92	21.40	21.20



LTE Band 7 Maximum Average Power [dBm]						
BW [MHz]	RB Size	RB Offset	Mod	Lowest	Middle	Highest
10	1	0	QPSK	22.70	23.21	23.03
10	1	25		22.75	23.23	23.06
10	1	49		22.82	23.20	23.09
10	25	0		21.80	22.32	22.08
10	25	12		21.82	22.33	22.11
10	25	25		21.88	22.33	22.14
10	50	0		21.88	22.36	22.15
10	1	0	16-QAM	21.88	22.44	22.20
10	1	25		22.31	22.31	22.22
10	1	49		22.05	22.46	22.23
10	25	0		20.79	21.32	21.12
10	25	12		20.81	21.32	21.15
10	25	25		20.86	21.37	21.19
10	50	0		20.84	21.36	21.18
5	1	0	QPSK	22.67	23.24	23.03
5	1	12		22.73	23.21	23.10
5	1	24		22.67	23.18	23.06
5	12	0		21.78	22.35	22.15
5	12	7		21.79	22.35	22.16
5	12	13		21.81	22.34	22.17
5	25	0		21.77	22.29	22.11
5	1	0	16-QAM	21.89	22.49	22.22
5	1	12		21.97	22.50	22.28
5	1	24		21.93	22.47	22.21
5	12	0		20.81	21.36	21.21
5	12	7		20.79	21.39	21.22
5	12	13		20.81	21.36	21.21
5	25	0		20.75	21.27	21.16



LTE Band 12 Maximum Average Power [dBm]						
BW [MHz]	RB Size	RB Offset	Mod	Lowest	Middle	Highest
10	1	0	QPSK	23.81	23.75	23.79
10	1	25		23.85	23.83	23.80
10	1	49		23.84	23.79	23.76
10	25	0		22.89	22.87	22.88
10	25	12		22.92	22.91	22.81
10	25	25		22.94	22.93	22.91
10	50	0		22.96	22.94	22.93
10	1	0	16-QAM	22.89	22.95	22.95
10	1	25		22.97	22.95	22.98
10	1	49		22.96	22.94	22.91
10	25	0		21.84	21.86	21.88
10	25	12		21.86	21.92	21.88
10	25	25		21.94	21.93	21.89
10	50	0		21.93	21.94	21.91
5	1	0	QPSK	23.68	23.77	23.76
5	1	12		23.61	23.51	23.63
5	1	24		23.73	23.76	23.66
5	12	0		22.82	22.91	22.84
5	12	7		22.88	22.92	22.84
5	12	13		22.89	22.93	22.87
5	25	0		22.84	22.88	22.82
5	1	0	16-QAM	22.91	22.98	22.94
5	1	12		22.91	22.96	22.97
5	1	24		22.93	22.98	22.79
5	12	0		21.84	21.93	21.85
5	12	7		21.88	21.96	21.84
5	12	13		21.91	21.96	21.87
5	25	0		21.83	21.89	21.81



LTE Band 12 Maximum Average Power [dBm]						
BW [MHz]	RB Size	RB Offset	Mod	Lowest	Middle	Highest
3	1	0	QPSK	23.62	23.73	23.67
3	1	8		23.73	23.62	23.76
3	1	14		23.70	23.74	23.58
3	8	0		22.79	22.86	22.81
3	8	4		22.82	22.88	22.81
3	8	7		22.84	22.88	22.79
3	15	0		22.83	22.90	22.83
3	1	0	16-QAM	22.79	22.89	22.82
3	1	8		22.91	22.97	22.86
3	1	14		22.85	22.91	22.71
3	8	0		21.86	21.94	21.85
3	8	4		21.86	21.95	21.84
3	8	7		21.89	21.97	21.81
3	15	0		21.84	21.92	21.82
1.4	1	0	QPSK	23.63	23.75	23.70
1.4	1	3		23.76	23.63	23.76
1.4	1	5		23.68	23.76	23.62
1.4	3	0		23.78	23.61	23.61
1.4	3	1		23.73	23.51	23.73
1.4	3	3		23.72	23.41	23.73
1.4	6	0		22.79	22.89	22.80
1.4	1	0	16-QAM	22.82	22.97	22.81
1.4	1	3		22.95	22.96	22.87
1.4	1	5		22.88	22.91	22.71
1.4	3	0		22.74	22.85	22.72
1.4	3	1		22.69	22.79	22.65
1.4	3	3		22.68	22.79	22.64
1.4	6	0		21.85	21.98	21.83



LTE Band 13 Maximum Average Power [dBm]							
BW [MHz]	RB Size	RB Offset	Mod	Lowest	Middle	Highest	
10	1	0	QPSK		23.34		
10	1	25				23.45	
10	1	49				23.30	
10	25	0				22.48	
10	25	12				22.45	
10	25	25				22.47	
10	50	0				22.51	
10	1	0		16-QAM		22.36	
10	1	25				22.85	
10	1	49				22.59	
10	25	0				21.51	
10	25	12				21.51	
10	25	25				21.49	
10	50	0				21.53	
5	1	0	QPSK		23.32	23.33	23.32
5	1	12			23.32	23.21	23.21
5	1	24			23.31	23.32	23.26
5	12	0			22.42	22.52	22.51
5	12	7			22.48	22.54	22.49
5	12	13			22.50	22.53	22.48
5	25	0			22.47	22.45	22.46
5	1	0			22.28	22.54	22.79
5	1	12			22.59	22.81	22.65
5	1	24			22.76	22.62	22.53
5	12	0	16-QAM	21.42	21.62	21.56	
5	12	7			21.51	21.64	21.49
5	12	13			21.58	21.59	21.50
5	25	0			21.48	21.53	21.48



LTE Band 17 Maximum Average Power [dBm]						
BW [MHz]	RB Size	RB Offset	Mod	Lowest	Middle	Highest
10	1	0	QPSK	23.71	23.75	23.76
10	1	25		23.82	23.81	23.83
10	1	49		23.80	23.79	23.82
10	25	0		22.85	22.87	22.89
10	25	12		22.90	22.91	22.93
10	25	25		22.94	22.92	22.96
10	50	0		22.97	22.92	22.99
10	1	0	16-QAM	22.92	22.91	22.93
10	1	25		22.94	22.91	22.96
10	1	49		22.96	22.93	22.97
10	25	0		21.88	21.92	21.93
10	25	12		21.93	21.94	21.94
10	25	25		21.97	21.93	21.92
10	50	0		21.95	21.93	21.92
5	1	0	QPSK	23.75	23.76	23.51
5	1	12		23.63	23.51	23.63
5	1	24		23.61	23.52	23.68
5	12	0		22.87	22.94	22.89
5	12	7		22.90	22.95	22.87
5	12	13		22.92	22.96	22.86
5	25	0		22.87	22.90	22.85
5	1	0	16-QAM	22.94	22.96	22.91
5	1	12		22.94	22.98	22.96
5	1	24		22.95	22.96	22.83
5	12	0		21.89	21.98	21.92
5	12	7		21.95	21.99	21.90
5	12	13		21.99	21.99	21.88
5	25	0		21.90	21.93	21.85



LTE Band 2

Peak-to-Average Ratio

Mode	LTE Band 2 / 20MHz				
Mod.	QPSK		16QAM		Limit: 13dB
RB Size	1RB	Full RB	1RB	Full RB	Result
Lowest CH	3.91	5.04	4.90	5.86	PASS
Middle CH	4.09	5.36	4.99	6.17	
Highest CH	4.55	5.39	5.94	6.35	



LTE Band 2 / 20MHz / QPSK

Lowest Channel / 1RB

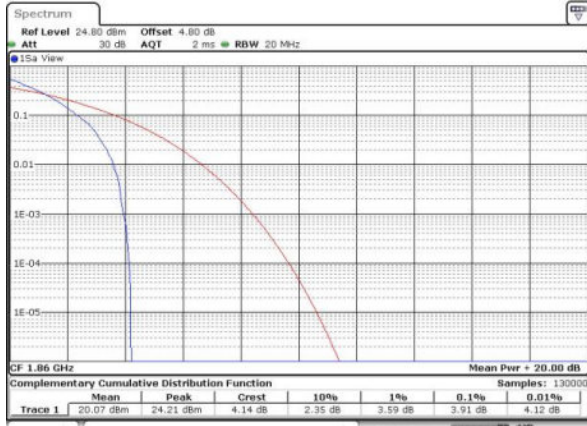

Date: 6 JUN 2016 23:58:42

Lowest Channel / Full RB

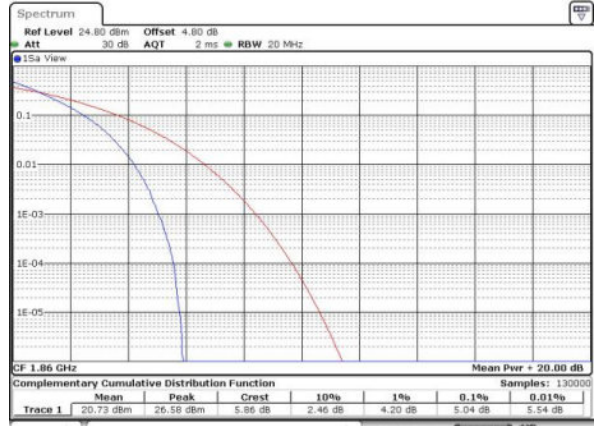

Date: 6 JUN 2016 23:58:52

Middle Channel / 1RB

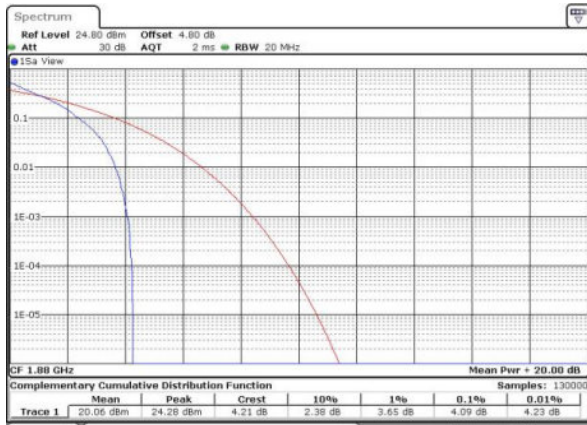

Date: 6 JUN 2016 23:59:03

Middle Channel / Full RB

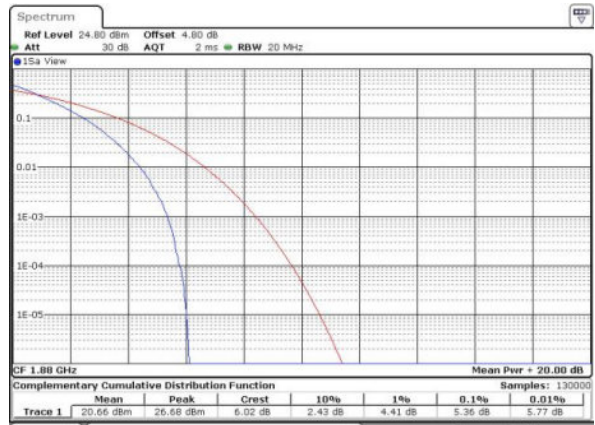

Date: 7 JUN 2016 00:16:03

Highest Channel / 1RB

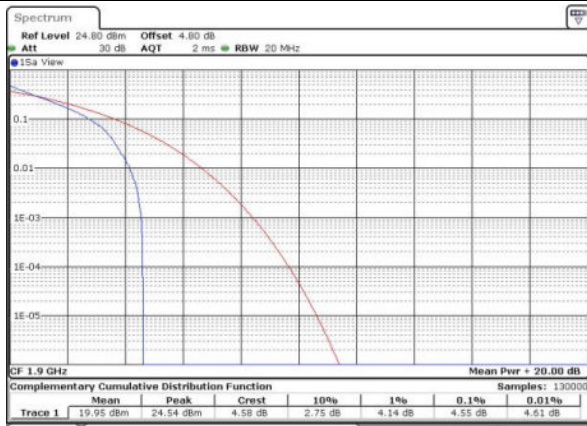

Date: 6 JUN 2016 23:59:25

Highest Channel / Full RB

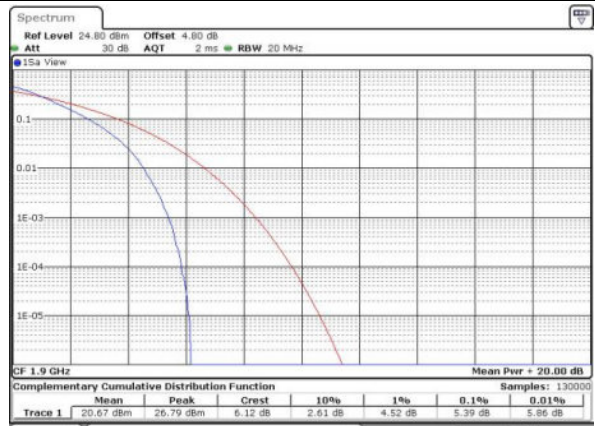

Date: 6 JUN 2016 23:59:35



LTE Band 2 / 20MHz / 16QAM

Lowest Channel / 1RB

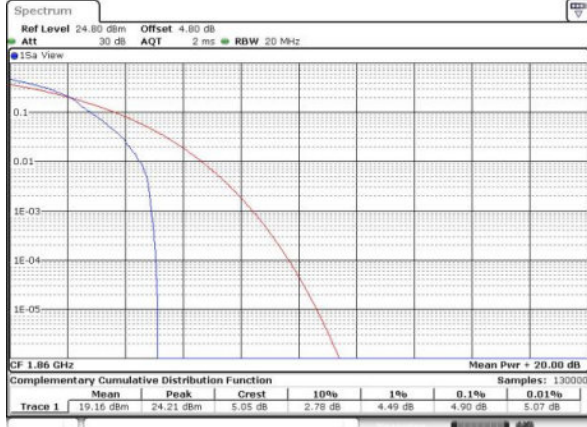

Date: 6 JUN 2016 23:57:37

Lowest Channel / Full RB

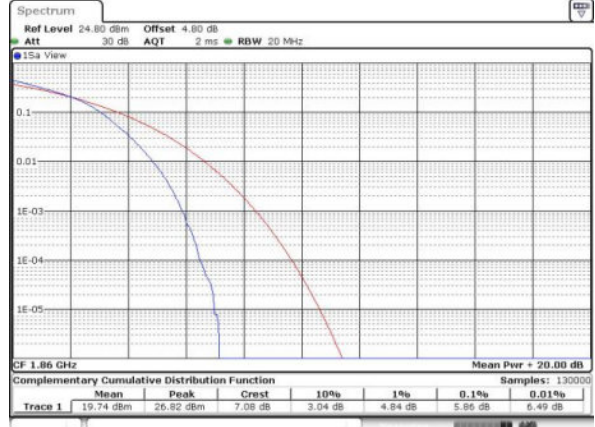

Date: 6 JUN 2016 23:57:47

Middle Channel / 1RB

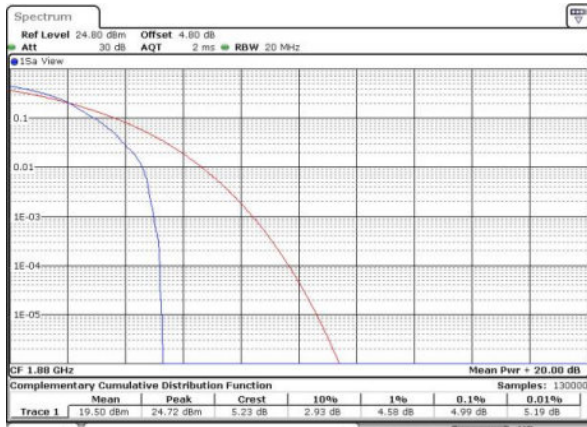

Date: 6 JUN 2016 23:57:58

Middle Channel / Full RB

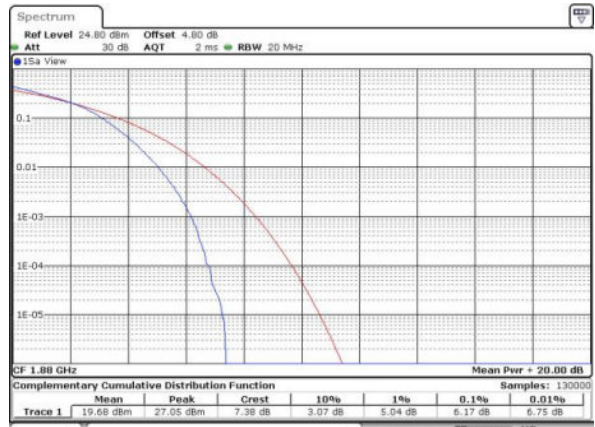

Date: 6 JUN 2016 23:58:08

Highest Channel / 1RB

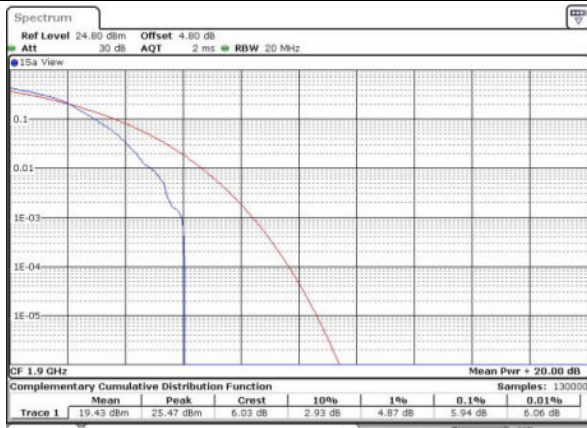

Date: 6 JUN 2016 23:58:20

Highest Channel / Full RB

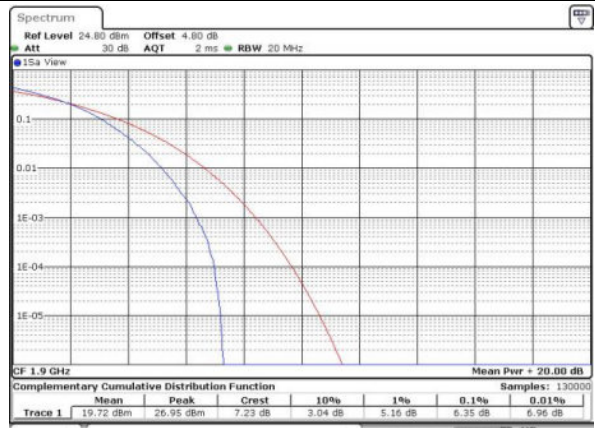

Date: 6 JUN 2016 23:58:31



26dB Bandwidth

Mode	LTE Band 2 : 26dB BW(MHz)											
	1.4MHz		3MHz		5MHz		10MHz		15MHz		20MHz	
BW	QPSK	16QAM	QPSK	16QAM	QPSK	16QAM	QPSK	16QAM	QPSK	16QAM	QPSK	16QAM
Lowest CH	1.250	1.239	2.997	3.003	4.765	4.985	9.990	9.650	14.446	14.446	20.500	20.260
Middle CH	1.259	1.245	2.973	2.967	4.975	4.885	9.770	9.870	14.745	14.655	20.300	20.180
Highest CH	1.245	1.262	2.973	3.003	5.025	4.905	9.650	9.750	14.505	14.266	20.380	20.380



LTE Band 2

Lowest Channel / 1.4MHz / QPSK

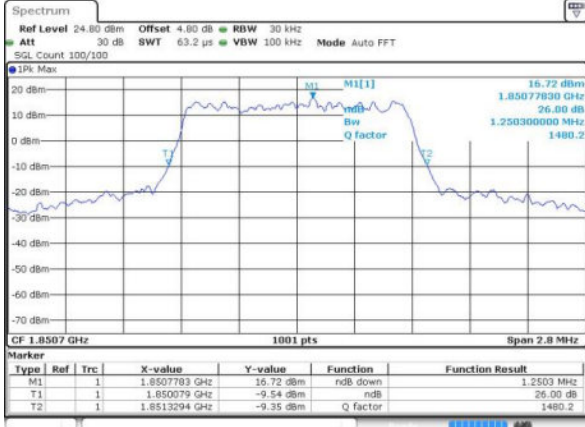

Date: 6 JUN 2016 21:57:51

Lowest Channel / 1.4MHz / 16QAM

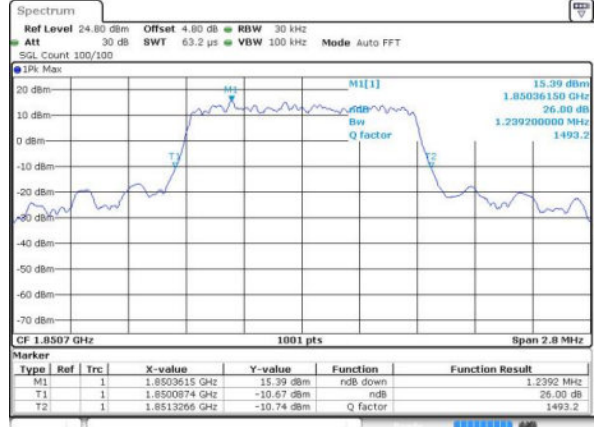

Date: 6 JUN 2016 21:58:02

Middle Channel / 1.4MHz / QPSK

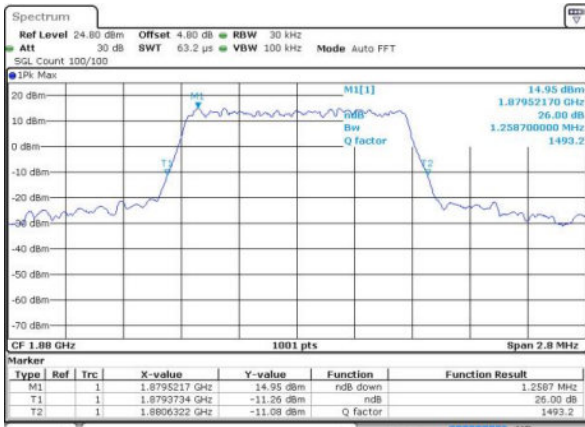

Date: 6 JUN 2016 22:04:56

Middle Channel / 1.4MHz / 16QAM

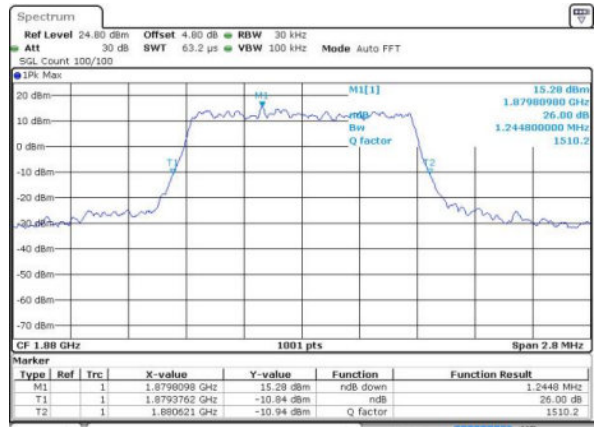

Date: 6 JUN 2016 22:05:07

Highest Channel / 1.4MHz / QPSK

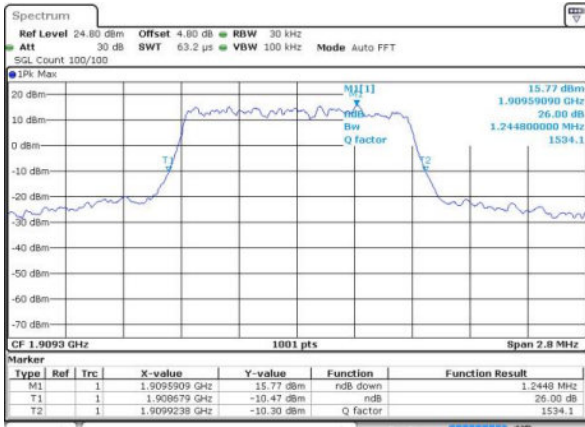

Date: 6 JUN 2016 22:07:29

Highest Channel / 1.4MHz / 16QAM

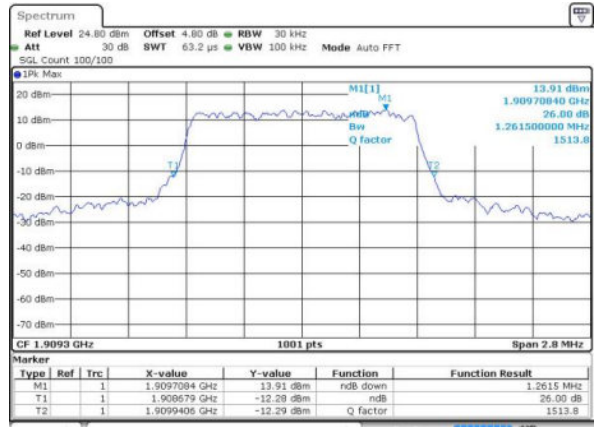

Date: 6 JUN 2016 22:07:40



LTE Band 2

Lowest Channel / 3MHz / QPSK

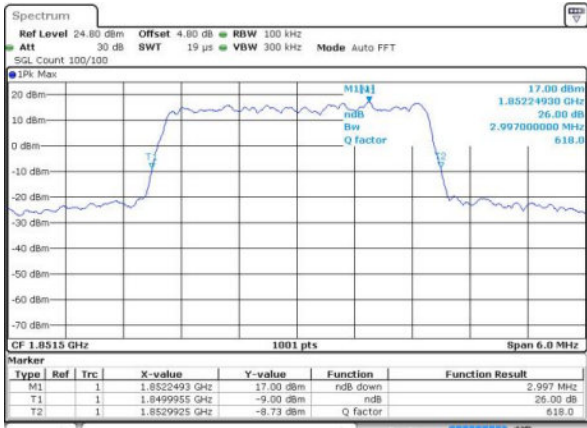

Date: 6 JUN 2016 22:14:34

Lowest Channel / 3MHz / 16QAM

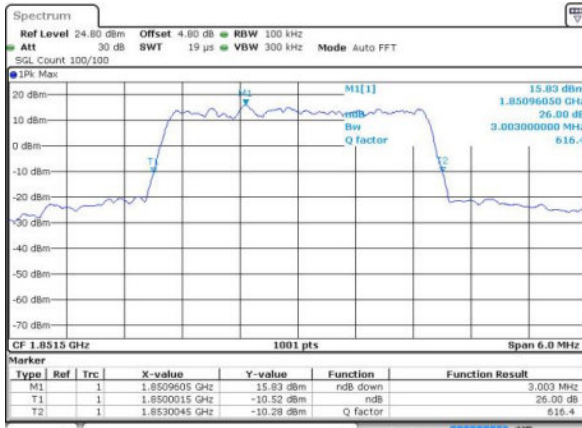

Date: 6 JUN 2016 22:14:44

Middle Channel / 3MHz / QPSK

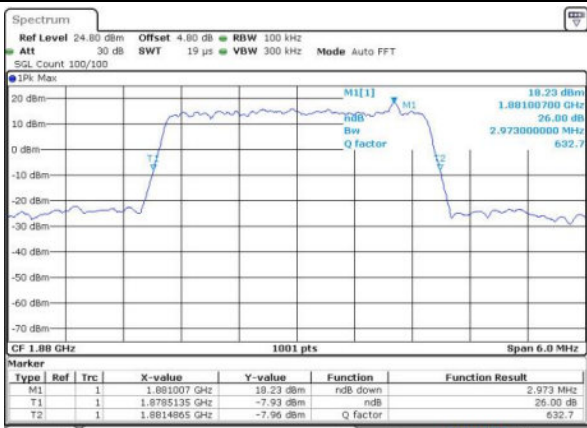

Date: 6 JUN 2016 22:21:38

Middle Channel / 3MHz / 16QAM

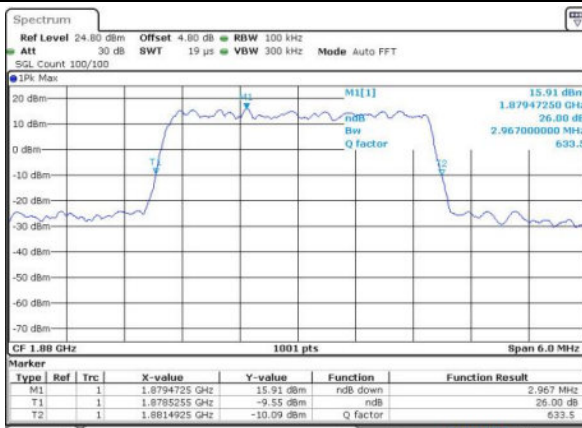

Date: 6 JUN 2016 22:36:05

Highest Channel / 3MHz / QPSK

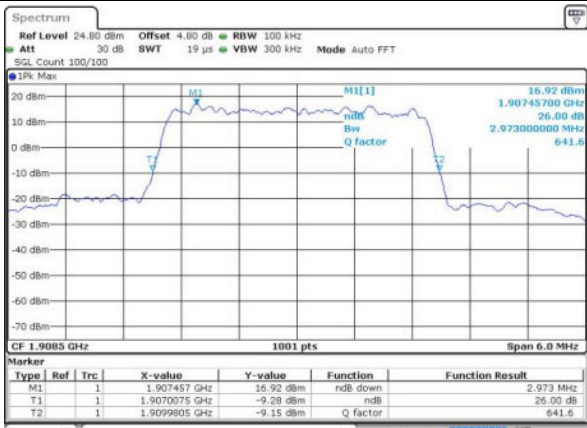

Date: 6 JUN 2016 22:40:27

Highest Channel / 3MHz / 16QAM

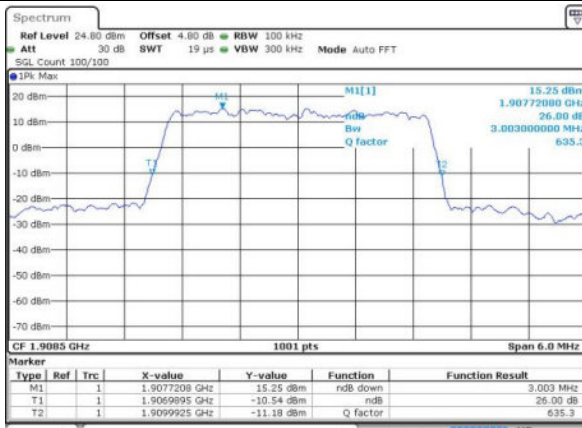

Date: 6 JUN 2016 22:40:38



LTE Band 2

Lowest Channel / 5MHz / QPSK

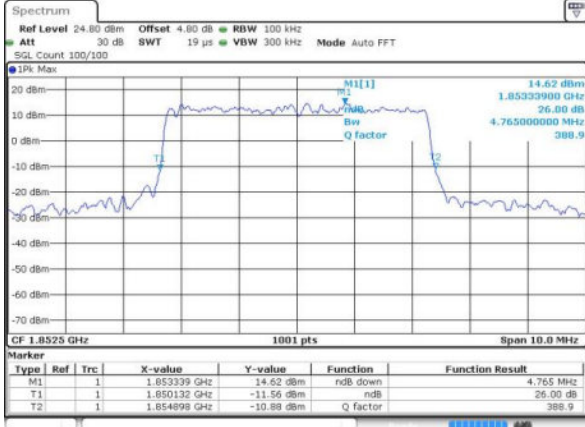

Date: 6 JUN 2016 22:47:32

Lowest Channel / 5MHz / 16QAM

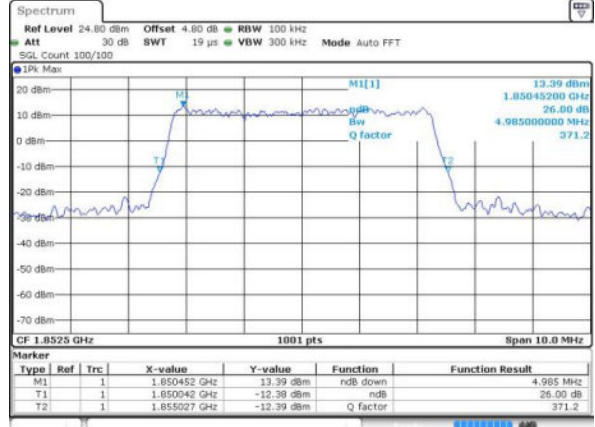

Date: 6 JUN 2016 22:47:43

Middle Channel / 5MHz / QPSK

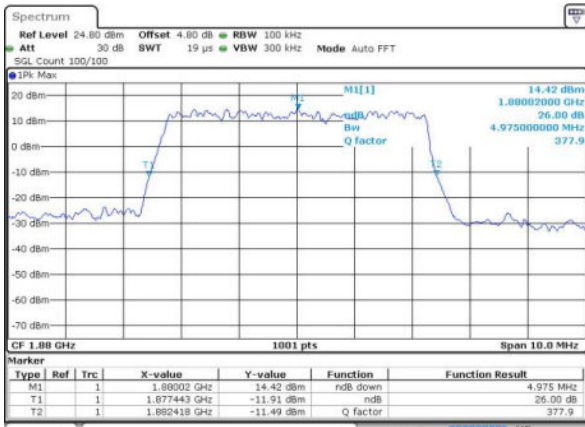

Date: 6 JUN 2016 22:54:37

Middle Channel / 5MHz / 16QAM

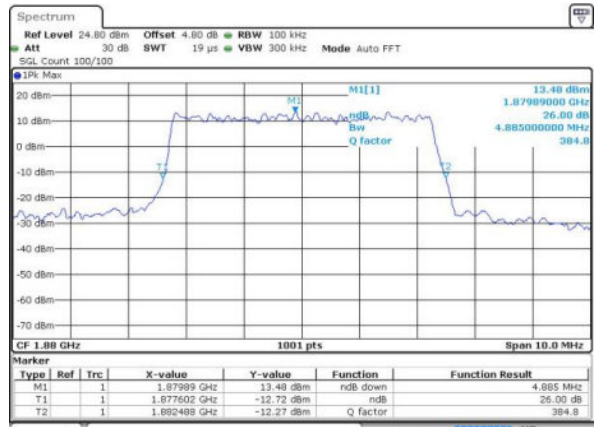

Date: 6 JUN 2016 22:54:48

Highest Channel / 5MHz / QPSK

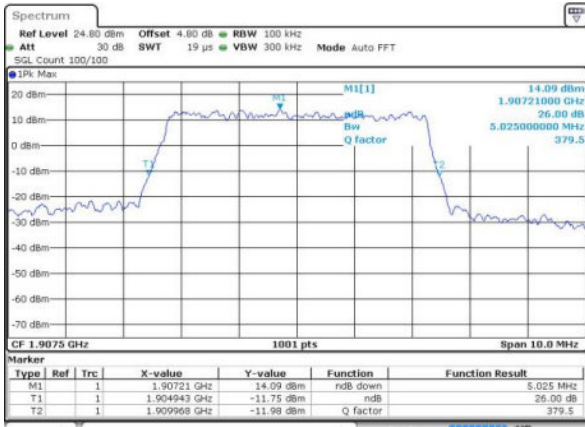

Date: 6 JUN 2016 22:57:10

Highest Channel / 5MHz / 16QAM

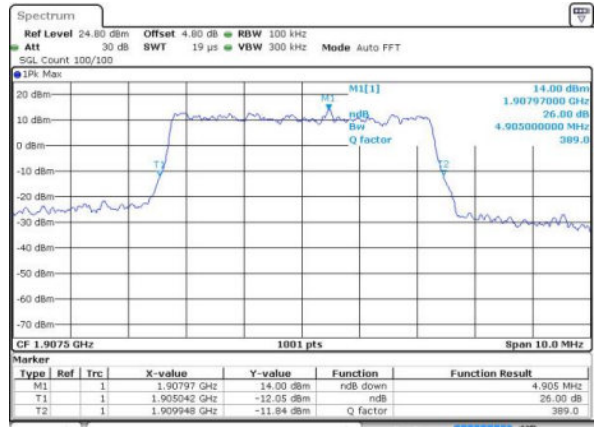

Date: 6 JUN 2016 22:57:21



LTE Band 2

Lowest Channel / 10MHz / QPSK

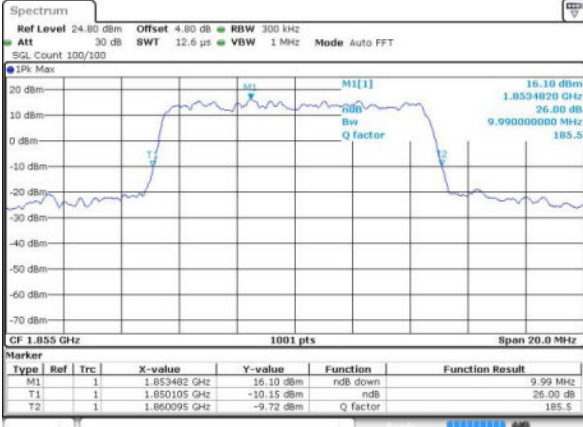

Date: 6 JUN 2016 23:04:15

Lowest Channel / 10MHz / 16QAM

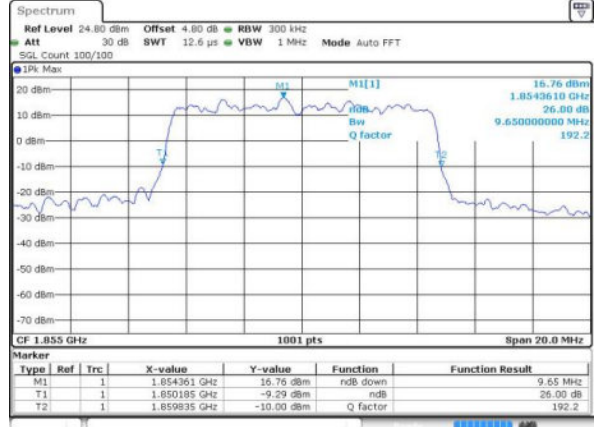

Date: 6 JUN 2016 23:04:26

Middle Channel / 10MHz / QPSK



Date: 6 JUN 2016 23:11:20

Middle Channel / 10MHz / 16QAM



Date: 6 JUN 2016 23:11:31

Highest Channel / 10MHz / QPSK



Date: 6 JUN 2016 23:13:53

Highest Channel / 10MHz / 16QAM

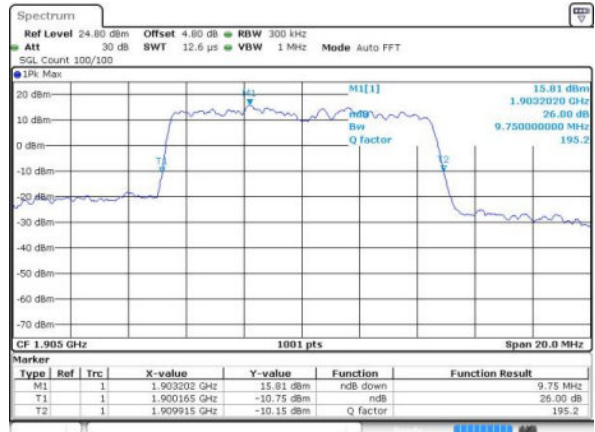

Date: 6 JUN 2016 23:14:03



LTE Band 2

Lowest Channel / 15MHz / QPSK

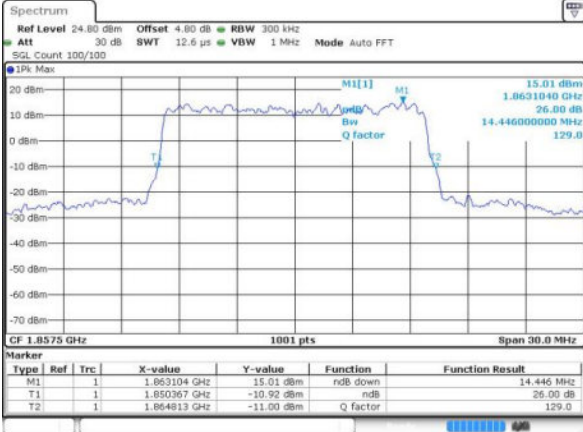

Date: 6 JUN 2016 23:20:58

Lowest Channel / 15MHz / 16QAM

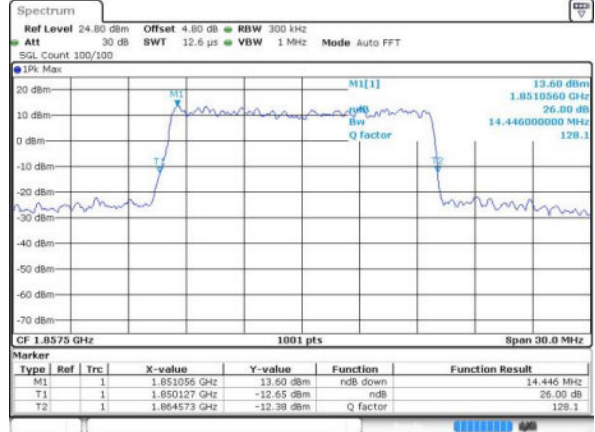

Date: 6 JUN 2016 23:21:08

Middle Channel / 15MHz / QPSK

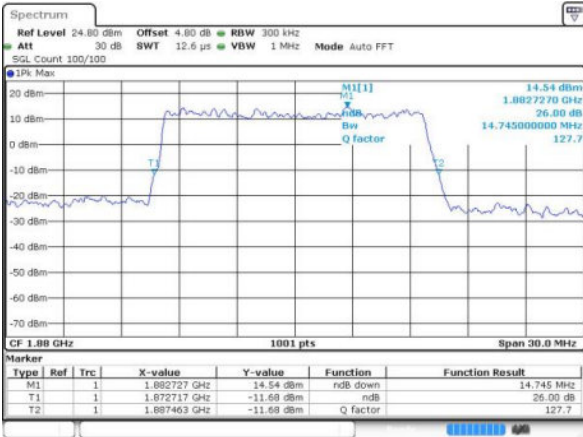

Date: 6 JUN 2016 23:28:02

Middle Channel / 15MHz / 16QAM

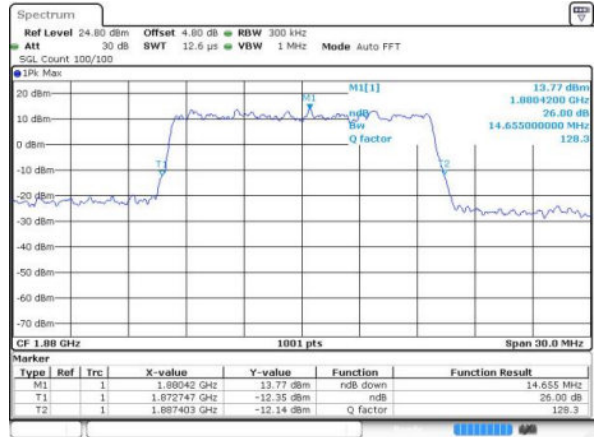

Date: 6 JUN 2016 23:28:13

Highest Channel / 15MHz / QPSK

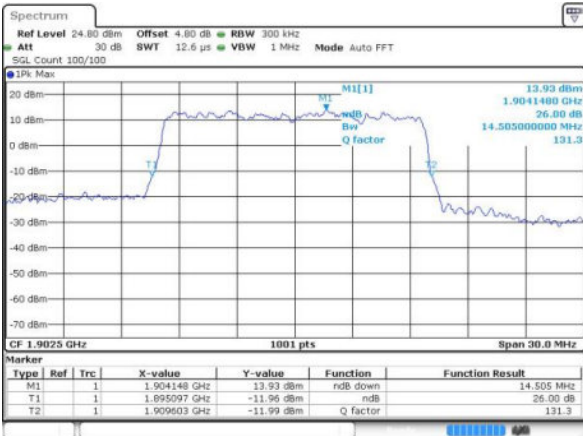

Date: 6 JUN 2016 23:30:35

Highest Channel / 15MHz / 16QAM

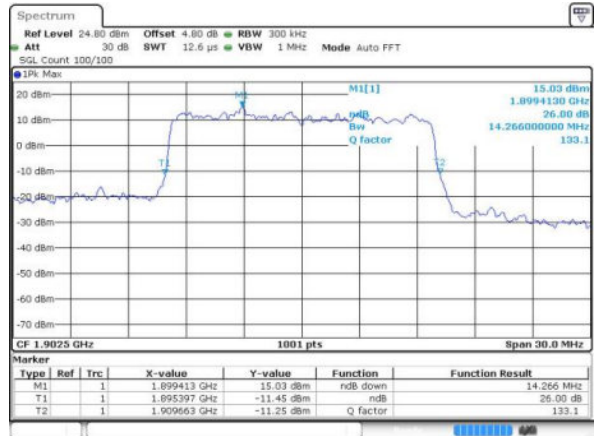

Date: 6 JUN 2016 23:30:46



LTE Band 2

Lowest Channel / 20MHz / QPSK



Date: 6 JUN 2016 23:37:40

Lowest Channel / 20MHz / 16QAM

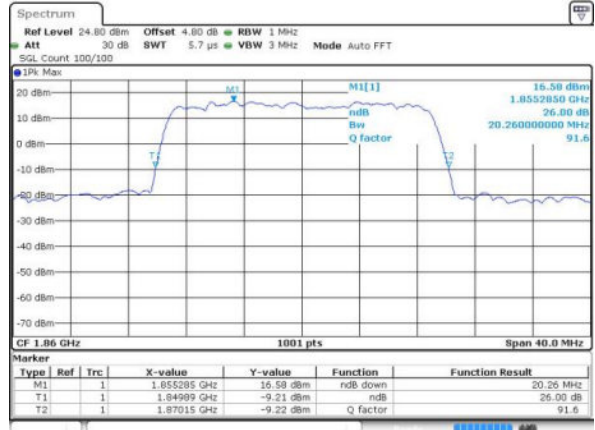

Date: 6 JUN 2016 23:37:50

Middle Channel / 20MHz / QPSK



Date: 6 JUN 2016 23:44:45

Middle Channel / 20MHz / 16QAM

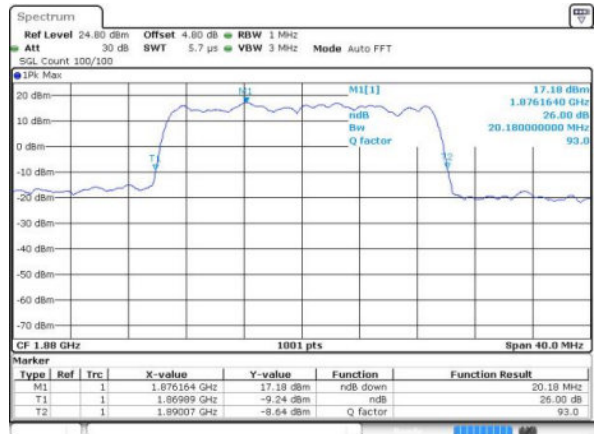

Date: 6 JUN 2016 23:44:56

Highest Channel / 20MHz / QPSK

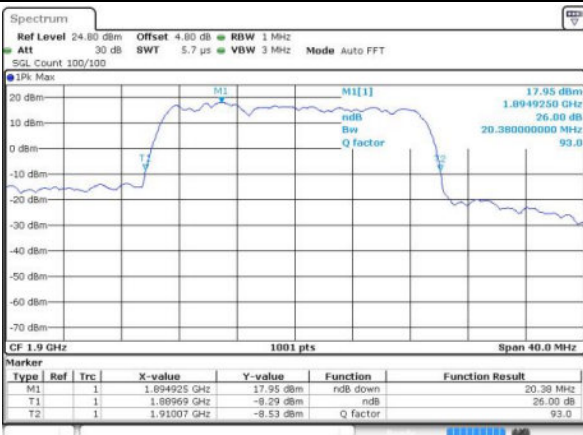

Date: 6 JUN 2016 23:47:18

Highest Channel / 20MHz / 16QAM



Date: 6 JUN 2016 23:47:29



Occupied Bandwidth

Mode	LTE Band 2 : 99%OBW(MHz)											
	1.4MHz		3MHz		5MHz		10MHz		15MHz		20MHz	
BW	QPSK	16QAM	QPSK	16QAM	QPSK	16QAM	QPSK	16QAM	QPSK	16QAM	QPSK	16QAM
Lowest CH	1.09	1.10	2.71	2.71	4.51	4.49	9.09	9.03	13.46	13.55	18.34	18.50
Middle CH	1.09	1.10	2.72	2.72	4.51	4.51	9.01	9.05	13.46	13.49	18.34	18.50
Highest CH	1.09	1.10	2.70	2.70	4.52	4.50	9.07	8.99	13.52	13.46	18.38	18.26



LTE Band 2

Lowest Channel / 1.4MHz / QPSK

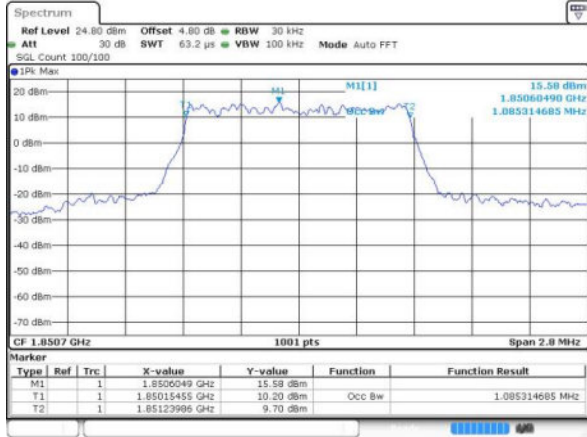

Date: 6 JUN 2016 21:57:30

Lowest Channel / 1.4MHz / 16QAM

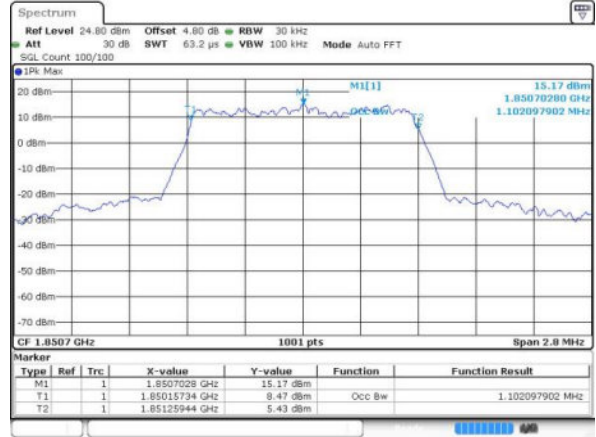

Date: 6 JUN 2016 21:57:40

Middle Channel / 1.4MHz / QPSK

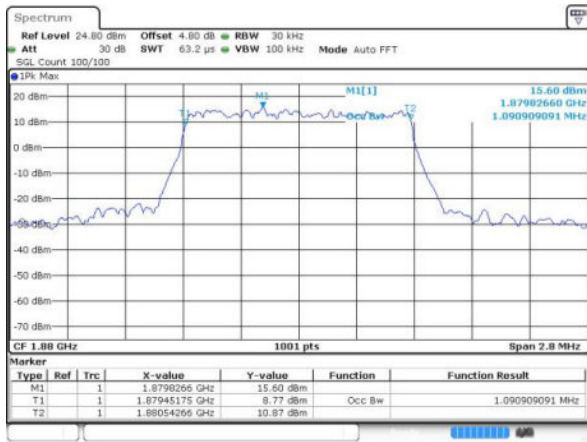

Date: 6 JUN 2016 22:04:35

Middle Channel / 1.4MHz / 16QAM

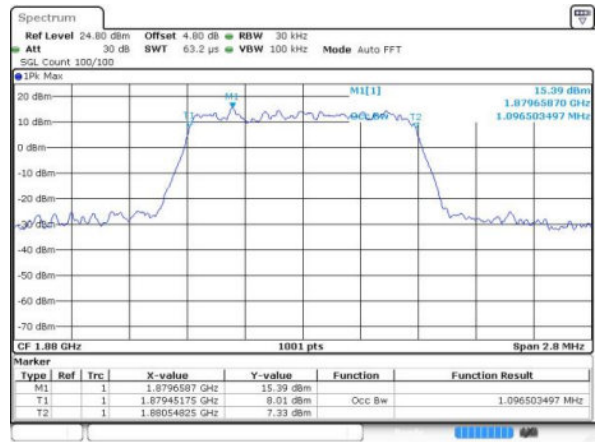

Date: 6 JUN 2016 22:04:46

Highest Channel / 1.4MHz / QPSK

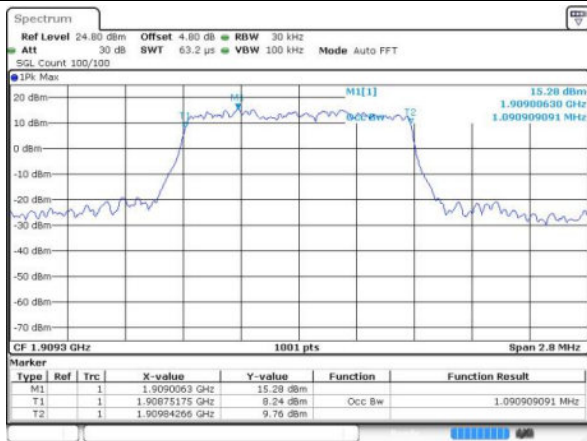

Date: 6 JUN 2016 22:07:08

Highest Channel / 1.4MHz / 16QAM

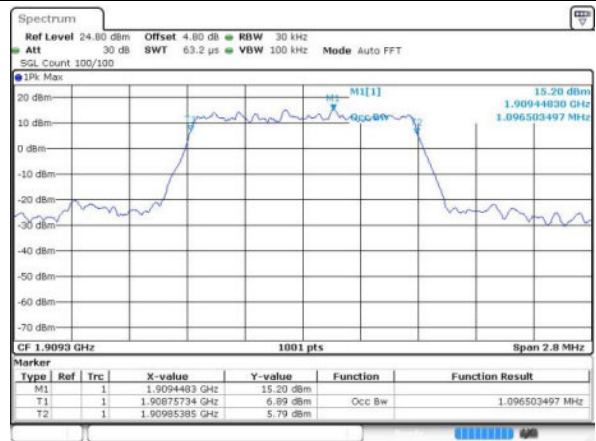

Date: 6 JUN 2016 22:07:19



LTE Band 2

Lowest Channel / 3MHz / QPSK

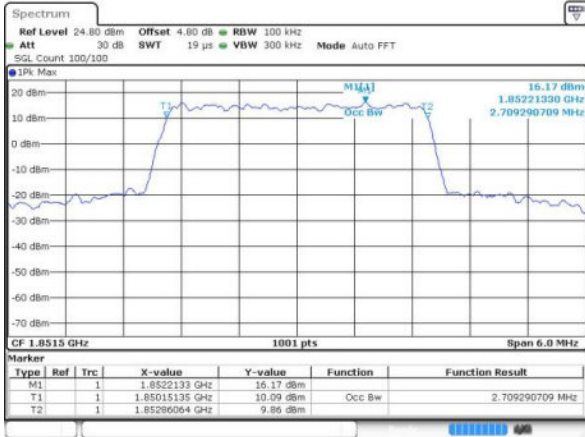

Date: 6 JUN 2016 22:14:13

Lowest Channel / 3MHz / 16QAM

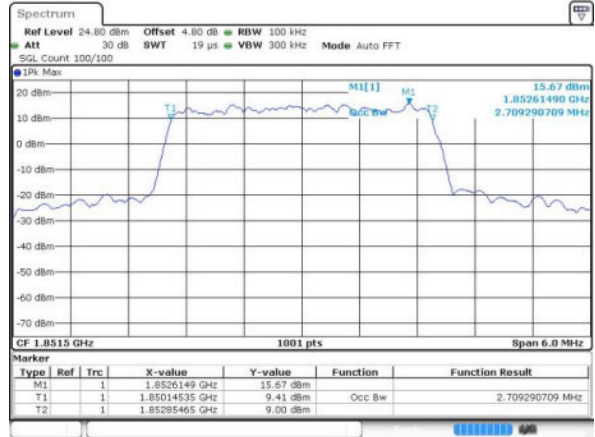

Date: 6 JUN 2016 22:14:23

Middle Channel / 3MHz / QPSK

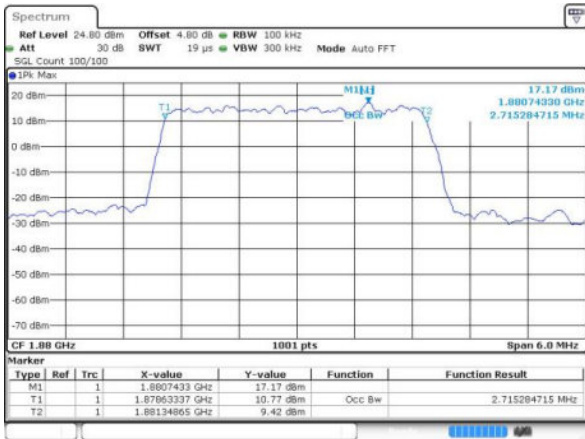

Date: 6 JUN 2016 22:21:18

Middle Channel / 3MHz / 16QAM

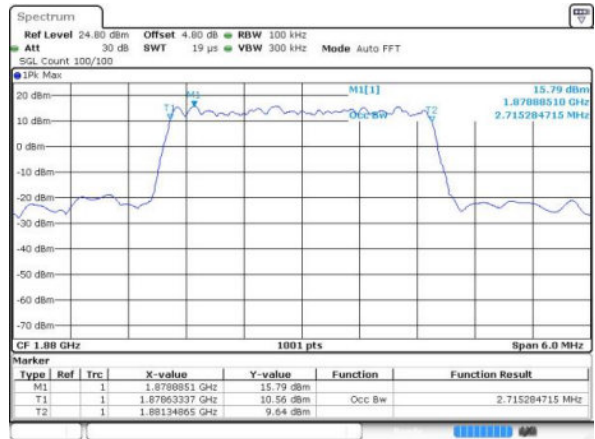

Date: 6 JUN 2016 22:21:28

Highest Channel / 3MHz / QPSK

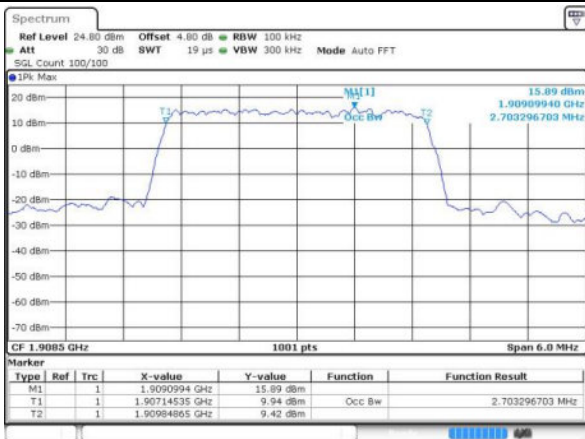

Date: 6 JUN 2016 22:40:06

Highest Channel / 3MHz / 16QAM

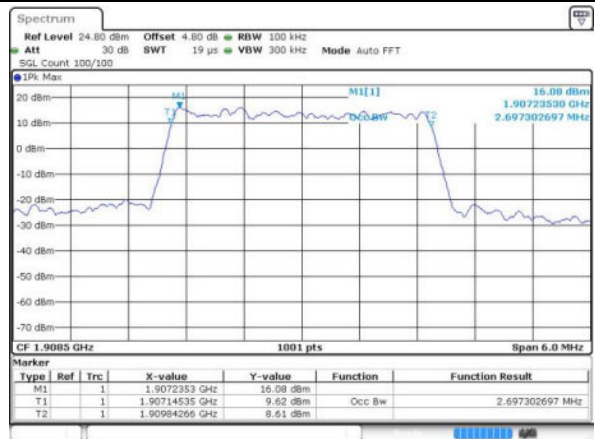

Date: 6 JUN 2016 22:40:17



LTE Band 2

Lowest Channel / 5MHz / QPSK

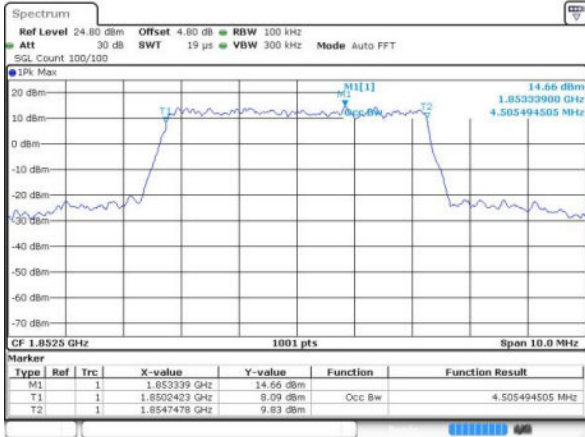

Lowest Channel / 5MHz / 16QAM

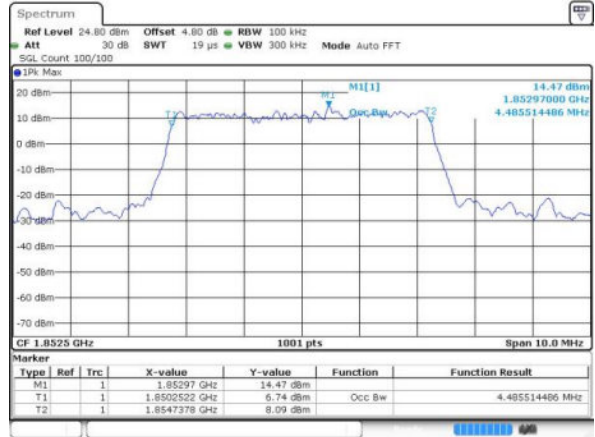

Middle Channel / 5MHz / QPSK

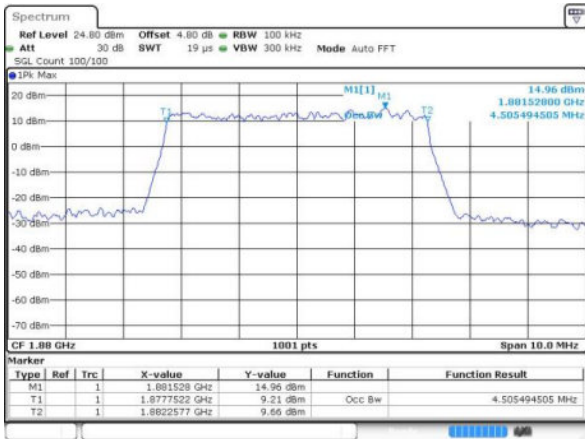

Middle Channel / 5MHz / 16QAM

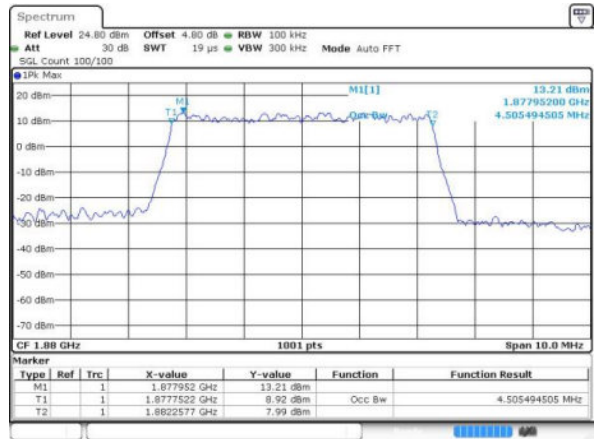

Highest Channel / 5MHz / QPSK



Highest Channel / 5MHz / 16QAM

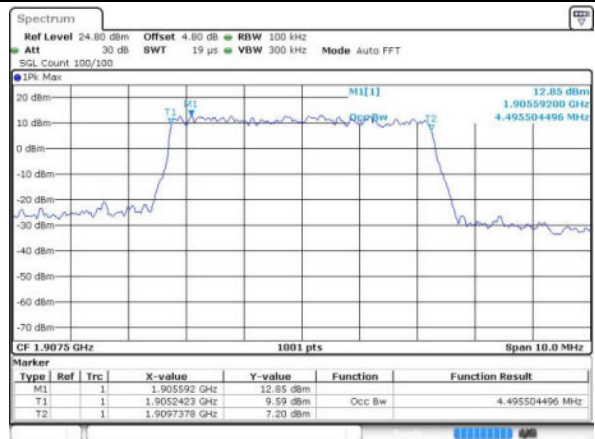



LTE Band 2

Lowest Channel / 10MHz / QPSK

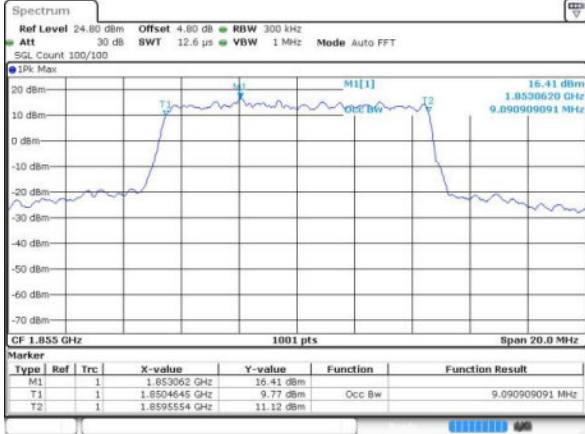

Date: 6 JUN 2016 23:03:54

Lowest Channel / 10MHz / 16QAM

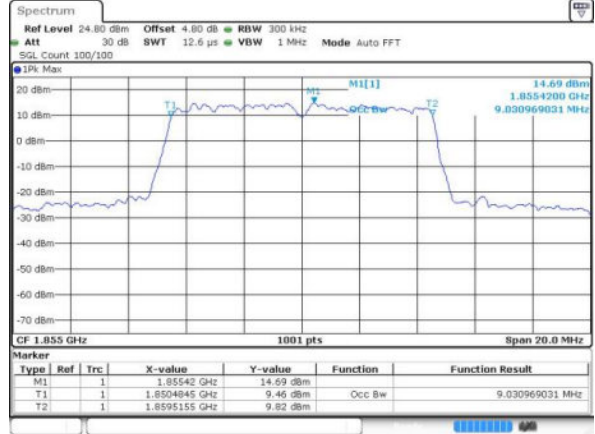

Date: 6 JUN 2016 23:04:04

Middle Channel / 10MHz / QPSK

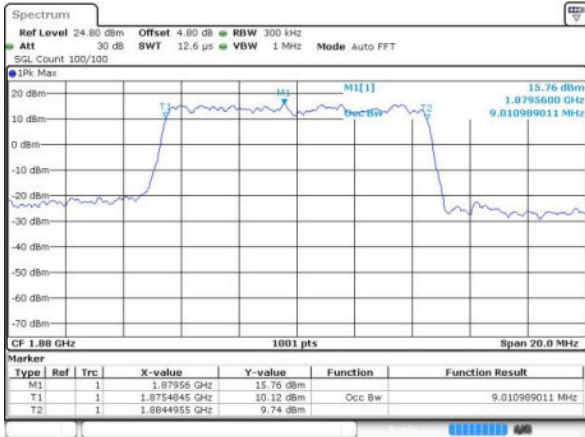

Date: 6 JUN 2016 23:10:59

Middle Channel / 10MHz / 16QAM

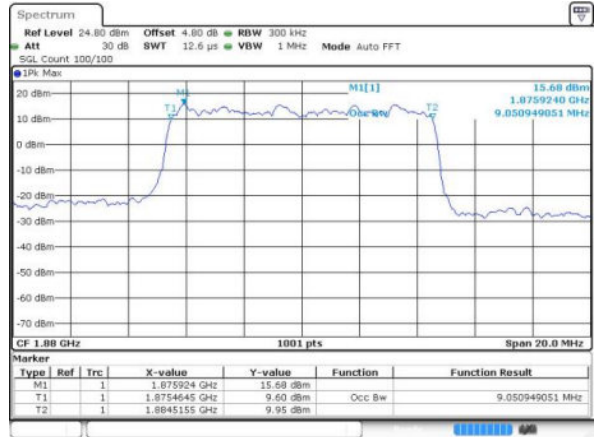

Date: 6 JUN 2016 23:11:10

Highest Channel / 10MHz / QPSK

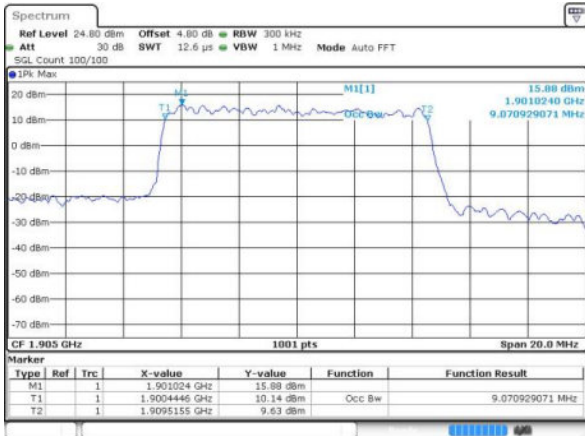

Date: 6 JUN 2016 23:13:32

Highest Channel / 10MHz / 16QAM

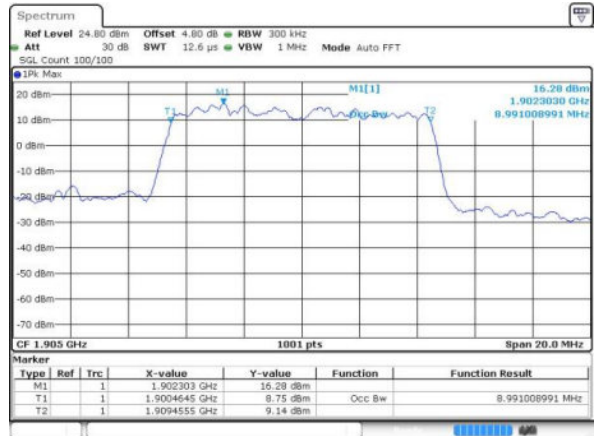

Date: 6 JUN 2016 23:13:42



LTE Band 2

Lowest Channel / 15MHz / QPSK

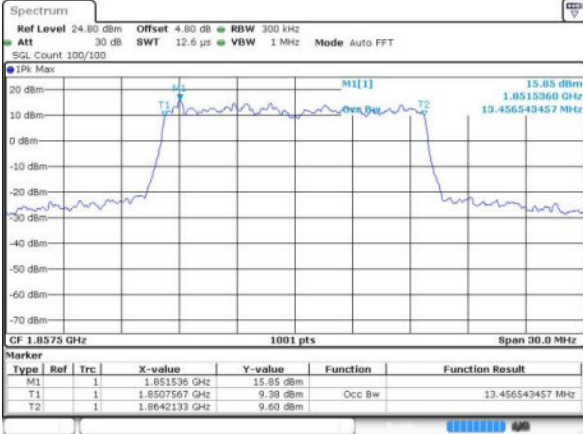

Date: 6 JUN 2016 23:20:36

Lowest Channel / 15MHz / 16QAM

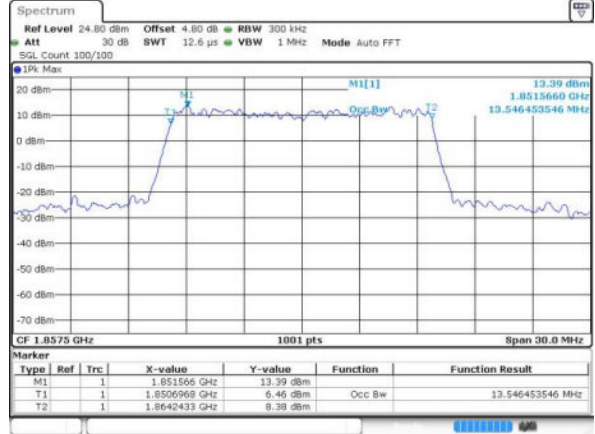

Date: 6 JUN 2016 23:20:47

Middle Channel / 15MHz / QPSK

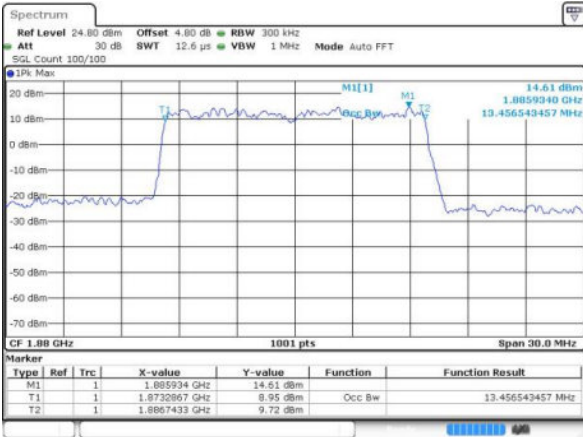

Date: 6 JUN 2016 23:27:41

Middle Channel / 15MHz / 16QAM

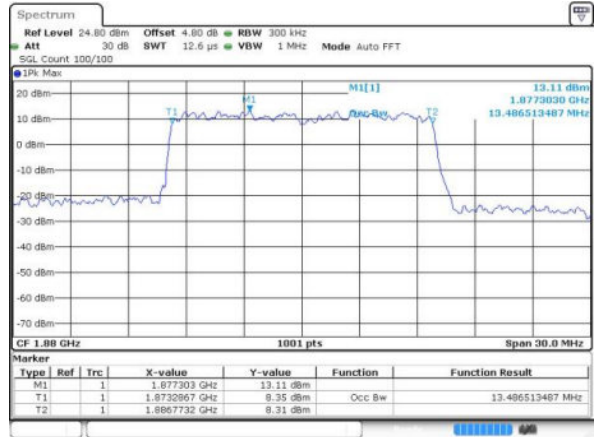

Date: 6 JUN 2016 23:27:52

Highest Channel / 15MHz / QPSK

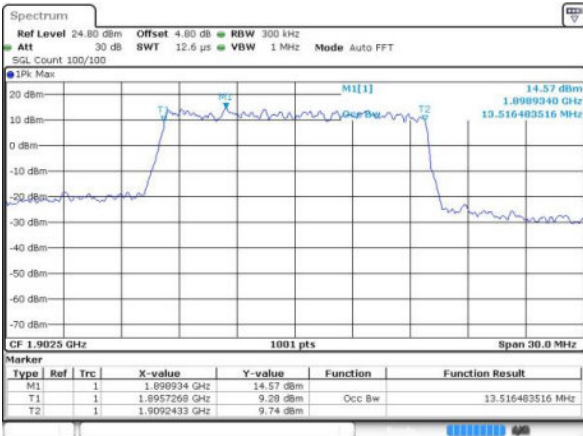

Date: 6 JUN 2016 23:30:14

Highest Channel / 15MHz / 16QAM

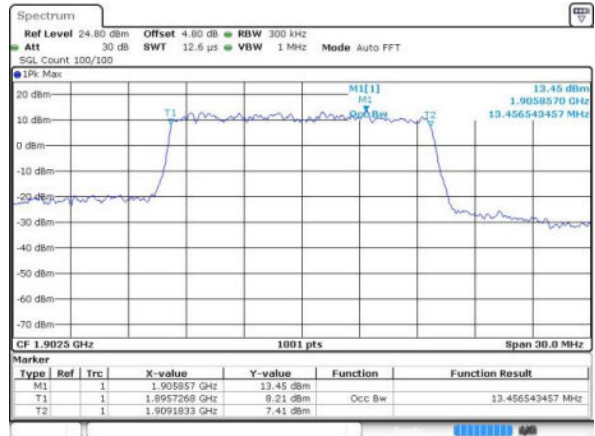

Date: 6 JUN 2016 23:30:25



LTE Band 2

Lowest Channel / 20MHz / QPSK

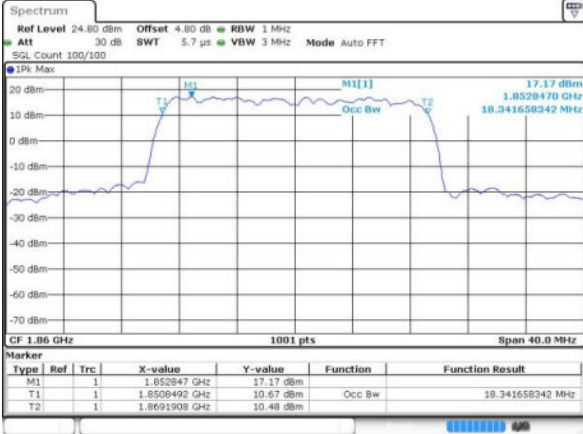

Date: 6 JUN 2016 23:37:19

Lowest Channel / 20MHz / 16QAM

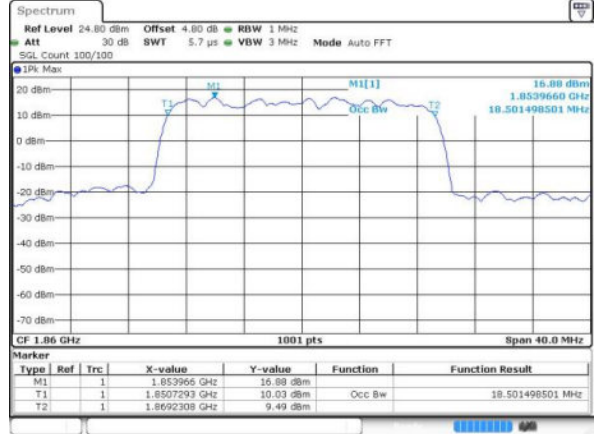

Date: 6 JUN 2016 23:37:29

Middle Channel / 20MHz / QPSK

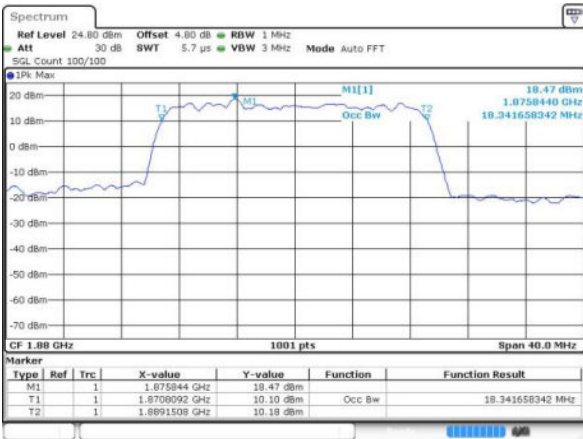

Date: 6 JUN 2016 23:44:24

Middle Channel / 20MHz / 16QAM

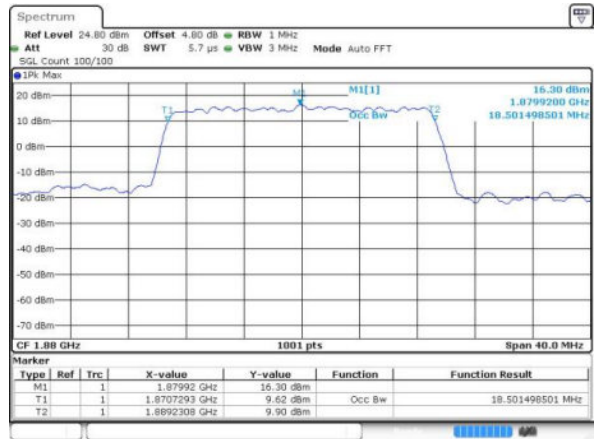

Date: 6 JUN 2016 23:44:35

Highest Channel / 20MHz / QPSK

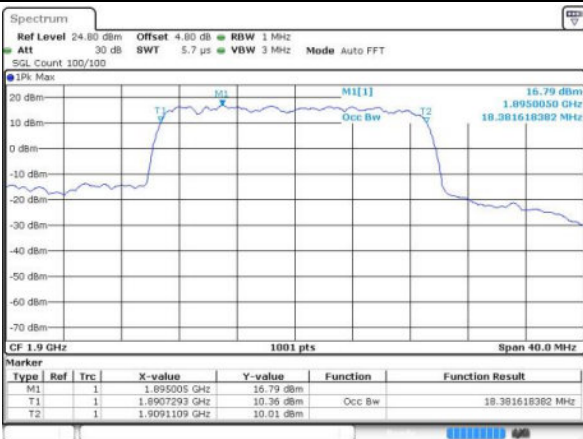

Date: 6 JUN 2016 23:46:57

Highest Channel / 20MHz / 16QAM

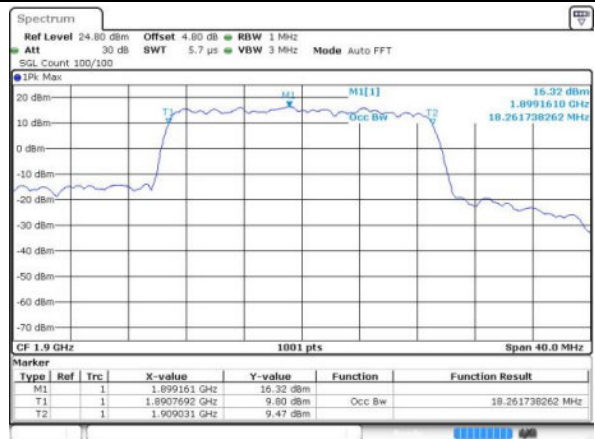

Date: 6 JUN 2016 23:47:08



Conducted Band Edge

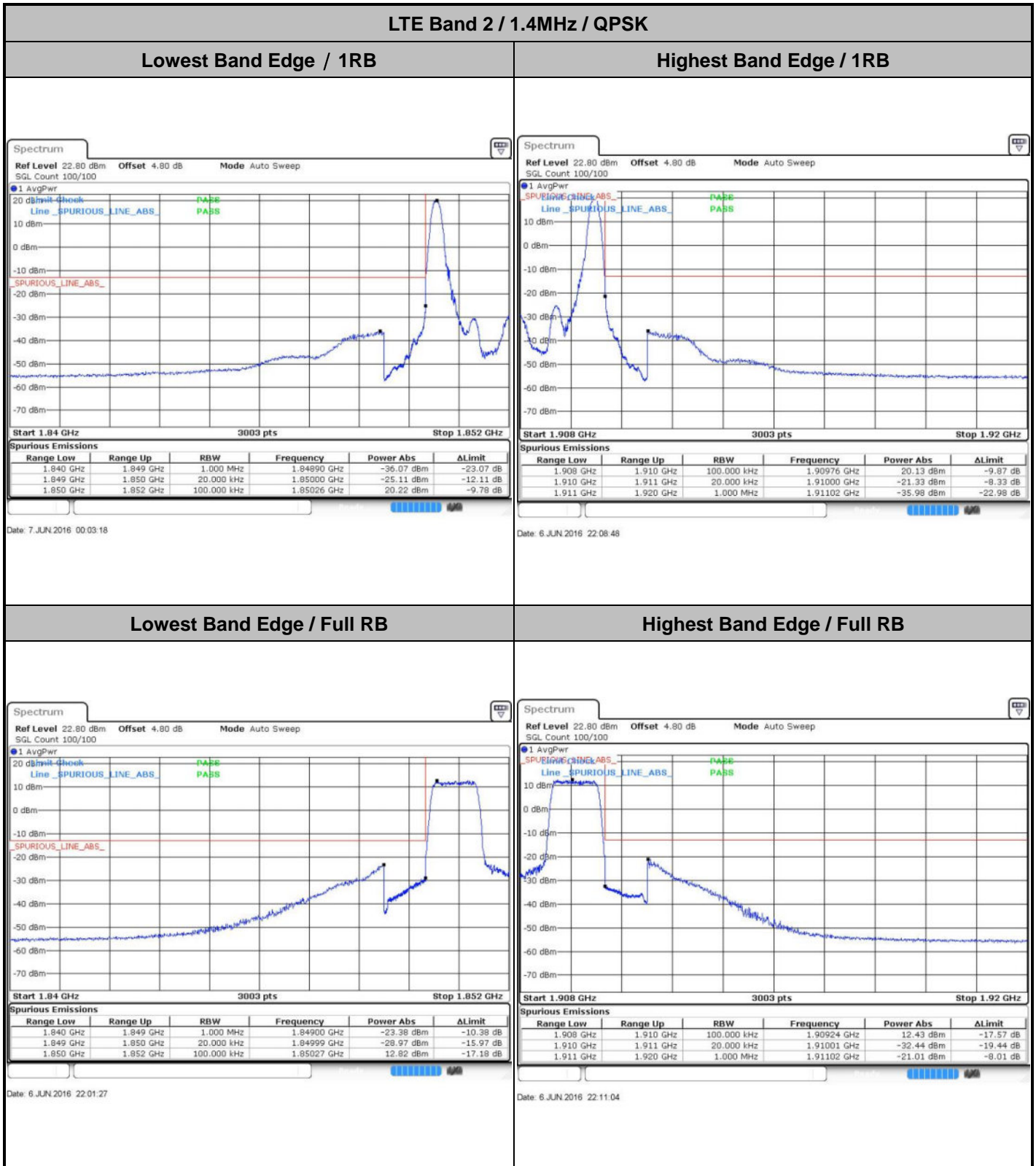



LTE Band 2 / 1.4MHz / 16QAM

Lowest Band Edge / 1 RB

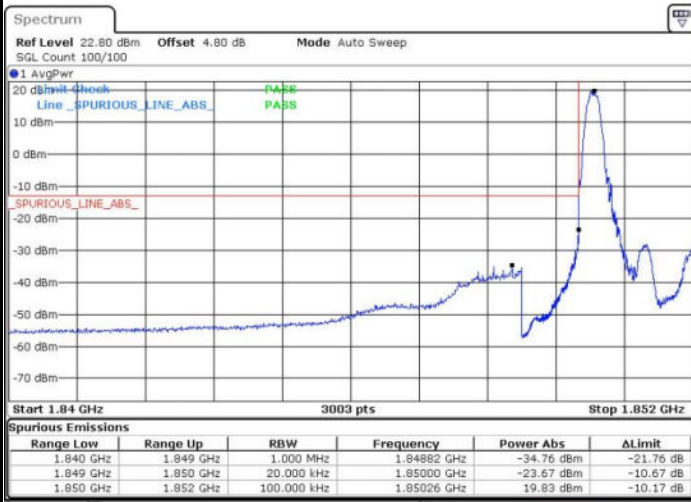

Date: 6 JUN 2016 22:00:19

Highest Band Edge / 1 RB



Date: 6 JUN 2016 22:09:56

Lowest Band Edge / Full RB

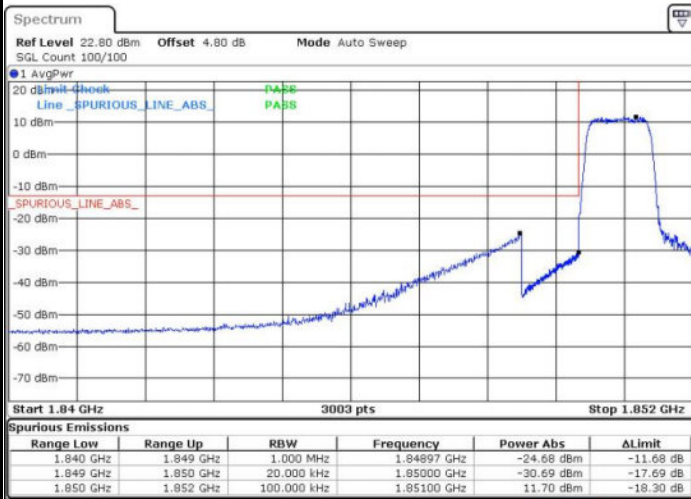

Date: 6 JUN 2016 22:02:34

Highest Band Edge / Full RB



Date: 7 JUN 2016 00:05:12



LTE Band 2 / 3MHz / QPSK

Lowest Band Edge / 1RB

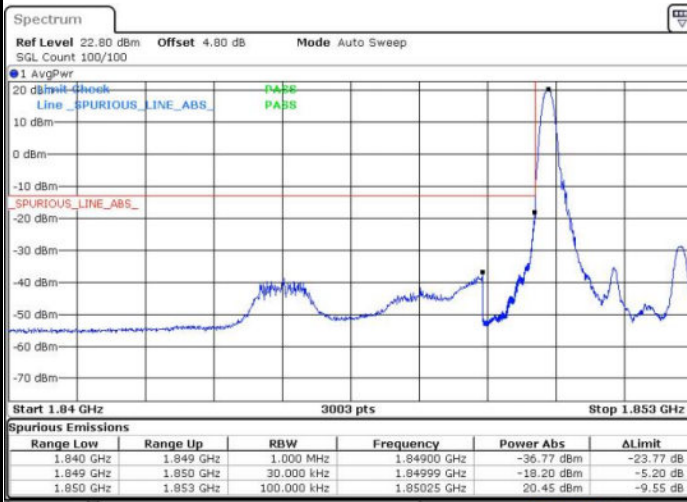

Date: 6 JUN 2016 22:15:53

Highest Band Edge / 1 RB

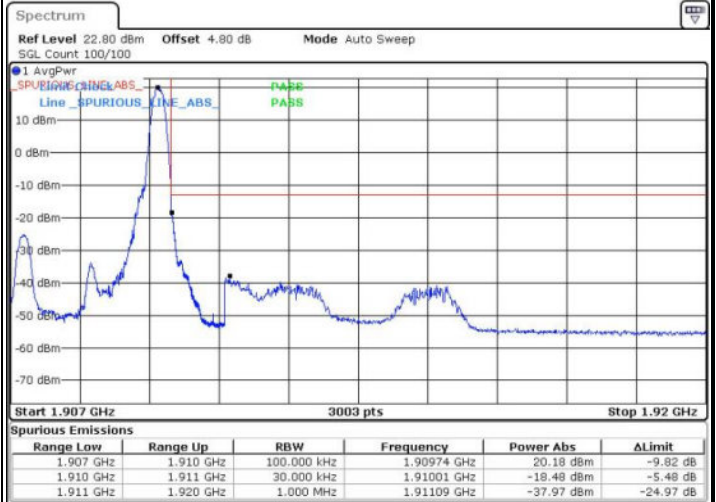

Date: 6 JUN 2016 22:41:46

Lowest Band Edge / Full RB

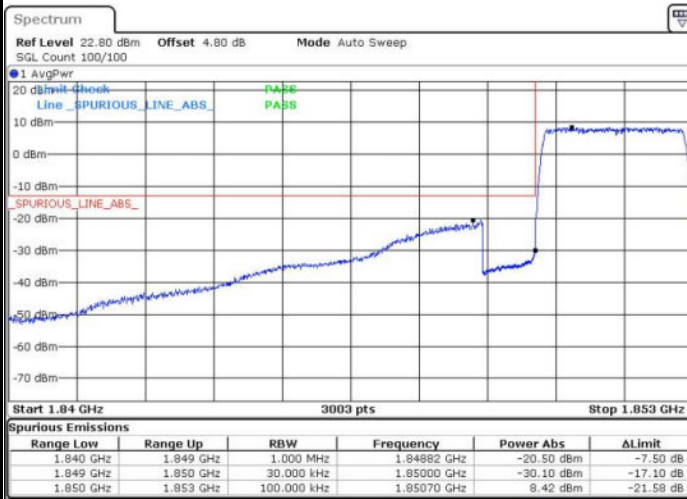

Date: 6 JUN 2016 22:18:09

Highest Band Edge / Full RB



Date: 6 JUN 2016 22:44:02



LTE Band 2 / 3MHz / 16QAM

Lowest Band Edge / 1 RB

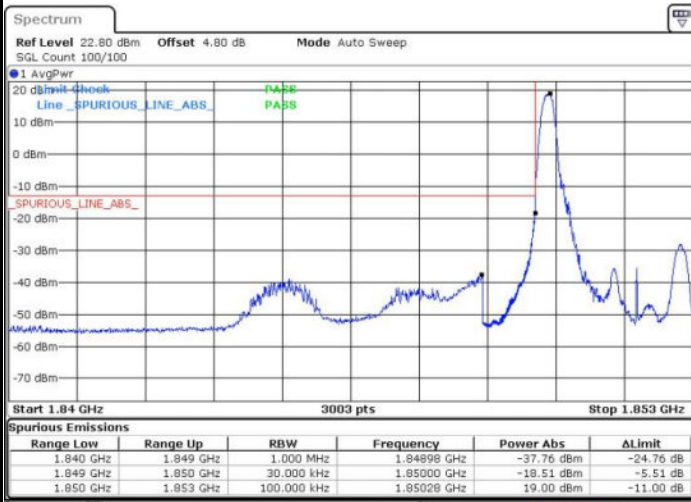

Date: 6 JUN 2016 22:17:01

Highest Band Edge / 1 RB

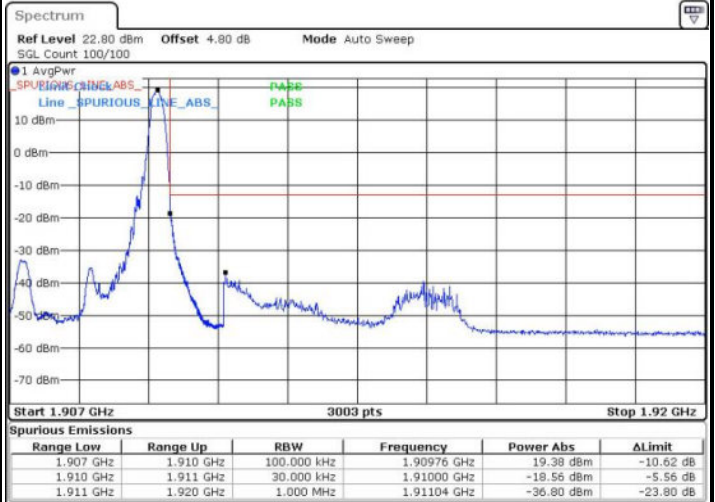

Date: 6 JUN 2016 22:42:54

Lowest Band Edge / Full RB



Date: 6 JUN 2016 22:19:17

Highest Band Edge / Full RB



Date: 6 JUN 2016 22:45:10



LTE Band 2 / 5MHz / QPSK

Lowest Band Edge / 1 RB

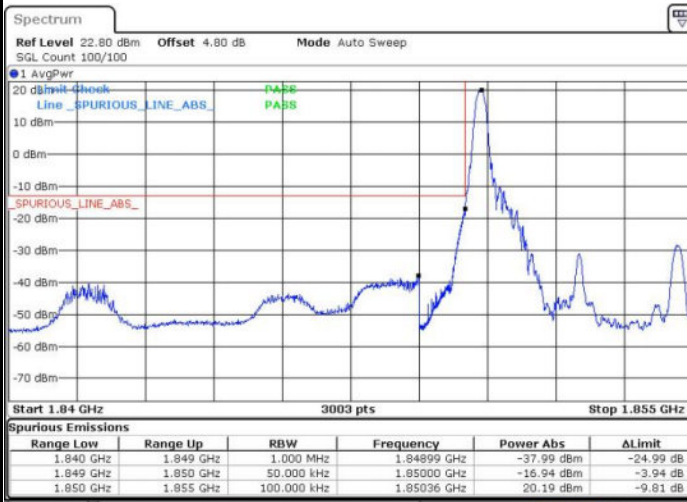

Date: 6 JUN 2016 22:48:51

Highest Band Edge / 1 RB

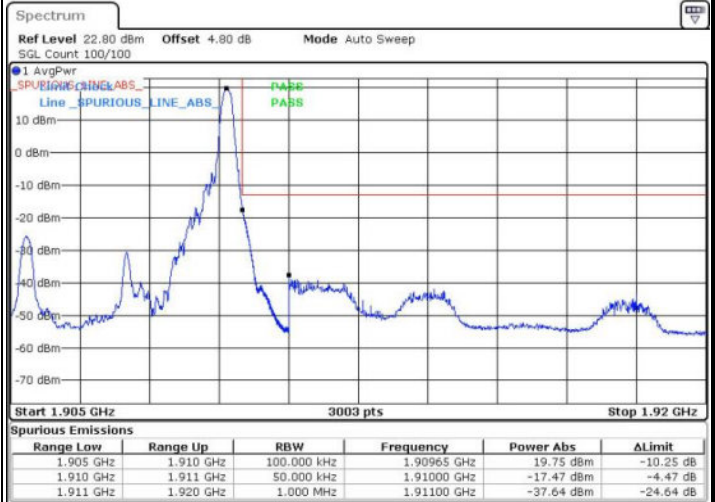

Date: 6 JUN 2016 22:58:29

Lowest Band Edge / Full RB

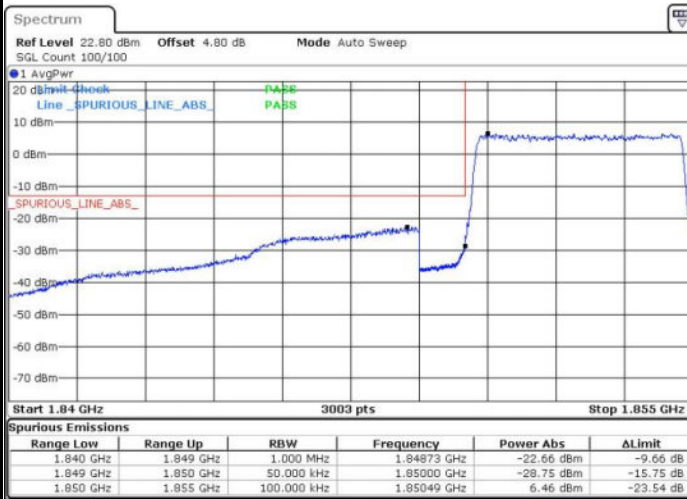

Date: 6 JUN 2016 22:51:07

Highest Band Edge / Full RB

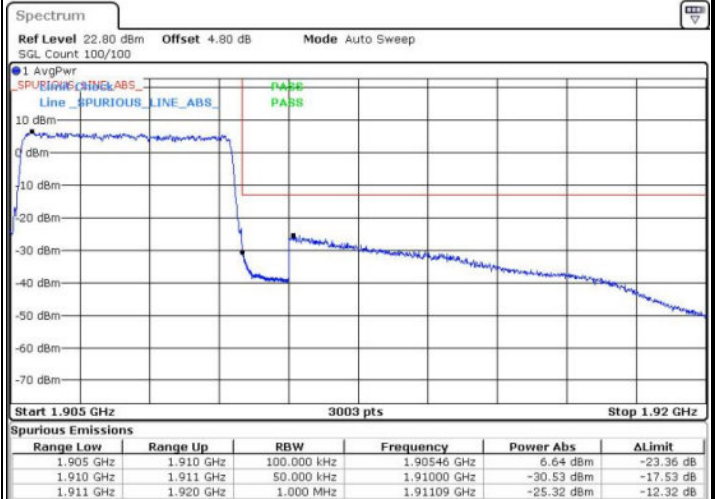

Date: 6 JUN 2016 23:00:45