

## Measurement Conditions

DASY system configuration, as far as not given on page 1.

|                              |                        |             |
|------------------------------|------------------------|-------------|
| DASY Version                 | DASY5                  | V52.10.0    |
| Extrapolation                | Advanced Extrapolation |             |
| Phantom                      | Modular Flat Phantom   |             |
| Distance Dipole Center - TSL | 10 mm                  | with Spacer |
| Zoom Scan Resolution         | dx, dy, dz = 5 mm      |             |
| Frequency                    | 1900 MHz ± 1 MHz       |             |

## Head TSL parameters

The following parameters and calculations were applied.

|   | Temperature     | Permittivity | Conductivity     |
|---|-----------------|--------------|------------------|
| Nominal Head TSL parameters             | 22.0 °C         | 40.0         | 1.40 mho/m       |
| Measured Head TSL parameters            | (22.0 ± 0.2) °C | 40.8 ± 6 %   | 1.37 mho/m ± 6 % |
| Head TSL temperature change during test | < 0.5 °C        | ----         | ----             |

## SAR result with Head TSL

| SAR averaged over 1 cm <sup>3</sup> (1 g) of Head TSL | Condition          |                                 |
|---|--------------------|---------------------------------|
| SAR measured  | 250 mW input power | 9.89 W/kg                       |
| SAR for nominal Head TSL parameters                   | normalized to 1W   | <b>40.3 W/kg ± 17.0 % (k=2)</b> |

| SAR averaged over 10 cm <sup>3</sup> (10 g) of Head TSL | condition          |                                 |
|---|--------------------|---------------------------------|
| SAR measured  | 250 mW input power | 5.20 W/kg                       |
| SAR for nominal Head TSL parameters                     | normalized to 1W   | <b>21.0 W/kg ± 16.5 % (k=2)</b> |

## Body TSL parameters

The following parameters and calculations were applied.

|   | Temperature     | Permittivity | Conductivity     |
|---|-----------------|--------------|------------------|
| Nominal Body TSL parameters             | 22.0 °C         | 53.3         | 1.52 mho/m       |
| Measured Body TSL parameters            | (22.0 ± 0.2) °C | 54.0 ± 6 %   | 1.49 mho/m ± 6 % |
| Body TSL temperature change during test | < 0.5 °C        | ----         | ----             |

## SAR result with Body TSL

| SAR averaged over 1 cm <sup>3</sup> (1 g) of Body TSL | Condition          |                                 |
|---|--------------------|---------------------------------|
| SAR measured  | 250 mW input power | 9.94 W/kg                       |
| SAR for nominal Body TSL parameters                   | normalized to 1W   | <b>40.4 W/kg ± 17.0 % (k=2)</b> |

| SAR averaged over 10 cm <sup>3</sup> (10 g) of Body TSL | condition          |                                 |
|---|--------------------|---------------------------------|
| SAR measured  | 250 mW input power | 5.28 W/kg                       |
| SAR for nominal Body TSL parameters                     | normalized to 1W   | <b>21.3 W/kg ± 16.5 % (k=2)</b> |

## Appendix (Additional assessments outside the scope of SCS 0108)

### Antenna Parameters with Head TSL

|                                      |                                |
|--------------------------------------|--------------------------------|
| Impedance, transformed to feed point | 52.0 $\Omega$ + 5.9 j $\Omega$ |
| Return Loss                          | - 24.4 dB                      |

### Antenna Parameters with Body TSL

|                                      |                                |
|--------------------------------------|--------------------------------|
| Impedance, transformed to feed point | 48.4 $\Omega$ + 7.1 j $\Omega$ |
| Return Loss                          | - 22.6 dB                      |

### General Antenna Parameters and Design

|                                  |          |
|----------------------------------|----------|
| Electrical Delay (one direction) | 1.198 ns |
|----------------------------------|----------|

After long term use with 100W radiated power, only a slight warming of the dipole near the feedpoint can be measured.

The dipole is made of standard semirigid coaxial cable. The center conductor of the feeding line is directly connected to the second arm of the dipole. The antenna is therefore short-circuited for DC-signals. On some of the dipoles, small end caps are added to the dipole arms in order to improve matching when loaded according to the position as explained in the "Measurement Conditions" paragraph. The SAR data are not affected by this change. The overall dipole length is still according to the Standard.

No excessive force must be applied to the dipole arms, because they might bend or the soldered connections near the feedpoint may be damaged.

### Additional EUT Data

|                 |                |
|-----------------|----------------|
| Manufactured by | SPEAG          |
| Manufactured on | March 11, 2011 |

# DASY5 Validation Report for Head TSL

Date: 21.06.2017

Test Laboratory: SPEAG, Zurich, Switzerland

**DUT: Dipole 1900 MHz; Type: D1900V2; Serial: D1900V2 - SN:5d142**

Communication System: UID 0 - CW; Frequency: 1900 MHz

Medium parameters used:  $f = 1900$  MHz;  $\sigma = 1.37$  S/m;  $\epsilon_r = 40.8$ ;  $\rho = 1000$  kg/m<sup>3</sup>

Phantom section: Flat Section

Measurement Standard: DASY5 (IEEE/IEC/ANSI C63.19-2011)

DASY52 Configuration:

- Probe: EX3DV4 - SN7349; ConvF(8.43, 8.43, 8.43); Calibrated: 31.05.2017;
- Sensor-Surface: 1.4mm (Mechanical Surface Detection)
- Electronics: DAE4 Sn601; Calibrated: 28.03.2017
- Phantom: Flat Phantom 5.0 (front); Type: QD 000 P50 AA; Serial: 1001
- DASY52 52.10.0(1446); SEMCAD X 14.6.10(7417)

## Dipole Calibration for Head Tissue/Pin=250 mW, d=10mm/Zoom Scan (7x7x7)/Cube 0:

Measurement grid: dx=5mm, dy=5mm, dz=5mm

Reference Value = 107.0 V/m; Power Drift = -0.04 dB

Peak SAR (extrapolated) = 18.3 W/kg

**SAR(1 g) = 9.89 W/kg; SAR(10 g) = 5.2 W/kg**

Maximum value of SAR (measured) = 15.0 W/kg

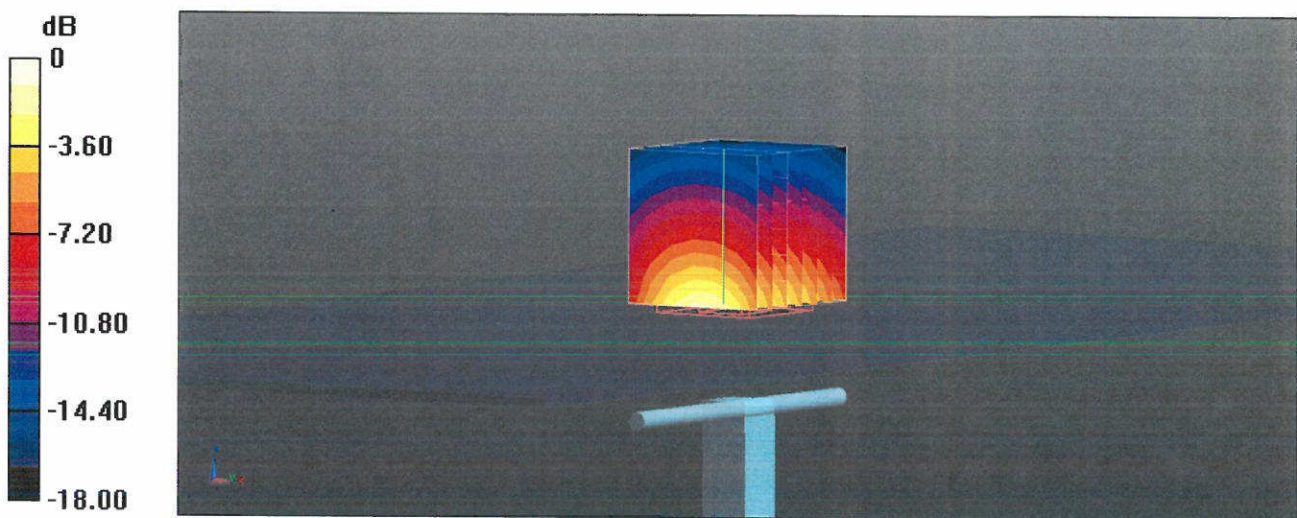

0 dB = 15.0 W/kg = 11.76 dBW/kg

# Impedance Measurement Plot for Head TSL

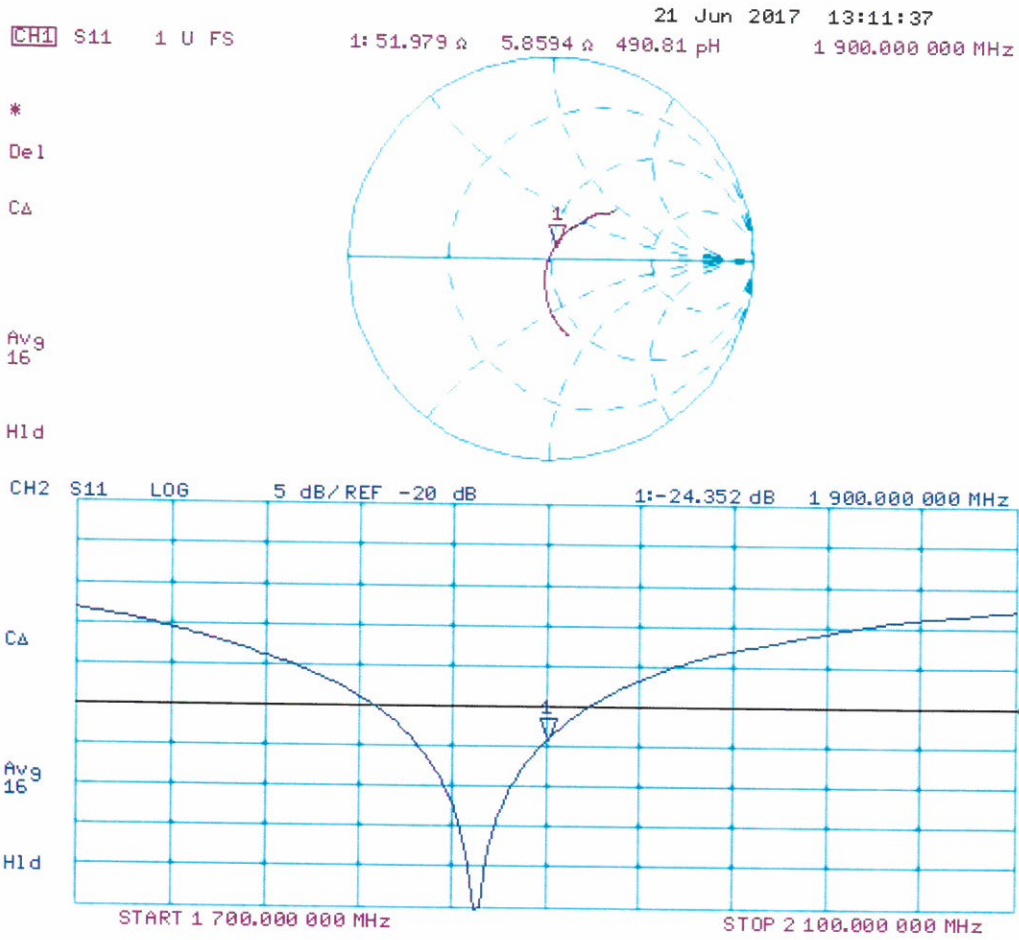

# DASY5 Validation Report for Body TSL

Date: 21.06.2017

Test Laboratory: SPEAG, Zurich, Switzerland

**DUT: Dipole 1900 MHz; Type: D1900V2; Serial: D1900V2 - SN:5d142**

Communication System: UID 0 - CW; Frequency: 1900 MHz

Medium parameters used:  $f = 1900$  MHz;  $\sigma = 1.49$  S/m;  $\epsilon_r = 54$ ;  $\rho = 1000$  kg/m<sup>3</sup>

Phantom section: Flat Section

Measurement Standard: DASY5 (IEEE/IEC/ANSI C63.19-2011)

DASY52 Configuration:

- Probe: EX3DV4 - SN7349; ConvF(8.2, 8.2, 8.2); Calibrated: 31.05.2017;
- Sensor-Surface: 1.4mm (Mechanical Surface Detection)
- Electronics: DAE4 Sn601; Calibrated: 28.03.2017
- Phantom: Flat Phantom 5.0 (back); Type: QD 000 P50 AA; Serial: 1002
- DASY52 52.10.0(1446); SEMCAD X 14.6.10(7417)

## Dipole Calibration for Body Tissue/Pin=250 mW, d=10mm/Zoom Scan (7x7x7)/Cube 0:

Measurement grid: dx=5mm, dy=5mm, dz=5mm

Reference Value = 102.7 V/m; Power Drift = -0.06 dB

Peak SAR (extrapolated) = 17.6 W/kg

**SAR(1 g) = 9.94 W/kg; SAR(10 g) = 5.28 W/kg**

Maximum value of SAR (measured) = 14.4 W/kg

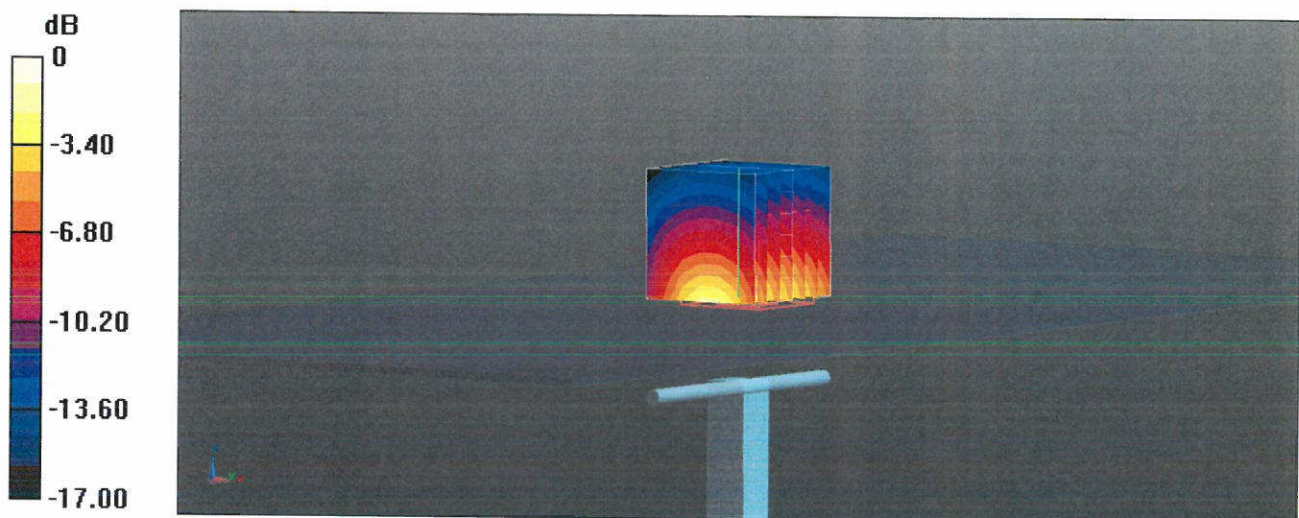

0 dB = 14.4 W/kg = 11.58 dBW/kg

# Impedance Measurement Plot for Body TSL

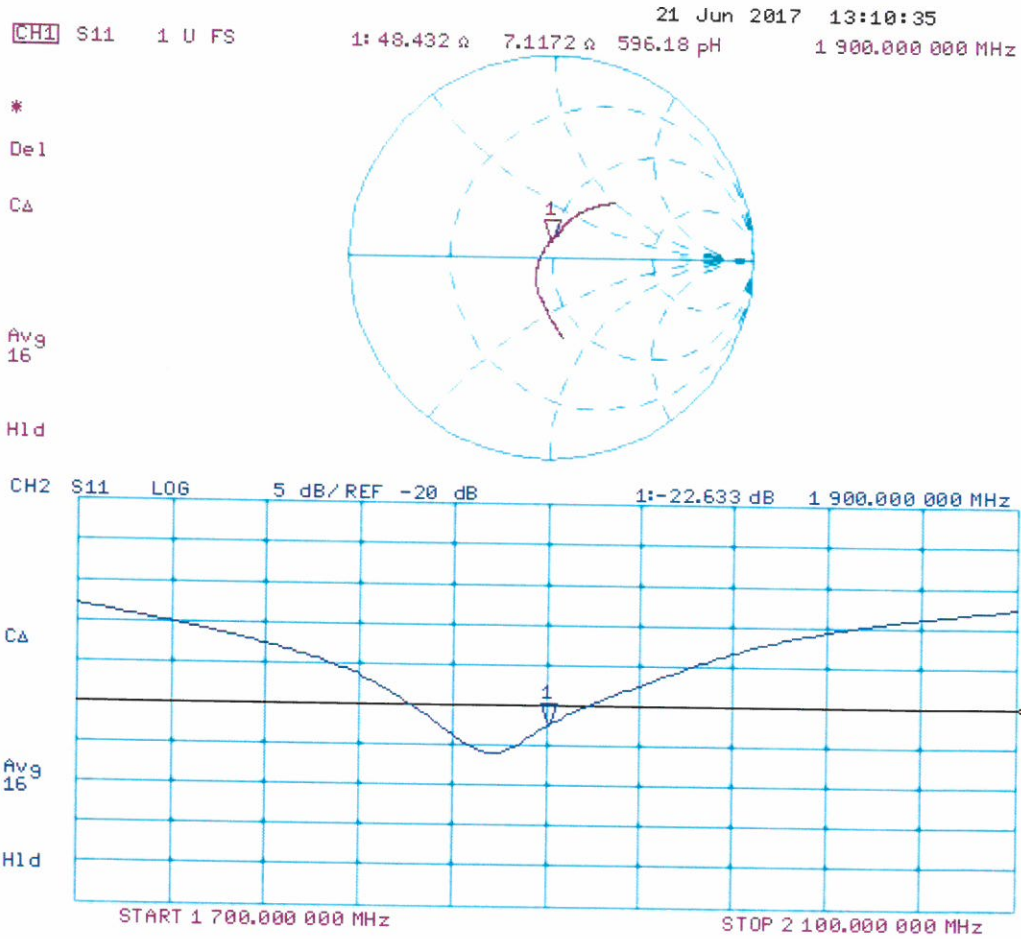



In Collaboration with  
**s p e a g**  
CALIBRATION LABORATORY



中国认可  
国际互认  
校准  
CALIBRATION  
CNAS L0570

Add: No.51 Xueyuan Road, Haidian District, Beijing, 100191, China  
Tel: +86-10-62304633-2079 Fax: +86-10-62304633-2504  
E-mail: cttl@chinattl.com http://www.chinattl.cn

Client

**Sporton International INC**

Certificate No:

**Z17-97126**

## CALIBRATION CERTIFICATE

Object: D2300V2 - SN: 1055

Calibration Procedure(s): FF-Z11-003-01  
Calibration Procedures for dipole validation kits

Calibration date: August 30, 2017

This calibration Certificate documents the traceability to national standards, which realize the physical units of measurements(SI). The measurements and the uncertainties with confidence probability are given on the following pages and are part of the certificate.

All calibrations have been conducted in the closed laboratory facility: environment temperature(22±3)°C and humidity<70%.

Calibration Equipment used (M&TE critical for calibration)

| Primary Standards       | ID #       | Cal Date(Calibrated by, Certificate No.) | Scheduled Calibration |
|-------------------------|------------|--|-----------------------|
| Power Meter NRVD        | 102083     | 22-Sep-16 (CTTL, No.J16X06809)           | Sep-17                |
| Power sensor NRV-Z5     | 100595     | 22-Sep-16 (CTTL, No.J16X06809)           | Sep-17                |
| Reference Probe EX3DV4  | SN 3617    | 23-Jan-17(SPEAG,No.EX3-3617_Jan17)       | Jan-18                |
| DAE4                    | SN 1331    | 19-Jan-17(CTTL-SPEAG,No.Z17-97015)       | Jan-18                |
| Secondary Standards     | ID #       | Cal Date(Calibrated by, Certificate No.) | Scheduled Calibration |
| Signal Generator E4438C | MY49071430 | 13-Jan-17 (CTTL, No.J17X00286)           | Jan-18                |
| Network Analyzer E5071C | MY46110673 | 13-Jan-17 (CTTL, No.J17X00285)           | Jan-18                |

|                | Name        | Function           | Signature |
|----------------|-------------|--------------------|-----------|
| Calibrated by: | Zhao Jing   | SAR Test Engineer  |           |
| Reviewed by:   | Yu Zongying | SAR Test Engineer  |           |
| Approved by:   | Qi Dianyuan | SAR Project Leader |           |

Issued: September 2, 2017

This calibration certificate shall not be reproduced except in full without written approval of the laboratory.



### Glossary:

|       |  |
|-------|--|
| TSL   | tissue simulating liquid                   |
| ConvF | sensitivity in TSL / NORM <sub>x,y,z</sub> |
| N/A   | not applicable or not measured             |

### Calibration is Performed According to the Following Standards:

- IEEE Std 1528-2013, "IEEE Recommended Practice for Determining the Peak Spatial-Averaged Specific Absorption Rate (SAR) in the Human Head from Wireless Communications Devices: Measurement Techniques", June 2013
- IEC 62209-1, "Measurement procedure for assessment of specific absorption rate of human exposure to radio frequency fields from hand-held and body-mounted wireless communication devices- Part 1: Device used next to the ear (Frequency range of 300MHz to 6GHz)", July 2016
- IEC 62209-2, "Procedure to measure the Specific Absorption Rate (SAR) For wireless communication devices used in close proximity to the human body (frequency range of 30MHz to 6GHz)", March 2010
- KDB865664, SAR Measurement Requirements for 100 MHz to 6 GHz

### Additional Documentation:

- DASY4/5 System Handbook

### Methods Applied and Interpretation of Parameters:

- Measurement Conditions:* Further details are available from the Validation Report at the end of the certificate. All figures stated in the certificate are valid at the frequency indicated.
- Antenna Parameters with TSL:* The dipole is mounted with the spacer to position its feed point exactly below the center marking of the flat phantom section, with the arms oriented parallel to the body axis.
- Feed Point Impedance and Return Loss:* These parameters are measured with the dipole positioned under the liquid filled phantom. The impedance stated is transformed from the measurement at the SMA connector to the feed point. The Return Loss ensures low reflected power. No uncertainty required.
- Electrical Delay:* One-way delay between the SMA connector and the antenna feed point. No uncertainty required.
- SAR measured:* SAR measured at the stated antenna input power.
- SAR normalized:* SAR as measured, normalized to an input power of 1 W at the antenna connector.
- SAR for nominal TSL parameters:* The measured TSL parameters are used to calculate the nominal SAR result.

The reported uncertainty of measurement is stated as the standard uncertainty of Measurement multiplied by the coverage factor  $k=2$ , which for a normal distribution Corresponds to a coverage probability of approximately 95%.





Add: No.51 Xueyuan Road, Haidian District, Beijing, 100191, China  
 Tel: +86-10-62304633-2079 Fax: +86-10-62304633-2504  
 E-mail: cttl@chinattl.com http://www.chinattl.cn

### Measurement Conditions

DASY system configuration, as far as not given on page 1.

|                                     |                          |              |
|-------------------------------------|--------------------------|--------------|
| <b>DASY Version</b>                 | DASY52                   | 52.10.0.1446 |
| <b>Extrapolation</b>                | Advanced Extrapolation   |              |
| <b>Phantom</b>                      | Triple Flat Phantom 5.1C |              |
| <b>Distance Dipole Center - TSL</b> | 10 mm                    | with Spacer  |
| <b>Zoom Scan Resolution</b>         | dx, dy, dz = 5 mm        |              |
| <b>Frequency</b>                    | 2300 MHz ± 1 MHz         |              |

### Head TSL parameters

The following parameters and calculations were applied.

|  | Temperature     | Permittivity | Conductivity     |
|--|-----------------|--------------|------------------|
| <b>Nominal Head TSL parameters</b>             | 22.0 °C         | 39.5         | 1.67 mho/m       |
| <b>Measured Head TSL parameters</b>            | (22.0 ± 0.2) °C | 39.3 ± 6 %   | 1.69 mho/m ± 6 % |
| <b>Head TSL temperature change during test</b> | <1.0 °C         | ----         | ----             |

### SAR result with Head TSL

|   |                    |                                  |
|---|--------------------|----------------------------------|
| <b>SAR averaged over 1 cm<sup>3</sup> (1 g) of Head TSL</b>   | Condition          |                                  |
| SAR measured  | 250 mW input power | 12.4 mW / g                      |
| SAR for nominal Head TSL parameters                           | normalized to 1W   | <b>49.3 mW /g ± 18.8 % (k=2)</b> |
| <b>SAR averaged over 10 cm<sup>3</sup> (10 g) of Head TSL</b> | Condition          |                                  |
| SAR measured  | 250 mW input power | 5.91 mW / g                      |
| SAR for nominal Head TSL parameters                           | normalized to 1W   | <b>23.6 mW /g ± 18.7 % (k=2)</b> |

### Body TSL parameters

The following parameters and calculations were applied.

|  | Temperature     | Permittivity | Conductivity     |
|--|-----------------|--------------|------------------|
| <b>Nominal Body TSL parameters</b>             | 22.0 °C         | 52.9         | 1.81 mho/m       |
| <b>Measured Body TSL parameters</b>            | (22.0 ± 0.2) °C | 52.5 ± 6 %   | 1.80 mho/m ± 6 % |
| <b>Body TSL temperature change during test</b> | <1.0 °C         | ----         | ----             |

### SAR result with Body TSL

|   |                    |                                  |
|---|--------------------|----------------------------------|
| <b>SAR averaged over 1 cm<sup>3</sup> (1 g) of Body TSL</b>   | Condition          |                                  |
| SAR measured  | 250 mW input power | 12.2 mW / g                      |
| SAR for nominal Body TSL parameters                           | normalized to 1W   | <b>48.9 mW /g ± 18.8 % (k=2)</b> |
| <b>SAR averaged over 10 cm<sup>3</sup> (10 g) of Body TSL</b> | Condition          |                                  |
| SAR measured  | 250 mW input power | 5.82 mW / g                      |
| SAR for nominal Body TSL parameters                           | normalized to 1W   | <b>23.3 mW /g ± 18.7 % (k=2)</b> |



Add: No.51 Xueyuan Road, Haidian District, Beijing, 100191, China  
Tel: +86-10-62304633-2079 Fax: +86-10-62304633-2504  
E-mail: cttl@chinattl.com http://www.chinattl.cn

### Appendix(Additional assessments outside the scope of CNAS L0570)

#### Antenna Parameters with Head TSL

|                                      |               |
|--------------------------------------|---------------|
| Impedance, transformed to feed point | 48.6Ω- 3.86jΩ |
| Return Loss                          | - 27.6dB      |

#### Antenna Parameters with Body TSL

|                                      |               |
|--------------------------------------|---------------|
| Impedance, transformed to feed point | 45.9Ω- 3.37jΩ |
| Return Loss                          | - 25.2dB      |

#### General Antenna Parameters and Design

|                                  |          |
|----------------------------------|----------|
| Electrical Delay (one direction) | 1.275 ns |
|----------------------------------|----------|

After long term use with 100W radiated power, only a slight warming of the dipole near the feedpoint can be measured.

The dipole is made of standard semirigid coaxial cable. The center conductor of the feeding line is directly connected to the second arm of the dipole. The antenna is therefore short-circuited for DC-signals. On some of the dipoles, small end caps are added to the dipole arms in order to improve matching when loaded according to the position as explained in the "Measurement Conditions" paragraph. The SAR data are not affected by this change. The overall dipole length is still according to the Standard.

No excessive force must be applied to the dipole arms, because they might bend or the soldered connections near the feedpoint may be damaged.

#### Additional EUT Data

|                 |       |
|-----------------|-------|
| Manufactured by | SPEAG |
|-----------------|-------|



Add: No.51 Xueyuan Road, Haidian District, Beijing, 100191, China  
Tel: +86-10-62304633-2079 Fax: +86-10-62304633-2504  
E-mail: cttl@chinattl.com http://www.chinattl.cn

**DASY5 Validation Report for Head TSL**

Date: 08.30.2017

Test Laboratory: CTTL, Beijing, China

**DUT: Dipole 2300 MHz; Type: D2300V2; Serial: D2300V2 - SN: 1055**

Communication System: UID 0, CW; Frequency: 2300 MHz; Duty Cycle: 1:1

Medium parameters used:  $f = 2300$  MHz;  $\sigma = 1.688$  S/m;  $\epsilon_r = 39.32$ ;  $\rho = 1000$  kg/m<sup>3</sup>

Phantom section: Left Section

Measurement Standard: DASY5 (IEEE/IEC/ANSI C63.19-2007)

DASY5 Configuration:

- Probe: EX3DV4 - SN3617; ConvF(7.87, 7.87, 7.87); Calibrated: 1/23/2017;
- Sensor-Surface: 1.4mm (Mechanical Surface Detection)
- Electronics: DAE4 Sn1331; Calibrated: 1/19/2017
- Phantom: Triple Flat Phantom 5.1C; Type: QD 000 P51 CA; Serial: 1161/1
- Measurement SW: DASY52, Version 52.10 (0); SEMCAD X Version 14.6.10 (7417)

**Dipole Calibration/Zoom Scan (7x7x7) (7x7x7)/Cube 0:** Measurement grid: dx=5mm, dy=5mm, dz=5mm

Reference Value = 105.2 V/m; Power Drift = 0.00 dB

Peak SAR (extrapolated) = 24.9 W/kg

**SAR(1 g) = 12.4 W/kg; SAR(10 g) = 5.91 W/kg**

Maximum value of SAR (measured) = 20.3 W/kg

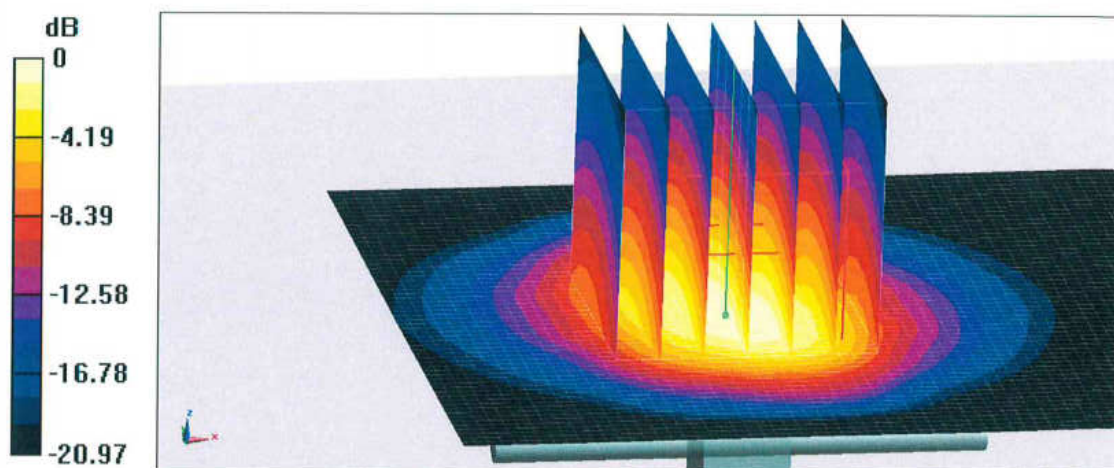

0 dB = 20.3 W/kg = 13.07 dBW/kg



Add: No.51 Xueyuan Road, Haidian District, Beijing, 100191, China  
Tel: +86-10-62304633-2079 Fax: +86-10-62304633-2504  
E-mail: cttl@chinattl.com http://www.chinattl.cn

### Impedance Measurement Plot for Head TSL

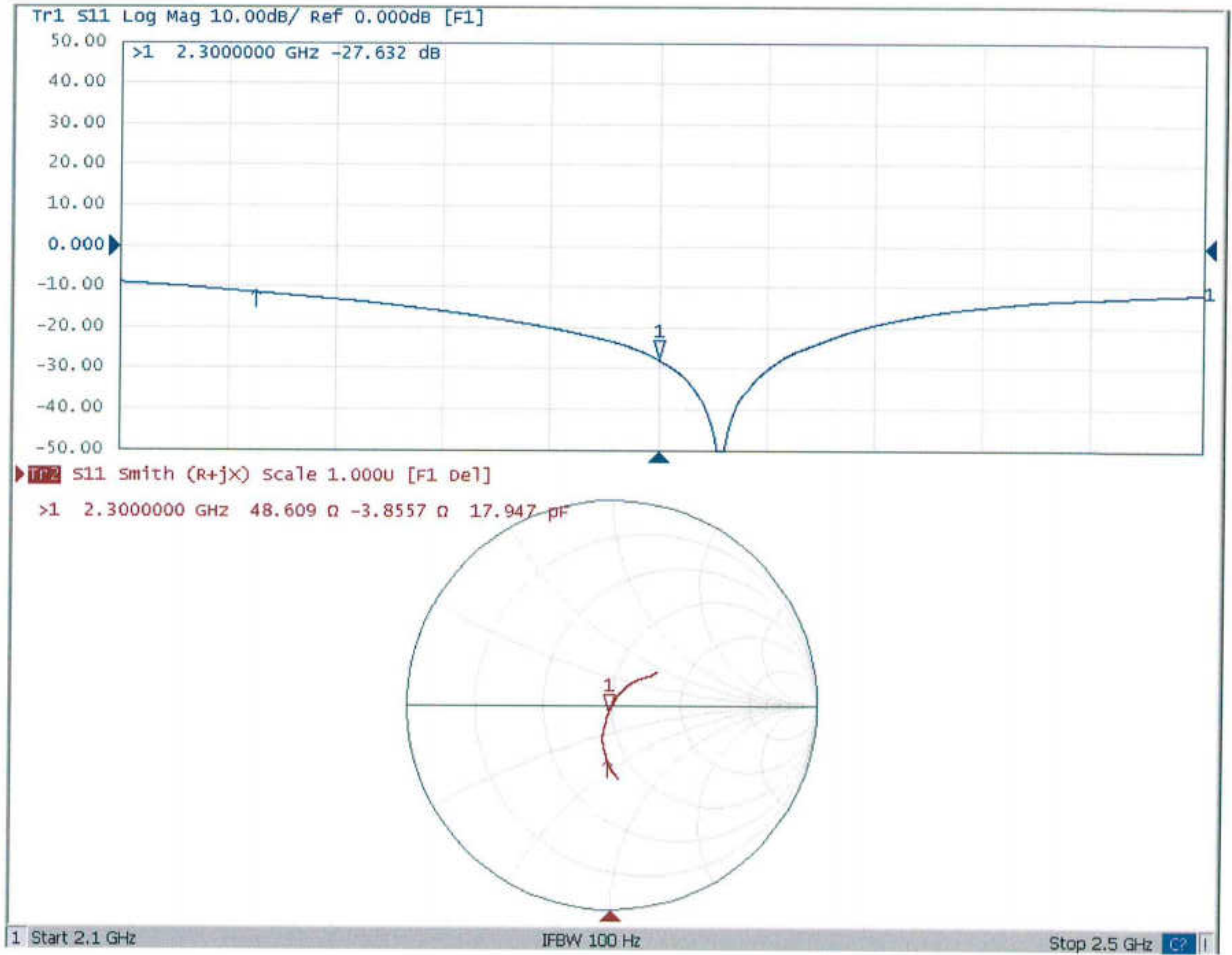



Add: No.51 Xueyuan Road, Haidian District, Beijing, 100191, China  
Tel: +86-10-62304633-2079 Fax: +86-10-62304633-2504  
E-mail: cttl@chinattl.com http://www.chinattl.cn

**DASY5 Validation Report for Body TSL**

Date: 08.30.2017

Test Laboratory: CTTL, Beijing, China

**DUT: Dipole 2300 MHz; Type: D2300V2; Serial: D2300V2 - SN: 1055**

Communication System: UID 0, CW; Frequency: 2300 MHz; Duty Cycle: 1:1

Medium parameters used:  $f = 2300$  MHz;  $\sigma = 1.8$  S/m;  $\epsilon_r = 52.46$ ;  $\rho = 1000$  kg/m<sup>3</sup>

Phantom section: Right Section

Measurement Standard: DASY5 (IEEE/IEC/ANSI C63.19-2007)

DASY5 Configuration:

- Probe: EX3DV4 - SN3617; ConvF(7.87, 7.87, 7.87); Calibrated: 1/23/2017;
- Sensor-Surface: 1.4mm (Mechanical Surface Detection)
- Electronics: DAE4 Sn1331; Calibrated: 1/19/2017
- Phantom: Triple Flat Phantom 5.1C; Type: QD 000 P51 CA; Serial: 1161/1
- Measurement SW: DASY52, Version 52.10 (0); SEMCAD X Version 14.6.10 (7417)

**Dipole Calibration/Zoom Scan (7x7x7) (7x7x7)/Cube 0:** Measurement grid: dx=5mm, dy=5mm, dz=5mm

Reference Value = 60.83 V/m; Power Drift = -0.00 dB

Peak SAR (extrapolated) = 24.2 W/kg

**SAR(1 g) = 12.2 W/kg; SAR(10 g) = 5.82 W/kg**

Maximum value of SAR (measured) = 19.7 W/kg

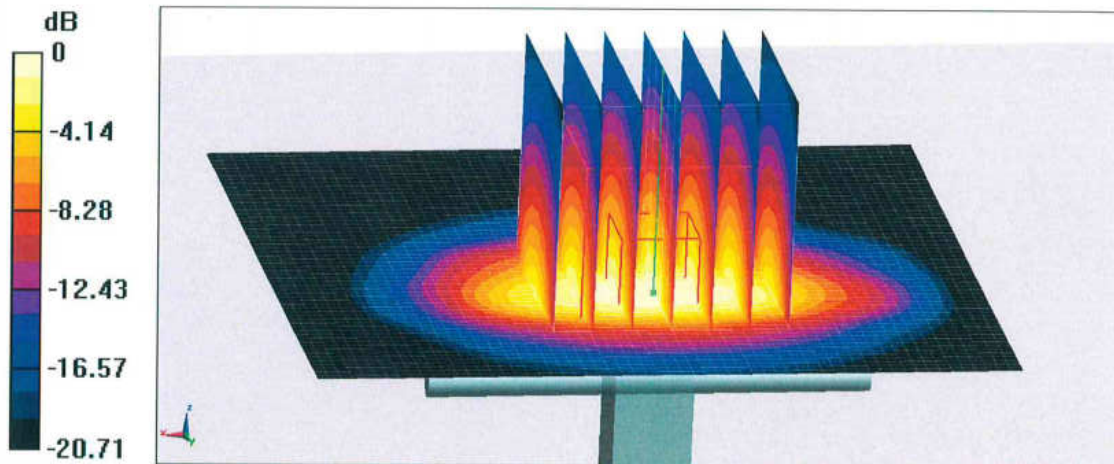

**0 dB = 19.7 W/kg = 12.94 dBW/kg**



Add: No.51 Xueyuan Road, Haidian District, Beijing, 100191, China  
Tel: +86-10-62304633-2079 Fax: +86-10-62304633-2504  
E-mail: cttl@chinattl.com http://www.chinattl.cn

### Impedance Measurement Plot for Body TSL

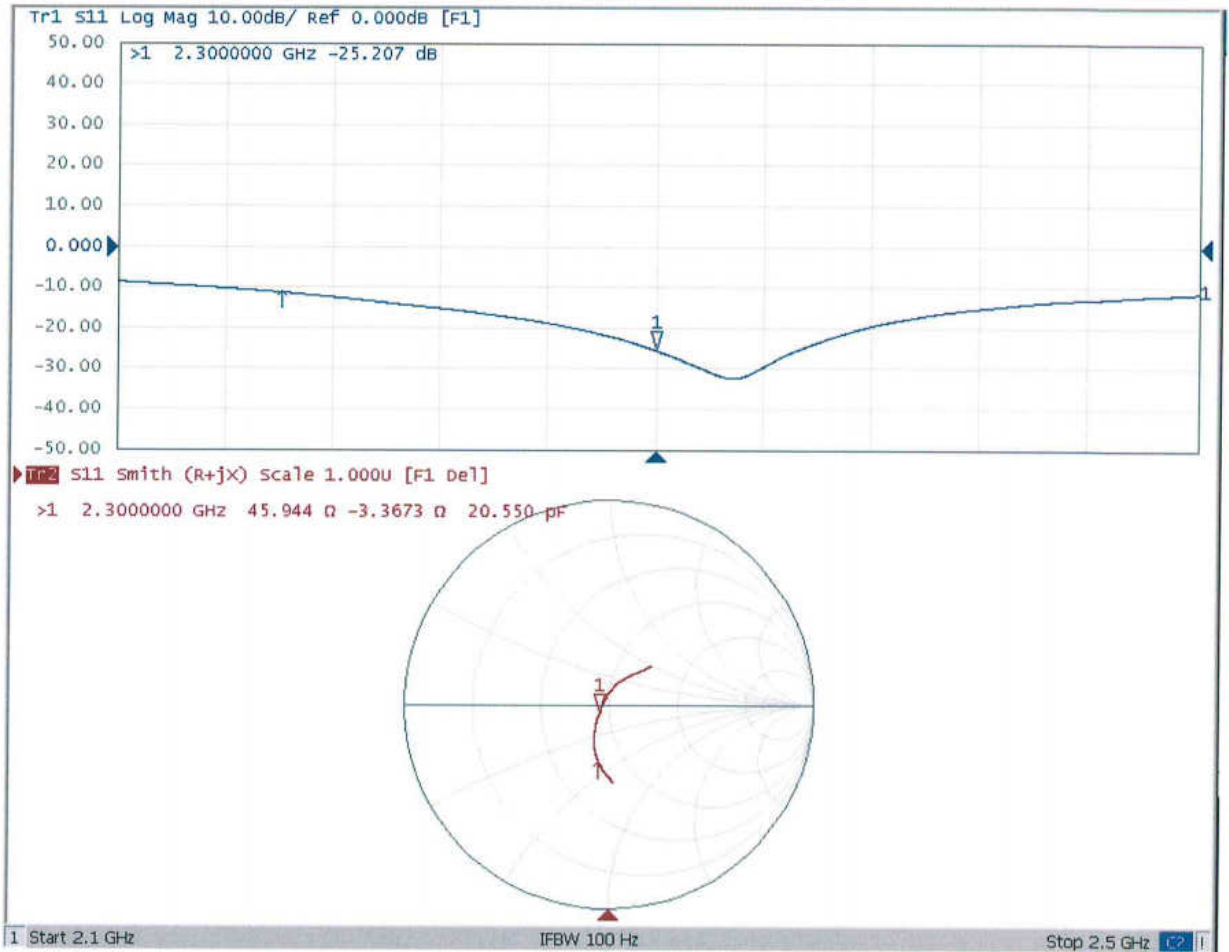



In Collaboration with  
**s p e a g**  
 CALIBRATION LABORATORY



中国认可  
 国际互认  
 校准  
 CALIBRATION  
 CNAS L0570

Add: No.51 Xueyuan Road, Haidian District, Beijing, 100191, China  
 Tel: +86-10-62304633-2079 Fax: +86-10-62304633-2504  
 E-mail: cttl@chinattl.com http://www.chinattl.cn

Client

**Sporton\_XA**

Certificate No:

**Z17-97043**

## CALIBRATION CERTIFICATE

Object

D2450V2 - SN: 908

Calibration Procedure(s)

FD-Z11-003-01

Calibration Procedures for dipole validation kits

Calibration date:

March 21, 2017

This calibration Certificate documents the traceability to national standards, which realize the physical units of measurements(SI). The measurements and the uncertainties with confidence probability are given on the following pages and are part of the certificate.

All calibrations have been conducted in the closed laboratory facility: environment temperature(22±3)°C and humidity<70%.

Calibration Equipment used (M&TE critical for calibration)

| Primary Standards       | ID #       | Cal Date(Calibrated by, Certificate No.) | Scheduled Calibration |
|-------------------------|------------|--|-----------------------|
| Power Meter NRP2        | 101919     | 27-Jun-16 (CTTL, No.J16X04777)           | Jun-17                |
| Power sensor NRP-Z91    | 101547     | 27-Jun-16 (CTTL, No.J16X04777)           | Jun-17                |
| Reference Probe EX3DV4  | SN 3617    | 23-Jan-17(SPEAG,No.EX3-3617_Jan17)       | Jan-18                |
| DAE4                    | SN 777     | 22-Aug-16(CTTL-SPEAG,No.Z16-97138)       | Aug-17                |
| Secondary Standards     | ID #       | Cal Date(Calibrated by, Certificate No.) | Scheduled Calibration |
| Signal Generator E4438C | MY49071430 | 13-Jan-17 (CTTL, No.J17X00286)           | Jan-18                |
| Network Analyzer E5071C | MY46110673 | 13-Jan-17 (CTTL, No.J17X00285)           | Jan-18                |

|                | Name        | Function                          | Signature |
|----------------|-------------|-----------------------------------|-----------|
| Calibrated by: | Zhao Jing   | SAR Test Engineer                 |           |
| Reviewed by:   | Qi Dianyuan | SAR Project Leader                |           |
| Approved by:   | Lu Bingsong | Deputy Director of the laboratory |           |

Issued: March 26, 2017

This calibration certificate shall not be reproduced except in full without written approval of the laboratory.



**Glossary:**

|       |  |
|-------|--|
| TSL   | tissue simulating liquid                   |
| ConvF | sensitivity in TSL / NORM <sub>x,y,z</sub> |
| N/A   | not applicable or not measured             |

**Calibration is Performed According to the Following Standards:**

- IEEE Std 1528-2013, "IEEE Recommended Practice for Determining the Peak Spatial-Averaged Specific Absorption Rate (SAR) in the Human Head from Wireless Communications Devices: Measurement Techniques", June 2013
- IEC 62209-1, "Procedure to measure the Specific Absorption Rate (SAR) For hand-held devices used in close proximity to the ear (frequency range of 300MHz to 3GHz)", February 2005
- IEC 62209-2, "Procedure to measure the Specific Absorption Rate (SAR) For wireless communication devices used in close proximity to the human body (frequency range of 30MHz to 6GHz)", March 2010
- KDB865664, SAR Measurement Requirements for 100 MHz to 6 GHz

**Additional Documentation:**

- DASY4/5 System Handbook

**Methods Applied and Interpretation of Parameters:**

- Measurement Conditions:* Further details are available from the Validation Report at the end of the certificate. All figures stated in the certificate are valid at the frequency indicated.
- Antenna Parameters with TSL:* The dipole is mounted with the spacer to position its feed point exactly below the center marking of the flat phantom section, with the arms oriented parallel to the body axis.
- Feed Point Impedance and Return Loss:* These parameters are measured with the dipole positioned under the liquid filled phantom. The impedance stated is transformed from the measurement at the SMA connector to the feed point. The Return Loss ensures low reflected power. No uncertainty required.
- Electrical Delay:* One-way delay between the SMA connector and the antenna feed point. No uncertainty required.
- SAR measured:* SAR measured at the stated antenna input power.
- SAR normalized:* SAR as measured, normalized to an input power of 1 W at the antenna connector.
- SAR for nominal TSL parameters:* The measured TSL parameters are used to calculate the nominal SAR result.

The reported uncertainty of measurement is stated as the standard uncertainty of Measurement multiplied by the coverage factor  $k=2$ , which for a normal distribution Corresponds to a coverage probability of approximately 95%.





### Measurement Conditions

DASY system configuration, as far as not given on page 1.

|                                     |                          |             |
|-------------------------------------|--------------------------|-------------|
| <b>DASY Version</b>                 | DASY52                   | 52.8.8.1258 |
| <b>Extrapolation</b>                | Advanced Extrapolation   |             |
| <b>Phantom</b>                      | Triple Flat Phantom 5.1C |             |
| <b>Distance Dipole Center - TSL</b> | 10 mm                    | with Spacer |
| <b>Zoom Scan Resolution</b>         | dx, dy, dz = 5 mm        |             |
| <b>Frequency</b>                    | 2450 MHz ± 1 MHz         |             |

### Head TSL parameters

The following parameters and calculations were applied.

|  | Temperature     | Permittivity | Conductivity     |
|--|-----------------|--------------|------------------|
| <b>Nominal Head TSL parameters</b>             | 22.0 °C         | 39.2         | 1.80 mho/m       |
| <b>Measured Head TSL parameters</b>            | (22.0 ± 0.2) °C | 39.0 ± 6 %   | 1.77 mho/m ± 6 % |
| <b>Head TSL temperature change during test</b> | <1.0 °C         | ----         | ----             |

### SAR result with Head TSL

|   |                    |                                   |
|---|--------------------|-----------------------------------|
| <b>SAR averaged over 1 cm<sup>3</sup> (1 g) of Head TSL</b>   | Condition          |                                   |
| SAR measured  | 250 mW input power | 13.2 mW / g                       |
| SAR for nominal Head TSL parameters                           | normalized to 1W   | <b>53.2 mW / g ± 20.8 % (k=2)</b> |
| <b>SAR averaged over 10 cm<sup>3</sup> (10 g) of Head TSL</b> | Condition          |                                   |
| SAR measured  | 250 mW input power | 6.13 mW / g                       |
| SAR for nominal Head TSL parameters                           | normalized to 1W   | <b>24.6 mW / g ± 20.4 % (k=2)</b> |

### Body TSL parameters

The following parameters and calculations were applied.

|  | Temperature     | Permittivity | Conductivity     |
|--|-----------------|--------------|------------------|
| <b>Nominal Body TSL parameters</b>             | 22.0 °C         | 52.7         | 1.95 mho/m       |
| <b>Measured Body TSL parameters</b>            | (22.0 ± 0.2) °C | 52.3 ± 6 %   | 1.93 mho/m ± 6 % |
| <b>Body TSL temperature change during test</b> | <1.0 °C         | ----         | ----             |

### SAR result with Body TSL

|   |                    |                                   |
|---|--------------------|-----------------------------------|
| <b>SAR averaged over 1 cm<sup>3</sup> (1 g) of Body TSL</b>   | Condition          |                                   |
| SAR measured  | 250 mW input power | 12.7 mW / g                       |
| SAR for nominal Body TSL parameters                           | normalized to 1W   | <b>50.9 mW / g ± 20.8 % (k=2)</b> |
| <b>SAR averaged over 10 cm<sup>3</sup> (10 g) of Body TSL</b> | Condition          |                                   |
| SAR measured  | 250 mW input power | 5.88 mW / g                       |
| SAR for nominal Body TSL parameters                           | normalized to 1W   | <b>23.6 mW / g ± 20.4 % (k=2)</b> |



## Appendix (Additional assessments outside the scope of CNAS L0570)

### Antenna Parameters with Head TSL

|                                      |               |
|--------------------------------------|---------------|
| Impedance, transformed to feed point | 55.5Ω+ 2.35jΩ |
| Return Loss                          | - 24.9dB      |

### Antenna Parameters with Body TSL

|                                      |               |
|--------------------------------------|---------------|
| Impedance, transformed to feed point | 52.5Ω+ 2.12jΩ |
| Return Loss                          | - 30.0dB      |

### General Antenna Parameters and Design

|                                  |          |
|----------------------------------|----------|
| Electrical Delay (one direction) | 1.261 ns |
|----------------------------------|----------|

After long term use with 100W radiated power, only a slight warming of the dipole near the feedpoint can be measured.

The dipole is made of standard semirigid coaxial cable. The center conductor of the feeding line is directly connected to the second arm of the dipole. The antenna is therefore short-circuited for DC-signals. On some of the dipoles, small end caps are added to the dipole arms in order to improve matching when loaded according to the position as explained in the "Measurement Conditions" paragraph. The SAR data are not affected by this change. The overall dipole length is still according to the Standard. No excessive force must be applied to the dipole arms, because they might bend or the soldered connections near the feedpoint may be damaged.

### Additional EUT Data

|                 |       |
|-----------------|-------|
| Manufactured by | SPEAG |
|-----------------|-------|



### DASY5 Validation Report for Head TSL

Date: 03.21.2017

Test Laboratory: CTTL, Beijing, China

**DUT: Dipole 2450 MHz; Type: D2450V2; Serial: D2450V2 - SN: 908**

Communication System: UID 0, CW; Frequency: 2450 MHz; Duty Cycle: 1:1

Medium parameters used:  $f = 2450$  MHz;  $\sigma = 1.768$  S/m;  $\epsilon_r = 39.02$ ;  $\rho = 1000$  kg/m<sup>3</sup>

Phantom section: Right Section

Measurement Standard: DASY5 (IEEE/IEC/ANSI C63.19-2007)

DASY5 Configuration:

- Probe: EX3DV4 - SN3617; ConvF(7.74, 7.74, 7.74); Calibrated: 1/23/2017;
- Sensor-Surface: 1.4mm (Mechanical Surface Detection)
- Electronics: DAE4 Sn777; Calibrated: 8/22/2016
- Phantom: Triple Flat Phantom 5.1C; Type: QD 000 P51 CA; Serial: 1161/1
- Measurement SW: DASY52, Version 52.8 (8); SEMCAD X Version 14.6.10 (7372)

**Dipole Calibration/Zoom Scan (7x7x7) (7x7x7)/Cube 0:** Measurement grid: dx=5mm, dy=5mm, dz=5mm

Reference Value = 104.7 V/m; Power Drift = 0.04 dB

Peak SAR (extrapolated) = 27.4 W/kg

**SAR(1 g) = 13.2 W/kg; SAR(10 g) = 6.13 W/kg**

Maximum value of SAR (measured) = 22.0 W/kg

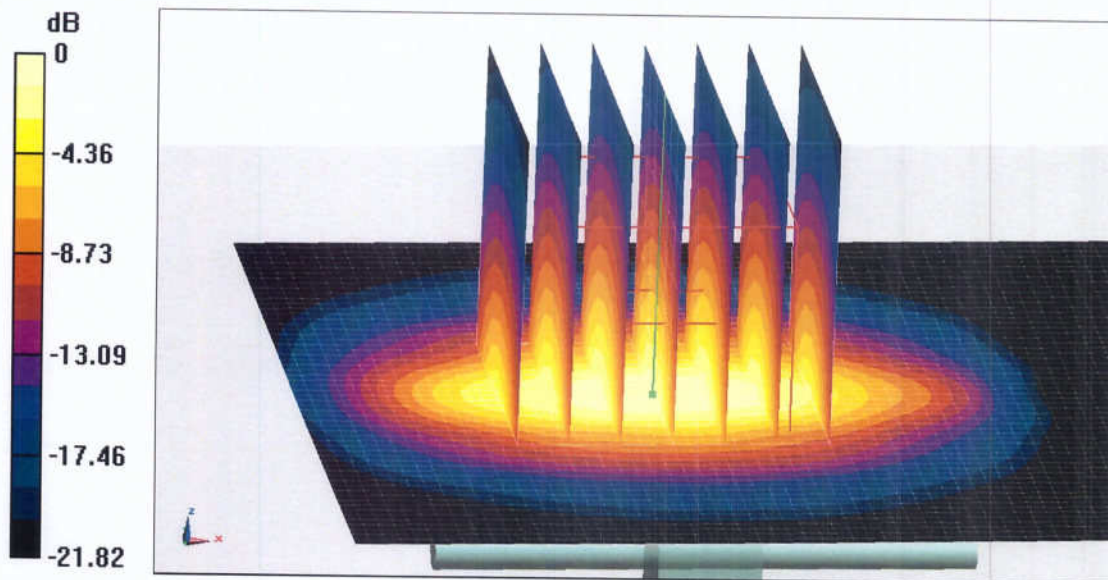

0 dB = 22.0 W/kg = 13.42 dBW/kg



Add: No.51 Xueyuan Road, Haidian District, Beijing, 100191, China  
Tel: +86-10-62304633-2079 Fax: +86-10-62304633-2504  
E-mail: cttl@chinattl.com http://www.chinattl.cn

### Impedance Measurement Plot for Head TSL

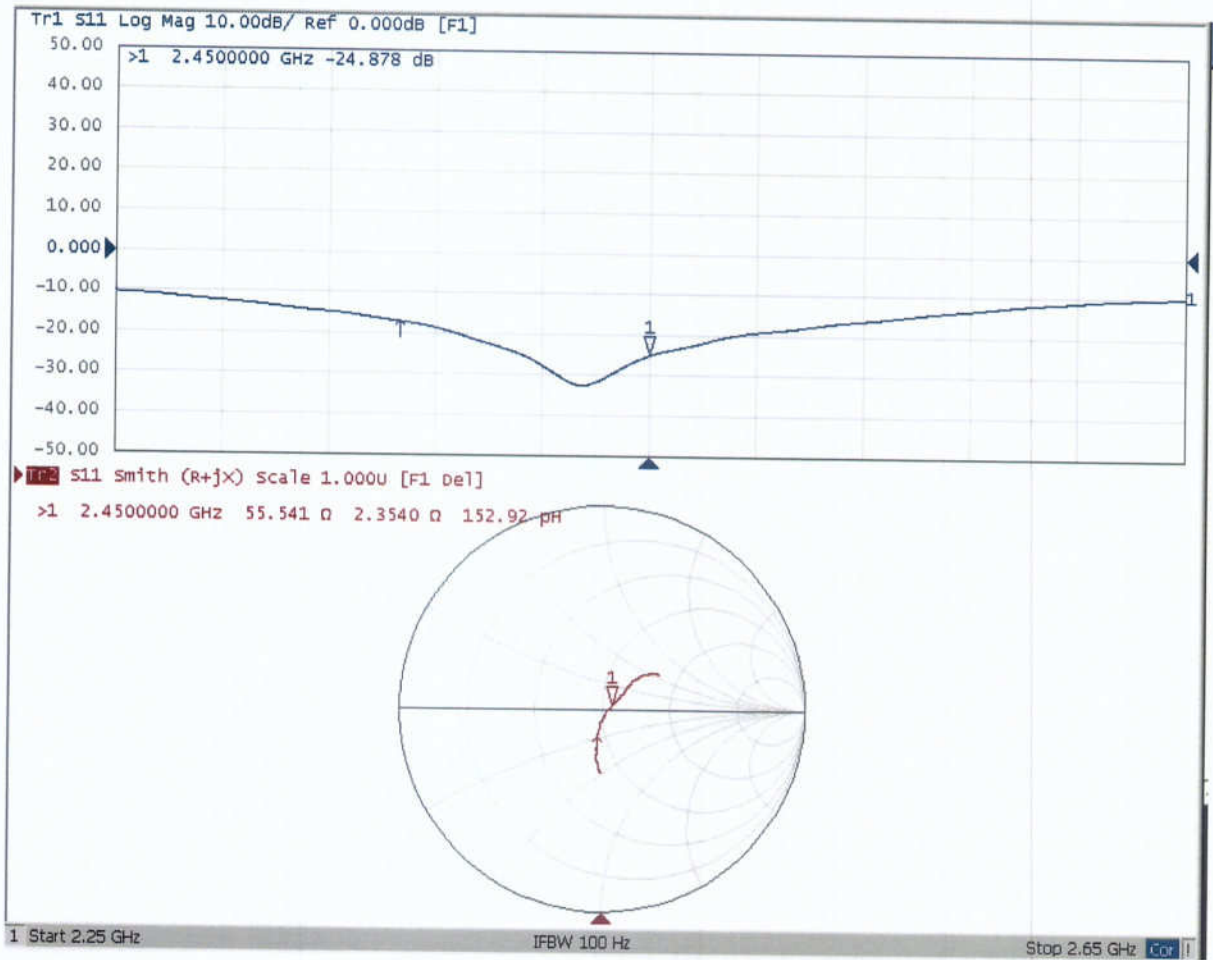



Add: No.51 Xueyuan Road, Haidian District, Beijing, 100191, China  
Tel: +86-10-62304633-2079 Fax: +86-10-62304633-2504  
E-mail: cttl@chinattl.com http://www.chinattl.cn

**DASY5 Validation Report for Body TSL**

Date: 03.21.2017

Test Laboratory: CTTL, Beijing, China

**DUT: Dipole 2450 MHz; Type: D2450V2; Serial: D2450V2 - SN: 908**

Communication System: UID 0, CW; Frequency: 2450 MHz; Duty Cycle: 1:1

Medium parameters used:  $f = 2450$  MHz;  $\sigma = 1.931$  S/m;  $\epsilon_r = 52.27$ ;  $\rho = 1000$  kg/m<sup>3</sup>

Phantom section: Center Section

Measurement Standard: DASY5 (IEEE/IEC/ANSI C63.19-2007)

DASY5 Configuration:

- Probe: EX3DV4 - SN3617; ConvF(7.8, 7.8, 7.8); Calibrated: 1/23/2017;
- Sensor-Surface: 1.4mm (Mechanical Surface Detection)
- Electronics: DAE4 Sn777; Calibrated: 8/22/2016
- Phantom: Triple Flat Phantom 5.1C; Type: QD 000 P51 CA; Serial: 1161/1
- Measurement SW: DASY52, Version 52.8 (8); SEMCAD X Version 14.6.10 (7372)

**Dipole Calibration/Zoom Scan (7x7x7) (7x7x7)/Cube 0:** Measurement grid: dx=5mm, dy=5mm, dz=5mm

Reference Value = 97.13 V/m; Power Drift = 0.01 dB

Peak SAR (extrapolated) = 27.0 W/kg

**SAR(1 g) = 12.7 W/kg; SAR(10 g) = 5.88 W/kg**

Maximum value of SAR (measured) = 21.7 W/kg

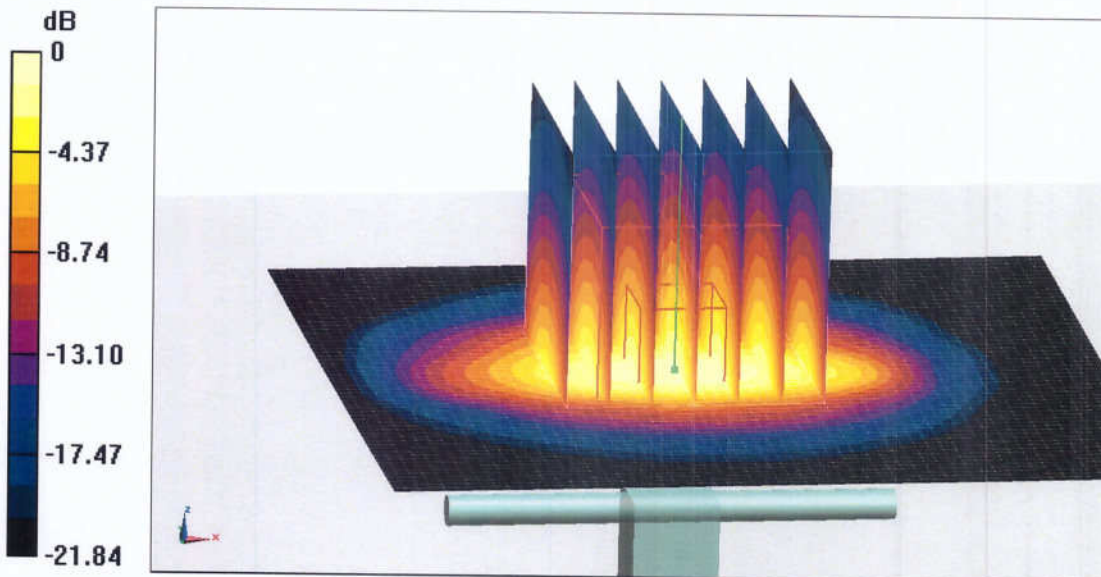

0 dB = 21.7 W/kg = 13.36 dBW/kg



Add: No.51 Xueyuan Road, Haidian District, Beijing, 100191, China  
Tel: +86-10-62304633-2079 Fax: +86-10-62304633-2504  
E-mail: cttl@chinattl.com http://www.chinattl.cn

### Impedance Measurement Plot for Body TSL

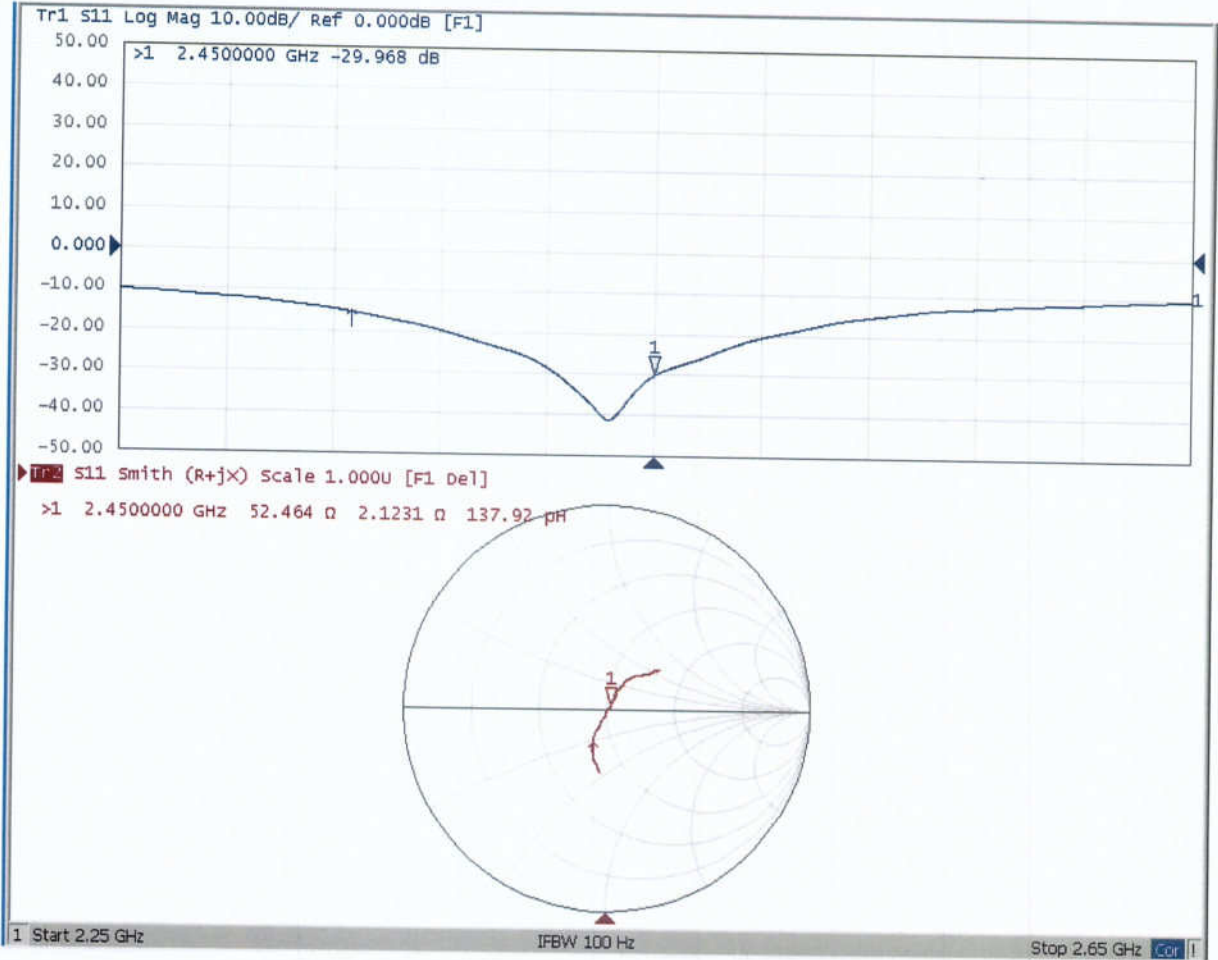



In Collaboration with  
**s p e a g**  
 CALIBRATION LABORATORY



中国认可  
 国际互认  
 校准  
 CALIBRATION  
 CNAS L0570

Add: No.51 Xueyuan Road, Haidian District, Beijing, 100191, China  
 Tel: +86-10-62304633-2079 Fax: +86-10-62304633-2504  
 E-mail: cttl@chinattl.com http://www.chinattl.cn

Client **Sporton International INC**

Certificate No: **Z17-97161**

# CALIBRATION CERTIFICATE

Object **D2600V2 - SN: 1112**

Calibration Procedure(s) **FF-Z11-003-01**  
**Calibration Procedures for dipole validation kits**

Calibration date: **September 18, 2017**

This calibration Certificate documents the traceability to national standards, which realize the physical units of measurements(SI). The measurements and the uncertainties with confidence probability are given on the following pages and are part of the certificate.

All calibrations have been conducted in the closed laboratory facility: environment temperature(22±3)°C and humidity<70%.

Calibration Equipment used (M&TE critical for calibration)

| Primary Standards       | ID #       | Cal Date(Calibrated by, Certificate No.) | Scheduled Calibration |
|-------------------------|------------|--|-----------------------|
| Power Meter NRVD        | 102196     | 02-Mar-17 (CTTL, No.J17X01254)           | Mar-18                |
| Power sensor NRV-Z5     | 100596     | 02-Mar-17 (CTTL, No.J17X01254)           | Mar-18                |
| Reference Probe EX3DV4  | SN 7433    | 26-Sep-16(SPEAG,No.EX3-7433_Sep16)       | Sep-17                |
| DAE4                    | SN 1331    | 19-Jan-17(CTTL-SPEAG,No.Z17-97015)       | Jan-18                |
| Secondary Standards     | ID #       | Cal Date(Calibrated by, Certificate No.) | Scheduled Calibration |
| Signal Generator E4438C | MY49071430 | 13-Jan-17 (CTTL, No.J17X00286)           | Jan-18                |
| Network Analyzer E5071C | MY46110673 | 13-Jan-17 (CTTL, No.J17X00285)           | Jan-18                |

|                | Name        | Function           | Signature |
|----------------|-------------|--------------------|-----------|
| Calibrated by: | Zhao Jing   | SAR Test Engineer  |           |
| Reviewed by:   | Yu Zongying | SAR Test Engineer  |           |
| Approved by:   | Qi Dianyuan | SAR Project Leader |           |

Issued: September 20, 2017

This calibration certificate shall not be reproduced except in full without written approval of the laboratory.



### Glossary:

|       |  |
|-------|--|
| TSL   | tissue simulating liquid                   |
| ConvF | sensitivity in TSL / NORM <sub>x,y,z</sub> |
| N/A   | not applicable or not measured             |

### Calibration is Performed According to the Following Standards:

- IEEE Std 1528-2013, "IEEE Recommended Practice for Determining the Peak Spatial-Averaged Specific Absorption Rate (SAR) in the Human Head from Wireless Communications Devices: Measurement Techniques", June 2013
- IEC 62209-1, "Measurement procedure for assessment of specific absorption rate of human exposure to radio frequency fields from hand-held and body-mounted wireless communication devices- Part 1: Device used next to the ear (Frequency range of 300MHz to 6GHz)", July 2016
- IEC 62209-2, "Procedure to measure the Specific Absorption Rate (SAR) For wireless communication devices used in close proximity to the human body (frequency range of 30MHz to 6GHz)", March 2010
- KDB865664, SAR Measurement Requirements for 100 MHz to 6 GHz

### Additional Documentation:

- DASY4/5 System Handbook

### Methods Applied and Interpretation of Parameters:

- Measurement Conditions:** Further details are available from the Validation Report at the end of the certificate. All figures stated in the certificate are valid at the frequency indicated.
- Antenna Parameters with TSL:** The dipole is mounted with the spacer to position its feed point exactly below the center marking of the flat phantom section, with the arms oriented parallel to the body axis.
- Feed Point Impedance and Return Loss:** These parameters are measured with the dipole positioned under the liquid filled phantom. The impedance stated is transformed from the measurement at the SMA connector to the feed point. The Return Loss ensures low reflected power. No uncertainty required.
- Electrical Delay:** One-way delay between the SMA connector and the antenna feed point. No uncertainty required.
- SAR measured:** SAR measured at the stated antenna input power.
- SAR normalized:** SAR as measured, normalized to an input power of 1 W at the antenna connector.
- SAR for nominal TSL parameters:** The measured TSL parameters are used to calculate the nominal SAR result.

The reported uncertainty of measurement is stated as the standard uncertainty of Measurement multiplied by the coverage factor  $k=2$ , which for a normal distribution Corresponds to a coverage probability of approximately 95%.





Add: No.51 Xueyuan Road, Haidian District, Beijing, 100191, China  
 Tel: +86-10-62304633-2079 Fax: +86-10-62304633-2504  
 E-mail: cttl@chinattl.com http://www.chinattl.cn

### Measurement Conditions

DASY system configuration, as far as not given on page 1.

|                              |                          |              |
|------------------------------|--------------------------|--------------|
| DASY Version                 | DASY52                   | 52.10.0.1446 |
| Extrapolation                | Advanced Extrapolation   |              |
| Phantom                      | Triple Flat Phantom 5.1C |              |
| Distance Dipole Center - TSL | 10 mm                    | with Spacer  |
| Zoom Scan Resolution         | dx, dy, dz = 5 mm        |              |
| Frequency                    | 2600 MHz ± 1 MHz         |              |

### Head TSL parameters

The following parameters and calculations were applied.

|   | Temperature     | Permittivity | Conductivity     |
|---|-----------------|--------------|------------------|
| Nominal Head TSL parameters             | 22.0 °C         | 39.0         | 1.96 mho/m       |
| Measured Head TSL parameters            | (22.0 ± 0.2) °C | 39.8 ± 6 %   | 1.95 mho/m ± 6 % |
| Head TSL temperature change during test | <1.0 °C         | ----         | ----             |

### SAR result with Head TSL

|   |                    |                            |
|---|--------------------|----------------------------|
| SAR averaged over 1 cm <sup>3</sup> (1 g) of Head TSL   | Condition          |                            |
| SAR measured  | 250 mW input power | 14.0 mW / g                |
| SAR for nominal Head TSL parameters                     | normalized to 1W   | 56.4 mW / g ± 18.8 % (k=2) |
| SAR averaged over 10 cm <sup>3</sup> (10 g) of Head TSL | Condition          |                            |
| SAR measured  | 250 mW input power | 6.29 mW / g                |
| SAR for nominal Head TSL parameters                     | normalized to 1W   | 25.3 mW / g ± 18.7 % (k=2) |

### Body TSL parameters

The following parameters and calculations were applied.

|   | Temperature     | Permittivity | Conductivity     |
|---|-----------------|--------------|------------------|
| Nominal Body TSL parameters             | 22.0 °C         | 52.5         | 2.16 mho/m       |
| Measured Body TSL parameters            | (22.0 ± 0.2) °C | 52.7 ± 6 %   | 2.15 mho/m ± 6 % |
| Body TSL temperature change during test | <1.0 °C         | ----         | ----             |

### SAR result with Body TSL

|   |                    |                            |
|---|--------------------|----------------------------|
| SAR averaged over 1 cm <sup>3</sup> (1 g) of Body TSL   | Condition          |                            |
| SAR measured  | 250 mW input power | 13.7 mW / g                |
| SAR for nominal Body TSL parameters                     | normalized to 1W   | 55.0 mW / g ± 18.8 % (k=2) |
| SAR averaged over 10 cm <sup>3</sup> (10 g) of Body TSL | Condition          |                            |
| SAR measured  | 250 mW input power | 6.08 mW / g                |
| SAR for nominal Body TSL parameters                     | normalized to 1W   | 24.4 mW / g ± 18.7 % (k=2) |



Add: No.51 Xueyuan Road, Haidian District, Beijing, 100191, China  
Tel: +86-10-62304633-2079 Fax: +86-10-62304633-2504  
E-mail: cttl@chinattl.com http://www.chinattl.cn

### Appendix(Additional assessments outside the scope of CNAS L0570)

#### Antenna Parameters with Head TSL

|                                      |               |
|--------------------------------------|---------------|
| Impedance, transformed to feed point | 50.0Ω- 5.12jΩ |
| Return Loss                          | - 25.8dB      |

#### Antenna Parameters with Body TSL

|                                      |               |
|--------------------------------------|---------------|
| Impedance, transformed to feed point | 46.8Ω- 5.40jΩ |
| Return Loss                          | - 23.8dB      |

#### General Antenna Parameters and Design

|                                  |          |
|----------------------------------|----------|
| Electrical Delay (one direction) | 1.258 ns |
|----------------------------------|----------|

After long term use with 100W radiated power, only a slight warming of the dipole near the feedpoint can be measured.

The dipole is made of standard semirigid coaxial cable. The center conductor of the feeding line is directly connected to the second arm of the dipole. The antenna is therefore short-circuited for DC-signals. On some of the dipoles, small end caps are added to the dipole arms in order to improve matching when loaded according to the position as explained in the "Measurement Conditions" paragraph. The SAR data are not affected by this change. The overall dipole length is still according to the Standard.

No excessive force must be applied to the dipole arms, because they might bend or the soldered connections near the feedpoint may be damaged.

#### Additional EUT Data

|                 |       |
|-----------------|-------|
| Manufactured by | SPEAG |
|-----------------|-------|



Add: No.51 Xueyuan Road, Haidian District, Beijing, 100191, China  
Tel: +86-10-62304633-2079 Fax: +86-10-62304633-2504  
E-mail: cttl@chinattl.com http://www.chinattl.cn

**DASY5 Validation Report for Head TSL**

Date: 09.18.2017

Test Laboratory: CTTL, Beijing, China

**DUT: Dipole 2600 MHz; Type: D2600V2; Serial: D2600V2 - SN: 1112**

Communication System: UID 0, CW; Frequency: 2600 MHz; Duty Cycle: 1:1

Medium parameters used:  $f = 2600$  MHz;  $\sigma = 1.947$  S/m;  $\epsilon_r = 39.75$ ;  $\rho = 1000$  kg/m<sup>3</sup>

Phantom section: Left Section

Measurement Standard: DASY5 (IEEE/IEC/ANSI C63.19-2007)

DASY5 Configuration:

- Probe: EX3DV4 - SN7433; ConvF(7.19, 7.19, 7.19); Calibrated: 9/26/2016;
- Sensor-Surface: 1.4mm (Mechanical Surface Detection)
- Electronics: DAE4 Sn1331; Calibrated: 1/19/2017
- Phantom: Triple Flat Phantom 5.1C; Type: QD 000 P51 CA; Serial: 1161/1
- Measurement SW: DASY52, Version 52.10 (0); SEMCAD X Version 14.6.10 (7417)

**Dipole Calibration/Zoom Scan (7x7x7) (7x7x7)/Cube 0:** Measurement grid: dx=5mm, dy=5mm, dz=5mm

Reference Value = 97.92 V/m; Power Drift = 0.03 dB

Peak SAR (extrapolated) = 30.0 W/kg

**SAR(1 g) = 14 W/kg; SAR(10 g) = 6.29 W/kg**

Maximum value of SAR (measured) = 24.0 W/kg

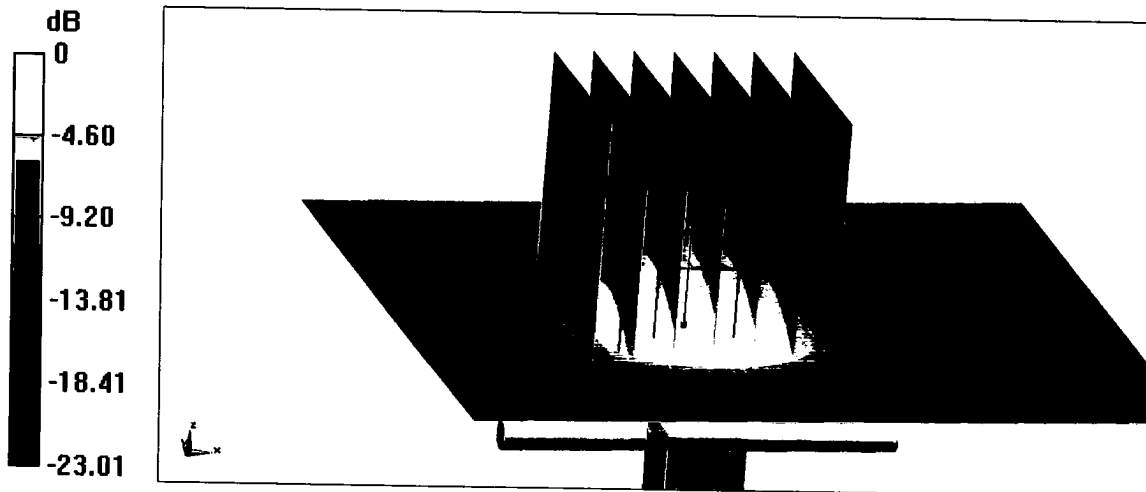

0 dB = 24.0 W/kg = 13.80 dBW/kg



Add: No.51 Xueyuan Road, Haidian District, Beijing, 100191, China  
Tel: +86-10-62304633-2079 Fax: +86-10-62304633-2504  
E-mail: cttl@chinattl.com http://www.chinattl.cn

### Impedance Measurement Plot for Head TSL

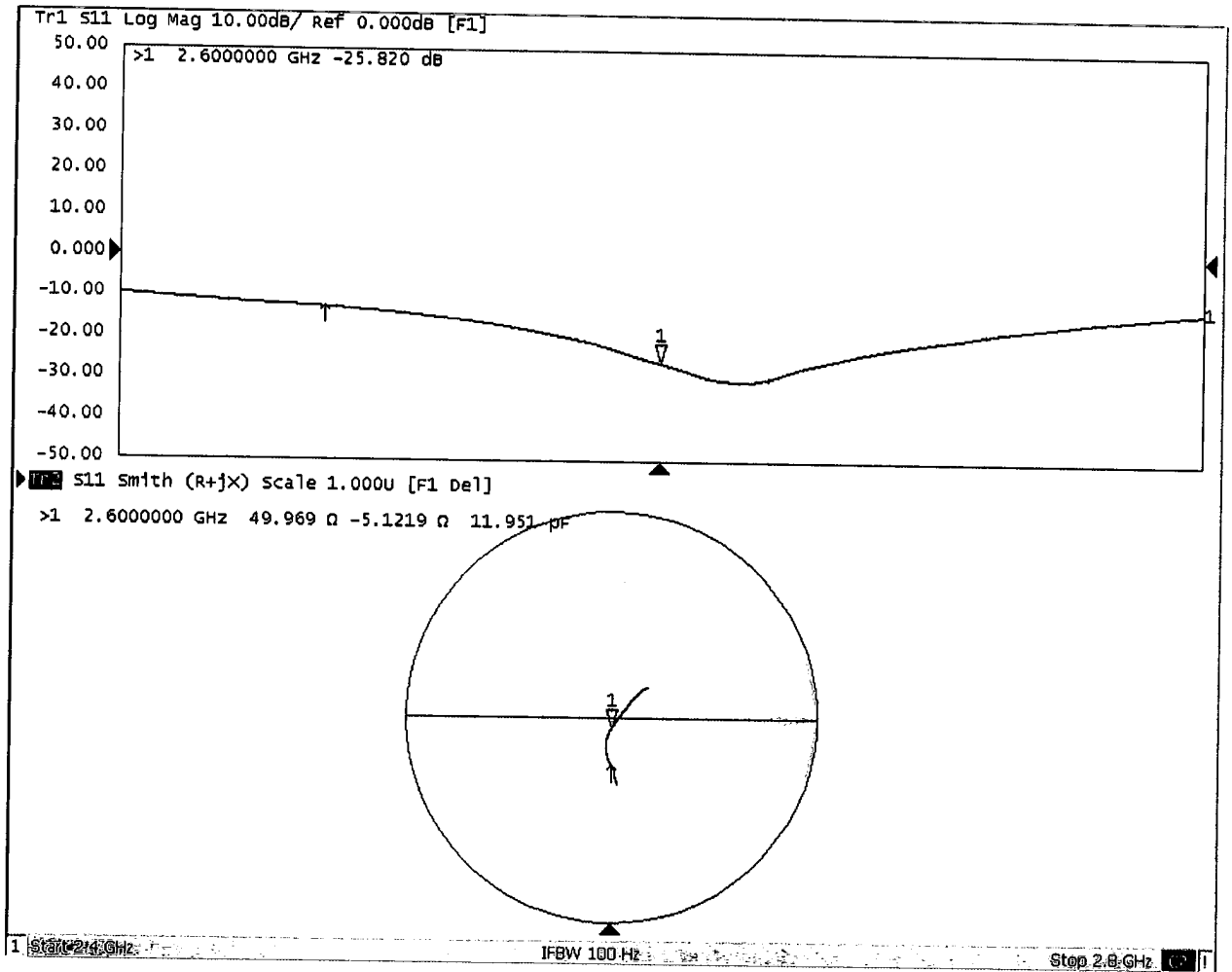



Add: No.51 Xueyuan Road, Haidian District, Beijing, 100191, China  
Tel: +86-10-62304633-2079 Fax: +86-10-62304633-2504  
E-mail: cttl@chinattl.com http://www.chinattl.cn

### DASY5 Validation Report for Body TSL

Date: 09.18.2017

Test Laboratory: CTTL, Beijing, China

**DUT: Dipole 2600 MHz; Type: D2600V2; Serial: D2600V2 - SN: 1112**

Communication System: UID 0, CW; Frequency: 2600 MHz; Duty Cycle: 1:1

Medium parameters used:  $f = 2600$  MHz;  $\sigma = 2.147$  S/m;  $\epsilon_r = 52.74$ ;  $\rho = 1000$  kg/m<sup>3</sup>

Phantom section: Center Section

Measurement Standard: DASY5 (IEEE/IEC/ANSI C63.19-2007)

DASY5 Configuration:

- Probe: EX3DV4 - SN7433; ConvF(7.22, 7.22, 7.22); Calibrated: 9/26/2016;
- Sensor-Surface: 1.4mm (Mechanical Surface Detection)
- Electronics: DAE4 Sn1331; Calibrated: 1/19/2017
- Phantom: Triple Flat Phantom 5.1C; Type: QD 000 P51 CA; Serial: 1161/1
- Measurement SW: DASY52, Version 52.10 (0); SEMCAD X Version 14.6.10 (7417)

**Dipole Calibration/Zoom Scan (7x7x7) (7x7x7)/Cube 0:** Measurement grid: dx=5mm, dy=5mm, dz=5mm

Reference Value = 98.69 V/m; Power Drift = -0.01 dB

Peak SAR (extrapolated) = 30.3 W/kg

**SAR(1 g) = 13.7 W/kg; SAR(10 g) = 6.08 W/kg**

Maximum value of SAR (measured) = 23.7 W/kg

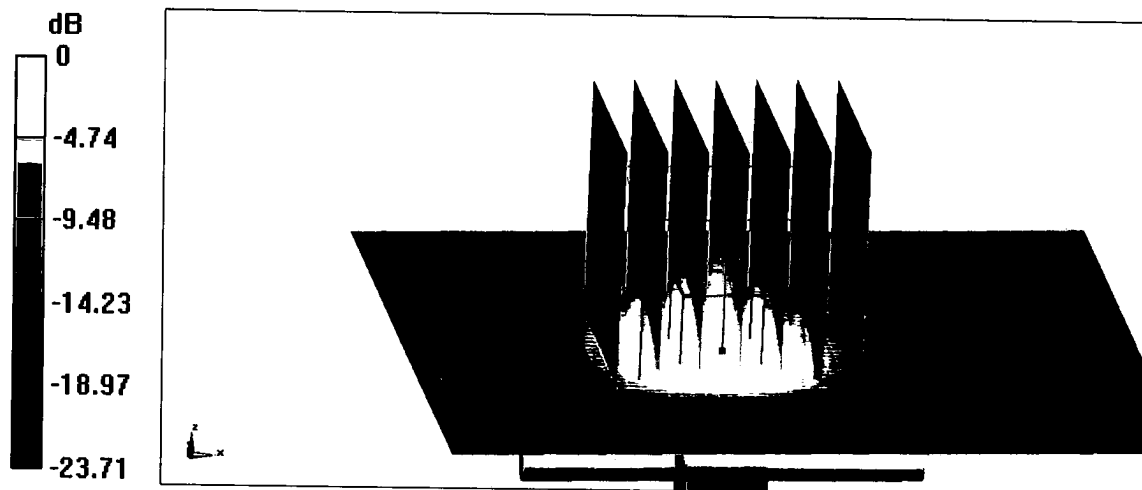

0 dB = 23.7 W/kg = 13.75 dBW/kg



Add: No.51 Xueyuan Road, Haidian District, Beijing, 100191, China  
Tel: +86-10-62304633-2079 Fax: +86-10-62304633-2504  
E-mail: cttl@chinattl.com http://www.chinattl.cn

### Impedance Measurement Plot for Body TSL

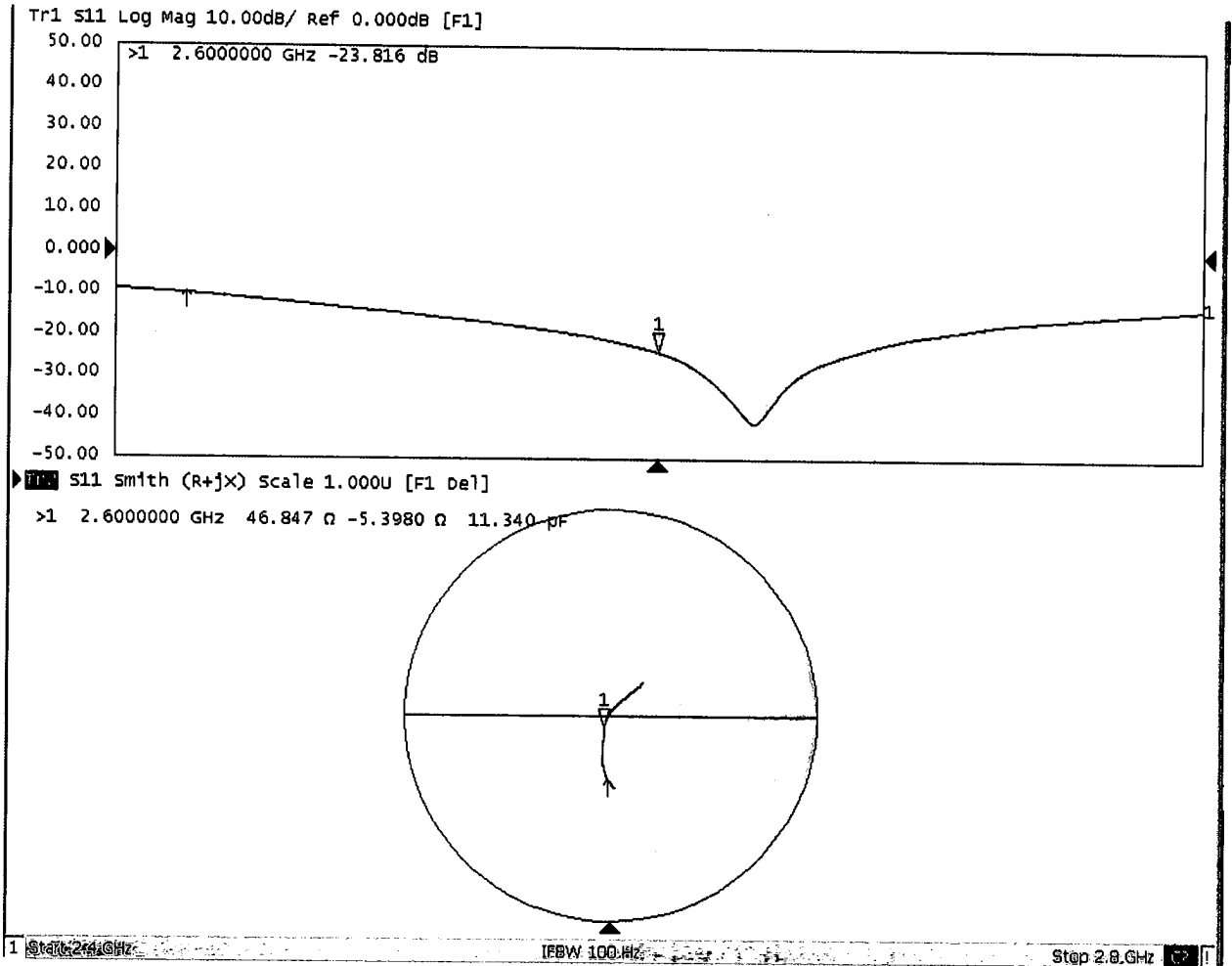



In Collaboration with  
**s p e a g**  
 CALIBRATION LABORATORY



中国认可  
 国际互认  
 校准  
 CALIBRATION  
 CNAS L0570

Add: No.51 Xueyuan Road, Haidian District, Beijing, 100191, China  
 Tel: +86-10-62304633-2079 Fax: +86-10-62304633-2504  
 E-mail: cttl@chinattl.com http://www.chinattl.cn

Client **Sporton International INC**

Certificate No: **Z17-97162**

## CALIBRATION CERTIFICATE

Object **D5GHzV2 - SN: 1128**

Calibration Procedure(s) **FF-Z11-003-01**  
 Calibration Procedures for dipole validation kits

Calibration date: **September 25, 2017**

This calibration Certificate documents the traceability to national standards, which realize the physical units of measurements(SI). The measurements and the uncertainties with confidence probability are given on the following pages and are part of the certificate.

All calibrations have been conducted in the closed laboratory facility: environment temperature(22±3)°C and humidity<70%.

Calibration Equipment used (M&TE critical for calibration)

| Primary Standards       | ID #       | Cal Date(Calibrated by, Certificate No.) | Scheduled Calibration |
|-------------------------|------------|--|-----------------------|
| Power Meter NRP2        | 102196     | 02-Mar-17 (CTTL, No.J17X01254)           | Mar-18                |
| Power sensor NRP-Z91    | 100596     | 02-Mar-17 (CTTL, No.J17X01254)           | Mar-18                |
| ReferenceProbe EX3DV4   | SN 3846    | 13-Jan-17(CTTL-SPEAG,No.Z16-97251)       | Jan-18                |
| DAE4                    | SN 1331    | 19-Jan-17(CTTL-SPEAG,No.Z17-97015)       | Jan-18                |
| Secondary Standards     | ID #       | Cal Date(Calibrated by, Certificate No.) | Scheduled Calibration |
| Signal Generator E4438C | MY49071430 | 13-Jan-17 (CTTL, No.J17X00286)           | Jan-18                |
| NetworkAnalyzer E5071C  | MY46110673 | 13-Jan-17 (CTTL, No.J17X00285)           | Jan-18                |

|                | Name        | Function           | Signature |
|----------------|-------------|--------------------|-----------|
| Calibrated by: | Zhao Jing   | SAR Test Engineer  |           |
| Reviewed by:   | Yu Zongying | SAR Test Engineer  |           |
| Approved by:   | Qi Dianyuan | SAR Project Leader |           |

Issued: September 28, 2017

This calibration certificate shall not be reproduced except in full without written approval of the laboratory.



Add: No.51 Xueyuan Road, Haidian District, Beijing, 100191, China  
Tel: +86-10-62304633-2079 Fax: +86-10-62304633-2504  
E-mail: cttl@chinattl.com http://www.chinattl.cn

**Glossary:**

|       |  |
|-------|--|
| TSL   | tissue simulating liquid                   |
| ConvF | sensitivity in TSL / NORM <sub>x,y,z</sub> |
| N/A   | not applicable or not measured             |

**Calibration is Performed According to the Following Standards:**

- IEEE Std 1528-2013, "IEEE Recommended Practice for Determining the Peak Spatial-Averaged Specific Absorption Rate (SAR) in the Human Head from Wireless Communications Devices: Measurement Techniques", June 2013
- IEC 62209-1, "Measurement procedure for assessment of specific absorption rate of human exposure to radio frequency fields from hand-held and body-mounted wireless communication devices- Part 1: Device used next to the ear (Frequency range of 300MHz to 6GHz)", July 2016
- IEC 62209-2, "Procedure to measure the Specific Absorption Rate (SAR) For wireless communication devices used in close proximity to the human body (frequency range of 30MHz to 6GHz)", March 2010
- KDB865664, SAR Measurement Requirements for 100 MHz to 6 GHz

**Additional Documentation:**

- DASY4/5 System Handbook

**Methods Applied and Interpretation of Parameters:**

- Measurement Conditions:** Further details are available from the Validation Report at the end of the certificate. All figures stated in the certificate are valid at the frequency indicated.
- Antenna Parameters with TSL:** The dipole is mounted with the spacer to position its feed point exactly below the center marking of the flat phantom section, with the arms oriented parallel to the body axis.
- Feed Point Impedance and Return Loss:** These parameters are measured with the dipole positioned under the liquid filled phantom. The impedance stated is transformed from the measurement at the SMA connector to the feed point. The Return Loss ensures low reflected power. No uncertainty required.
- Electrical Delay:** One-way delay between the SMA connector and the antenna feed point. No uncertainty required.
- SAR measured:** SAR measured at the stated antenna input power.
- SAR normalized:** SAR as measured, normalized to an input power of 1 W at the antenna connector.
- SAR for nominal TSL parameters:** The measured TSL parameters are used to calculate the nominal SAR result.

The reported uncertainty of measurement is stated as the standard uncertainty of Measurement multiplied by the coverage factor  $k=2$ , which for a normal distribution Corresponds to a coverage probability of approximately 95%.





Add: No.51 Xueyuan Road, Haidian District, Beijing, 100191, China  
 Tel: +86-10-62304633-2079 Fax: +86-10-62304633-2504  
 E-mail: cttl@chinattl.com http://www.chinattl.cn

### Measurement Conditions

DASY system configuration, as far as not given on page 1.

|                              |  |                                  |
|------------------------------|--|----------------------------------|
| DASY Version                 | DASY52   | 52.10.0.1446                     |
| Extrapolation                | Advanced Extrapolation   |                                  |
| Phantom                      | Triple Flat Phantom 5.1C   |                                  |
| Distance Dipole Center - TSL | 10 mm  | with Spacer                      |
| Zoom Scan Resolution         | dx, dy = 4 mm, dz = 1.4 mm   | Graded Ratio = 1.4 (Z direction) |
| Frequency                    | 5200 MHz ± 1 MHz<br>5300 MHz ± 1 MHz<br>5500 MHz ± 1 MHz<br>5600 MHz ± 1 MHz<br>5800 MHz ± 1 MHz |                                  |

### Head TSL parameters at 5200 MHz

The following parameters and calculations were applied.

|   | Temperature     | Permittivity | Conductivity     |
|---|-----------------|--------------|------------------|
| Nominal Head TSL parameters             | 22.0 °C         | 36.0         | 4.66 mho/m       |
| Measured Head TSL parameters            | (22.0 ± 0.2) °C | 35.7 ± 6 %   | 4.62 mho/m ± 6 % |
| Head TSL temperature change during test | <1.0 °C         | ----         | ----             |

### SAR result with Head TSL at 5200 MHz

|   |                    |                                   |
|---|--------------------|-----------------------------------|
| SAR averaged over 1 cm <sup>3</sup> (1 g) of Head TSL   | Condition          |                                   |
| SAR measured  | 100 mW input power | 7.83 mW / g                       |
| SAR for nominal Head TSL parameters                     | normalized to 1W   | <b>78.2 mW / g ± 24.4 % (k=2)</b> |
| SAR averaged over 10 cm <sup>3</sup> (10 g) of Head TSL | Condition          |                                   |
| SAR measured  | 100 mW input power | 2.28 mW / g                       |
| SAR for nominal Head TSL parameters                     | normalized to 1W   | <b>22.7 mW / g ± 24.2 % (k=2)</b> |



Add: No.51 Xueyuan Road, Haidian District, Beijing, 100191, China  
 Tel: +86-10-62304633-2079 Fax: +86-10-62304633-2504  
 E-mail: cttl@chinattl.com http://www.chinattl.cn

**Head TSL parameters at 5300 MHz**

The following parameters and calculations were applied.

|   | Temperature     | Permittivity | Conductivity     |
|---|-----------------|--------------|------------------|
| Nominal Head TSL parameters             | 22.0 °C         | 35.9         | 4.76 mho/m       |
| Measured Head TSL parameters            | (22.0 ± 0.2) °C | 36.1 ± 6 %   | 4.67 mho/m ± 6 % |
| Head TSL temperature change during test | <1.0 °C         | ----         | ----             |

**SAR result with Head TSL at 5300 MHz**

|   |                    |                                   |
|---|--------------------|-----------------------------------|
| SAR averaged over 1 cm <sup>3</sup> (1 g) of Head TSL   | Condition          |                                   |
| SAR measured  | 100 mW input power | 8.21 mW / g                       |
| SAR for nominal Head TSL parameters                     | normalized to 1W   | <b>82.1 mW / g ± 24.4 % (k=2)</b> |
| SAR averaged over 10 cm <sup>3</sup> (10 g) of Head TSL | Condition          |                                   |
| SAR measured  | 100 mW input power | 2.34 mW / g                       |
| SAR for nominal Head TSL parameters                     | normalized to 1W   | <b>23.4 mW / g ± 24.2 % (k=2)</b> |

**Head TSL parameters at 5500 MHz**

The following parameters and calculations were applied.

|   | Temperature     | Permittivity | Conductivity     |
|---|-----------------|--------------|------------------|
| Nominal Head TSL parameters             | 22.0 °C         | 35.6         | 4.96 mho/m       |
| Measured Head TSL parameters            | (22.0 ± 0.2) °C | 35.9 ± 6 %   | 4.93 mho/m ± 6 % |
| Head TSL temperature change during test | <1.0 °C         | ----         | ----             |

**SAR result with Head TSL at 5500 MHz**

|   |                    |                                   |
|---|--------------------|-----------------------------------|
| SAR averaged over 1 cm <sup>3</sup> (1 g) of Head TSL   | Condition          |                                   |
| SAR measured  | 100 mW input power | 8.45 mW / g                       |
| SAR for nominal Head TSL parameters                     | normalized to 1W   | <b>84.6 mW / g ± 24.4 % (k=2)</b> |
| SAR averaged over 10 cm <sup>3</sup> (10 g) of Head TSL | Condition          |                                   |
| SAR measured  | 100 mW input power | 2.42 mW / g                       |
| SAR for nominal Head TSL parameters                     | normalized to 1W   | <b>24.3 mW / g ± 24.2 % (k=2)</b> |



Add: No.51 Xueyuan Road, Haidian District, Beijing, 100191, China  
 Tel: +86-10-62304633-2079 Fax: +86-10-62304633-2504  
 E-mail: cttl@chinattl.com http://www.chinattl.cn

**Head TSL parameters at 5600 MHz**

The following parameters and calculations were applied.

|   | Temperature     | Permittivity | Conductivity     |
|---|-----------------|--------------|------------------|
| Nominal Head TSL parameters             | 22.0 °C         | 35.5         | 5.07 mho/m       |
| Measured Head TSL parameters            | (22.0 ± 0.2) °C | 35.7 ± 6 %   | 4.98 mho/m ± 6 % |
| Head TSL temperature change during test | <1.0 °C         | ----         | ----             |

**SAR result with Head TSL at 5600 MHz**

|   |                    |                                  |
|---|--------------------|----------------------------------|
| SAR averaged over 1 cm <sup>3</sup> (1 g) of Head TSL   | Condition          |                                  |
| SAR measured  | 100 mW input power | 8.18 mW / g                      |
| SAR for nominal Head TSL parameters                     | normalized to 1W   | <b>81.8 mW /g ± 24.4 % (k=2)</b> |
| SAR averaged over 10 cm <sup>3</sup> (10 g) of Head TSL | Condition          |                                  |
| SAR measured  | 100 mW input power | 2.34 mW / g                      |
| SAR for nominal Head TSL parameters                     | normalized to 1W   | <b>23.4 mW /g ± 24.2 % (k=2)</b> |

**Head TSL parameters at 5800 MHz**

The following parameters and calculations were applied.

|   | Temperature     | Permittivity | Conductivity     |
|---|-----------------|--------------|------------------|
| Nominal Head TSL parameters             | 22.0 °C         | 35.3         | 5.27 mho/m       |
| Measured Head TSL parameters            | (22.0 ± 0.2) °C | 35.8 ± 6 %   | 5.16 mho/m ± 6 % |
| Head TSL temperature change during test | <1.0 °C         | ----         | ----             |

**SAR result with Head TSL at 5800 MHz**

|   |                    |                                  |
|---|--------------------|----------------------------------|
| SAR averaged over 1 cm <sup>3</sup> (1 g) of Head TSL   | Condition          |                                  |
| SAR measured  | 100 mW input power | 7.97 mW / g                      |
| SAR for nominal Head TSL parameters                     | normalized to 1W   | <b>79.9 mW /g ± 24.4 % (k=2)</b> |
| SAR averaged over 10 cm <sup>3</sup> (10 g) of Head TSL | Condition          |                                  |
| SAR measured  | 100 mW input power | 2.29 mW / g                      |
| SAR for nominal Head TSL parameters                     | normalized to 1W   | <b>23.0 mW /g ± 24.2 % (k=2)</b> |



Add: No.51 Xueyuan Road, Haidian District, Beijing, 100191, China  
 Tel: +86-10-62304633-2079 Fax: +86-10-62304633-2504  
 E-mail: cttl@chinattl.com http://www.chinattl.cn

**Body TSL parameters at 5200 MHz**

The following parameters and calculations were applied.

|   | Temperature     | Permittivity | Conductivity     |
|---|-----------------|--------------|------------------|
| Nominal Body TSL parameters             | 22.0 °C         | 49.0         | 5.30 mho/m       |
| Measured Body TSL parameters            | (22.0 ± 0.2) °C | 49.5 ± 6 %   | 5.38 mho/m ± 6 % |
| Body TSL temperature change during test | <1.0 °C         | ----         | ----             |

**SAR result with Body TSL at 5200 MHz**

|   |                    |                                   |
|---|--------------------|-----------------------------------|
| SAR averaged over 1 cm <sup>3</sup> (1 g) of Body TSL   | Condition          |                                   |
| SAR measured  | 100 mW input power | 7.44 mW / g                       |
| SAR for nominal Body TSL parameters                     | normalized to 1W   | <b>74.6 mW / g ± 24.4 % (k=2)</b> |
| SAR averaged over 10 cm <sup>3</sup> (10 g) of Body TSL | Condition          |                                   |
| SAR measured  | 100 mW input power | 2.10 mW / g                       |
| SAR for nominal Body TSL parameters                     | normalized to 1W   | <b>21.1 mW / g ± 24.2 % (k=2)</b> |

**Body TSL parameters at 5300 MHz**

The following parameters and calculations were applied.

|   | Temperature     | Permittivity | Conductivity     |
|---|-----------------|--------------|------------------|
| Nominal Body TSL parameters             | 22.0 °C         | 48.9         | 5.42 mho/m       |
| Measured Body TSL parameters            | (22.0 ± 0.2) °C | 49.2 ± 6 %   | 5.50 mho/m ± 6 % |
| Body TSL temperature change during test | <1.0 °C         | ----         | ----             |

**SAR result with Body TSL at 5300 MHz**

|   |                    |                                   |
|---|--------------------|-----------------------------------|
| SAR averaged over 1 cm <sup>3</sup> (1 g) of Body TSL   | Condition          |                                   |
| SAR measured  | 100 mW input power | 7.58 mW / g                       |
| SAR for nominal Body TSL parameters                     | normalized to 1W   | <b>75.9 mW / g ± 24.4 % (k=2)</b> |
| SAR averaged over 10 cm <sup>3</sup> (10 g) of Body TSL | Condition          |                                   |
| SAR measured  | 100 mW input power | 2.15 mW / g                       |
| SAR for nominal Body TSL parameters                     | normalized to 1W   | <b>21.6 mW / g ± 24.2 % (k=2)</b> |



Add: No.51 Xueyuan Road, Haidian District, Beijing, 100191, China  
 Tel: +86-10-62304633-2079 Fax: +86-10-62304633-2504  
 E-mail: cttl@chinattl.com http://www.chinattl.cn

**Body TSL parameters at 5500 MHz**

The following parameters and calculations were applied.

|   | Temperature     | Permittivity | Conductivity     |
|---|-----------------|--------------|------------------|
| Nominal Body TSL parameters             | 22.0 °C         | 48.6         | 5.65 mho/m       |
| Measured Body TSL parameters            | (22.0 ± 0.2) °C | 49.0 ± 6 %   | 5.72 mho/m ± 6 % |
| Body TSL temperature change during test | <1.0 °C         | ----         | ----             |

**SAR result with Body TSL at 5500 MHz**

|   |                    |                                  |
|---|--------------------|----------------------------------|
| SAR averaged over 1 cm <sup>3</sup> (1 g) of Body TSL   | Condition          |                                  |
| SAR measured  | 100 mW input power | 8.19 mW / g                      |
| SAR for nominal Body TSL parameters                     | normalized to 1W   | <b>82.1 mW /g ± 24.4 % (k=2)</b> |
| SAR averaged over 10 cm <sup>3</sup> (10 g) of Body TSL | Condition          |                                  |
| SAR measured  | 100 mW input power | 2.34 mW / g                      |
| SAR for nominal Body TSL parameters                     | normalized to 1W   | <b>23.5 mW /g ± 24.2 % (k=2)</b> |

**Body TSL parameters at 5600 MHz**

The following parameters and calculations were applied.

|   | Temperature     | Permittivity | Conductivity     |
|---|-----------------|--------------|------------------|
| Nominal Body TSL parameters             | 22.0 °C         | 48.5         | 5.77 mho/m       |
| Measured Body TSL parameters            | (22.0 ± 0.2) °C | 48.4 ± 6 %   | 5.73 mho/m ± 6 % |
| Body TSL temperature change during test | <1.0 °C         | ----         | ----             |

**SAR result with Body TSL at 5600 MHz**

|   |                    |                                  |
|---|--------------------|----------------------------------|
| SAR averaged over 1 cm <sup>3</sup> (1 g) of Body TSL   | Condition          |                                  |
| SAR measured  | 100 mW input power | 8.01 mW / g                      |
| SAR for nominal Body TSL parameters                     | normalized to 1W   | <b>80.0 mW /g ± 24.4 % (k=2)</b> |
| SAR averaged over 10 cm <sup>3</sup> (10 g) of Body TSL | Condition          |                                  |
| SAR measured  | 100 mW input power | 2.27 mW / g                      |
| SAR for nominal Body TSL parameters                     | normalized to 1W   | <b>22.7 mW /g ± 24.2 % (k=2)</b> |



Add: No.51 Xueyuan Road, Haidian District, Beijing, 100191, China  
Tel: +86-10-62304633-2079 Fax: +86-10-62304633-2504  
E-mail: cttl@chinattl.com http://www.chinattl.cn

### Body TSL parameters at 5800 MHz

The following parameters and calculations were applied.

|   | Temperature     | Permittivity | Conductivity     |
|---|-----------------|--------------|------------------|
| Nominal Body TSL parameters             | 22.0 °C         | 48.2         | 6.00 mho/m       |
| Measured Body TSL parameters            | (22.0 ± 0.2) °C | 49.0 ± 6 %   | 5.94 mho/m ± 6 % |
| Body TSL temperature change during test | <1.0 °C         | ----         | ----             |

### SAR result with Body TSL at 5800 MHz

|   |                    |                            |
|---|--------------------|----------------------------|
| SAR averaged over 1 cm <sup>3</sup> (1 g) of Body TSL   | Condition          |                            |
| SAR measured  | 100 mW input power | 7.80 mW / g                |
| SAR for nominal Body TSL parameters                     | normalized to 1W   | 78.2 mW / g ± 24.4 % (k=2) |
| SAR averaged over 10 cm <sup>3</sup> (10 g) of Body TSL | Condition          |                            |
| SAR measured  | 100 mW input power | 2.19 mW / g                |
| SAR for nominal Body TSL parameters                     | normalized to 1W   | 22.0 mW / g ± 24.2 % (k=2) |



Add: No.51 Xueyuan Road, Haidian District, Beijing, 100191, China  
Tel: +86-10-62304633-2079 Fax: +86-10-62304633-2504  
E-mail: cttl@chinattl.com http://www.chinattl.cn

### Appendix (Additional assessments outside the scope of CNAS L0570)

#### Antenna Parameters with Head TSL at 5200 MHz

|                                      |                |
|--------------------------------------|----------------|
| Impedance, transformed to feed point | 52.3Ω - 5.14jΩ |
| Return Loss                          | - 25.2dB       |

#### Antenna Parameters with Head TSL at 5300 MHz

|                                      |                |
|--------------------------------------|----------------|
| Impedance, transformed to feed point | 49.4Ω - 2.35jΩ |
| Return Loss                          | - 32.2dB       |

#### Antenna Parameters with Head TSL at 5500 MHz

|                                      |                |
|--------------------------------------|----------------|
| Impedance, transformed to feed point | 53.2Ω - 1.80jΩ |
| Return Loss                          | - 29.0dB       |

#### Antenna Parameters with Head TSL at 5600 MHz

|                                      |                |
|--------------------------------------|----------------|
| Impedance, transformed to feed point | 56.2Ω + 3.04jΩ |
| Return Loss                          | - 23.8dB       |

#### Antenna Parameters with Head TSL at 5800 MHz

|                                      |                |
|--------------------------------------|----------------|
| Impedance, transformed to feed point | 55.1Ω - 0.92jΩ |
| Return Loss                          | - 26.2dB       |

#### Antenna Parameters with Body TSL at 5200 MHz

|                                      |                |
|--------------------------------------|----------------|
| Impedance, transformed to feed point | 52.0Ω - 3.72jΩ |
| Return Loss                          | - 27.7dB       |

#### Antenna Parameters with Body TSL at 5300 MHz

|                                      |                |
|--------------------------------------|----------------|
| Impedance, transformed to feed point | 49.0Ω - 1.32jΩ |
| Return Loss                          | - 35.5dB       |



Add: No.51 Xueyuan Road, Haidian District, Beijing, 100191, China  
Tel: +86-10-62304633-2079 Fax: +86-10-62304633-2504  
E-mail: cttl@chinattl.com http://www.chinattl.cn

### Antenna Parameters with Body TSL at 5500 MHz

|                                      |                |
|--------------------------------------|----------------|
| Impedance, transformed to feed point | 54.0Ω - 0.02jΩ |
| Return Loss                          | - 28.4dB       |

### Antenna Parameters with Body TSL at 5600 MHz

|                                      |                |
|--------------------------------------|----------------|
| Impedance, transformed to feed point | 56.0Ω + 4.38jΩ |
| Return Loss                          | - 23.1dB       |

### Antenna Parameters with Body TSL at 5800 MHz

|                                      |                |
|--------------------------------------|----------------|
| Impedance, transformed to feed point | 55.2Ω + 0.32jΩ |
| Return Loss                          | - 26.1dB       |

### General Antenna Parameters and Design

|                                  |          |
|----------------------------------|----------|
| Electrical Delay (one direction) | 1.316 ns |
|----------------------------------|----------|

After long term use with 100W radiated power, only a slight warming of the dipole near the feedpoint can be measured.

The dipole is made of standard semirigid coaxial cable. The center conductor of the feeding line is directly connected to the second arm of the dipole. The antenna is therefore short-circuited for DC-signals. On some of the dipoles, small end caps are added to the dipole arms in order to improve matching when loaded according to the position as explained in the "Measurement Conditions" paragraph. The SAR data are not affected by this change. The overall dipole length is still according to the Standard. No excessive force must be applied to the dipole arms, because they might bend or the soldered connections near the feedpoint may be damaged.

### Additional EUT Data

|                 |       |
|-----------------|-------|
| Manufactured by | SPEAG |
|-----------------|-------|





**DASY5 Validation Report for Head TSL**

Date: 09.21.2017

Test Laboratory: CTTL, Beijing, China

**DUT: Dipole 5GHz; Type: D5GHzV2; Serial: D5GHzV2 - SN: 1128**

Communication System: CW; Frequency: 5200 MHz, Frequency: 5300 MHz,  
Frequency: 5500 MHz, Frequency: 5600 MHz, Frequency: 5800 MHz,

Medium parameters used:  $f = 5200$  MHz;  $\sigma = 4.616$  mho/m;  $\epsilon_r = 35.72$ ;  $\rho = 1000$  kg/m<sup>3</sup>,  
Medium parameters used:  $f = 5300$  MHz;  $\sigma = 4.668$  mho/m;  $\epsilon_r = 36.09$ ;  $\rho = 1000$  kg/m<sup>3</sup>,  
Medium parameters used:  $f = 5500$  MHz;  $\sigma = 4.934$  mho/m;  $\epsilon_r = 35.92$ ;  
 $\rho = 1000$  kg/m<sup>3</sup>, Medium parameters used:  $f = 5600$  MHz;  $\sigma = 4.984$  mho/m;  $\epsilon_r = 35.73$ ;  
 $\rho = 1000$  kg/m<sup>3</sup>, Medium parameters used:  $f = 5800$  MHz;  $\sigma = 5.159$  mho/m;  
 $\epsilon_r = 35.83$ ;  $\rho = 1000$  kg/m<sup>3</sup>,

Phantom section: Left Section

Measurement Standard: DASY5 (IEEE/IEC/ANSI C63.19-2007)

**DASY5 Configuration:**

- Probe: EX3DV4 - SN3846; ConvF(5.37,5.37,5.37); Calibrated: 1/13/2017, ConvF(5.37,5.37,5.37); Calibrated: 1/13/2017, ConvF(4.72,4.72,4.72); Calibrated: 1/13/2017, ConvF(4.72,4.72,4.72); Calibrated: 1/13/2017, ConvF(4.95,4.95,4.95); Calibrated: 1/13/2017,
- Sensor-Surface: 1.4mm (Mechanical Surface Detection)
- Electronics: DAE4 Sn1331; Calibrated: 2017/1/19
- Phantom: Triple Flat Phantom 5.1C; Type: QD 000 P51 CA; Serial: 1161/3
- Measurement SW: DASY52, Version 52.10 (0); SEMCAD X Version 14.6.10 (7417)

**Dipole Calibration /Pin=100mW, d=10mm, f=5200 MHz/Zoom Scan, dist=1.4mm (8x8x7)/Cube 0:** Measurement grid: dx=4mm, dy=4mm, dz=1.4mm  
Reference Value = 56.36 V/m; Power Drift = 0.04 dB  
Peak SAR (extrapolated) = 31.2 W/kg  
**SAR(1 g) = 7.83 W/kg; SAR(10 g) = 2.28 W/kg**  
Maximum value of SAR (measured) = 18.0 W/kg

**Dipole Calibration /Pin=100mW, d=10mm, f=5300 MHz/Zoom Scan, dist=1.4mm (8x8x7)/Cube 0:** Measurement grid: dx=4mm, dy=4mm, dz=1.4mm  
Reference Value = 65.51 V/m; Power Drift = 0.01 dB  
Peak SAR (extrapolated) = 34.2 W/kg  
**SAR(1 g) = 8.21 W/kg; SAR(10 g) = 2.34 W/kg**  
Maximum value of SAR (measured) = 19.5 W/kg



Add: No.51 Xueyuan Road, Haidian District, Beijing, 100191, China  
Tel: +86-10-62304633-2079 Fax: +86-10-62304633-2504  
E-mail: cttl@chinattl.com http://www.chinattl.cn

**Dipole Calibration /Pin=100mW, d=10mm, f=5500 MHz/Zoom Scan,**  
**dist=1.4mm (8x8x7)/Cube 0:** Measurement grid: dx=4mm, dy=4mm, dz=1.4mm  
Reference Value = 56.82 V/m; Power Drift = 0.01 dB  
Peak SAR (extrapolated) = 35.1 W/kg  
**SAR(1 g) = 8.45 W/kg; SAR(10 g) = 2.42 W/kg**  
Maximum value of SAR (measured) = 20.4 W/kg

**Dipole Calibration /Pin=100mW, d=10mm, f=5600 MHz/Zoom Scan,**  
**dist=1.4mm (8x8x7)/Cube 0:** Measurement grid: dx=4mm, dy=4mm, dz=1.4mm  
Reference Value = 58.17 V/m; Power Drift = 0.02 dB  
Peak SAR (extrapolated) = 35.6 W/kg  
**SAR(1 g) = 8.18 W/kg; SAR(10 g) = 2.34 W/kg**  
Maximum value of SAR (measured) = 20.2 W/kg

**Dipole Calibration /Pin=100mW, d=10mm, f=5800 MHz/Zoom Scan,**  
**dist=1.4mm (8x8x7)/Cube 0:** Measurement grid: dx=4mm, dy=4mm, dz=1.4mm  
Reference Value = 47.45 V/m; Power Drift = 0.08 dB  
Peak SAR (extrapolated) = 35.8 W/kg  
**SAR(1 g) = 7.97 W/kg; SAR(10 g) = 2.29 W/kg**  
Maximum value of SAR (measured) = 19.4 W/kg

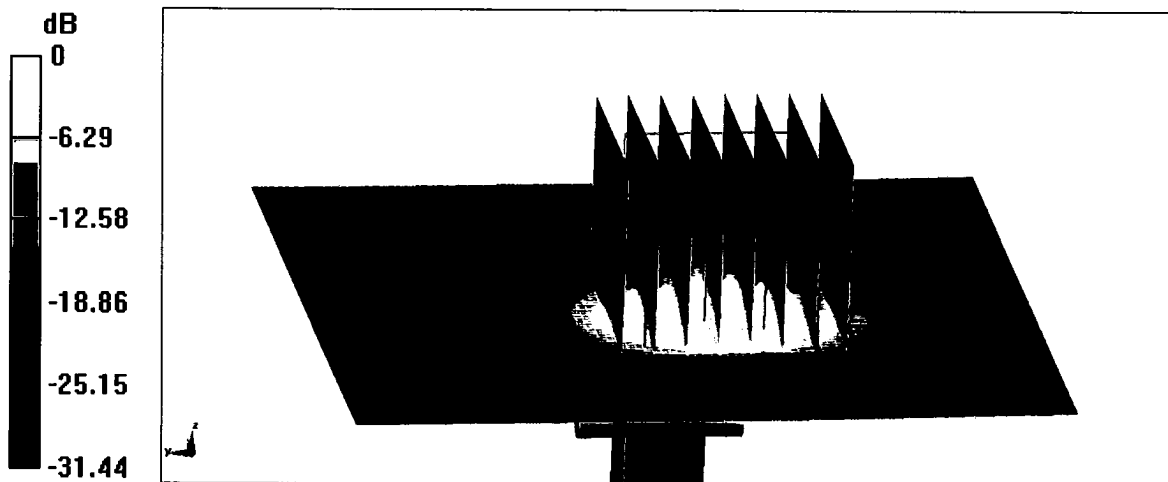

**0 dB = 19.4 W/kg = 12.88 dBW/kg**



Add: No.51 Xueyuan Road, Haidian District, Beijing, 100191, China  
Tel: +86-10-62304633-2079 Fax: +86-10-62304633-2504  
E-mail: cttl@chinattl.com http://www.chinattl.cn

### Impedance Measurement Plot for Head TSL

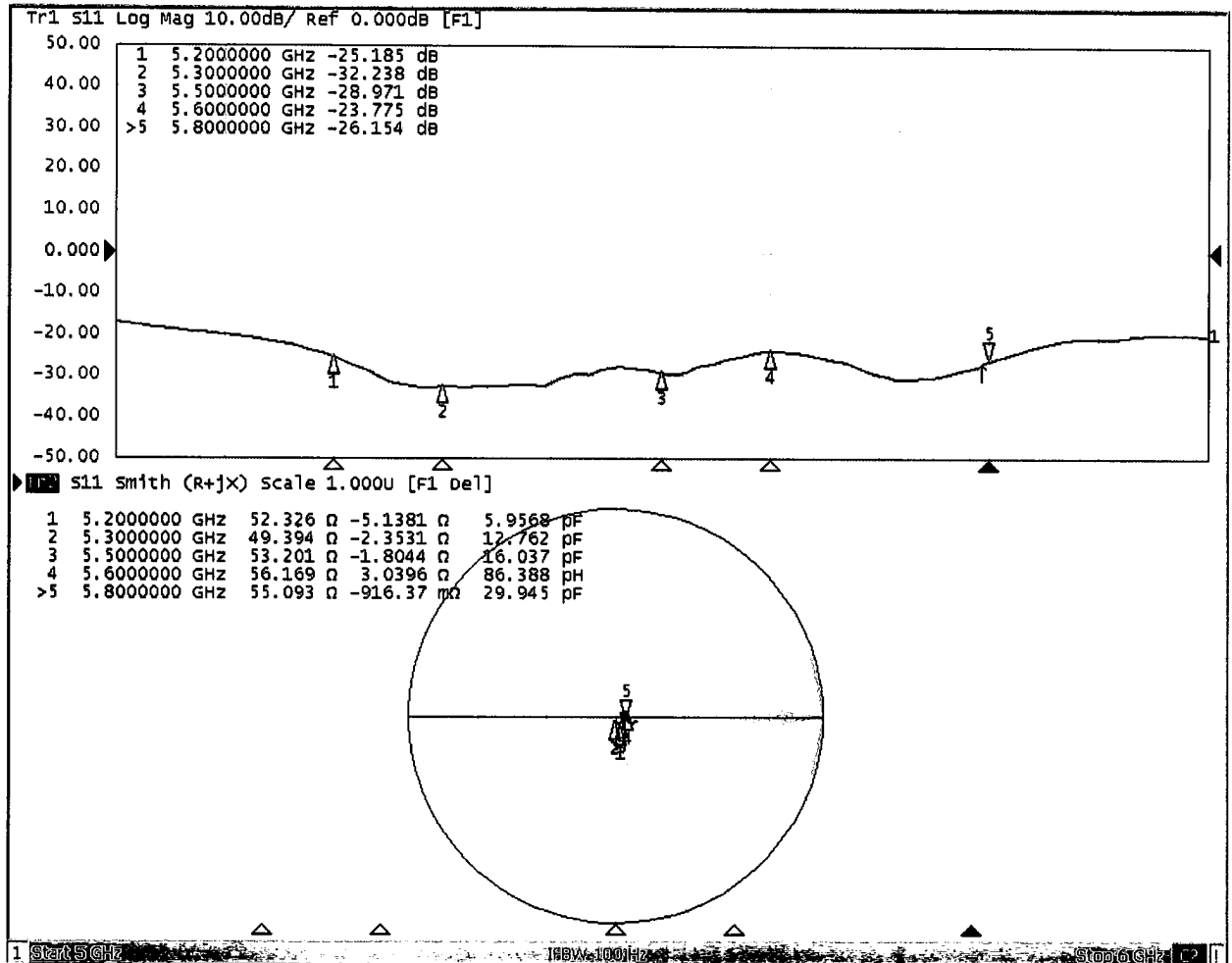



In Collaboration with

**s p e a g**  
**CALIBRATION LABORATORY**

Add: No.51 Xueyuan Road, Haidian District, Beijing, 100191, China  
Tel: +86-10-62304633-2079 Fax: +86-10-62304633-2504  
E-mail: cttl@chinattl.com http://www.chinattl.cn

## DASY5 Validation Report for Body TSL

Date: 09.25.2017

Test Laboratory: CTTL, Beijing, China

**DUT: Dipole 5GHz; Type: D5GHzV2; Serial: D5GHzV2 - SN: 1128**

Communication System: CW; Frequency: 5200 MHz, Frequency: 5300 MHz, Frequency: 5500 MHz, Frequency: 5600 MHz, Frequency: 5800 MHz,  
Medium parameters used:  $f = 5200$  MHz;  $\sigma = 5.382$  mho/m;  $\epsilon_r = 49.47$ ;  $\rho = 1000$  kg/m<sup>3</sup>, Medium parameters used:  $f = 5300$  MHz;  $\sigma = 5.498$  mho/m;  $\epsilon_r = 49.21$ ;  $\rho = 1000$  kg/m<sup>3</sup>, Medium parameters used:  $f = 5500$  MHz;  $\sigma = 5.722$  mho/m;  $\epsilon_r = 49.03$ ;  $\rho = 1000$  kg/m<sup>3</sup>, Medium parameters used:  $f = 5600$  MHz;  $\sigma = 5.733$  mho/m;  $\epsilon_r = 48.37$ ;  $\rho = 1000$  kg/m<sup>3</sup>, Medium parameters used:  $f = 5800$  MHz;  $\sigma = 5.935$  mho/m;  $\epsilon_r = 48.99$ ;  $\rho = 1000$  kg/m<sup>3</sup>,

Phantom section: Center Section

Measurement Standard: DASY5 (IEEE/IEC/ANSI C63.19-2007)

### DASY5 Configuration:

- Probe: EX3DV4 - SN3846; ConvF(4.95,4.95,4.95); Calibrated: 1/13/2017, ConvF(4.95,4.95,4.95); Calibrated: 1/13/2017, ConvF(4.18,4.18,4.18); Calibrated: 1/13/2017, ConvF(4.18,4.18,4.18); Calibrated: 1/13/2017, ConvF(4.53,4.53,4.53); Calibrated: 1/13/2017,
- Sensor-Surface: 1.4mm (Mechanical Surface Detection)
- Electronics: DAE4 Sn1331; Calibrated: 2017/1/19
- Phantom: Triple Flat Phantom 5.1C; Type: QD 000 P51 CA; Serial: 1161/3
- Measurement SW: DASY52, Version 52.10 (0); SEMCAD X Version 14.6.10 (7417)

**Dipole Calibration /Pin=100mW, d=10mm, f=5200 MHz/Zoom Scan, dist=1.4mm (8x8x7)/Cube 0:** Measurement grid: dx=4mm, dy=4mm, dz=1.4mm  
Reference Value = 54.22 V/m; Power Drift = 0.00 dB  
Peak SAR (extrapolated) = 29.8 W/kg  
**SAR(1 g) = 7.44 W/kg; SAR(10 g) = 2.1 W/kg**  
Maximum value of SAR (measured) = 18.0 W/kg

**Dipole Calibration /Pin=100mW, d=10mm, f=5300 MHz/Zoom Scan, dist=1.4mm (8x8x7)/Cube 0:** Measurement grid: dx=4mm, dy=4mm, dz=1.4mm  
Reference Value = 53.85 V/m; Power Drift = -0.01 dB  
Peak SAR (extrapolated) = 31.6 W/kg  
**SAR(1 g) = 7.58 W/kg; SAR(10 g) = 2.15 W/kg**  
Maximum value of SAR (measured) = 18.2 W/kg



Add: No.51 Xueyuan Road, Haidian District, Beijing, 100191, China  
Tel: +86-10-62304633-2079 Fax: +86-10-62304633-2504  
E-mail: cttl@chinattl.com http://www.chinattl.cn

**Dipole Calibration /Pin=100mW, d=10mm, f=5500 MHz/Zoom Scan,**  
**dist=1.4mm (8x8x7)/Cube 0:** Measurement grid: dx=4mm, dy=4mm, dz=1.4mm  
Reference Value = 66.63 V/m; Power Drift = -0.00 dB  
Peak SAR (extrapolated) = 33.6 W/kg  
**SAR(1 g) = 8.19 W/kg; SAR(10 g) = 2.34 W/kg**  
Maximum value of SAR (measured) = 19.9 W/kg

**Dipole Calibration /Pin=100mW, d=10mm, f=5600 MHz/Zoom Scan,**  
**dist=1.4mm (8x8x7)/Cube 0:** Measurement grid: dx=4mm, dy=4mm, dz=1.4mm  
Reference Value = 67.06 V/m; Power Drift = -0.02 dB  
Peak SAR (extrapolated) = 34.2 W/kg  
**SAR(1 g) = 8.01 W/kg; SAR(10 g) = 2.27 W/kg**  
Maximum value of SAR (measured) = 19.2 W/kg

**Dipole Calibration /Pin=100mW, d=10mm, f=5800 MHz/Zoom Scan,**  
**dist=1.4mm (8x8x7)/Cube 0:** Measurement grid: dx=4mm, dy=4mm, dz=1.4mm  
Reference Value = 68.63 V/m; Power Drift = -0.02 dB  
Peak SAR (extrapolated) = 33.8 W/kg  
**SAR(1 g) = 7.8 W/kg; SAR(10 g) = 2.19 W/kg**  
Maximum value of SAR (measured) = 18.6 W/kg

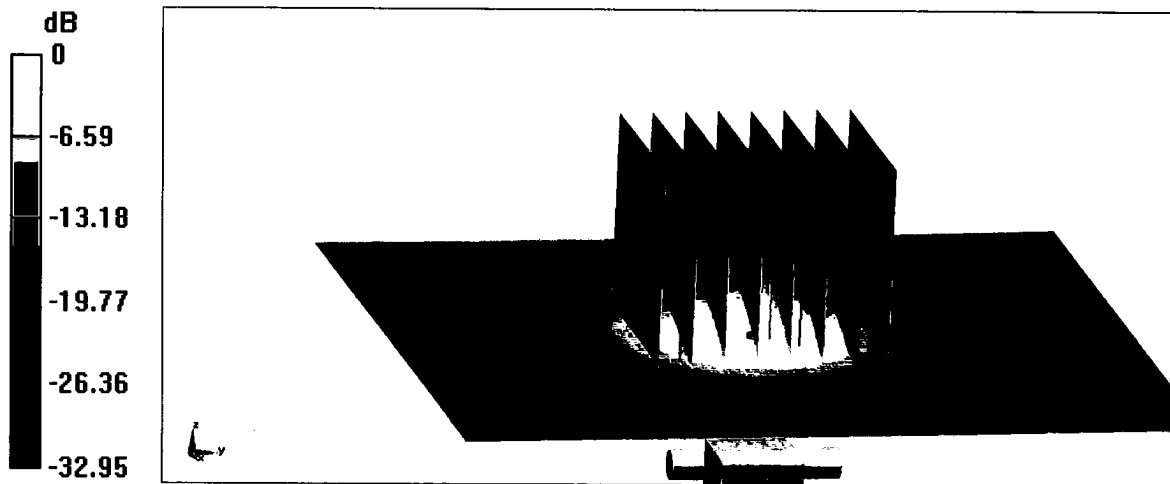

**0 dB = 18.6 W/kg = 12.70 dBW/kg**



Add: No.51 Xueyuan Road, Haidian District, Beijing, 100191, China  
Tel: +86-10-62304633-2079 Fax: +86-10-62304633-2504  
E-mail: cttl@chinattl.com http://www.chinattl.cn

### Impedance Measurement Plot for Body TSL

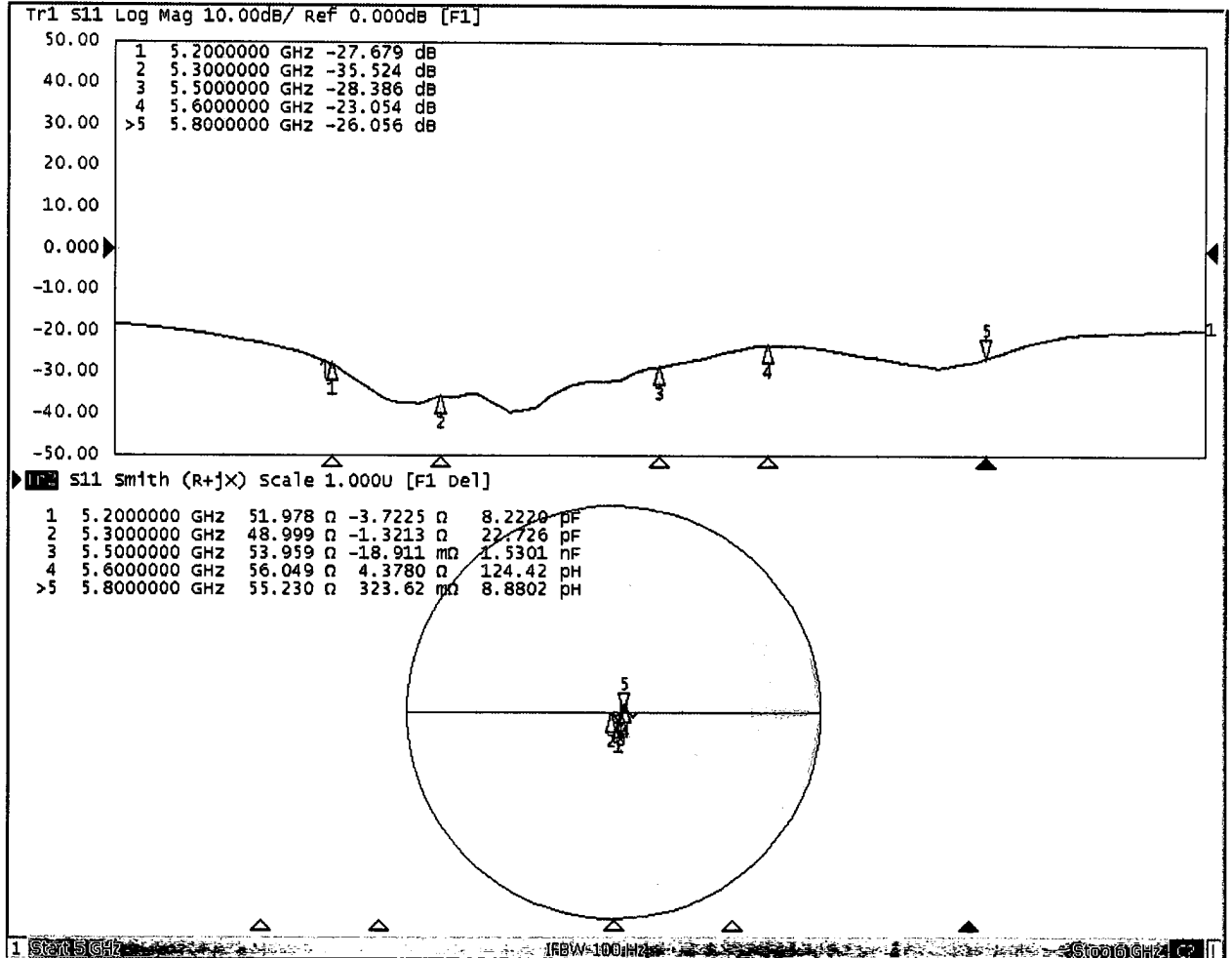



In Collaboration with  
**s p e a g**  
**CALIBRATION LABORATORY**



中国认可  
 国际互认  
 校准  
 CALIBRATION  
 CNAS L0570

Add: No.51 Xueyuan Road, Haidian District, Beijing, 100191, China  
 Tel: +86-10-62304633-2218 Fax: +86-10-62304633-2209  
 E-mail: cttl@chinattl.com Http://www.chinattl.cn

Client : **Sporton International INC**

Certificate No: **Z17-97205**

## CALIBRATION CERTIFICATE

Object **DAE4 - SN: 1358**

Calibration Procedure(s) **FF-Z11-002-01**  
**Calibration Procedure for the Data Acquisition Electronics (DAEx)**

Calibration date: **October 24, 2017**

This calibration Certificate documents the traceability to national standards, which realize the physical units of measurements(SI). The measurements and the uncertainties with confidence probability are given on the following pages and are part of the certificate.

All calibrations have been conducted in the closed laboratory facility: environment temperature(22±3)°C and humidity<70%.

Calibration Equipment used (M&TE critical for calibration)

| Primary Standards      | ID #    | Cal Date(Calibrated by, Certificate No.) | Scheduled Calibration |
|------------------------|---------|--|-----------------------|
| Process Calibrator 753 | 1971018 | 27-Jun-17 (CTTL, No.J17X05859)           | June-18               |

|                | Name        | Function           | Signature |
|----------------|-------------|--------------------|-----------|
| Calibrated by: | Yu Zongying | SAR Test Engineer  |           |
| Reviewed by:   | Lin Hao     | SAR Test Engineer  |           |
| Approved by:   | Qi Dianyuan | SAR Project Leader |           |

Issued: October 26, 2017

This calibration certificate shall not be reproduced except in full without written approval of the laboratory.



### **Glossary:**

DAE data acquisition electronics  
Connector angle information used in DASY system to align probe sensor X to the robot coordinate system.

### **Methods Applied and Interpretation of Parameters:**

- *DC Voltage Measurement:* Calibration Factor assessed for use in DASY system by comparison with a calibrated instrument traceable to national standards. The figure given corresponds to the full scale range of the voltmeter in the respective range.
- *Connector angle:* The angle of the connector is assessed measuring the angle mechanically by a tool inserted. Uncertainty is not required.
- The report provide only calibration results for DAE, it does not contain other performance test results.





Add: No.51 Xueyuan Road, Haidian District, Beijing, 100191, China  
 Tel: +86-10-62304633-2218 Fax: +86-10-62304633-2209  
 E-mail: cttl@chinattl.com Http://www.chinattl.cn

**DC Voltage Measurement**

A/D - Converter Resolution nominal

High Range: 1LSB = 6.1μV, full range = -100...+300 mV

Low Range: 1LSB = 61nV, full range = -1.....+3mV

DASY measurement parameters: Auto Zero Time: 3 sec; Measuring time: 3 sec

| Calibration Factors | X                     | Y                     | Z                     |
|---------------------|-----------------------|-----------------------|-----------------------|
| High Range          | 403.474 ± 0.15% (k=2) | 403.509 ± 0.15% (k=2) | 403.510 ± 0.15% (k=2) |
| Low Range           | 3.96147 ± 0.7% (k=2)  | 3.98783 ± 0.7% (k=2)  | 3.99209 ± 0.7% (k=2)  |

**Connector Angle**

|   |            |
|---|------------|
| Connector Angle to be used in DASY system | 134° ± 1 ° |
|---|------------|



In Collaboration with  
**s p e a g**  
**CALIBRATION LABORATORY**



中国认可  
 国际互认  
 校准  
 CALIBRATION  
 CNAS L0570

Add: No.51 Xueyuan Road, Haidian District, Beijing, 100191, China  
 Tel: +86-10-62304633-2218 Fax: +86-10-62304633-2209  
 E-mail: cttl@chinattl.com [Http://www.chinattl.cn](http://www.chinattl.cn)

Client **Sporton International INC**

Certificate No: **Z17-97257**

## CALIBRATION CERTIFICATE

Object **EX3DV4 - SN:3935**

Calibration Procedure(s) **FF-Z11-004-01**  
**Calibration Procedures for Dosimetric E-field Probes**

Calibration date: **December 14, 2017**

This calibration Certificate documents the traceability to national standards, which realize the physical units of measurements(SI). The measurements and the uncertainties with confidence probability are given on the following pages and are part of the certificate.

All calibrations have been conducted in the closed laboratory facility: environment temperature(22±3)°C and humidity<70%.

### Calibration Equipment used (M&TE critical for calibration)

| Primary Standards       | ID #        | Cal Date(Calibrated by, Certificate No.) | Scheduled Calibration |
|-------------------------|-------------|--|-----------------------|
| Power Meter NRP2        | 101919      | 27-Jun-17 (CTTL, No.J17X05857)           | Jun-18                |
| Power sensor NRP-Z91    | 101547      | 27-Jun-17 (CTTL, No.J17X05857)           | Jun-18                |
| Power sensor NRP-Z91    | 101548      | 27-Jun-17 (CTTL, No.J17X05857)           | Jun-18                |
| Reference10dBAttenuator | 18N50W-10dB | 13-Mar-16(CTTL,No.J16X01547)             | Mar-18                |
| Reference20dBAttenuator | 18N50W-20dB | 13-Mar-16(CTTL, No.J16X01548)            | Mar-18                |
| Reference Probe EX3DV4  | SN 7464     | 12-Sep-17(SPEAG,No.EX3-7464_Sep17)       | Sep-18                |
| DAE4                    | SN 549      | 13-Dec-16(SPEAG, No.DAE4-549_Dec16)      | Dec -17               |
| DAE4                    | SN 1524     | 13-Sep-17(SPEAG, No.DAE4-1524_Sep17)     | Sep -18               |
| Secondary Standards     | ID #        | Cal Date(Calibrated by, Certificate No.) | Scheduled Calibration |
| SignalGeneratorMG3700A  | 6201052605  | 27-Jun-17 (CTTL, No.J17X05858)           | Jun-18                |
| Network Analyzer E5071C | MY46110673  | 13-Jan-17 (CTTL, No.J17X00285)           | Jan -18               |

|                | Name        | Function           | Signature |
|----------------|-------------|--------------------|-----------|
| Calibrated by: | Yu Zongying | SAR Test Engineer  |           |
| Reviewed by:   | Lin Hao     | SAR Test Engineer  |           |
| Approved by:   | Qi Dianyuan | SAR Project Leader |           |

Issued: December 16, 2017

This calibration certificate shall not be reproduced except in full without written approval of the laboratory.



**Glossary:**

|                       |  |
|-----------------------|--|
| TSL                   | tissue simulating liquid   |
| NORM <sub>x,y,z</sub> | sensitivity in free space  |
| ConvF                 | sensitivity in TSL / NORM <sub>x,y,z</sub>   |
| DCP                   | diode compression point  |
| CF                    | crest factor (1/duty_cycle) of the RF signal   |
| A,B,C,D               | modulation dependent linearization parameters  |
| Polarization $\Phi$   | $\Phi$ rotation around probe axis  |
| Polarization $\theta$ | $\theta$ rotation around an axis that is in the plane normal to probe axis (at measurement center) |
| Connector Angle       | $\theta=0$ is normal to probe axis   |
|                       | information used in DASY system to align probe sensor X to the robot coordinate system             |

**Calibration is Performed According to the Following Standards:**

- a) IEEE Std 1528-2013, "IEEE Recommended Practice for Determining the Peak Spatial-Averaged Specific Absorption Rate (SAR) in the Human Head from Wireless Communications Devices: Measurement Techniques", June 2013
- b) IEC 62209-1, "Measurement procedure for the assessment of Specific Absorption Rate (SAR) from hand-held and body-mounted devices used next to the ear (frequency range of 300 MHz to 6 GHz)", July 2016
- c) IEC 62209-2, "Procedure to determine the Specific Absorption Rate (SAR) for wireless communication devices used in close proximity to the human body (frequency range of 30 MHz to 6 GHz)", March 2010
- d) KDB 865664, "SAR Measurement Requirements for 100 MHz to 6 GHz"

**Methods Applied and Interpretation of Parameters:**

- **NORM<sub>x,y,z</sub>:** Assessed for E-field polarization  $\theta=0$  ( $f \leq 900\text{MHz}$  in TEM-cell;  $f > 1800\text{MHz}$ : waveguide). NORM<sub>x,y,z</sub> are only intermediate values, i.e., the uncertainties of NORM<sub>x,y,z</sub> does not effect the  $E^2$ -field uncertainty inside TSL (see below ConvF).
- **NORM(f)<sub>x,y,z</sub> = NORM<sub>x,y,z</sub> \* frequency\_response** (see Frequency Response Chart). This linearization is implemented in DASY4 software versions later than 4.2. The uncertainty of the frequency response is included in the stated uncertainty of ConvF.
- **DCP<sub>x,y,z</sub>:** DCP are numerical linearization parameters assessed based on the data of power sweep (no uncertainty required). DCP does not depend on frequency nor media.
- **PAR:** PAR is the Peak to Average Ratio that is not calibrated but determined based on the signal characteristics.
- **A<sub>x,y,z</sub>; B<sub>x,y,z</sub>; C<sub>x,y,z</sub>; VR<sub>x,y,z</sub>:** A,B,C are numerical linearization parameters assessed based on the data of power sweep for specific modulation signal. The parameters do not depend on frequency nor media. VR is the maximum calibration range expressed in RMS voltage across the diode.
- **ConvF and Boundary Effect Parameters:** Assessed in flat phantom using E-field (or Temperature Transfer Standard for  $f \leq 800\text{MHz}$ ) and inside waveguide using analytical field distributions based on power measurements for  $f > 800\text{MHz}$ . The same setups are used for assessment of the parameters applied for boundary compensation (alpha, depth) of which typical uncertainty valued are given. These parameters are used in DASY4 software to improve probe accuracy close to the boundary. The sensitivity in TSL corresponds to NORM<sub>x,y,z</sub> \* ConvF whereby the uncertainty corresponds to that given for ConvF. A frequency dependent ConvF is used in DASY version 4.4 and higher which allows extending the validity from  $\pm 50\text{MHz}$  to  $\pm 100\text{MHz}$ .
- **Spherical isotropy (3D deviation from isotropy):** in a field of low gradients realized using a flat phantom exposed by a patch antenna.
- **Sensor Offset:** The sensor offset corresponds to the offset of virtual measurement center from the probe tip (on probe axis). No tolerance required.
- **Connector Angle:** The angle is assessed using the information gained by determining the NORM<sub>x</sub> (no uncertainty required).



In Collaboration with  
**s p e a g**  
**CALIBRATION LABORATORY**

Add: No.51 Xueyuan Road, Haidian District, Beijing, 100191, China  
Tel: +86-10-62304633-2218 Fax: +86-10-62304633-2209  
E-mail: [cttl@chinattl.com](mailto:cttl@chinattl.com) [Http://www.chinattl.cn](http://www.chinattl.cn)

# Probe EX3DV4

## SN: 3935

Calibrated: December 14, 2017

Calibrated for DASY/EASY Systems

(Note: non-compatible with DASY2 system!)



## DASY/EASY – Parameters of Probe: EX3DV4 – SN: 3935

### Basic Calibration Parameters

|  | Sensor X | Sensor Y | Sensor Z | Unc (k=2) |
|--|----------|----------|----------|-----------|
| Norm( $\mu\text{V}/(\text{V}/\text{m})^2$ ) <sup>A</sup> | 0.48     | 0.54     | 0.49     | ±10.0%    |
| DCP(mV) <sup>B</sup>                                     | 104.4    | 104.3    | 106.1    |           |

### Modulation Calibration Parameters

| UID | Communication System Name |   | A dB | B dB/ $\mu\text{V}$ | C   | D dB | VR mV | Unc <sup>E</sup> (k=2) |
|-----|---------------------------|---|------|---------------------|-----|------|-------|------------------------|
| 0   | CW                        | X | 0.0  | 0.0                 | 1.0 | 0.00 | 162.8 | ±2.2%                  |
|     |                           | Y | 0.0  | 0.0                 | 1.0 |      | 176.1 |                        |
|     |                           | Z | 0.0  | 0.0                 | 1.0 |      | 165.6 |                        |

The reported uncertainty of measurement is stated as the standard uncertainty of Measurement multiplied by the coverage factor k=2, which for a normal distribution Corresponds to a coverage probability of approximately 95%.

- <sup>A</sup> The uncertainties of Norm X, Y, Z do not affect the E<sup>2</sup>-field uncertainty inside TSL (see Page 5 and Page 6).  
<sup>B</sup> Numerical linearization parameter: uncertainty not required.  
<sup>E</sup> Uncertainty is determined using the max. deviation from linear response applying rectangular distribution and is expressed for the square of the field value.



## DASY/EASY – Parameters of Probe: EX3DV4 – SN: 3935

### Calibration Parameter Determined in Head Tissue Simulating Media

| f [MHz] <sup>C</sup> | Relative Permittivity <sup>F</sup> | Conductivity (S/m) <sup>F</sup> | ConvF X | ConvF Y | ConvF Z | Alpha <sup>G</sup> | Depth <sup>G</sup> (mm) | Unct. (k=2) |
|----------------------|------------------------------------|---------------------------------|---------|---------|---------|--------------------|-------------------------|-------------|
| 750                  | 41.9                               | 0.89                            | 10.68   | 10.68   | 10.68   | 0.40               | 0.70                    | ± 12.1%     |
| 835                  | 41.5                               | 0.90                            | 10.36   | 10.36   | 10.36   | 0.10               | 1.67                    | ± 12.1%     |
| 900                  | 41.5                               | 0.97                            | 10.22   | 10.22   | 10.22   | 0.16               | 1.29                    | ± 12.1%     |
| 1750                 | 40.1                               | 1.37                            | 8.85    | 8.85    | 8.85    | 0.22               | 1.08                    | ± 12.1%     |
| 1900                 | 40.0                               | 1.40                            | 8.41    | 8.41    | 8.41    | 0.26               | 0.94                    | ± 12.1%     |
| 2000                 | 40.0                               | 1.40                            | 8.41    | 8.41    | 8.41    | 0.28               | 0.90                    | ± 12.1%     |
| 2300                 | 39.5                               | 1.67                            | 8.39    | 8.39    | 8.39    | 0.44               | 0.79                    | ± 12.1%     |
| 2450                 | 39.2                               | 1.80                            | 7.87    | 7.87    | 7.87    | 0.53               | 0.73                    | ± 12.1%     |
| 2600                 | 39.0                               | 1.96                            | 7.67    | 7.67    | 7.67    | 0.60               | 0.68                    | ± 12.1%     |
| 5200                 | 36.0                               | 4.66                            | 5.91    | 5.91    | 5.91    | 0.35               | 1.50                    | ± 13.3%     |
| 5300                 | 35.9                               | 4.76                            | 5.63    | 5.63    | 5.63    | 0.35               | 1.50                    | ± 13.3%     |
| 5500                 | 35.6                               | 4.96                            | 5.29    | 5.29    | 5.29    | 0.35               | 1.60                    | ± 13.3%     |
| 5600                 | 35.5                               | 5.07                            | 5.08    | 5.08    | 5.08    | 0.35               | 1.60                    | ± 13.3%     |
| 5800                 | 35.3                               | 5.27                            | 5.15    | 5.15    | 5.15    | 0.40               | 1.40                    | ± 13.3%     |

<sup>C</sup> Frequency validity above 300 MHz of ±100MHz only applies for DASY v4.4 and higher (Page 2), else it is restricted to ±50MHz. The uncertainty is the RSS of ConvF uncertainty at calibration frequency and the uncertainty for the indicated frequency band. Frequency validity below 300 MHz is ± 10, 25, 40, 50 and 70 MHz for ConvF assessments at 30, 64, 128, 150 and 220 MHz respectively. Above 5 GHz frequency validity can be extended to ± 110 MHz.

<sup>F</sup> At frequency below 3 GHz, the validity of tissue parameters ( $\epsilon$  and  $\sigma$ ) can be relaxed to ±10% if liquid compensation formula is applied to measured SAR values. At frequencies above 3 GHz, the validity of tissue parameters ( $\epsilon$  and  $\sigma$ ) is restricted to ±5%. The uncertainty is the RSS of the ConvF uncertainty for indicated target tissue parameters.

<sup>G</sup> Alpha/Depth are determined during calibration. SPEAG warrants that the remaining deviation due to the boundary effect after compensation is always less than ± 1% for frequencies below 3 GHz and below ± 2% for the frequencies between 3-6 GHz at any distance larger than half the probe tip diameter from the boundary.



## DASY/EASY – Parameters of Probe: EX3DV4 – SN: 3935

### Calibration Parameter Determined in Body Tissue Simulating Media

| f [MHz] <sup>C</sup> | Relative Permittivity <sup>F</sup> | Conductivity (S/m) <sup>F</sup> | ConvF X | ConvF Y | ConvF Z | Alpha <sup>G</sup> | Depth <sup>G</sup> (mm) | Unct. (k=2) |
|----------------------|------------------------------------|---------------------------------|---------|---------|---------|--------------------|-------------------------|-------------|
| 750                  | 55.5                               | 0.96                            | 10.65   | 10.65   | 10.65   | 0.40               | 0.80                    | ± 12.1%     |
| 835                  | 55.2                               | 0.97                            | 10.33   | 10.33   | 10.33   | 0.17               | 1.41                    | ± 12.1%     |
| 1750                 | 53.4                               | 1.49                            | 8.71    | 8.71    | 8.71    | 0.26               | 0.99                    | ± 12.1%     |
| 1900                 | 53.3                               | 1.52                            | 8.30    | 8.30    | 8.30    | 0.16               | 1.39                    | ± 12.1%     |
| 2300                 | 52.9                               | 1.81                            | 8.10    | 8.10    | 8.10    | 0.32               | 1.16                    | ± 12.1%     |
| 2450                 | 52.7                               | 1.95                            | 7.99    | 7.99    | 7.99    | 0.29               | 1.25                    | ± 12.1%     |
| 2600                 | 52.5                               | 2.16                            | 7.71    | 7.71    | 7.71    | 0.39               | 0.95                    | ± 12.1%     |
| 5200                 | 49.0                               | 5.30                            | 5.41    | 5.41    | 5.41    | 0.45               | 1.30                    | ± 13.3%     |
| 5300                 | 48.9                               | 5.42                            | 5.20    | 5.20    | 5.20    | 0.40               | 1.30                    | ± 13.3%     |
| 5500                 | 48.6                               | 5.65                            | 4.62    | 4.62    | 4.62    | 0.40               | 1.70                    | ± 13.3%     |
| 5600                 | 48.5                               | 5.77                            | 4.51    | 4.51    | 4.51    | 0.45               | 1.55                    | ± 13.3%     |
| 5800                 | 48.2                               | 6.00                            | 4.64    | 4.64    | 4.64    | 0.58               | 1.07                    | ± 13.3%     |

<sup>C</sup> Frequency validity above 300 MHz of ±100MHz only applies for DASY v4.4 and higher (Page 2), else it is restricted to ±50MHz. The uncertainty is the RSS of ConvF uncertainty at calibration frequency and the uncertainty for the indicated frequency band. Frequency validity below 300 MHz is ± 10, 25, 40, 50 and 70 MHz for ConvF assessments at 30, 64, 128, 150 and 220 MHz respectively. Above 5 GHz frequency validity can be extended to ± 110 MHz.

<sup>F</sup> At frequency below 3 GHz, the validity of tissue parameters ( $\epsilon$  and  $\sigma$ ) can be relaxed to ±10% if liquid compensation formula is applied to measured SAR values. At frequencies above 3 GHz, the validity of tissue parameters ( $\epsilon$  and  $\sigma$ ) is restricted to ±5%. The uncertainty is the RSS of the ConvF uncertainty for indicated target tissue parameters.

<sup>G</sup> Alpha/Depth are determined during calibration. SPEAG warrants that the remaining deviation due to the boundary effect after compensation is always less than ± 1% for frequencies below 3 GHz and below ± 2% for the frequencies between 3-6 GHz at any distance larger than half the probe tip diameter from the boundary.



## Frequency Response of E-Field (TEM-Cell: ifi110 EXX, Waveguide: R22)

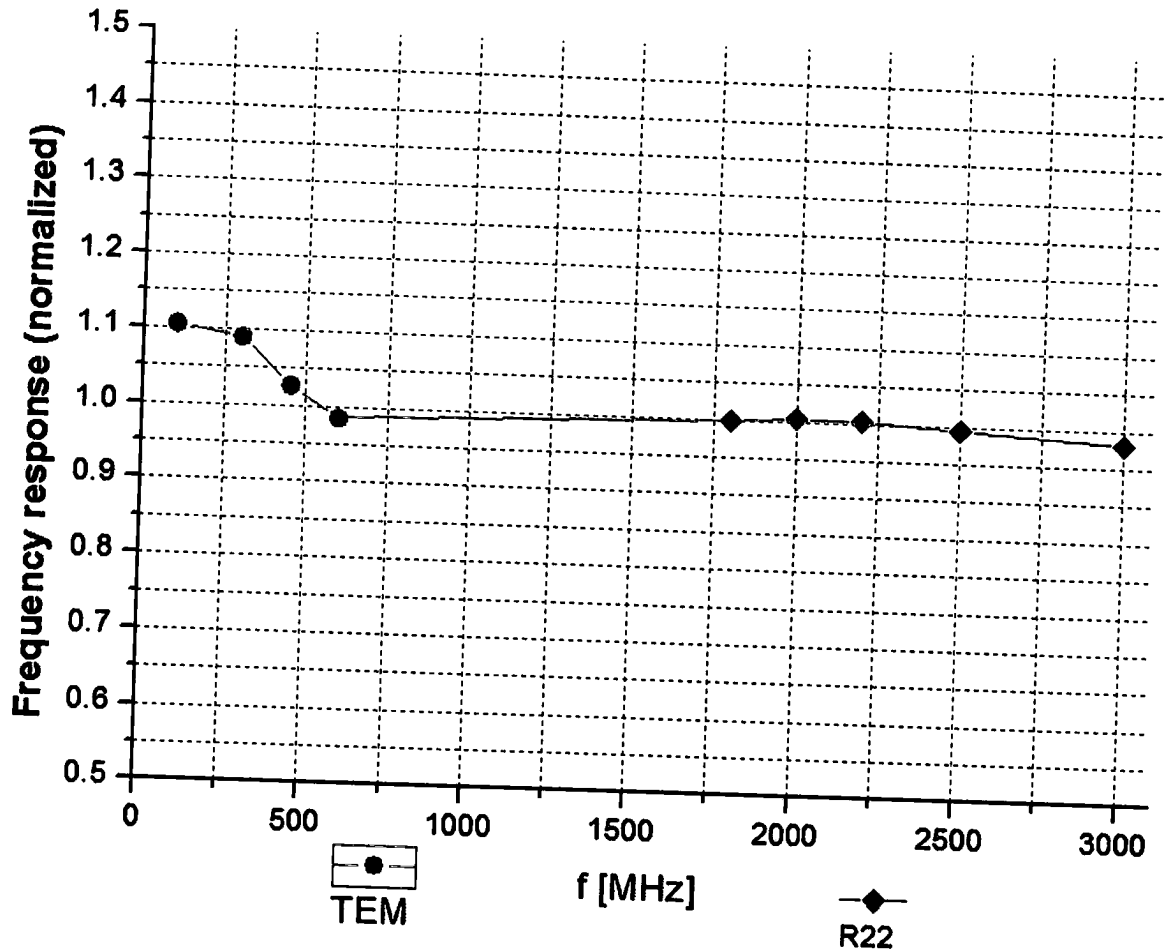

Uncertainty of Frequency Response of E-field:  $\pm 7.4\%$  ( $k=2$ )



# Receiving Pattern ( $\Phi$ ), $\theta=0^\circ$

**f=600 MHz, TEM**

**f=1800 MHz, R22**

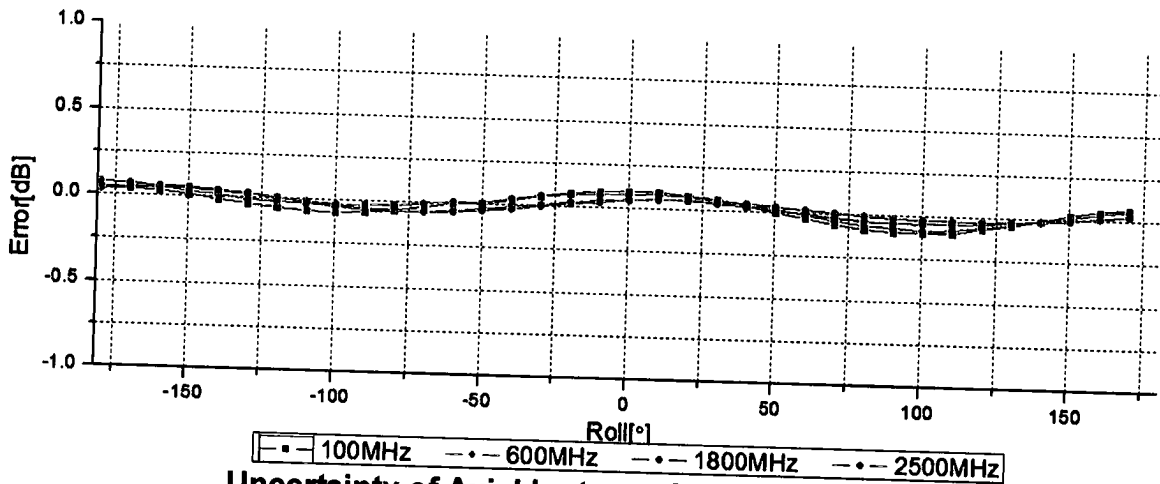
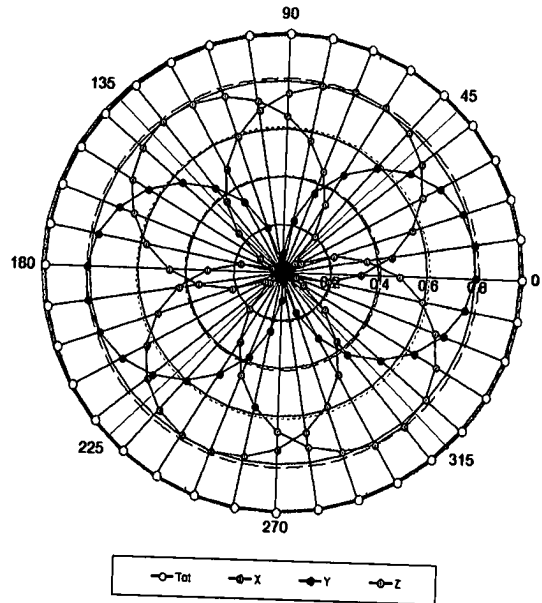
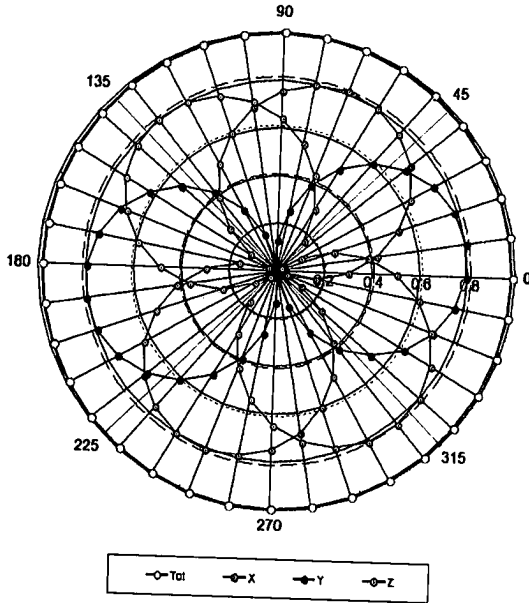

**Uncertainty of Axial Isotropy Assessment:  $\pm 1.2\%$  ( $k=2$ )**



### Dynamic Range $f(\text{SAR}_{\text{head}})$ (TEM cell, $f = 900 \text{ MHz}$ )

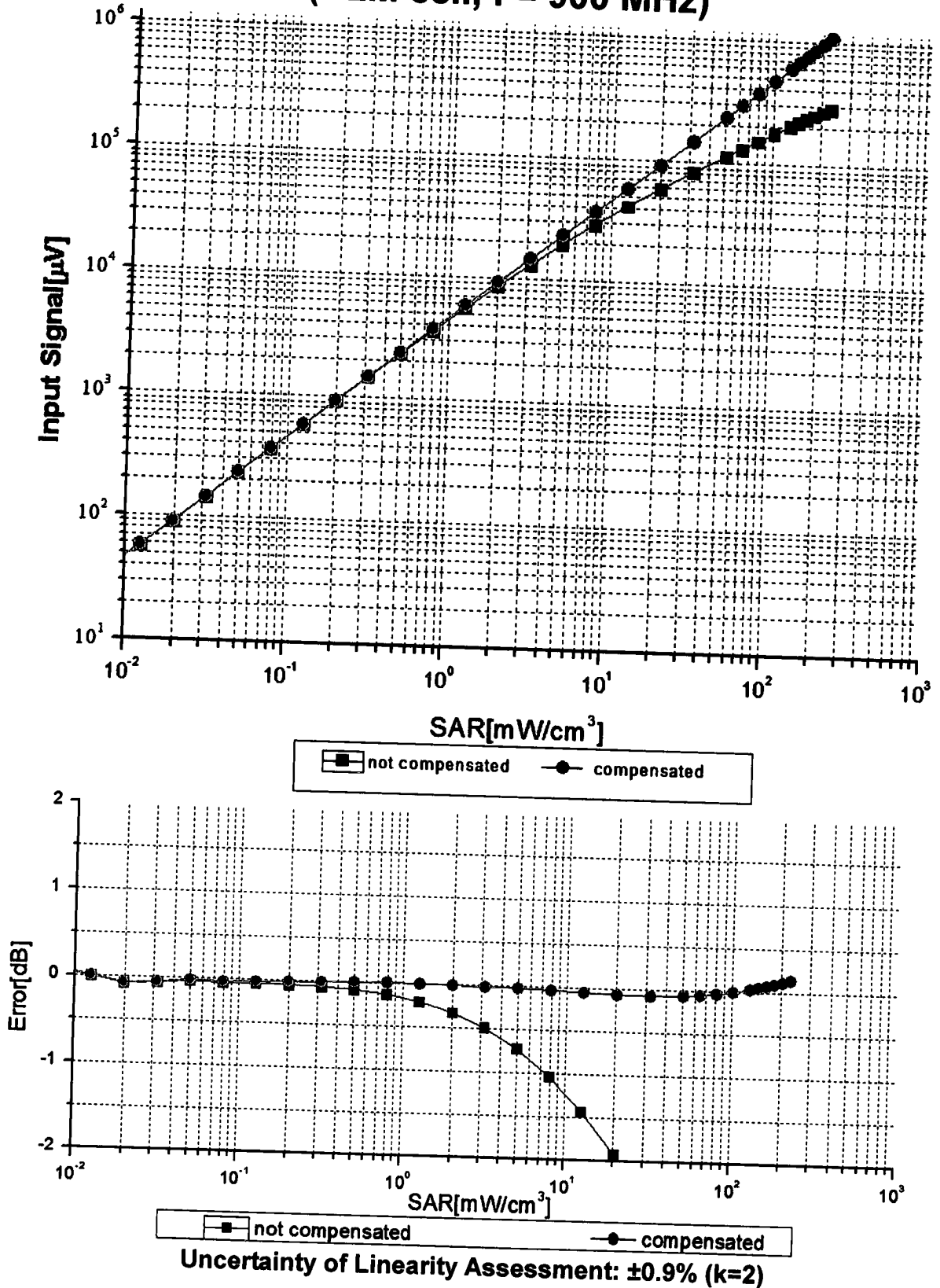



# Conversion Factor Assessment

f=850 MHz, WGLS R9(H\_convF)

f=1750 MHz, WGLS R22(H\_convF)

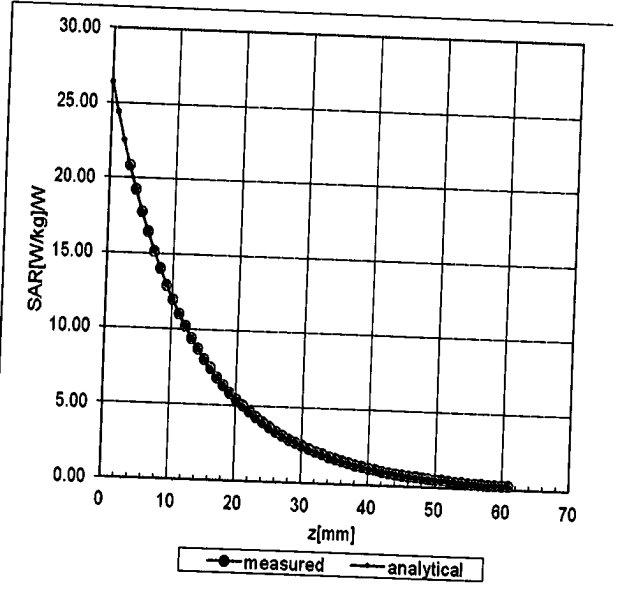
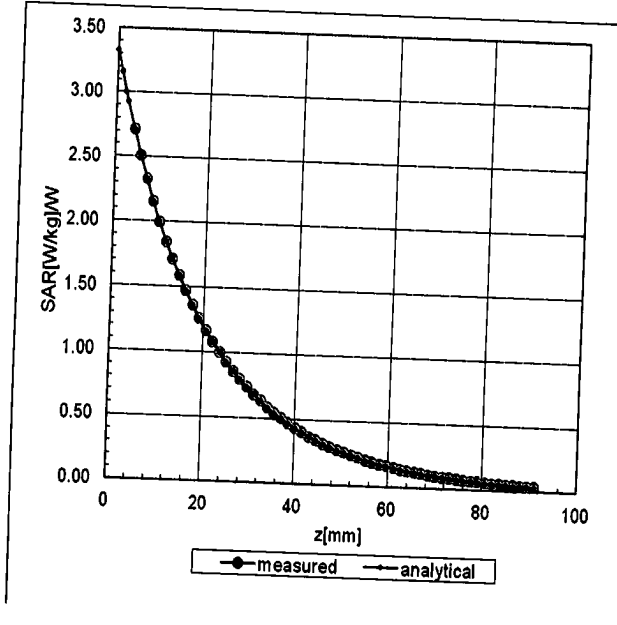

## Deviation from Isotropy in Liquid

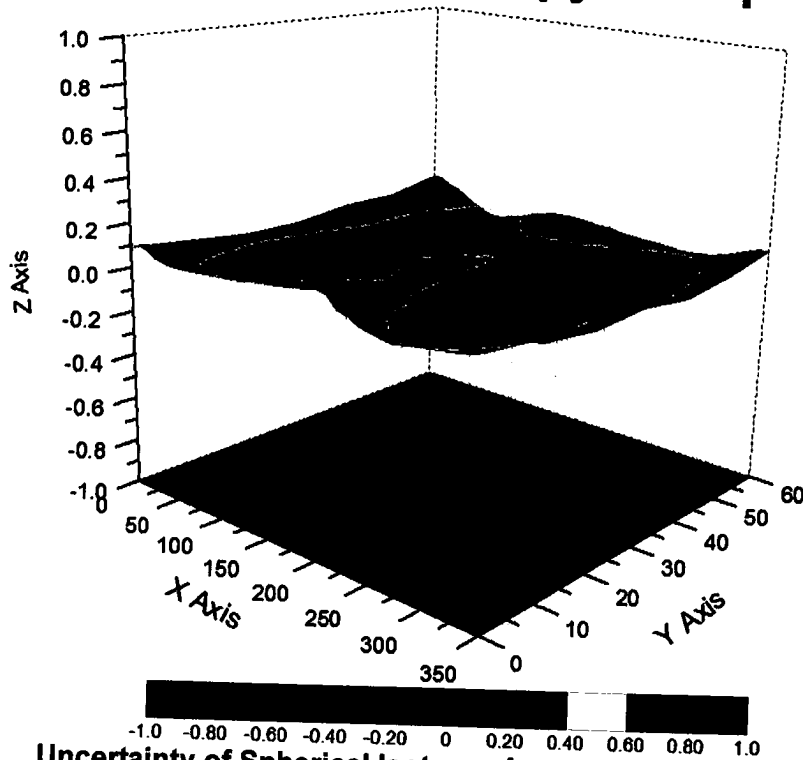

Uncertainty of Spherical Isotropy Assessment:  $\pm 3.2\%$  (K=2)



Add: No.51 Xueyuan Road, Haidian District, Beijing, 100191, China  
Tel: +86-10-62304633-2218 Fax: +86-10-62304633-2209  
E-mail: [ctl@chinattl.com](mailto:ctl@chinattl.com) [Http://www.chinattl.cn](http://www.chinattl.cn)

## DASY/EASY – Parameters of Probe: EX3DV4 – SN: 3935

### Other Probe Parameters

|   |            |
|---|------------|
| Sensor Arrangement                            | Triangular |
| Connector Angle (°)                           | 42.2       |
| Mechanical Surface Detection Mode             | enabled    |
| Optical Surface Detection Mode                | disable    |
| Probe Overall Length                          | 337mm      |
| Probe Body Diameter                           | 10mm       |
| Tip Length                                    | 9mm        |
| Tip Diameter                                  | 2.5mm      |
| Probe Tip to Sensor X Calibration Point       | 1mm        |
| Probe Tip to Sensor Y Calibration Point       | 1mm        |
| Probe Tip to Sensor Z Calibration Point       | 1mm        |
| Recommended Measurement Distance from Surface | 1.4mm      |