

# FCC Radio Test Report

**FCC ID: O57C640RTL8852**

**Project No.** : 2007T046B  
**Equipment** : Notebook Computer  
**Brand Name** : Lenovo  
**Test Model** : Yoga 6 13ARE05  
**Series Model** : Yoga 6 13ARE05\*\*\*\*\*, Yoga 6 13ALC6, Yoga 6 13ALC6\*\*\*\*\*(\*=0~9, A~z, “\_” or blank)  
**Applicant** : Lenovo (Shanghai) Electronics Technology Co., Ltd.  
**Address** : Section 304-305, Building No. 4, # 222, Meiyue Road, China (Shanghai) Pilot Free Trade Zone  
**Manufacturer** : Lenovo PC HK Limited  
**Address** : 23/F, Lincoln House, Taikoo Place 979 King's Road, Quarry Bay, Hong Kong, P.R.China  
**Date of Receipt** : Apr. 13, 2021  
**Date of Test** : Apr. 13, 2021 ~ May 04, 2021  
**Issued Date** : May 12, 2021  
**Report Version** : R00  
**Standard(s)** : FCC Part15, Subpart C (15.247)  
ANSI C63.10-2013  
FCC KDB 558074 D01 15.247 Meas Guidance v05r02

The above equipment has been tested and found compliance with the requirement of the relative standards by BTL Inc.



Prepared by : Welly Zhou



Approved by : Ethan Ma



Certificate #5123.02

Add: No.3, Jinshagang 1st Road, Shixia, Dalang Town, Dongguan, Guangdong, China.

Tel: +86-769-8318-3000

Web: www.newbtl.com

**Declaration**

**BTL** represents to the client that testing is done in accordance with standard procedures as applicable and that test instruments used has been calibrated with standards traceable to international standard(s) and/or national standard(s).

**BTL's** reports apply only to the specific samples tested under conditions. It is manufacture's responsibility to ensure that additional production units of this model are manufactured with the identical electrical and mechanical components. **BTL** shall have no liability for any declarations, inferences or generalizations drawn by the client or others from **BTL** issued reports.

The report must not be used by the client to claim product certification, approval, or endorsement by NVLAP, NIST, A2LA, or any agency of the U.S. Government.

This report is the confidential property of the client. As a mutual protection to the clients, the public and ourselves, the test report shall not be reproduced, except in full, without our written approval.

**BTL's** laboratory quality assurance procedures are in compliance with the **ISO/IEC 17025** requirements, and accredited by the conformity assessment authorities listed in this test report.

**BTL** is not responsible for the sampling stage, so the results only apply to the sample as received.

The information, data and test plan are provided by manufacturer which may affect the validity of results, so it is manufacturer's responsibility to ensure that the apparatus meets the essential requirements of applied standards and in all the possible configurations as representative of its intended use.

**Limitation**

For the use of the authority's logo is limited unless the Test Standard(s)/Scope(s)/Item(s) mentioned in this test report is (are) included in the conformity assessment authorities acceptance respective.

Please note that the measurement uncertainty is provided for informational purpose only and are not use in determining the Pass/Fail results.

<b>Table of Contents</b>	<b>Page</b>
<b>REVISION HISTORY</b>	<b>4</b>
<b>1 . SUMMARY OF TEST RESULTS</b>	<b>5</b>
1.1 TEST FACILITY	6
1.2 MEASUREMENT UNCERTAINTY	6
1.3 TEST ENVIRONMENT CONDITIONS	6
<b>2 . GENERAL INFORMATION</b>	<b>7</b>
2.1 GENERAL DESCRIPTION OF EUT	7
2.2 DESCRIPTION OF TEST MODES	9
2.3 BLOCK DIAGRAM SHOWING THE CONFIGURATION OF SYSTEM TESTED	10
2.4 SUPPORT UNITS	10
<b>3 . AC POWER LINE CONDUCTED EMISSIONS TEST</b>	<b>11</b>
3.1 LIMIT	11
3.2 TEST PROCEDURE	11
3.3 DEVIATION FROM TEST STANDARD	11
3.4 TEST SETUP	12
3.5 EUT OPERATING CONDITIONS	12
3.6 TEST RESULTS	12
<b>4 . RADIATED EMISSION TEST</b>	<b>13</b>
4.1 LIMIT	13
4.2 TEST PROCEDURE	14
4.3 DEVIATION FROM TEST STANDARD	14
4.4 TEST SETUP	15
4.5 EUT OPERATING CONDITIONS	17
4.6 TEST RESULTS - 30 MHZ TO 1000 MHZ	17
4.7 TEST RESULTS - ABOVE 1000 MHZ	17
<b>5 . MEASUREMENT INSTRUMENTS LIST</b>	<b>18</b>
<b>6 . EUT TEST PHOTO</b>	<b>19</b>
<b>APPENDIX A - AC POWER LINE CONDUCTED EMISSIONS</b>	<b>22</b>
<b>APPENDIX B - RADIATED EMISSION - 30 MHZ TO 1000 MHZ</b>	<b>27</b>
<b>APPENDIX C - RADIATED EMISSION - ABOVE 1000 MHZ</b>	<b>30</b>

**REVISION HISTORY**

Report No.	Version	Description	Issued Date
BTL-FCCP-1-2007T046	R00	Original Report.	Aug. 28, 2020
BTL-FCCP-1-2007T046A	R00	1. Added Series models. 2. Added CPU. 3. Added a new appearance without cover. 4. Changed adapter.	Mar. 23, 2021
BTL-FCCP-1-2007T046B	R00	1. Added Realtek / RTL8852AE module card. 2. Added adapter * 2.	May 12, 2021

## 1. SUMMARY OF TEST RESULTS

Test procedures according to the technical standard(s):

FCC Part15, Subpart C (15.247)				
Standard(s) Section	Test Item	Test Result	Judgment	Remark
15.207	AC Power Line Conducted Emissions	APPENDIX A	PASS	-----
15.247(d) 15.205(a) 15.209(a)	Radiated Emission	APPENDIX B APPENDIX C	PASS	-----

Note:

- (1) "N/A" denotes test is not applicable to this device.
- (2) This is to request a Class II permissive change for FCC ID: O57C640RTL8852.

This FCC ID: O57C640RTL8852 is change ID based Realtek Semiconductor Corp., the original application information follow as model: RTL8852AE, FCC ID: TX2-RTL8852AE, approved on 10/16/2020)

Thus, only conducted emissions and radiated spurious emissions were evaluated and recorded in this report. For the test results of all other test items please refer to module test report as below table:

RF Module model	Report Number	Module Function
RTL8852AE	RF200522E04	WLAN 2.4G
RTL8852AE	RF200522E04-1	RLAN 5G Band 1~4
RTL8852AE	RF200522E04-2	Bluetooth EDR
RTL8852AE	RF200522E04-3	Bluetooth LE

- (3) Based on the RF module the antennas for this Notebook Computer were updated as below table:

Antenna Information				
Antenna 1 (WLAN combo)	Manufacturer	AWAN		
	Antenna Type	Main: PIFA Antenna	Aux: PIFA Antenna	
	Part number	AUF6Y-100025 (DC33002GC00)	AUF6Y-100026 (DC33002GC10)	
	Peak gain	Main Antenna :	Aux Antenna :	
		WLAN(2.4G):1.14dBi	WLAN(2.4G):-1.53dBi	
		WLAN(5G B1-3):-1.73dBi WLAN(5G B4):-2.83dBi	WLAN(5G B1-3):-2.43dBi WLAN(5G B4):-1.54dBi	

### 1.1 TEST FACILITY

The test facilities used to collect the test data in this report is at the location of No.3, Jinshagang 1st Road, Shixia, Dalang Town, Dongguan, Guangdong, China  
 BTL's Test Firm Registration Number for FCC: 357015  
 BTL's Designation Number for FCC: CN1240

### 1.2 MEASUREMENT UNCERTAINTY

ISO/IEC 17025 requires that an estimate of the measurement uncertainties associated with the emissions test results be included in the report. The measurement uncertainties given below are based on a 95% confidence level (based on a coverage factor (k=2))  
 The BTL measurement uncertainty as below table:

#### A. AC power line conducted emissions test:

Test Site	Method	Measurement Frequency Range	U, (dB)
DG-C02	CISPR	150kHz ~ 30MHz	2.60

#### B. Radiated emissions test:

Test Site	Method	Measurement Frequency Range	Ant. H / V	U, (dB)
DG-CB03	CISPR	9kHz ~ 30MHz	V	3.79
		9kHz ~ 30MHz	H	3.57
		30MHz ~ 200MHz	V	4.88
		30MHz ~ 200MHz	H	4.14
		200MHz ~ 1,000MHz	V	4.62
		200MHz ~ 1,000MHz	H	4.80
		1GHz ~ 6GHz	-	4.58
		6GHz ~ 18GHz	-	5.18
		18GHz ~ 26.5GHz	-	3.62
		26.5GHz ~ 40GHz	-	4.00

Note: Unless specifically mentioned, the uncertainty of measurement has not been taken into account to declare the compliance or non-compliance to the specification.

### 1.3 TEST ENVIRONMENT CONDITIONS

Test Item	Temperature	Humidity	Test Voltage	Tested By
AC Power Line Conducted Emissions	24°C	73%	AC 120V/60Hz	Kwok Guo
Radiated Emissions-30 MHz to 1GHz	26°C	52%	AC 120V/60Hz	Kwok Guo
Radiated Emissions-Above 1000 MHz	26°C	52%	AC 120V/60Hz	Kwok Guo

## 2. GENERAL INFORMATION

### 2.1 GENERAL DESCRIPTION OF EUT

Equipment	Notebook Computer
Brand Name	Lenovo
Test Model	Yoga 6 13ARE05
Series Model	Yoga 6 13ARE05*****, Yoga 6 13ALC6, Yoga 6 13ALC6*****( *=0~9, A~z, " " or blank)
Model Difference(s)	Differ in marketing purpose.
Hardware Version	LA-K211P
Software Version	19041.329
RF Module Model	RTL8852AE
EUT Power Rating	20Vdc 2.25A
Power Adapter Power Rating	1. Brand: Acbel (Lenovo) M/N: ADLX45YAC3D I/P: 100-240V~1.2A 50-60Hz O/P: 20.0Vdc 2.25A 45.0W/15.0Vdc 3.0A/9.0Vdc 2.0A/5.0Vdc 2.0A 10.0W 2. Brand: Chicony (Lenovo) M/N: ADLX45YCC3G I/P: 100-240V~1.3A 50-60Hz O/P: 20.0Vdc 2.25A 45.0W / 15Vdc 3A / 9Vdc 2A / 5.0Vdc 2.0A 10.0W 3. Brand: Delta (Lenovo) M/N: ADLX45YDC3D I/P: 100-240V~1.2A 50-60Hz O/P: 20.0Vdc 2.25A 45.0W / 15.0Vdc 3.0A / 9.0Vdc 2.0A / 5.0Vdc 2.0A 10.0W
Power Adapter	1. Acbel (Lenovo) / ADLX45YAC3D 2. Chicony (Lenovo) / ADLX45YCC3G 3. Delta (Lenovo) / ADLX45YDC3D
Operation Frequency	2402 MHz ~ 2480 MHz
Modulation Technology	GFSK, $\pi/4$ -DQPSK, 8-DPSK
Bit Rate of Transmitter	1 Mbps, 2 Mbps, 3Mbps
Max. Output Power (Reference module report)	3 Mbps: 12.95 dBm (0.01972 W)

Note:

1. For a more detailed features description, please refer to the manufacturer's specifications or the user's manual.
2. This is a supplement report of BTL-FCCP-1-2007T046, BTL-FCCP-1-2007T046A report. The differences compared with original report are
  - a. Added Realtek / RTL8852AE module card.
  - b. Added adapter \* 2.
 After evaluated, the changes with respect to the original one, all tests need to re-test.

## 3. Channel List:

Channel	Frequency (MHz)	Channel	Frequency (MHz)	Channel	Frequency (MHz)
00	2402	27	2429	54	2456
01	2403	28	2430	55	2457
02	2404	29	2431	56	2458
03	2405	30	2432	57	2459
04	2406	31	2433	58	2460
05	2407	32	2434	59	2461
06	2408	33	2435	60	2462
07	2409	34	2436	61	2463
08	2410	35	2437	62	2464
09	2411	36	2438	63	2465
10	2412	37	2439	64	2466
11	2413	38	2440	65	2467
12	2414	39	2441	66	2468
13	2415	40	2442	67	2469
14	2416	41	2443	68	2470
15	2417	42	2444	69	2471
16	2418	43	2445	70	2472
17	2419	44	2446	71	2473
18	2420	45	2447	72	2474
19	2421	46	2448	73	2475
20	2422	47	2449	74	2476
21	2423	48	2450	75	2477
22	2424	49	2451	76	2478
23	2425	50	2452	77	2479
24	2426	51	2453	78	2480
25	2427	52	2454		
26	2428	53	2455		



**2.2 DESCRIPTION OF TEST MODES**

Test Items	Test mode	Channel	Note
AC power line conducted emissions	Normal/Idle	-	-
Transmitter Radiated Emissions (below 1GHz)	1 Mbps	78	-
Transmitter Radiated Emissions (above 1GHz)	1/3 Mbps	00/78	Bandedge
	1/3 Mbps	00/39/78	Harmonic

**NOTE:**

- (1) The Radiated emissions test was verified based on the worst conducted power and Bandwidth test results reported in the original report.
- (2) For radiated emission band edge test, both Vertical and Horizontal are evaluated, but only the worst case (Horizontal) is recorded.
- (3) All X, Y and Z axes are evaluated, but only the worst case (Y axis) is recorded.
- (4) There were no emissions found below 30 MHz within 20 dB of the limit.

**2.3 BLOCK DIAGRAM SHOWING THE CONFIGURATION OF SYSTEM TESTED**

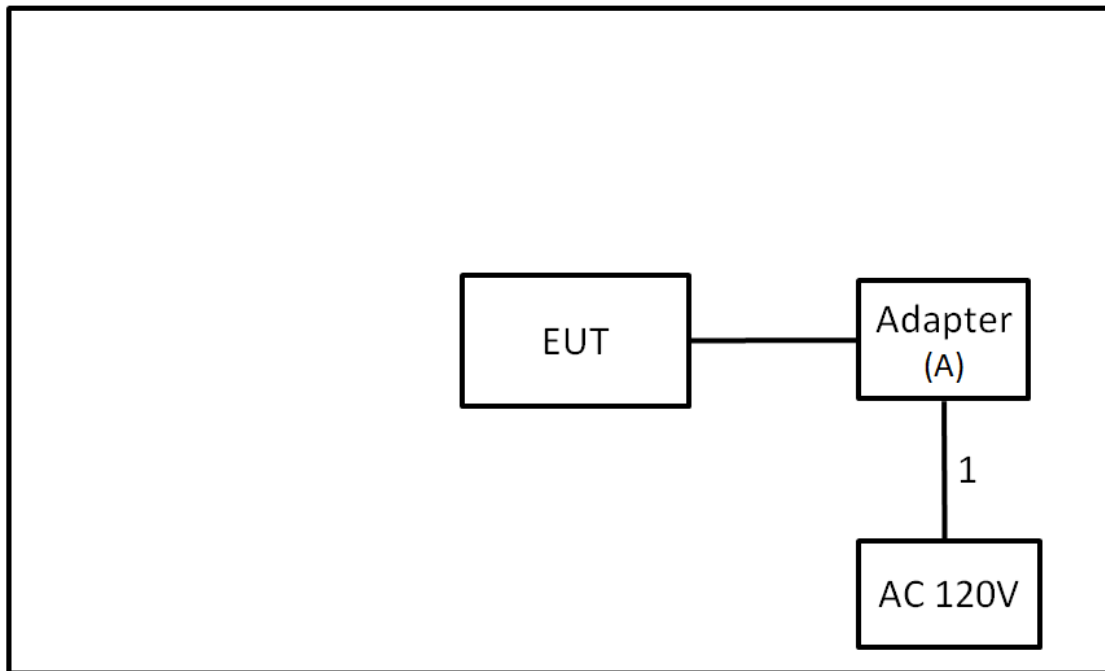

**2.4 SUPPORT UNITS**

Item	Equipment	Brand	Model No.	Series No.
A	Adapter	Delta	ADLX45YDC3D	N/A

Item	Cable Type	Shielded Type	Ferrite Core	Length
1	Power Cable	NO	NO	0.9m

### 3. AC POWER LINE CONDUCTED EMISSIONS TEST

#### 3.1 LIMIT

Frequency of Emission (MHz)	Limit (dB $\mu$ V)	
	Quasi-peak	Average
0.15 - 0.5	66 to 56*	56 to 46*
0.5 - 5.0	56	46
5.0 - 30.0	60	50

Note:

- (1) The tighter limit applies at the band edges.
- (2) The limit of " \* " marked band means the limitation decreases linearly with the logarithm of the frequency in the range.

The following table is the setting of the receiver

Receiver Parameters	Setting
Attenuation	10 dB
Start Frequency	0.15 MHz
Stop Frequency	30 MHz
IF Bandwidth	9 kHz

#### 3.2 TEST PROCEDURE

- a. The EUT was placed 0.8 meters from the horizontal ground plane with EUT being connected to the power mains through a line impedance stabilization network (LISN). All other support equipment powered from additional LISN(s). The LISN provide 50 Ohm/ 50uH of coupling impedance for the measuring instrument.
- b. Interconnecting cables that hang closer than 40 cm to the ground plane shall be folded back and forth in the center forming a bundle 30 to 40 cm long.
- c. I/O cables that are not connected to a peripheral shall be bundled in the center. The end of the cable may be terminated, if required, using the correct terminating impedance. The overall length shall not exceed 1 m.
- d. LISN at least 80 cm from nearest part of EUT chassis.
- e. For the actual test configuration, please refer to the related Item – EUT Test Photos.

#### 3.3 DEVIATION FROM TEST STANDARD

No deviation

### 3.4 TEST SETUP

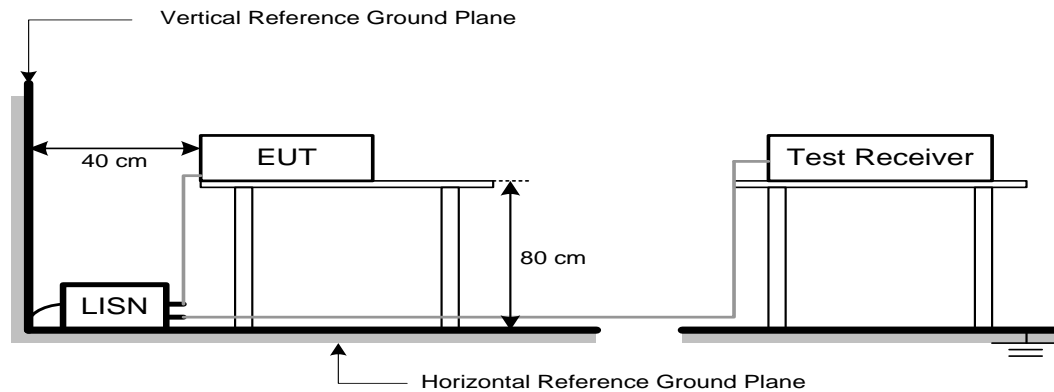

### 3.5 EUT OPERATING CONDITIONS

The EUT was configured for testing in a typical function (as a customer would normally use it), EUT was programmed to be in continuously transmitting data or hopping on mode.

### 3.6 TEST RESULTS

Please refer to the APPENDIX A.

Remark:

- (1) All readings are QP Mode value unless otherwise stated AVG in column of 『Note』. If the QP Mode Measured value compliance with the QP Limits and lower than AVG Limits, the EUT shall be deemed to meet both QP & AVG Limits and then only QP Mode was measured, but AVG Mode didn't perform in this case, a "\*\*\*" marked in AVG Mode column of Interference Voltage Measured.
- (2) Measuring frequency range from 150 kHz to 30 MHz.

## 4. RADIATED EMISSION TEST

### 4.1 LIMIT

In case the emission fall within the restricted band specified on 15.205(a), then the 15.209(a) limit in the table below has to be followed.

LIMITS OF RADIATED EMISSION MEASUREMENT (9 kHz-1000 MHz)

Frequency (MHz)	Field Strength (microvolts/meter)	Measurement Distance (meters)
0.009-0.490	2400/F(kHz)	300
0.490-1.705	24000/F(kHz)	30
1.705-30.0	30	30
30-88	100	3
88-216	150	3
216-960	200	3
Above 960	500	3

LIMITS OF RADIATED EMISSION MEASUREMENT (Above 1000 MHz)

Frequency (MHz)	Band edge/ Harmonic at 3m (dB $\mu$ V/m)		Harmonic at 1.5m (dB $\mu$ V/m)	
	Peak	Average	Peak	Average
Above 1000	74	54	80 (Note 5)	60 (Note 5)

Note:

- (1) The limit for radiated test was performed according to FCC PART 15C.
- (2) The tighter limit applies at the band edges.
- (3) Emission level (dB $\mu$ V/m)=20log Emission level (uV/m).
- (4) The test result calculated as following:  
 Measurement Value = Reading Level + Correct Factor  
 Correct Factor = Antenna Factor + Cable Loss - Amplifier Gain(if use)  
 Margin Level = Measurement Value - Limit Value

(5)

$$FS_{\text{limit}} = FS_{\text{max}} - 20 \log \left( \frac{d_{\text{limit}}}{d_{\text{measure}}} \right)$$

$$20 \log d_{\text{limit}}/d_{\text{measure}} = 20 \log 3/1.5 = 6 \text{ dB.}$$

Spectrum Parameter	Setting
Attenuation	Auto
Start Frequency	1000 MHz
Stop Frequency	10th carrier harmonic
RBW / VBW (Emission in restricted band)	RBW 1 MHz VBW 3 MHz peak detector for Pk value RMS detector for AV value

Receiver Parameter	Setting
Attenuation	Auto
Start ~ Stop Frequency	9 kHz~90 kHz for PK/AVG detector
Start ~ Stop Frequency	90 kHz~110 kHz for QP detector
Start ~ Stop Frequency	110 kHz~490 kHz for PK/AVG detector
Start ~ Stop Frequency	490 kHz~30 MHz for QP detector
Start ~ Stop Frequency	30 MHz~1000 MHz for QP detector

#### 4.2 TEST PROCEDURE

- a. The measuring distance of 3 m shall be used for measurements. The EUT was placed on the top of a rotating table 0.8 meter above the ground at a 3 meter semi-anechoic chamber. The table was rotated 360 degrees to determine the position of the highest radiation.(below 1 GHz)
- b. The measuring distance of 3 m or 1.5m shall be used for measurements. The EUT was placed on the top of a rotating table 1.5 meter above the ground at a 3 meter semi-anechoic chamber. The table was rotated 360 degrees to determine the position of the highest radiation.(above 1GHz)
- c. The height of the equipment or of the substitution antenna shall be 0.8m or 1.5m; the height of the test antenna shall vary between 1 m to 4 m. Both horizontal and vertical polarizations of the antenna are set to make the measurement.
- d. For each suspected emission, the EUT was arranged to its worst case and then the antenna was tuned to heights find the maximum reading (used Bore sight function).
- e. The receiver system was set to peak and average detect function and specified bandwidth with maximum hold mode when the test frequency is above 1 GHz.
- f. The initial step in collecting radiated emission data is a receiver peak detector mode pre-scanning the measurement frequency range. Significant peaks are then marked and then Quasi Peak detector mode re-measured.
- g. All readings are Peak unless otherwise stated QP in column of Note. Peak denotes that the Peak reading compliance with the QP Limits and then QP Mode measurement didn't perform.  
(below 1 GHz)
- h. All readings are Peak Mode value unless otherwise stated AVG in column of Note. If the Peak Mode Measured value compliance with the Peak Limits and lower than AVG Limits, the EUT shall be deemed to meet both Peak & AVG Limits and then only Peak Mode was measured, but AVG Mode didn't perform. (above 1 GHz)
- i. For the actual test configuration, please refer to the related Item – EUT Test Photos.

#### 4.3 DEVIATION FROM TEST STANDARD

No deviation

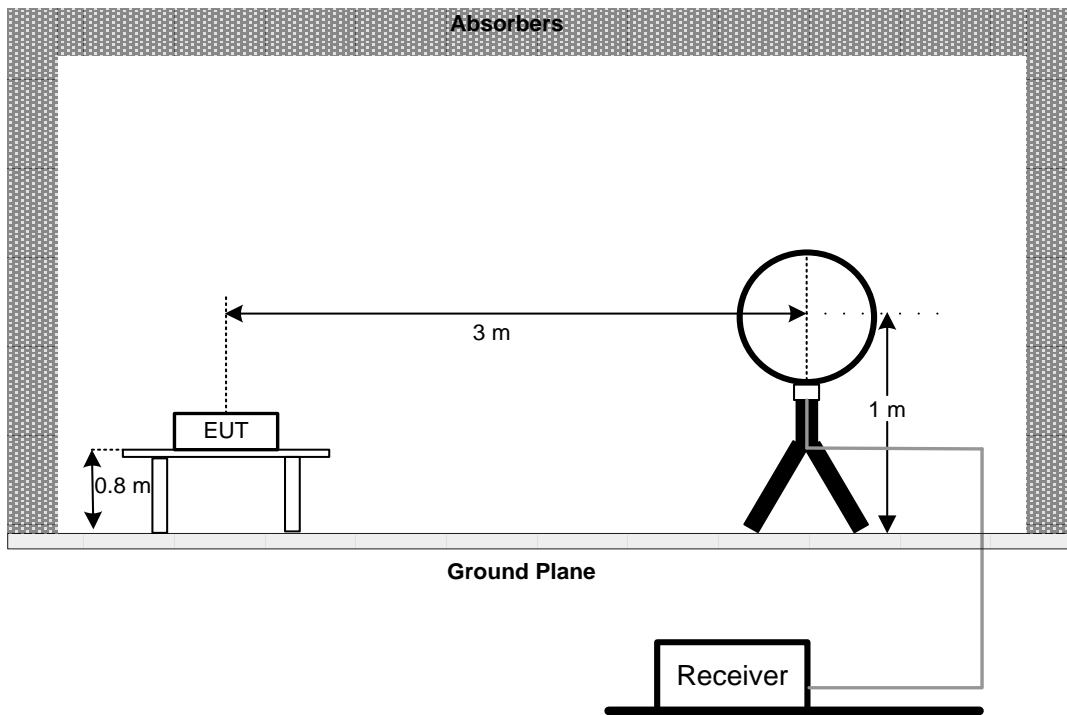
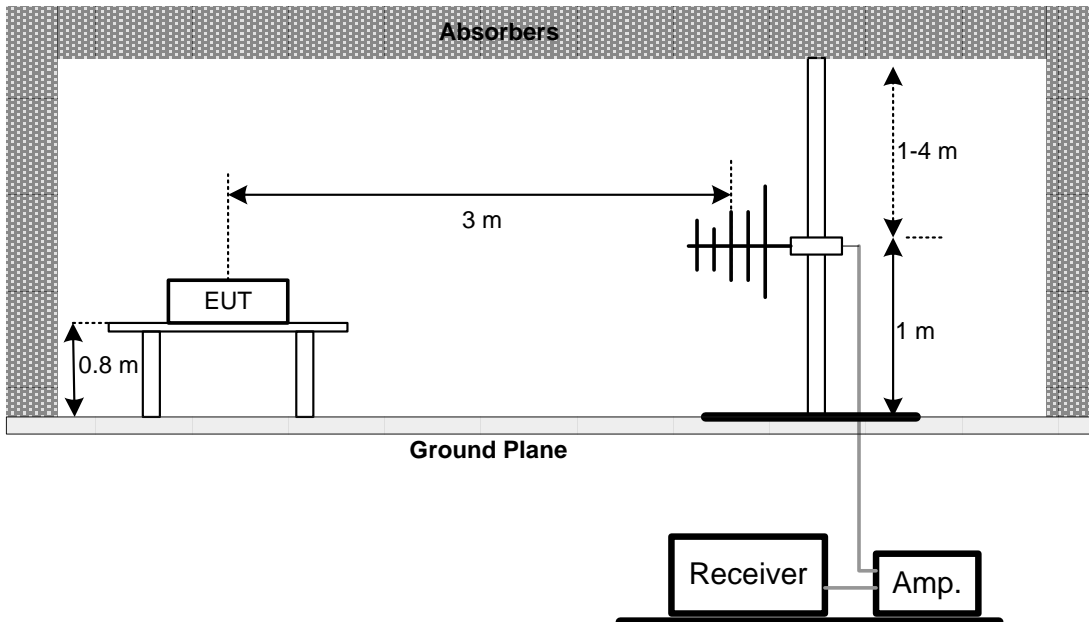
**4.4 TEST SETUP****9 kHz-30 MHz****30 MHz to 1 GHz**

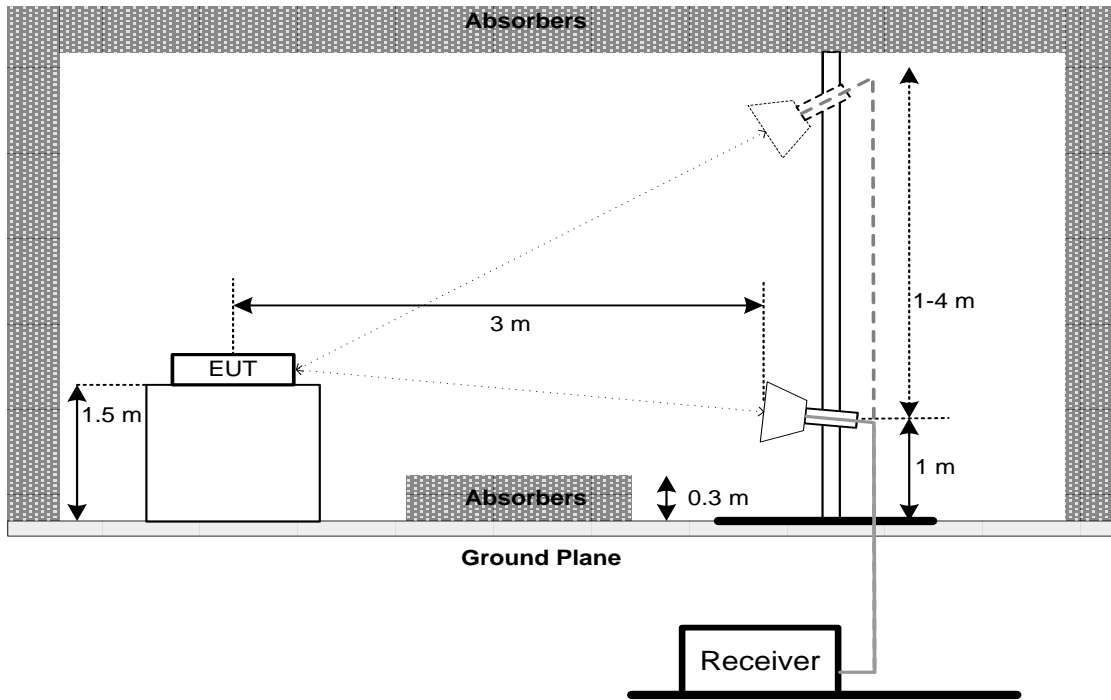
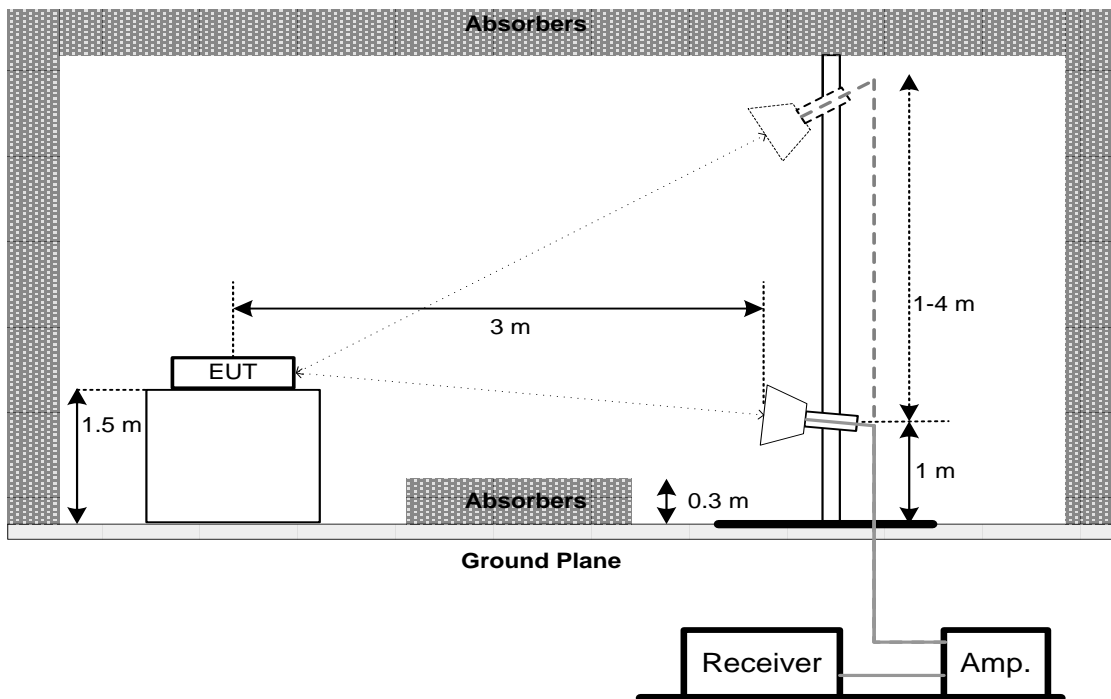
**Above 1 GHz  
Band edge****Harmonic (1 GHz to 18 GHz)**



**Harmonic (Above 18 GHz)**

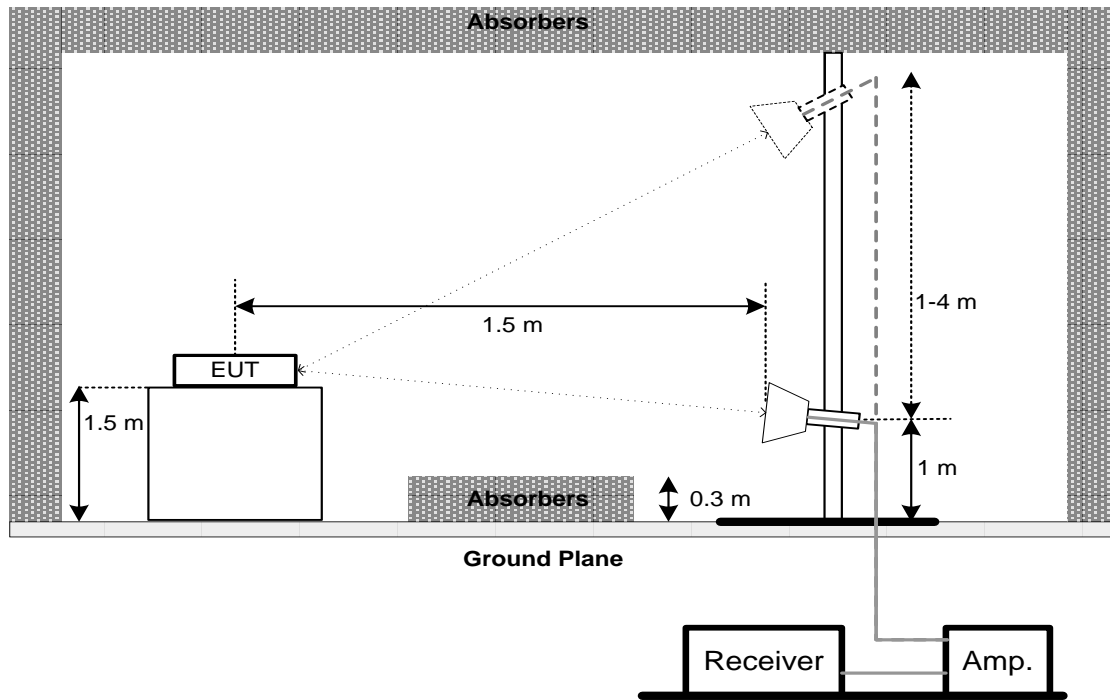

**4.5 EUT OPERATING CONDITIONS**

The EUT was programmed to be in continuously transmitting mode.

**4.6 TEST RESULTS - 30 MHz TO 1000 MHz**

Please refer to the APPENDIX B.

**4.7 TEST RESULTS - ABOVE 1000 MHz**

Please refer to the APPENDIX C.

Remark:

- (1) No limit: This is fundamental signal, the judgment is not applicable.  
For fundamental signal judgment was referred to Peak output test.

**5. MEASUREMENT INSTRUMENTS LIST**

AC Power Line Conducted Emissions					
Item	Kind of Equipment	Manufacturer	Type No.	Serial No.	Calibrated until
1	EMI Test Receiver	R&S	ESCI	100382	Feb. 28, 2022
2	LISN	EMCO	3816/2	52765	Feb. 27, 2022
3	TWO-LINE V-NETWORK	R&S	ENV216	101447	Feb. 27, 2022
4	50Ω Terminator	SHX	TF5-3	15041305	Feb. 27, 2022
5	Measurement Software	Farad	EZ-EMC Ver.NB-03A1-01	N/A	N/A
6	Cable	N/A	RG223	12m	Mar. 09, 2022
7	643 Shield Room	ETS	6*4*3m	N/A	N/A

Radiated Emissions - 30 MHz to 1 GHz					
Item	Kind of Equipment	Manufacturer	Type No.	Serial No.	Calibrated until
1	Antenna	Schwarzbeck	VULB9160	9160-3232	Mar. 15, 2022
2*	Amplifier	HP	8447D	2944A08742	Feb. 28, 2022
3	Receiver	Agilent	N9038A	MY52130039	Jul. 25, 2021
4	Cable	emci	LMR-400(30MHz-1 GHz)(8m+5m)	N/A	May 22, 2021
5	Controller	CT	SC100	N/A	N/A
6	Controller	MF	MF-7802	MF780208416	N/A
7	Measurement Software	Farad	EZ-EMC Ver.NB-03A1-01	N/A	N/A
8	966 Chambe Room	RM	9*6*6m	N/A	Jul. 25, 2021

Radiated Emissions - Above 1 GHz					
Item	Kind of Equipment	Manufacturer	Type No.	Serial No.	Calibrated until
1	Double Ridged Guide Antenna	ETS	3115	75789	May 12, 2021
2	Broad-Band Horn Antenna	Schwarzbeck	BBHA 9170	9170319	Jul. 07, 2021
3	Amplifier	Agilent	8449B	3008A02584	Jul. 25, 2021
4	Microwave Preamplifier With Adaptor	EMC INSTRUMENT	EMC2654045	980039 & HA01	Feb. 28, 2022
5	Receiver	Agilent	N9038A	MY52130039	Jul. 25, 2021
6	Controller	CT	SC100	N/A	N/A
7	Controller	MF	MF-7802	MF780208416	N/A
8	Cable	N/A	EMC104-SM-SM-6000	N/A	Oct. 16, 2021
9	Measurement Software	Farad	EZ-EMC Ver.NB-03A1-01	N/A	N/A
10	Filter	STI	STI15-9912	N/A	Jul. 25, 2021
11	966 Chambe Room	RM	9*6*6m	N/A	Jul. 25, 2021

Remark "N/A" denotes no model name, serial no. or calibration specified.

"\*\*" calibration period of equipment list is three year.

Except \* item, all calibration period of equipment list is one year.

## **APPENDIX A - AC POWER LINE CONDUCTED EMISSIONS**

Test Mode	Normal	Tested Date	2021/4/28
Test Frequency	-	Phase	Line

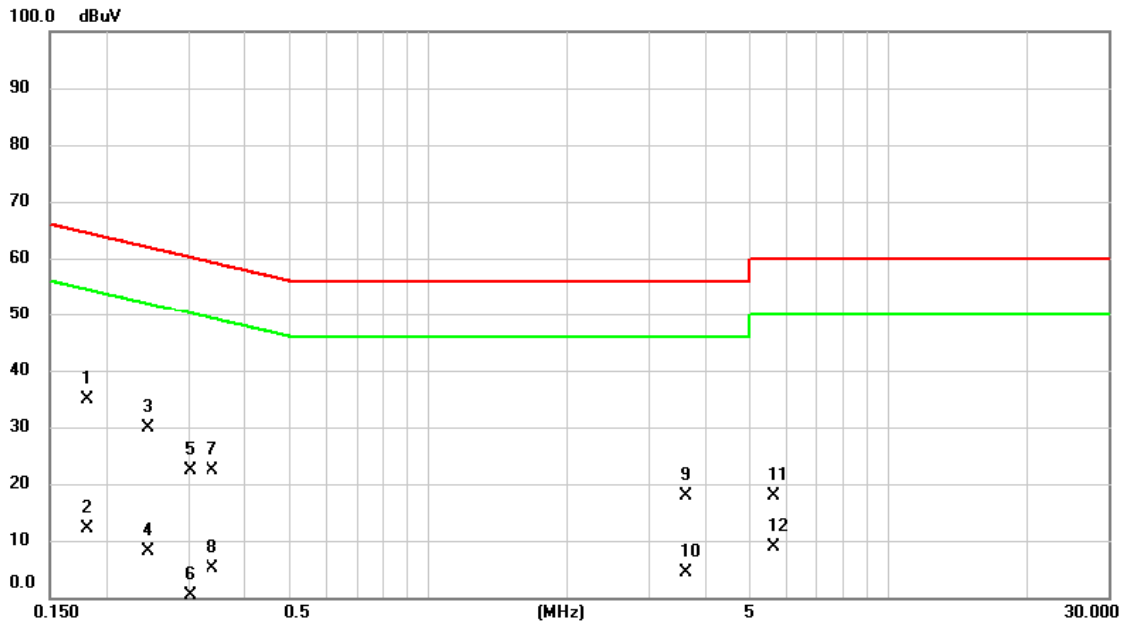

No.	Mk.	Freq.	Reading Level	Correct Factor	Measurement	Limit	Over	Detector	Comment
		MHz	dBuV	dB	dBuV	dBuV	dB		
1	*	0.1815	34.98	0.01	34.99	64.42	-29.43	QP	
2		0.1815	12.17	0.01	12.18	54.42	-42.24	AVG	
3		0.2445	29.82	0.02	29.84	61.94	-32.10	QP	
4		0.2445	8.19	0.02	8.21	51.94	-43.73	AVG	
5		0.3030	22.23	0.03	22.26	60.16	-37.90	QP	
6		0.3030	0.25	0.03	0.28	50.16	-49.88	AVG	
7		0.3392	22.35	0.03	22.38	59.22	-36.84	QP	
8		0.3392	5.09	0.03	5.12	49.22	-44.10	AVG	
9		3.6173	17.77	0.11	17.88	56.00	-38.12	QP	
10		3.6173	4.39	0.11	4.50	46.00	-41.50	AVG	
11		5.6513	17.75	0.15	17.90	60.00	-42.10	QP	
12		5.6513	8.61	0.15	8.76	50.00	-41.24	AVG	

**REMARKS:**

- (1) Measurement Value = Reading Level + Correct Factor.
- (2) Margin Level = Measurement Value - Limit Value.

Test Mode	Normal	Tested Date	2021/4/28
Test Frequency	-	Phase	Neutral

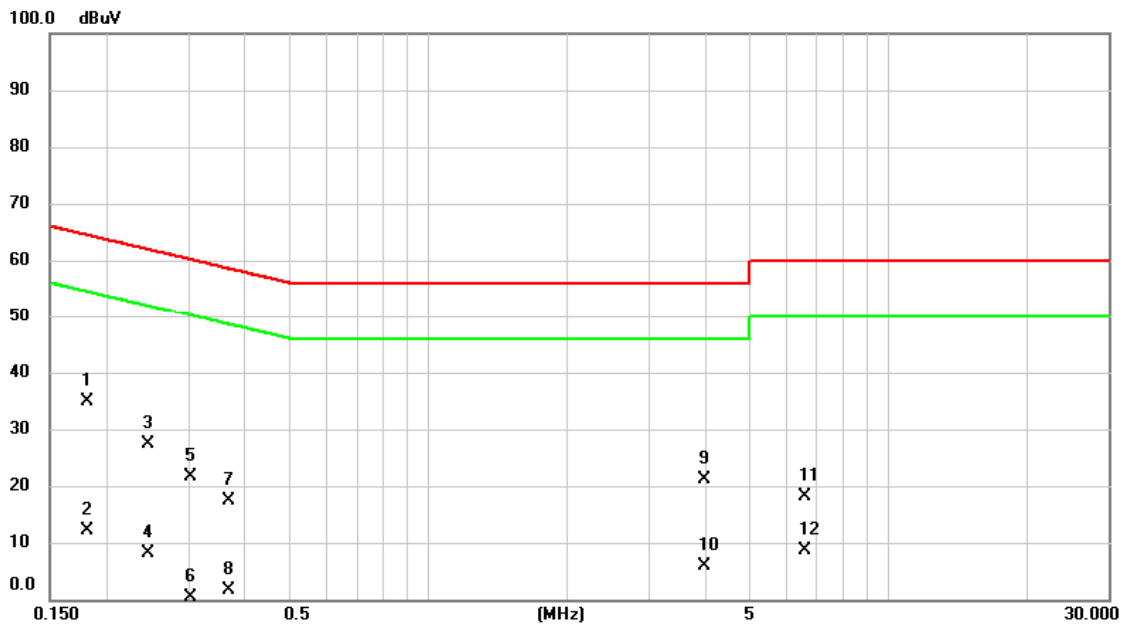

No. Mk.	Freq. MHz	Reading Level dBuV	Correct Factor dB	Measurement dBuV	Limit dBuV	Over dB	Detector	Comment
1 *	0.1815	34.82	0.01	34.83	64.42	-29.59	QP	
2	0.1815	12.05	0.01	12.06	54.42	-42.36	AVG	
3	0.2445	27.33	0.02	27.35	61.94	-34.59	QP	
4	0.2445	8.18	0.02	8.20	51.94	-43.74	AVG	
5	0.3030	21.70	0.03	21.73	60.16	-38.43	QP	
6	0.3030	0.26	0.03	0.29	50.16	-49.87	AVG	
7	0.3682	17.26	0.03	17.29	58.54	-41.25	QP	
8	0.3682	1.59	0.03	1.62	48.54	-46.92	AVG	
9	3.9593	21.12	0.11	21.23	56.00	-34.77	QP	
10	3.9593	5.66	0.11	5.77	46.00	-40.23	AVG	
11	6.6143	17.90	0.16	18.06	60.00	-41.94	QP	
12	6.6143	8.45	0.16	8.61	50.00	-41.39	AVG	

**REMARKS:**

- (1) Measurement Value = Reading Level + Correct Factor.
- (2) Margin Level = Measurement Value - Limit Value.

Test Mode	Idle	Tested Date	2021/4/28
Test Frequency	-	Phase	Line

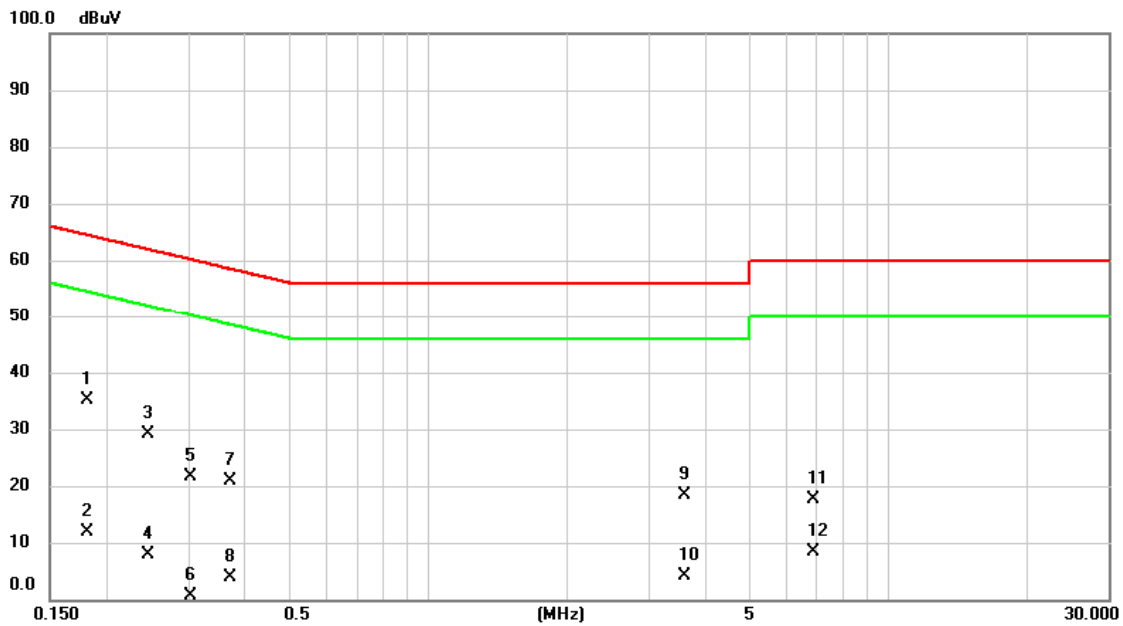

No.	Mk.	Freq. MHz	Reading Level dBuV	Correct Factor dB	Measure- ment dBuV	Limit dBuV	Over dB	Detector	Comment
1	*	0.1815	35.03	0.01	35.04	64.42	-29.38	QP	
2		0.1815	11.85	0.01	11.86	54.42	-42.56	AVG	
3		0.2445	29.07	0.02	29.09	61.94	-32.85	QP	
4		0.2445	7.98	0.02	8.00	51.94	-43.94	AVG	
5		0.3030	21.65	0.03	21.68	60.16	-38.48	QP	
6		0.3030	0.51	0.03	0.54	50.16	-49.62	AVG	
7		0.3727	20.94	0.03	20.97	58.44	-37.47	QP	
8		0.3727	3.97	0.03	4.00	48.44	-44.44	AVG	
9		3.5993	18.38	0.10	18.48	56.00	-37.52	QP	
10		3.5993	4.10	0.10	4.20	46.00	-41.80	AVG	
11		6.8865	17.55	0.17	17.72	60.00	-42.28	QP	
12		6.8865	8.20	0.17	8.37	50.00	-41.63	AVG	

**REMARKS:**

- (1) Measurement Value = Reading Level + Correct Factor.
- (2) Margin Level = Measurement Value - Limit Value.

Test Mode	Idle	Tested Date	2021/4/28
Test Frequency	-	Phase	Neutral

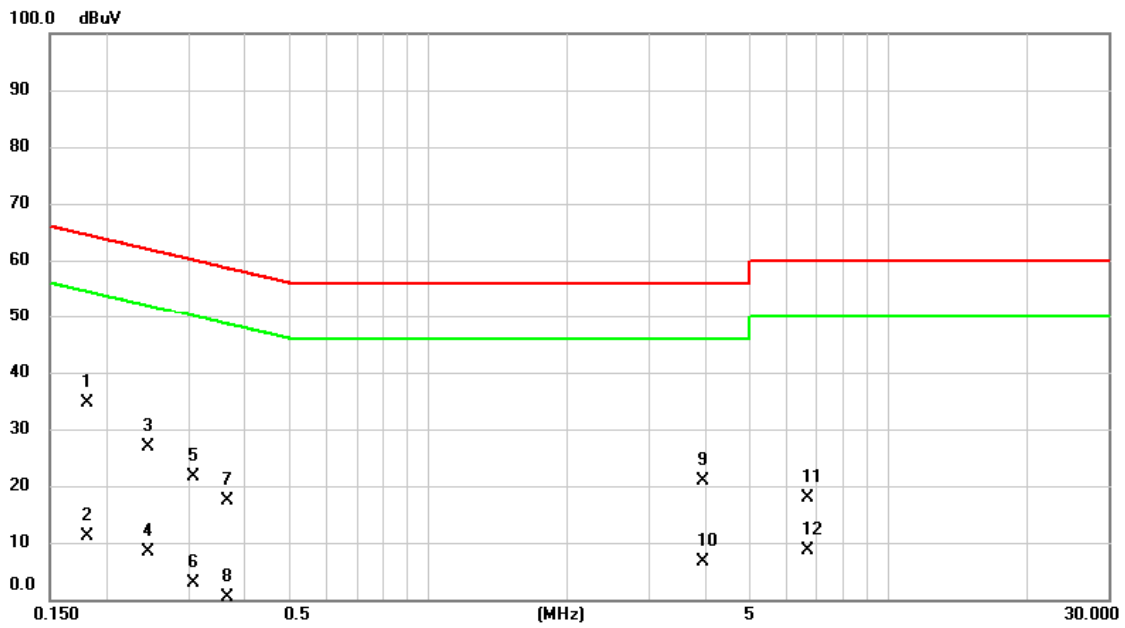

No.	Mk.	Freq. MHz	Reading Level dBuV	Correct Factor dB	Measure- ment dBuV	Limit dBuV	Over dB	Detector	Comment
1	*	0.1815	34.51	0.01	34.52	64.42	-29.90	QP	
2		0.1815	11.22	0.01	11.23	54.42	-43.19	AVG	
3		0.2445	26.82	0.02	26.84	61.94	-35.10	QP	
4		0.2445	8.34	0.02	8.36	51.94	-43.58	AVG	
5		0.3075	21.70	0.03	21.73	60.04	-38.31	QP	
6		0.3075	2.79	0.03	2.82	50.04	-47.22	AVG	
7		0.3660	17.42	0.03	17.45	58.59	-41.14	QP	
8		0.3660	0.42	0.03	0.45	48.59	-48.14	AVG	
9		3.9413	20.85	0.11	20.96	56.00	-35.04	QP	
10		3.9413	6.45	0.11	6.56	46.00	-39.44	AVG	
11		6.6885	17.81	0.16	17.97	60.00	-42.03	QP	
12		6.6885	8.39	0.16	8.55	50.00	-41.45	AVG	

**REMARKS:**

- (1) Measurement Value = Reading Level + Correct Factor.
- (2) Margin Level = Measurement Value - Limit Value.

## **APPENDIX B - RADIATED EMISSION - 30 MHZ TO 1000 MHZ**



Test Mode	BT (1 Mbps)	Test Date	2021/4/28
Test Frequency	CH79: 2480 MHz	Polarization	Vertical

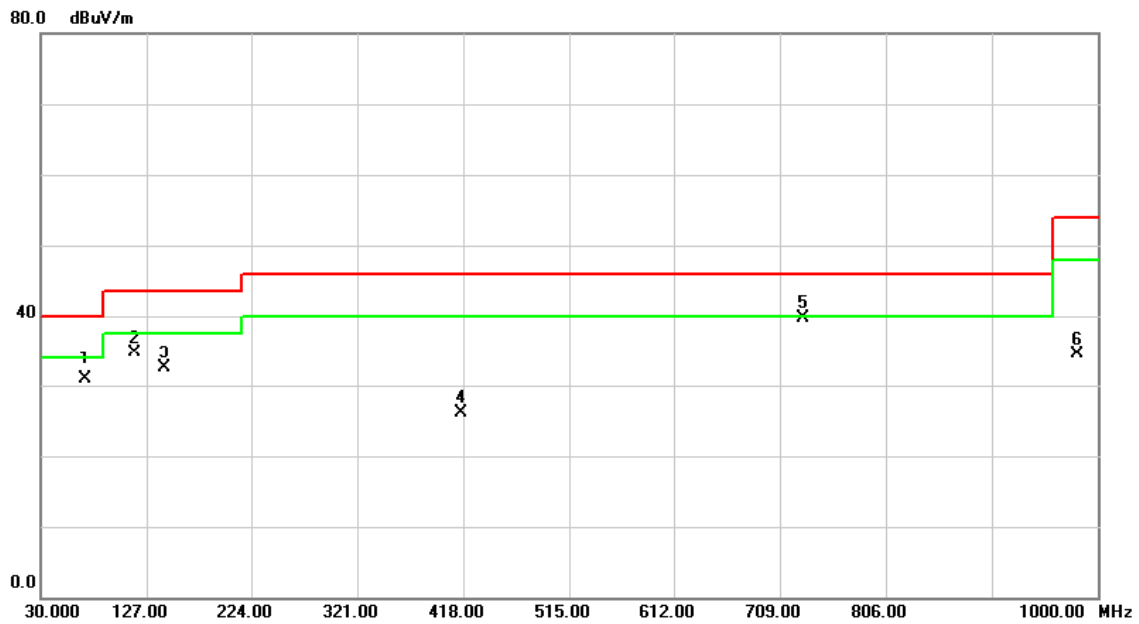

No.	Mk.	Freq. MHz	Reading Level dBuV	Correct Factor dB	Measure- ment dBuV/m	Limit dBuV/m	Margin dB	Detector	Comment
1		70.740	47.33	-16.37	30.96	40.00	-9.04	QP	
2		115.360	49.18	-14.57	34.61	43.50	-8.89	peak	
3		142.520	45.31	-12.82	32.49	43.50	-11.01	peak	
4		416.060	34.50	-8.34	26.16	46.00	-19.84	peak	
5	*	730.340	42.04	-2.39	39.65	46.00	-6.35	peak	
6		980.600	32.73	1.83	34.56	54.00	-19.44	peak	

**REMARKS:**

(1) Measurement Value = Reading Level + Correct Factor.

(2) Margin Level = Measurement Value - Limit Value.

Test Mode	BT (1 Mbps)	Test Date	2021/4/28
Test Frequency	CH79: 2480 MHz	Polarization	Horizontal

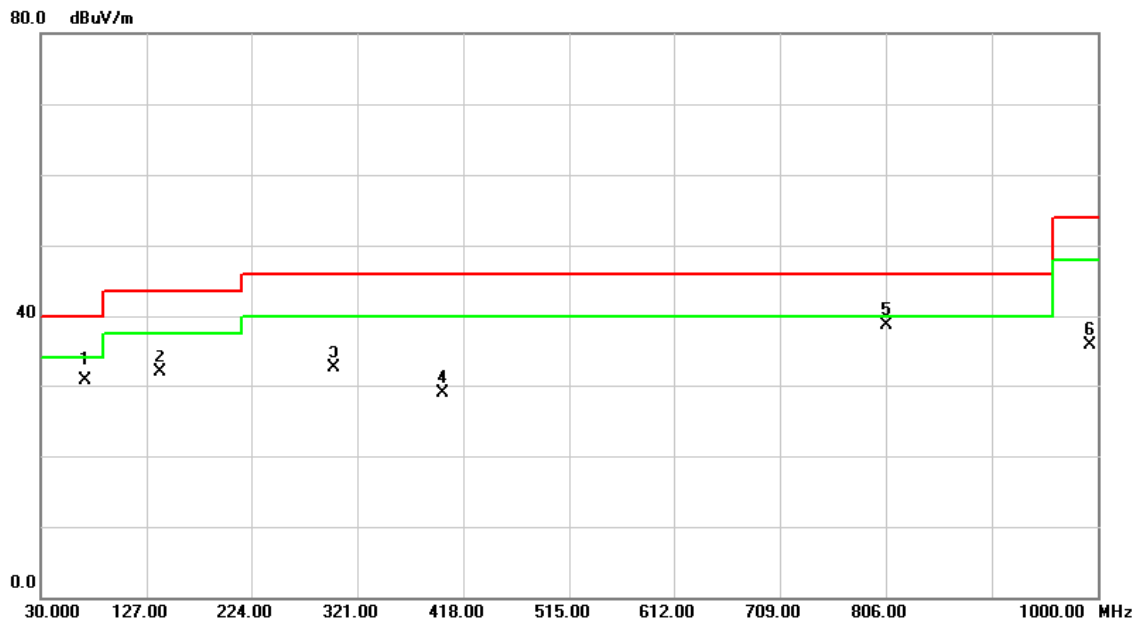

No.	Mk.	Freq. MHz	Reading Level dBuV	Correct Factor dB	Measure- ment dBuV/m	Limit dBuV/m	Margin dB	Detector	Comment
1		71.516	47.26	-16.55	30.71	40.00	-9.29	QP	
2		139.869	44.73	-12.90	31.83	43.50	-11.67	peak	
3		299.725	43.48	-10.90	32.58	46.00	-13.42	peak	
4		399.570	37.67	-8.78	28.89	46.00	-17.11	peak	
5	*	807.099	39.33	-0.68	38.65	46.00	-7.35	peak	
6		992.725	34.04	1.84	35.88	54.00	-18.12	peak	

**REMARKS:**

(1) Measurement Value = Reading Level + Correct Factor.

(2) Margin Level = Measurement Value - Limit Value.

## **APPENDIX C - RADIATED EMISSION - ABOVE 1000 MHZ**

Test Mode	BT (1 Mbps)	Test Date	2021/4/23
Test Frequency	CH00: 2402 MHz	Polarization	Horizontal

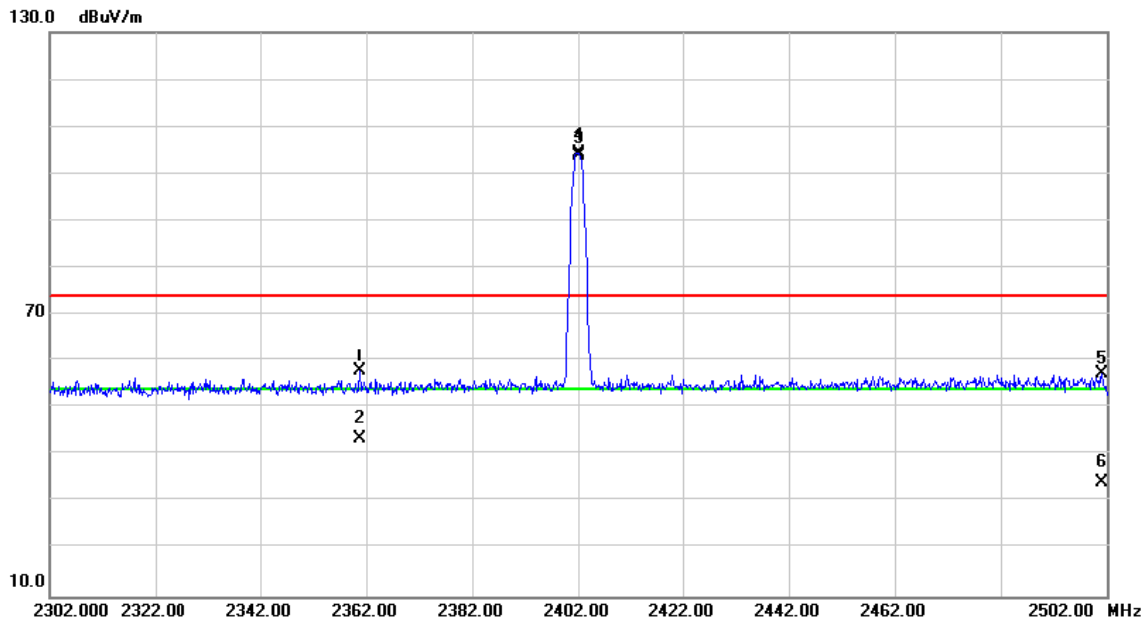

No.	Mk.	Freq. MHz	Reading Level dBuV	Correct Factor dB	Measure- ment dBuV/m	Limit dBuV/m	Margin dB	Detector	Comment
1		2360.873	50.56	7.26	57.82	74.00	-16.18	peak	
2		2360.873	36.31	7.26	43.57	54.00	-10.43	AVG	
3	X	2402.000	97.22	7.26	104.48	74.00	30.48	peak	No Limit
4	*	2402.000	96.38	7.26	103.64	54.00	49.64	AVG	No Limit
5		2501.020	49.91	7.25	57.16	74.00	-16.84	peak	
6		2501.020	26.97	7.25	34.22	54.00	-19.78	AVG	

**REMARKS:**

(1) Measurement Value = Reading Level + Correct Factor.

(2) Margin Level = Measurement Value - Limit Value.

Test Mode	BT (1 Mbps)	Test Date	2021/4/23
Test Frequency	CH79: 2480 MHz	Polarization	Horizontal

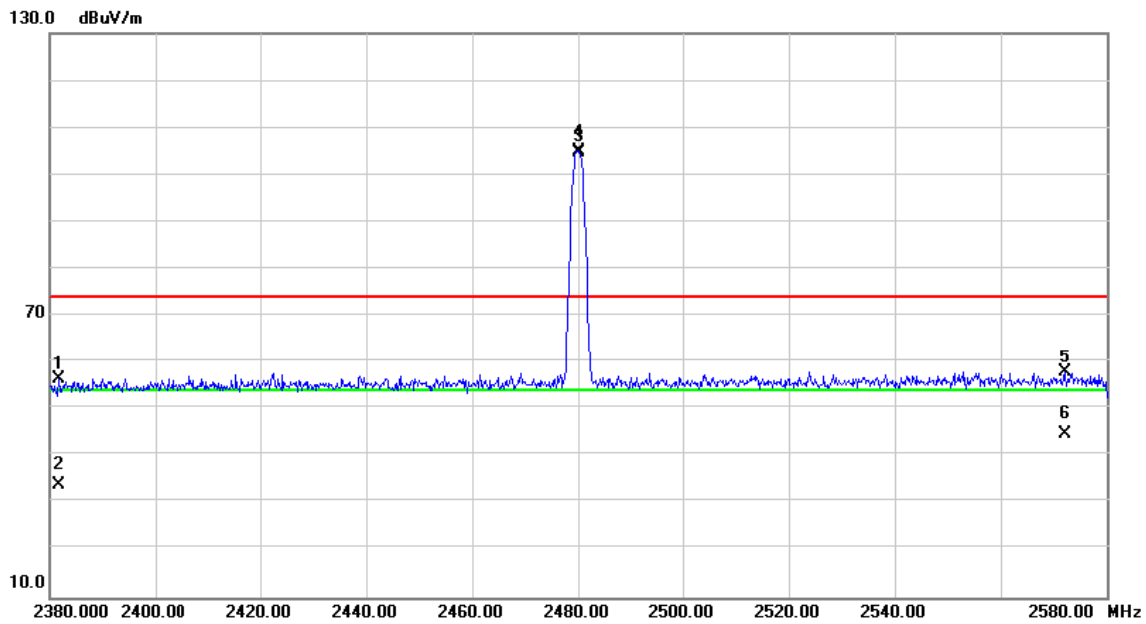

No.	Mk.	Freq. MHz	Reading Level dBuV	Correct Factor dB	Measure- ment dBuV/m	Limit dBuV/m	Margin dB	Detector	Comment
1		2381.800	49.15	7.25	56.40	74.00	-17.60	peak	
2		2381.800	26.52	7.25	33.77	54.00	-20.23	AVG	
3	X	2480.000	97.69	7.25	104.94	74.00	30.94	peak	No Limit
4	*	2480.000	97.31	7.25	104.56	54.00	50.56	AVG	No Limit
5		2572.060	50.39	7.53	57.92	74.00	-16.08	peak	
6		2572.060	37.18	7.53	44.71	54.00	-9.29	AVG	

**REMARKS:**

(1) Measurement Value = Reading Level + Correct Factor.

(2) Margin Level = Measurement Value - Limit Value.

Test Mode	BT (3 Mbps)	Test Date	2021/4/23
Test Frequency	CH00: 2402 MHz	Polarization	Horizontal

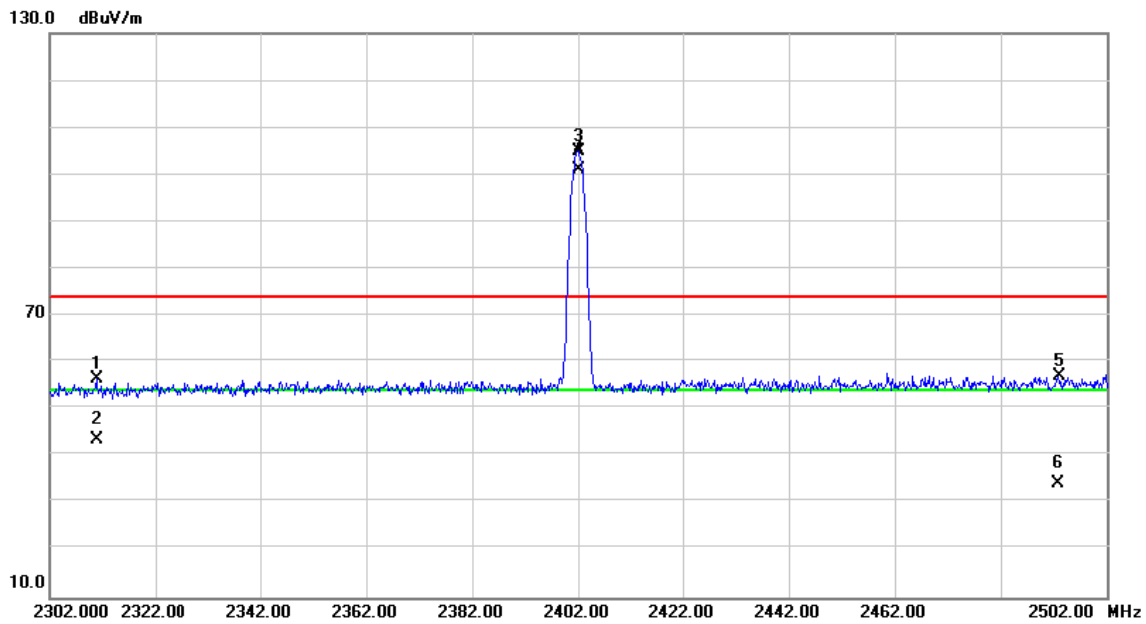

No.	Mk.	Freq. MHz	Reading Level dBuV	Correct Factor dB	Measure- ment dBuV/m	Limit dBuV/m	Margin dB	Detector	Comment
1		2310.980	49.05	7.27	56.32	74.00	-17.68	peak	
2		2310.980	36.24	7.27	43.51	54.00	-10.49	AVG	
3	X	2402.000	97.66	7.26	104.92	74.00	30.92	peak	No Limit
4	*	2402.000	93.74	7.26	101.00	54.00	47.00	AVG	No Limit
5		2492.947	49.60	7.24	56.84	74.00	-17.16	peak	
6		2492.947	26.98	7.24	34.22	54.00	-19.78	AVG	

**REMARKS:**

(1) Measurement Value = Reading Level + Correct Factor.

(2) Margin Level = Measurement Value - Limit Value.

Test Mode	BT (3 Mbps)	Test Date	2021/4/23
Test Frequency	CH79: 2480 MHz	Polarization	Horizontal

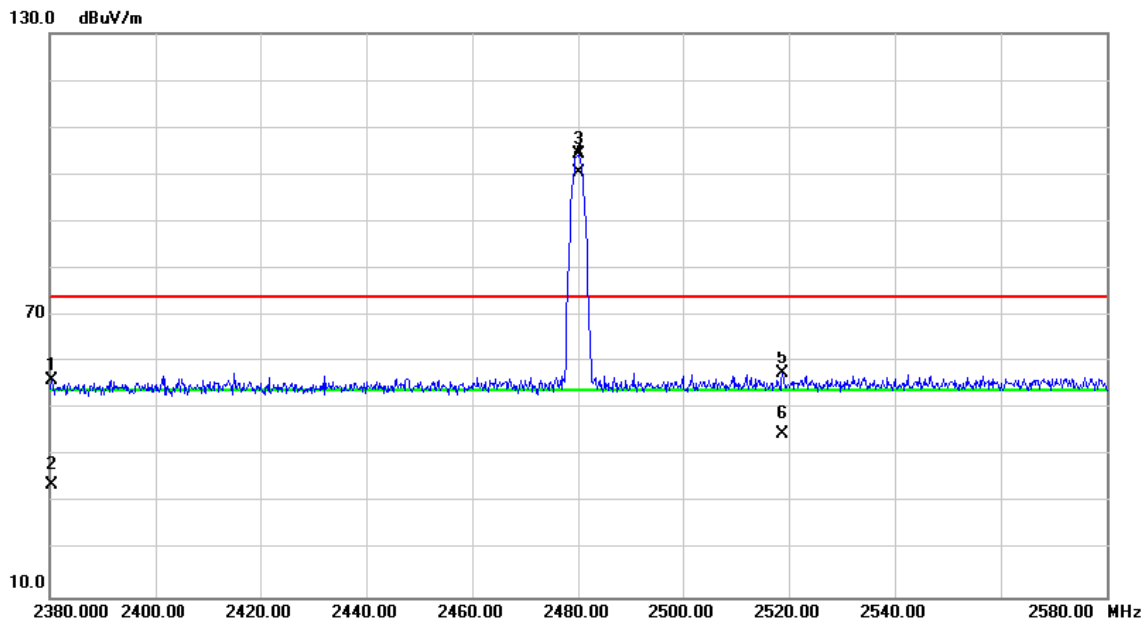

No.	Mk.	Freq. MHz	Reading Level dBuV	Correct Factor dB	Measure- ment dBuV/m	Limit dBuV/m	Margin dB	Detector	Comment
1		2380.493	48.73	7.26	55.99	74.00	-18.01	peak	
2		2380.493	26.53	7.26	33.79	54.00	-20.21	AVG	
3	X	2480.000	97.24	7.25	104.49	74.00	30.49	peak	No Limit
4	*	2480.000	93.27	7.25	100.52	54.00	46.52	AVG	No Limit
5		2518.813	50.37	7.32	57.69	74.00	-16.31	peak	
6		2518.813	37.36	7.32	44.68	54.00	-9.32	AVG	

**REMARKS:**

(1) Measurement Value = Reading Level + Correct Factor.

(2) Margin Level = Measurement Value - Limit Value.

Test Mode	BT (1 Mbps)	Test Date	2021/4/23
Test Frequency	CH00: 2402 MHz	Polarization	Vertical

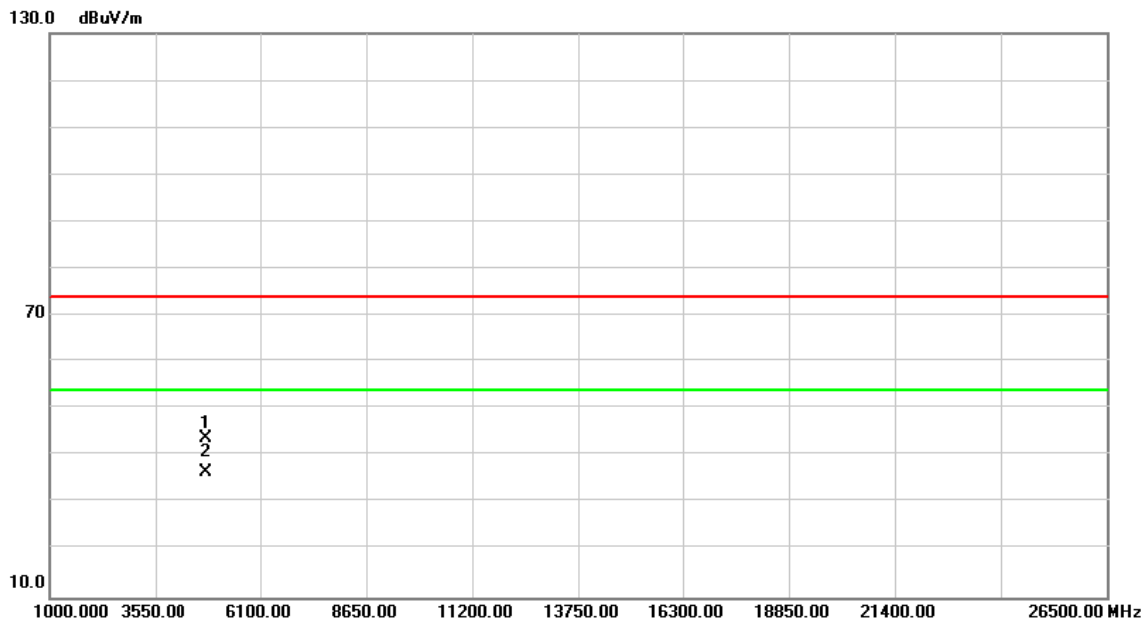

No.	Mk.	Freq. MHz	Reading Level dBuV	Correct Factor dB	Measure- ment dBuV/m	Limit dBuV/m	Margin dB	Detector	Comment
1		4804.000	39.20	4.40	43.60	74.00	-30.40	peak	
2	*	4804.000	32.26	4.40	36.66	54.00	-17.34	AVG	

**REMARKS:**

(1) Measurement Value = Reading Level + Correct Factor.

(2) Margin Level = Measurement Value - Limit Value.



Test Mode	BT (1 Mbps)	Test Date	2021/4/23
Test Frequency	CH00: 2402 MHz	Polarization	Horizontal

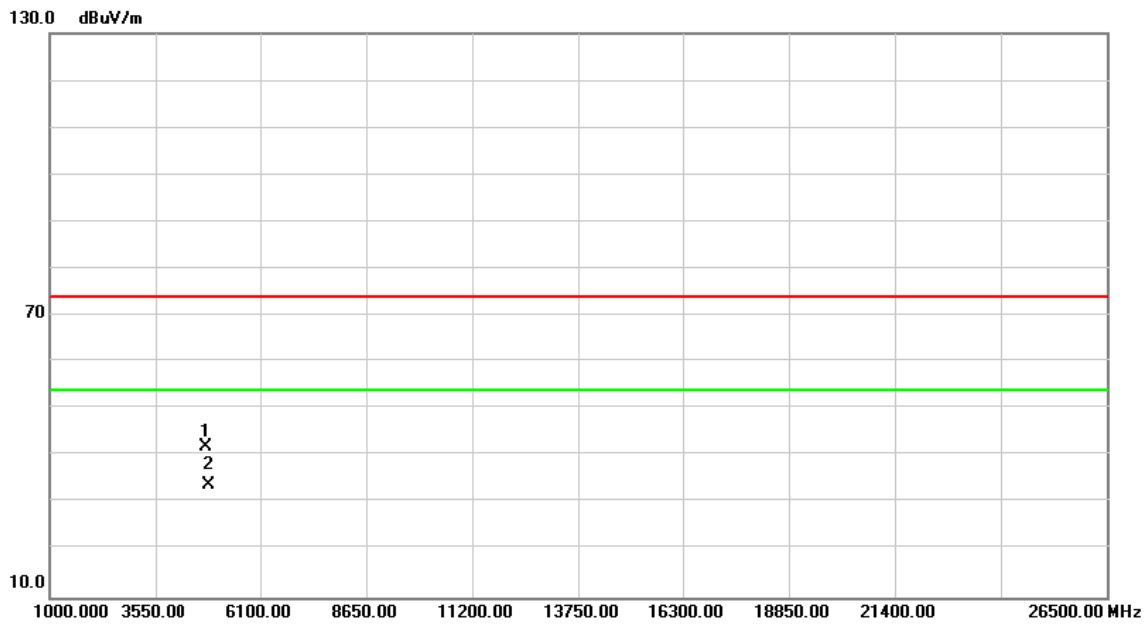

No.	Mk.	Freq. MHz	Reading Level dBuV	Correct Factor dB	Measure- ment dBuV/m	Limit dBuV/m	Margin dB	Detector	Comment
1		4804.000	37.47	4.40	41.87	74.00	-32.13	peak	
2	*	4804.000	29.43	4.40	33.83	54.00	-20.17	AVG	

**REMARKS:**

(1) Measurement Value = Reading Level + Correct Factor.

(2) Margin Level = Measurement Value - Limit Value.

Test Mode	BT (1 Mbps)	Test Date	2021/4/23
Test Frequency	CH39: 2441 MHz	Polarization	Vertical

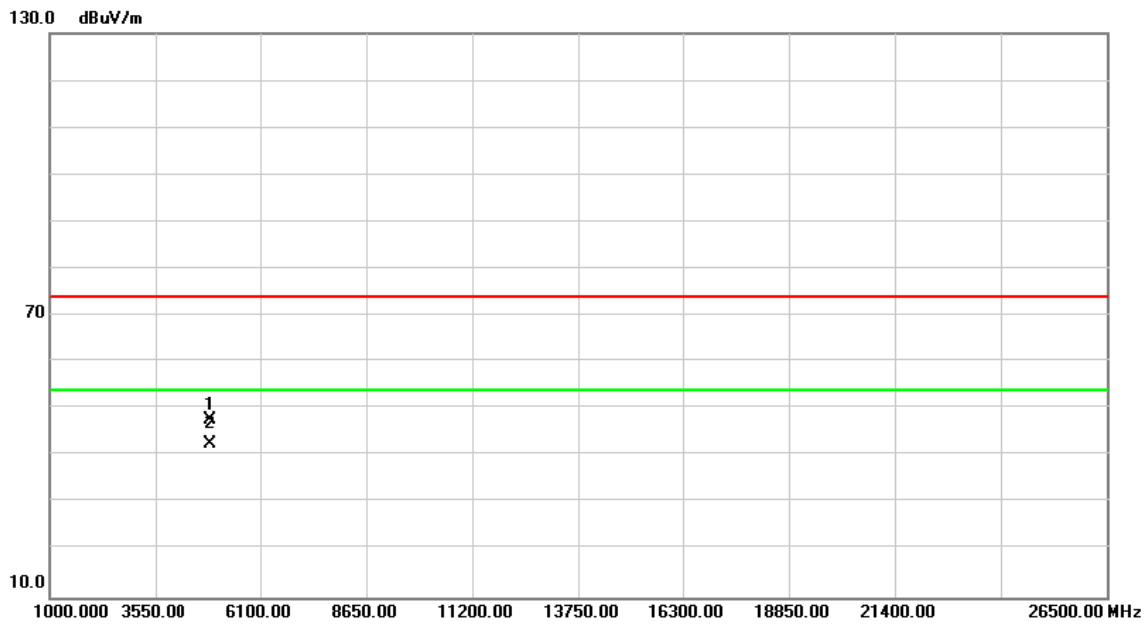

No.	Mk.	Freq. MHz	Reading Level dBuV	Correct Factor dB	Measure- ment dBuV/m	Limit dBuV/m	Margin dB	Detector	Comment
1		4882.000	43.04	4.61	47.65	74.00	-26.35	peak	
2	*	4882.000	38.04	4.61	42.65	54.00	-11.35	AVG	

**REMARKS:**

(1) Measurement Value = Reading Level + Correct Factor.

(2) Margin Level = Measurement Value - Limit Value.

Test Mode	BT (1 Mbps)	Test Date	2021/4/23
Test Frequency	CH39: 2441 MHz	Polarization	Horizontal

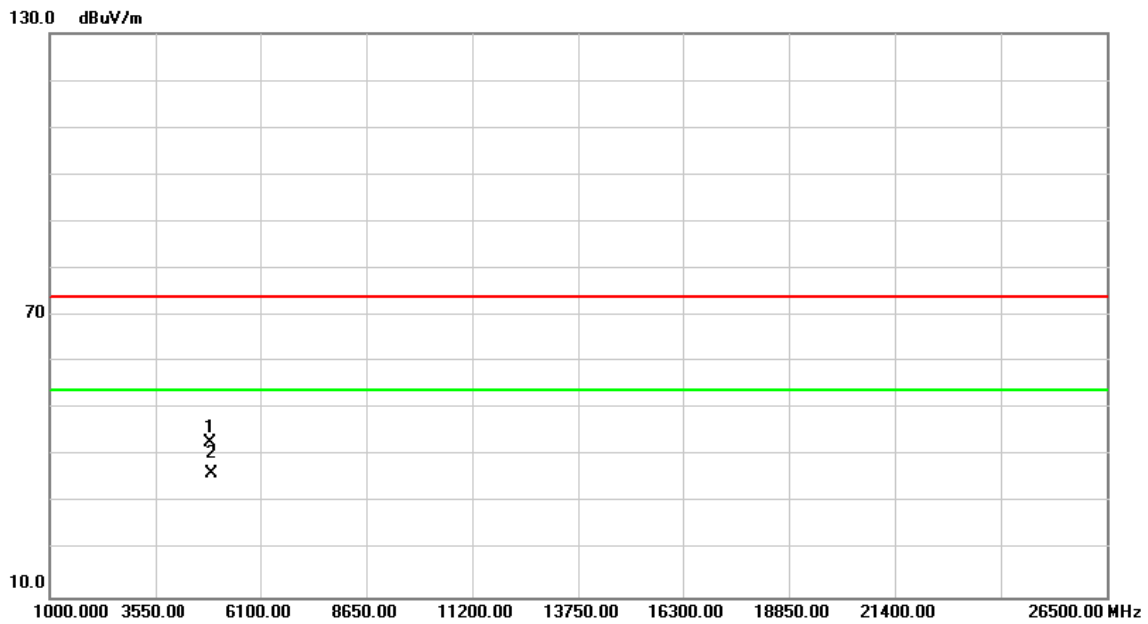

No.	Mk.	Freq. MHz	Reading Level dBuV	Correct Factor dB	Measure- ment dBuV/m	Limit dBuV/m	Margin dB	Detector	Comment
1		4882.000	38.37	4.61	42.98	74.00	-31.02	peak	
2	*	4882.000	31.66	4.61	36.27	54.00	-17.73	AVG	

**REMARKS:**

(1) Measurement Value = Reading Level + Correct Factor.

(2) Margin Level = Measurement Value - Limit Value.

Test Mode	BT (1 Mbps)	Test Date	2021/4/23
Test Frequency	CH79: 2480 MHz	Polarization	Vertical

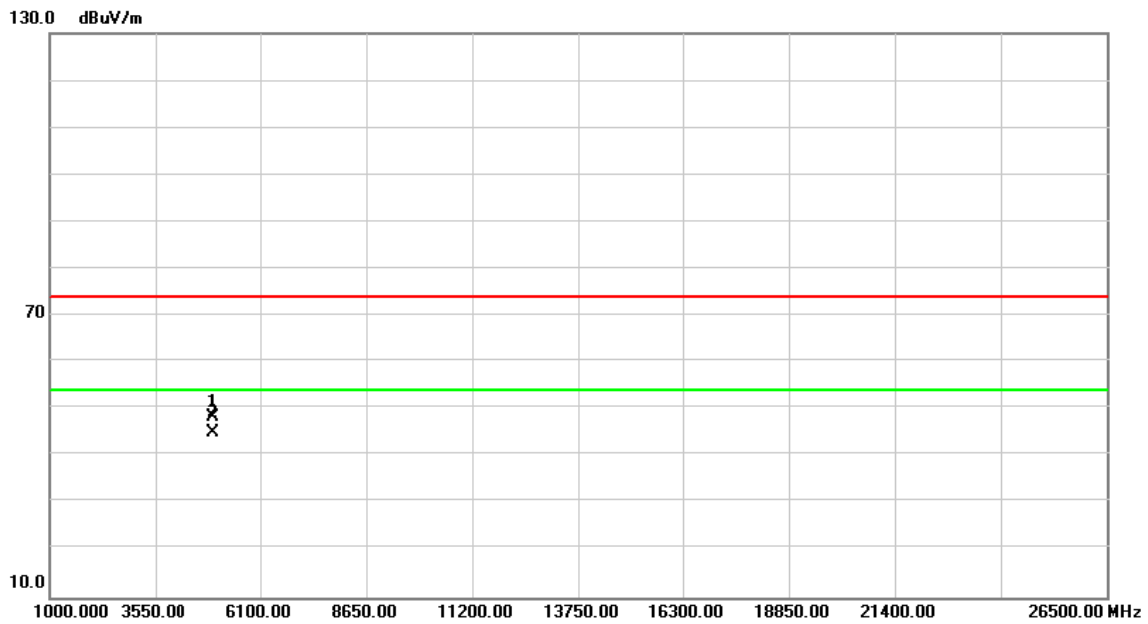

No.	Mk.	Freq. MHz	Reading Level dBuV	Correct Factor dB	Measure- ment dBuV/m	Limit dBuV/m	Margin dB	Detector	Comment
1		4960.000	43.49	4.81	48.30	74.00	-25.70	peak	
2	*	4960.000	40.15	4.81	44.96	54.00	-9.04	AVG	

**REMARKS:**

(1) Measurement Value = Reading Level + Correct Factor.

(2) Margin Level = Measurement Value - Limit Value.

Test Mode	BT (1 Mbps)	Test Date	2021/4/23
Test Frequency	CH79: 2480 MHz	Polarization	Horizontal

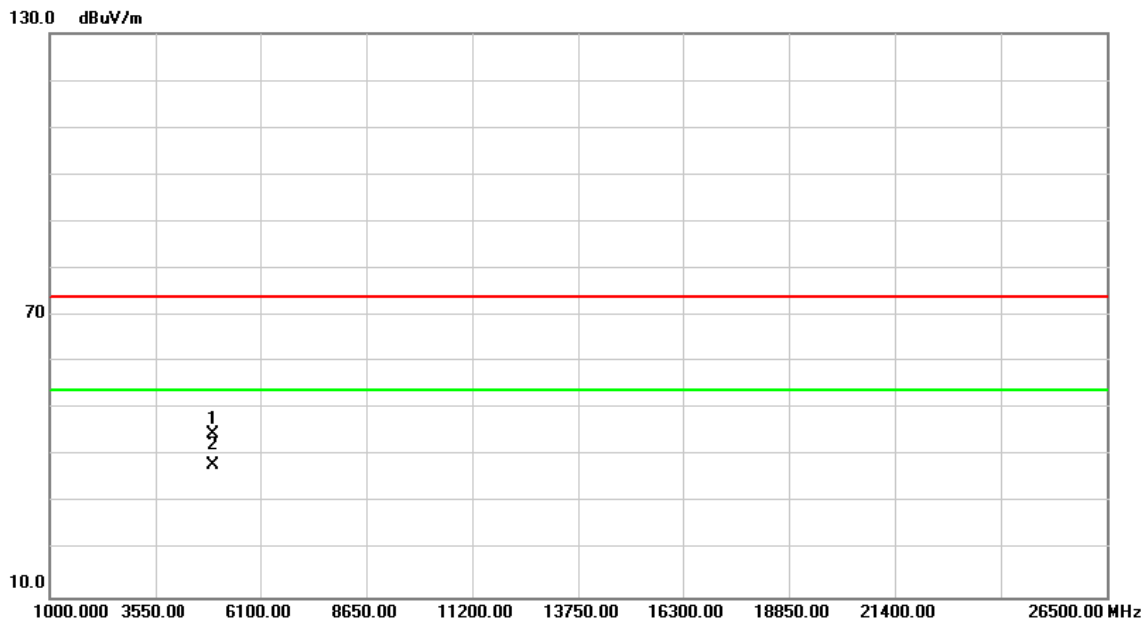

No.	Mk.	Freq. MHz	Reading Level dBuV	Correct Factor dB	Measure- ment dBuV/m	Limit dBuV/m	Margin dB	Detector	Comment
1		4960.000	39.82	4.81	44.63	74.00	-29.37	peak	
2	*	4960.000	33.22	4.81	38.03	54.00	-15.97	AVG	

**REMARKS:**

(1) Measurement Value = Reading Level + Correct Factor.

(2) Margin Level = Measurement Value - Limit Value.

Test Mode	BT (3 Mbps)	Test Date	2021/4/23
Test Frequency	CH00: 2402 MHz	Polarization	Vertical

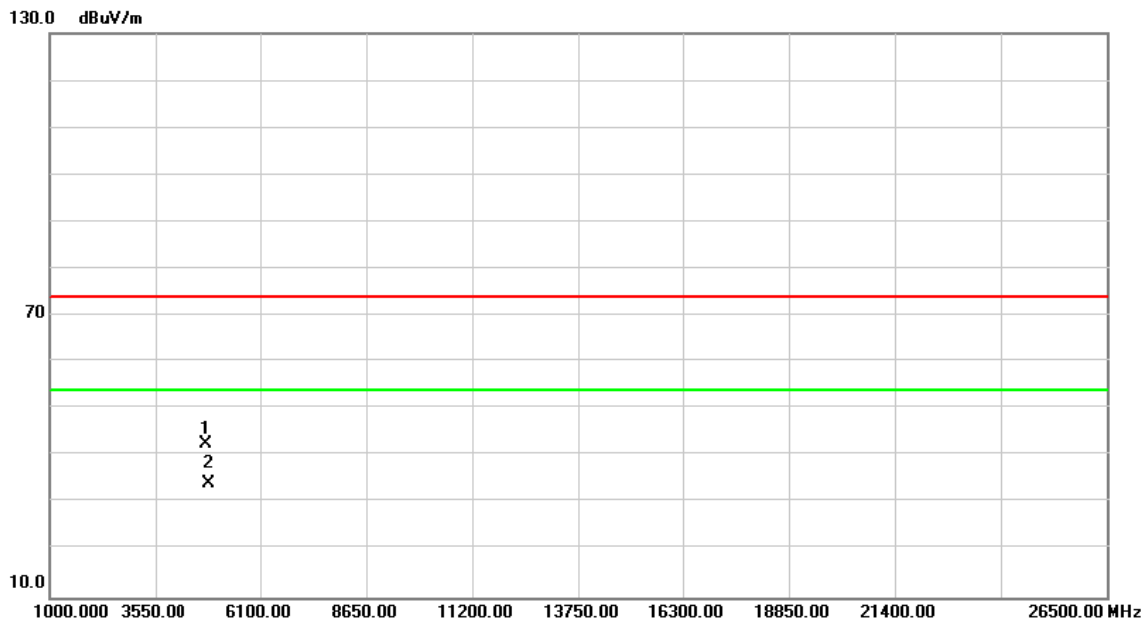

No.	Mk.	Freq. MHz	Reading Level dBuV	Correct Factor dB	Measure- ment dBuV/m	Limit dBuV/m	Margin dB	Detector	Comment
1		4804.000	38.21	4.40	42.61	74.00	-31.39	peak	
2	*	4804.000	29.74	4.40	34.14	54.00	-19.86	AVG	

**REMARKS:**

(1) Measurement Value = Reading Level + Correct Factor.

(2) Margin Level = Measurement Value - Limit Value.

Test Mode	BT (3 Mbps)	Test Date	2021/4/23
Test Frequency	CH00: 2402 MHz	Polarization	Horizontal

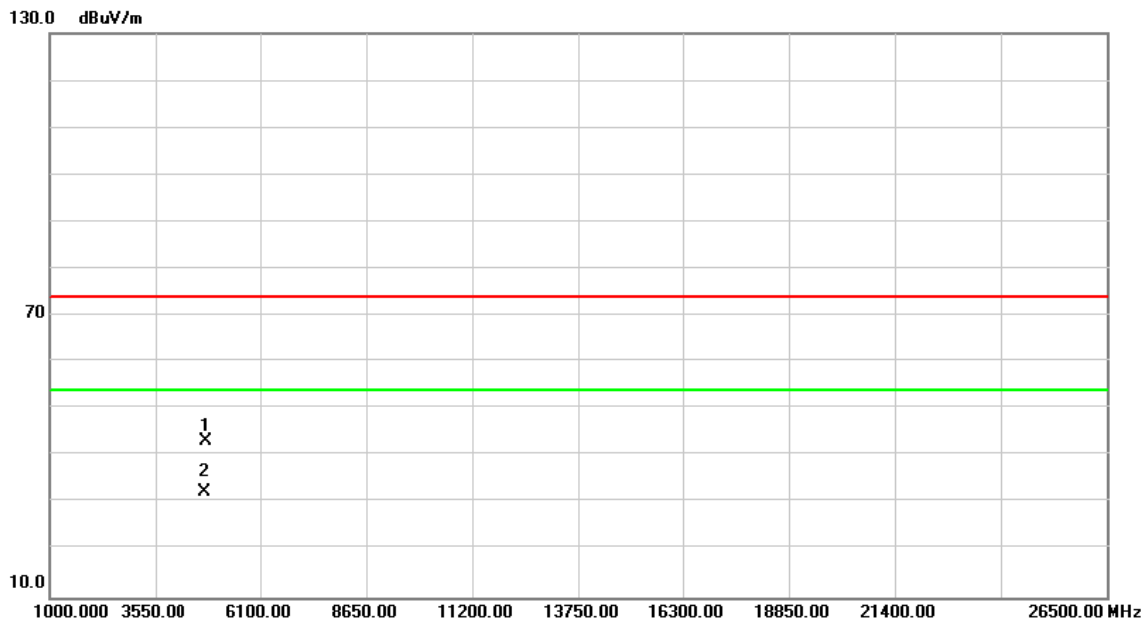

No.	Mk.	Freq. MHz	Reading Level dBuV	Correct Factor dB	Measure- ment dBuV/m	Limit dBuV/m	Margin dB	Detector	Comment
1		4804.000	38.87	4.40	43.27	74.00	-30.73	peak	
2	*	4804.000	27.80	4.40	32.20	54.00	-21.80	AVG	

**REMARKS:**

(1) Measurement Value = Reading Level + Correct Factor.

(2) Margin Level = Measurement Value - Limit Value.

Test Mode	BT (3 Mbps)	Test Date	2021/4/24
Test Frequency	CH39: 2441 MHz	Polarization	Vertical

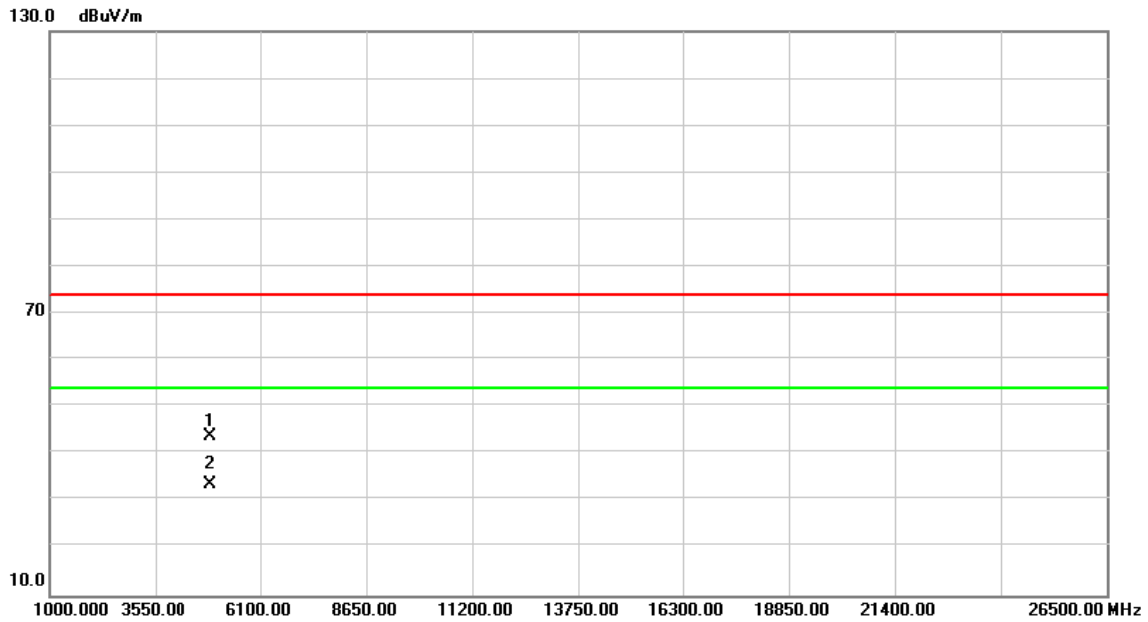

No.	Mk.	Freq. MHz	Reading Level dBuV	Correct Factor dB	Measure- ment dBuV/m	Limit dBuV/m	Margin dB	Detector	Comment
1		4882.000	39.16	4.61	43.77	74.00	-30.23	peak	
2	*	4882.000	28.99	4.61	33.60	54.00	-20.40	AVG	

**REMARKS:**

- (1) Measurement Value = Reading Level + Correct Factor.
- (2) Margin Level = Measurement Value - Limit Value.



Test Mode	BT (3 Mbps)	Test Date	2021/4/24
Test Frequency	CH39: 2441 MHz	Polarization	Horizontal

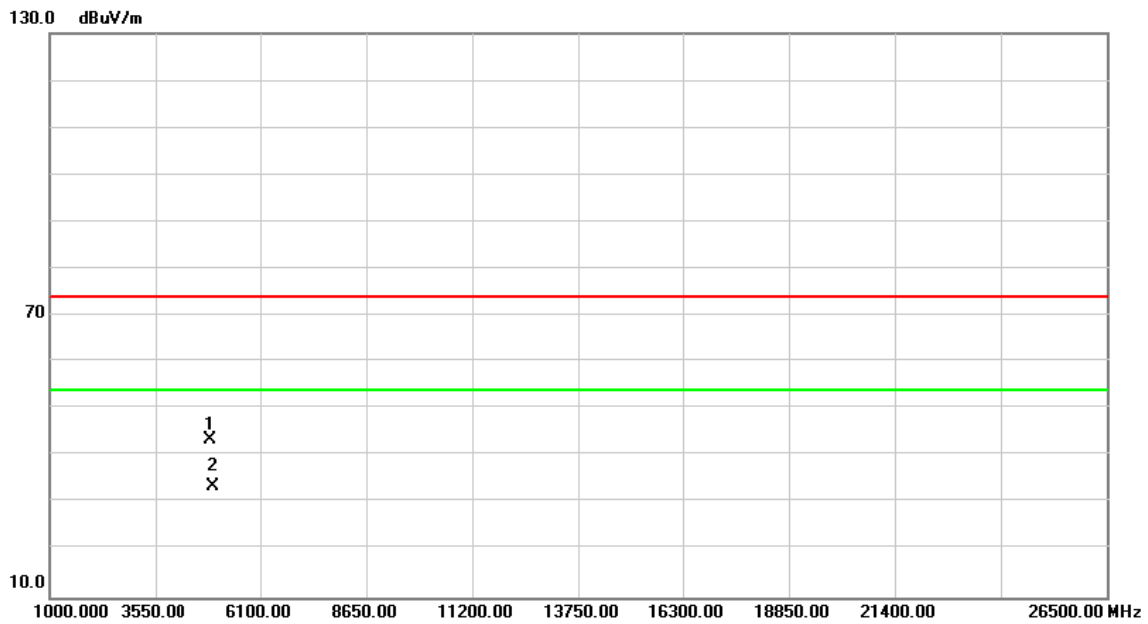

No.	Mk.	Freq. MHz	Reading Level dBuV	Correct Factor dB	Measure- ment dBuV/m	Limit dBuV/m	Margin dB	Detector	Comment
1		4882.000	38.96	4.61	43.57	74.00	-30.43	peak	
2	*	4882.000	28.81	4.61	33.42	54.00	-20.58	AVG	

**REMARKS:**

(1) Measurement Value = Reading Level + Correct Factor.

(2) Margin Level = Measurement Value - Limit Value.

Test Mode	BT (3 Mbps)	Test Date	2021/4/24
Test Frequency	CH79: 2480 MHz	Polarization	Vertical

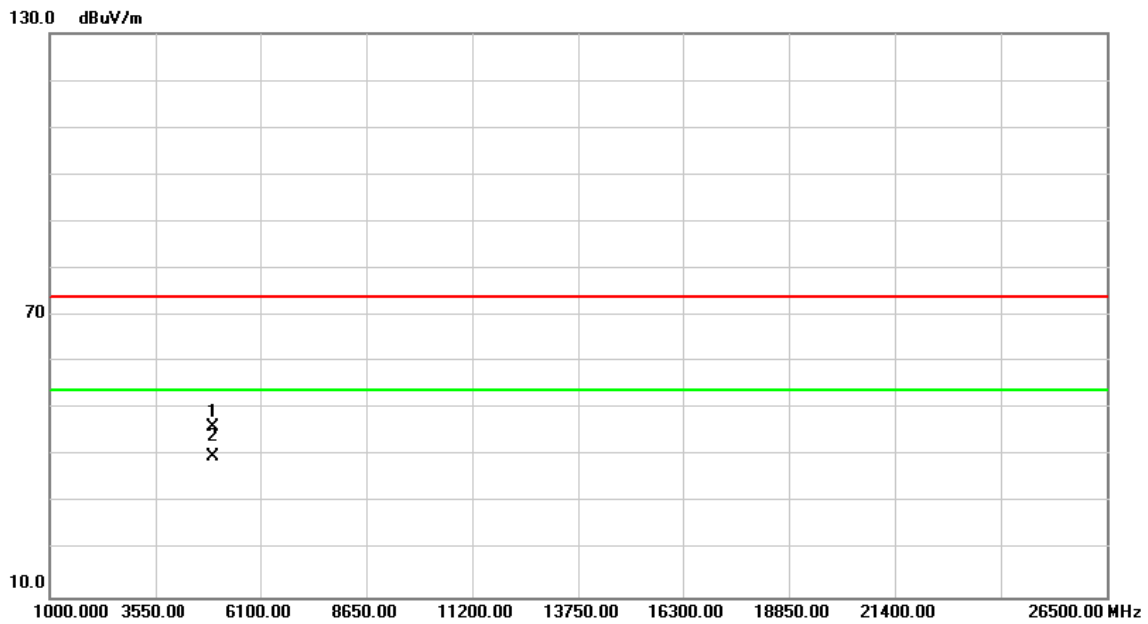

No.	Mk.	Freq. MHz	Reading Level dBuV	Correct Factor dB	Measure- ment dBuV/m	Limit dBuV/m	Margin dB	Detector	Comment
1		4960.000	41.20	4.81	46.01	74.00	-27.99	peak	
2	*	4960.000	35.11	4.81	39.92	54.00	-14.08	AVG	

**REMARKS:**

(1) Measurement Value = Reading Level + Correct Factor.

(2) Margin Level = Measurement Value - Limit Value.

Test Mode	BT (3 Mbps)	Test Date	2021/4/24
Test Frequency	CH79: 2480 MHz	Polarization	Horizontal

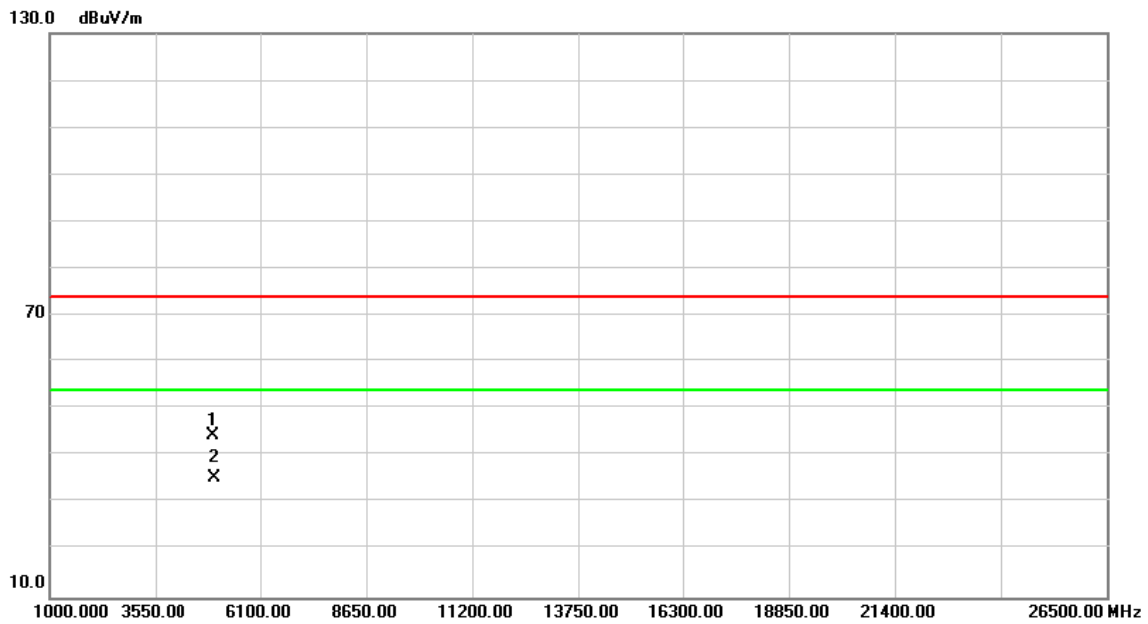

No.	Mk.	Freq. MHz	Reading Level dBuV	Correct Factor dB	Measure- ment dBuV/m	Limit dBuV/m	Margin dB	Detector	Comment
1		4960.000	39.49	4.81	44.30	74.00	-29.70	peak	
2	*	4960.000	30.51	4.81	35.32	54.00	-18.68	AVG	

**REMARKS:**

(1) Measurement Value = Reading Level + Correct Factor.

(2) Margin Level = Measurement Value - Limit Value.

**End of Test Report**