



FCC TEST REPORT (BLUETOOTH LE)

REPORT NO.: RF140704D10
MODEL NO.: BKC800
FCC ID: O57BKC800
RECEIVED: Jul. 4, 2014
TESTED: Jul. 7 ~ 8, 2014
ISSUED: Jul. 16, 2014

APPLICANT: Lenovo (Shanghai) Electronics Technology Co., Ltd.

ADDRESS: No. 68 Building, 199 Fenju Road, Wai Gao Qiao
FTZ , Shanghai , China

MANUFACTURER: Lenovo PC HK Limited

ADDRESS: 23/F, Lincoln House, Taikoo Place 979 King's Road,
Quarry Bay, Hong Kong

ISSUED BY: Bureau Veritas Consumer Products Services
(H.K.) Ltd., Taoyuan Branch

LAB ADDRESS: No. 47, 14th Ling, Chia Pau Vil., Lin Kou Dist.,
New Taipei City, Taiwan (R.O.C.)

This report should not be used by the client to claim product certification, approval, or endorsement by TAF or any government agencies.



This report is for your exclusive use. Any copying or replication of this report to or for any other person or entity, or use of our name or trademark, is permitted only with our prior written permission. This report sets forth our findings solely with respect to the test samples identified herein. The results set forth in this report are not indicative or representative of the quality or characteristics of the lot from which a test sample was taken or any similar or identical product unless specifically and expressly noted. Our report includes all of the tests requested by you and the results thereof based upon the information that you provided to us. You have 60 days from date of issuance of this report to notify us of any material error or omission caused by our negligence, provided, however, that such notice shall be in writing and shall specifically address the issue you wish to raise. A failure to raise such issue within the prescribed time shall constitute your unqualified acceptance of the completeness of this report, the tests conducted and the correctness of the report contents. Unless specific mention, the uncertainty of measurement has been explicitly taken into account to declare the compliance or non-compliance to the specification.

Table of Contents

RELEASE CONTROL RECORD.....	4
1. CERTIFICATION	5
2. SUMMARY OF TEST RESULTS.....	6
2.1 MEASUREMENT UNCERTAINTY	6
3. GENERAL INFORMATION	7
3.1 GENERAL DESCRIPTION OF EUT.....	7
3.2 DESCRIPTION OF TEST MODES.....	8
3.2.1 TEST MODE APPLICABILITY AND TESTED CHANNEL DETAIL	9
3.3 DUTY CYCLE OF TEST SIGNAL.....	11
3.4 DESCRIPTION OF SUPPORT UNITS	12
3.4.1 CONFIGURATION OF SYSTEM UNDER TEST	12
3.5 GENERAL DESCRIPTION OF APPLIED STANDARDS	13
4. TEST TYPES AND RESULTS	14
4.1 RADIATED EMISSION AND BANDEDGE MEASUREMENT	14
4.1.1 LIMITS OF RADIATED EMISSION AND BANDEDGE MEASUREMENT.....	14
4.1.2 TEST INSTRUMENTS	15
4.1.3 TEST PROCEDURES.....	16
4.1.4 DEVIATION FROM TEST STANDARD	16
4.1.5 TEST SETUP	17
4.1.6 EUT OPERATING CONDITIONS.....	18
4.1.7 TEST RESULTS.....	19
4.2 CONDUCTED EMISSION MEASUREMENT	27
4.2.1 LIMITS OF CONDUCTED EMISSION MEASUREMENT.....	27
4.2.2 TEST INSTRUMENTS	27
4.2.3 TEST PROCEDURES.....	28
4.2.4 DEVIATION FROM TEST STANDARD	28
4.2.5 TEST SETUP	29
4.2.6 EUT OPERATING CONDITIONS.....	29
4.2.7 TEST RESULTS.....	30
4.3 6DB BANDWIDTH MEASUREMENT	32
4.3.1 LIMITS OF 6DB BANDWIDTH MEASUREMENT	32
4.3.2 TEST SETUP	32
4.3.3 TEST INSTRUMENTS	32
4.3.4 TEST PROCEDURE	32
4.3.5 DEVIATION FROM TEST STANDARD	32
4.3.6 EUT OPERATING CONDITIONS.....	32
4.3.7 TEST RESULTS.....	33



4.4	CONDUCTED OUTPUT POWER	34
4.4.1	LIMITS OF CONDUCTED OUTPUT POWER MEASUREMENT	34
4.4.2	TEST SETUP	34
4.4.3	TEST INSTRUMENTS	34
4.4.4	TEST PROCEDURES	34
4.4.5	DEVIATION FROM TEST STANDARD	34
4.4.6	EUT OPERATING CONDITIONS	34
4.4.7	TEST RESULTS	35
4.5	POWER SPECTRAL DENSITY MEASUREMENT	36
4.5.1	LIMITS OF POWER SPECTRAL DENSITY MEASUREMENT	36
4.5.2	TEST SETUP	36
4.5.3	TEST INSTRUMENTS	36
4.5.4	TEST PROCEDURE	36
4.5.5	DEVIATION FROM TEST STANDARD	36
4.5.6	EUT OPERATING CONDITION	36
4.5.7	TEST RESULTS	37
4.6	CONDUCTED OUT OF BAND EMISSION MEASUREMENT	38
4.6.1	LIMITS OF CONDUCTED OUT OF BAND EMISSION MEASUREMENT	38
4.6.2	TEST SETUP	38
4.6.3	TEST INSTRUMENTS	38
4.6.4	TEST PROCEDURE	38
4.6.5	DEVIATION FROM TEST STANDARD	39
4.6.6	EUT OPERATING CONDITION	39
4.6.7	TEST RESULTS	39
5.	PHOTOGRAPHS OF THE TEST CONFIGURATION	41
6.	INFORMATION ON THE TESTING LABORATORIES	42
7.	APPENDIX A - MODIFICATIONS RECORDERS FOR ENGINEERING CHANGES TO THE EUT BY THE LAB	43



A D T

RELEASE CONTROL RECORD

ISSUE NO.	REASON FOR CHANGE	DATE ISSUED
RF140704D10	Original release	Jul. 16, 2014

1. CERTIFICATION

PRODUCT: Bluetooth Keyboard
MODEL NO.: BKC800
BRAND NAME: lenovo
APPLICANT: Lenovo (Shanghai) Electronics Technology Co., Ltd.
TESTED: Jul. 7 ~ 8, 2014
TEST SAMPLE: ENGINEERING SAMPLE
STANDARDS: **FCC Part 15, Subpart C (Section 15.247)**
ANSI C63.10-2009

The above equipment has been tested by **Bureau Veritas Consumer Products Services (H.K.) Ltd., Taoyuan Branch**, and found compliance with the requirement of the above standards. The test record, data evaluation & Equipment Under Test (EUT) configurations represented herein are true and accurate accounts of the measurements of the sample's EMC characteristics under the conditions specified in this report.

PREPARED BY : Celia Chen , **DATE:** Jul. 16, 2014
(Celia Chen / Senior Specialist)

APPROVED BY : Rex Lai , **DATE:** Jul. 16, 2014
(Rex Lai / Assistant Manager)

2. SUMMARY OF TEST RESULTS

The EUT has been tested according to the following specifications:

APPLIED STANDARD: FCC PART 15, SUBPART C			
STANDARD SECTION	TEST TYPE	RESULT	REMARK
15.207	AC Power Conducted Emission	PASS	Meet the requirement of limit. Minimum passing margin is -13.11dB at 0.16562MHz.
15.205 & 15.209	Radiated Emissions	PASS	Meet the requirement of limit. Minimum passing margin is -10.8dB at 166.58MHz.
15.247(d)	Band Edge Measurement	PASS	Meet the requirement of limit. Minimum passing margin is -8.8dB at 2400.00MHz.
15.247(d)	Antenna Port Emission	PASS	Meet the requirement of limit.
15.247(a)(2)	6dB bandwidth	PASS	Meet the requirement of limit.
15.247(b)	Conducted power	PASS	Meet the requirement of limit.
15.247(e)	Power Spectral Density	PASS	Meet the requirement of limit.
15.203	Antenna Requirement	PASS	No antenna connector is used.

2.1 MEASUREMENT UNCERTAINTY

Where relevant, the following measurement uncertainty levels have been estimated for tests performed on the EUT as specified in CISPR 16-4-2:

This uncertainty represents an expanded uncertainty expressed at approximately the 95% confidence level using a coverage factor of k=2.

Measurement	Frequency	Uncertainty
Conducted emissions	150kHz ~ 30MHz	3.43 dB
Radiated emissions	30MHz ~ 1GHz	4.00 dB
	Above 1GHz	3.36 dB

3. GENERAL INFORMATION

3.1 GENERAL DESCRIPTION OF EUT

EUT	Bluetooth Keyboard
MODEL NO.	BKC800
POWER SUPPLY	3.7Vdc (from battery) or 5.0Vdc (from USB adapter)
MODULATION TYPE	GFSK
TRANSFER RATE	20kbps-305Kbps
NUMBER OF CHANNEL	40
CHANNEL SPACING	2MHz
OPERATING FREQUENCY	2402-2480MHz
MAX. OUTPUT POWER	1.0mW
ANTENNA TYPE	PCB antenna with -3.05dBi gain
ANTENNA CONNECTOR	N/A
I/O PORTS	Micro USB port
DATA CABLE	Shielded USB cable (1.0m) with one ferrite core
ACCESSORY DEVICES	N/A

NOTE:

1. The EUT is a Bluetooth Keyboard with Micro USB interface.
2. The USB function on this product is for battery charging only, no data transmitting and/or receiving function involved.
3. The above EUT information is declared by manufacturer and for more detailed features description, please refer to the manufacturer's specifications or User's Manual.



3.2 DESCRIPTION OF TEST MODES

40 channels are provided to this EUT:

CHANNEL	FREQ. (MHz)	CHANNEL	FREQ. (MHz)	CHANNEL	FREQ. (MHz)	CHANNEL	FREQ. (MHz)
0	2402	10	2422	20	2442	30	2462
1	2404	11	2424	21	2444	31	2464
2	2406	12	2426	22	2446	32	2466
3	2408	13	2428	23	2448	33	2468
4	2410	14	2430	24	2450	34	2470
5	2412	15	2432	25	2452	35	2472
6	2414	16	2434	26	2454	36	2474
7	2416	17	2436	27	2456	37	2476
8	2418	18	2438	28	2458	38	2478
9	2420	19	2440	29	2460	39	2480



3.2.1 TEST MODE APPLICABILITY AND TESTED CHANNEL DETAIL

EUT CONFIGURE MODE	APPLICABLE TO					DESCRIPTION
	PLC	RE < 1G	RE ≥ 1G	APCM	OB	
A	√	√	√	√	√	Operating + Charging (EUT with USB adapter)
B	NOTE	√	√	-	-	Operating (EUT only)

Where **PLC**: Power Line Conducted Emission **RE < 1G**: Radiated Emission below 1GHz
RE ≥ 1G: Radiated Emission above 1GHz **APCM**: Antenna Port Conducted Measurement
OB: Conducted Out-Band Emission Measurement

NOTE: No need to concern of Conducted Emission due to the EUT is powered by battery.

RADIATED EMISSION TEST (BELOW 1 GHz):

- Pre-Scan has been conducted to determine the worst-case mode from all possible combinations between available modulations, data rates and antenna ports (if EUT with antenna diversity architecture).
- Following channel(s) was (were) selected for the final test as listed below.

EUT CONFIGURE MODE	AVAILABLE CHANNEL	TESTED CHANNEL	MODULATION TYPE
A & B	0 to 39	39	GFSK

RADIATED EMISSION TEST (ABOVE 1 GHz):

- Pre-Scan has been conducted to determine the worst-case mode from all possible combinations between available modulations, data rates and antenna ports (if EUT with antenna diversity architecture).
- Following channel(s) was (were) selected for the final test as listed below.

EUT CONFIGURE MODE	AVAILABLE CHANNEL	TESTED CHANNEL	MODULATION TYPE
A & B	0 to 39	0, 19, 39	GFSK

POWER LINE CONDUCTED EMISSION TEST:

- Pre-Scan has been conducted to determine the worst-case mode from all possible combinations between available modulations, antenna ports (if EUT with antenna diversity architecture) and packet types.
- Following channel(s) was (were) selected for the final test as listed below.

EUT CONFIGURE MODE	AVAILABLE CHANNEL	TESTED CHANNEL	MODULATION TYPE
A	0 to 39	39	GFSK

ANTENNA PORT CONDUCTED MEASUREMENT:

- Pre-Scan has been conducted to determine the worst-case mode from all possible combinations between available modulations, data rates and antenna ports (if EUT with antenna diversity architecture).
- Following channel(s) was (were) selected for the final test as listed below.

EUT CONFIGURE MODE	AVAILABLE CHANNEL	TESTED CHANNEL	MODULATION TYPE
A	0 to 39	0, 19, 39	GFSK

CONDUCTED OUT-BAND EMISSION MEASUREMENT:

- Pre-Scan has been conducted to determine the worst-case mode from all possible combinations between available modulations, data rates and antenna ports (if EUT with antenna diversity architecture).
- Following channel(s) was (were) selected for the final test as listed below.

EUT CONFIGURE MODE	AVAILABLE CHANNEL	TESTED CHANNEL	MODULATION TYPE
A	0 to 39	0, 19, 39	GFSK

TEST CONDITION:

APPLICABLE TO	EUT CONFIGURE MODE	ENVIRONMENTAL CONDITIONS	INPUT POWER	TESTED BY
RE<1G	A	25deg. C, 72% RH	120Vac, 60Hz (Adapter)	Joey Liu
	B	25deg. C, 72% RH	3.7Vdc	Joey Liu
RE ³ 1G	A	25deg. C, 72% RH	120Vac, 60Hz (Adapter)	Joey Liu
	B	25deg. C, 72% RH	3.7Vdc	Joey Liu
PLC	A	23deg. C, 60% RH	120Vac, 60Hz (Adapter)	Dalen Dai
APCM	A	20deg. C, 70% RH	120Vac, 60Hz (Adapter)	Saxon Lee
OB	A	20deg. C, 70% RH	120Vac, 60Hz (Adapter)	Saxon Lee



A D T

3.3 DUTY CYCLE OF TEST SIGNAL

Duty cycle of test signal is < 98%

Duty cycle = $0.708/1.166 = 0.607$, Duty factor = $10 * \log(1/0.607) = 2.17$

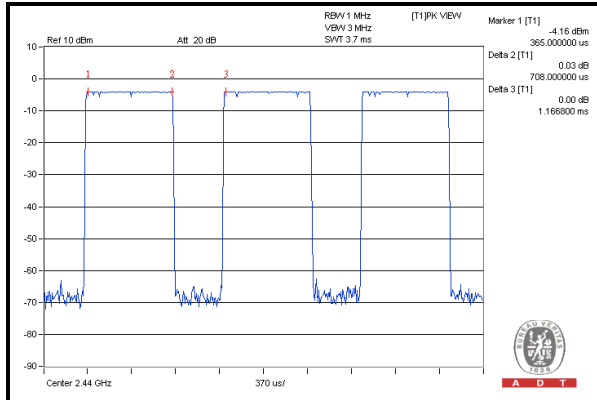



3.4 DESCRIPTION OF SUPPORT UNITS

The EUT has been tested as an independent unit together with other necessary accessories or support units. The following support units or accessories were used to form a representative test configuration during the tests.

NO.	PRODUCT	BRAND	MODEL NO.	SERIAL NO.	FCC ID
1	ADAPTER	lenovo	C-P32	N/A	FCC DoC Approved

NO.	SIGNAL CABLE DESCRIPTION OF THE ABOVE SUPPORT UNITS
1	N/A

- Note: 1. The support unit 1 was provided by client.
 2. Rating of support unit 1 was listed as below:
 AC I/P: 100-240V, 0.5A, 50/60Hz
 DC O/P: 5.2V, 2000mA

3.4.1 CONFIGURATION OF SYSTEM UNDER TEST

FOR MODE A:

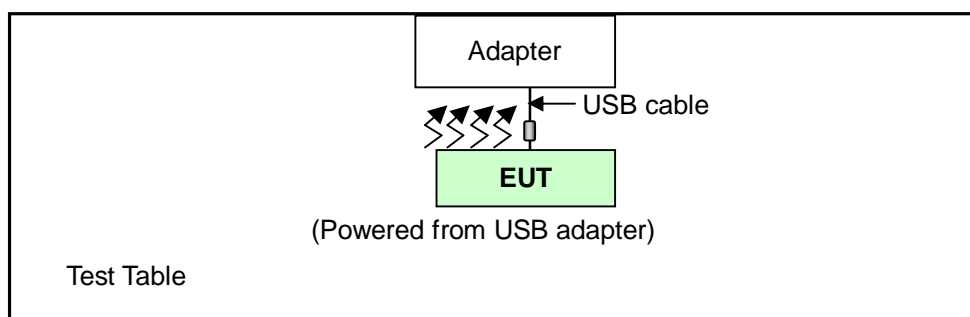

FOR MODE B:

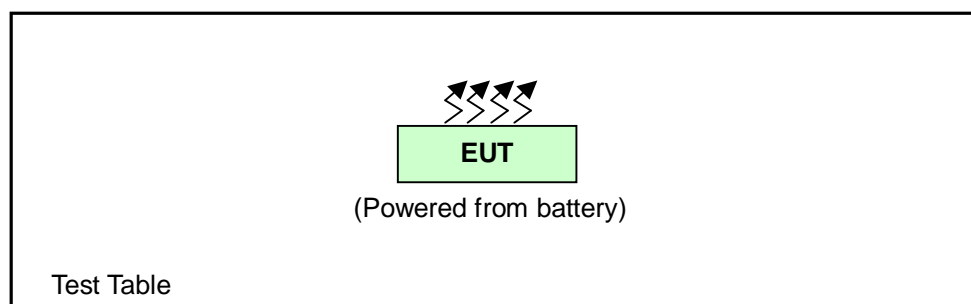



A D T

3.5 GENERAL DESCRIPTION OF APPLIED STANDARDS

The EUT is a RF Product. According to the specifications of the manufacturer, it must comply with the requirements of the following standards:

FCC Part 15, Subpart C. (15.247)

558074 D01 DTS Meas Guidance v03r02

ANSI C63.10-2009

All test items have been performed and recorded as per the above standards.

4. TEST TYPES AND RESULTS

4.1 RADIATED EMISSION AND BANDEDGE MEASUREMENT

4.1.1 LIMITS OF RADIATED EMISSION AND BANDEDGE MEASUREMENT

Radiated emissions which fall in the restricted bands must comply with the radiated emission limits specified as below table. Other emissions shall be at least 20dB below the highest level of the desired power:

FREQUENCIES (MHz)	FIELD STRENGTH (microvolts/meter)	MEASUREMENT DISTANCE (meters)
0.009 ~ 0.490	2400/F(kHz)	300
0.490 ~ 1.705	24000/F(kHz)	30
1.705 ~ 30.0	30	30
30 ~ 88	100	3
88 ~ 216	150	3
216 ~ 960	200	3
Above 960	500	3

NOTE:

1. The lower limit shall apply at the transition frequencies.
2. Emission level (dBuV/m) = 20 log Emission level (uV/m).
3. For frequencies above 1000MHz, the field strength limits are based on average detector, however, the peak field strength of any emission shall not exceed the maximum permitted average limits, specified above by more than 20dB under any condition of modulation.

4.1.2 TEST INSTRUMENTS

DESCRIPTION & MANUFACTURER	MODEL NO.	SERIAL NO.	CALIBRATED DATE	CALIBRATED UNTIL
HP Preamplifier	8447D	2432A03504	Feb. 26, 2014	Feb. 25, 2015
HP Preamplifier	8449B	3008A01201	Feb. 26, 2014	Feb. 25, 2015
Agilent TEST RECEIVER	N9038A	MY51210129	Jan. 18, 2014	Jan. 17, 2015
Schwarzbeck Antenna	VULB 9168	139	Feb. 24, 2014	Feb. 23, 2015
Schwarzbeck Antenna	VHBA 9123	480	May 29, 2013	May 28, 2015
ADT. Turn Table	TT100	0306	NA	NA
ADT. Tower	AT100	0306	NA	NA
Software	ADT_Radiated_V 7.6.15.9.4	NA	NA	NA
SUHNER RF cable	SF102	CABLE-CH6	Aug. 16, 2013	Aug. 15, 2014
EMCO Horn Antenna	3115	00028257	Sep. 27, 2013	Sep. 26, 2014
Highpass filter Wainwright Instruments	WHK 3.1/18G-10SS	SN 8	NA	NA
ROHDE & SCHWARZ Spectrum Analyzer	FSP 40	100036	May 17, 2014	May 16, 2015
Anritsu Power Sensor	MA2411B	0738404	Apr. 21, 2014	Apr. 20, 2015
Anritsu Power Meter	ML2495A	0842014	Apr. 21, 2014	Apr. 20, 2015

- NOTE:** 1. The calibration interval of the above test instruments is 12/24 months. And the calibrations are traceable to NML/ROC and NIST/USA.
2. The horn antenna and HP preamplifier (model: 8449B) are used only for the measurement of emission frequency above 1GHz if tested.
3. The test was performed in Chamber No. 6.
4. The Industry Canada Reference No. IC 7450E-6.
5. The FCC Site Registration No. is 447212.

4.1.3 TEST PROCEDURES

- a. The EUT was placed on the top of a rotating table 0.8 meters above the ground at a 3 meter semi-anechoic chamber. The table was rotated 360 degrees to determine the position of the highest radiation.
- b. The EUT was set 3 meters away from the interference-receiving antenna, which was mounted on the top of a variable-height antenna tower.
- c. The height is varied from one meter to four meters above the ground to determine the maximum value of the field strength. Both horizontal and vertical polarizations of the antenna are set to make the measurement.
- d. For each suspected emission, the EUT was arranged to its worst case and then the antenna was tuned to heights from 1 meter to 4 meters and the rotatable table was turned from 0 degrees to 360 degrees to find the maximum reading.
- e. The test-receiver system was set to Peak Detect Function and Specified Bandwidth with Maximum Hold Mode.
- f. If the emission level of the EUT in peak mode was lower than the limit specified, then testing could be stopped and the peak values of the EUT would be reported. Otherwise the emissions would be re-tested one by one using peak, quasi-peak or average method as specified and then reported in a data sheet.

NOTE:

1. The resolution bandwidth and video bandwidth of test receiver/spectrum analyzer is 120kHz for Quasi-peak detection at frequency below 1GHz.
2. The resolution bandwidth of test receiver/spectrum analyzer is 1MHz and video bandwidth is 3MHz for Peak detection at frequency above 1GHz.
3. The resolution bandwidth of test receiver/spectrum analyzer is 1MHz and the video bandwidth is $\geq 1/T$ (Duty cycle < 98%) or 10Hz (Duty cycle > 98%) for Average detection (AV) at frequency above 1GHz.
4. All modes of operation were investigated and the worst-case emissions are reported.

4.1.4 DEVIATION FROM TEST STANDARD

No deviation.

4.1.5 TEST SETUP

Frequency range 30MHz~1GHz

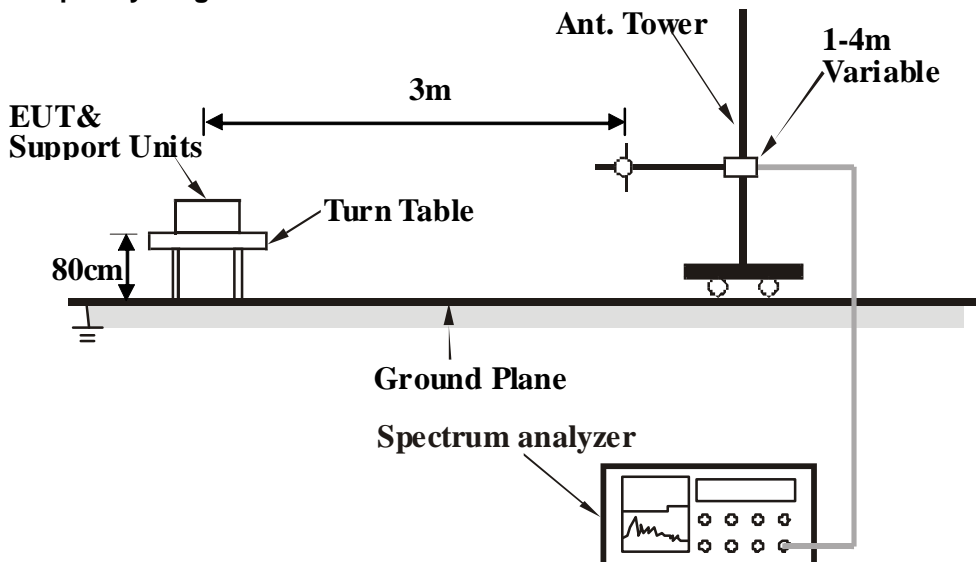

Frequency range above 1GHz

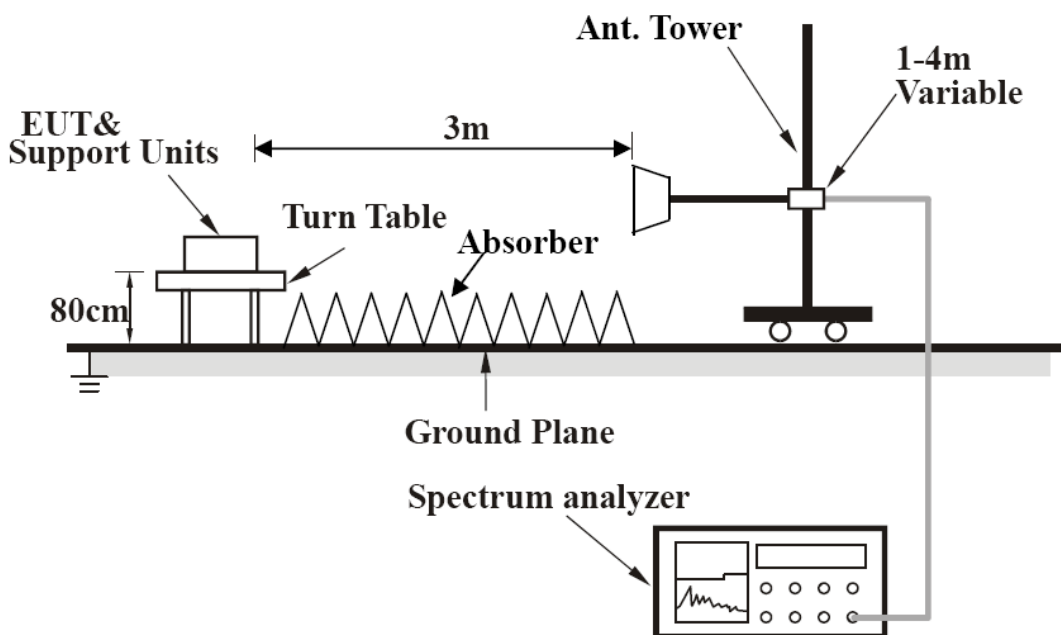

For the actual test configuration, please refer to the attached file (Test Setup Photo).

4.1.6 EUT OPERATING CONDITIONS

For Mode A:

- a. Turn on the power of all equipment.
- b. Notebook ran a test program (provided by manufacture) to enable EUT under transmitting condition at specific channel continuously.
- c. Set the EUT under transmitting and charging condition.

For Mode B:

Set the EUT under transmission/receiving condition continuously at specific channel frequency.



4.1.7 TEST RESULTS

ABOVE 1GHz DATA

CHANNEL	TX Channel 0	DETECTOR FUNCTION	Peak (PK)
FREQUENCY RANGE	1GHz ~ 25GHz		Average (AV)
TEST MODE	A		

ANTENNA POLARITY & TEST DISTANCE: HORIZONTAL AT 3 M								
NO.	FREQ. (MHz)	EMISSION LEVEL (dBuV/m)	LIMIT (dBuV/m)	MARGIN (dB)	ANTENNA HEIGHT (m)	TABLE ANGLE (Degree)	RAW VALUE (dBuV)	CORRECTION FACTOR (dB/m)
1	2390.00	42.5 PK	74.0	-31.5	1.17 H	153	46.11	-3.58
2	2390.00	28.3 AV	54.0	-25.8	1.17 H	153	31.83	-3.58
3	#2400.00	48.3 PK	63.2	-14.9	1.17 H	153	51.86	-3.54
4	#2400.00	33.4 AV	42.6	-9.2	1.17 H	153	36.95	-3.54
5	*2402.00	83.2 PK			1.17 H	154	86.73	-3.54
6	*2402.00	62.6 AV			1.17 H	154	66.11	-3.54
7	4804.00	48.1 PK	74.0	-26.0	1.17 H	154	44.13	3.92
8	4804.00	34.8 AV	54.0	-19.2	1.17 H	154	30.87	3.92
ANTENNA POLARITY & TEST DISTANCE: VERTICAL AT 3 M								
NO.	FREQ. (MHz)	EMISSION LEVEL (dBuV/m)	LIMIT (dBuV/m)	MARGIN (dB)	ANTENNA HEIGHT (m)	TABLE ANGLE (Degree)	RAW VALUE (dBuV)	CORRECTION FACTOR (dB/m)
1	2390.00	42.6 PK	74.0	-31.4	1.00 V	194	46.21	-3.58
2	2390.00	28.3 AV	54.0	-25.7	1.00 V	194	31.91	-3.58
3	#2400.00	46.4 PK	59.1	-12.6	1.00 V	194	49.98	-3.54
4	#2400.00	31.5 AV	42.0	-10.5	1.00 V	194	35.04	-3.54
5	*2402.00	79.1 PK			1.00 V	194	82.63	-3.54
6	*2402.00	62.0 AV			1.00 V	194	65.53	-3.54
7	4804.00	48.9 PK	74.0	-25.1	1.00 V	341	44.96	3.92
8	4804.00	34.7 AV	54.0	-19.3	1.00 V	341	30.78	3.92

REMARKS:

- Emission Level(dBuV/m) = Raw Value(dBuV) + Correction Factor(dB/m)
- Correction Factor(dB/m) = Antenna Factor(dB/m) + Cable Factor(dB) – Pre-Amplifier Factor(dB)
- The other emission levels were very low against the limit.
- Margin value = Emission Level – Limit value
- " * ": Fundamental frequency.
- " # ": The radiated frequency is out of the restricted band.



A D T

CHANNEL	TX Channel 19	DETECTOR FUNCTION	Peak (PK)
FREQUENCY RANGE	1GHz ~ 25GHz		Average (AV)
TEST MODE	A		

ANTENNA POLARITY & TEST DISTANCE: HORIZONTAL AT 3 M								
NO.	FREQ. (MHz)	EMISSION LEVEL (dBuV/m)	LIMIT (dBuV/m)	MARGIN (dB)	ANTENNA HEIGHT (m)	TABLE ANGLE (Degree)	RAW VALUE (dBuV)	CORRECTION FACTOR (dB/m)
1	*2440.00	80.1 PK			1.22 H	162	83.47	-3.42
2	*2440.00	60.6 AV			1.22 H	162	63.97	-3.42
3	4880.00	47.9 PK	74.0	-26.1	1.04 H	21	43.63	4.29
4	4880.00	34.4 AV	54.0	-19.6	1.04 H	21	30.12	4.29
ANTENNA POLARITY & TEST DISTANCE: VERTICAL AT 3 M								
NO.	FREQ. (MHz)	EMISSION LEVEL (dBuV/m)	LIMIT (dBuV/m)	MARGIN (dB)	ANTENNA HEIGHT (m)	TABLE ANGLE (Degree)	RAW VALUE (dBuV)	CORRECTION FACTOR (dB/m)
1	*2440.00	78.5 PK			1.00 V	202	81.89	-3.42
2	*2440.00	59.4 AV			1.00 V	202	62.86	-3.42
3	4880.00	47.7 PK	74.0	-26.3	1.00 V	125	43.38	4.29
4	4880.00	35.4 AV	54.0	-18.6	1.00 V	125	31.14	4.29

REMARKS:

1. Emission Level(dBuV/m) = Raw Value(dBuV) + Correction Factor(dB/m)
2. Correction Factor(dB/m) = Antenna Factor(dB/m) + Cable Factor(dB) – Pre-Amplifier Factor(dB)
3. The other emission levels were very low against the limit.
4. Margin value = Emission Level – Limit value
5. " * ": Fundamental frequency.



A D T

CHANNEL	TX Channel 39	DETECTOR FUNCTION	Peak (PK)
FREQUENCY RANGE	1GHz ~ 25GHz		Average (AV)
TEST MODE	A		

ANTENNA POLARITY & TEST DISTANCE: HORIZONTAL AT 3 M

NO.	FREQ. (MHz)	EMISSION LEVEL (dBuV/m)	LIMIT (dBuV/m)	MARGIN (dB)	ANTENNA HEIGHT (m)	TABLE ANGLE (Degree)	RAW VALUE (dBuV)	CORRECTION FACTOR (dB/m)
1	*2480.00	83.3 PK			1.21 H	171	86.60	-3.31
2	*2480.00	62.8 AV			1.21 H	171	66.07	-3.31
3	2483.50	44.4 PK	74.0	-29.6	1.21 H	171	47.74	-3.30
4	2483.50	30.1 AV	54.0	-23.9	1.21 H	171	33.42	-3.30
5	4960.00	48.7 PK	74.0	-25.3	1.05 H	245	44.15	4.54
6	4960.00	34.7 AV	54.0	-19.3	1.05 H	245	30.17	4.54

ANTENNA POLARITY & TEST DISTANCE: VERTICAL AT 3 M

NO.	FREQ. (MHz)	EMISSION LEVEL (dBuV/m)	LIMIT (dBuV/m)	MARGIN (dB)	ANTENNA HEIGHT (m)	TABLE ANGLE (Degree)	RAW VALUE (dBuV)	CORRECTION FACTOR (dB/m)
1	*2480.00	78.6 PK			1.00 V	197	81.95	-3.31
2	*2480.00	59.8 AV			1.00 V	197	63.06	-3.31
3	2483.50	43.0 PK	74.0	-31.0	1.00 V	197	46.32	-3.30
4	2483.50	29.1 AV	54.0	-24.9	1.00 V	197	32.36	-3.30
5	4960.00	48.4 PK	74.0	-25.7	1.00 V	139	43.81	4.54
6	4960.00	36.2 AV	54.0	-17.8	1.00 V	139	31.62	4.54

REMARKS:

1. Emission Level(dBuV/m) = Raw Value(dBuV) + Correction Factor(dB/m)
2. Correction Factor(dB/m) = Antenna Factor(dB/m) + Cable Factor(dB) – Pre-Amplifier Factor(dB)
3. The other emission levels were very low against the limit.
4. Margin value = Emission Level – Limit value
5. " * ": Fundamental frequency.



A D T

CHANNEL	TX Channel 0	DETECTOR FUNCTION	Peak (PK)
FREQUENCY RANGE	1GHz ~ 25GHz		Average (AV)
TEST MODE	B		

ANTENNA POLARITY & TEST DISTANCE: HORIZONTAL AT 3 M								
NO.	FREQ. (MHz)	EMISSION LEVEL (dBuV/m)	LIMIT (dBuV/m)	MARGIN (dB)	ANTENNA HEIGHT (m)	TABLE ANGLE (Degree)	RAW VALUE (dBuV)	CORRECTION FACTOR (dB/m)
1	2390.00	42.2 PK	74.0	-31.8	1.20 H	166	45.78	-3.58
2	2390.00	28.0 AV	54.0	-26.0	1.20 H	166	31.54	-3.58
3	#2400.00	47.8 PK	63.0	-15.2	1.20 H	166	51.36	-3.54
4	#2400.00	33.1 AV	41.9	-8.8	1.20 H	166	36.66	-3.54
5	*2402.00	83.0 PK			1.20 H	166	86.54	-3.54
6	*2402.00	61.9 AV			1.20 H	166	65.48	-3.54
7	4804.00	48.0 PK	74.0	-26.0	1.20 H	236	44.05	3.92
8	4804.00	34.7 AV	54.0	-19.3	1.20 H	236	30.82	3.92

ANTENNA POLARITY & TEST DISTANCE: VERTICAL AT 3 M								
NO.	FREQ. (MHz)	EMISSION LEVEL (dBuV/m)	LIMIT (dBuV/m)	MARGIN (dB)	ANTENNA HEIGHT (m)	TABLE ANGLE (Degree)	RAW VALUE (dBuV)	CORRECTION FACTOR (dB/m)
1	2390.00	42.5 PK	74.0	-31.5	1.00 V	201	46.04	-3.58
2	2390.00	28.3 AV	54.0	-25.7	1.00 V	201	31.88	-3.58
3	#2400.00	46.3 PK	58.8	-12.5	1.00 V	201	49.86	-3.54
4	#2400.00	31.3 AV	41.8	-10.5	1.00 V	201	34.86	-3.54
5	*2402.00	78.8 PK			1.00 V	201	82.35	-3.54
6	*2402.00	61.8 AV			1.00 V	201	65.31	-3.54
7	4804.00	48.5 PK	74.0	-25.6	1.00 V	296	44.53	3.92
8	4804.00	34.5 AV	54.0	-19.5	1.00 V	296	30.61	3.92

REMARKS:

1. Emission Level(dBuV/m) = Raw Value(dBuV) + Correction Factor(dB/m)
2. Correction Factor(dB/m) = Antenna Factor(dB/m) + Cable Factor(dB) – Pre-Amplifier Factor(dB)
3. The other emission levels were very low against the limit.
4. Margin value = Emission Level – Limit value
5. " * ": Fundamental frequency.
6. " # ": The radiated frequency is out of the restricted band.



A D T

CHANNEL	TX Channel 19	DETECTOR FUNCTION	Peak (PK)
FREQUENCY RANGE	1GHz ~ 25GHz		Average (AV)
TEST MODE	B		

ANTENNA POLARITY & TEST DISTANCE: HORIZONTAL AT 3 M								
NO.	FREQ. (MHz)	EMISSION LEVEL (dBuV/m)	LIMIT (dBuV/m)	MARGIN (dB)	ANTENNA HEIGHT (m)	TABLE ANGLE (Degree)	RAW VALUE (dBuV)	CORRECTION FACTOR (dB/m)
1	*2440.00	80.0 PK			1.25 H	171	83.45	-3.42
2	*2440.00	60.0 AV			1.25 H	171	63.45	-3.42
3	4880.00	47.8 PK	74.0	-26.2	1.05 H	43	43.51	4.29
4	4880.00	34.6 AV	54.0	-19.4	1.05 H	43	30.32	4.29
ANTENNA POLARITY & TEST DISTANCE: VERTICAL AT 3 M								
NO.	FREQ. (MHz)	EMISSION LEVEL (dBuV/m)	LIMIT (dBuV/m)	MARGIN (dB)	ANTENNA HEIGHT (m)	TABLE ANGLE (Degree)	RAW VALUE (dBuV)	CORRECTION FACTOR (dB/m)
1	*2440.00	78.1 PK			1.00 V	211	81.54	-3.42
2	*2440.00	58.9 AV			1.00 V	211	62.34	-3.42
3	4880.00	47.4 PK	74.0	-26.6	1.00 V	115	43.08	4.29
4	4880.00	35.5 AV	54.0	-18.5	1.00 V	115	31.21	4.29

REMARKS:

1. Emission Level(dBuV/m) = Raw Value(dBuV) + Correction Factor(dB/m)
2. Correction Factor(dB/m) = Antenna Factor(dB/m) + Cable Factor(dB) – Pre-Amplifier Factor(dB)
3. The other emission levels were very low against the limit.
4. Margin value = Emission Level – Limit value
5. " * ": Fundamental frequency.



A D T

CHANNEL	TX Channel 39	DETECTOR FUNCTION	Peak (PK)
FREQUENCY RANGE	1GHz ~ 25GHz		Average (AV)
TEST MODE	B		

ANTENNA POLARITY & TEST DISTANCE: HORIZONTAL AT 3 M

NO.	FREQ. (MHz)	EMISSION LEVEL (dBuV/m)	LIMIT (dBuV/m)	MARGIN (dB)	ANTENNA HEIGHT (m)	TABLE ANGLE (Degree)	RAW VALUE (dBuV)	CORRECTION FACTOR (dB/m)
1	*2480.00	82.9 PK			1.22 H	180	86.25	-3.31
2	*2480.00	62.7 AV			1.22 H	180	66.01	-3.31
3	2483.50	44.2 PK	74.0	-29.8	1.22 H	180	47.53	-3.30
4	2483.50	29.9 AV	54.0	-24.1	1.22 H	180	33.21	-3.30
5	4960.00	48.1 PK	74.0	-25.9	1.02 H	255	43.57	4.54
6	4960.00	34.9 AV	54.0	-19.1	1.02 H	255	30.32	4.54

ANTENNA POLARITY & TEST DISTANCE: VERTICAL AT 3 M

NO.	FREQ. (MHz)	EMISSION LEVEL (dBuV/m)	LIMIT (dBuV/m)	MARGIN (dB)	ANTENNA HEIGHT (m)	TABLE ANGLE (Degree)	RAW VALUE (dBuV)	CORRECTION FACTOR (dB/m)
1	*2480.00	78.3 PK			1.00 V	211	81.65	-3.31
2	*2480.00	59.6 AV			1.00 V	211	62.87	-3.31
3	2483.50	42.9 PK	74.0	-31.1	1.00 V	211	46.22	-3.30
4	2483.50	28.8 AV	54.0	-25.2	1.00 V	211	32.13	-3.30
5	4960.00	48.1 PK	74.0	-25.9	1.00 V	148	43.53	4.54
6	4960.00	36.1 AV	54.0	-17.9	1.00 V	148	31.53	4.54

REMARKS:

1. Emission Level(dBuV/m) = Raw Value(dBuV) + Correction Factor(dB/m)
2. Correction Factor(dB/m) = Antenna Factor(dB/m) + Cable Factor(dB) – Pre-Amplifier Factor(dB)
3. The other emission levels were very low against the limit.
4. Margin value = Emission Level – Limit value
5. " * ": Fundamental frequency.



A D T

BELOW 1GHz WORST-CASE DATA

CHANNEL	TX Channel 39	DETECTOR FUNCTION	Quasi-Peak (QP)
FREQUENCY RANGE	30MHz ~ 1GHz		
TEST MODE	A		

ANTENNA POLARITY & TEST DISTANCE: HORIZONTAL AT 3 M								
NO.	FREQ. (MHz)	EMISSION LEVEL (dBuV/m)	LIMIT (dBuV/m)	MARGIN (dB)	ANTENNA HEIGHT (m)	TABLE ANGLE (Degree)	RAW VALUE (dBuV)	CORRECTION FACTOR (dB/m)
1	166.58	32.7 QP	43.5	-10.8	1.45 H	214	46.26	-13.55
2	210.86	27.7 QP	43.5	-15.8	1.07 H	345	43.60	-15.91
3	258.68	29.8 QP	46.0	-16.3	1.11 H	214	43.47	-13.72
4	307.52	29.8 QP	46.0	-16.2	1.07 H	5	41.71	-11.95
5	372.36	26.8 QP	46.0	-19.2	1.65 H	54	37.50	-10.74
6	481.39	28.4 QP	46.0	-17.6	1.33 H	331	37.44	-9.02
ANTENNA POLARITY & TEST DISTANCE: VERTICAL AT 3 M								
NO.	FREQ. (MHz)	EMISSION LEVEL (dBuV/m)	LIMIT (dBuV/m)	MARGIN (dB)	ANTENNA HEIGHT (m)	TABLE ANGLE (Degree)	RAW VALUE (dBuV)	CORRECTION FACTOR (dB/m)
1	31.02	27.7 QP	40.0	-12.3	1.17 V	43	43.01	-15.33
2	144.02	31.6 QP	43.5	-11.9	1.09 V	129	45.29	-13.73
3	166.58	31.2 QP	43.5	-12.3	1.05 V	162	44.79	-13.55
4	367.41	30.9 QP	46.0	-15.1	1.37 V	101	41.73	-10.85
5	424.31	27.7 QP	46.0	-18.3	1.16 V	93	37.60	-9.89
6	528.00	27.2 QP	46.0	-18.8	1.21 V	103	35.40	-8.17

REMARKS:

1. Emission Level(dBuV/m) = Raw Value(dBuV) + Correction Factor(dB/m)
2. Correction Factor(dB/m) = Antenna Factor(dB/m) + Cable Factor(dB) – Pre-Amplifier Factor(dB)
3. The other emission levels were very low against the limit.
4. Margin value = Emission Level – Limit value



A D T

CHANNEL	TX Channel 39	DETECTOR FUNCTION	Quasi-Peak (QP)
FREQUENCY RANGE	30MHz ~ 1GHz		
TEST MODE	B		

ANTENNA POLARITY & TEST DISTANCE: HORIZONTAL AT 3 M

NO.	FREQ. (MHz)	EMISSION LEVEL (dBuV/m)	LIMIT (dBuV/m)	MARGIN (dB)	ANTENNA HEIGHT (m)	TABLE ANGLE (Degree)	RAW VALUE (dBuV)	CORRECTION FACTOR (dB/m)
1	50.47	14.4 QP	40.0	-25.6	1.17 H	360	28.00	-13.63
2	110.41	10.6 QP	43.5	-32.9	1.32 H	360	27.44	-16.84
3	170.70	13.5 QP	43.5	-30.0	1.14 H	360	27.20	-13.74
4	293.21	14.6 QP	46.0	-31.4	1.25 H	352	26.88	-12.31
5	405.05	16.5 QP	46.0	-29.6	1.07 H	350	26.88	-10.43
6	540.12	19.2 QP	46.0	-26.8	1.23 H	343	27.25	-8.07

ANTENNA POLARITY & TEST DISTANCE: VERTICAL AT 3 M

NO.	FREQ. (MHz)	EMISSION LEVEL (dBuV/m)	LIMIT (dBuV/m)	MARGIN (dB)	ANTENNA HEIGHT (m)	TABLE ANGLE (Degree)	RAW VALUE (dBuV)	CORRECTION FACTOR (dB/m)
1	50.42	18.8 QP	40.0	-21.2	1.24 V	224	32.39	-13.63
2	103.28	24.1 QP	43.5	-19.4	1.07 V	233	41.75	-17.61
3	131.41	20.3 QP	43.5	-23.2	1.54 V	107	35.05	-14.75
4	245.97	12.0 QP	46.0	-34.0	1.10 V	17	26.13	-14.14
5	331.67	14.1 QP	46.0	-31.9	1.32 V	222	25.49	-11.40
6	414.27	16.6 QP	46.0	-29.4	1.05 V	107	26.79	-10.20

REMARKS:

1. Emission Level(dBuV/m) = Raw Value(dBuV) + Correction Factor(dB/m)
2. Correction Factor(dB/m) = Antenna Factor(dB/m) + Cable Factor(dB) – Pre-Amplifier Factor(dB)
3. The other emission levels were very low against the limit.
4. Margin value = Emission Level – Limit value



4.2 CONDUCTED EMISSION MEASUREMENT

4.2.1 LIMITS OF CONDUCTED EMISSION MEASUREMENT

FREQUENCY OF EMISSION (MHz)	CONDUCTED LIMIT (dBµV)	
	Quasi-peak	Average
0.15 ~ 0.5	66 to 56	56 to 46
0.5 ~ 5	56	46
5 ~ 30	60	50

- NOTE:** 1. The lower limit shall apply at the transition frequencies.
 2. The limit decreases in line with the logarithm of the frequency in the range of 0.15 to 0.50MHz.

4.2.2 TEST INSTRUMENTS

Description & Manufacturer	Model No.	Serial No.	Cal. Date	Cal. Due
ROHDE & SCHWARZ TEST RECEIVER	ESCS 30	834115/016	Apr. 28, 2014	Apr. 27, 2015
ROHDE & SCHWARZ Artificial Mains Network (For EUT)	ESH2-Z5	828075/003	Sep. 06, 2013	Sep. 05, 2014
LISN With Adapter (for EUT)	AD10	C03Ada-001	Sep. 06, 2013	Sep. 05, 2014
EMCO L.I.S.N. (For peripherals)	3825/2	9504-2359	Jul. 23, 2013	Jul. 22, 2014
SCHWARZBECK Artificial Mains Network (For EUT)	NNLK8129	8129229	May 08, 2014	May 07, 2015
Software	ADT_Cond_V7.3.7	NA	NA	NA
RF cable (JYEBAO)	5D-FB	Cable-C03.01	Sep. 26, 2013	Sep. 25, 2014
LYNICS Terminator (For EMCO LISN)	0900510	E1-01-300	Jan. 17, 2014	Jan. 16, 2015
LYNICS Terminator (For EMCO LISN)	0900510	E1-01-301	Jan. 27, 2014	Jan. 26, 2015

- Notes: 1. The calibration interval of the above test instruments is 12 months and the calibrations are traceable to NML/ROC and NIST/USA.
 2. The test was performed in Shielded Room No. 3.
 3. The VCCI Site Registration No. C-274.

4.2.3 TEST PROCEDURES

- a. The EUT was placed 0.4 meters from the conducting wall of the shielded room with EUT being connected to the power mains through a line impedance stabilization network (LISN). Other support units were connected to the power mains through another LISN. The two LISNs provide 50 ohm/ 50uH of coupling impedance for the measuring instrument.
- b. Both lines of the power mains connected to the EUT were checked for maximum conducted interference.
- c. The frequency range from 150kHz to 30MHz was searched. Emission levels under (Limit - 20dB) was not recorded.

NOTE: All modes of operation were investigated and the worst-case emissions are reported.

4.2.4 DEVIATION FROM TEST STANDARD

No deviation.

4.2.5 TEST SETUP

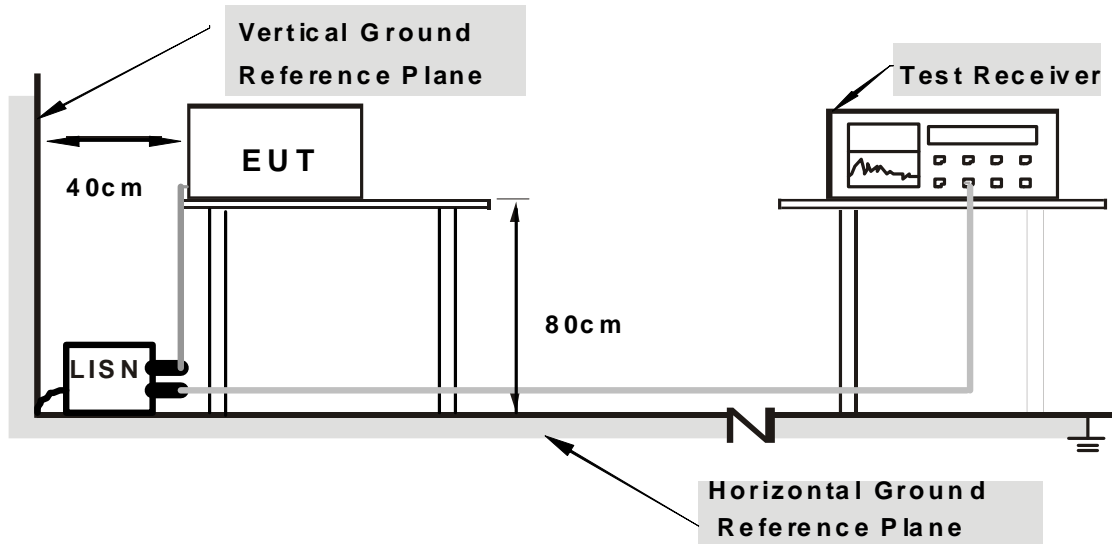

Note: Support units were connected to second LISN.

For the actual test configuration, please refer to the attached file (Test Setup Photo).

4.2.6 EUT OPERATING CONDITIONS

For Mode A

- Turn on the power of all equipment.
- Notebook ran a test program (provided by manufacture) to enable EUT under transmitting condition at specific channel continuously.
- Set the EUT under transmitting and charging condition.

4.2.7 TEST RESULTS

CONDUCTED WORST-CASE DATA

PHASE	Line 1	6dB BANDWIDTH	9kHz
CHANNEL	39	TEST MODE	A

No	Freq. [MHz]	Corr. Factor (dB)	Reading Value [dB (uV)]		Emission Level [dB (uV)]		Limit [dB (uV)]		Margin (dB)	
			Q.P.	AV.	Q.P.	AV.	Q.P.	AV.	Q.P.	AV.
			1	0.15000	0.24	48.25	26.37	48.49	26.61	66.00
2	0.16562	0.25	51.82	30.99	52.07	31.24	65.18	55.18	-13.11	-23.94
3	0.52109	0.29	38.81	21.11	39.10	21.40	56.00	46.00	-16.90	-24.60
4	0.66563	0.29	38.22	24.58	38.51	24.87	56.00	46.00	-17.49	-21.13
5	2.73438	0.42	28.85	19.82	29.27	20.24	56.00	46.00	-26.73	-25.76
6	18.02734	0.64	33.11	25.86	33.75	26.50	60.00	50.00	-26.25	-23.50

REMARKS:

1. Q.P. and AV. are abbreviations of quasi-peak and average individually.
2. The emission levels of other frequencies were very low against the limit.
3. Margin value = Emission Level – Limit value
4. Correction Factor = Insertion loss + Cable loss
5. Emission Level = Correction Factor + Reading Value

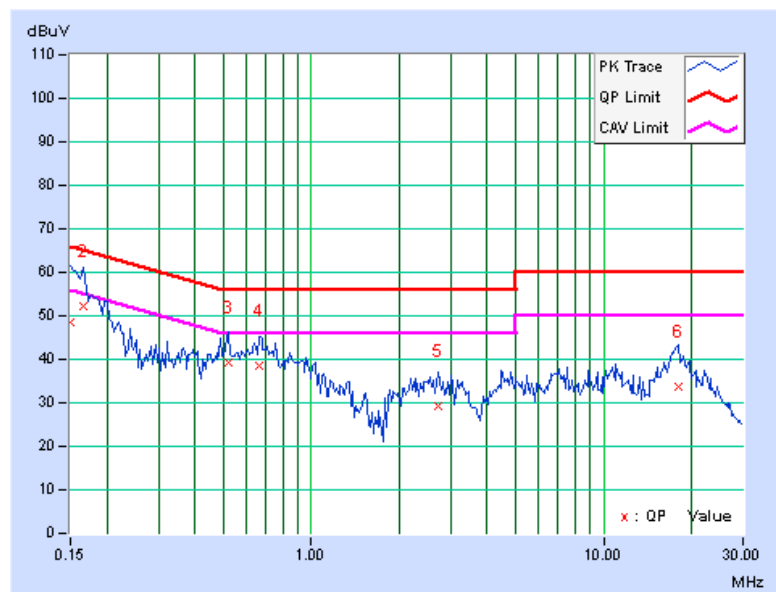



A D T

PHASE	Line 2	6dB BANDWIDTH	9kHz
CHANNEL	39	TEST MODE	A

No	Freq. [MHz]	Corr. Factor (dB)	Reading Value [dB (uV)]		Emission Level [dB (uV)]		Limit [dB (uV)]		Margin (dB)	
			Q.P.	AV.	Q.P.	AV.	Q.P.	AV.	Q.P.	AV.
			1	0.15000	0.30	43.57	25.65	43.87	25.95	66.00
2	0.16562	0.31	49.07	28.95	49.38	29.26	65.18	55.18	-15.80	-25.92
3	0.51719	0.37	40.64	23.14	41.01	23.51	56.00	46.00	-14.99	-22.49
4	0.86875	0.39	35.97	23.16	36.36	23.55	56.00	46.00	-19.64	-22.45
5	2.34375	0.54	30.76	20.80	31.30	21.34	56.00	46.00	-24.70	-24.66
6	19.79297	0.66	31.05	23.86	31.71	24.52	60.00	50.00	-28.29	-25.48

REMARKS:

1. Q.P. and AV. are abbreviations of quasi-peak and average individually.
2. The emission levels of other frequencies were very low against the limit.
3. Margin value = Emission Level – Limit value
4. Correction Factor = Insertion loss + Cable loss
5. Emission Level = Correction Factor + Reading Value

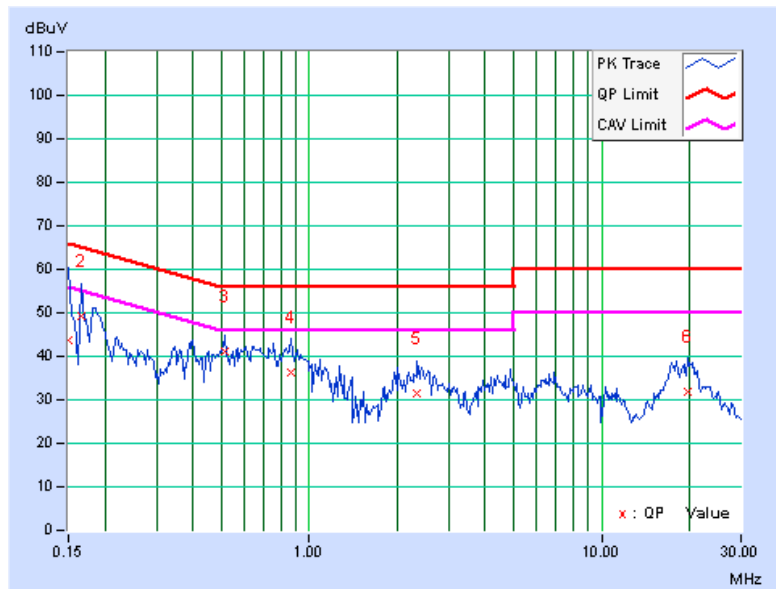

4.3 6dB BANDWIDTH MEASUREMENT

4.3.1 LIMITS OF 6dB BANDWIDTH MEASUREMENT

The minimum of 6dB Bandwidth Measurement is 0.5 MHz.

4.3.2 TEST SETUP

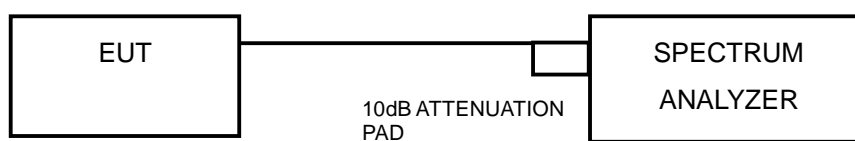

4.3.3 TEST INSTRUMENTS

Refer to section 4.1.2 to get information of above instrument.

4.3.4 TEST PROCEDURE

- Set resolution bandwidth (RBW) = 100kHz
- Set the video bandwidth (VBW) $\geq 3 \times$ RBW, Detector = Peak.
- Trace mode = max hold.
- Sweep = auto couple.
- Measure the maximum width of the emission that is constrained by the frequencies associated with the two amplitude points (upper and lower) that are attenuated by 6 dB relative to the maximum level measured in the fundamental emission

4.3.5 DEVIATION FROM TEST STANDARD

No deviation.

4.3.6 EUT OPERATING CONDITIONS

The software provided by client to enable the EUT under transmission condition continuously at lowest, middle and highest channel frequencies individually.



A D T

4.3.7 TEST RESULTS

MODE A

CHANNEL	CHANNEL FREQUENCY (MHz)	6dB BANDWIDTH (MHz)	MINIMUM LIMIT (MHz)	PASS / FAIL
0	2402	0.70	0.5	PASS
19	2440	0.69	0.5	PASS
39	2480	0.69	0.5	PASS

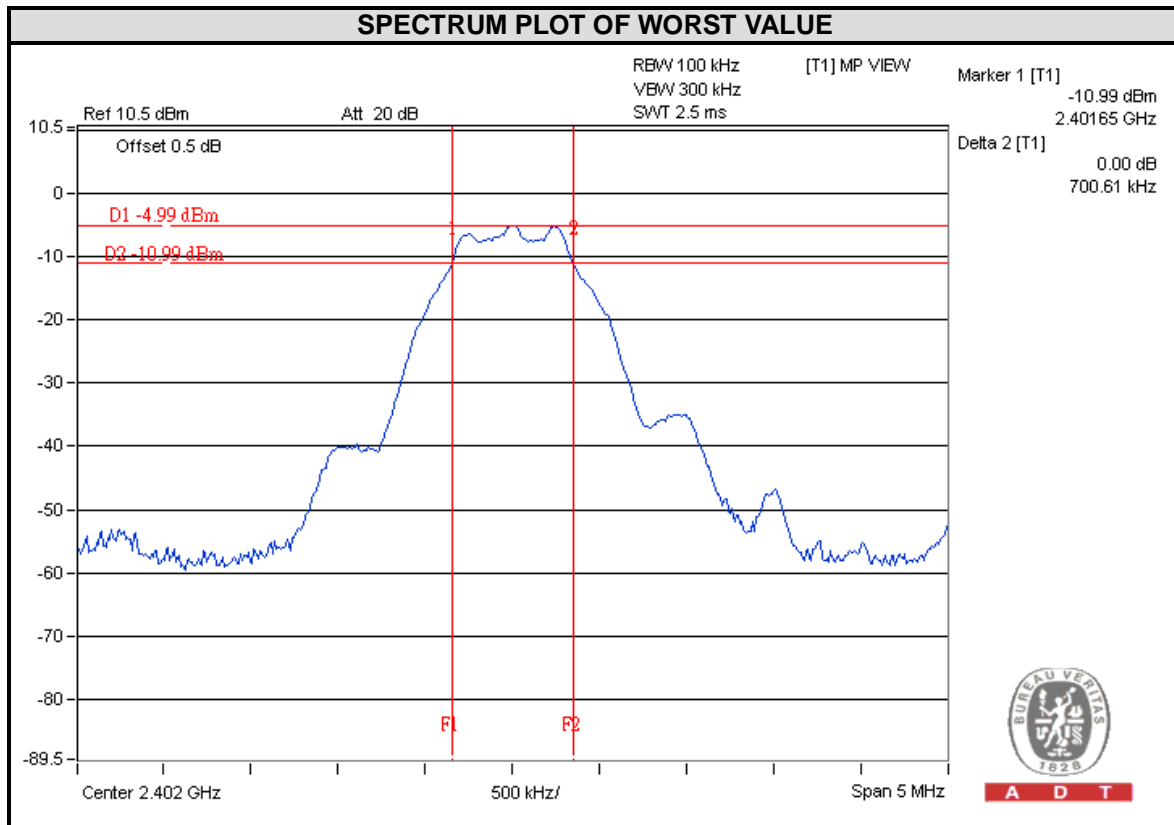

A D T

4.4 CONDUCTED OUTPUT POWER

4.4.1 LIMITS OF CONDUCTED OUTPUT POWER MEASUREMENT

For systems using digital modulation in the 2400–2483.5 MHz bands: 1 Watt (30dBm)

4.4.2 TEST SETUP

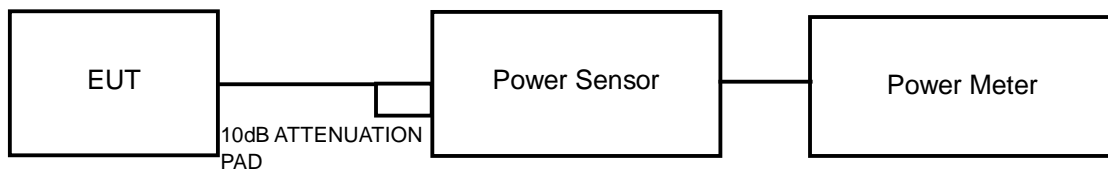

4.4.3 TEST INSTRUMENTS

Refer to section 4.1.2 to get information of above instrument.

4.4.4 TEST PROCEDURES

A peak / average power sensor were used on the output port of the EUT. A power meter was used to read the response of the peak / average power sensor. Record the power level.

4.4.5 DEVIATION FROM TEST STANDARD

No deviation.

4.4.6 EUT OPERATING CONDITIONS

Same as Item 4.3.6.



A D T

4.4.7 TEST RESULTS

MODE A

FOR PEAK POWER

CHANNEL	FREQUENCY (MHz)	PEAK POWER (dBm)	PEAK POWER (mW)	LIMIT (dBm)	PASS/FAIL
0	2402	-2.21	0.6	30	PASS
19	2440	-1.02	0.8	30	PASS
39	2480	-0.11	1.0	30	PASS

FOR AVERAGE POWER

CHANNEL	FREQUENCY (MHz)	AVERAGE POWER (dBm)
0	2402	-2.94
19	2440	-1.65
39	2480	-0.72

4.5 POWER SPECTRAL DENSITY MEASUREMENT

4.5.1 LIMITS OF POWER SPECTRAL DENSITY MEASUREMENT

The Maximum of Power Spectral Density Measurement is 8dBm.

4.5.2 TEST SETUP

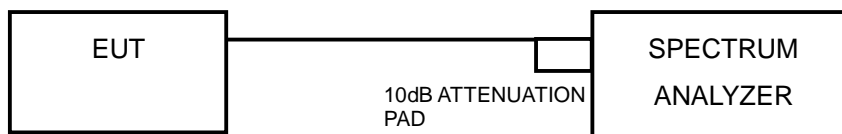

4.5.3 TEST INSTRUMENTS

Refer to section 4.1.2 to get information of above instrument.

4.5.4 TEST PROCEDURE

- Set the RBW = 3 kHz, VBW = 10 kHz, Detector = peak.
- Sweep time = auto couple, Trace mode = max hold, allow trace to fully stabilize.
- Use the peak marker function to determine the maximum power level in any 100 kHz band segment within the fundamental EBW.

4.5.5 DEVIATION FROM TEST STANDARD

No deviation.

4.5.6 EUT OPERATING CONDITION

Same as Item 4.3.6



A D T

4.5.7 TEST RESULTS

MODE A

Channel	FREQ. (MHz)	PSD (dBm/3kHz)	Limit (dBm/3kHz)	PASS /FAIL
0	2402	-20.51	8	PASS
19	2440	-19.40	8	PASS
39	2480	-18.41	8	PASS

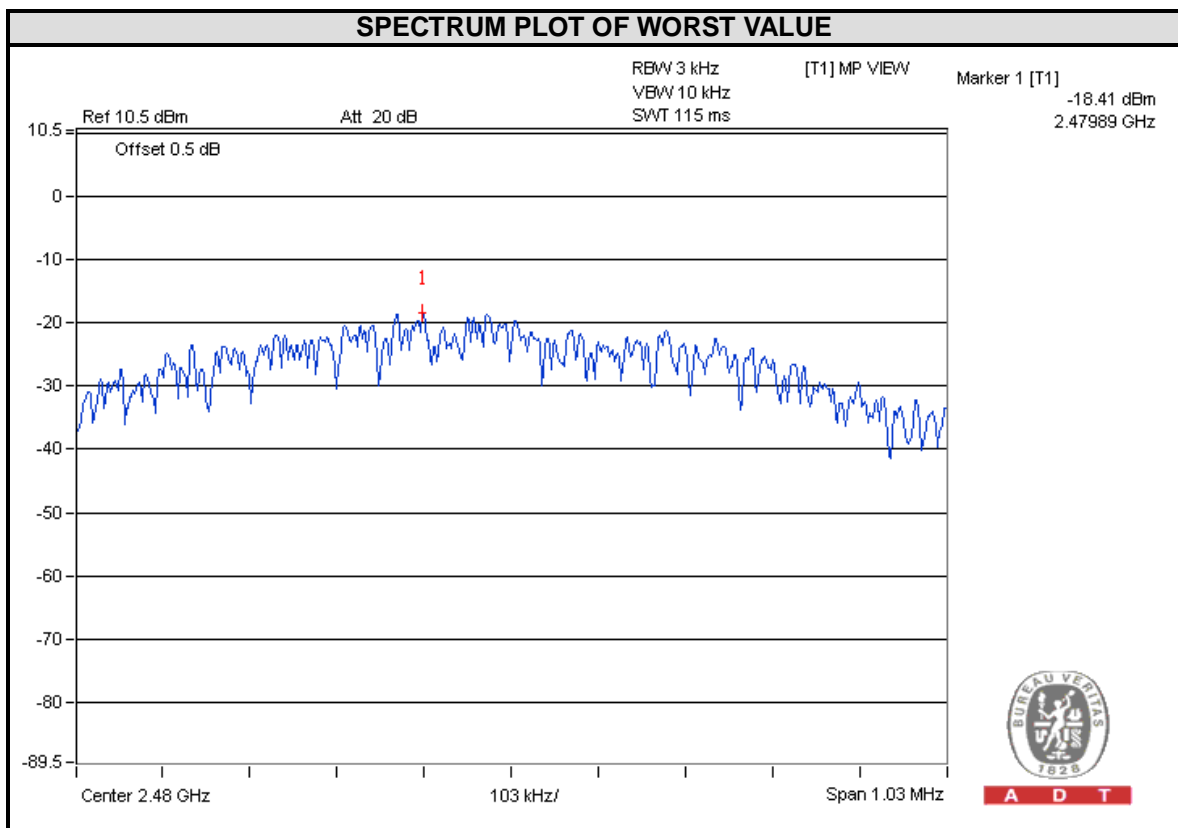

4.6 CONDUCTED OUT OF BAND EMISSION MEASUREMENT

4.6.1 LIMITS OF CONDUCTED OUT OF BAND EMISSION MEASUREMENT

Below -20dB of the highest emission level of operating band (in 100kHz Resolution Bandwidth).

4.6.2 TEST SETUP

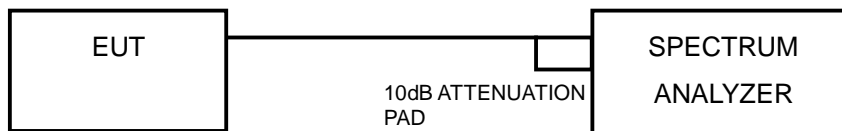

4.6.3 TEST INSTRUMENTS

Refer to section 4.1.2 to get information of above instrument.

4.6.4 TEST PROCEDURE

MEASUREMENT PROCEDURE REF

1. Set the RBW = 100 kHz.
2. Set the VBW \geq 300 kHz.
3. Detector = peak.
4. Sweep time = auto couple.
5. Trace mode = max hold.
6. Allow trace to fully stabilize.
7. Use the peak marker function to determine the maximum power level in any 100 kHz band segment within the fundamental EBW.

MEASUREMENT PROCEDURE OOB

1. Set RBW = 100 kHz.
2. Set VBW \geq 300 kHz.
3. Detector = peak.
4. Sweep = auto couple.
5. Trace Mode = max hold.
6. Allow trace to fully stabilize.
7. Use the peak marker function to determine the maximum amplitude level.

4.6.5 DEVIATION FROM TEST STANDARD

No deviation.

4.6.6 EUT OPERATING CONDITION

Same as Item 4.3.6

4.6.7 TEST RESULTS

The spectrum plots are attached on the following pages. D1 line indicates the highest level, and D2 line indicates the 20dB offset below D1. It shows compliance with the requirement.



A D T

MODE A

CH 0

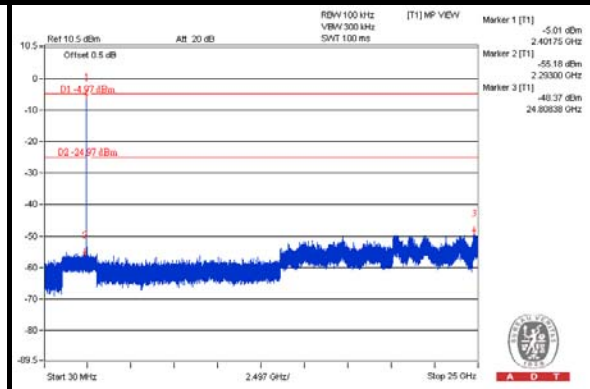
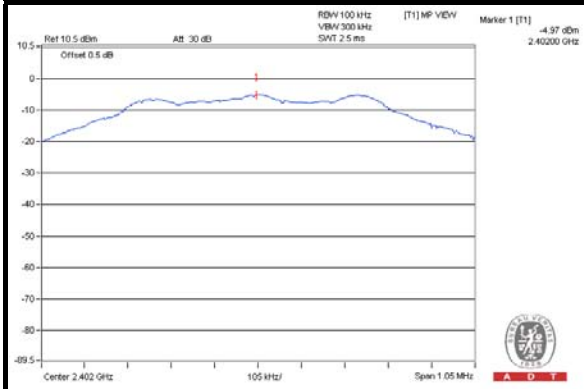

CH 19

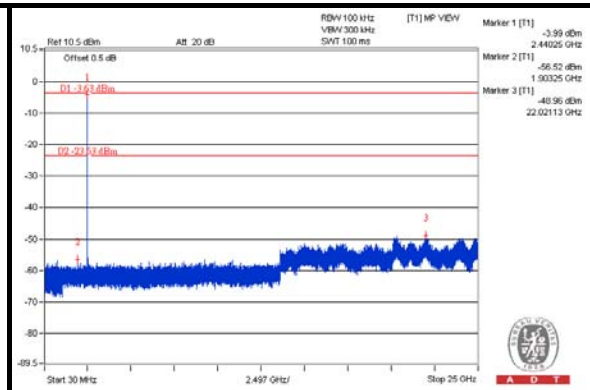
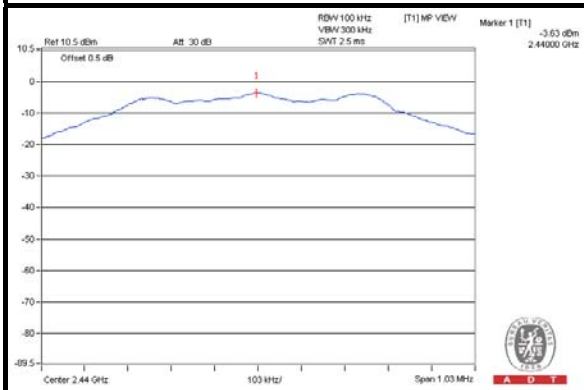

CH 39

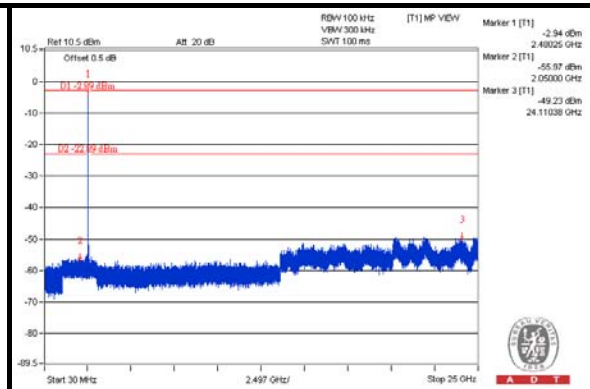
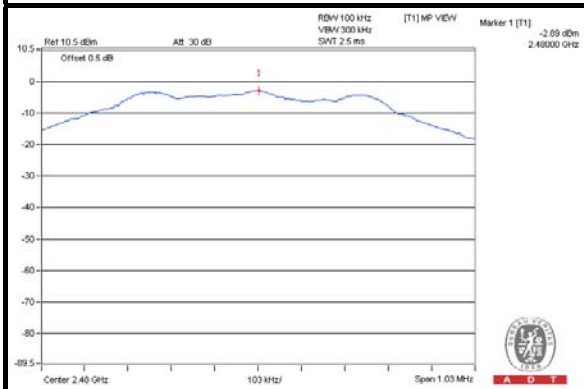

CH 0 Band edge

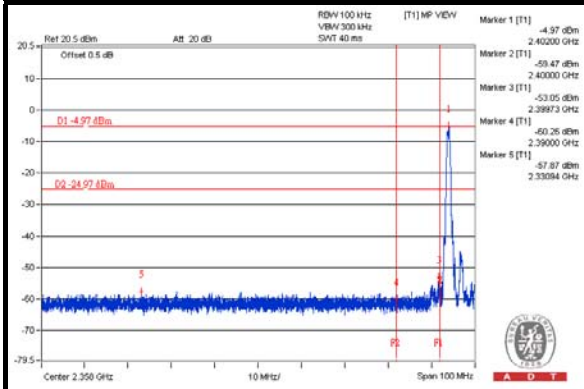

CH 39 Band edge

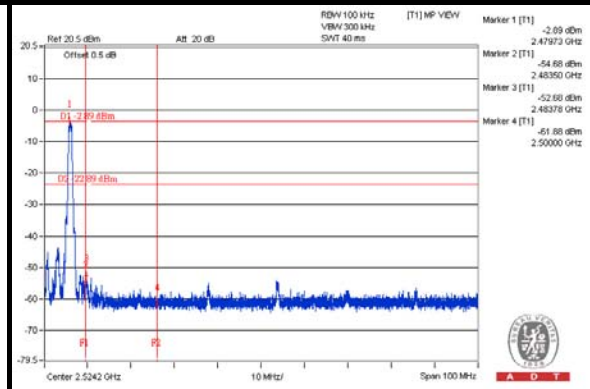



A D T

5. PHOTOGRAPHS OF THE TEST CONFIGURATION

Please refer to the attached file (Test Setup Photo).



6. INFORMATION ON THE TESTING LABORATORIES

We, Bureau Veritas Consumer Products Services (H.K.) Ltd., Taoyuan Branch, were founded in 1988 to provide our best service in EMC, Radio, Telecom and Safety consultation. Our laboratories are accredited and approved according to ISO/IEC 17025.

If you have any comments, please feel free to contact us at the following:

Linko EMC/RF Lab:

Tel: 886-2-26052180

Fax: 886-2-26051924

Hsin Chu EMC/RF Lab:

Tel: 886-3-5935343

Fax: 886-3-5935342

Hwa Ya EMC/RF/Safety/Telecom Lab:

Tel: 886-3-3183232

Fax: 886-3-3270892

Email: service.adt@tw.bureauveritas.com

Web Site: www.bureauveritas-adt.com

The address and road map of all our labs can be found in our web site also.

7. APPENDIX A - MODIFICATIONS RECORDERS FOR ENGINEERING CHANGES TO THE EUT BY THE LAB

No modifications were made to the EUT by the lab during the test.

--- END ---