

Partial FCC Test Report

Report No.: RFBEDW-WTW-P21010530-1

FCC ID: O57AX200NGW

Test Model: AX200NGW

Received Date: Jan. 19, 2021

Test Date: Jan. 23, 2021 ~ Feb. 26, 2021

Issued Date: Mar. 08, 2021

Applicant: Lenovo(Shanghai) Electronics Technology Co., Ltd.

Address: Section 304-305, Building No.4, #222, Meiyue Road, China(Shanghai) Pilot Free Trade Zone ,Shanghai 200131 , China (Peoples Republic Of)

Issued By: Bureau Veritas Consumer Products Services (H.K.) Ltd., Taoyuan Branch
Lin Kou Laboratories

Lab Address: No. 47-2, 14th Ling, Chia Pau Vil., Lin Kou Dist., New Taipei City, Taiwan

Test Location: No.19, Hwa Ya 2nd Rd., Wen Hwa Vil., Kwei Shan Dist., Taoyuan City
33383, Taiwan

**FCC Registration /
Designation Number:** 788550 / TW0003



This report is for your exclusive use. Any copying or replication of this report to or for any other person or entity, or use of our name or trademark, is permitted only with our prior written permission. This report sets forth our findings solely with respect to the test samples identified herein. The results set forth in this report are not indicative or representative of the quality or characteristics of the lot from which a test sample was taken or any similar or identical product unless specifically and expressly noted. Our report includes all of the tests requested by you and the results thereof based upon the information that you provided to us. You have 60 days from date of issuance of this report to notify us of any material error or omission caused by our negligence, provided, however, that such notice shall be in writing and shall specifically address the issue you wish to raise. A failure to raise such issue within the prescribed time shall constitute your unqualified acceptance of the completeness of this report, the tests conducted and the correctness of the report contents. Unless specific mention, the uncertainty of measurement has been explicitly taken into account to declare the compliance or non-compliance to the specification.

Table of Contents

Release Control Record	3
1 Certificate of Conformity	4
2 Summary of Test Results.....	5
2.1 Measurement Uncertainty.....	5
2.2 Modification Record	6
3 General Information	7
3.1 General Description of EUT	7
3.2 Description of Test Modes.....	9
3.2.1 Test Mode Applicability and Tested Channel Detail.....	10
3.3 Duty Cycle of Test Signal	13
3.4 Description of Support Units	14
3.4.1 Configuration of System under Test	14
3.5 General Description of Applied Standards and References	14
4 Test Types and Results	15
4.1 Radiated Emission and Bandedge Measurement	15
4.1.1 Limits of Radiated Emission and Bandedge Measurement	15
4.1.2 Test Instruments	16
4.1.3 Test Procedures.....	17
4.1.4 Deviation from Test Standard	17
4.1.5 Test Set Up	18
4.1.6 EUT Operating Conditions.....	19
4.1.7 Test Results	20
4.2 Conducted Emission Measurement.....	28
4.2.1 Limits of Conducted Emission Measurement	28
4.2.2 Test Instruments	28
4.2.3 Test Procedures.....	28
4.2.4 Deviation from Test Standard	29
4.2.5 Test Setup.....	29
4.2.6 EUT Operating Conditions.....	29
4.2.7 Test Results	30
4.3 Conducted Output Power Measurement	32
4.3.1 Limits of Conducted Output Power Measurement.....	32
4.3.2 Test Setup.....	32
4.3.3 Test Instruments	32
4.3.4 Test Procedures.....	32
4.3.5 Deviation from Test Standard	32
4.3.6 EUT Operating Conditions.....	32
4.3.7 Test Results	33
5 Pictures of Test Arrangements.....	34
Annex A- Band Edge Measurement	35
Appendix – Information of the Testing Laboratories	37

Release Control Record

Issue No.	Description	Date Issued
RFBEDW-WTW-P21010530-1	Original Release	Mar. 08, 2021

2 Summary of Test Results

47 CFR FCC Part 15, Subpart C (Section 15.247)			
FCC Clause	Test Item	Result	Remarks
15.207	AC Power Conducted Emission	Pass	Meet the requirement of limit. Minimum passing margin is -11.61 dB at 0.55800 MHz.
15.205 & 209	Radiated Emissions	Pass	Meet the requirement of limit. Minimum passing margin is -1.0 dB at 335.06 MHz.
15.247(d)	Band Edge Measurement	N/A	Refer to Note
15.247(d)	Antenna Port Emission	N/A	Refer to Note
15.247(a)(2)	6 dB Bandwidth	N/A	Refer to Note
---	Occupied Bandwidth Measurement	N/A	Refer to Note
15.247(b)	Conducted Power	Pass	Meet the requirement of limit.
15.247(e)	Power Spectral Density	N/A	Refer to Note
15.203	Antenna Requirement	Pass	Antenna connector is Kangshuo MHF-B13-N-01 not a standard connector.

Note:

1. This report is a partial report, only test item of AC Power Conducted Emission, Radiated Emissions and Maximum Peak Output Power were performed for this report. Other testing data please refer to Intel report no.: 181210-03.TR04 for module (Brand: Intel® Wi-Fi 6 AX200 , Model: AX200NGW).
2. For 2.4G band compliance with rule 15.247(d) of the band-edge items, the test plots were recorded in Annex A. Test Procedures refer to report 4.1.3.
3. Determining compliance based on the results of the compliance measurement, not taking into account measurement instrumentation uncertainty.

2.1 Measurement Uncertainty

Where relevant, the following measurement uncertainty levels have been estimated for tests performed on the EUT as specified in CISPR 16-4-2:

Measurement	Frequency	Expanded Uncertainty (k=2) (\pm)
Conducted Emissions at mains ports	150 kHz ~ 30 MHz	2.79 dB
Radiated Emissions up to 1 GHz	9 kHz ~ 30 MHz	3.04 dB
	30 MHz ~ 200 MHz	2.93 dB
Radiated Emissions above 1 GHz	200 MHz ~ 1000 MHz	2.95 dB
	1 GHz ~ 18 GHz	2.26 dB
	18 GHz ~ 40 GHz	1.94 dB

2.2 Modification Record

There were no modifications required for compliance.

3 General Information

3.1 General Description of EUT

Product	WLAN and BT , 2x2 Pcle M.2 2230 adapter card
Brand	Intel® Wi-Fi 6 AX200
Test Model	AX200NGW
Status of EUT	Engineering Sample
Power Supply Rating	3.3Vdc form host equipment
Modulation Type	GFSK
Transfer Rate	LE 4.0: 1 Mbps LE 5.0: 2 Mbps
Operating Frequency	2402 ~ 2480 MHz
Number of Channel	40
Output Power	LE 4.0: 4.97 mW LE 5.0: 4.91 mW
Antenna Type	Refer to Note
Antenna Connector	Refer to Note
Accessory Device	N/A
Data Cable Supplied	N/A

Note:

1. The EUT is authorized for use in specific End-product. Please refer to below table for more details.

Product	Brand	Model
Notebook Computer	Lenovo	Lenovo 300e Chromebook Gen 3*****

Note: *=0~9,A-Z,a~z,"-" or blank, for marketing use only, with no impact on RF compliance of the product.

2. The EUT contains following accessory devices.

Product	Brand	Model	Description
Adapter 1	Lenovo	ADLX45YLC2D	I/P: 100-240Vac, 50-60Hz, 1.8A O/P: 20.0V===2.25A, 45.0W 1.75M / 0core
Adapter 2	Lenovo	ADLX65YCC3D	I/P: 100-240Vac, 50-60Hz, 1.8A O/P: 20.0V===3.25A, 65.0W 1.77M / 0core
Adapter 3	Lenovo	ADLX65NLC3A	I/P: 100-240Vac, 50-60Hz, 1.8A O/P: 20.0V ===3.25A 1.55M / 1core
Battery	Lenovo	L20M3PG0	11.52 Vdc, 3994 mAh, 46Wh

*After pretesting, the adapter 2 was the worst case and chose for final test.

3. The antenna information is listed as below.

Ant. Type	Brand	Model	Ant.	Antenna Peak Gain (dBi)				
				BT	2400-2500MHz	5150-5350MHz	5470-5725MHz	5725-5850MHz
PIFA	High-Tek Electronics Co., Ltd	0ACCN020019N (DC33002JM00)	Main	-	-0.7	-0.81	-1.5	-1.63
		0ACCN020020N (DC33002JM10)	Aux.	-2.65	-2.65	-0.40	-1.44	-1.44
	Shenzhen South Star Technology Ltd	N12-7471-R0A (DC33002J000)	Main	-	0.90	-0.87	-0.14	-0.96
		N12-7472-R0A (DC33002J010)	Aux.	-1.87	-1.87	1.03	-0.19	-2.21

* The Max antenna gain was chosen for final test.

4. The above Antenna information is declared by manufacturer and for more detailed features description, please refer to the manufacturer's specifications, the laboratory shall not be held responsible.
5. The above EUT information is declared by manufacturer and for more detailed features description, please refers to the manufacturer's specifications or user's manual.

3.2 Description of Test Modes

40 channels are provided to this EUT:

Channel	Freq. (MHz)	Channel	Freq. (MHz)	Channel	Freq. (MHz)	Channel	Freq. (MHz)
0	2402	10	2422	20	2442	30	2462
1	2404	11	2424	21	2444	31	2464
2	2406	12	2426	22	2446	32	2466
3	2408	13	2428	23	2448	33	2468
4	2410	14	2430	24	2450	34	2470
5	2412	15	2432	25	2452	35	2472
6	2414	16	2434	26	2454	36	2474
7	2416	17	2436	27	2456	37	2476
8	2418	18	2438	28	2458	38	2478
9	2420	19	2440	29	2460	39	2480

3.2.1 Test Mode Applicability and Tested Channel Detail

<LE 4.0>

EUT Configure Mode	Applicable To				Description
	RE≥1G	RE<1G	PLC	Power	
-	√	-	-	√	-

Where **RE≥1G**: Radiated Emission above 1 GHz **RE<1G**: Radiated Emission below 1 GHz
PLC: Power Line Conducted Emission **Power**: Maximum Output Power Measurement

Note: For radiated emission (below 1GHz) and Power Line Conducted Emission test items, the worst radiated emission mode was selected

Note: “-” means no effect.

Note: The EUT had been pre-tested on the positioned of NB Mode and each 3 axis of Tablet Mode. The worst case was found when positioned on NB Mode.

Radiated Emission Test (Above 1 GHz):

- Pre-Scan has been conducted to determine the worst-case mode from all possible combinations between available modulations, data rates and antenna ports (if EUT with antenna diversity architecture).
- Following channel(s) was (were) selected for the final test as listed below.

EUT Configure Mode	Available Channel	Tested Channel	Modulation Type	Data Rate (Mbps)
-	0 to 39	0, 19, 39	GFSK	1

Maximum Output Power Measurement:

- This item includes all test value of each mode, but only includes spectrum plot of worst value of each mode.
- Pre-Scan has been conducted to determine the worst-case mode from all possible combinations between available modulations, data rates and antenna ports (if EUT with antenna diversity architecture).
- Following channel(s) was (were) selected for the final test as listed below.

EUT Configure Mode	Available Channel	Tested Channel	Modulation Type	Data Rate (Mbps)
-	0 to 39	0, 19, 39	GFSK	1

<LE 5.0>

EUT Configure Mode	Applicable To				Description
	RE≥1G	RE<1G	PLC	Power	
-	√	√	√	√	-

Where **RE≥1G**: Radiated Emission above 1 GHz **RE<1G**: Radiated Emission below 1 GHz
PLC: Power Line Conducted Emission **Power**: Maximum Output Power Measurement

Note: “-” means no effect.

Note: For radiated emission (below 1GHz) and power line conducted emission test items, the worst radiated emission mode was selected chosen the worst maximum fundamental emission level channel.

Note: The EUT had been pre-tested on the positioned of NB Mode and each 3 axis of Tablet Mode. The worst case was found when positioned on NB Mode.

Radiated Emission Test (Above 1 GHz):

- Pre-Scan has been conducted to determine the worst-case mode from all possible combinations between available modulations, data rates and antenna ports (if EUT with antenna diversity architecture).
- Following channel(s) was (were) selected for the final test as listed below.

EUT Configure Mode	Available Channel	Tested Channel	Modulation Type	Data Rate (Mbps)
A	0 to 39	0, 19, 39	GFSK	2

Radiated Emission Test (Below 1 GHz):

- Pre-Scan has been conducted to determine the worst-case mode from all possible combinations between available modulations, data rates and antenna ports (if EUT with antenna diversity architecture).
- Following channel(s) was (were) selected for the final test as listed below.

EUT Configure Mode	Available Channel	Tested Channel	Modulation Type	Data Rate (Mbps)
A	0 to 39	39	GFSK	2

Power Line Conducted Emission Test:

- Pre-Scan has been conducted to determine the worst-case mode from all possible combinations between available modulations, data rates and antenna ports (if EUT with antenna diversity architecture).
- Following channel(s) was (were) selected for the final test as listed below.

EUT Configure Mode	Available Channel	Tested Channel	Modulation Type	Data Rate (Mbps)
A, B	0 to 39	39	GFSK	2

Maximum Output Power Measurement:

- This item includes all test value of each mode, but only includes spectrum plot of worst value of each mode.
- Pre-Scan has been conducted to determine the worst-case mode from all possible combinations between available modulations, data rates and antenna ports (if EUT with antenna diversity architecture).
- Following channel(s) was (were) selected for the final test as listed below.

EUT Configure Mode	Available Channel	Tested Channel	Modulation Type	Data Rate (Mbps)
A	0 to 39	0, 19, 39	GFSK	2

Test Condition:

Applicable To	Environmental Conditions	Input Power	Tested by
RE \geq 1G	25 deg. C, 65 % RH	120 Vac, 60 Hz	Edison Lee
RE<1G	25 deg. C, 65 % RH	120 Vac, 60 Hz	Titan Hsu
PLC	25 deg. C, 65 % RH	120 Vac, 60 Hz	Titan Hsu
APCM	25 deg. C, 65 % RH	120 Vac, 60 Hz	Tim Chen

3.3 Duty Cycle of Test Signal

Duty cycle of test signal is < 98 %, duty factor shall be considered.

<LE 4.0>

Duty cycle = $0.388/0.626 = 0.620$, Duty factor = $10 * \log(1/0.62) = 2.08$

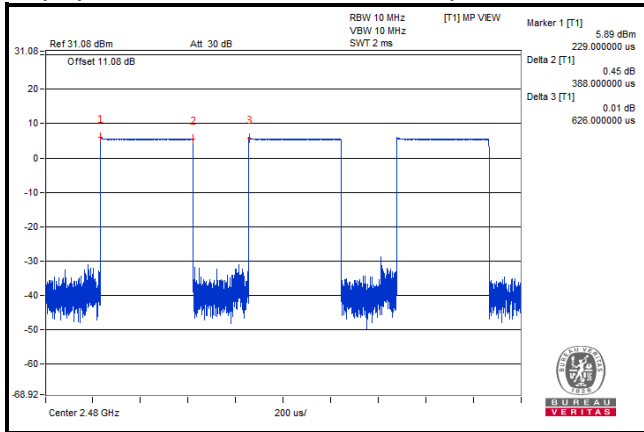

<LE 5.0>

Duty cycle = $0.204/0.626 = 0.326$, Duty factor = $10 * \log(1/0.326) = 4.87$

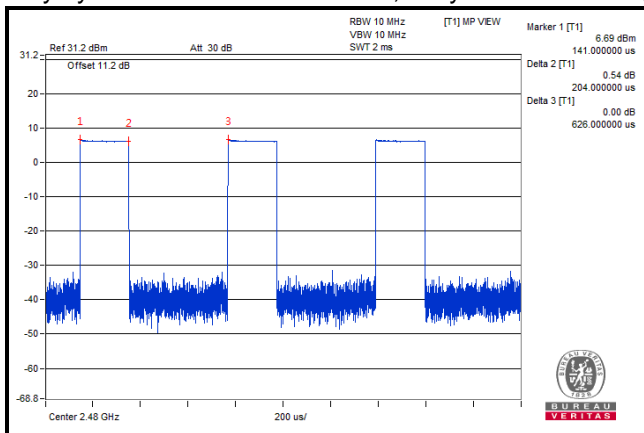

3.4 Description of Support Units

The EUT has been tested as an independent unit together with other necessary accessories or support units. The following support units or accessories were used to form a representative test configuration during the tests.

ID	Product	Brand	Model No.	Serial No.	FCC ID	Remarks
A	Notebook Computer	Lenovo	Lenovo 300e Chromebook Gen3*****	NA	NA	-
B	Adapter	Lenovo	ADLX65YCC3D	NA	NA	-
C	Flash	HP	v250W	05	NA	-
D	Flash	HP	v250W	03	NA	-
E	Monitor	ViewSonic	VX2457-MHD	UG0182942333	NA	-

No.	Signal Cable Description Of The Above Support Units
1.	HDMI Cable: 1m

Note:

1. All power cords of the above support units are non-shielded (1.8m).
2. Items A, C, D acted as communication partners to transfer data.

3.4.1 Configuration of System under Test

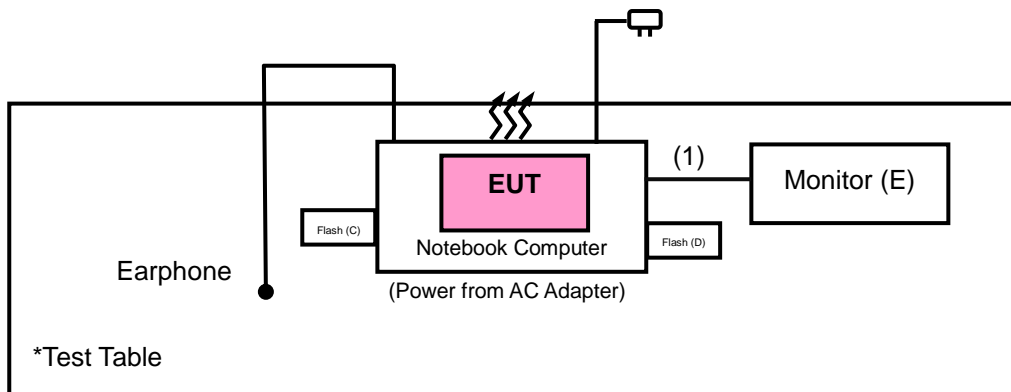

3.5 General Description of Applied Standards and References

The EUT is a RF Product. According to the specifications of the manufacturer, it must comply with the requirements of the following standards and references:

Test Standard:

FCC Part 15, Subpart C (15.247)

ANSI C63.10-2013

All test items have been performed and recorded as per the above standards.

References Test Guidance:

KDB 558074 D01 15.247 Meas Guidance v05r02

All test items have been performed as a reference to the above KDB test guidance.

4 Test Types and Results

4.1 Radiated Emission and Bandedge Measurement

4.1.1 Limits of Radiated Emission and Bandedge Measurement

Radiated emissions which fall in the restricted bands must comply with the radiated emission limits specified as below table. Other emissions shall be at least 20 dB below the highest level of the desired power:

Frequencies (MHz)	Field Strength (microvolts/meter)	Measurement Distance (meters)
0.009 ~ 0.490	2400/F (kHz)	300
0.490 ~ 1.705	24000/F (kHz)	30
1.705 ~ 30.0	30	30
30 ~ 88	100	3
88 ~ 216	150	3
216 ~ 960	200	3
Above 960	500	3

Note:

1. The lower limit shall apply at the transition frequencies.
2. Emission level (dBuV/m) = 20 log Emission level (uV/m).
3. For frequencies above 1000 MHz, the field strength limits are based on average detector, however, the peak field strength of any emission shall not exceed the maximum permitted average limits, specified above by more than 20 dB under any condition of modulation.

4.1.2 Test Instruments

Description & Manufacturer	Model No.	Serial No.	Date of Calibration	Due Date of Calibration
Test Receiver ROHDE & SCHWARZ	ESR3	102579	Jul. 07, 2020	Jul. 06, 2021
Spectrum Analyzer ROHDE & SCHWARZ	FSP40	100269	Jun. 09, 2020	Jun. 08, 2021
BILOG Antenna SCHWARZBECK	VULB9168	9168-171	Nov. 04, 2020	Nov. 03, 2021
HORN Antenna SCHWARZBECK	9120D	209	Nov. 22, 2020	Nov. 21, 2021
HORN Antenna SCHWARZBECK	BBHA 9170	BBHA9170241	Nov. 22, 2020	Nov. 21, 2021
Loop Antenna EMCI	EM-6879	269	Sep. 17, 2020	Sep. 16, 2021
Preamplifier Agilent (Below 1GHz)	8447D	2944A10738	Aug. 16, 2020	Aug. 15, 2021
Preamplifier Agilent (Above 1GHz)	8449B	3008A02465	Mar. 23, 2020	Mar. 22, 2021
RF Coaxial Cable WOKEN With 5dB PAD	8D-FB	Cable-CH3-01	Aug. 16, 2020	Aug. 15, 2021
RF signal cable HUBER+SUHNER	SUCOFLEX 104	Cable-CH3-03 (223653/4)	Aug. 16, 2020	Aug. 15, 2021
RF signal cable HUBER+SUHNER& EMCI	SUCOFLEX 104&EMC104-SM- SM-8000	Cable-CH3-03 (309224+170907)	Aug. 16, 2020	Aug. 15, 2021
Software BV ADT	ADT_Radiated_ V7.6.15.9.5	NA	NA	NA
Antenna Tower inn-co GmbH	MA 4000	013303	NA	NA
Antenna Tower Controller BV ADT	AT100	AT93021702	NA	NA
Turn Table BV ADT	TT100	TT93021702	NA	NA
Turn Table Controller BV ADT	SC100	SC93021702	NA	NA
Boresight Antenna Fixture	FBA-01	FBA-SIP01	NA	NA
USB Wideband Power Sensor KEYSIGHT	U2021XA	MY55050005/MY55 190004/MY551900 07/MY55210005	Jul. 13, 2020	Jul. 12, 2021

Note: 1. The calibration interval of the above test instruments is 12 months and the calibrations are traceable to NML/ROC and NIST/USA.
 2. The test was performed in HwaYa Chamber 3.

4.1.3 Test Procedures

For Radiated Emission below 30 MHz

- a. The EUT was placed on the top of a rotating table 0.8 meters above the ground at a 3 meter chamber room. The table was rotated 360 degrees to determine the position of the highest radiation.
- b. The EUT was set 3 meters away from the interference-receiving antenna, which was mounted on the top of a variable-height antenna tower.
- c. Parallel, perpendicular, and ground-parallel orientations of the antenna are set to make the measurement.
- d. For each suspected emission, the EUT was arranged to its worst case and the rotatable table was turned from 0 degrees to 360 degrees to find the maximum reading.
- e. The test-receiver system was set to Quasi-Peak Detect Function and Specified Bandwidth with Maximum Hold Mode.

Note:

1. The resolution bandwidth and video bandwidth of test receiver/spectrum analyzer is 9 kHz at frequency below 30 MHz.

For Radiated Emission above 30 MHz

- a. The EUT was placed on the top of a rotating table 0.8 meters (for 30 MHz ~ 1 GHz) / 1.5 meters (for above 1 GHz) above the ground at 3 meter chamber room for test. The table was rotated 360 degrees to determine the position of the highest radiation.
- b. The EUT was set 3 meters away from the interference-receiving antenna, which was mounted on the top of a variable-height antenna tower.
- c. The height of antenna is varied from one meter to four meters above the ground to determine the maximum value of the field strength. Both horizontal and vertical polarizations of the antenna are set to make the measurement.
- d. For each suspected emission, the EUT was arranged to its worst case and then the antenna was tuned to heights from 1 meter to 4 meters and the rotatable table was turned from 0 degrees to 360 degrees to find the maximum reading.
- e. The test-receiver system was set to quasi-peak detect function and specified bandwidth with maximum hold mode when the test frequency is below 1 GHz.
- f. The test-receiver system was set to peak and average detected function and specified bandwidth with maximum hold mode when the test frequency is above 1 GHz. If the peak reading value also meets average limit, measurement with the average detector is unnecessary.

Note:

1. The resolution bandwidth and video bandwidth of test receiver/spectrum analyzer is 120 kHz for Quasi-peak detection (QP) or Peak detection (PK) at frequency below 1 GHz.
2. The resolution bandwidth of test receiver/spectrum analyzer is 1 MHz and the video bandwidth is 3 MHz for Peak detection (PK) at frequency above 1 GHz.
3. The resolution bandwidth of test receiver/spectrum analyzer is 1 MHz and the video bandwidth is $\geq 1/T$ (Duty cycle < 98 %) or 10 Hz (Duty cycle ≥ 98 %) for Average detection (AV) at frequency above 1 GHz. (LE 4.0: RBW = 1 MHz, VBW = 3 kHz, LE 5.0: RBW = 1 MHz, VBW = 5 kHz)
4. All modes of operation were investigated and the worst-case emissions are reported.

4.1.4 Deviation from Test Standard

No deviation.

4.1.5 Test Set Up

<Radiated Emission below 30 MHz>

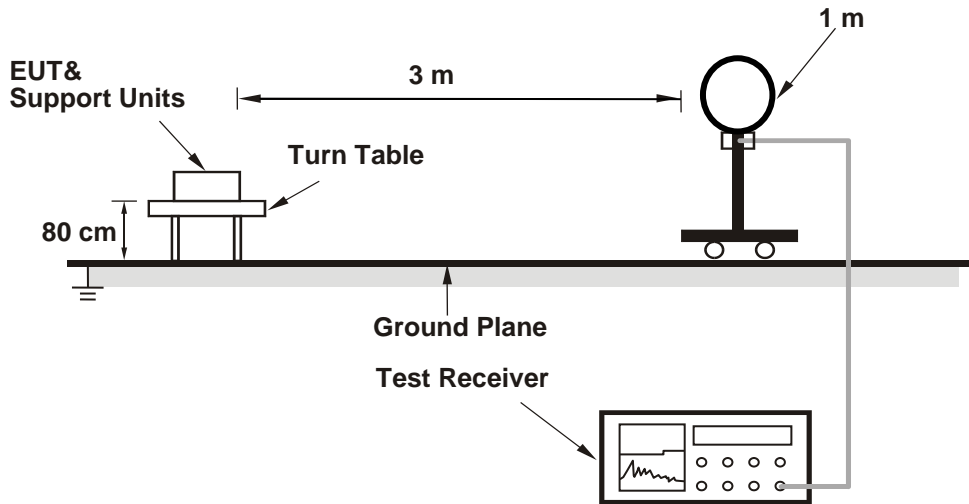

<Radiated Emission 30 MHz to 1 GHz>

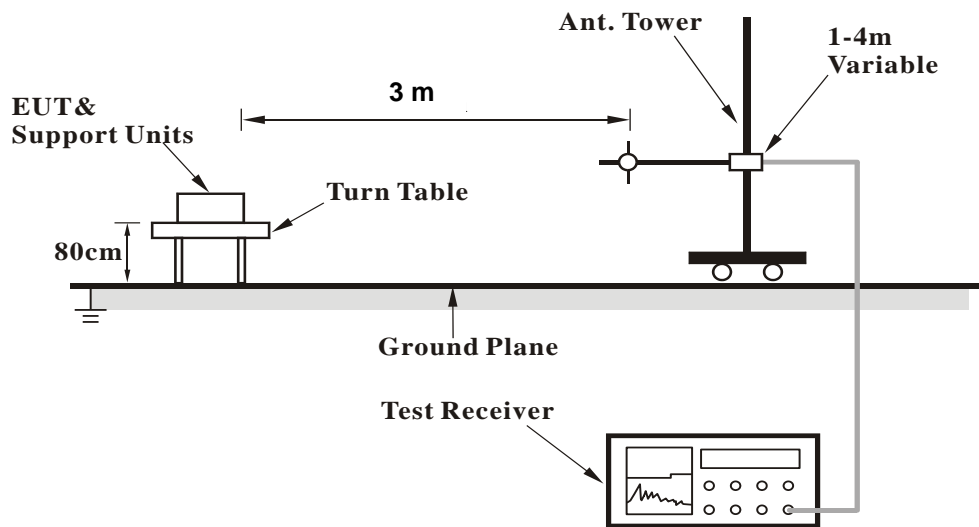

<Radiated Emission above 1 GHz>

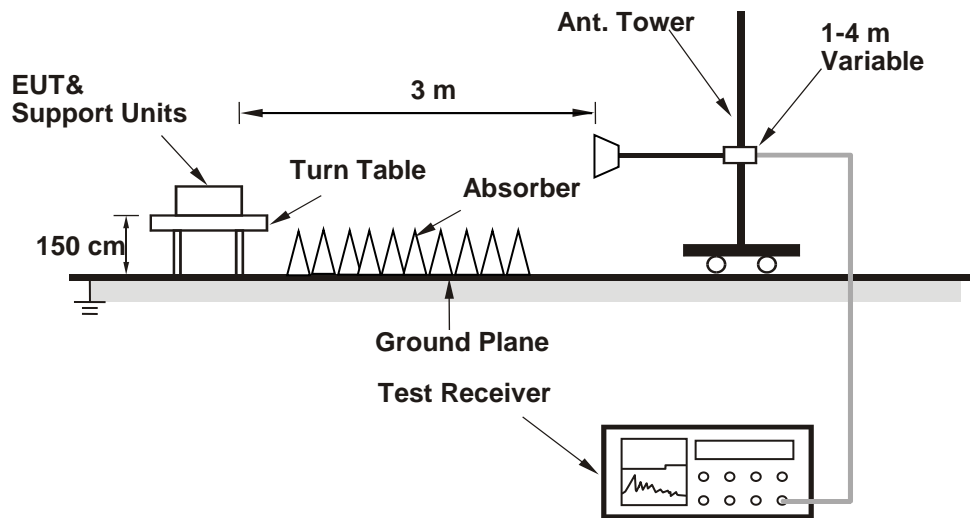

For the actual test configuration, please refer to the attached file (Test Setup Photo).

4.1.6 EUT Operating Conditions

- a. Placed the EUT on the testing table.
- b. Set the EUT under transmission condition continuously at specific channel frequency.

4.1.7 Test Results

ABOVE 1GHz DATA

<LE 4.0>

RF Mode	TX BT_LE-1M	Channel	CH 0 : 2402 MHz
Frequency Range	1GHz ~ 25GHz	Detector Function	Peak (PK) Average (AV)

Antenna Polarity & Test Distance : Horizontal at 3 m								
No	Frequency (MHz)	Emission Level (dBuV/m)	Limit (dBuV/m)	Margin (dB)	Antenna Height (m)	Table Angle (Degree)	Raw Value (dBuV)	Correction Factor (dB/m)
1	2390.00	59.2 PK	74.0	-14.8	1.95 H	188	24.8	34.4
2	2390.00	47.2 AV	54.0	-6.8	1.95 H	188	12.8	34.4
3	*2402.00	99.8 PK			1.95 H	188	65.5	34.3
4	*2402.00	98.8 AV			1.95 H	188	64.5	34.3
5	4804.00	47.6 PK	74.0	-26.4	1.73 H	261	41.5	6.1
6	4804.00	35.4 AV	54.0	-18.6	1.73 H	261	29.3	6.1
Antenna Polarity & Test Distance : Vertical at 3 m								
No	Frequency (MHz)	Emission Level (dBuV/m)	Limit (dBuV/m)	Margin (dB)	Antenna Height (m)	Table Angle (Degree)	Raw Value (dBuV)	Correction Factor (dB/m)
1	2390.00	59.7 PK	74.0	-14.3	1.85 V	164	25.3	34.4
2	2390.00	47.4 AV	54.0	-6.6	1.85 V	164	13.0	34.4
3	*2402.00	98.4 PK			1.85 V	164	64.1	34.3
4	*2402.00	97.5 AV			1.85 V	164	63.2	34.3
5	4804.00	47.4 PK	74.0	-26.6	2.34 V	166	41.3	6.1
6	4804.00	35.2 AV	54.0	-18.8	2.34 V	166	29.1	6.1

Remarks:

1. Emission Level(dBuV/m) = Raw Value(dBuV) + Correction Factor(dB/m)
2. Correction Factor(dB/m) = Antenna Factor(dB/m) + Cable Factor(dB) – Pre-Amplifier Factor(dB)
3. Margin value = Emission Level – Limit value
4. The other emission levels were very low against the limit.
5. " * ": Fundamental frequency.

RF Mode	TX BT_LE-1M	Channel	CH 19 : 2440 MHz
Frequency Range	1GHz ~ 25GHz	Detector Function	Peak (PK) Average (AV)

Antenna Polarity & Test Distance : Horizontal at 3 m

No	Frequency (MHz)	Emission Level (dBuV/m)	Limit (dBuV/m)	Margin (dB)	Antenna Height (m)	Table Angle (Degree)	Raw Value (dBuV)	Correction Factor (dB/m)
1	*2440.00	99.9 PK			1.45 H	189	65.6	34.3
2	*2440.00	98.9 AV			1.45 H	189	64.6	34.3
3	4880.00	47.4 PK	74.0	-26.6	1.80 H	259	41.3	6.1
4	4880.00	35.3 AV	54.0	-18.7	1.80 H	259	29.2	6.1

Antenna Polarity & Test Distance : Vertical at 3 m

No	Frequency (MHz)	Emission Level (dBuV/m)	Limit (dBuV/m)	Margin (dB)	Antenna Height (m)	Table Angle (Degree)	Raw Value (dBuV)	Correction Factor (dB/m)
1	*2440.00	98.4 PK			1.60 V	166	64.1	34.3
2	*2440.00	97.3 AV			1.60 V	166	63.0	34.3
3	4880.00	47.4 PK	74.0	-26.6	2.91 V	187	41.3	6.1
4	4880.00	35.4 AV	54.0	-18.6	2.91 V	187	29.3	6.1

Remarks:

1. Emission Level(dBuV/m) = Raw Value(dBuV) + Correction Factor(dB/m)
2. Correction Factor(dB/m) = Antenna Factor(dB/m) + Cable Factor(dB) – Pre-Amplifier Factor(dB)
3. Margin value = Emission Level – Limit value
4. The other emission levels were very low against the limit.
5. " * ": Fundamental frequency.

RF Mode	TX BT_LE-1M	Channel	CH 39 : 2480 MHz
Frequency Range	1GHz ~ 25GHz	Detector Function	Peak (PK) Average (AV)

Antenna Polarity & Test Distance : Horizontal at 3 m

No	Frequency (MHz)	Emission Level (dBuV/m)	Limit (dBuV/m)	Margin (dB)	Antenna Height (m)	Table Angle (Degree)	Raw Value (dBuV)	Correction Factor (dB/m)
1	*2480.00	100.8 PK			1.04 H	184	66.4	34.4
2	*2480.00	100.0 AV			1.04 H	184	65.6	34.4
3	2483.50	59.3 PK	74.0	-14.7	1.04 H	184	24.9	34.4
4	2483.50	49.2 AV	54.0	-4.8	1.04 H	184	14.8	34.4
5	4960.00	47.9 PK	74.0	-26.1	1.59 H	242	41.6	6.3
6	4960.00	35.5 AV	54.0	-18.5	1.59 H	242	29.2	6.3

Antenna Polarity & Test Distance : Vertical at 3 m

No	Frequency (MHz)	Emission Level (dBuV/m)	Limit (dBuV/m)	Margin (dB)	Antenna Height (m)	Table Angle (Degree)	Raw Value (dBuV)	Correction Factor (dB/m)
1	*2480.00	100.3 PK			1.68 V	167	65.9	34.4
2	*2480.00	99.4 AV			1.68 V	167	65.0	34.4
3	2483.50	59.9 PK	74.0	-14.1	1.68 V	167	25.5	34.4
4	2483.50	49.2 AV	54.0	-4.8	1.68 V	167	14.8	34.4
5	4960.00	47.5 PK	74.0	-26.5	2.36 V	149	41.2	6.3
6	4960.00	35.5 AV	54.0	-18.5	2.36 V	149	29.2	6.3

Remarks:

1. Emission Level(dBuV/m) = Raw Value(dBuV) + Correction Factor(dB/m)
2. Correction Factor(dB/m) = Antenna Factor(dB/m) + Cable Factor(dB) – Pre-Amplifier Factor(dB)
3. Margin value = Emission Level – Limit value
4. The other emission levels were very low against the limit.
5. " * " : Fundamental frequency.

<LE 5.0>

DATA

RF Mode	TX BT_LE-2M	Channel	CH 0 : 2402 MHz
Frequency Range	1GHz ~ 25GHz	Detector Function	Peak (PK) Average (AV)

Antenna Polarity & Test Distance : Horizontal at 3 m								
No	Frequency (MHz)	Emission Level (dBuV/m)	Limit (dBuV/m)	Margin (dB)	Antenna Height (m)	Table Angle (Degree)	Raw Value (dBuV)	Correction Factor (dB/m)
1	2390.00	59.4 PK	74.0	-14.6	1.14 H	161	25.0	34.4
2	2390.00	47.7 AV	54.0	-6.3	1.14 H	161	13.3	34.4
3	*2402.00	100.5 PK			1.14 H	161	66.2	34.3
4	*2402.00	98.1 AV			1.14 H	161	63.8	34.3
5	4804.00	47.3 PK	74.0	-26.7	1.90 H	243	41.2	6.1
6	4804.00	35.1 AV	54.0	-18.9	1.90 H	243	29.0	6.1
Antenna Polarity & Test Distance : Vertical at 3 m								
No	Frequency (MHz)	Emission Level (dBuV/m)	Limit (dBuV/m)	Margin (dB)	Antenna Height (m)	Table Angle (Degree)	Raw Value (dBuV)	Correction Factor (dB/m)
1	2390.00	59.2 PK	74.0	-14.8	1.43 V	169	24.8	34.4
2	2390.00	48.1 AV	54.0	-5.9	1.43 V	169	13.7	34.4
3	*2402.00	99.3 PK			1.43 V	169	65.0	34.3
4	*2402.00	96.5 AV			1.43 V	169	62.2	34.3
5	4804.00	47.6 PK	74.0	-26.4	2.71 V	178	41.5	6.1
6	4804.00	36.6 AV	54.0	-17.4	2.71 V	178	30.5	6.1

Remarks:

1. Emission Level(dBuV/m) = Raw Value(dBuV) + Correction Factor(dB/m)
2. Correction Factor(dB/m) = Antenna Factor(dB/m) + Cable Factor(dB) – Pre-Amplifier Factor(dB)
3. Margin value = Emission Level – Limit value
4. The other emission levels were very low against the limit.
5. " * ": Fundamental frequency.

RF Mode	TX BT_LE-2M	Channel	CH 19 : 2440 MHz
Frequency Range	1GHz ~ 25GHz	Detector Function	Peak (PK) Average (AV)

Antenna Polarity & Test Distance : Horizontal at 3 m

No	Frequency (MHz)	Emission Level (dBuV/m)	Limit (dBuV/m)	Margin (dB)	Antenna Height (m)	Table Angle (Degree)	Raw Value (dBuV)	Correction Factor (dB/m)
1	*2440.00	100.0 PK			1.50 H	188	65.7	34.3
2	*2440.00	97.4 AV			1.50 H	188	63.1	34.3
3	4880.00	47.7 PK	74.0	-26.3	1.77 H	255	41.6	6.1
4	4880.00	36.2 AV	54.0	-17.8	1.77 H	255	30.1	6.1

Antenna Polarity & Test Distance : Vertical at 3 m

No	Frequency (MHz)	Emission Level (dBuV/m)	Limit (dBuV/m)	Margin (dB)	Antenna Height (m)	Table Angle (Degree)	Raw Value (dBuV)	Correction Factor (dB/m)
1	*2440.00	98.7 PK			1.76 V	168	64.4	34.3
2	*2440.00	96.1 AV			1.76 V	168	61.8	34.3
3	4880.00	47.6 PK	74.0	-26.4	2.63 V	158	41.5	6.1
4	4880.00	36.3 AV	54.0	-17.7	2.63 V	158	30.2	6.1

Remarks:

1. Emission Level(dBuV/m) = Raw Value(dBuV) + Correction Factor(dB/m)
2. Correction Factor(dB/m) = Antenna Factor(dB/m) + Cable Factor(dB) – Pre-Amplifier Factor(dB)
3. Margin value = Emission Level – Limit value
4. The other emission levels were very low against the limit.
5. " * ": Fundamental frequency.

RF Mode	TX BT_LE-2M	Channel	CH 39 : 2480 MHz
Frequency Range	1GHz ~ 25GHz	Detector Function	Peak (PK) Average (AV)

Antenna Polarity & Test Distance : Horizontal at 3 m

No	Frequency (MHz)	Emission Level (dBuV/m)	Limit (dBuV/m)	Margin (dB)	Antenna Height (m)	Table Angle (Degree)	Raw Value (dBuV)	Correction Factor (dB/m)
1	*2480.00	99.7 PK			1.53 H	182	65.3	34.4
2	*2480.00	97.2 AV			1.53 H	182	62.8	34.4
3	2483.50	59.0 PK	74.0	-15.0	1.53 H	182	24.6	34.4
4	2483.50	49.9 AV	54.0	-4.1	1.53 H	182	15.5	34.4
5	4960.00	48.0 PK	74.0	-26.0	1.63 H	270	41.7	6.3
6	4960.00	36.3 AV	54.0	-17.7	1.63 H	270	30.0	6.3

Antenna Polarity & Test Distance : Vertical at 3 m

No	Frequency (MHz)	Emission Level (dBuV/m)	Limit (dBuV/m)	Margin (dB)	Antenna Height (m)	Table Angle (Degree)	Raw Value (dBuV)	Correction Factor (dB/m)
1	*2480.00	99.7 PK			1.74 V	168	65.3	34.4
2	*2480.00	97.1 AV			1.74 V	168	62.7	34.4
3	2483.50	59.7 PK	74.0	-14.3	1.74 V	168	25.3	34.4
4	2483.50	49.8 AV	54.0	-4.2	1.74 V	168	15.4	34.4
5	4960.00	47.5 PK	74.0	-26.5	2.63 V	147	41.2	6.3
6	4960.00	36.4 AV	54.0	-17.6	2.63 V	147	30.1	6.3

Remarks:

1. Emission Level(dBuV/m) = Raw Value(dBuV) + Correction Factor(dB/m)
2. Correction Factor(dB/m) = Antenna Factor(dB/m) + Cable Factor(dB) – Pre-Amplifier Factor(dB)
3. Margin value = Emission Level – Limit value
4. The other emission levels were very low against the limit.
5. " * ": Fundamental frequency.

9 kHz ~ 30 MHz Data:

The amplitude of spurious emissions attenuated more than 20 dB below the permissible value is not required to be report.

30 MHz ~ 1 GHz Worst-Case Data:

<LE 5.0>

RF Mode	TX BT_LE-2M	Channel	CH 39 : 2480 MHz
Frequency Range	30MHz ~ 1GHz	Detector Function	Quasi-Peak (QP)

Antenna Polarity & Test Distance : Horizontal at 3 m								
No	Frequency (MHz)	Emission Level (dBuV/m)	Limit (dBuV/m)	Margin (dB)	Antenna Height (m)	Table Angle (Degree)	Raw Value (dBuV)	Correction Factor (dB/m)
1	49.68	24.7 QP	40.0	-15.3	1.00 H	237	33.8	-9.1
2	143.87	23.7 QP	43.5	-19.8	1.00 H	242	32.5	-8.8
3	239.46	35.2 QP	46.0	-10.8	1.00 H	333	44.4	-9.2
4	335.06	45.0 QP	46.0	-1.0	1.00 H	25	50.7	-5.7
5	432.06	29.5 QP	46.0	-16.5	1.00 H	142	33.1	-3.6
6	579.67	33.1 QP	46.0	-12.9	1.00 H	200	33.6	-0.5

Remarks:

1. Emission Level(dBuV/m) = Raw Value(dBuV) + Correction Factor(dB/m)
2. Correction Factor(dB/m) = Antenna Factor(dB/m) + Cable Factor(dB) – Pre-Amplifier Factor(dB)
3. Margin value = Emission Level – Limit value
4. The other emission levels were very low against the limit of frequency range 30MHz~1000MHz.
5. The emission levels were very low against the limit of frequency range 9kHz~30MHz: the amplitude of spurious emissions attenuated more than 20 dB below the permissible value to be report.

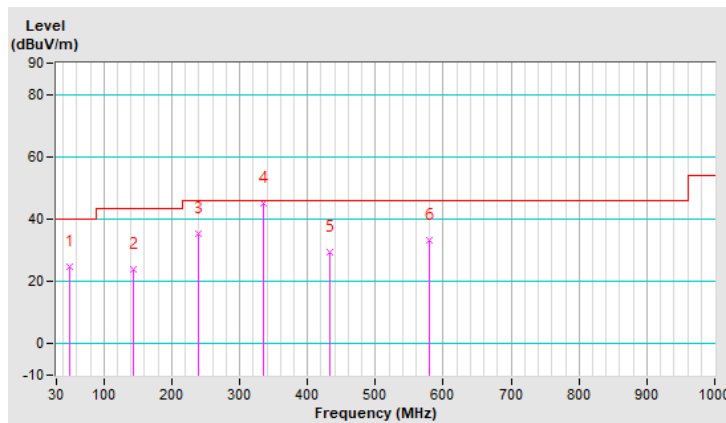

RF Mode	TX BT_LE-2M	Channel	CH 39 : 2480 MHz
Frequency Range	30MHz ~ 1GHz	Detector Function	Quasi-Peak (QP)

Antenna Polarity & Test Distance : Vertical at 3 m								
No	Frequency (MHz)	Emission Level (dBuV/m)	Limit (dBuV/m)	Margin (dB)	Antenna Height (m)	Table Angle (Degree)	Raw Value (dBuV)	Correction Factor (dB/m)
1	49.68	36.1 QP	40.0	-3.9	1.00 V	102	45.2	-9.1
2	104.51	30.6 QP	43.5	-12.9	1.00 V	185	43.1	-12.5
3	239.46	28.6 QP	46.0	-17.4	1.50 V	353	37.8	-9.2
4	280.23	31.6 QP	46.0	-14.4	1.00 V	14	38.5	-6.9
5	335.06	32.9 QP	46.0	-13.1	1.00 V	110	38.6	-5.7
6	464.39	31.6 QP	46.0	-14.4	1.00 V	159	34.5	-2.9

Remarks:

1. Emission Level(dBuV/m) = Raw Value(dBuV) + Correction Factor(dB/m)
2. Correction Factor(dB/m) = Antenna Factor(dB/m) + Cable Factor(dB) – Pre-Amplifier Factor(dB)
3. Margin value = Emission Level – Limit value
4. The other emission levels were very low against the limit of frequency range 30MHz~1000MHz.
5. The emission levels were very low against the limit of frequency range 9kHz~30MHz: the amplitude of spurious emissions attenuated more than 20 dB below the permissible value to be report.

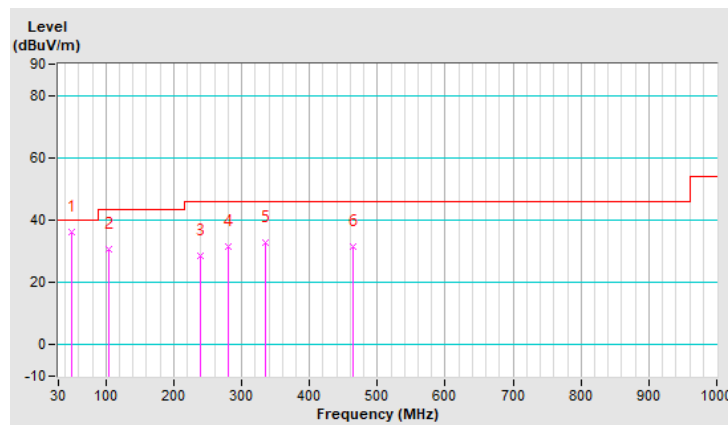

4.2 Conducted Emission Measurement

4.2.1 Limits of Conducted Emission Measurement

Frequency (MHz)	Conducted Limit (dBuV)	
	Quasi-Peak	Average
0.15 - 0.5	66 - 56	56 - 46
0.50 - 5.0	56	46
5.0 - 30.0	60	50

- Note: 1. The lower limit shall apply at the transition frequencies.
 2. The limit decreases in line with the logarithm of the frequency in the range of 0.15 to 0.50 MHz.

4.2.2 Test Instruments

Description & Manufacturer	Model No.	Serial No.	Date of Calibration	Due Date of Calibration
Test Receiver ROHDE & SCHWARZ	ESCI	100613	Dec. 04, 2020	Dec. 03, 2021
RF signal cable (with 10dB PAD) Woken	5D-FB	Cable-cond1-01	Sep. 04, 2020	Sep. 03, 2021
LISN ROHDE & SCHWARZ (EUT)	ESH3-Z5	835239/001	Mar. 19, 2020	Mar. 18, 2021
LISN ROHDE & SCHWARZ (Peripheral)	ESH3-Z5	100311	Aug. 28, 2020	Aug. 27, 2021
Software ADT	BV ADT_Cond_ V7.3.7.4	NA	NA	NA

- Note: 1. The calibration interval of the above test instruments is 12 months and the calibrations are traceable to NML/ROC and NIST/USA.
 2. The test was performed in HwaYa Shielded Room 1 (Conduction 1).
 3. The VCCI Site Registration No. is C-12040.

4.2.3 Test Procedures

- The EUT was placed 0.4 meters from the conducting wall of the shielded room with EUT being connected to the power mains through a line impedance stabilization network (LISN). Other support units were connected to the power mains through another LISN. The two LISNs provide 50 ohm/50 uH of coupling impedance for the measuring instrument.
- Both lines of the power mains connected to the EUT were checked for maximum conducted interference.
- The frequency range from 150 kHz to 30 MHz was searched. Emission levels under (Limit – 20 dB) was not recorded.

Note: The resolution bandwidth and video bandwidth of test receiver is 9 kHz for quasi-peak detection (QP) and average detection (AV) at frequency 0.15 MHz - 30 MHz.

4.2.4 Deviation from Test Standard

No deviation.

4.2.5 Test Setup

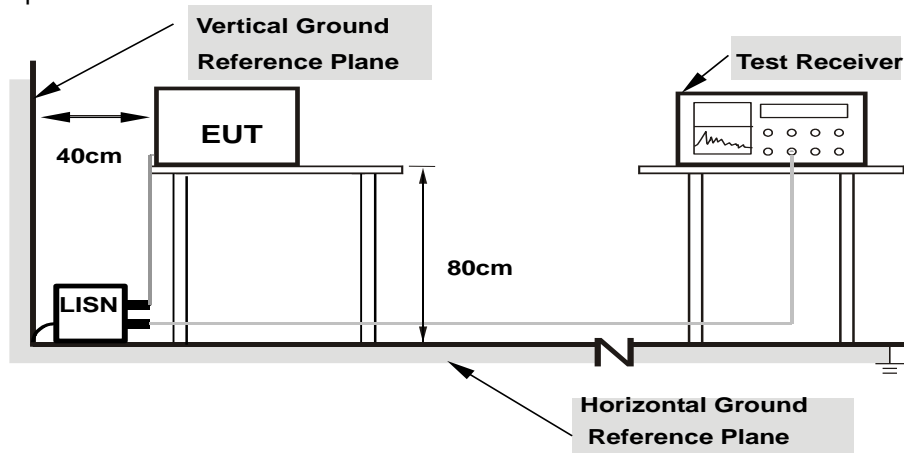

**Note: 1.Support units were connected to second LISN.
2.Both of LISNs (AMN) are 80 cm from EUT and at least 80 from other units and other metal planes**

4.2.6 EUT Operating Conditions

- a. Placed the EUT on the testing table.
- b. Set the EUT under transmission condition continuously at specific channel frequency.

4.2.7 Test Results

Frequency Range	150kHz ~ 30MHz	Detector Function & Resolution Bandwidth	Quasi-Peak (QP) / Average (AV), 9kHz
Input Power	120Vac, 60Hz	Environmental Conditions	23°C, 66%RH
Tested by	Titan Hsu	Test Date	2021/1/30

Phase Of Power : Line (L)										
No	Frequency (MHz)	Correction Factor (dB)	Reading Value (dBuV)		Emission Level (dBuV)		Limit (dBuV)		Margin (dB)	
			Q.P.	AV.	Q.P.	AV.	Q.P.	AV.	Q.P.	AV.
1	0.16932	9.65	33.12	21.55	42.77	31.20	64.99	54.99	-22.22	-23.79
2	0.18600	9.65	30.17	18.41	39.82	28.06	64.21	54.21	-24.39	-26.15
3	0.55800	9.69	30.55	24.70	40.24	34.39	56.00	46.00	-15.76	-11.61
4	3.10200	9.73	21.80	12.49	31.53	22.22	56.00	46.00	-24.47	-23.78
5	6.94600	9.77	22.06	17.03	31.83	26.80	60.00	50.00	-28.17	-23.20
6	12.12200	9.79	22.49	11.87	32.28	21.66	60.00	50.00	-27.72	-28.34

Remarks:

1. Q.P. and AV. are abbreviations of quasi-peak and average individually.
2. The emission levels of other frequencies were very low against the limit.
3. Margin value = Emission level – Limit value
4. Correction factor = Insertion loss + Cable loss
5. Emission Level = Correction Factor + Reading Value

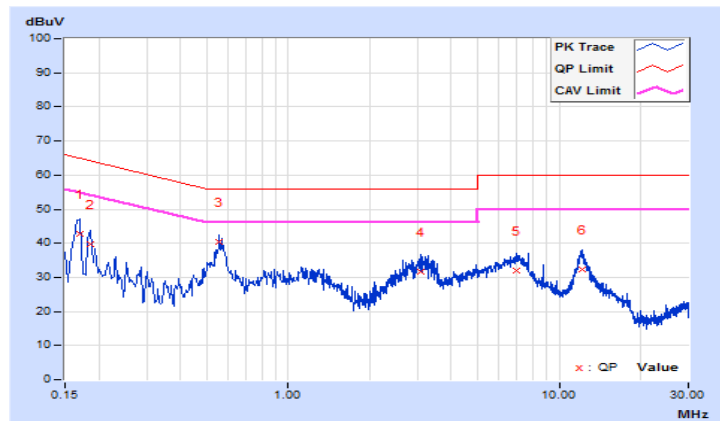

Frequency Range	150kHz ~ 30MHz	Detector Function & Resolution Bandwidth	Quasi-Peak (QP) / Average (AV), 9kHz
Input Power	120Vac, 60Hz	Environmental Conditions	23°C, 66%RH
Tested by	Titan Hsu	Test Date	2021/1/30

Phase Of Power : Neutral (N)										
No	Frequency (MHz)	Correction Factor (dB)	Reading Value (dBuV)		Emission Level (dBuV)		Limit (dBuV)		Margin (dB)	
			Q.P.	AV.	Q.P.	AV.	Q.P.	AV.	Q.P.	AV.
1	0.15400	9.68	36.44	22.46	46.12	32.14	65.78	55.78	-19.66	-23.64
2	0.17400	9.68	31.06	18.89	40.74	28.57	64.77	54.77	-24.03	-26.20
3	0.56591	9.71	28.48	23.35	38.19	33.06	56.00	46.00	-17.81	-12.94
4	3.33400	9.76	20.74	11.76	30.50	21.52	56.00	46.00	-25.50	-24.48
5	7.01400	9.81	20.79	15.96	30.60	25.77	60.00	50.00	-29.40	-24.23
6	11.99800	9.85	20.88	11.47	30.73	21.32	60.00	50.00	-29.27	-28.68

Remarks:

1. Q.P. and AV. are abbreviations of quasi-peak and average individually.
2. The emission levels of other frequencies were very low against the limit.
3. Margin value = Emission level – Limit value
4. Correction factor = Insertion loss + Cable loss
5. Emission Level = Correction Factor + Reading Value

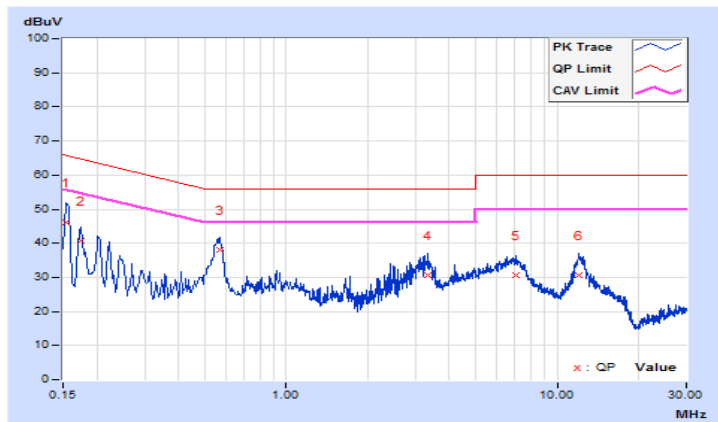

4.3 Conducted Output Power Measurement

4.3.1 Limits of Conducted Output Power Measurement

For systems using digital modulation in the 2400–2483.5 MHz bands: 1 Watt (30 dBm)

4.3.2 Test Setup

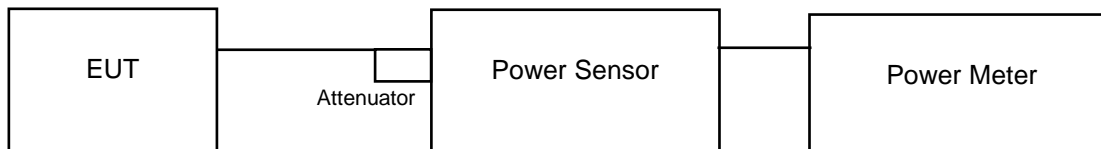

4.3.3 Test Instruments

Refer to section 4.1.2 to get information of above instrument.

4.3.4 Test Procedures

A peak power sensor was used on the output port of the EUT. A power meter was used to read the response of the peak power sensor. Record the power level.

Average power sensor was used to perform output power measurement, trigger and gating function of wide band power meter is enabled to measure max output power of TX on burst. Duty factor is not added to measured value.

4.3.5 Deviation from Test Standard

No deviation.

4.3.6 EUT Operating Conditions

The software provided by client to enable the EUT under transmission condition continuously at lowest, middle and highest channel frequencies individually.

4.3.7 Test Results

<LE 4.0>

Channel	Frequency (MHz)	Peak Power (mW)	Peak Power (dBm)	Limit (dBm)	Pass / Fail
0	2402	4.93	6.93	30	Pass
19	2440	4.97	6.96	30	Pass
39	2480	4.93	6.93	30	Pass

Channel	Freq. (MHz)	Average Power (mW)	Average Power (dBm)	Limit (dBm)	Pass / Fail
0	2402	4.89	6.89	30	Pass
19	2440	4.91	6.91	30	Pass
39	2480	4.88	6.88	30	Pass

<LE 5.0>

Channel	Frequency (MHz)	Peak Power (mW)	Peak Power (dBm)	Limit (dBm)	Pass / Fail
0	2402	4.89	6.89	30	Pass
19	2440	4.91	6.91	30	Pass
39	2480	4.9	6.90	30	Pass

Channel	Freq. (MHz)	Average Power (mW)	Average Power (dBm)	Limit (dBm)	Pass / Fail
0	2402	4.84	6.85	30	Pass
19	2440	4.86	6.87	30	Pass
39	2480	4.85	6.86	30	Pass

5 Pictures of Test Arrangements

Please refer to the attached file (Test Setup Photo).

Annex A- Band Edge Measurement

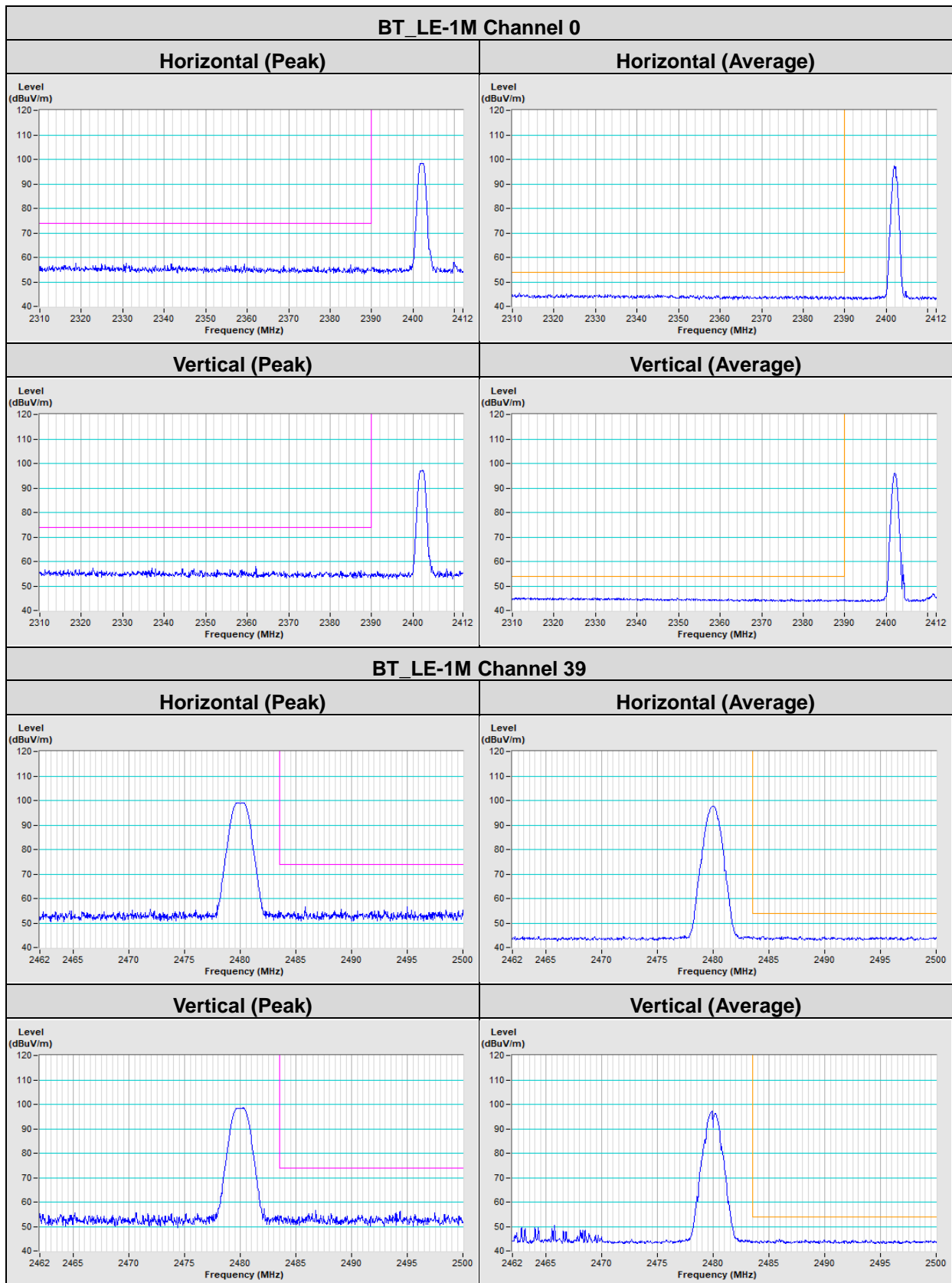

BT_LE-2M Channel 0

Horizontal (Peak)

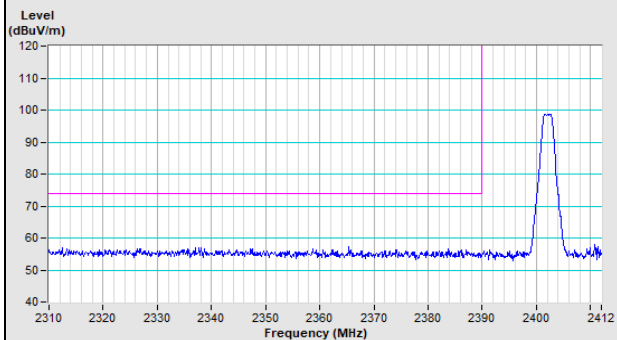

Horizontal (Average)

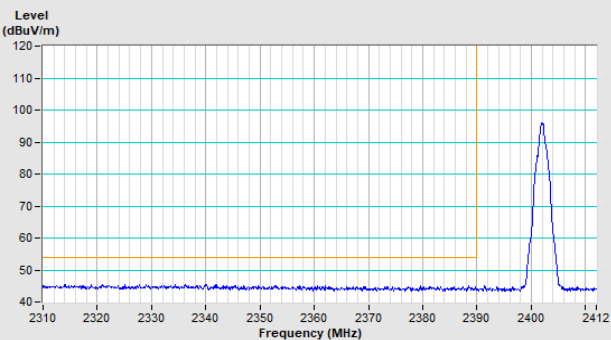

Vertical (Peak)

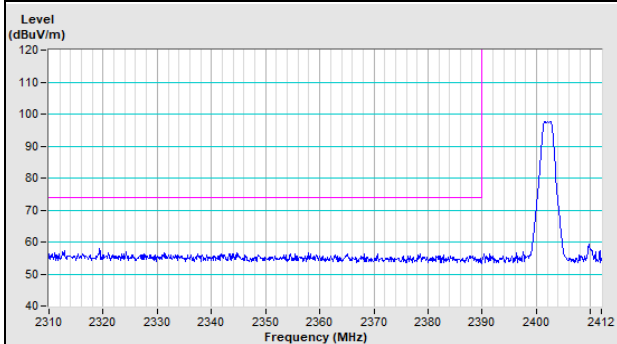

Vertical (Average)

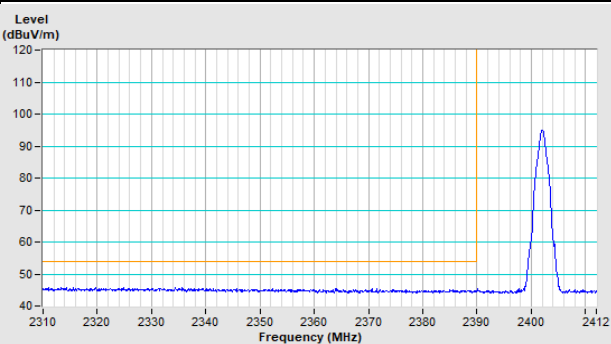

BT_LE-2M Channel 39

Horizontal (Peak)

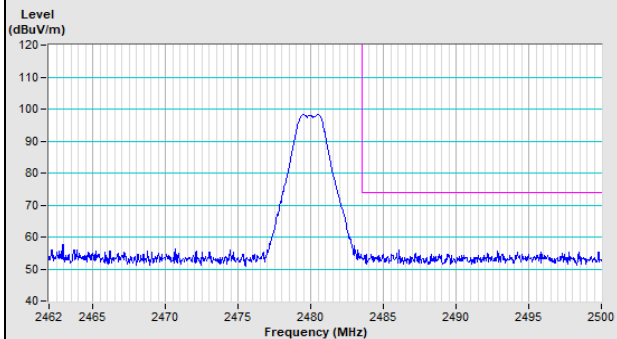

Horizontal (Average)

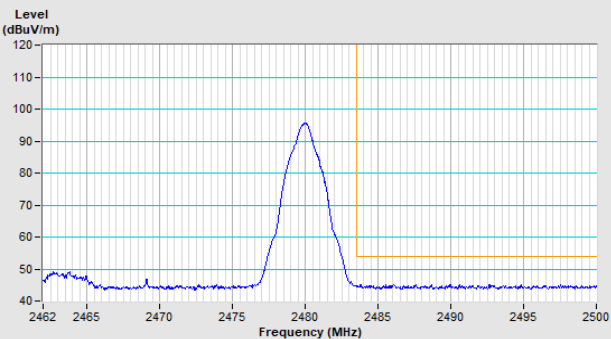

Vertical (Peak)

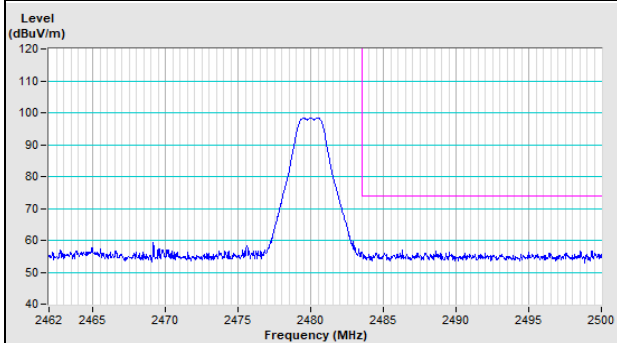

Vertical (Average)

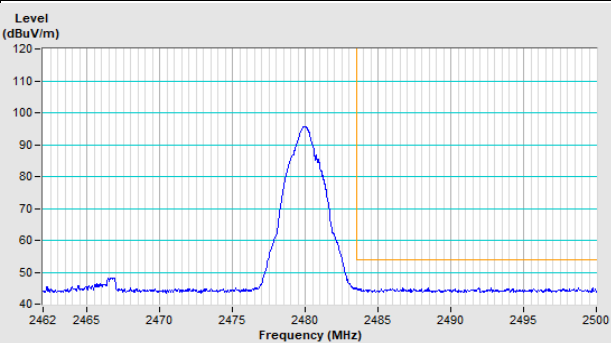

Appendix – Information of the Testing Laboratories

We, Bureau Veritas Consumer Products Services (H.K.) Ltd., Taoyuan Branch, were founded in 1988 to provide our best service in EMC, Radio, Telecom and Safety consultation. Our laboratories are FCC recognized accredited test firms and accredited according to ISO/IEC 17025.

If you have any comments, please feel free to contact us at the following:

Lin Kou EMC/RF Lab

Tel: 886-2-26052180

Fax: 886-2-26051924

Hsin Chu EMC/RF/Telecom Lab

Tel: 886-3-6668565

Fax: 886-3-6668323

Hwa Ya EMC/RF/Safety Lab

Tel: 886-3-3183232

Fax: 886-3-3270892

Email: service.adt@tw.bureauveritas.com

Web Site: www.bureauveritas-adt.com

The address and road map of all our labs can be found in our web site also.

--- END ---