



# FCC TEST REPORT (15.247)

**REPORT NO.:** RF131213C12-3  
**MODEL NO.:** Lenovo A7600-H  
**FCC ID:** O57A7600H  
**RECEIVED:** Dec. 13, 2013  
**TESTED:** Dec. 19, 2013 ~ Jan. 09, 2014  
**ISSUED:** Jan. 15, 2014

**APPLICANT:** Lenovo (Shanghai) Electronics Technology Co., Ltd.

**ADDRESS:** No. 68 Building, 199 Fenju Road, Wai Gao Qiao FTZ,  
Shanghai, China

**ISSUED BY:** Bureau Veritas Consumer Products Services  
(H.K.) Ltd., Taoyuan Branch

**LAB ADDRESS:** No. 47, 14th Ling, Chia Pau Vil., Lin Kou Dist.,  
New Taipei City, Taiwan ( R.O.C )

**TEST LOCATION:** No. 19, Hwa Ya 2nd Rd, Wen Hwa Tsuen, Kwei  
Shan Hsiang, Taoyuan Hsien 333, Taiwan, R.O.C.

This report should not be used by the client to claim product certification, approval, or endorsement by TAF or any government agencies.



This report is for your exclusive use. Any copying or replication of this report to or for any other person or entity, or use of our name or trademark, is permitted only with our prior written permission. This report sets forth our findings solely with respect to the test samples identified herein. The results set forth in this report are not indicative or representative of the quality or characteristics of the lot from which a test sample was taken or any similar or identical product unless specifically and expressly noted. Our report includes all of the tests requested by you and the results thereof based upon the information that you provided to us. You have 60 days from date of issuance of this report to notify us of any material error or omission caused by our negligence, provided, however, that such notice shall be in writing and shall specifically address the issue you wish to raise. A failure to raise such issue within the prescribed time shall constitute your unqualified acceptance of the completeness of this report, the tests conducted and the correctness of the report contents. Unless specific mention, the uncertainty of measurement has been explicitly taken into account to declare the compliance or non-compliance to the specification.



# TABLE OF CONTENTS

RELEASE CONTROL RECORD.....	4
1. CERTIFICATION .....	5
2. SUMMARY OF TEST RESULTS .....	6
2.1 MEASUREMENT UNCERTAINTY.....	6
3. GENERAL INFORMATION.....	7
3.1 GENERAL DESCRIPTION OF EUT .....	7
3.2 DESCRIPTION OF TEST MODES .....	9
3.2.1 TEST MODE APPLICABILITY AND TESTED CHANNEL DETAIL .....	10
3.3 DESCRIPTION OF SUPPORT UNITS .....	12
3.3.1 CONFIGURATION OF SYSTEM UNDER TEST .....	12
3.4 GENERAL DESCRIPTION OF APPLIED STANDARDS .....	12
4. TEST TYPES AND RESULTS (FOR 2.4GHz BAND).....	13
4.1 RADIATED EMISSION AND BANDEDGE MEASUREMENT .....	13
4.1.1 LIMITS OF RADIATED EMISSION AND BANDEDGE MEASUREMENT .....	13
4.1.2 TEST INSTRUMENTS.....	14
4.1.3 TEST PROCEDURES .....	15
4.1.4 DEVIATION FROM TEST STANDARD .....	15
4.1.5 TEST SETUP.....	16
4.1.6 EUT OPERATING CONDITIONS .....	16
4.1.7 TEST RESULTS .....	17
4.2 CONDUCTED EMISSION MEASUREMENT .....	29
4.2.1 LIMITS OF CONDUCTED EMISSION MEASUREMENT .....	29
4.2.2 TEST INSTRUMENTS.....	29
4.2.3 TEST PROCEDURES .....	30
4.2.4 DEVIATION FROM TEST STANDARD .....	30
4.2.5 TEST SETUP.....	31
4.2.6 EUT OPERATING CONDITIONS .....	31
4.2.7 TEST RESULTS .....	32
4.3 6dB BANDWIDTH MEASUREMENT.....	34
4.3.1 LIMITS OF 6dB BANDWIDTH MEASUREMENT .....	34
4.3.2 TEST SETUP.....	34
4.3.3 TEST INSTRUMENTS.....	34
4.3.4 TEST PROCEDURE.....	34
4.3.5 DEVIATION FROM TEST STANDARD .....	34
4.3.6 EUT OPERATING CONDITIONS .....	34
4.3.7 TEST RESULTS .....	35
4.4 CONDUCTED OUTPUT POWER.....	37
4.4.1 LIMITS OF CONDUCTED OUTPUT POWER MEASUREMENT .....	37



A D T

4.4.2	TEST SETUP.....	37
4.4.3	TEST INSTRUMENTS.....	37
4.4.4	TEST PROCEDURES .....	37
4.4.5	DEVIATION FROM TEST STANDARD .....	37
4.4.6	EUT OPERATING CONDITIONS .....	37
4.4.7	TEST RESULTS .....	38
4.5	POWER SPECTRAL DENSITY MEASUREMENT .....	39
4.5.1	LIMITS OF POWER SPECTRAL DENSITY MEASUREMENT .....	39
4.5.2	TEST SETUP.....	39
4.5.3	TEST INSTRUMENTS.....	39
4.5.4	TEST PROCEDURE.....	39
4.5.5	DEVIATION FROM TEST STANDARD .....	39
4.5.6	EUT OPERATING CONDITION.....	39
4.5.7	TEST RESULTS .....	40
4.6	CONDUCTED OUT OF BAND EMISSION MEASUREMENT .....	42
4.6.1	LIMITS OF CONDUCTED OUT OF BAND EMISSION MEASUREMENT .....	42
4.6.2	TEST SETUP.....	42
4.6.3	TEST INSTRUMENTS.....	42
4.6.4	TEST PROCEDURE.....	42
4.6.5	DEVIATION FROM TEST STANDARD .....	43
4.6.6	EUT OPERATING CONDITION.....	43
4.6.7	TEST RESULTS .....	43
5.	PHOTOGRAPHS OF THE TEST CONFIGURATION.....	47
6.	INFORMATION ON THE TESTING LABORATORIES .....	48
7.	APPENDIX A - MODIFICATIONS RECORDERS FOR ENGINEERING CHANGES TO THE EUT BY THE LAB.....	49



A D T

## RELEASE CONTROL RECORD

ISSUE NO.	REASON FOR CHANGE	DATE ISSUED
RF131213C12-3	Original release	Jan. 15, 2014



## 1. CERTIFICATION

**PRODUCT:** Portable Tablet Computer  
**MODEL NO.:** Lenovo A7600-H  
**BRAND:** lenovo  
**APPLICANT:** Lenovo (Shanghai) Electronics Technology Co., Ltd.  
**TESTED:** Dec. 19, 2013 ~ Jan. 09, 2014  
**TEST SAMPLE:** Production Unit  
**STANDARDS:** **FCC Part 15, Subpart C (Section 15.247)**  
ANSI C63.10-2009

The above equipment (model: Lenovo A7600-H) has been tested by **Bureau Veritas Consumer Products Services (H.K.) Ltd., Taoyuan Branch**, and found compliance with the requirement of the above standards. The test record, data evaluation & Equipment Under Test (EUT) configurations represented herein are true and accurate accounts of the measurements of the sample's EMC characteristics under the conditions specified in this report.

**PREPARED BY** : Vera Huang , **DATE** : Jan. 15, 2014  
Vera Huang / Specialist

**APPROVED BY** : Sam chen , **DATE** : Jan. 15, 2014  
Sam Chen / Senior Project Engineer

## 2. SUMMARY OF TEST RESULTS

The EUT has been tested according to the following specifications:

APPLIED STANDARD: FCC PART 15, SUBPART C (SECTION 15.247)			
STANDARD SECTION	TEST TYPE	RESULT	REMARK
15.207	AC Power Conducted Emission	PASS	Meet the requirement of limit. Minimum passing margin is -10.14dB at 0.55625MHz.
15.247(d) 15.209	Radiated Emissions	PASS	Meet the requirement of limit. Minimum passing margin is -1.12dB at 2390MHz.
15.247(d)	Band Edge Measurement	PASS	Meet the requirement of limit.
15.247(a)(2)	6dB bandwidth	PASS	Meet the requirement of limit.
15.247(b)	Conducted power	PASS	Meet the requirement of limit.
15.247(e)	Power Spectral Density	PASS	Meet the requirement of limit.
15.203	Antenna Requirement	PASS	No antenna connector is used.

### 2.1 MEASUREMENT UNCERTAINTY

Where relevant, the following measurement uncertainty levels have been estimated for tests performed on the EUT as specified in CISPR 16-4-2:

MEASUREMENT	FREQUENCY	UNCERTAINTY
Conducted emissions	9kHz~30MHz	2.44 dB
Radiated emissions	30MHz ~ 200MHz	2.93 dB
	200MHz ~1000MHz	2.95 dB
	1GHz ~ 18GHz	2.26 dB
	18GHz ~ 40GHz	1.94 dB

This uncertainty represents an expanded uncertainty expressed at approximately the 95% confidence level using a coverage factor of  $k = 2$ .



### 3. GENERAL INFORMATION

#### 3.1 GENERAL DESCRIPTION OF EUT

<b>EUT</b>	Portable Tablet Computer
<b>MODEL NO.</b>	Lenovo A7600-H
<b>POWER SUPPLY</b>	5Vdc (adapter or host equipment) 3.7Vdc (Li-ion battery)
<b>MODULATION TYPE</b>	CCK, DQPSK, DBPSK for DSSS 64QAM, 16QAM, QPSK, BPSK for OFDM
<b>MODULATION TECHNOLOGY</b>	DSSS, OFDM
<b>TRANSFER RATE</b>	802.11b:11.0/ 5.5/ 2.0/ 1.0Mbps 802.11g: 54.0/ 48.0/ 36.0/ 24.0/ 18.0/ 12.0/ 9.0/ 6.0Mbps 802.11n: up to MCS7
<b>OPERATING FREQUENCY</b>	2412 ~ 2462MHz
<b>NUMBER OF CHANNEL</b>	11 for 802.11b, 802.11g, 802.11n (20MHz)
<b>OUTPUT POWER</b>	161.808mW
<b>ANTENNA TYPE</b>	Chip antenna with 0.78dBi gain
<b>ANTENNA CONNECTOR</b>	NA
<b>DATA CABLE</b>	Refer to Note as below
<b>I/O PORTS</b>	Refer to user's manual
<b>ACCESSORY DEVICES</b>	Refer to Note as below



**NOTE:**

1. The EUT provides one completed transmitter and one receiver.

MODULATION MODE	TX FUNCTION
802.11b	1TX
802.11g	1TX
802.11n (20MHz)	1TX

2. The EUT has following accessories.

ITEM	BRAND	MODEL	DESCRIPTION
AC Adapter 1	lenovo	C-P62	I/P: 100-240Vac, 50/60Hz, 300mA O/P: 5Vdc, 1500mA Manufacturer: Huntkey
AC Adapter 2	lenovo	C-P62	I/P: 100-240Vac, 50/60Hz, 300mA O/P: 5Vdc, 1500mA Manufacturer: PI
Li-ion Battery	lenovo	L11C2P32	Rating: 3.7Vdc, 6340mAh
USB cable	LUXSHARE	L4QU2005-CS-R	0.7m cable
LCM 1	BOE	BP101WX1-210	--
LCM 2	AUO	B101EAN01.3	--
Camera 1	O-Film	L5648F10	--
Camera 2	Sunny	P5V19K-201	--
Touch Panel 1	O-Film	MCF-101-1325	--
Touch Panel 2	Asia Vital	AP101303	--
eMCP 1	Samsung	KMK8X000VM-B412	--
eMCP 2	Hynix	H9TP18A8JDMCPR-KGM	--

3. The device has 2 configurations as below.

Main Sample (A): LCM 1 + Camera 1 + Touch Panel 1 + eMCP 1

2nd Sample (B): LCM 2 + Camera 2 + Touch Panel 2 + eMCP 2

4. The above EUT information is declared by the manufacturer and for more detailed features description, please refer to the manufacturer's specifications or User's Manual.





A D T

### 3.2 DESCRIPTION OF TEST MODES

11 channels are provided for 802.11b, 802.11g and 802.11n (20MHz):

CHANNEL	FREQUENCY	CHANNEL	FREQUENCY
1	2412MHz	7	2442MHz
2	2417MHz	8	2447MHz
3	2422MHz	9	2452MHz
4	2427MHz	10	2457MHz
5	2432MHz	11	2462MHz
6	2437MHz		

### 3.2.1 TEST MODE APPLICABILITY AND TESTED CHANNEL DETAIL

#### FOR 2.4GHz:

EUT CONFIGURE MODE	APPLICABLE TO				DESCRIPTION
	RE $\geq$ 1G	RE $<$ 1G	PLC	APCM	
A	√	√	√	√	Main Sample
B	√	√	-	-	2nd Sample

Where **RE $\geq$ 1G**: Radiated Emission above 1GHz

**RE $<$ 1G**: Radiated Emission below 1GHz

**PLC**: Power Line Conducted Emission

**APCM**: Antenna Port Conducted Measurement

**NOTE:** The EUT had been pre-tested on the positioned of each 3 axis. The worst case was found when positioned on **Z-plane** for MODE A and **Y-plane** for MODE B.

#### RADIATED EMISSION TEST (ABOVE 1GHz):

- Pre-Scan has been conducted to determine the worst-case mode from all possible combinations between available modulations, data rates and antenna ports (if EUT with antenna diversity architecture).
- Following channel(s) was (were) selected for the final test as listed below.

EUT CONFIGURE MODE	MODE	AVAILABLE CHANNEL	TESTED CHANNEL	MODULATION TECHNOLOGY	MODULATION TYPE	DATA RATE (Mbps)
A	802.11b	1 to 11	1, 6, 11	DSSS	DBPSK	1.0
	802.11g	1 to 11	1, 6, 11	OFDM	BPSK	6.0
	802.11n (20MHz)	1 to 11	1, 6, 11	OFDM	BPSK	MCS0
B	802.11g	1 to 11	1	OFDM	BPSK	6.0

#### RADIATED EMISSION TEST (BELOW 1GHz):

- Pre-Scan has been conducted to determine the worst-case mode from all possible combinations between available modulations, data rates and antenna ports (if EUT with antenna diversity architecture).
- Following channel(s) was (were) selected for the final test as listed below.

EUT CONFIGURE MODE	MODE	AVAILABLE CHANNEL	TESTED CHANNEL	MODULATION TECHNOLOGY	MODULATION TYPE	DATA RATE (Mbps)
A, B	802.11g	1 to 11	1	OFDM	BPSK	6.0

**POWER LINE CONDUCTED EMISSION TEST:**

- Pre-Scan has been conducted to determine the worst-case mode from all possible combinations between available modulations, data rates and antenna ports (if EUT with antenna diversity architecture).
- Following channel(s) was (were) selected for the final test as listed below.

EUT CONFIGURE MODE	MODE	AVAILABLE CHANNEL	TESTED CHANNEL	MODULATION TECHNOLOGY	MODULATION TYPE	DATA RATE (Mbps)
A	802.11n (20MHz)	1 to 11	1	OFDM	BPSK	MCS0

**BANDEGE MEASUREMENT:**

- Pre-Scan has been conducted to determine the worst-case mode from all possible combinations between available modulations, data rates and antenna ports (if EUT with antenna diversity architecture).
- Following channel(s) was (were) selected for the final test as listed below.

EUT CONFIGURE MODE	MODE	AVAILABLE CHANNEL	TESTED CHANNEL	MODULATION TECHNOLOGY	MODULATION TYPE	DATA RATE (Mbps)
A	802.11b	1 to 11	1, 11	DSSS	DBPSK	1.0
	802.11g	1 to 11	1, 11	OFDM	BPSK	6.0
	802.11n (20MHz)	1 to 11	1, 11	OFDM	BPSK	MCS0

**ANTENNA PORT CONDUCTED MEASUREMENT:**

- This item includes all test value of each mode, but only includes spectrum plot of worst value of each mode.
- Pre-Scan has been conducted to determine the worst-case mode from all possible combinations between available modulations, data rates and antenna ports (if EUT with antenna diversity architecture).
- Following channel(s) was (were) selected for the final test as listed below.

EUT CONFIGURE MODE	MODE	AVAILABLE CHANNEL	TESTED CHANNEL	MODULATION TECHNOLOGY	MODULATION TYPE	DATA RATE (Mbps)
A	802.11b	1 to 11	1, 6, 11	DSSS	DBPSK	1.0
	802.11g	1 to 11	1, 6, 11	OFDM	BPSK	6.0
	802.11n (20MHz)	1 to 11	1, 6, 11	OFDM	BPSK	MCS0

**TEST CONDITION:**

APPLICABLE TO	ENVIRONMENTAL CONDITIONS	INPUT POWER	TESTED BY
RE≥1G	25deg. C, 65%RH	120Vac, 60Hz	Kay Wu
RE<1G	25deg. C, 65%RH	120Vac, 60Hz	Kay Wu
PLC	25deg. C, 65%RH	120Vac, 60Hz	Johnson Liao
APCM	25deg. C, 65%RH	120Vac, 60Hz	Howard Kao

**3.3 DESCRIPTION OF SUPPORT UNITS**

The EUT has been tested as an independent unit together with other necessary accessories or support units.

**3.3.1 CONFIGURATION OF SYSTEM UNDER TEST**

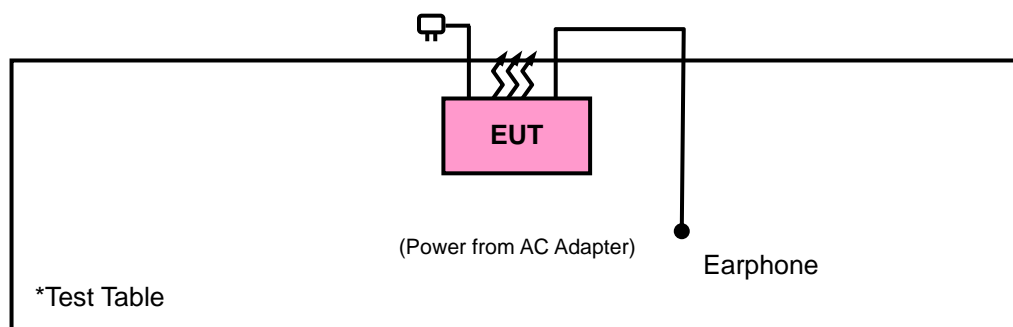

**3.4 GENERAL DESCRIPTION OF APPLIED STANDARDS**

The EUT is a RF Product. According to the specifications of the manufacturer, it must comply with the requirements of the following standards:

**FCC Part 15, Subpart C (15.247)**

ANSI C63.10-2009

558074 D01 DTS Meas Guidance v03r01

All test items have been performed and recorded as per the above standards.

**NOTE:** The EUT is also considered as a kind of computer peripheral, because the connection to computer is necessary for typical use. It has been verified to comply with the requirements of FCC Part 15, Subpart B, Class B. The test report has been issued separately.

## 4. TEST TYPES AND RESULTS (FOR 2.4GHz BAND)

### 4.1 RADIATED EMISSION AND BANDEDGE MEASUREMENT

#### 4.1.1 LIMITS OF RADIATED EMISSION AND BANDEDGE MEASUREMENT

Radiated emissions which fall in the restricted bands must comply with the radiated emission limits specified as below table. Other emissions shall be at least 20dB below the highest level of the desired power:

FREQUENCIES (MHz)	FIELD STRENGTH (microvolts/meter)	MEASUREMENT DISTANCE (meters)
0.009 ~ 0.490	2400/F(kHz)	300
0.490 ~ 1.705	24000/F(kHz)	30
1.705 ~ 30.0	30	30
30 ~ 88	100	3
88 ~ 216	150	3
216 ~ 960	200	3
Above 960	500	3

**NOTE:**

1. The lower limit shall apply at the transition frequencies.
2. Emission level (dBuV/m) = 20 log Emission level (uV/m).
3. For frequencies above 1000MHz, the field strength limits are based on average detector, however, the peak field strength of any emission shall not exceed the maximum permitted average limits, specified above by more than 20dB under any condition of modulation.



A D T

#### 4.1.2 TEST INSTRUMENTS

DESCRIPTION & MANUFACTURER	MODEL NO.	SERIAL NO.	DATE OF CALIBRATION	DUE DATE OF CALIBRATION
Test Receiver ROHDE & SCHWARZ	ESCI	100744	Apr. 15, 2013	Apr. 14, 2014
Spectrum Analyzer ROHDE & SCHWARZ	FSU43	100115	Dec. 18, 2013	Dec. 17, 2014
BILOG Antenna SCHWARZBECK	VULB9168	9168-472	Mar. 25, 2013	Mar. 24, 2014
HORN Antenna SCHWARZBECK	BBHA 9120 D	9120D-209	Sep. 12, 2013	Sep. 11, 2014
HORN Antenna SCHWARZBECK	BBHA 9170	9170-480	Dec. 18, 2013	Dec. 17, 2014
Loop Antenna	HFH2-Z2	100070	Jan. 31, 2012	Jan. 30, 2014
Preamplifier Agilent	8447D	2944A10631	Aug. 30, 2013	Aug. 29, 2014
Preamplifier Agilent	8449B	3008A1960	Aug. 30, 2013	Aug. 29, 2014
Preamplifier EMCI	EMC 330H	980112	Dec. 28, 2012	Dec. 27, 2013
Preamplifier EMCI	EMC 330H	980112	Dec. 27, 2013	Dec. 26, 2014
RF signal cable HUBER+SUHNNER	SUCOFLEX 104	309219/4	Oct. 18, 2013	Oct. 17, 2014
RF signal cable HUBER+SUHNNER	SUCOFLEX 104	250130/4	Oct. 18, 2013	Oct. 17, 2014
RF signal cable Worken	RG-213	NA	Nov. 07, 2013	Nov. 06, 2014
Software BV ADT	E3 6.120103	NA	NA	NA
Antenna Tower MF	MFA-440H	NA	NA	NA
Turn Table MF	MFT-201SS	NA	NA	NA
Antenna Tower & Turn Table Controller MF	MF-7802	NA	NA	NA
Mini-Circuits Power Splitter	ZN2PD-9G	NA	Jul. 18, 2013	Jul. 17, 2014
JFW 20dB attenuation	50HF-020-SMA	NA	NA	NA
Communications Tester-Wireless	E5515C	MY52102544	Sep. 05, 2012	Sep. 04, 2014
Radio Communication Analyzer	MT8820C	6201300640	Aug. 01, 2013	Jul. 31, 2014

- NOTE:** 1. The calibration interval of the above test instruments is 12 months and the calibrations are traceable to NML/ROC and NIST/USA.  
 2. The test was performed in HwaYa Chamber 10.  
 3. The horn antenna and HP preamplifier (model: 8449B) are used only for the measurement of emission frequency above 1GHz if tested.  
 4. The FCC Site Registration No. is 690701.  
 5. The IC Site Registration No. is IC 7450F-10.

#### 4.1.3 TEST PROCEDURES

- a. The EUT was placed on the top of a rotating table 0.8 meters above the ground at a 3 meters semi-anechoic chamber. The table was rotated 360 degrees to determine the position of the highest radiation.
- b. The EUT was set 3 meters away from the interference-receiving antenna, which was mounted on the top of a variable-height antenna tower.
- c. Height of receiving antenna is varied from one meter to four meters above the ground to determine the maximum value of the field strength. Both horizontal and vertical polarizations of the antenna are set to make the measurement.
- d. For each suspected emission, the EUT was arranged to its worst case and then the antenna was tuned to heights from 1 meter to 4 meters and the rotatable table was turned from 0 degrees to 360 degrees to find the maximum reading.
- e. The test-receiver system was set to Peak Detect Function and Specified Bandwidth with Maximum Hold Mode.
- f. If the emission level of the EUT in peak mode was lower than the limit specified, then testing could be stopped and the peak values of the EUT would be reported. Otherwise the emissions would be re-tested one by one using peak, quasi-peak or average method as specified and then reported in a data sheet.

**NOTE:**

1. The resolution bandwidth and video bandwidth of test receiver/spectrum analyzer is 120kHz for Quasi-peak detection at frequency below 1GHz.
2. The resolution bandwidth of test receiver/spectrum analyzer is 1MHz and video bandwidth is 3MHz for Peak detection at frequency above 1GHz.
3. The resolution bandwidth of test receiver/spectrum analyzer is 1MHz and the video bandwidth is 10Hz for Average detection (AV) at frequency above 1GHz.
4. All modes of operation were investigated and the worst-case emissions are reported.

#### 4.1.4 DEVIATION FROM TEST STANDARD

No deviation.

#### 4.1.5 TEST SETUP

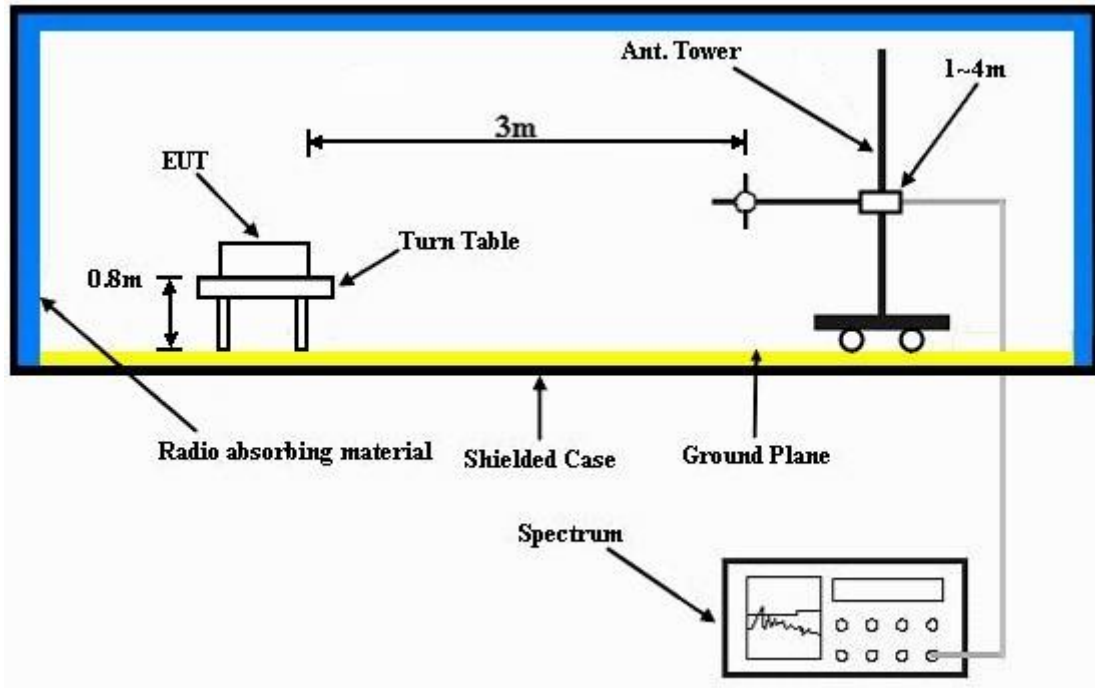

For the actual test configuration, please refer to the attached file (Test Setup Photo).

#### 4.1.6 EUT OPERATING CONDITIONS

- a. Placed the EUT on a testing table.
- b. Use the software to control the EUT under transmission condition continuously at specific channel frequency.





A D T

### 4.1.7 TEST RESULTS

#### MODE A

#### ABOVE 1GHz WORST-CASE DATA

#### 802.11b

EUT TEST CONDITION		MEASUREMENT DETAIL	
CHANNEL	Channel 1	FREQUENCY RANGE	1GHz ~ 25GHz
INPUT POWER (SYSTEM)	120Vac, 60 Hz	DETECTOR FUNCTION	Peak (PK) Average (AV)
ENVIRONMENTAL CONDITIONS	25deg. C, 65%RH	TESTED BY	Kay Wu

ANTENNA POLARITY & TEST DISTANCE: HORIZONTAL AT 3 M										
FREQ. (MHz)	EMISSION LEVEL (dBuV/m)	READ LEVEL (dBuV)	LIMIT (dBuV/m)	MARGIN (dB)	ANTENNA FACTOR (dB/m)	CABLE LOSS (dB)	PREAMP FACTOR (dB)	ANTENNA HEIGHT (cm)	TABLE ANGLE (Degree)	REMARK
2386	44.77	42.93	54	-9.23	31.93	5.4	35.49	114	175	Average
2386	58.01	56.17	74	-15.99	31.93	5.4	35.49	114	175	Peak
2412	105.86	103.94			31.96	5.43	35.47	114	175	Average
2412	108.52	106.6			31.96	5.43	35.47	114	175	Peak
2492	42.2	39.98	54	-11.8	32.1	5.53	35.41	114	175	Average
2492	58.43	56.21	74	-15.57	32.1	5.53	35.41	114	175	Peak
ANTENNA POLARITY & TEST DISTANCE: VERTICAL AT 3 M										
FREQ. (MHz)	EMISSION LEVEL (dBuV/m)	READ LEVEL (dBuV)	LIMIT (dBuV/m)	MARGIN (dB)	ANTENNA FACTOR (dB/m)	CABLE LOSS (dB)	PREAMP FACTOR (dB)	ANTENNA HEIGHT (cm)	TABLE ANGLE (Degree)	REMARK
2334	40.74	39.09	54	-13.26	31.84	5.33	35.52	119	271	Average
2334	57.56	55.91	74	-16.44	31.84	5.33	35.52	119	271	Peak
2412	102.99	101.07			31.96	5.43	35.47	119	271	Average
2412	105.32	103.4			31.96	5.43	35.47	119	271	Peak
2492	42.2	39.98	54	-11.8	32.1	5.53	35.41	119	271	Average
2492	57.67	55.45	74	-16.33	32.1	5.53	35.41	119	271	Peak

#### REMARKS:

- Emission Level = Read Level + Antenna Factor + Cable Loss - Preamp Factor  
Margin Value = Emission Level - Limit Value
- 2412MHz: Fundamental frequency.



A D T

EUT TEST CONDITION		MEASUREMENT DETAIL	
CHANNEL	Channel 6	FREQUENCY RANGE	1GHz ~ 25GHz
INPUT POWER (SYSTEM)	120Vac, 60 Hz	DETECTOR FUNCTION	Peak (PK) Average (AV)
ENVIRONMENTAL CONDITIONS	25deg. C, 65%RH	TESTED BY	Kay Wu

ANTENNA POLARITY & TEST DISTANCE: HORIZONTAL AT 3 M										
FREQ. (MHz)	EMISSION LEVEL (dBuV/m)	READ LEVEL (dBuV)	LIMIT (dBuV/m)	MARGIN (dB)	ANTENNA FACTOR (dB/m)	CABLE LOSS (dB)	PREAMP FACTOR (dB)	ANTENNA HEIGHT (cm)	TABLE ANGLE (Degree)	REMARK
2376	41.78	40	54	-12.22	31.9	5.37	35.49	113	180	Average
2376	58.2	56.42	74	-15.8	31.9	5.37	35.49	113	180	Peak
2437	105.34	103.33			32.01	5.46	35.46	113	180	Average
2437	107.41	105.4			32.01	5.46	35.46	113	180	Peak
2500	43.2	40.98	54	-10.8	32.1	5.53	35.41	113	180	Average
2500	58.74	56.52	74	-15.26	32.1	5.53	35.41	113	180	Peak
ANTENNA POLARITY & TEST DISTANCE: VERTICAL AT 3 M										
FREQ. (MHz)	EMISSION LEVEL (dBuV/m)	READ LEVEL (dBuV)	LIMIT (dBuV/m)	MARGIN (dB)	ANTENNA FACTOR (dB/m)	CABLE LOSS (dB)	PREAMP FACTOR (dB)	ANTENNA HEIGHT (cm)	TABLE ANGLE (Degree)	REMARK
2386	41.9	40.06	54	-12.1	31.93	5.4	35.49	118	278	Average
2386	57.17	55.33	74	-16.83	31.93	5.4	35.49	118	278	Peak
2437	103.78	101.77			32.01	5.46	35.46	118	278	Average
2437	105.58	103.57			32.01	5.46	35.46	118	278	Peak
2488	42.19	39.98	54	-11.81	32.1	5.53	35.42	118	278	Average
2488	57.57	55.36	74	-16.43	32.1	5.53	35.42	118	278	Peak

**REMARKS:**

- Emission Level = Read Level + Antenna Factor + Cable Loss - Preamp Factor  
Margin Value = Emission Level - Limit Value
- 2437MHz: Fundamental frequency.



A D T

EUT TEST CONDITION		MEASUREMENT DETAIL	
CHANNEL	Channel 11	FREQUENCY RANGE	1GHz ~ 25GHz
INPUT POWER (SYSTEM)	120Vac, 60 Hz	DETECTOR FUNCTION	Peak (PK) Average (AV)
ENVIRONMENTAL CONDITIONS	25deg. C, 65%RH	TESTED BY	Kay Wu

ANTENNA POLARITY & TEST DISTANCE: HORIZONTAL AT 3 M										
FREQ. (MHz)	EMISSION LEVEL (dBuV/m)	READ LEVEL (dBuV)	LIMIT (dBuV/m)	MARGIN (dB)	ANTENNA FACTOR (dB/m)	CABLE LOSS (dB)	PREAMP FACTOR (dB)	ANTENNA HEIGHT (cm)	TABLE ANGLE (Degree)	REMARK
2364	40.48	38.71	54	-13.52	31.9	5.37	35.5	113	175	Average
2364	57.48	55.71	74	-16.52	31.9	5.37	35.5	113	175	Peak
2462	106.4	104.3			32.04	5.5	35.44	113	175	Average
2462	108.89	106.79			32.04	5.5	35.44	113	175	Peak
2483.5	43.29	41.14	54	-10.71	32.07	5.5	35.42	113	175	Average
2483.5	58.64	56.49	74	-15.36	32.07	5.5	35.42	113	175	Peak
ANTENNA POLARITY & TEST DISTANCE: VERTICAL AT 3 M										
FREQ. (MHz)	EMISSION LEVEL (dBuV/m)	READ LEVEL (dBuV)	LIMIT (dBuV/m)	MARGIN (dB)	ANTENNA FACTOR (dB/m)	CABLE LOSS (dB)	PREAMP FACTOR (dB)	ANTENNA HEIGHT (cm)	TABLE ANGLE (Degree)	REMARK
2318	41.64	40.05	54	-12.36	31.81	5.3	35.52	115	274	Average
2318	57.76	56.17	74	-16.24	31.81	5.3	35.52	115	274	Peak
2462	104.24	102.14			32.04	5.5	35.44	115	274	Average
2462	106.6	104.5			32.04	5.5	35.44	115	274	Peak
2484	46.15	43.97	54	-7.85	32.1	5.5	35.42	115	274	Average
2484	60.2	58.02	74	-13.8	32.1	5.5	35.42	115	274	Peak

**REMARKS:**

- Emission Level = Read Level + Antenna Factor + Cable Loss - Preamp Factor  
Margin Value = Emission Level - Limit Value
- 2462MHz: Fundamental frequency.



802.11g

EUT TEST CONDITION		MEASUREMENT DETAIL	
CHANNEL	Channel 1	FREQUENCY RANGE	1GHz ~ 25GHz
INPUT POWER (SYSTEM)	120Vac, 60 Hz	DETECTOR FUNCTION	Peak (PK) Average (AV)
ENVIRONMENTAL CONDITIONS	25deg. C, 65%RH	TESTED BY	Kay Wu

**ANTENNA POLARITY & TEST DISTANCE: HORIZONTAL AT 3 M**

FREQ. (MHz)	EMISSION LEVEL (dBuV/m)	READ LEVEL (dBuV)	LIMIT (dBuV/m)	MARGIN (dB)	ANTENNA FACTOR (dB/m)	CABLE LOSS (dB)	PREAMP FACTOR (dB)	ANTENNA HEIGHT (cm)	TABLE ANGLE (Degree)	REMARK
2390	52.88	51.02	54	-1.12	31.93	5.4	35.47	117	176	Average
2390	69.18	67.32	74	-4.82	31.93	5.4	35.47	117	176	Peak
2412	100.06	98.14			31.96	5.43	35.47	117	176	Average
2412	107.13	105.21			31.96	5.43	35.47	117	176	Peak
2498	40.16	37.94	54	-13.84	32.1	5.53	35.41	117	176	Average
2498	58.46	56.24	74	-15.54	32.1	5.53	35.41	117	176	Peak

**ANTENNA POLARITY & TEST DISTANCE: VERTICAL AT 3 M**

FREQ. (MHz)	EMISSION LEVEL (dBuV/m)	READ LEVEL (dBuV)	LIMIT (dBuV/m)	MARGIN (dB)	ANTENNA FACTOR (dB/m)	CABLE LOSS (dB)	PREAMP FACTOR (dB)	ANTENNA HEIGHT (cm)	TABLE ANGLE (Degree)	REMARK
2390	46.01	44.15	54	-7.99	31.93	5.4	35.47	102	284	Average
2390	61.09	59.23	74	-12.91	31.93	5.4	35.47	102	284	Peak
2412	95.64	93.72			31.96	5.43	35.47	102	284	Average
2412	103.11	101.19			31.96	5.43	35.47	102	284	Peak
2492	41.19	38.97	54	-12.81	32.1	5.53	35.41	102	284	Average
2492	57.72	55.5	74	-16.28	32.1	5.53	35.41	102	284	Peak

**REMARKS:**

- Emission Level = Read Level + Antenna Factor + Cable Loss - Preamp Factor  
Margin Value = Emission Level - Limit Value
- 2412MHz: Fundamental frequency.



A D T

EUT TEST CONDITION		MEASUREMENT DETAIL	
CHANNEL	Channel 6	FREQUENCY RANGE	1GHz ~ 25GHz
INPUT POWER (SYSTEM)	120Vac, 60 Hz	DETECTOR FUNCTION	Peak (PK) Average (AV)
ENVIRONMENTAL CONDITIONS	25deg. C, 65%RH	TESTED BY	Kay Wu

ANTENNA POLARITY & TEST DISTANCE: HORIZONTAL AT 3 M										
FREQ. (MHz)	EMISSION LEVEL (dBuV/m)	READ LEVEL (dBuV)	LIMIT (dBuV/m)	MARGIN (dB)	ANTENNA FACTOR (dB/m)	CABLE LOSS (dB)	PREAMP FACTOR (dB)	ANTENNA HEIGHT (cm)	TABLE ANGLE (Degree)	REMARK
2386	42.9	41.06	54	-11.1	31.93	5.4	35.49	112	178	Average
2386	58.23	56.39	74	-15.77	31.93	5.4	35.49	112	178	Peak
2437	100.86	98.85			32.01	5.46	35.46	112	178	Average
2437	108.95	106.94			32.01	5.46	35.46	112	178	Peak
2484	42.16	39.98	54	-11.84	32.1	5.5	35.42	112	178	Average
2484	59.65	57.47	74	-14.35	32.1	5.5	35.42	112	178	Peak
ANTENNA POLARITY & TEST DISTANCE: VERTICAL AT 3 M										
FREQ. (MHz)	EMISSION LEVEL (dBuV/m)	READ LEVEL (dBuV)	LIMIT (dBuV/m)	MARGIN (dB)	ANTENNA FACTOR (dB/m)	CABLE LOSS (dB)	PREAMP FACTOR (dB)	ANTENNA HEIGHT (cm)	TABLE ANGLE (Degree)	REMARK
2388	43.89	42.05	54	-10.11	31.93	5.4	35.49	121	285	Average
2388	60.1	58.26	74	-13.9	31.93	5.4	35.49	121	285	Peak
2437	98.02	96.01			32.01	5.46	35.46	121	285	Average
2437	105.48	103.47			32.01	5.46	35.46	121	285	Peak
2494	41.2	38.98	54	-12.8	32.1	5.53	35.41	121	285	Average
2494	59.16	56.94	74	-14.84	32.1	5.53	35.41	121	285	Peak

**REMARKS:**

- Emission Level = Read Level + Antenna Factor + Cable Loss - Preamp Factor  
Margin Value = Emission Level - Limit Value
- 2437MHz: Fundamental frequency.



A D T

EUT TEST CONDITION		MEASUREMENT DETAIL	
CHANNEL	Channel 11	FREQUENCY RANGE	1GHz ~ 25GHz
INPUT POWER (SYSTEM)	120Vac, 60 Hz	DETECTOR FUNCTION	Peak (PK) Average (AV)
ENVIRONMENTAL CONDITIONS	25deg. C, 65%RH	TESTED BY	Kay Wu

ANTENNA POLARITY & TEST DISTANCE: HORIZONTAL AT 3 M										
FREQ. (MHz)	EMISSION LEVEL (dBuV/m)	READ LEVEL (dBuV)	LIMIT (dBuV/m)	MARGIN (dB)	ANTENNA FACTOR (dB/m)	CABLE LOSS (dB)	PREAMP FACTOR (dB)	ANTENNA HEIGHT (cm)	TABLE ANGLE (Degree)	REMARK
2380	39.83	38.05	54	-14.17	31.9	5.37	35.49	113	181	Average
2380	58.51	56.73	74	-15.49	31.9	5.37	35.49	113	181	Peak
2462	100.13	98.03			32.04	5.5	35.44	113	181	Average
2462	107.78	105.68			32.04	5.5	35.44	113	181	Peak
2483.5	51.6	49.45	54	-2.4	32.07	5.5	35.42	113	181	Average
2483.5	72.11	69.96	74	-1.89	32.07	5.5	35.42	113	181	Peak
ANTENNA POLARITY & TEST DISTANCE: VERTICAL AT 3 M										
FREQ. (MHz)	EMISSION LEVEL (dBuV/m)	READ LEVEL (dBuV)	LIMIT (dBuV/m)	MARGIN (dB)	ANTENNA FACTOR (dB/m)	CABLE LOSS (dB)	PREAMP FACTOR (dB)	ANTENNA HEIGHT (cm)	TABLE ANGLE (Degree)	REMARK
2362	40.35	38.61	54	-13.65	31.87	5.37	35.5	100	284	Average
2362	58.18	56.44	74	-15.82	31.87	5.37	35.5	100	284	Peak
2462	96.03	93.93			32.04	5.5	35.44	100	284	Average
2462	104	101.9			32.04	5.5	35.44	100	284	Peak
2483.5	48.06	45.91	54	-5.94	32.07	5.5	35.42	100	284	Average
2483.5	66.06	63.91	74	-7.94	32.07	5.5	35.42	100	284	Peak

**REMARKS:**

- Emission Level = Read Level + Antenna Factor + Cable Loss - Preamp Factor  
Margin Value = Emission Level - Limit Value
- 2462MHz: Fundamental frequency.



802.11n (20MHz)

EUT TEST CONDITION		MEASUREMENT DETAIL	
CHANNEL	Channel 1	FREQUENCY RANGE	1GHz ~ 25GHz
INPUT POWER (SYSTEM)	120Vac, 60 Hz	DETECTOR FUNCTION	Peak (PK) Average (AV)
ENVIRONMENTAL CONDITIONS	25deg. C, 65%RH	TESTED BY	Kay Wu

**ANTENNA POLARITY & TEST DISTANCE: HORIZONTAL AT 3 M**

FREQ. (MHz)	EMISSION LEVEL (dBuV/m)	READ LEVEL (dBuV)	LIMIT (dBuV/m)	MARGIN (dB)	ANTENNA FACTOR (dB/m)	CABLE LOSS (dB)	PREAMP FACTOR (dB)	ANTENNA HEIGHT (cm)	TABLE ANGLE (Degree)	REMARK
2390	50.69	48.83	54	-3.31	31.93	5.4	35.47	116	172	Average
2390	69.63	67.77	74	-4.37	31.93	5.4	35.47	116	172	Peak
2412	99.03	97.11			31.96	5.43	35.47	116	172	Average
2412	106.79	104.87			31.96	5.43	35.47	116	172	Peak
2492	41.19	38.97	54	-12.81	32.1	5.53	35.41	116	172	Average
2492	60.38	58.16	74	-13.62	32.1	5.53	35.41	116	172	Peak

**ANTENNA POLARITY & TEST DISTANCE: VERTICAL AT 3 M**

FREQ. (MHz)	EMISSION LEVEL (dBuV/m)	READ LEVEL (dBuV)	LIMIT (dBuV/m)	MARGIN (dB)	ANTENNA FACTOR (dB/m)	CABLE LOSS (dB)	PREAMP FACTOR (dB)	ANTENNA HEIGHT (cm)	TABLE ANGLE (Degree)	REMARK
2390	47.96	46.1	54	-6.04	31.93	5.4	35.47	118	272	Average
2390	65.24	63.38	74	-8.76	31.93	5.4	35.47	118	272	Peak
2412	96.76	94.84			31.96	5.43	35.47	118	272	Average
2412	104.52	102.6			31.96	5.43	35.47	118	272	Peak
2484	40.85	38.67	54	-13.15	32.1	5.5	35.42	118	272	Average
2484	57.66	55.48	74	-16.34	32.1	5.5	35.42	118	272	Peak

**REMARKS:**

- Emission Level = Read Level + Antenna Factor + Cable Loss - Preamp Factor  
Margin Value = Emission Level - Limit Value
- 2412MHz: Fundamental frequency.



A D T

EUT TEST CONDITION		MEASUREMENT DETAIL	
CHANNEL	Channel 6	FREQUENCY RANGE	1GHz ~ 25GHz
INPUT POWER (SYSTEM)	120Vac, 60 Hz	DETECTOR FUNCTION	Peak (PK) Average (AV)
ENVIRONMENTAL CONDITIONS	25deg. C, 65%RH	TESTED BY	Kay Wu

ANTENNA POLARITY & TEST DISTANCE: HORIZONTAL AT 3 M										
FREQ. (MHz)	EMISSION LEVEL (dBuV/m)	READ LEVEL (dBuV)	LIMIT (dBuV/m)	MARGIN (dB)	ANTENNA FACTOR (dB/m)	CABLE LOSS (dB)	PREAMP FACTOR (dB)	ANTENNA HEIGHT (cm)	TABLE ANGLE (Degree)	REMARK
2386	40.85	39.01	54	-13.15	31.93	5.4	35.49	113	182	Average
2386	59.09	57.25	74	-14.91	31.93	5.4	35.49	113	182	Peak
2437	98.14	96.13			32.01	5.46	35.46	113	182	Average
2437	106.46	104.45			32.01	5.46	35.46	113	182	Peak
2496	40.86	38.64	54	-13.14	32.1	5.53	35.41	113	182	Average
2496	59.21	56.99	74	-14.79	32.1	5.53	35.41	113	182	Peak
ANTENNA POLARITY & TEST DISTANCE: VERTICAL AT 3 M										
FREQ. (MHz)	EMISSION LEVEL (dBuV/m)	READ LEVEL (dBuV)	LIMIT (dBuV/m)	MARGIN (dB)	ANTENNA FACTOR (dB/m)	CABLE LOSS (dB)	PREAMP FACTOR (dB)	ANTENNA HEIGHT (cm)	TABLE ANGLE (Degree)	REMARK
2334	40.73	39.08	54	-13.27	31.84	5.33	35.52	115	273	Average
2334	57.61	55.96	74	-16.39	31.84	5.33	35.52	115	273	Peak
2437	96.93	94.92			32.01	5.46	35.46	115	273	Average
2437	104.31	102.3			32.01	5.46	35.46	115	273	Peak
2490	41.78	39.57	54	-12.22	32.1	5.53	35.42	115	273	Average
2490	58.33	56.12	74	-15.67	32.1	5.53	35.42	115	273	Peak

**REMARKS:**

- Emission Level = Read Level + Antenna Factor + Cable Loss - Preamp Factor  
Margin Value = Emission Level - Limit Value
- 2437MHz: Fundamental frequency.





A D T

EUT TEST CONDITION		MEASUREMENT DETAIL	
CHANNEL	Channel 11	FREQUENCY RANGE	1GHz ~ 25GHz
INPUT POWER (SYSTEM)	120Vac, 60 Hz	DETECTOR FUNCTION	Peak (PK) Average (AV)
ENVIRONMENTAL CONDITIONS	25deg. C, 65%RH	TESTED BY	Kay Wu

ANTENNA POLARITY & TEST DISTANCE: HORIZONTAL AT 3 M										
FREQ. (MHz)	EMISSION LEVEL (dBuV/m)	READ LEVEL (dBuV)	LIMIT (dBuV/m)	MARGIN (dB)	ANTENNA FACTOR (dB/m)	CABLE LOSS (dB)	PREAMP FACTOR (dB)	ANTENNA HEIGHT (cm)	TABLE ANGLE (Degree)	REMARK
2346	39.73	38.03	54	-14.27	31.87	5.33	35.5	112	179	Average
2346	57.78	56.08	74	-16.22	31.87	5.33	35.5	112	179	Peak
2462	99.43	97.33			32.04	5.5	35.44	112	179	Average
2462	106.35	104.25			32.04	5.5	35.44	112	179	Peak
2483.5	52.12	49.97	54	-1.88	32.07	5.5	35.42	112	179	Average
2483.5	69.97	67.82	74	-4.03	32.07	5.5	35.42	112	179	Peak
ANTENNA POLARITY & TEST DISTANCE: VERTICAL AT 3 M										
FREQ. (MHz)	EMISSION LEVEL (dBuV/m)	READ LEVEL (dBuV)	LIMIT (dBuV/m)	MARGIN (dB)	ANTENNA FACTOR (dB/m)	CABLE LOSS (dB)	PREAMP FACTOR (dB)	ANTENNA HEIGHT (cm)	TABLE ANGLE (Degree)	REMARK
2362	40.8	39.06	54	-13.2	31.87	5.37	35.5	113	277	Average
2362	55.92	54.18	74	-18.08	31.87	5.37	35.5	113	277	Peak
2462	98.4	96.3			32.04	5.5	35.44	113	277	Average
2462	104.77	102.67			32.04	5.5	35.44	113	277	Peak
2483.5	49.09	46.94	54	-4.91	32.07	5.5	35.42	113	277	Average
2483.5	67.25	65.1	74	-6.75	32.07	5.5	35.42	113	277	Peak

**REMARKS:**

- Emission Level = Read Level + Antenna Factor + Cable Loss - Preamp Factor  
Margin Value = Emission Level - Limit Value
- 2462MHz: Fundamental frequency.



A D T

**BELOW 1GHz WORST-CASE DATA: 802.11g**

EUT TEST CONDITION		MEASUREMENT DETAIL	
CHANNEL	Channel 1	FREQUENCY RANGE	30MHz ~ 1GHz
INPUT POWER (SYSTEM)	120Vac, 60 Hz	DETECTOR FUNCTION	Peak (PK) QP
ENVIRONMENTAL CONDITIONS	25deg. C, 65%RH	TESTED BY	Kay Wu

ANTENNA POLARITY & TEST DISTANCE: HORIZONTAL AT 3 M										
FREQ. (MHz)	EMISSION LEVEL (dBuV/m)	READ LEVEL (dBuV)	LIMIT (dBuV/m)	MARGIN (dB)	ANTENNA FACTOR (dB/m)	CABLE LOSS (dB)	PREAMP FACTOR (dB)	ANTENNA HEIGHT (cm)	TABLE ANGLE (Degree)	REMARK
71.31	17.04	40.01	40	-22.96	8.14	1.11	32.22	166	215	Peak
109.65	26.57	48.12	43.5	-16.93	9.42	1.28	32.25	154	188	Peak
115.05	23.54	45.46	43.5	-19.96	9.05	1.28	32.25	102	225	Peak
310.5	27.92	43.42	46	-18.08	14.51	2.11	32.12	156	220	Peak
428.1	21.35	33.37	46	-24.65	17.75	2.41	32.18	106	30	Peak
521.2	21.88	30.81	46	-24.12	20.51	2.7	32.14	155	114	Peak
ANTENNA POLARITY & TEST DISTANCE: VERTICAL AT 3 M										
FREQ. (MHz)	EMISSION LEVEL (dBuV/m)	READ LEVEL (dBuV)	LIMIT (dBuV/m)	MARGIN (dB)	ANTENNA FACTOR (dB/m)	CABLE LOSS (dB)	PREAMP FACTOR (dB)	ANTENNA HEIGHT (cm)	TABLE ANGLE (Degree)	REMARK
47.82	31.14	53.98	40	-8.86	8.48	0.9	32.22	162	218	Peak
104.79	24.4	45.82	43.5	-19.1	9.56	1.28	32.26	157	82	Peak
232.77	20.63	38.7	46	-25.37	12.25	1.85	32.17	165	226	Peak
388.9	18.92	31.42	46	-27.08	17.35	2.34	32.19	165	259	Peak
465.9	24.65	35.68	46	-21.35	18.54	2.56	32.13	105	225	Peak
693.4	24.77	30.57	46	-21.23	23.19	3.11	32.1	185	215	Peak

**REMARKS:**

- Emission Level = Read Level + Antenna Factor + Cable Loss - Preamp Factor  
Margin Value = Emission Level - Limit Value



A D T

**MODE B**

**ABOVE 1GHz WORST-CASE DATA: 802.11g**

EUT TEST CONDITION		MEASUREMENT DETAIL	
CHANNEL	Channel 1	FREQUENCY RANGE	1GHz ~ 25GHz
INPUT POWER (SYSTEM)	120Vac, 60 Hz	DETECTOR FUNCTION	Peak (PK) Average (AV)
ENVIRONMENTAL CONDITIONS	25deg. C, 65%RH	TESTED BY	Kay Wu

ANTENNA POLARITY & TEST DISTANCE: HORIZONTAL AT 3 M										
FREQ. (MHz)	EMISSION LEVEL (dBuV/m)	READ LEVEL (dBuV)	LIMIT (dBuV/m)	MARGIN (dB)	ANTENNA FACTOR (dB/m)	CABLE LOSS (dB)	PREAMP FACTOR (dB)	ANTENNA HEIGHT (cm)	TABLE ANGLE (Degree)	REMARK
2390	47.19	45.33	54	-6.81	31.93	5.4	35.47	177	22	Average
2390	61.15	59.29	74	-12.85	31.93	5.4	35.47	177	22	Peak
2412	93.62	91.7			31.96	5.43	35.47	177	22	Average
2412	101.79	99.87			31.96	5.43	35.47	177	22	Peak
2488	41.16	38.95	54	-12.84	32.1	5.53	35.42	177	22	Average
2488	55.6	53.39	74	-18.4	32.1	5.53	35.42	177	22	Peak
ANTENNA POLARITY & TEST DISTANCE: VERTICAL AT 3 M										
FREQ. (MHz)	EMISSION LEVEL (dBuV/m)	READ LEVEL (dBuV)	LIMIT (dBuV/m)	MARGIN (dB)	ANTENNA FACTOR (dB/m)	CABLE LOSS (dB)	PREAMP FACTOR (dB)	ANTENNA HEIGHT (cm)	TABLE ANGLE (Degree)	REMARK
2390	51.58	49.72	54	-2.42	31.93	5.4	35.47	120	80	Average
2390	66.55	64.69	74	-7.45	31.93	5.4	35.47	120	80	Peak
2412	98.67	96.75			31.96	5.43	35.47	120	80	Average
2412	106.53	104.61			31.96	5.43	35.47	120	80	Peak
2492	41.16	38.94	54	-12.84	32.1	5.53	35.41	120	80	Average
2492	56.76	54.54	74	-17.24	32.1	5.53	35.41	120	80	Peak

**REMARKS:**

- Emission Level = Read Level + Antenna Factor + Cable Loss - Preamp Factor  
Margin Value = Emission Level - Limit Value
- 2412MHz: Fundamental frequency.



A D T

**BELOW 1GHz WORST-CASE DATA: 802.11g**

EUT TEST CONDITION		MEASUREMENT DETAIL	
CHANNEL	Channel 1	FREQUENCY RANGE	30MHz ~ 1GHz
INPUT POWER (SYSTEM)	120Vac, 60 Hz	DETECTOR FUNCTION	Peak (PK) QP
ENVIRONMENTAL CONDITIONS	25deg. C, 65%RH	TESTED BY	Kay Wu

ANTENNA POLARITY & TEST DISTANCE: HORIZONTAL AT 3 M										
FREQ. (MHz)	EMISSION LEVEL (dBuV/m)	READ LEVEL (dBuV)	LIMIT (dBuV/m)	MARGIN (dB)	ANTENNA FACTOR (dB/m)	CABLE LOSS (dB)	PREAMP FACTOR (dB)	ANTENNA HEIGHT (cm)	TABLE ANGLE (Degree)	REMARK
99.93	22.57	43.89	43.5	-20.93	9.66	1.28	32.26	156	215	Peak
145.83	15.88	36.98	43.5	-27.62	9.79	1.38	32.27	133	265	Peak
213.06	20.23	39.37	43.5	-23.27	11.45	1.65	32.24	100	215	Peak
415.5	18.78	30.72	46	-27.22	17.85	2.41	32.2	166	215	Peak
513.5	20.96	30.44	46	-25.04	19.94	2.7	32.12	103	221	Peak
683.6	24.24	30.03	46	-21.76	23.27	3.05	32.11	117	154	Peak
ANTENNA POLARITY & TEST DISTANCE: VERTICAL AT 3 M										
FREQ. (MHz)	EMISSION LEVEL (dBuV/m)	READ LEVEL (dBuV)	LIMIT (dBuV/m)	MARGIN (dB)	ANTENNA FACTOR (dB/m)	CABLE LOSS (dB)	PREAMP FACTOR (dB)	ANTENNA HEIGHT (cm)	TABLE ANGLE (Degree)	REMARK
32.16	28.39	43.7	40	-11.61	16.21	0.74	32.26	155	215	Peak
48.36	22.93	45.94	40	-17.07	8.31	0.9	32.22	165	216	Peak
95.61	17.26	38.68	43.5	-26.24	9.34	1.28	32.04	157	188	Peak
400.8	18.82	30.64	46	-27.18	18.06	2.34	32.22	166	215	Peak
587	21.67	30.44	46	-24.33	20.6	2.82	32.19	132	115	Peak
719.3	24.74	30.38	46	-21.26	23.31	3.16	32.11	102	111	Peak

**REMARKS:**

- Emission Level = Read Level + Antenna Factor + Cable Loss - Preamp Factor  
Margin Value = Emission Level - Limit Value

## 4.2 CONDUCTED EMISSION MEASUREMENT

### 4.2.1 LIMITS OF CONDUCTED EMISSION MEASUREMENT

FREQUENCY OF EMISSION (MHz)	CONDUCTED LIMIT (dB $\mu$ V)	
	Quasi-peak	Average
0.15 ~ 0.5	66 to 56	56 to 46
0.5 ~ 5	56	46
5 ~ 30	60	50

- NOTE:**
1. The lower limit shall apply at the transition frequencies.
  2. The limit decreases in line with the logarithm of the frequency in the range of 0.15 to 0.50MHz.
  3. All emanations from a class A/B digital device or system, including any network of conductors and apparatus connected thereto, shall not exceed the level of field strengths specified above.

### 4.2.2 TEST INSTRUMENTS

Test Date: Jan. 07, 2014

DESCRIPTION & MANUFACTURER	MODEL NO.	SERIAL NO.	DATE OF CALIBRATION	DUE DATE OF CALIBRATION
Test Receiver ROHDE & SCHWARZ	ESCS30	100288	Nov. 17, 2013	Nov. 16, 2014
RF signal cable Woken	5D-FB	Cable-HYCO2-01	Dec. 27, 2013	Dec. 26, 2014
LISN ROHDE & SCHWARZ (EUT)	ESH2-Z5	100100	Dec. 23, 2013	Dec. 22, 2014
LISN ROHDE & SCHWARZ (Peripheral)	ESH3-Z5	100312	Jul. 08, 2013	Jul. 07, 2014
Software ADT	BV ADT_Cond_ V7.3.7.3	NA	NA	NA

- NOTE:**
1. The calibration interval of the above test instruments is 12 months and the calibrations are traceable to NML/ROC and NIST/USA.
  2. The test was performed in HwaYa Shielded Room 2.
  3. The VCCI Site Registration No. is C-2047.



A D T

#### 4.2.3 TEST PROCEDURES

- a. The EUT was placed 0.4 meters from the conducting wall of the shielded room with EUT being connected to the power mains through a line impedance stabilization network (LISN). Other support units were connected to the power mains through another LISN. The two LISNs provide 50 ohm/ 50uH of coupling impedance for the measuring instrument.
- b. Both lines of the power mains connected to the EUT were checked for maximum conducted interference.
- c. The frequency range from 150kHz to 30MHz was searched. Emission levels under (Limit - 20dB) was not recorded.

**NOTE:** All modes of operation were investigated and the worst-case emissions are reported.

#### 4.2.4 DEVIATION FROM TEST STANDARD

No deviation.

#### 4.2.5 TEST SETUP

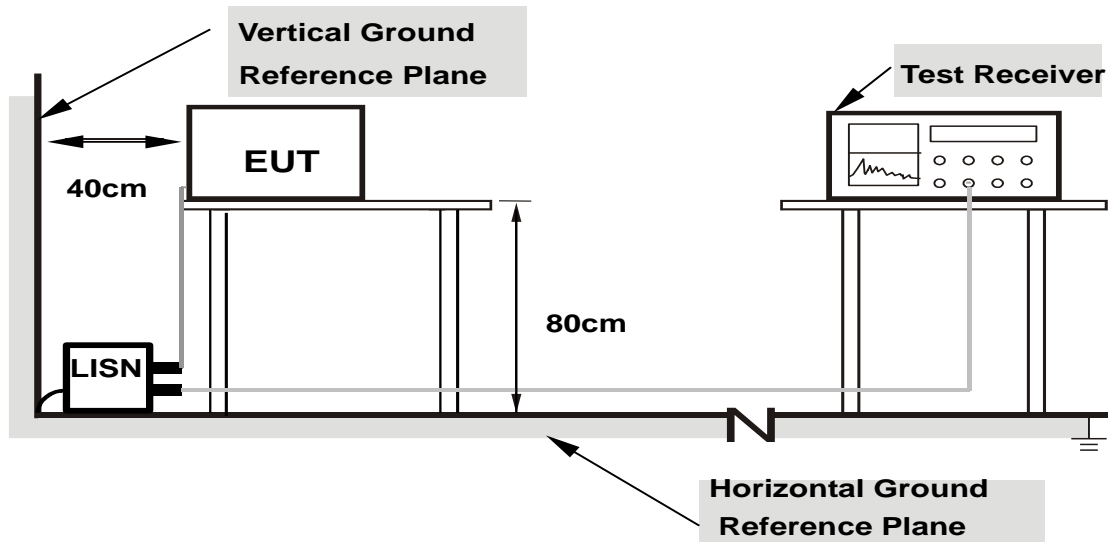

- Note:**
1. Support units were connected to second LISN.
  2. Both of LISNs (AMN) are 80 cm from EUT and at least 80 from other units and other metal planes

For the actual test configuration, please refer to the attached file (Test Setup Photo).

#### 4.2.6 EUT OPERATING CONDITIONS

Same as 4.1.6.

### 4.2.7 TEST RESULTS

#### CONDUCTED WORST-CASE DATA :

PHASE	Line 1	6dB BANDWIDTH	9kHz
-------	--------	---------------	------

No	Freq. [MHz]	Corr. Factor (dB)	Reading Value		Emission Level		Limit		Margin	
			[dB (uV)]		[dB (uV)]		[dB (uV)]		(dB)	
			Q.P.	AV.	Q.P.	AV.	Q.P.	AV.	Q.P.	AV.
1	0.20078	0.28	37.88	28.93	38.16	29.21	63.58	53.58	-25.42	-24.37
2	0.65781	0.32	34.18	19.03	34.50	19.35	56.00	46.00	-21.50	-26.65
3	1.64063	0.35	34.05	17.48	34.40	17.83	56.00	46.00	-21.60	-28.17
4	3.13672	0.40	41.37	28.52	41.77	28.92	56.00	46.00	-14.23	-17.08
5	4.30859	0.43	32.57	16.42	33.00	16.85	56.00	46.00	-23.00	-29.15
6	14.42969	0.53	22.37	13.58	22.90	14.11	60.00	50.00	-37.10	-35.89

#### REMARKS:

1. Q.P. and AV. are abbreviations of quasi-peak and average individually.
2. The emission levels of other frequencies were very low against the limit.
3. Margin value = Emission level - Limit value
4. Correction factor = Insertion loss + Cable loss
5. Emission Level = Correction Factor + Reading Value

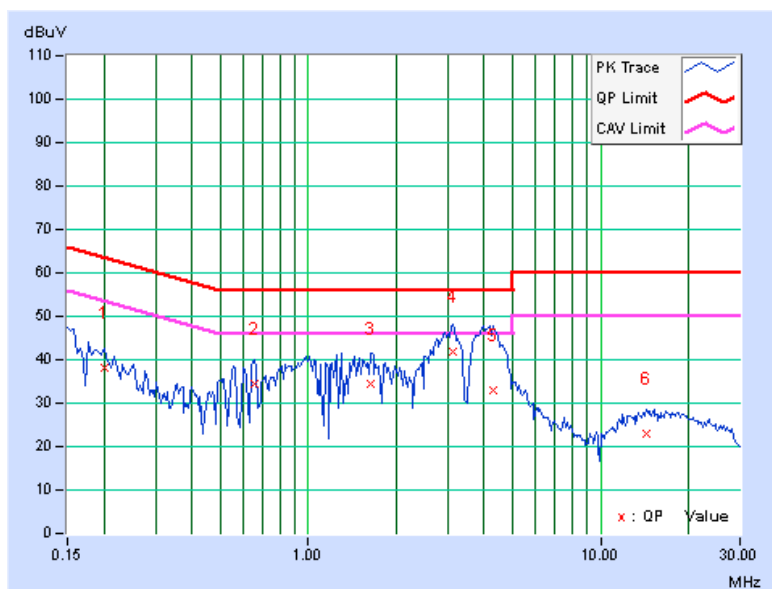





A D T

PHASE	Line 2	6dB BANDWIDTH	9kHz
-------	--------	---------------	------

No	Freq. [MHz]	Corr. Factor (dB)	Reading Value [dB (uV)]		Emission Level [dB (uV)]		Limit [dB (uV)]		Margin (dB)	
			Q.P.	AV.	Q.P.	AV.	Q.P.	AV.	Q.P.	AV.
			1	0.23203	0.28	36.83	19.91	37.11	20.19	62.38
2	<b>0.55625</b>	<b>0.31</b>	<b>37.58</b>	<b>35.55</b>	<b>37.89</b>	<b>35.86</b>	<b>56.00</b>	<b>46.00</b>	<b>-18.11</b>	<b>-10.14</b>
3	0.99375	0.34	25.42	15.77	25.76	16.11	56.00	46.00	-30.24	-29.89
4	3.35938	0.42	28.62	17.17	29.04	17.59	56.00	46.00	-26.96	-28.41
5	4.18750	0.44	37.38	20.98	37.82	21.42	56.00	46.00	-18.18	-24.58
6	13.96484	0.56	26.26	19.41	26.82	19.97	60.00	50.00	-33.18	-30.03

**REMARKS:**

1. Q.P. and AV. are abbreviations of quasi-peak and average individually.
2. The emission levels of other frequencies were very low against the limit.
3. Margin value = Emission level - Limit value
4. Correction factor = Insertion loss + Cable loss
5. Emission Level = Correction Factor + Reading Value

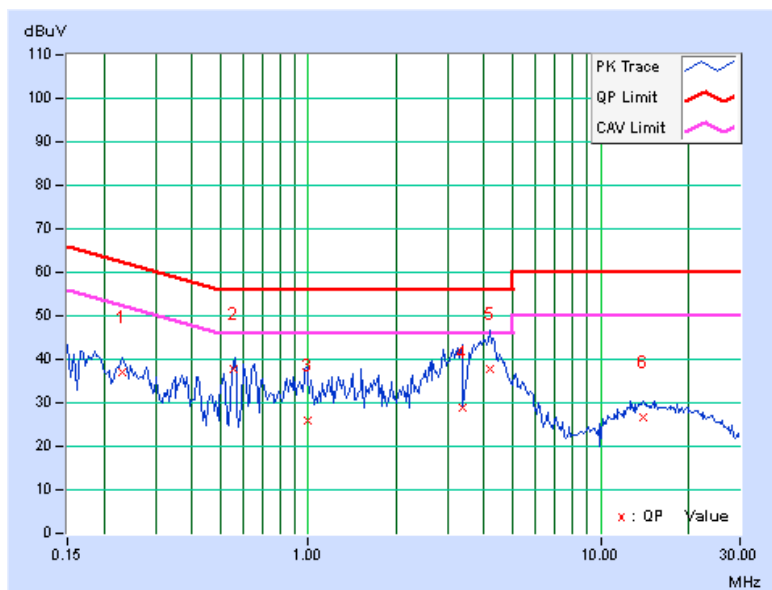

### 4.3 6dB BANDWIDTH MEASUREMENT

#### 4.3.1 LIMITS OF 6dB BANDWIDTH MEASUREMENT

The minimum of 6dB Bandwidth Measurement is 0.5 MHz.

#### 4.3.2 TEST SETUP

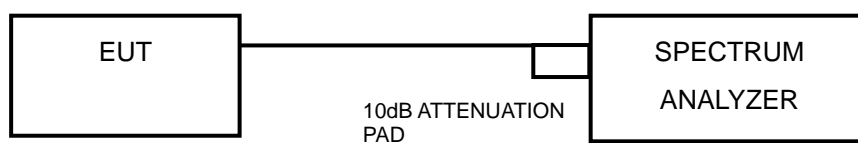

#### 4.3.3 TEST INSTRUMENTS

Refer to section 4.1.2 to get information of above instrument.

#### 4.3.4 TEST PROCEDURE

- a. Set resolution bandwidth (RBW) = approximately 1% of the emission bandwidth
- b. Set the video bandwidth (VBW)  $\geq 3 \times$  RBW, Detector = Peak.
- c. Trace mode = max hold.
- d. Sweep = auto couple.
- e. Measure the maximum width of the emission that is constrained by the frequencies associated with the two amplitude points (upper and lower) that are attenuated by 6 dB relative to the maximum level measured in the fundamental emission

#### 4.3.5 DEVIATION FROM TEST STANDARD

No deviation.

#### 4.3.6 EUT OPERATING CONDITIONS

The software provided by client to enable the EUT under transmission condition continuously at lowest, middle and highest channel frequencies individually.



### 4.3.7 TEST RESULTS

#### 802.11b

CHANNEL	FREQUENCY (MHz)	6dB BANDWIDTH (MHz)	MINIMUM LIMIT (MHz)	PASS / FAIL
1	2412	9.09	0.5	PASS
6	2437	9.11	0.5	PASS
11	2462	9.58	0.5	PASS

#### 802.11g

CHANNEL	FREQUENCY (MHz)	6dB BANDWIDTH (MHz)	MINIMUM LIMIT (MHz)	PASS / FAIL
1	2412	15.46	0.5	PASS
6	2437	15.38	0.5	PASS
11	2462	15.30	0.5	PASS

#### 802.11n (20MHz)

CHANNEL	FREQUENCY (MHz)	6dB BANDWIDTH (MHz)	MINIMUM LIMIT (MHz)	PASS / FAIL
1	2412	15.75	0.5	PASS
6	2437	16.10	0.5	PASS
11	2462	15.17	0.5	PASS



**A D T**

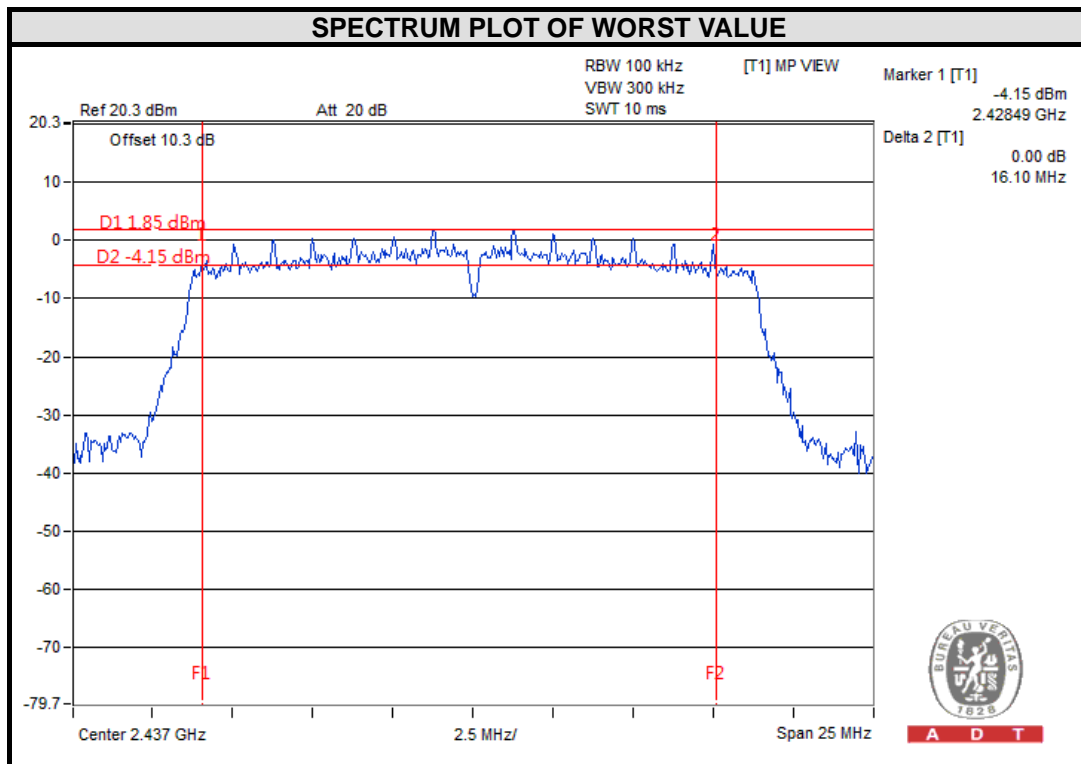

## 4.4 CONDUCTED OUTPUT POWER

### 4.4.1 LIMITS OF CONDUCTED OUTPUT POWER MEASUREMENT

For systems using digital modulation in the 2400–2483.5 MHz bands: 1 Watt (30dBm)

### 4.4.2 TEST SETUP

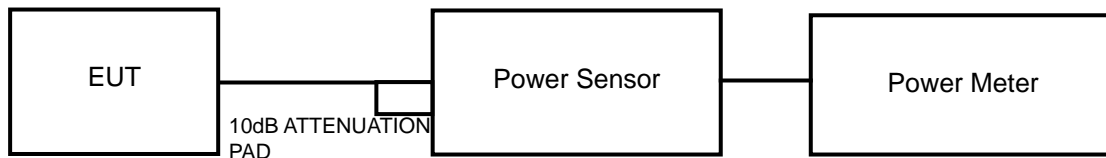

### 4.4.3 TEST INSTRUMENTS

Refer to section 4.1.2 to get information of above instrument.

### 4.4.4 TEST PROCEDURES

A peak power sensor was used on the output port of the EUT. A power meter was used to read the response of the peak power sensor. Record the peak power level.

### 4.4.5 DEVIATION FROM TEST STANDARD

No deviation.

### 4.4.6 EUT OPERATING CONDITIONS

Same as Item 4.3.6.



A D T

#### 4.4.7 TEST RESULTS

##### 802.11b

CHANNEL	FREQUENCY (MHz)	PEAK POWER (mW)	PEAK POWER (dBm)	LIMIT (dBm)	PASS/FAIL
1	2412	80.538	19.06	30	PASS
6	2437	77.804	18.91	30	PASS
11	2462	78.343	18.94	30	PASS

##### 802.11g

CHANNEL	FREQUENCY (MHz)	PEAK POWER (mW)	PEAK POWER (dBm)	LIMIT (dBm)	PASS/FAIL
1	2412	152.055	21.82	30	PASS
6	2437	145.881	21.64	30	PASS
11	2462	150.314	21.77	30	PASS

##### 802.11n (20MHz)

CHANNEL	FREQUENCY (MHz)	PEAK POWER (mW)	PEAK POWER (dBm)	LIMIT (dBm)	PASS/FAIL
1	2412	161.808	22.09	30	PASS
6	2437	158.855	22.01	30	PASS
11	2462	157.036	21.96	30	PASS

## 4.5 POWER SPECTRAL DENSITY MEASUREMENT

### 4.5.1 LIMITS OF POWER SPECTRAL DENSITY MEASUREMENT

The Maximum of Power Spectral Density Measurement is 8dBm.

### 4.5.2 TEST SETUP

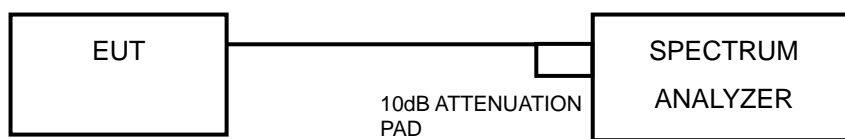

### 4.5.3 TEST INSTRUMENTS

Refer to section 4.1.2 to get information of above instrument.

### 4.5.4 TEST PROCEDURE

- Set the RBW = 3 kHz, VBW = 10 kHz, Detector = peak.
- Sweep time = auto couple, Trace mode = max hold, allow trace to fully stabilize.
- Use the peak marker function to determine the maximum power level in any 100 kHz band segment within the fundamental EBW.

### 4.5.5 DEVIATION FROM TEST STANDARD

No deviation.

### 4.5.6 EUT OPERATING CONDITION

Same as Item 4.3.6



#### 4.5.7 TEST RESULTS

##### 802.11b

Channel	FREQ. (MHz)	PSD (dBm/3kHz)	Limit (dBm/3kHz)	PASS /FAIL
1	2412	-6.40	8	PASS
6	2437	-7.22	8	PASS
11	2462	-4.41	8	PASS

##### 802.11g

Channel	FREQ. (MHz)	PSD (dBm/3kHz)	Limit (dBm/3kHz)	PASS /FAIL
1	2412	-11.21	8	PASS
6	2437	-11.11	8	PASS
11	2462	-10.32	8	PASS

##### 802.11n (20MHz)

Channel	FREQ. (MHz)	PSD (dBm/3kHz)	Limit (dBm/3kHz)	PASS /FAIL
1	2412	-11.79	8	PASS
6	2437	-13.00	8	PASS
11	2462	-12.16	8	PASS





A D T

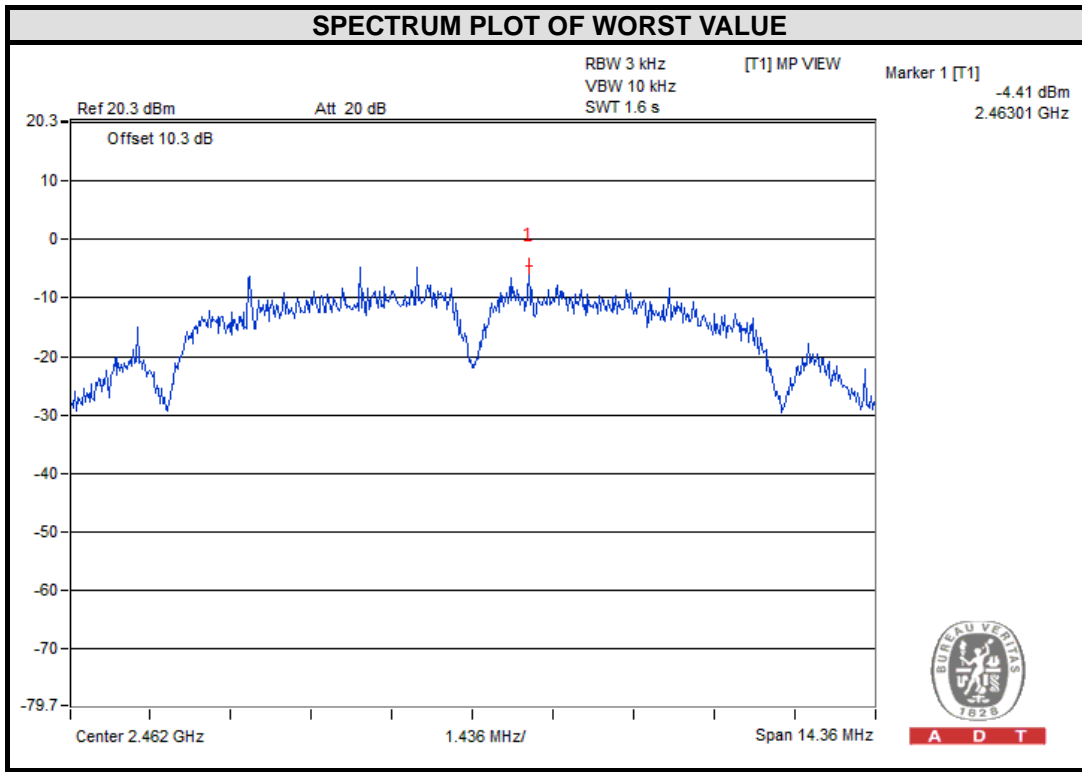

## 4.6 CONDUCTED OUT OF BAND EMISSION MEASUREMENT

### 4.6.1 LIMITS OF CONDUCTED OUT OF BAND EMISSION MEASUREMENT

Below  $-20\text{dB}$  of the highest emission level of operating band (in 100kHz Resolution Bandwidth).

### 4.6.2 TEST SETUP

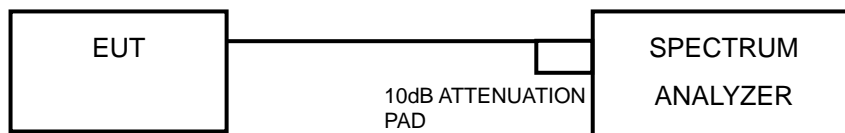

### 4.6.3 TEST INSTRUMENTS

Refer to section 4.1.2 to get information of above instrument.

### 4.6.4 TEST PROCEDURE

#### MEASUREMENT PROCEDURE REF

1. Set the RBW = 100 kHz.
2. Set the VBW  $\geq$  300 kHz.
3. Detector = peak.
4. Sweep time = auto couple.
5. Trace mode = max hold.
6. Allow trace to fully stabilize.
7. Use the peak marker function to determine the maximum power level in any 100 kHz band segment within the fundamental EBW.



A D T

## MEASUREMENT PROCEDURE OOB

1. Set RBW = 100 kHz.
2. Set VBW  $\geq$  300 kHz.
3. Set span to encompass the spectrum to be examined.
4. Detector = peak.
5. Trace Mode = max hold.
6. Sweep = auto couple.

### 4.6.5 DEVIATION FROM TEST STANDARD

No deviation.

### 4.6.6 EUT OPERATING CONDITION

Same as Item 4.3.6

### 4.6.7 TEST RESULTS

The spectrum plots are attached on the following pages. D1 line indicates the highest level, and D2 line indicates the 20dB offset below D1. It shows compliance with the requirement.



A D T

### 802.11b

#### CH 1

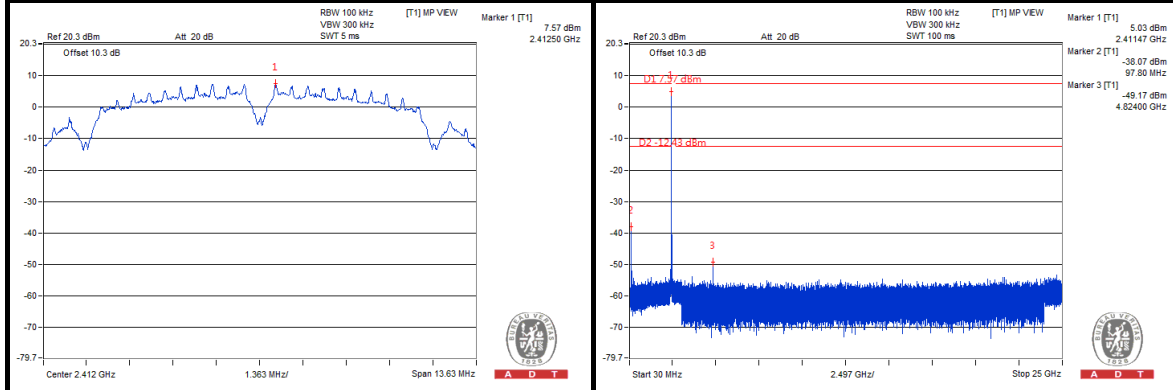

#### CH 6

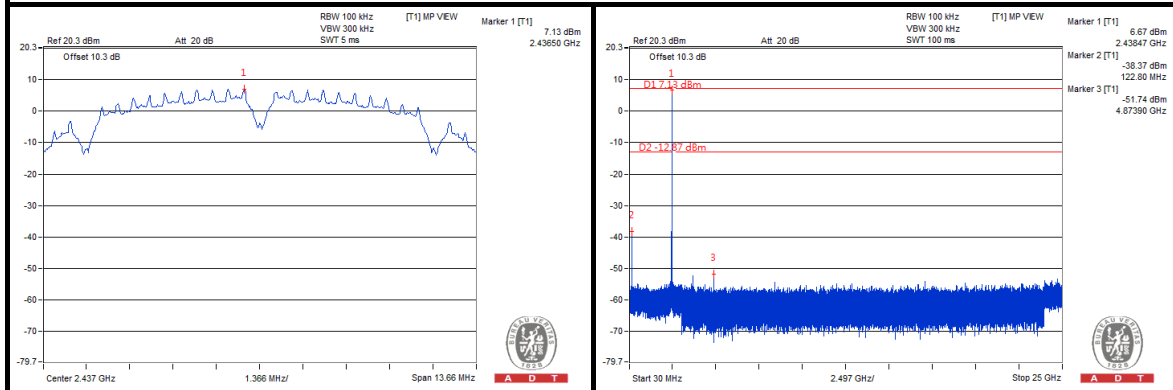

#### CH 11

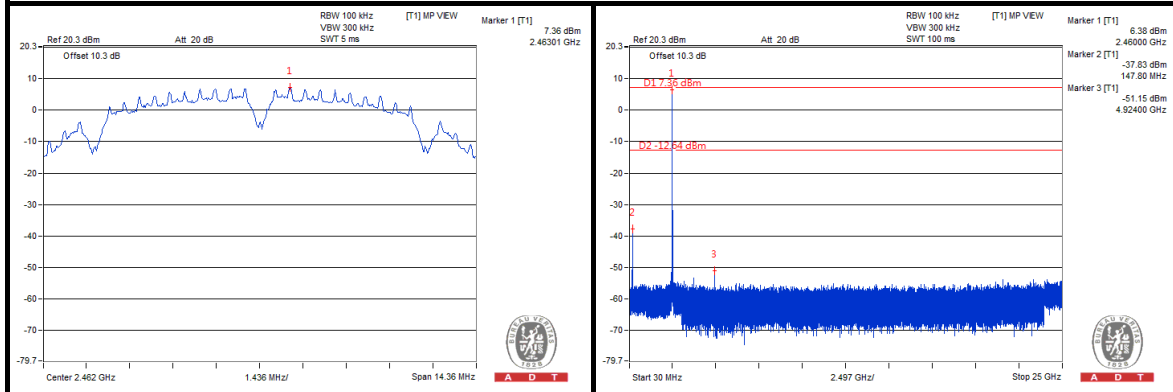



A D T

### 802.11g

#### CH 1

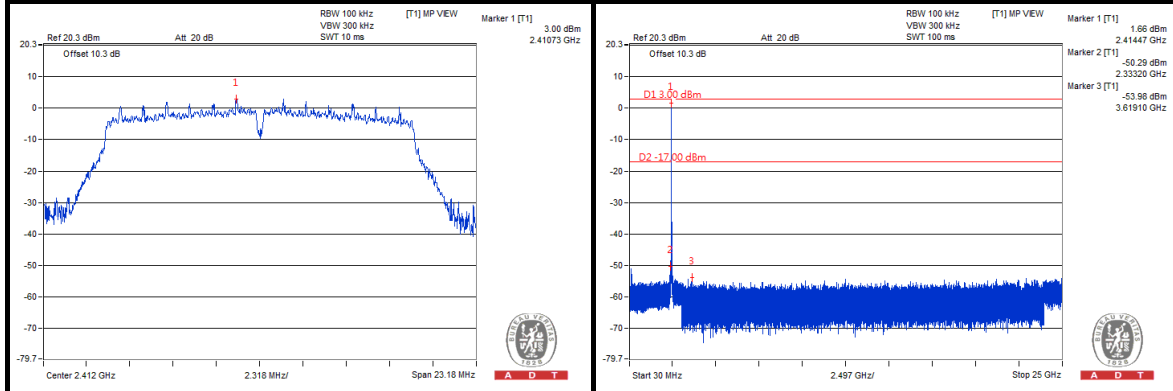

#### CH 6

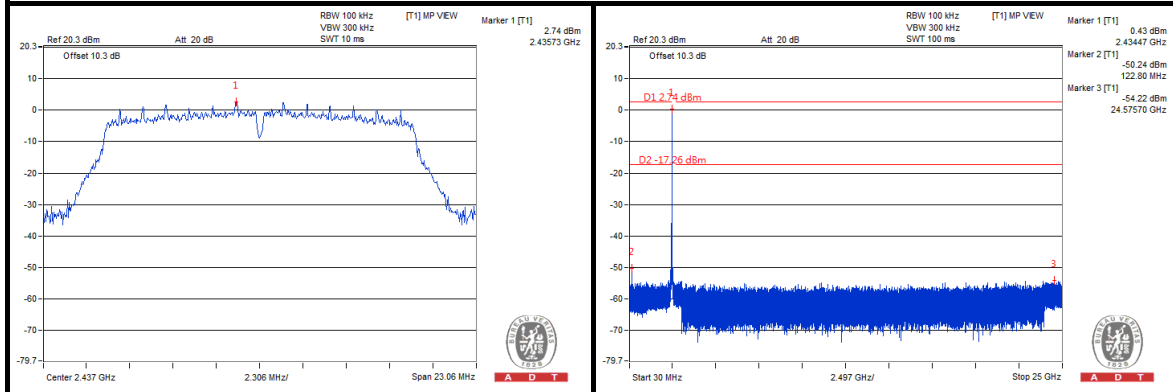

#### CH 11

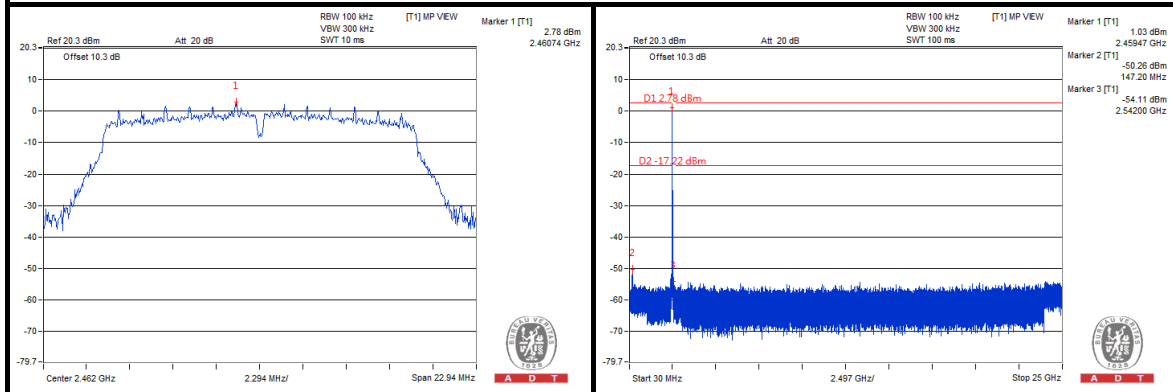



A D T

### 802.11n (20MHz)

#### CH 1

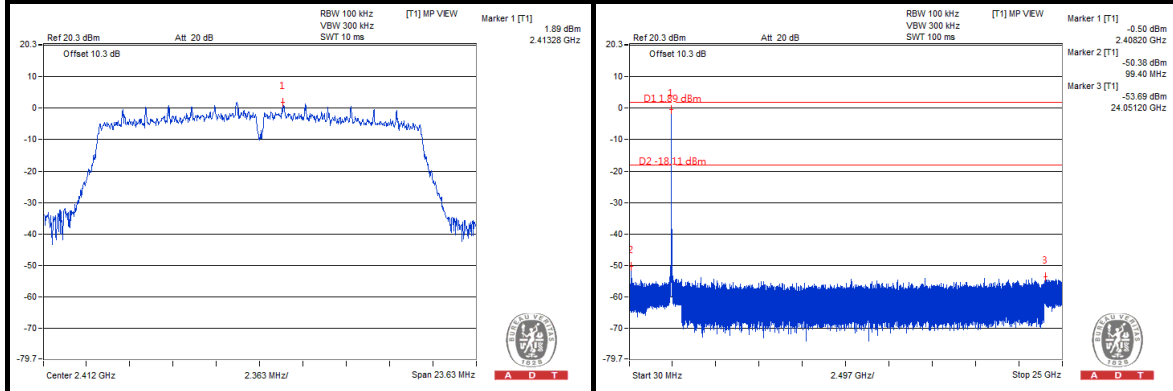

#### CH 6

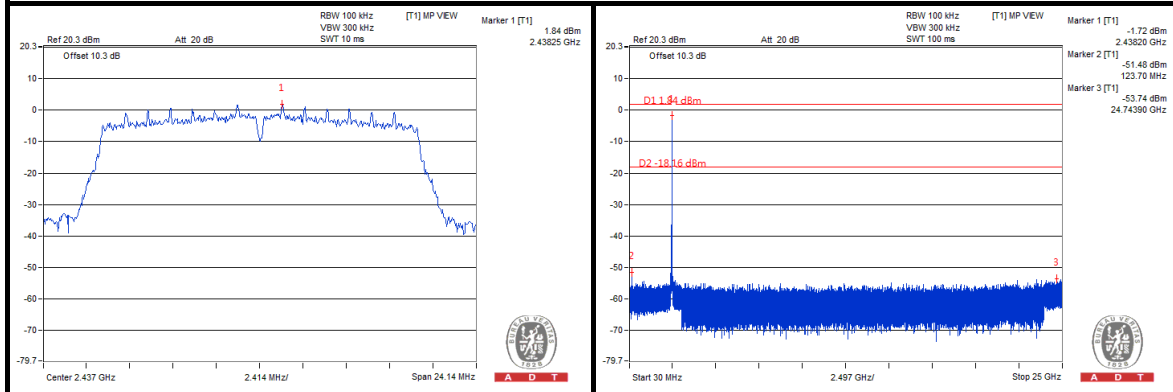

#### CH 11

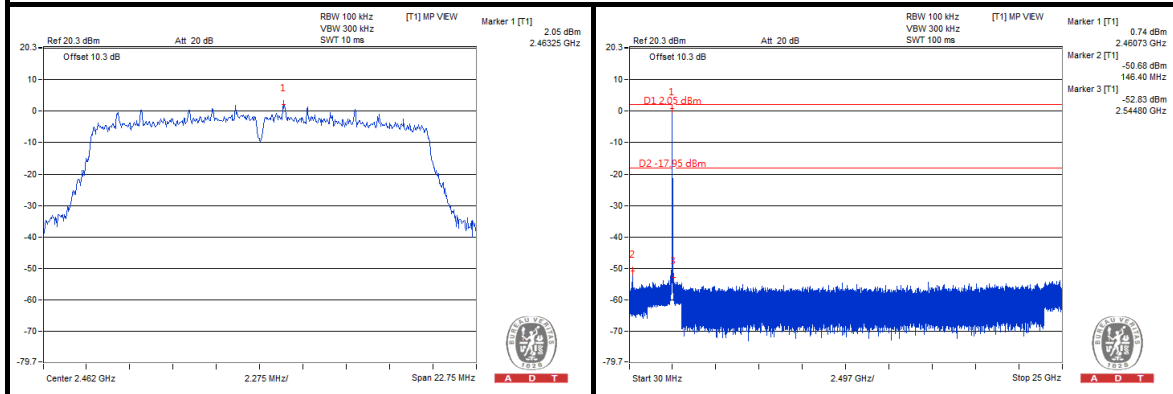



A D T

## 5. PHOTOGRAPHS OF THE TEST CONFIGURATION

Please refer to the attached file (Test Setup Photo).



## 6. INFORMATION ON THE TESTING LABORATORIES

We, Bureau Veritas Consumer Products Services (H.K.) Ltd., Taoyuan Branch, were founded in 1988 to provide our best service in EMC, Radio, Telecom and Safety consultation. Our laboratories are accredited and approved according to ISO/IEC 17025.

If you have any comments, please feel free to contact us at the following:

**Linko EMC/RF Lab:**

Tel: 886-2-26052180

Fax: 886-2-26051924

**Hsin Chu EMC/RF Lab:**

Tel: 886-3-5935343

Fax: 886-3-5935342

**Hwa Ya EMC/RF/Safety Telecom Lab:**

Tel: 886-3-3183232

Fax: 886-3-3270892

**Email:** [service.adt@tw.bureauveritas.com](mailto:service.adt@tw.bureauveritas.com)

**Web Site:** [www.bureauveritas-adt.com](http://www.bureauveritas-adt.com)

The address and road map of all our labs can be found in our web site also.





A D T

## 7. APPENDIX A - MODIFICATIONS RECORDERS FOR ENGINEERING CHANGES TO THE EUT BY THE LAB

No any modifications are made to the EUT by the lab during the test.

---END---