



FCC TEST REPORT (PART 22)

REPORT NO.: RF131213C12
MODEL NO.: Lenovo A7600-H
FCC ID: O57A7600H
RECEIVED: Dec. 13, 2013
TESTED: Dec. 24, 2013 ~ Jan. 09, 2014
ISSUED: Jan. 14, 2014

APPLICANT: Lenovo (Shanghai) Electronics Technology Co., Ltd.

ADDRESS: No. 68 Building, 199 Fenju Road, Wai Gao Qiao FTZ,
Shanghai, China

ISSUED BY: Bureau Veritas Consumer Products Services
(H.K.) Ltd., Taoyuan Branch

LAB ADDRESS: No. 47, 14th Ling, Chia Pau Vil., Lin Kou Dist., New
Taipei City, Taiwan (R.O.C.)

TEST LOCATION: No. 19, Hwa Ya 2nd Rd, Wen Hwa Tsuen, Kwei
Shan Hsiang, Taoyuan Hsien 333, Taiwan, R.O.C.

This report should not be used by the client to claim
product certification, approval, or endorsement by TAF or
any government agencies.



This report is for your exclusive use. Any copying or replication of this report to or for any other person or entity, or use of our name or trademark, is permitted only with our prior written permission. This report sets forth our findings solely with respect to the test samples identified herein. The results set forth in this report are not indicative or representative of the quality or characteristics of the lot from which a test sample was taken or any similar or identical product unless specifically and expressly noted. Our report includes all of the tests requested by you and the results thereof based upon the information that you provided to us. You have 60 days from date of issuance of this report to notify us of any material error or omission caused by our negligence, provided, however, that such notice shall be in writing and shall specifically address the issue you wish to raise. A failure to raise such issue within the prescribed time shall constitute your unqualified acceptance of the completeness of this report, the tests conducted and the correctness of the report contents. Unless specific mention, the uncertainty of measurement has been explicitly taken into account to declare the compliance or non-compliance to the specification

TABLE OF CONTENTS

RELEASE CONTROL RECORD.....	3
1 CERTIFICATION	4
2 SUMMARY OF TEST RESULTS.....	5
2.1 MEASUREMENT UNCERTAINTY	5
2.2 TEST SITE AND INSTRUMENTS	6
3 GENERAL INFORMATION	7
3.1 GENERAL DESCRIPTION OF EUT	7
3.2 CONFIGURATION OF SYSTEM UNDER TEST	9
3.3 DESCRIPTION OF SUPPORT UNITS	9
3.4 TEST ITEM AND TEST CONFIGURATION	10
3.5 EUT OPERATING CONDITIONS	11
3.6 GENERAL DESCRIPTION OF APPLIED STANDARDS	11
4 TEST TYPES AND RESULTS.....	12
4.1 OUTPUT POWER MEASUREMENT	12
4.1.1 LIMITS OF OUTPUT POWER MEASUREMENT	12
4.1.2 TEST PROCEDURES	12
4.1.3 TEST SETUP	13
4.1.4 TEST RESULTS	14
4.2 FREQUENCY STABILITY MEASUREMENT	17
4.2.1 LIMITS OF FREQUENCY STABILITY MEASUREMENT	17
4.2.2 TEST PROCEDURE	17
4.2.3 TEST SETUP	17
4.2.4 TEST RESULTS	18
4.3 OCCUPIED BANDWIDTH MEASUREMENT	19
4.3.1 TEST PROCEDURES	19
4.3.2 TEST SETUP	19
4.3.3 TEST RESULTS	20
4.4 BAND EDGE MEASUREMENT	21
4.4.1 LIMITS OF BAND EDGE MEASUREMENT	21
4.4.2 TEST SETUP	21
4.4.3 TEST PROCEDURES	21
4.4.4 TEST RESULTS	22
4.5 CONDUCTED SPURIOUS EMISSIONS	23
4.5.1 LIMITS OF CONDUCTED SPURIOUS EMISSIONS MEASUREMENT	23
4.5.2 TEST PROCEDURE	23
4.5.3 TEST SETUP	23
4.5.4 TEST RESULTS	24
4.6 RADIATED EMISSION MEASUREMENT	25
4.6.1 LIMITS OF RADIATED EMISSION MEASUREMENT	25
4.6.2 TEST PROCEDURES	25
4.6.3 DEVIATION FROM TEST STANDARD	25
4.6.4 TEST SETUP	26
4.6.5 TEST RESULTS	27
5 PHOTOGRAPHS OF THE TEST CONFIGURATION	35
6 INFORMATION ON THE TESTING LABORATORIES	36
7 APPENDIX A – MODIFICATIONS RECORDERS FOR ENGINEERING CHANGES TO THE EUT BY THE LAB.....	37



A D T

RELEASE CONTROL RECORD

ISSUE NO.	REASON FOR CHANGE	DATE ISSUED
RF131213C12	Original release	Jan. 14, 2014



1 CERTIFICATION

PRODUCT: Portable Tablet Computer

MODEL: Lenovo A7600-H

BRAND: lenovo

APPLICANT: Lenovo (Shanghai) Electronics Technology Co., Ltd.

TESTED: Dec. 24, 2013 ~ Jan. 09, 2014

TEST SAMPLE: Production Unit

STANDARDS: FCC PART 22, Subpart H

The above equipment (model: Lenovo A7600-H) has been tested by **Bureau Veritas Consumer Products Services (H.K.) Ltd., Taoyuan Branch**, and found compliance with the requirement of the above standards. The test record, data evaluation & Equipment Under Test (EUT) configurations represented herein are true and accurate accounts of the measurements of the sample's EMC characteristics under the conditions specified in this report.

PREPARED BY : Vera Huang , **DATE** : Jan. 14, 2014
Vera Huang / Specialist

APPROVED BY : Sam chen , **DATE** : Jan. 14, 2014
Sam Chen / Senior Project Engineer

2 SUMMARY OF TEST RESULTS

The EUT has been tested according to the following specifications:

APPLIED STANDARD: FCC Part 22 & Part 2			
STANDARD SECTION	TEST TYPE	RESULT	REMARK
2.1046 22.913 (a)	Effective radiated power	PASS	Meet the requirement of limit.
2.1055 22.355	Frequency Stability	PASS	Meet the requirement of limit.
2.1049	Occupied Bandwidth	PASS	Meet the requirement of limit.
22.917	Band Edge Measurements	PASS	Meet the requirement of limit.
2.1051 22.917	Conducted Spurious Emissions	PASS	Meet the requirement of limit.
2.1053 22.917	Radiated Spurious Emissions	PASS	Meet the requirement of limit. Minimum passing margin is -31.56dB at 2509.20MHz.

2.1 MEASUREMENT UNCERTAINTY

Where relevant, the following measurement uncertainty levels have been estimated for tests performed on the EUT as specified in CISPR 16-4-2:

MEASUREMENT	FREQUENCY	UNCERTAINTY
Conducted emissions	150kHz~30MHz	2.44 dB
Radiated emissions	30MHz ~ 200MHz	2.93 dB
	200MHz ~1000MHz	2.95 dB
	1GHz ~ 18GHz	2.26 dB
	18GHz ~ 40GHz	1.94 dB

This uncertainty represents an expanded uncertainty expressed at approximately the 95% confidence level using a coverage factor of k=2.



2.2 TEST SITE AND INSTRUMENTS

DESCRIPTION & MANUFACTURER	MODEL NO.	SERIAL NO.	DATE OF CALIBRATION	DUE DATE OF CALIBRATION
Test Receiver ROHDE & SCHWARZ	ESCI	100744	Apr. 15, 2013	Apr. 14, 2014
Spectrum Analyzer ROHDE & SCHWARZ	FSU43	101261	Dec. 21, 2013	Dec. 20, 2014
BILOG Antenna SCHWARZBECK	VULB9168	9168-472	Mar. 25, 2013	Mar. 24, 2014
HORN Antenna SCHWARZBECK	BBHA 9120 D	9120D-209	Sep. 12, 2013	Sep. 11, 2014
HORN Antenna SCHWARZBECK	BBHA 9170	9170-480	Dec. 18, 2013	Dec. 17, 2014
Loop Antenna	HFH2-Z2	100070	Jan. 31, 2012	Jan. 30, 2014
Preamplifier Agilent	8447D	2944A10631	Aug. 30, 2013	Aug. 29, 2014
Preamplifier Agilent	8449B	3008A1960	Aug. 30, 2013	Aug. 29, 2014
Preamplifier EMCI	EMC 330H	980112	Dec. 28, 2012	Dec. 27, 2013
Preamplifier EMCI	EMC 330H	980112	Dec. 27, 2013	Dec. 26, 2014
RF signal cable HUBER+SUHNNER	SUCOFLEX 104	309219/4	Oct. 18, 2013	Oct. 17, 2014
RF signal cable HUBER+SUHNNER	SUCOFLEX 104	250130/4	Oct. 18, 2013	Oct. 17, 2014
RF signal cable Worken	RG-213	NA	Nov. 07, 2013	Nov. 06, 2014
Software BV ADT	E3 6.120103	NA	NA	NA
Antenna Tower MF	MFA-440H	NA	NA	NA
Turn Table MF	MFT-201SS	NA	NA	NA
Antenna Tower & Turn Table Controller MF	MF-7802	NA	NA	NA
Mini-Circuits Power Splitter	ZN2PD-9G	NA	Jul. 18, 2013	Jul. 17, 2014
JFW 20dB attenuation	50HF-020-SMA	NA	NA	NA
Communications Tester-Wireless	E5515C	MY52102544	Sep. 05, 2012	Sep. 04, 2014
Radio Communication Analyzer	MT8820C	6201300640	Aug. 01, 2013	Jul. 31, 2014

- NOTE:**
1. The calibration interval of the above test instruments is 12 months and the calibrations are traceable to NML/ROC and NIST/USA.
 2. The test was performed in HwaYa Chamber 10.
 3. The horn antenna and HP preamplifier (model: 8449B) are used only for the measurement of emission frequency above 1GHz if tested.
 4. The FCC Site Registration No. is 690701.
 5. The IC Site Registration No. is IC 7450F-10.

3 GENERAL INFORMATION

3.1 GENERAL DESCRIPTION OF EUT

EUT	Portable Tablet Computer	
MODEL NO.	Lenovo A7600-H	
POWER SUPPLY	5.0Vdc (adapter or host equipment) 3.7Vdc (battery)	
MODULATION TYPE	GPRS	GMSK
	EDGE	GMSK, 8PSK
	WCDMA	BPSK
FREQUENCY RANGE	GPRS/EDGE	824.2MHz ~ 848.8MHz
	WCDMA	826.4MHz ~ 846.6MHz
MAX. ERP POWER	GPRS	496.36mW
	EDGE	98.86mW
	WCDMA	53.83mW
EMISSION DESIGNATOR	GPRS	248KGXW
	EDGE	246KG7W
	WCDMA	4M18F9W
ANTENNA TYPE	Fixed Internal Antenna	
I/O PORTS	Refer to users' manual	
DATA CABLE	Refer to NOTE as below	
ACCESSORY DEVICES	Refer to NOTE as below	

NOTE:

1. The EUT has following accessories.

ITEM	BRAND	MODEL	DESCRIPTION
AC Adapter 1	lenovo	C-P62	I/P: 100-240Vac, 50/60Hz, 300mA O/P: 5Vdc, 1500mA Manufacturer: Huntkey
AC Adapter 2	lenovo	C-P62	I/P: 100-240Vac, 50/60Hz, 300mA O/P: 5Vdc, 1500mA Manufacturer: PI
Li-ion Battery	lenovo	L11C2P32	Rating: 3.7Vdc, 6340mAh
USB cable	LUXSHARE	L4QU2005-CS-R	0.7m cable
LCM 1	BOE	BP101WX1-210	--
LCM 2	AUO	B101EAN01.3	--
Camera 1	O-Film	L5648F10	--
Camera 2	Sunny	P5V19K-201	--
Touch Panel 1	O-Film	MCF-101-1325	--
Touch Panel 2	Asia Vital	AP101303	--
eMCP 1	Samsung	KMK8X000VM-B412	--
eMCP 2	Hynix	H9TP18A8JDMCPR-KGM	--

2. The device has 2 configurations as below.

Main Sample (A): LCM 1 + Camera 1 + Touch Panel 1 + eMCP 1

2nd Sample (B): LCM 2 + Camera 2 + Touch Panel 2 + eMCP 2

3. The above EUT information was declared by manufacturer and for more detailed features description, please refer to the manufacturer's specifications or User's Manual.

3.2 CONFIGURATION OF SYSTEM UNDER TEST

For Radiation Emission Test

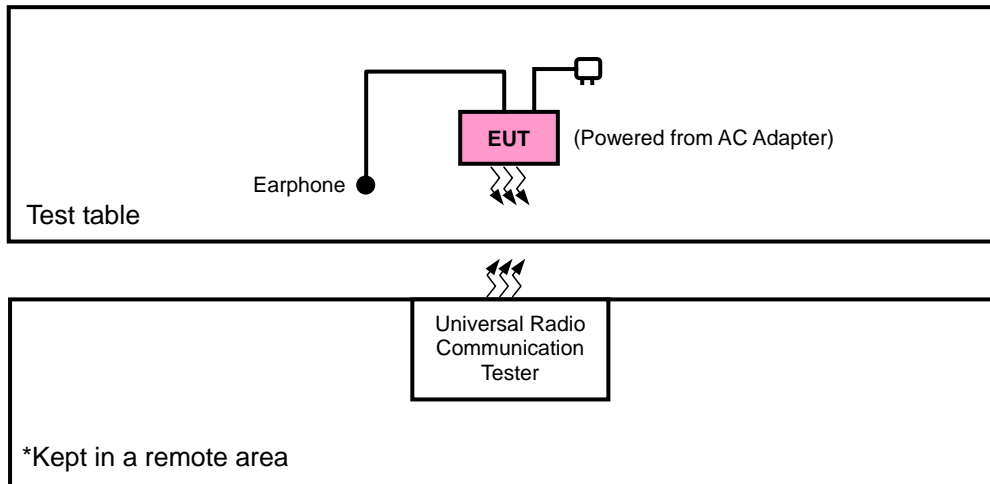

For E.R.P. Test

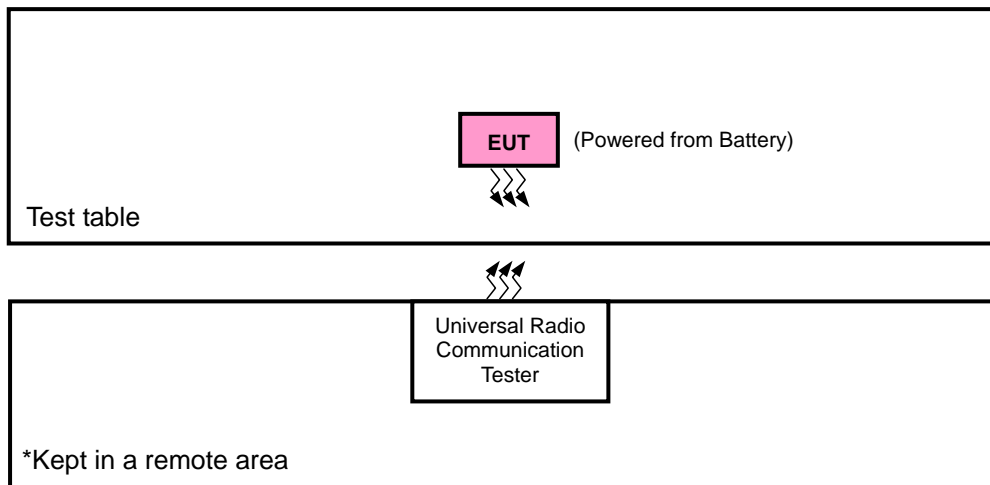

3.3 DESCRIPTION OF SUPPORT UNITS

The EUT has been tested as an independent unit together with other necessary accessories or support units.

3.4 TEST ITEM AND TEST CONFIGURATION

Pre-Scan has been conducted to determine the worst-case mode from all possible combinations between available modulations, data rates, XYZ axis and antenna ports. The worst case was found when positioned on X-axis for ERP and Z-axis for radiated emission. Following channel(s) was (were) selected for the final test as listed below:

GSM MODE

EUT CONFIGURE MODE	TEST ITEM	AVAILABLE CHANNEL	TESTED CHANNEL	MODE
A	ERP	128 to 251	128, 189, 251	GPRS, EDGE
B	ERP	128 to 251	128, 189, 251	GPRS
A	FREQUENCY STABILITY	128 to 251	189	GPRS, EDGE
A	OCCUPIED BANDWIDTH	128 to 251	128, 189, 251	GPRS, EDGE
A	BAND EDGE	128 to 251	128, 251	GPRS, EDGE
A	CONDCUDED EMISSION	128 to 251	189	GPRS, EDGE
A	RADIATED EMISSION	128 to 251	189	GPRS, EDGE
B	RADIATED EMISSION	128 to 251	189	GPRS

WCDMA MODE

EUT CONFIGURE MODE	TEST ITEM	AVAILABLE CHANNEL	TESTED CHANNEL	MODE
A	ERP	4132 to 4233	4132, 4182, 4233	WCDMA
A	FREQUENCY STABILITY	4132 to 4233	4182	WCDMA
A	OCCUPIED BANDWIDTH	4132 to 4233	4132, 4182, 4233	WCDMA
A	BAND EDGE	4132 to 4233	4132, 4233	WCDMA
A	CONDCUDED EMISSION	4132 to 4233	4182	WCDMA
A	RADIATED EMISSION	4132 to 4233	4182	WCDMA

TEST CONDITION:

TEST ITEM	ENVIRONMENTAL CONDITIONS	INPUT POWER	TESTED BY
ERP	26deg. C, 58%RH	3.7Vdc	Howard Kao
FREQUENCY STABILITY	26deg. C, 58%RH	3.7Vdc	Howard Kao
OCCUPIED BANDWIDTH	26deg. C, 58%RH	3.7Vdc	Howard Kao
BAND EDGE	26deg. C, 58%RH	3.7Vdc	Howard Kao
CONDCUDED EMISSION	26deg. C, 58%RH	3.7Vdc	Howard Kao
RADIATED EMISSION	25deg. C, 65%RH	120Vac, 60Hz	Kay Wu

3.5 EUT OPERATING CONDITIONS

The EUT makes a call to the communication simulator. The communication simulator station system controlled a EUT to export maximum output power under transmission mode and specific channel frequency.

3.6 GENERAL DESCRIPTION OF APPLIED STANDARDS

The EUT is a RF product. According to the specifications of the manufacturer, it must comply with the requirements of the following standards:

FCC 47 CFR Part 2

FCC 47 CFR Part 22

ANSI/TIA/EIA-603-C 2004

NOTE: All test items have been performed and recorded as per the above standards.



4 TEST TYPES AND RESULTS

4.1 OUTPUT POWER MEASUREMENT

4.1.1 LIMITS OF OUTPUT POWER MEASUREMENT

Mobile / Portable station are limited to 7 watts e.r.p.

4.1.2 TEST PROCEDURES

EIRP / ERP MEASUREMENT:

- a. All measurements were done at low, middle and high operational frequency range. RBW and VBW is 1MHz for GSM, GPRS & EDGE.
- b. Substitution method is used for E.I.R.P measurement. In the semi-anechoic chamber, EUT placed on the 0.8m height of Turn Table, rotated the table around 360 degrees to search the maximum radiation power and receiver antenna shall be rotated vertical and horizontal polarization and moved height from 1m to 4m to find the maximum polar radiated power. The “Read Value” is the spectrum reading the maximum power value.
- c. The substitution horn antenna is substituted for EUT at the same position and signals generator export the CW signal to the substitution antenna via a tx cable. Rotated the Turn Table and moved receiving antenna to find the maximum radiation power. Adjust output power level of S.G to get a Value of spectrum reading equal to “Read Value” of step b. Record the power level of S.G
- d. $EIRP = \text{Output power level of S.G} - \text{TX cable loss} + \text{Antenna gain of substitution horn.}$
E.R.P power can be calculated form E.I.R.P power by subtracting the gain of dipole, $E.R.P \text{ power} = E.I.R.P \text{ power} - 2.15\text{dBi.}$

CONDUCTED POWER MEASUREMENT:

The EUT was set up for the maximum power with GSM, GPRS, EDGE and WCDMA link data modulation and link up with simulator. Set the EUT to transmit under low, middle and high channel and record the power level shown on simulator.

4.1.3 TEST SETUP

EIRP / ERP MEASUREMENT:

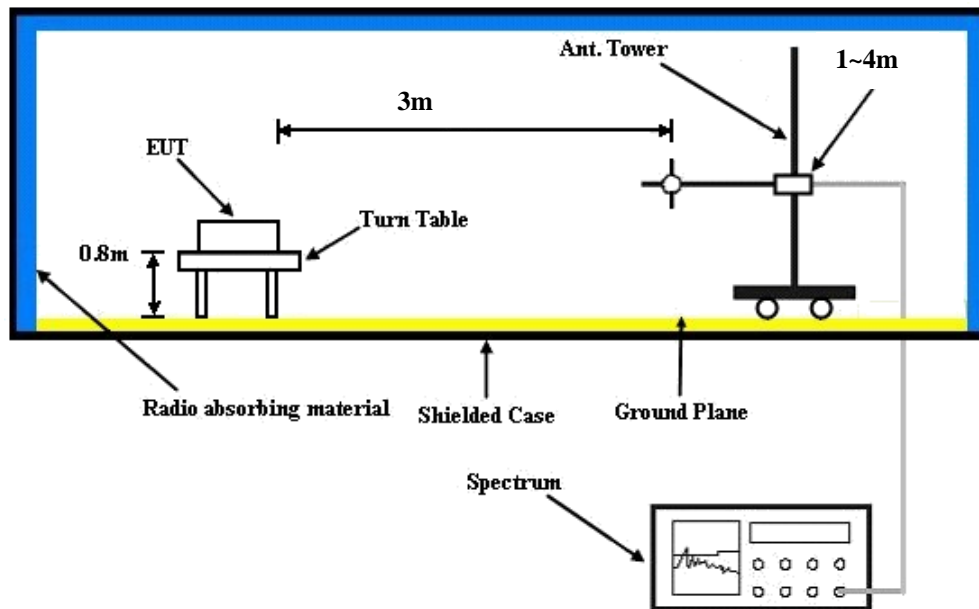

CONDUCTED POWER MEASUREMENT:

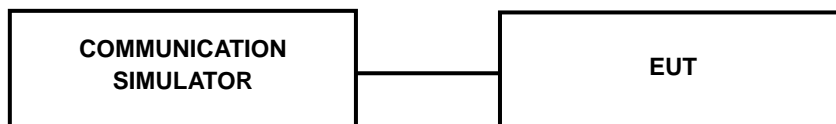

4.1.4 TEST RESULTS

CONDUCTED OUTPUT POWER (dBm)

Band	GSM850		
Channel	128	189	251
Frequency (MHz)	824.2	836.4	848.8
GPRS 8 (GMSK, 1 slot)	32.36	32.50	32.48
GPRS 10 (GMSK, 2 slot)	31.67	31.81	31.79
GPRS 11 (GMSK, 3 slot)	29.90	30.04	30.02
GPRS 12 (GMSK, 4 slot)	28.89	29.10	28.94
EDGE 8 (GMSK, 1 Uplink)	32.33	32.47	32.45
EDGE 10 (GMSK, 2 Uplink)	31.66	31.80	31.78
EDGE 11 (GMSK, 3 Uplink)	29.88	30.02	30.00
EDGE 12 (GMSK, 4 Uplink)	28.87	28.97	28.94
EDGE 8 (8PSK, 1 Uplink)	26.17	26.31	26.29
EDGE 10 (8PSK, 2 Uplink)	25.11	25.25	25.23
EDGE 11 (8PSK, 3 Uplink)	22.89	23.03	23.01
EDGE 12 (8PSK, 4 Uplink)	21.79	21.93	21.91

Band	WCDMA V		
Channel	4132	4182	4233
Frequency (MHz)	826.4	836.4	846.6
RMC 12.2K	23.49	23.25	23.52
HSDPA Subtest-1	22.50	22.25	22.53
HSDPA Subtest-2	22.49	22.26	22.52
HSDPA Subtest-3	22.03	21.79	22.06
HSDPA Subtest-4	22.00	21.76	22.03
HSUPA Subtest-1	20.54	20.30	20.57
HSUPA Subtest-2	20.55	20.31	20.58
HSUPA Subtest-3	21.54	21.30	21.57
HSUPA Subtest-4	20.09	19.85	20.12
HSUPA Subtest-5	22.50	22.26	22.53



A D T

ERP POWER (dBm)

MODE A

GSM

Plane	Channel	Frequency (MHz)	LVL (dBm)	Correction Factor(dB)	ERP(dBm)	ERP(mW)	Polarization (H/V)
X	128	824.2	-2.79	31.208	26.27	423.45	H
	189	836.4	-2.84	31.3	26.31	427.56	H
	251	848.8	-2.85	31.222	26.22	418.99	H
	128	824.2	-8.98	31.504	20.37	108.99	V
	189	836.4	-8.52	31.117	20.45	110.84	V
	251	848.8	-8.85	31.922	20.92	123.65	V

EDGE

Plane	Channel	Frequency (MHz)	LVL (dBm)	Correction Factor(dB)	ERP(dBm)	ERP(mW)	Polarization (H/V)
X	128	824.2	-9.35	31.208	19.71	93.50	H
	189	836.4	-9.20	31.3	19.95	98.86	H
	251	848.8	-9.47	31.222	19.60	91.24	H
	128	824.2	-15.57	31.504	13.78	23.90	V
	189	836.4	-15.37	31.117	13.60	22.89	V
	251	848.8	-15.80	31.922	13.97	24.96	V

WCDMA

Plane	Channel	Frequency (MHz)	LVL (dBm)	Correction Factor(dB)	ERP(dBm)	ERP(mW)	Polarization (H/V)
X	4132	826.4	-11.83	31.208	17.23	52.82	H
	4182	836.4	-11.84	31.3	17.31	53.83	H
	4233	846.6	-11.85	31.222	17.22	52.75	H
	4132	826.4	-17.48	31.504	11.87	15.40	V
	4182	836.4	-17.22	31.117	11.75	14.95	V
	4233	846.6	-18.02	31.922	11.75	14.97	V



A D T

MODE B

GSM

Plane	Channel	Frequency (MHz)	LVL (dBm)	Correction Factor(dB)	ERP(dBm)	ERP(mW)	Polarization (H/V)
X	128	824.2	-2.10	31.208	26.96	496.36	H
	189	836.4	-2.36	31.3	26.79	477.53	H
	251	848.8	-2.91	31.222	26.16	413.24	H
	128	824.2	-8.61	31.504	20.74	118.69	V
	189	836.4	-8.08	31.117	20.89	122.66	V
	251	848.8	-9.22	31.922	20.55	113.55	V

4.2 FREQUENCY STABILITY MEASUREMENT

4.2.1 LIMITS OF FREQUENCY STABILITY MEASUREMENT

1.5 ppm is for base and fixed station. 2.5 ppm is for mobile station.

4.2.2 TEST PROCEDURE

- a. Device is placed at the oven room. The oven room could control the temperatures and humidity. Power warm up is at least 15 min and power applied should perform before recording frequency error.
- b. EUT is connected the external power supply to control the DC input power. The test voltage range is from minimum to maximum working voltage. Each step shall be record the frequency error rate.
- c. The temperature range step is 10 degrees in this test items. All temperature levels shall be hold the $\pm 0.5^{\circ}\text{C}$ during the measurement testing. The each temperature step shall be at least 0.5 hours, consider the EUT could be test under the stability condition.

NOTE: The frequency error was recorded frequency error from the communication simulator.

4.2.3 TEST SETUP

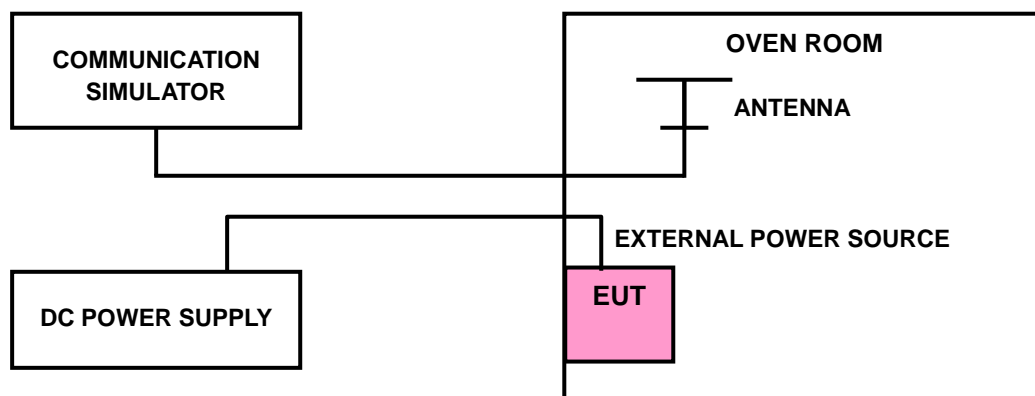

4.2.4 TEST RESULTS

FREQUENCY ERROR vs. VOLTAGE

VOLTAGE (Volts)	FREQUENCY ERROR (ppm)			LIMIT (ppm)
	GPRS	EDGE	WCDMA	
3.8	0.01	-0.01	-0.003	2.5
3.5	0.01	-0.01	-0.003	2.5
4.3	0.01	-0.01	-0.004	2.5

NOTE: The applicant defined the normal working voltage of the battery is from 3.5Vdc to 4.3Vdc.

FREQUENCY ERROR vs. TEMPERATURE

TEMP. (°C)	FREQUENCY ERROR (ppm)			LIMIT (ppm)
	GPRS	EDGE	WCDMA	
-30	0.008	-0.005	-0.006	2.5
-20	0.005	-0.004	-0.004	2.5
-10	-0.004	-0.004	-0.004	2.5
0	-0.009	-0.008	-0.002	2.5
10	0.002	-0.005	0.002	2.5
20	-0.005	-0.007	0.003	2.5
30	0.008	-0.007	0.004	2.5
40	0.005	-0.004	0.004	2.5
50	-0.003	-0.003	-0.003	2.5

4.3 OCCUPIED BANDWIDTH MEASUREMENT

4.3.1 TEST PROCEDURES

The EUT makes a call to the communication simulator. All measurements were done at low, middle and high operational frequency range. The communication simulator station system controlled a EUT to export maximum output power under transmission mode and specific channel frequency. Use OBW measurement function of Spectrum analyzer to measure 99 % occupied bandwidth.

4.3.2 TEST SETUP

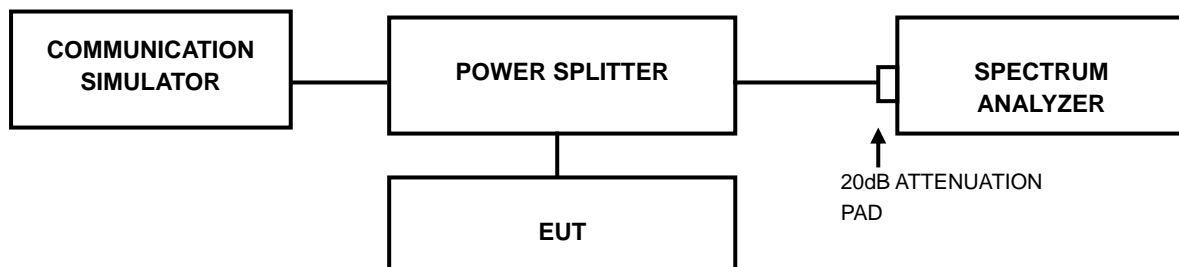



A D T

4.3.3 TEST RESULTS

CHANNEL	FREQUENCY (MHz)	99% OCCUPIED BANDWIDTH (kHz)		CHANNEL	FREQUENCY (MHz)	99% OCCUPIED BANDWIDTH (MHz)
		GPRS	EDGE			WCDMA
128	824.2	245.20	244.68	4132	826.4	4.1635
189	836.4	247.54	245.14	4182	836.4	4.1758
251	848.8	243.37	246.34	4233	846.6	4.1715

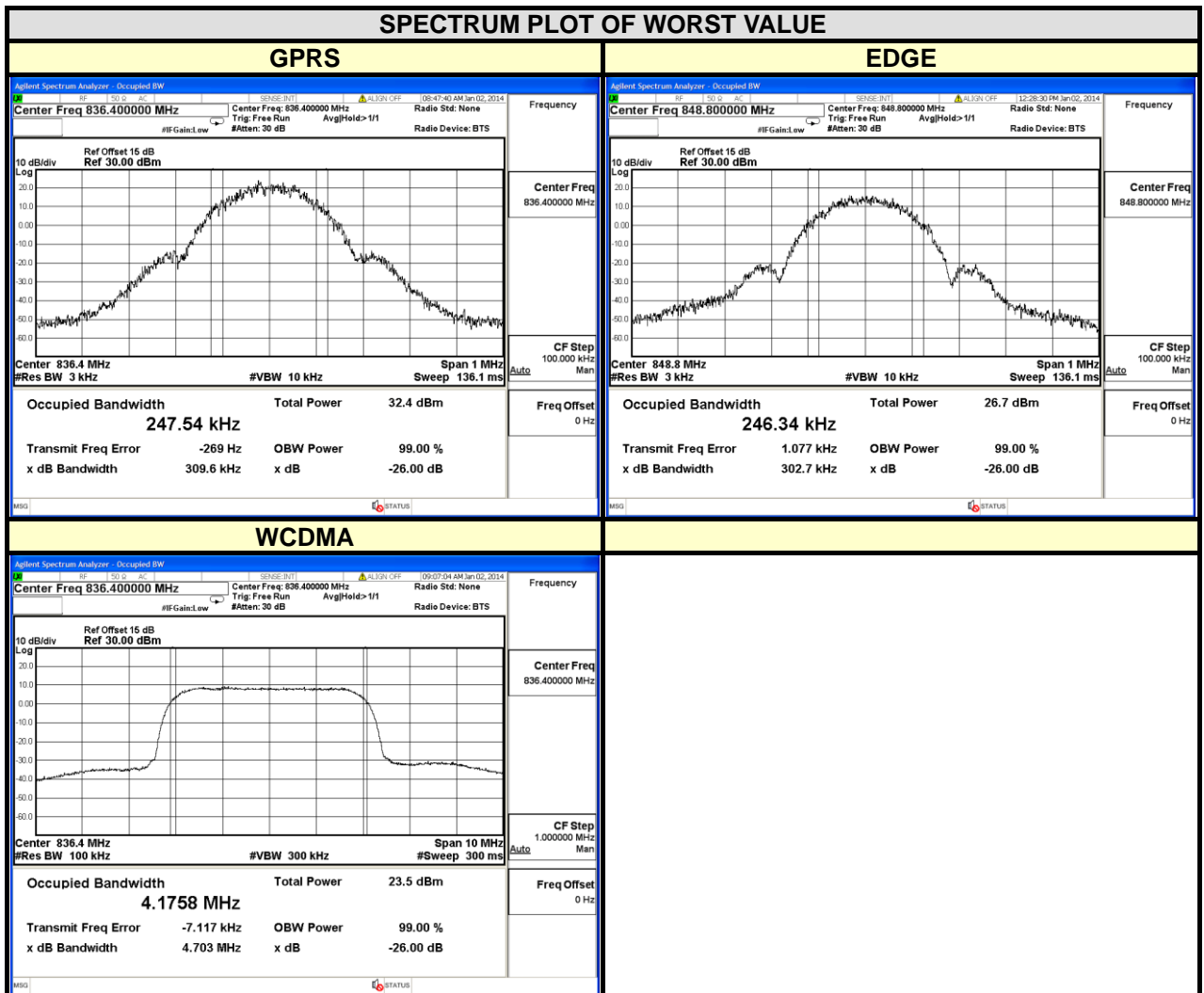

4.4 BAND EDGE MEASUREMENT

4.4.1 LIMITS OF BAND EDGE MEASUREMENT

Power of any emission outside of the authorized operating frequency ranges must be attenuated below the transmitting power (P) by a factor of at least $43 + 10 \log(P)$ dB. In the 1 MHz bands immediately outside and adjacent to the frequency block a resolution bandwidth of at least one percent of the emission bandwidth of the fundamental emission of the transmitter may be employed.

4.4.2 TEST SETUP

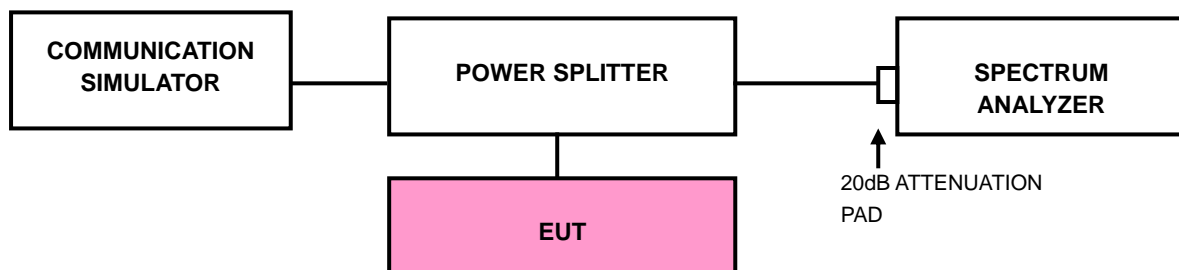

4.4.3 TEST PROCEDURES

- All measurements were done at low and high operational frequency range.
- The center frequency of spectrum is the band edge frequency and span is 1MHz. RB of the spectrum is 3kHz and VB of the spectrum is 10kHz (GSM/GPRS/EDGE).
- The center frequency of spectrum is the band edge frequency and span is 5MHz. RB of the spectrum is 100kHz and VB of the spectrum is 300kHz (WCDMA).
- Record the max trace plot into the test report.

4.4.4 TEST RESULTS

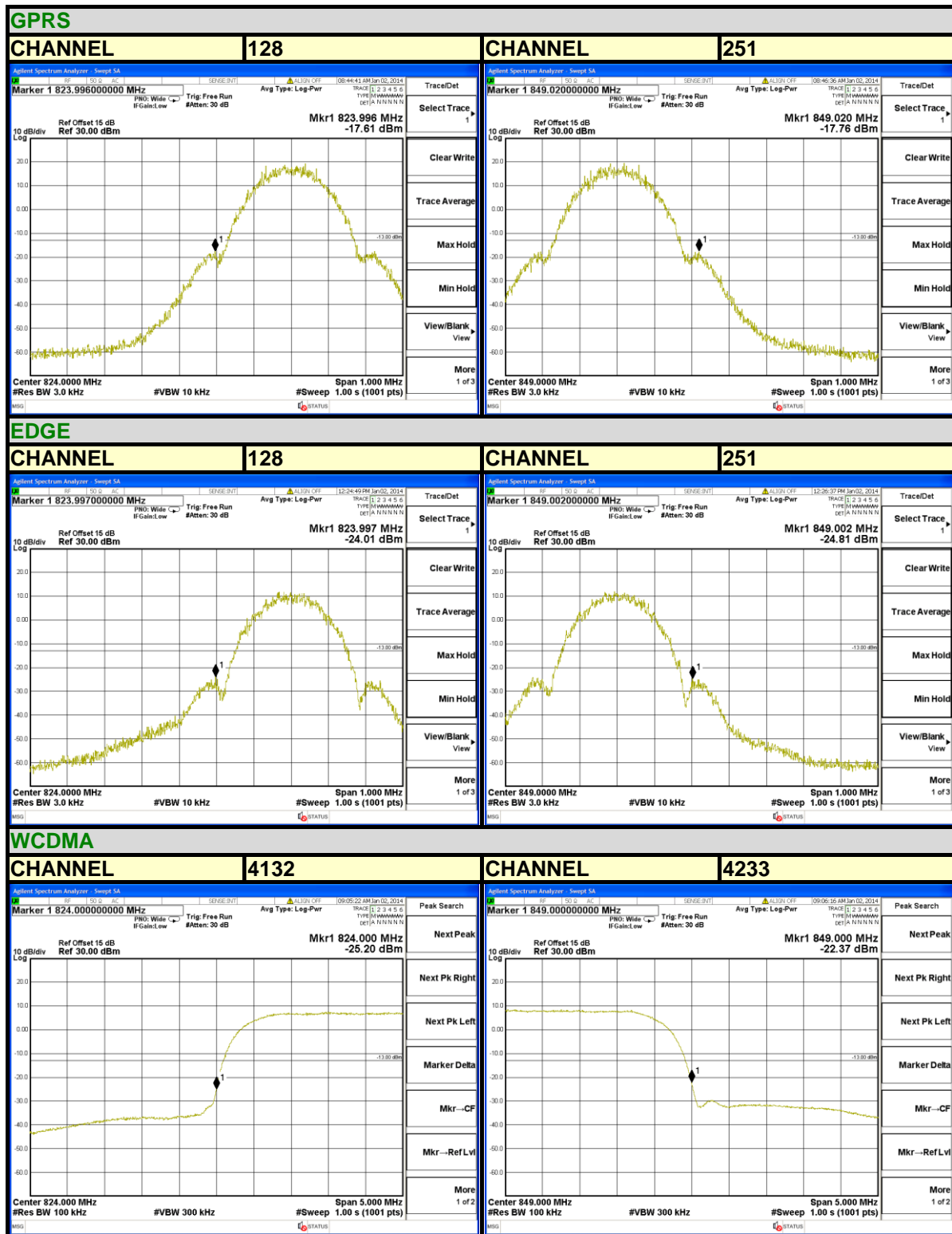

4.5 CONDUCTED SPURIOUS EMISSIONS

4.5.1 LIMITS OF CONDUCTED SPURIOUS EMISSIONS MEASUREMENT

The power of any emission outside of the authorized operating frequency ranges must be attenuated below the transmitting power (P) by a factor of at least $43 + 10 \log(P)$ dB. The emission limit equal to -13dBm .

4.5.2 TEST PROCEDURE

- a. The EUT makes a phone call to the communication simulator. All measurements were done at low, middle and high operational frequency range.
- b. Measuring frequency range is from 30 MHz to 9GHz. 10dB attenuation pad is connected with spectrum. RBW=1MHz and VBW=3MHz is used for conducted emission measurement.

4.5.3 TEST SETUP

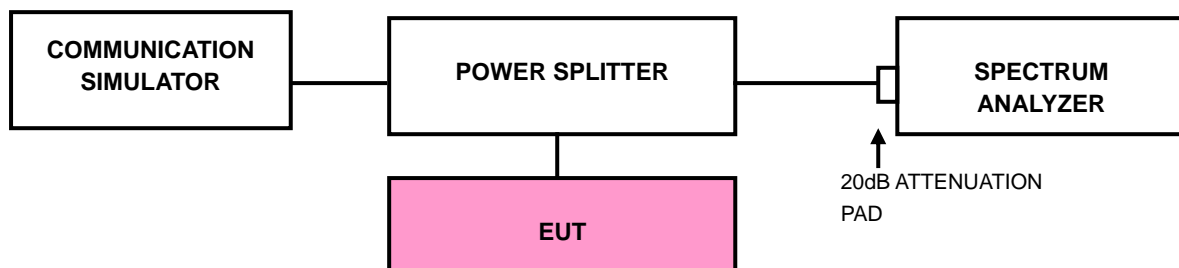



A D T

4.5.4 TEST RESULTS

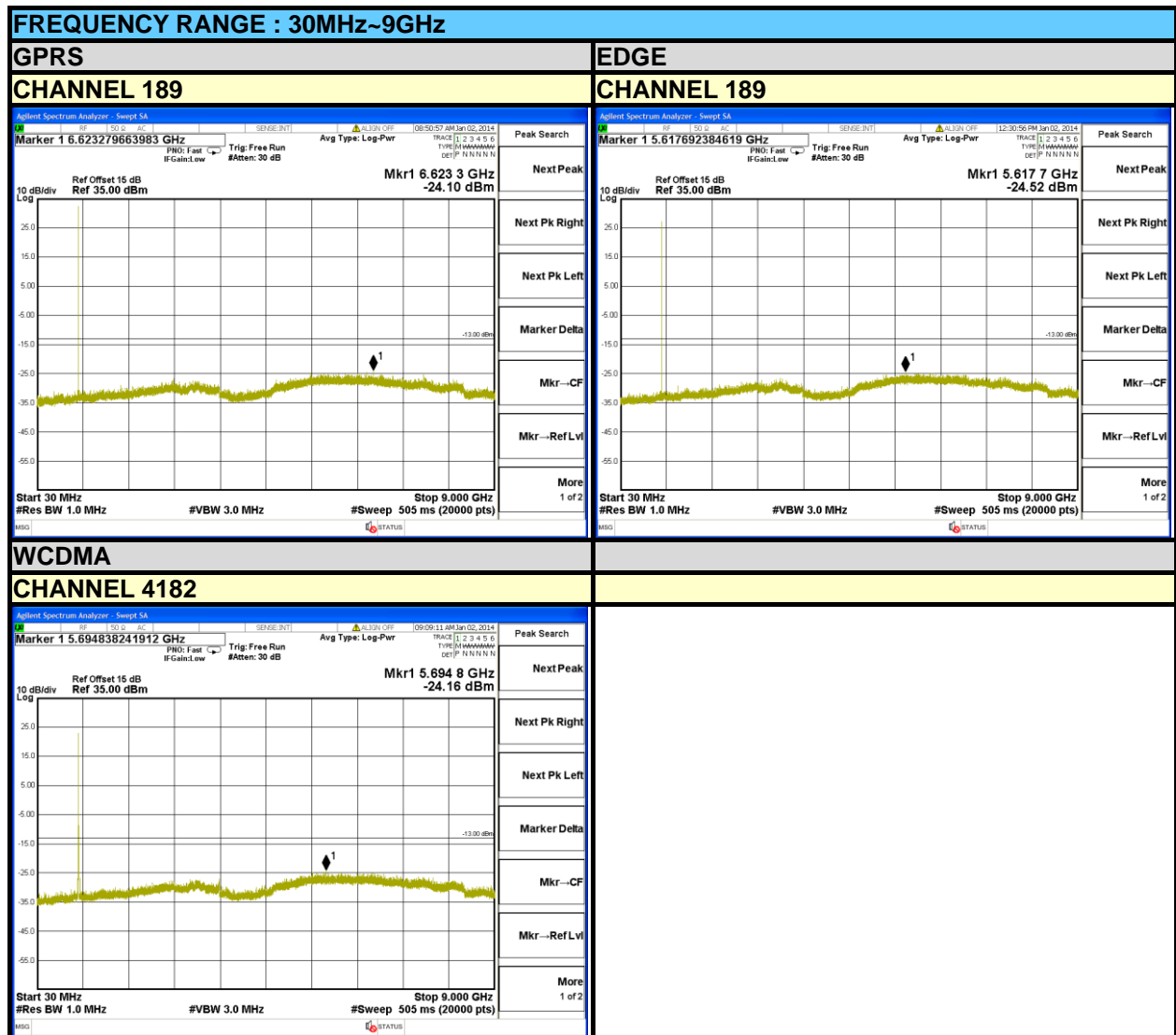

4.6 RADIATED EMISSION MEASUREMENT

4.6.1 LIMITS OF RADIATED EMISSION MEASUREMENT

The power of any emission outside of the authorized operating frequency ranges must be attenuated below the transmitting power (P) by a factor of at least $43 + 10 \log(P)$ dB. The emission limit equal to -13dBm .

4.6.2 TEST PROCEDURES

- a. Substitution method is used for E.I.R.P measurement. In the semi-anechoic chamber, EUT placed on the 0.8m height of Turn Table, rotated the table around 360 degrees to search the maximum radiation power and receiver antenna shall be rotated vertical and horizontal polarization and moved height from 1m to 4m to find the maximum polar radiated power. The “Read Value” is the spectrum reading the maximum power value.
- b. The substitution horn antenna is substituted for EUT at the same position and signals generator export the CW signal to the substitution antenna via a TX cable. Rotated the Turn Table and moved receiving antenna to find the maximum radiation power. Adjust output power level of S.G to get a Value of spectrum reading equal to “Read Value” of step a. Record the power level of S.G
- c. $\text{EIRP} = \text{Output power level of S.G} - \text{TX cable loss} + \text{Antenna gain of substitution horn.}$
- d. E.R.P power can be calculated form E.I.R.P power by subtracting the gain of dipole,
 $\text{E.R.P power} = \text{E.I.R.P power} - 2.15\text{dBi.}$

NOTE: The resolution bandwidth and video bandwidth of test receiver/spectrum analyzer is 1MHz/3MHz.

4.6.3 DEVIATION FROM TEST STANDARD

No deviation

4.6.4 TEST SETUP

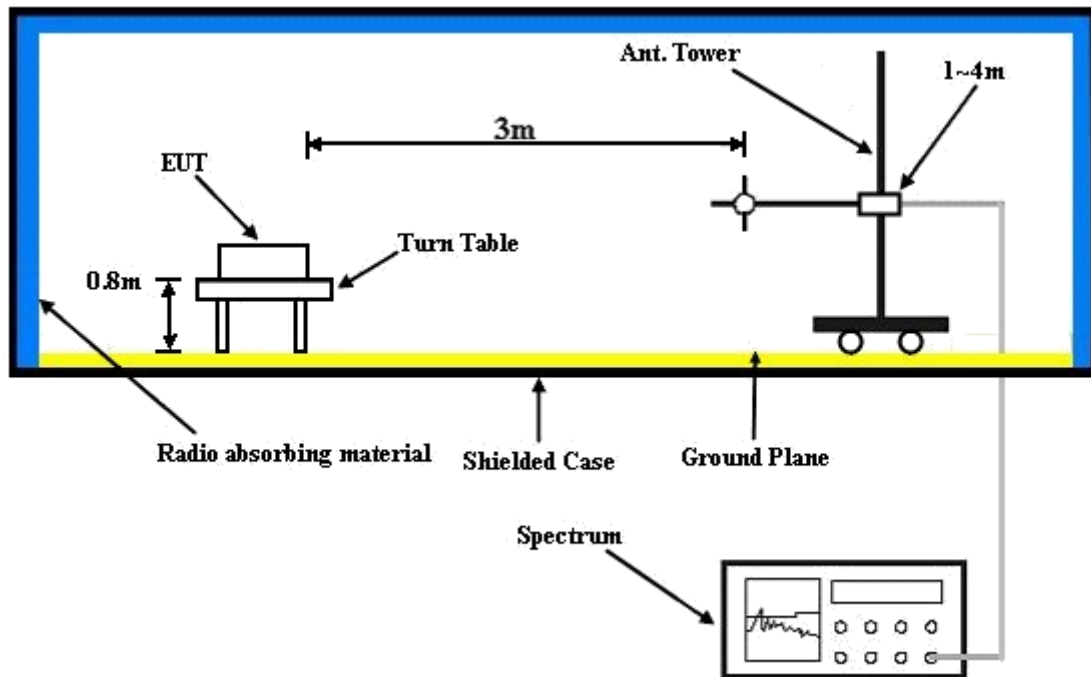

For the actual test configuration, please refer to the attached file (Test Setup Photo).



A D T

4.6.5 TEST RESULTS

MODE A

GPRS:



Bureau Veritas Consumer Products Services Ltd., Taoyuan Branch

A D T

Data: 9

Date: 2013-12-24

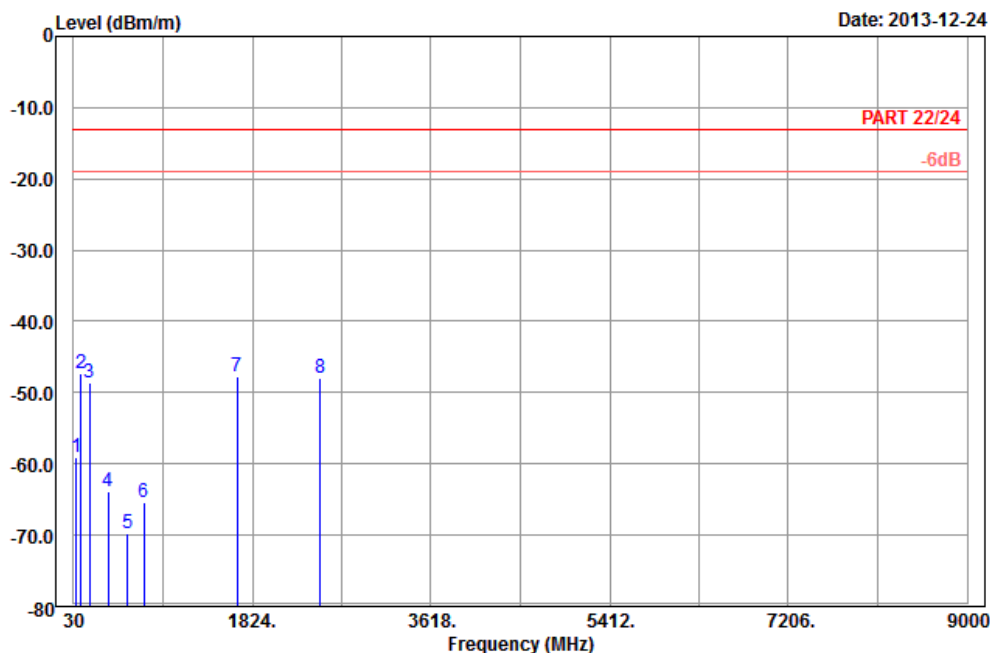

Site : 966 chamber 5
 Condition : PART 22/24 3m Horizontal
 Brand/Model: LVP9
 Remark : GPRS_850_Link
 Tested by : Kay wu
 Temperature : 25°C
 Humidity : 65%
 Plane : Z

	Freq	Level	Read Level	Limit Line	Over Limit	Factor	Remark
	MHz	dBm/m	dBm	dBm/m	dB	dB/m	
1	59.70	-59.12	-45.05	-13.00	-46.12	-14.07	Peak
2	pp 102.63	-47.29	-37.52	-13.00	-34.29	-9.77	Peak
3	192.00	-48.55	-42.73	-13.00	-35.55	-5.82	Peak
4	374.20	-63.90	-59.82	-13.00	-50.90	-4.08	Peak
5	575.10	-69.75	-69.13	-13.00	-56.75	-0.62	Peak
6	732.60	-65.43	-64.45	-13.00	-52.43	-0.98	Peak
7	1672.80	-47.80	-55.71	-13.00	-34.80	7.91	Peak
8	2509.20	-47.98	-59.26	-13.00	-34.98	11.28	Peak



Bureau Veritas Consumer Products Services Ltd., Taoyuan Branch

A D T

Data: 10

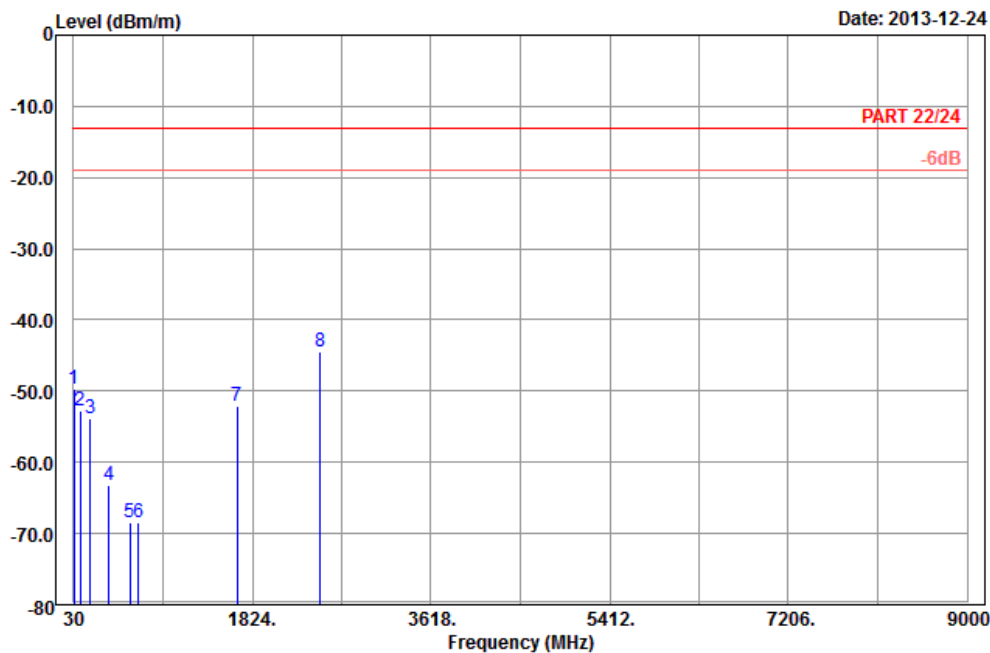

Site : 966 chamber 5
 Condition : PART 22/24 3m Vertical
 Brand/Model: LVP9
 Remark : GPRS_850_Link
 Tested by : Kay wu
 Temperature : 25°C
 Humidity : 65%
 Plane : Z

	Freq	Level	Read Level	Limit Line	Over Limit	Factor	Remark
	MHz	dBm/m	dBm	dBm/m	dB	dB/m	
1	31.62	-49.81	-39.05	-13.00	-36.81	-10.76	Peak
2	99.93	-52.67	-42.55	-13.00	-39.67	-10.12	Peak
3	195.24	-53.82	-47.86	-13.00	-40.82	-5.96	Peak
4	387.50	-63.25	-59.89	-13.00	-50.25	-3.36	Peak
5	594.00	-68.34	-68.49	-13.00	-55.34	0.15	Peak
6	680.80	-68.53	-68.25	-13.00	-55.53	-0.28	Peak
7	1672.80	-52.20	-60.11	-13.00	-39.20	7.91	Peak
8 pp	2509.20	-44.56	-55.84	-13.00	-31.56	11.28	Peak



A D T

EDGE:



Bureau Veritas Consumer Products Services Ltd., Taoyuan Branch

A D T

Data: 5

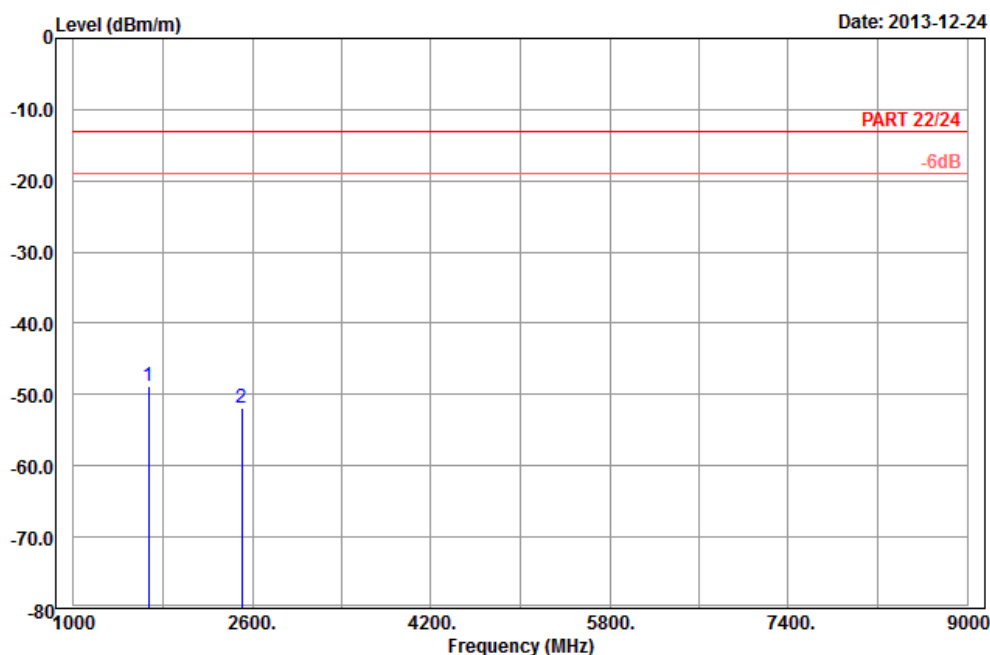

Site : 966 chamber 5
 Condition : PART 22/24 3m Horizontal
 Brand/Model: LVP9
 Remark : EDGE_850_Link
 Tested by : Kay wu
 Temperature : 25°C
 Humidity : 65%
 Plane : Z

	Read	Limit	Over			
Freq	Level	Level	Line	Limit	Factor	Remark
MHz	dBm/m	dBm	dBm/m	dB	dB/m	
1 pp	1672.80	-48.87	-56.78	-13.00	-35.87	7.91 Peak
2	2509.20	-51.89	-63.17	-13.00	-38.89	11.28 Peak



A D T



Bureau Veritas Consumer Products Services Ltd., Taoyuan Branch

A D T

Data: 6

Date: 2013-12-24

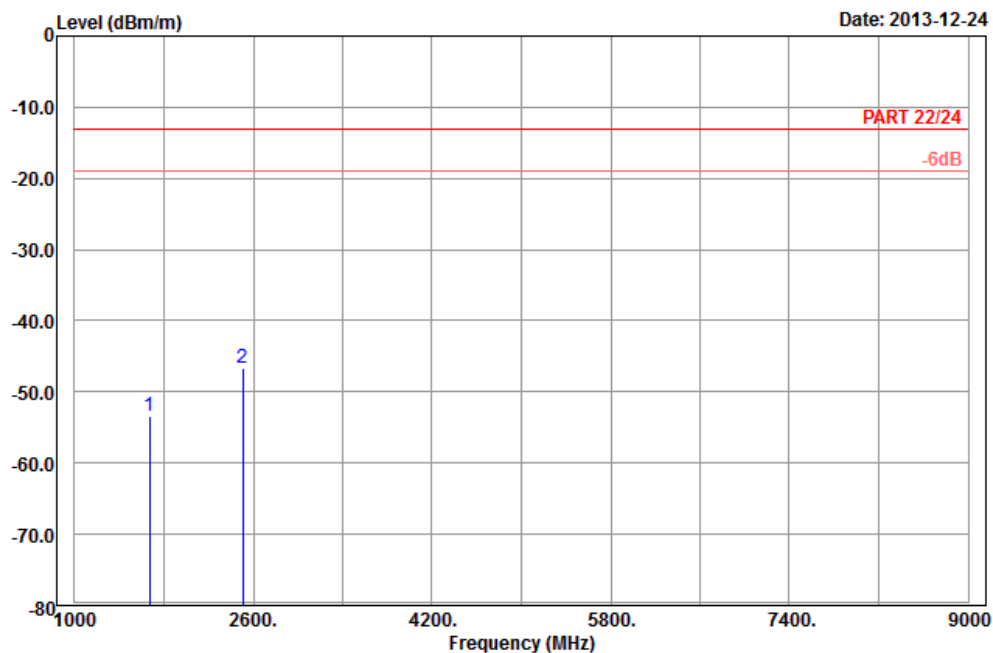

Site : 966 chamber 5
 Condition : PART 22/24 3m Vertical
 Brand/Model: LVP9
 Remark : EDGE_850_Link
 Tested by : Kay wu
 Temperature : 25°C
 Humidity : 65%
 Plane : Z

	Read	Limit	Over			
Freq	Level	Level	Line	Limit	Factor	Remark
MHz	dBm/m	dBm	dBm/m	dB	dB/m	
1	1672.80	-53.31	-61.22	-13.00	-40.31	7.91 Peak
2 pp	2509.20	-46.74	-58.02	-13.00	-33.74	11.28 Peak



A D T

WCDMA:



Bureau Veritas Consumer Products Services Ltd., Taoyuan Branch

A D T

Data: 5

Date: 2013-12-24

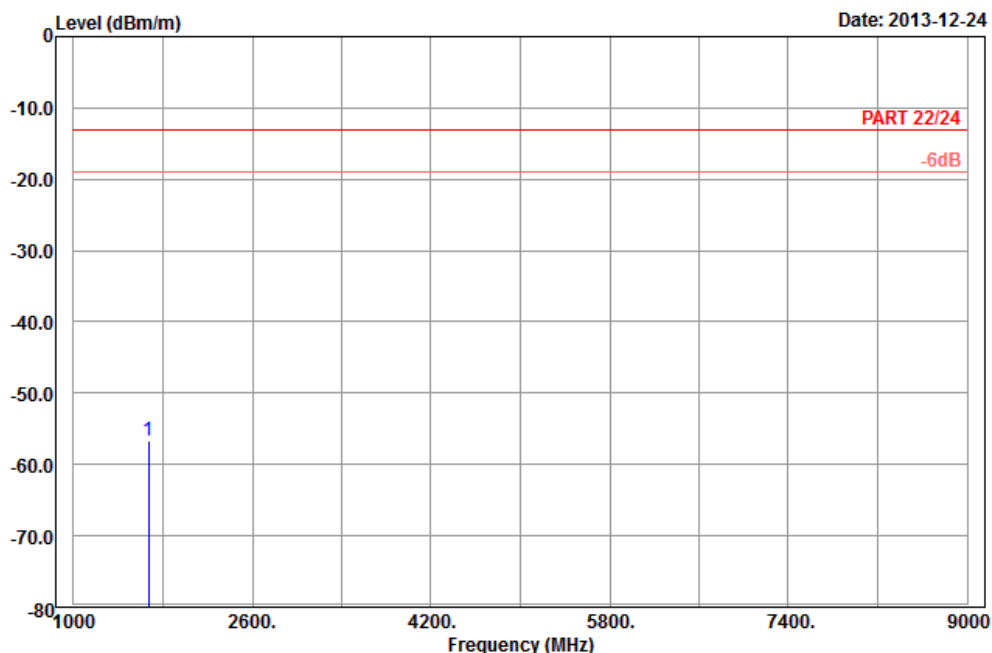

Site : 966 chamber 5
 Condition : PART 22/24 3m Horizontal
 Brand/Model: LVP9
 Remark : Band V_Link
 Tested by : Kay wu
 Temperature : 25°C
 Humidity : 65%
 Plane : Z

	Freq	Level	Read Level	Limit Line	Over Limit	Factor	Remark
	MHz	dBm/m	dBm	dBm/m	dB	dB/m	
1 pp	1672.80	-56.65	-64.56	-13.00	-43.65	7.91	Peak



Bureau Veritas Consumer Products Services Ltd., Taoyuan Branch

A D T

Data: 6

Date: 2013-12-24

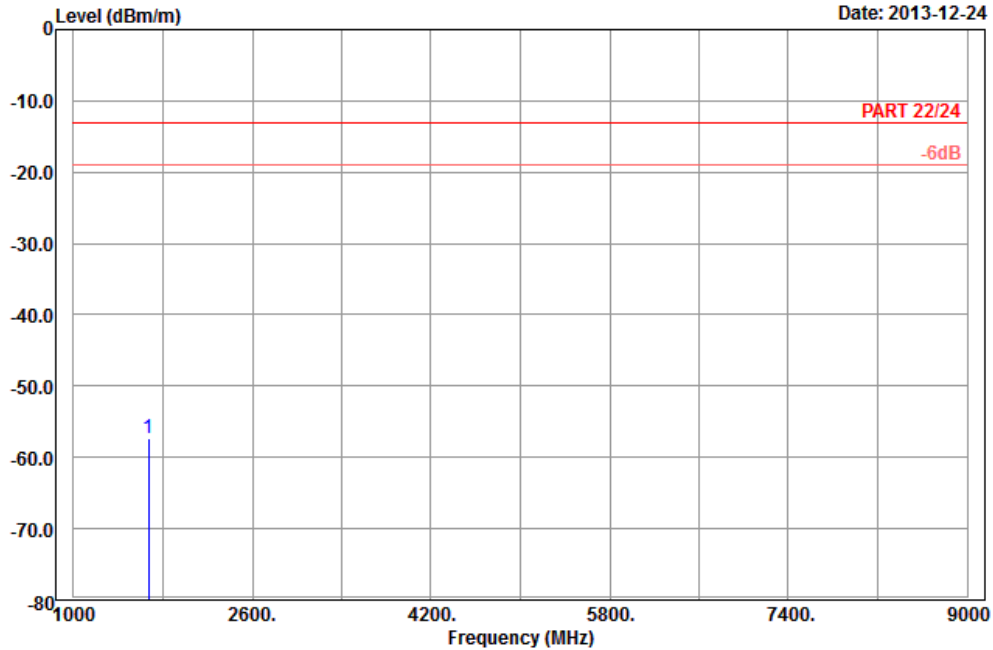

Site : 966 chamber 5
 Condition : PART 22/24 3m Vertical
 Brand/Model: LVP9
 Remark : Band V_Link
 Tested by : Kay wu
 Temperature : 25°C
 Humidity : 65%
 Plane : Z

	Read	Limit	Over			
Freq	Level	Level	Line	Limit	Factor	Remark
MHz	dBm/m	dBm	dBm/m	dB	dB/m	
1 pp 1672.80	-57.35	-65.26	-13.00	-44.35	7.91	Peak



A D T

MODE B

GPRS:



Bureau Veritas Consumer Products Services Ltd., Taoyuan Branch

A D T

Data: 9

Date: 2014-01-09

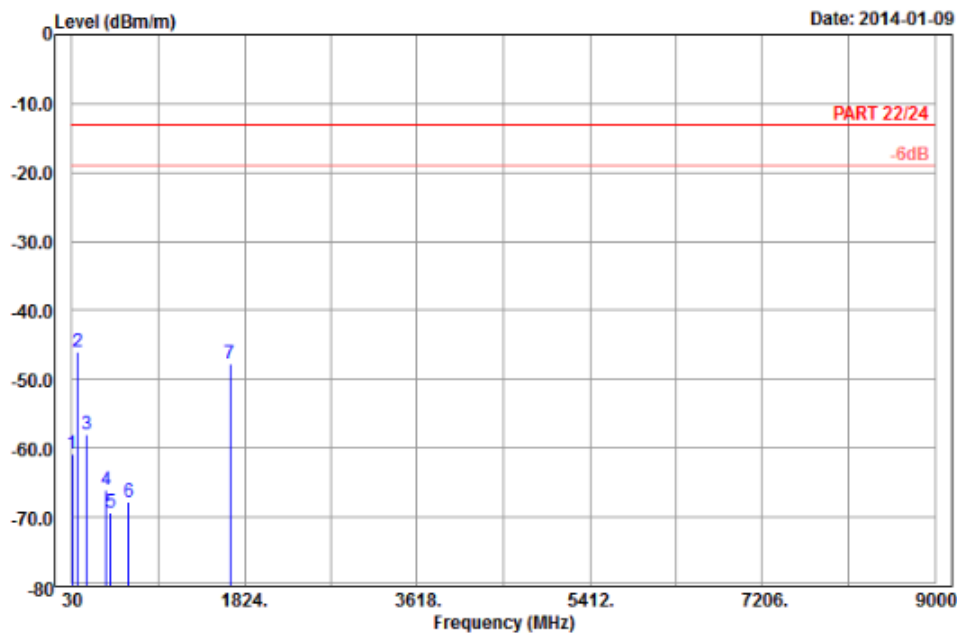

Site : 966 chamber 5
 Condition : PART 22/24 3m Horizontal
 Brand/Model: LVP9
 Remark : GPRS_850_Link
 Tested by : Kay wu
 Temperature : 25°C
 Humidity : 65%
 Plane : Z(2nd)

	Freq	Level	Read Level	Limit Line	Over Limit	Factor	Remark
	MHz	dBm/m	dBm	dBm/m	dB	dB/m	
1	31.62	-60.84	-50.08	-13.00	-47.84	-10.76	Peak
2	92.37	-46.00	-35.44	-13.00	-33.00	-10.56	Peak
3	182.55	-57.96	-52.35	-13.00	-44.96	-5.61	Peak
4	381.90	-66.09	-62.42	-13.00	-53.09	-3.67	Peak
5	435.10	-69.39	-65.86	-13.00	-56.39	-3.53	Peak
6	622.70	-67.76	-67.93	-13.00	-54.76	0.17	Peak
7	1672.80	-47.65	-55.56	-13.00	-34.65	7.91	Peak



A D T



Bureau Veritas Consumer Products Services Ltd., Taoyuan Branch

A D T

Data: 10

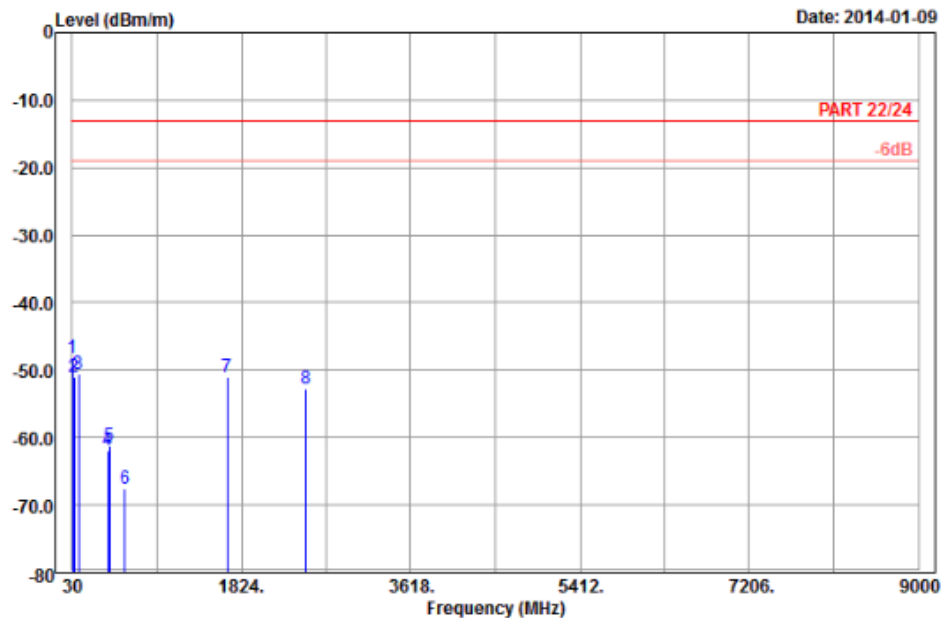

Site : 966 chamber 5
 Condition : PART 22/24 3m Vertical
 Brand/Model: LVP9
 Remark : GPRS_850_Link
 Tested by : Kay wu
 Temperature : 25°C
 Humidity : 65%
 Plane : Z(2nd)

	Freq	Level	Read	Limit	Over		
	MHz	dBm/m	Level	Line	Limit	Factor	Remark
	MHz	dBm/m	dBm	dBm/m	dB	dB/m	
1	pp	31.62	-48.14	-37.38	-13.00	-35.14	-10.76 Peak
2		47.28	-51.02	-37.91	-13.00	-38.02	-13.11 Peak
3		93.99	-50.58	-40.13	-13.00	-37.58	-10.45 Peak
4		407.80	-61.92	-59.01	-13.00	-48.92	-2.91 Peak
5		423.90	-61.26	-57.99	-13.00	-48.26	-3.27 Peak
6		588.40	-67.54	-67.49	-13.00	-54.54	-0.05 Peak
7		1672.80	-50.92	-58.83	-13.00	-37.92	7.91 Peak
8		2509.20	-52.73	-64.01	-13.00	-39.73	11.28 Peak



A D T

5 PHOTOGRAPHS OF THE TEST CONFIGURATION

Please refer to the attached file (Test Setup Photo).



6 INFORMATION ON THE TESTING LABORATORIES

We, Bureau Veritas Consumer Products Services (H.K.) Ltd., Taoyuan Branch, were founded in 1988 to provide our best service in EMC, Radio, Telecom and Safety consultation. Our laboratories are accredited and approved according to ISO/IEC 17025.

If you have any comments, please feel free to contact us at the following:

Linko EMC/RF Lab:

Tel: 886-2-26052180

Fax: 886-2-26051924

Hsin Chu EMC/RF Lab:

Tel: 886-3-5935343

Fax: 886-3-5935342

Hwa Ya EMC/RF/Safety/Telecom Lab:

Tel: 886-3-3183232

Fax: 886-3-3270892

Email: service.adt@tw.bureauveritas.com

Web Site: www.bureauveritas-adt.com

The address and road map of all our labs can be found in our web site also.



A D T

7 APPENDIX A – MODIFICATIONS RECORDERS FOR ENGINEERING CHANGES TO THE EUT BY THE LAB

No any modifications were made to the EUT by the lab during the test.

---END---