

# Variant FCC SAR Test Report

APPLICANT : Lenovo (Shanghai) Electronics Technology Co., Ltd.  
EQUIPMENT : Portable Tablet Computer  
BRAND NAME : lenovo  
MODEL NAME : Lenovo A3300-HV  
MARKETING NAME : Lenovo A3300-HV  
FCC ID : O57A3300HV  
STANDARD : FCC 47 CFR Part 2 (2.1093)  
ANSI/IEEE C95.1-1992  
IEEE 1528-2003

This is a variant report which is only valid together with the original test report. We, SPORTON INTERNATIONAL (SHENZHEN) INC., would like to declare that the tested sample has been evaluated in accordance with the procedures and had been in compliance with the applicable technical standards.

The test results in this report apply exclusively to the tested model / sample. Without written approval of SPORTON INTERNATIONAL (SHENZHEN) INC., the test report shall not be reproduced except in full.

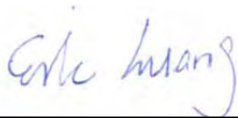

Reviewed by: Eric Huang / Deputy Manager



Approved by: Jones Tsai / Manager



**SPORTON INTERNATIONAL (SHENZHEN) INC.**

No. 101, Complex Building C, Guanlong Village, Xili Town, Nanshan District, Shenzhen, Guangdong, P.R.C.



## Table of Contents

<b>1. Statement of Compliance</b> .....	<b>4</b>
<b>2. Administration Data</b> .....	<b>5</b>
<b>3. Guidance Standard</b> .....	<b>5</b>
<b>4. Equipment Under Test (EUT)</b> .....	<b>6</b>
4.1 General Information .....	6
4.2 Maximum Tune-up Limit .....	7
<b>5. RF Exposure Limits</b> .....	<b>8</b>
5.1 Uncontrolled Environment .....	8
5.2 Controlled Environment .....	8
<b>6. Specific Absorption Rate (SAR)</b> .....	<b>9</b>
6.1 Introduction .....	9
6.2 SAR Definition .....	9
<b>7. System Description and Setup</b> .....	<b>10</b>
<b>8. Measurement Procedures</b> .....	<b>11</b>
8.1 Spatial Peak SAR Evaluation .....	11
8.2 Power Reference Measurement .....	12
8.3 Area Scan .....	12
8.4 Zoom Scan .....	13
8.5 Volume Scan Procedures .....	13
8.6 Power Drift Monitoring .....	13
<b>9. Test Equipment List</b> .....	<b>14</b>
<b>10. System Verification</b> .....	<b>15</b>
10.1 Tissue Verification .....	15
10.2 System Performance Check Results .....	16
<b>11. RF Exposure Positions</b> .....	<b>17</b>
11.1 Ear and handset reference point .....	17
11.2 Definition of the cheek position .....	18
11.3 Definition of the tilt position .....	19
11.4 SAR Testing for Tablet .....	19
<b>12. Conducted RF Output Power (Unit: dBm)</b> .....	<b>20</b>
<b>13. Bluetooth Exclusions Applied</b> .....	<b>26</b>
<b>14. Antenna Location</b> .....	<b>27</b>
<b>15. SAR Test Results</b> .....	<b>28</b>
15.1 Head SAR .....	28
15.2 Body SAR .....	29
15.3 Repeated SAR Measurement .....	30
<b>16. Simultaneous Transmission Analysis</b> .....	<b>31</b>
16.1 Head Exposure Conditions .....	32
16.2 Body Exposure Conditions .....	33
16.3 SPLSR Evaluation and Analysis .....	34
<b>17. Uncertainty Assessment</b> .....	<b>35</b>
<b>18. References</b> .....	<b>37</b>
<b>Appendix A. Plots of System Performance Check</b>	
<b>Appendix B. Plots of High SAR Measurement</b>	
<b>Appendix C. DASYS Calibration Certificate</b>	
<b>Appendix D. Test Setup Photos</b>	
<b>Appendix E. Product Equality Declaration</b>	





### 1. Statement of Compliance

The maximum results of Specific Absorption Rate (SAR) found during testing for **Lenovo (Shanghai) Electronics Technology Co., Ltd., Portable Tablet Computer, Lenovo A3300-HV** are as follows.

Equipment Class	Frequency Band	Operating Mode	Highest SAR Summary		
			Head 1g SAR (W/kg)	Body 1g SAR (W/kg)	Simultaneous Transmission SAR (W/kg)
PCB	GSM850	Voice/Data	0.43	0.70	1.34
	GSM1900	Voice/Data	<b>0.92</b>	0.71	
	WCDMA Band V	Voice/Data	0.36	0.58	
	WCDMA Band II	Voice/Data	0.92	0.78	
DTS	WLAN 2.4GHz Band	Data	0.48	<b>1.34</b>	1.34
DSS	Bluetooth	Data			1.01
Date of Testing:			Oct. 28, 2014 ~ Nov. 10, 2014		

This device is in compliance with Specific Absorption Rate (SAR) for general population/uncontrolled exposure limits (1.6 W/kg) specified in FCC 47 CFR part 2 (2.1093) and ANSI/IEEE C95.1-1992, and had been tested in accordance with the measurement methods and procedures specified in IEEE 1528-2003.



**2. Administration Data**

Testing Laboratory	
Test Site	SPORTON INTERNATIONAL (SHENZHEN) INC.
Test Site Location	No. 101, Complex Building C, Guanlong Village, Xili Town, Nanshan District, Shenzhen, Guangdong, P.R.C. TEL: +86-755-8637-9589 FAX: +86-755-8637-9595

Applicant	
Company Name	Lenovo (Shanghai) Electronics Technology Co., Ltd.
Address	No. 68 Building, 199 Fenju Road, Wai Gao Qiao FTZ, Shanghai, China

Manufacturer	
Company Name	Lenovo PC HK Limited
Address	23/F, Lincoln House, Taikoo Place 979 King's Road, Quarry Bay, Hong Kong

**3. Guidance Standard**

The Specific Absorption Rate (SAR) testing specification, method, and procedure for this device is in accordance with the following standards:

- FCC 47 CFR Part 2 (2.1093)
- ANSI/IEEE C95.1-1992
- IEEE 1528-2003
- FCC KDB 865664 D01 SAR Measurement 100 MHz to 6 GHz v01r03
- FCC KDB 865664 D02 SAR Reporting v01r01
- FCC KDB 447498 D01 General RF Exposure Guidance v05r02
- FCC KDB 248227 D01 SAR meas for 802 11abg v01r02
- FCC KDB 616217 D04 SAR for laptop and tablets v01r01
- FCC KDB 941225 D01 3G SAR Procedures v03



**4. Equipment Under Test (EUT)**

**4.1 General Information**

Product Feature & Specification	
Equipment Name	Portable Tablet Computer
Brand Name	lenovo
Model Name	Lenovo A3300-HV
Marketing Name	Lenovo A3300-HV
FCC ID	O57A3300HV
IMEI Code	863352020008984
Wireless Technology and Frequency Range	GSM850: 824.2 MHz ~ 848.8 MHz GSM1900: 1850.2 MHz ~ 1909.8 MHz WCDMA Band V: 826.4 MHz ~ 846.6 MHz WCDMA Band II: 1852.4 MHz ~ 1907.6 MHz WLAN 2.4GHz Band: 2412 MHz ~ 2462 MHz Bluetooth: 2402 MHz ~ 2480 MHz
Mode	<ul style="list-style-type: none"> <li>• GSM/GPRS/EGPRS</li> <li>• RMC/AMR 12.2Kbps</li> <li>• HSDPA</li> <li>• HSUPA</li> <li>• HSPA+ (Downlink Only)</li> <li>• 802.11b/g/nHT20/HT40</li> <li>• Bluetooth v3.0+EDR, Bluetooth v4.0 LE</li> </ul>
HW Version	A977_MB_PCB_V4.0
SW Version	A3300HV_A442_01_06_140505_ROW_ENG
GSM / (E)GPRS Transfer mode	Class B – EUT cannot support Packet Switched and Circuit Switched Network simultaneously but can automatically switch between Packet and Circuit Switched Network.
EUT Stage	Pre-Production
<b>Remark:</b>	
<ol style="list-style-type: none"> <li>1. This device supported VoIP in GPRS, EGPRS and WCDMA (e.g. 3rd party VoIP).</li> <li>2. This device supports GRPS/EGPRS mode up to multi-slot class12.</li> <li>3. This device does not support DTM function.</li> </ol>	

**4.2 Maximum Tune-up Limit**

Burst Average Power (dBm)				
Mode / Band	GSM850		GSM1900	
Output Power Status	Full power mode	Reduced power mode	Full power mode	Reduced power mode
GSM (GMSK, 1 Tx slot)	32.5	28.0	29.5	24.5
GPRS (GMSK, 1 Tx slot)	32.5	28.0	29.5	24.5
GPRS (GMSK, 2 Tx slots)	30.0	25.5	27.0	22.5
GPRS (GMSK, 3 Tx slots)	28.5	24.0	25.0	21.0
GPRS (GMSK, 4 Tx slots)	27.5	23.0	24.5	20.5
EDGE (8PSK, 1 Tx slot)	27.5	22.5	26.5	21.0
EDGE (8PSK, 2 Tx slots)	26.0	21.0	25.5	18.0
EDGE (8PSK, 3 Tx slots)	24.0	19.0	23.5	16.5
EDGE (8PSK, 4 Tx slots)	23.0	17.0	22.5	15.0

Average Power (dBm)				
Mode / Band	WCDMA Band V		WCDMA Band II	
Output Power Status	Full power mode	Reduced power mode	Full power mode	Reduced power mode
AMR 12.2K	22.5	17.5	22.5	17.5
RMC 12.2K	22.5	17.5	22.5	17.5
HSDPA Subtest-1	21.5	17.0	21.5	16.5
HSDPA Subtest-2	21.5	17.0	21.5	16.5
HSDPA Subtest-3	21.5	16.5	21.5	16.0
HSDPA Subtest-4	21.5	16.5	21.5	16.0
HSUPA Subtest-1	20.0	15.0	19.5	15.0
HSUPA Subtest-2	20.0	15.0	19.5	15.0
HSUPA Subtest-3	20.0	16.0	19.5	15.0
HSUPA Subtest-4	20.0	15.0	19.5	14.0
HSUPA Subtest-5	21.0	17.0	21.0	16.5

Mode			Average Power (dBm)
2.4GHz	802.11b	CH01	13.0
		CH06	13.0
		CH11	13.5
	802.11g		9.0
	802.11n-HT20		8.0
	802.11n-HT40		8.0
Bluetooth v3.0+EDR			3.0
Bluetooth v4.0 LE			-5.0



## 5. RF Exposure Limits

### 5.1 Uncontrolled Environment

Uncontrolled Environments are defined as locations where there is the exposure of individuals who have no knowledge or control of their exposure. The general population/uncontrolled exposure limits are applicable to situations in which the general public may be exposed or in which persons who are exposed as a consequence of their employment may not be made fully aware of the potential for exposure or cannot exercise control over their exposure. Members of the general public would come under this category when exposure is not employment-related; for example, in the case of a wireless transmitter that exposes persons in its vicinity.

### 5.2 Controlled Environment

Controlled Environments are defined as locations where there is exposure that may be incurred by persons who are aware of the potential for exposure, (i.e. as a result of employment or occupation). In general, occupational/controlled exposure limits are applicable to situations in which persons are exposed as a consequence of their employment, who have been made fully aware of the potential for exposure and can exercise control over their exposure. The exposure category is also applicable when the exposure is of a transient nature due to incidental passage through a location where the exposure levels may be higher than the general population/uncontrolled limits, but the exposed person is fully aware of the potential for exposure and can exercise control over his or her exposure by leaving the area or by some other appropriate means.

**Limits for Occupational/Controlled Exposure (W/kg)**

Whole-Body	Partial-Body	Hands, Wrists, Feet and Ankles
0.4	8.0	20.0

**Limits for General Population/Uncontrolled Exposure (W/kg)**

Whole-Body	Partial-Body	Hands, Wrists, Feet and Ankles
0.08	1.6	4.0

Whole-Body SAR is averaged over the entire body, partial-body SAR is averaged over any 1gram of tissue defined as a tissue volume in the shape of a cube. SAR for hands, wrists, feet and ankles is averaged over any 10 grams of tissue defined as a tissue volume in the shape of a cube.



## **6. Specific Absorption Rate (SAR)**

### **6.1 Introduction**

SAR is related to the rate at which energy is absorbed per unit mass in an object exposed to a radio field. The SAR distribution in a biological body is complicated and is usually carried out by experimental techniques or numerical modeling. The standard recommends limits for two tiers of groups, occupational/controlled and general population/uncontrolled, based on a person's awareness and ability to exercise control over his or her exposure. In general, occupational/controlled exposure limits are higher than the limits for general population/uncontrolled.

### **6.2 SAR Definition**

The SAR definition is the time derivative (rate) of the incremental energy (dW) absorbed by (dissipated in) an incremental mass (dm) contained in a volume element (dv) of a given density ( $\rho$ ). The equation description is as below:

$$SAR = \frac{d}{dt} \left( \frac{dW}{dm} \right) = \frac{d}{dt} \left( \frac{dW}{\rho dv} \right)$$

SAR is expressed in units of Watts per kilogram (W/kg)

$$SAR = \frac{\sigma |E|^2}{\rho}$$

Where:  $\sigma$  is the conductivity of the tissue,  $\rho$  is the mass density of the tissue and E is the RMS electrical field strength.

## **7. System Description and Setup**

The DASY system used for performing compliance tests consists of the following items:

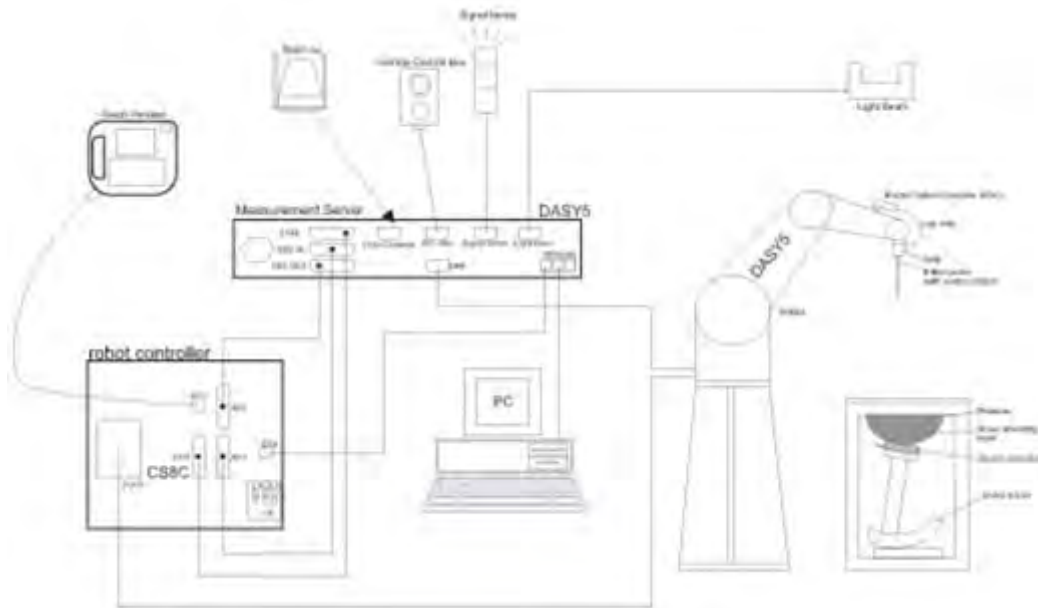

- A standard high precision 6-axis robot with controller, teach pendant and software. An arm extension for accommodating the data acquisition electronics (DAE).
- An isotropic Field probe optimized and calibrated for the targeted measurement.
- A data acquisition electronics (DAE) which performs the signal amplification, signal multiplexing, AD-conversion, offset measurements, mechanical surface detection, collision detection, etc. The unit is battery powered with standard or rechargeable batteries. The signal is optically transmitted to the EOC.
- The Electro-optical converter (EOC) performs the conversion from optical to electrical signals for the digital communication to the DAE. To use optical surface detection, a special version of the EOC is required. The EOC signal is transmitted to the measurement server.
- The function of the measurement server is to perform the time critical tasks such as signal filtering, control of the robot operation and fast movement interrupts.
- The Light Beam used is for probe alignment. This improves the (absolute) accuracy of the probe positioning.
- A computer running WinXP or Win7 and the DASY5 software.
- Remote control and teach pendant as well as additional circuitry for robot safety such as warning lamps, etc.
- The phantom, the device holder and other accessories according to the targeted measurement.



## **8. Measurement Procedures**

The measurement procedures are as follows:

### <Conducted power measurement>

- (a) For WWAN power measurement, use base station simulator to configure EUT WWAN transmission in conducted connection with RF cable, at maximum power in each supported wireless interface and frequency band.
- (b) Read the WWAN RF power level from the base station simulator.
- (c) For WLAN/BT power measurement, use engineering software to configure EUT WLAN/BT continuously transmission, at maximum RF power in each supported wireless interface and frequency band
- (d) Connect EUT RF port through RF cable to the power meter, and measure WLAN/BT output power

### <SAR measurement>

- (a) Use base station simulator to configure EUT WWAN transmission in radiated connection, and engineering software to configure EUT WLAN/BT continuously transmission, at maximum RF power, in the highest power channel.
- (b) Place the EUT in the positions as Appendix D demonstrates.
- (c) Set scan area, grid size and other setting on the DASY software.
- (d) Measure SAR results for the highest power channel on each testing position.
- (e) Find out the largest SAR result on these testing positions of each band
- (f) Measure SAR results for other channels in worst SAR testing position if the reported SAR of highest power channel is larger than 0.8 W/kg

According to the test standard, the recommended procedure for assessing the peak spatial-average SAR value consists of the following steps:

- (a) Power reference measurement
- (b) Area scan
- (c) Zoom scan
- (d) Power drift measurement

### **8.1 Spatial Peak SAR Evaluation**

The procedure for spatial peak SAR evaluation has been implemented according to the test standard. It can be conducted for 1g and 10g, as well as for user-specific masses. The DASY software includes all numerical procedures necessary to evaluate the spatial peak SAR value.

The base for the evaluation is a "cube" measurement. The measured volume must include the 1g and 10g cubes with the highest averaged SAR values. For that purpose, the center of the measured volume is aligned to the interpolated peak SAR value of a previously performed area scan.

The entire evaluation of the spatial peak values is performed within the post-processing engine (SEMCAD). The system always gives the maximum values for the 1g and 10g cubes. The algorithm to find the cube with highest averaged SAR is divided into the following stages:

- (a) Extraction of the measured data (grid and values) from the Zoom Scan
- (b) Calculation of the SAR value at every measurement point based on all stored data (A/D values and measurement parameters)
- (c) Generation of a high-resolution mesh within the measured volume
- (d) Interpolation of all measured values from the measurement grid to the high-resolution grid
- (e) Extrapolation of the entire 3-D field distribution to the phantom surface over the distance from sensor to surface
- (f) Calculation of the averaged SAR within masses of 1g and 10g

**8.2 Power Reference Measurement**

The Power Reference Measurement and Power Drift Measurements are for monitoring the power drift of the device under test in the batch process. The minimum distance of probe sensors to surface determines the closest measurement point to phantom surface. This distance cannot be smaller than the distance of sensor calibration points to probe tip as defined in the probe properties.

**8.3 Area Scan**

The area scan is used as a fast scan in two dimensions to find the area of high field values, before doing a fine measurement around the hot spot. The sophisticated interpolation routines implemented in DASY software can find the maximum found in the scanned area, within a range of the global maximum. The range (in dB0 is specified in the standards for compliance testing. For example, a 2 dB range is required in IEEE standard 1528 and IEC 62209 standards, whereby 3 dB is a requirement when compliance is assessed in accordance with the ARIB standard (Japan), if only one zoom scan follows the area scan, then only the absolute maximum will be taken as reference. For cases where multiple maximums are detected, the number of zoom scans has to be increased accordingly.

Area scan parameters extracted from FCC KDB 865664 D01v01r03 SAR measurement 100 MHz to 6 GHz.

	$\leq 3$ GHz	$> 3$ GHz
Maximum distance from closest measurement point (geometric center of probe sensors) to phantom surface	$5 \pm 1$ mm	$\frac{1}{2} \cdot \delta \cdot \ln(2) \pm 0.5$ mm
Maximum probe angle from probe axis to phantom surface normal at the measurement location	$30^\circ \pm 1^\circ$	$20^\circ \pm 1^\circ$
Maximum area scan spatial resolution: $\Delta x_{Area}, \Delta y_{Area}$	$\leq 2$ GHz: $\leq 15$ mm $2 - 3$ GHz: $\leq 12$ mm	$3 - 4$ GHz: $\leq 12$ mm $4 - 6$ GHz: $\leq 10$ mm
	When the x or y dimension of the test device, in the measurement plane orientation, is smaller than the above, the measurement resolution must be $\leq$ the corresponding x or y dimension of the test device with at least one measurement point on the test device.	

**8.4 Zoom Scan**

Zoom scans are used assess the peak spatial SAR values within a cubic averaging volume containing 1 gram and 10 gram of simulated tissue. The zoom scan measures points (refer to table below) within a cube shoes base faces are centered on the maxima found in a preceding area scan job within the same procedure. When the measurement is done, the zoom scan evaluates the averaged SAR for 1 gram and 10 gram and displays these values next to the job's label.

Zoom scan parameters extracted from FCC KDB 865664 D01v01r03 SAR measurement 100 MHz to 6 GHz.

		≤ 3 GHz	> 3 GHz	
Maximum zoom scan spatial resolution: $\Delta x_{Zoom}, \Delta y_{Zoom}$		$\leq 2$ GHz: $\leq 8$ mm 2 – 3 GHz: $\leq 5$ mm*	3 – 4 GHz: $\leq 5$ mm* 4 – 6 GHz: $\leq 4$ mm*	
Maximum zoom scan spatial resolution, normal to phantom surface	uniform grid: $\Delta z_{Zoom}(n)$	$\leq 5$ mm	3 – 4 GHz: $\leq 4$ mm 4 – 5 GHz: $\leq 3$ mm 5 – 6 GHz: $\leq 2$ mm	
	graded grid	$\Delta z_{Zoom}(1)$ : between 1 <sup>st</sup> two points closest to phantom surface	$\leq 4$ mm	3 – 4 GHz: $\leq 3$ mm 4 – 5 GHz: $\leq 2.5$ mm 5 – 6 GHz: $\leq 2$ mm
		$\Delta z_{Zoom}(n>1)$ : between subsequent points	$\leq 1.5 \cdot \Delta z_{Zoom}(n-1)$	
Minimum zoom scan volume	x, y, z	$\geq 30$ mm	3 – 4 GHz: $\geq 28$ mm 4 – 5 GHz: $\geq 25$ mm 5 – 6 GHz: $\geq 22$ mm	
Note: $\delta$ is the penetration depth of a plane-wave at normal incidence to the tissue medium; see draft standard IEEE P1528-2011 for details. * When zoom scan is required and the <i>reported</i> SAR from the <i>area scan based 1-g SAR estimation</i> procedures of KDB 447498 is $\leq 1.4$ W/kg, $\leq 8$ mm, $\leq 7$ mm and $\leq 5$ mm zoom scan resolution may be applied, respectively, for 2 GHz to 3 GHz, 3 GHz to 4 GHz and 4 GHz to 6 GHz.				

**8.5 Volume Scan Procedures**

The volume scan is used for assess overlapping SAR distributions for antennas transmitting in different frequency bands. It is equivalent to an oversized zoom scan used in standalone measurements. The measurement volume will be used to enclose all the simultaneous transmitting antennas. For antennas transmitting simultaneously in different frequency bands, the volume scan is measured separately in each frequency band. In order to sum correctly to compute the 1g aggregate SAR, the EUT remain in the same test position for all measurements and all volume scan use the same spatial resolution and grid spacing. When all volume scan were completed, the software, SEMCAD postprocessor can combine and subsequently superpose these measurement data to calculating the multiband SAR.

**8.6 Power Drift Monitoring**

All SAR testing is under the EUT install full charged battery and transmit maximum output power. In DASYS measurement software, the power reference measurement and power drift measurement procedures are used for monitoring the power drift of EUT during SAR test. Both these procedures measure the field at a specified reference position before and after the SAR testing. The software will calculate the field difference in dB. If the power drifts more than 5%, the SAR will be retested.



### 9. Test Equipment List

Manufacturer	Name of Equipment	Type/Model	Serial Number	Calibration	
				Last Cal.	Due Date
SPEAG	835MHz System Validation Kit	D835V2	4d151	Mar. 25, 2013	Mar. 23, 2015
SPEAG	1900MHz System Validation Kit	D1900V2	5d170	Mar. 27, 2013	Mar. 25, 2015
SPEAG	2450MHz System Validation Kit	D2450V2	908	Mar. 26, 2013	Mar. 24, 2015
SPEAG	Data Acquisition Electronics	DAE4	910	Jul. 22, 2014	Jul. 21, 2015
SPEAG	Dosimetric E-Field Probe	EX3DV4	3661	Mar. 10, 2014	Mar. 09, 2015
SPEAG	SAM Twin Phantom	QD 000 P40 CD	TP-1670	NCR	NCR
SPEAG	SAM Twin Phantom	QD 000 P40 CD	TP-1671	NCR	NCR
SPEAG	ELI4 Phantom	QD OVA 002 AA	1149	NCR	NCR
SPEAG	Phone Positioner	N/A	N/A	NCR	NCR
Anritsu	Radio communication analyzer	MT8820C	6201300653	Jul. 17, 2014	Jul. 16, 2015
R&S	Network Analyzer	ZVB8	100106	Sep. 29, 2014	Sep. 28, 2015
Speag	Dielectric Assessment Kit	DAK-3.5	1032	NCR	NCR
Anritsu	Power Meter	ML2495A	1218010	Mar. 03, 2014	Mar. 02, 2015
Anritsu	Power Sensor	MA2411B	1207253	Mar. 03, 2014	Mar. 02, 2015
ARRA	Power Divider	A3200-2	N/A	NA	NA
R&S	Spectrum Analyzer	FSP30	101362	Sep. 29, 2014	Sep. 28, 2015
Agilent	Dual Directional Coupler	778D	50422	Note1	
Woken	Attenuator 1	WK0602-XX	N/A	Note1	
PE	Attenuator 2	PE7005-10	N/A	Note1	
PE	Attenuator 3	PE7005- 3	N/A	Note1	
AR	Power Amplifier	5S1G4M2	0328767	Note1	
Mini-Circuits	Power Amplifier	ZVE-3W	162601250	Note1	
Mini-Circuits	Power Amplifier	ZHL-42W+	13440021344	Note1	

**General Note:**

1. Prior to system verification and validation, the path loss from the signal generator to the system check source and the power meter, which includes the amplifier, cable, attenuator and directional coupler, was measured by the network analyzer. The reading of the power meter was offset by the path loss difference between the path to the power meter and the path to the system check source to monitor the actual power level fed to the system check source.
2. Referring to KDB 865664 D01v01r03, the dipole calibration interval can be extended to 3 years with justification. The dipoles are also not physically damaged, or repaired during the interval.
3. The justification data of dipole D835V2, SN: 4d151, D1900V2, SN: 5d170 and D2450V2, SN: 908 can be found in appendix C. The return loss is < -20dB, within 20% of prior calibration, the impedance is within 5 ohm of prior calibration.



**10. System Verification**

**10.1 Tissue Verification**

The following tissue formulations are provided for reference only as some of the parameters have not been thoroughly verified. The composition of ingredients may be modified accordingly to achieve the desired target tissue parameters required for routine SAR evaluation.

Frequency (MHz)	Water (%)	Sugar (%)	Cellulose (%)	Salt (%)	Preventol (%)	DGBE (%)	Conductivity (σ)	Permittivity (ε <sub>r</sub> )
<b>For Head</b>								
835	40.3	57.9	0.2	1.4	0.2	0	0.90	41.5
1800, 1900, 2000	55.2	0	0	0.3	0	44.5	1.40	40.0
2450	55.0	0	0	0	0	45.0	1.80	39.2
<b>For Body</b>								
835	50.8	48.2	0	0.9	0.1	0	0.97	55.2
1800, 1900, 2000	70.2	0	0	0.4	0	29.4	1.52	53.3
2450	68.6	0	0	0	0	31.4	1.95	52.7

**<Tissue Dielectric Parameter Check Results>**

Frequency (MHz)	Tissue Type	Liquid Temp. (°C)	Conductivity (σ)	Permittivity (ε <sub>r</sub> )	Conductivity Target (σ)	Permittivity Target (ε <sub>r</sub> )	Delta (σ) (%)	Delta (ε <sub>r</sub> ) (%)	Limit (%)	Date
835	Head	22.6	0.914	41.826	0.90	41.50	1.56	0.79	±5	Oct. 28, 2014
1900	Head	22.6	1.422	40.315	1.40	40.00	1.57	0.79	±5	Oct. 28, 2014
2450	Head	22.8	1.829	40.081	1.80	39.20	1.61	2.25	±5	Oct. 28, 2014
835	Body	22.8	0.974	54.111	0.97	55.20	0.41	-1.97	±5	Nov. 09, 2014
1900	Body	22.7	1.542	53.532	1.52	53.30	1.45	0.44	±5	Nov. 06, 2014
2450	Body	22.7	1.992	52.319	1.95	52.70	2.15	-0.72	±5	Nov. 10, 2014



**10.2 System Performance Check Results**

Comparing to the original SAR value provided by SPEAG, the verification data should be within its specification of 10 %. Below table shows the target SAR and measured SAR after normalized to 1W input power. The table below indicates the system performance check can meet the variation criterion and the plots can be referred to Appendix A of this report.

Date	Frequency (MHz)	Tissue Type	Input Power (mW)	Dipole S/N	Probe S/N	DAE S/N	Measured SAR (W/kg)	Targeted SAR (W/kg)	Normalized SAR (W/kg)	Deviation (%)
Oct. 28, 2014	835	Head	250	4d151	3661	910	2.30	9.49	9.2	-3.06
Oct. 28, 2014	1900	Head	250	5d170	3661	910	9.39	40.20	37.56	-6.57
Oct. 28, 2014	2450	Head	250	908	3661	910	13.40	54.00	53.6	-0.74
Nov. 09, 2014	835	Body	250	4d151	3661	910	2.45	9.43	9.8	3.92
Nov. 06, 2014	1900	Body	250	5d170	3661	910	10.10	41.20	40.4	-1.94
Nov. 10, 2014	2450	Body	250	908	3661	910	12.20	50.40	48.8	-3.17

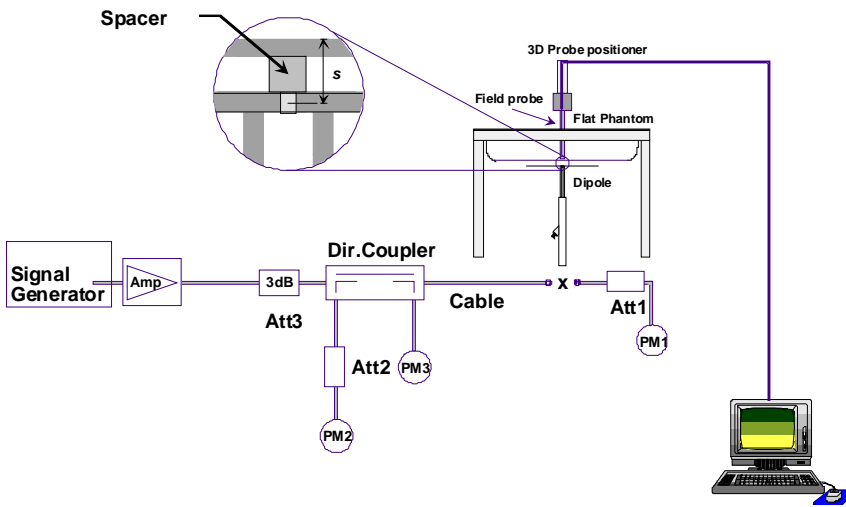

**Fig 8.3.1 System Performance Check Setup**



**Fig 8.3.2 Setup Photo**



## 11. RF Exposure Positions

### 11.1 Ear and handset reference point

Figure 9.1.1 shows the front, back, and side views of the SAM phantom. The center-of-mouth reference point is labeled “M,” the left ear reference point (ERP) is marked “LE,” and the right ERP is marked “RE.” Each ERP is 15 mm along the B-M (back-mouth) line behind the entrance-to-ear-canal (EEC) point, as shown in Figure 9.1.2 The Reference Plane is defined as passing through the two ear reference points and point M. The line N-F (neck-front), also called the reference pivoting line, is normal to the Reference Plane and perpendicular to both a line passing through RE and LE and the B-M line (see Figure 9.1.3). Both N-F and B-M lines should be marked on the exterior of the phantom shell to facilitate handset positioning. Posterior to the N-F line the ear shape is a flat surface with 6 mm thickness at each ERP, and forward of the N-F line the ear is truncated, as illustrated in Figure 9.1.2. The ear truncation is introduced to preclude the ear lobe from interfering with handset tilt, which could lead to unstable positioning at the cheek.

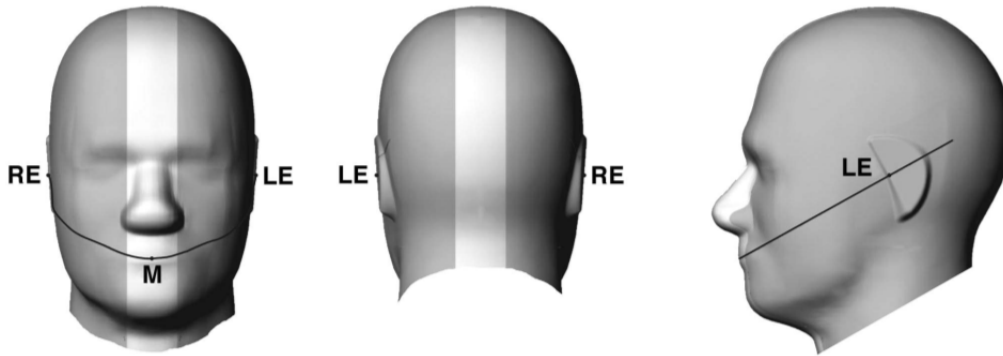

Fig 9.1.1 Front, back, and side views of SAM twin phantom

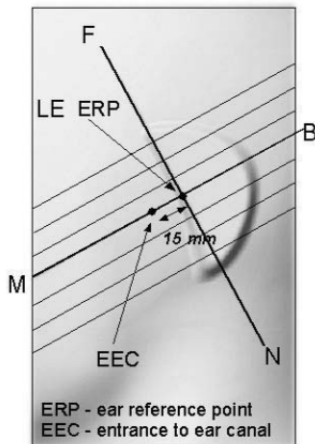

Fig 9.1.2 Close-up side view of phantom showing the ear region.

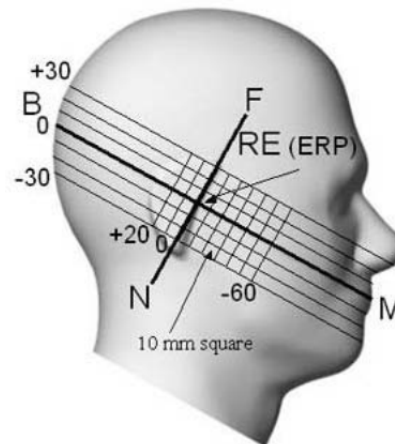
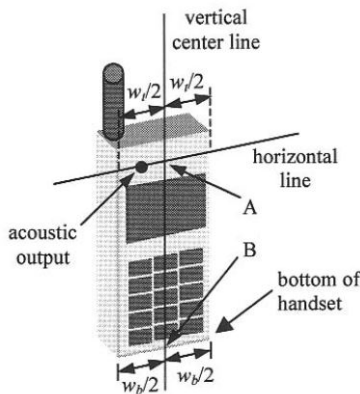

Fig 9.1.3 Side view of the phantom showing relevant markings and seven cross-sectional plane locations

**11.2 Definition of the cheek position**

1. Ready the handset for talk operation, if necessary. For example, for handsets with a cover piece (flip cover), open the cover. If the handset can transmit with the cover closed, both configurations must be tested.
2. Define two imaginary lines on the handset—the vertical centerline and the horizontal line. The vertical centerline passes through two points on the front side of the handset—the midpoint of the width  $w_t$  of the handset at the level of the acoustic output (point A in Figure 9.2.1 and Figure 9.2.2), and the midpoint of the width  $w_b$  of the bottom of the handset (point B). The horizontal line is perpendicular to the vertical centerline and passes through the center of the acoustic output (see Figure 9.2.1). The two lines intersect at point A. Note that for many handsets, point A coincides with the center of the acoustic output; however, the acoustic output may be located elsewhere on the horizontal line. Also note that the vertical centerline is not necessarily parallel to the front face of the handset (see Figure 9.2.2), especially for clamshell handsets, handsets with flip covers, and other irregularly-shaped handsets.
3. Position the handset close to the surface of the phantom such that point A is on the (virtual) extension of the line passing through points RE and LE on the phantom (see Figure 9.2.3), such that the plane defined by the vertical centerline and the horizontal line of the handset is approximately parallel to the sagittal plane of the phantom.
4. Translate the handset towards the phantom along the line passing through RE and LE until handset point A touches the pinna at the ERP.
5. While maintaining the handset in this plane, rotate it around the LE-RE line until the vertical centerline is in the plane normal to the plane containing B-M and N-F lines, i.e., the Reference Plane.
6. Rotate the handset around the vertical centerline until the handset (horizontal line) is parallel to the N-F line.
7. While maintaining the vertical centerline in the Reference Plane, keeping point A on the line passing through RE and LE, and maintaining the handset contact with the pinna, rotate the handset about the N-F line until any point on the handset is in contact with a phantom point below the pinna on the cheek. See Figure 9.2.3. The actual rotation angles should be documented in the test report.



**Fig 9.2.1 Handset vertical and horizontal reference lines—“fixed case”**

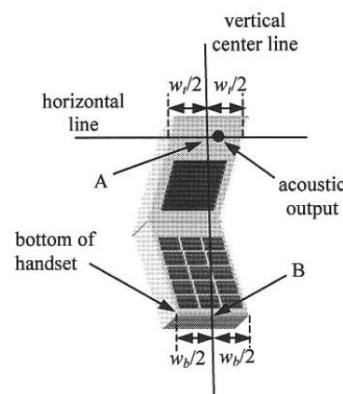

**Fig 9.2.2 Handset vertical and horizontal reference lines—“clam-shell case”**

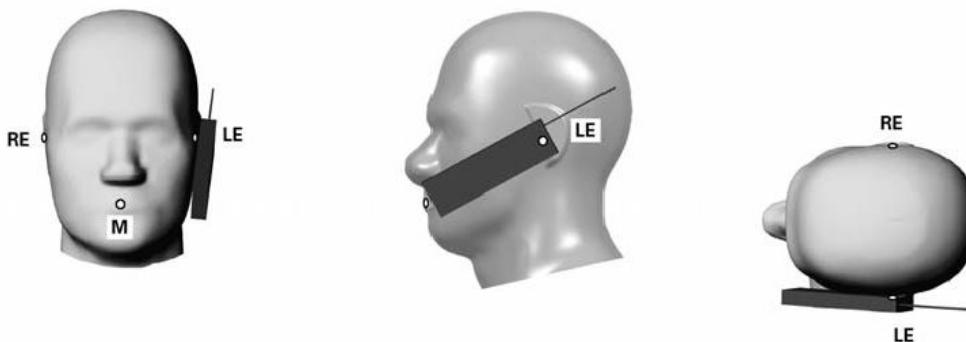

**Fig 9.2.3 cheek or touch position. The reference points for the right ear (RE), left ear (LE), and mouth (M), which establish the Reference Plane for handset positioning, are indicated.**

**11.3 Definition of the tilt position**

1. Ready the handset for talk operation, if necessary. For example, for handsets with a cover piece (flip cover), open the cover. If the handset can transmit with the cover closed, both configurations must be tested.
2. While maintaining the orientation of the handset, move the handset away from the pinna along the line passing through RE and LE far enough to allow a rotation of the handset away from the cheek by 15°.
3. Rotate the handset around the horizontal line by 15°.
4. While maintaining the orientation of the handset, move the handset towards the phantom on the line passing through RE and LE until any part of the handset touches the ear. The tilt position is obtained when the contact point is on the pinna. See Figure 9.3.1. If contact occurs at any location other than the pinna, e.g., the antenna at the back of the phantom head, the angle of the handset should be reduced. In this case, the tilt position is obtained if any point on the handset is in contact with the pinna and a second point

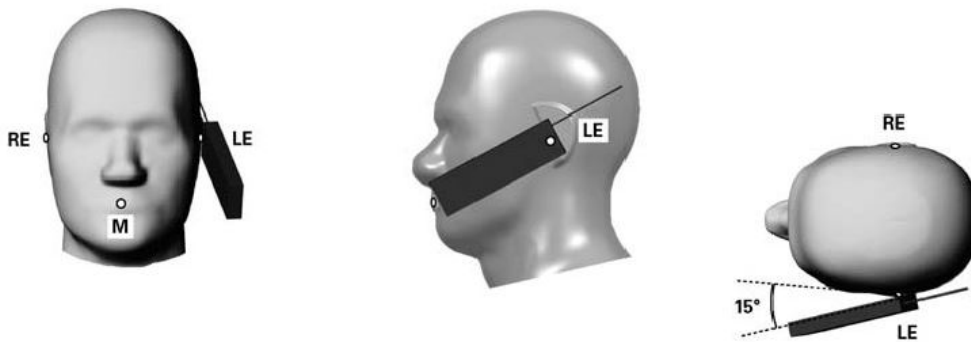

**Fig 9.3.1 Tilt position. The reference points for the right ear (RE), left ear (LE), and mouth (M), which define the Reference Plane for handset positioning, are indicated.**

**11.4 SAR Testing for Tablet**

This device can be used also in full sized tablet exposure conditions, due to its size. Per FCC KDB 616217, the back surface and edges of the tablet should be tested for SAR compliance with the tablet touching the phantom. The SAR exclusion threshold in KDB 447498 D01v05r02 can be applied to determine SAR test exclusion for adjacent edge configurations. The closest distance from the antenna to an adjacent tablet edge is used to determine if SAR testing is required for the adjacent edges, with the adjacent edge positioned against the phantom and the edge containing the antenna positioned perpendicular to the phantom.

**12. Conducted RF Output Power (Unit: dBm)**

**<GSM Conducted Power>**

**Maximum Average RF Power (Proximity Sensor Inactive)**

Band GSM850	Burst Average Power (dBm)			Tune-up Limit (dBm)	Frame-Average Power (dBm)			Tune-up Limit (dBm)
	Tx Channel	128	189		251	128	189	
Frequency (MHz)	824.2	836.4	848.8		824.2	836.4	848.8	
GSM (GMSK, 1 Tx slot)	31.71	32.12	<b>32.16</b>	32.5	22.71	23.12	23.16	23.5
GPRS (GMSK, 1 Tx slot) – CS1	31.70	32.11	32.15	32.5	22.70	23.11	23.15	23.5
GPRS (GMSK, 2 Tx slots) – CS1	29.40	29.85	29.85	30.0	23.40	23.85	23.85	24.0
GPRS (GMSK, 3 Tx slots) – CS1	27.34	27.78	27.73	28.5	23.08	23.52	23.47	24.24
GPRS (GMSK, 4 Tx slots) – CS1	26.43	26.91	26.86	27.5	23.43	<b>23.91</b>	23.86	24.5
EDGE (8PSK, 1 Tx slot) – MCS5	27.03	26.94	26.79	27.5	18.03	17.94	17.79	18.0
EDGE (8PSK, 2 Tx slots) – MCS5	25.92	25.80	25.79	26.0	19.92	19.80	19.79	20.0
EDGE (8PSK, 3 Tx slots) – MCS5	23.98	23.90	23.75	24.0	19.72	19.64	19.49	19.74
EDGE (8PSK, 4 Tx slots) – MCS5	22.94	22.83	22.69	23.0	19.94	19.83	19.69	20.0
Band GSM1900	Burst Average Power (dBm)			Tune-up Limit (dBm)	Frame-Average Power (dBm)			Tune-up Limit (dBm)
TX Channel	512	661	810		512	661	810	
Frequency (MHz)	1850.2	1880	1909.8		1850.2	1880	1909.8	
GSM (GMSK, 1 Tx slot)	28.92	29.13	<b>29.24</b>	29.5	19.92	20.13	20.24	20.5
GPRS (GMSK, 1 Tx slot) – CS1	28.91	29.12	29.23	29.5	19.91	20.12	20.23	20.5
GPRS (GMSK, 2 Tx slots) – CS1	26.79	26.81	26.98	27.0	20.79	20.81	20.98	21.0
GPRS (GMSK, 3 Tx slots) – CS1	24.70	24.92	24.99	25.0	20.44	20.66	20.73	20.74
GPRS (GMSK, 4 Tx slots) – CS1	24.02	24.23	24.29	24.5	21.02	21.23	<b>21.29</b>	21.5
EDGE (8PSK, 1 Tx slot) – MCS5	25.50	25.72	25.71	26.5	16.50	16.72	16.71	17.5
EDGE (8PSK, 2 Tx slots) – MCS5	24.48	24.56	24.59	25.5	18.48	18.56	18.59	19.5
EDGE (8PSK, 3 Tx slots) – MCS5	22.26	22.42	22.48	23.5	18.00	18.16	18.22	19.24
EDGE (8PSK, 4 Tx slots) – MCS5	21.22	21.34	21.36	22.5	18.22	18.34	18.36	19.5

Remark: The frame-averaged power is linearly scaled the maximum burst averaged power over 8 time slots.

The calculated method are shown as below:

Frame-averaged power = Maximum burst averaged power (1 Tx Slot) - 9 dB

Frame-averaged power = Maximum burst averaged power (2 Tx Slots) - 6 dB

Frame-averaged power = Maximum burst averaged power (3 Tx Slots) - 4.26 dB

Frame-averaged power = Maximum burst averaged power (4 Tx Slots) - 3 dB



**Reduced Average RF Power (Proximity Sensor active)**

Band GSM850	Burst Average Power (dBm)			Tune-up Limit (dBm)	Frame-Average Power (dBm)			Tune-up Limit (dBm)	
	128	189	251		128	189	251		
Tx Channel	128	189	251		128	189	251		
Frequency (MHz)	824.2	836.4	848.8		824.2	836.4	848.8		
GSM (GMSK, 1 Tx slot)	26.73	<b>27.17</b>	27.12	28.0	17.73	18.17	18.12	19.0	
GPRS (GMSK, 1 Tx slot) – CS1	26.71	27.15	27.11	28.0	17.71	18.15	18.11	19.0	
GPRS (GMSK, 2 Tx slots) – CS1	24.03	24.05	24.04	25.5	18.03	18.05	18.04	19.5	
GPRS (GMSK, 3 Tx slots) – CS1	22.05	22.23	22.24	24.0	17.79	17.97	17.98	19.74	
GPRS (GMSK, 4 Tx slots) – CS1	21.03	21.33	21.31	23.0	18.03	<b>18.33</b>	18.31	20.0	
EDGE (8PSK, 1 Tx slot) – MCS5	22.33	22.16	22.15	22.5	13.33	13.16	13.15	13.5	
EDGE (8PSK, 2 Tx slots) – MCS5	19.37	19.24	19.13	21.0	13.37	13.24	13.13	15.0	
EDGE (8PSK, 3 Tx slots) – MCS5	17.58	17.42	17.36	19.0	13.32	13.16	13.10	14.74	
EDGE (8PSK, 4 Tx slots) – MCS5	16.34	16.14	16.13	17.0	13.34	13.14	13.13	14.0	
Band GSM1900		Burst Average Power (dBm)			Tune-up Limit (dBm)	Frame-Average Power (dBm)			Tune-up Limit (dBm)
TX Channel		512	661	810		512	661	810	
Frequency (MHz)		1850.2	1880	1909.8		1850.2	1880	1909.8	
GSM (GMSK, 1 Tx slot)		24.14	24.32	<b>24.36</b>	24.5	15.14	15.32	15.36	15.5
GPRS (GMSK, 1 Tx slot) – CS1		24.13	24.30	24.35	24.5	15.13	15.30	15.35	15.5
GPRS (GMSK, 2 Tx slots) – CS1		21.05	21.27	21.30	22.5	15.05	15.27	15.30	16.5
GPRS (GMSK, 3 Tx slots) – CS1		19.58	19.78	19.62	21.0	15.32	15.52	15.36	16.74
GPRS (GMSK, 4 Tx slots) – CS1		18.57	18.79	18.84	20.5	15.57	15.79	<b>15.84</b>	17.5
EDGE (8PSK, 1 Tx slot) – MCS5		20.45	20.56	20.60	21.0	11.45	11.56	11.60	12.0
EDGE (8PSK, 2 Tx slots) – MCS5		17.46	17.56	17.64	18.0	11.46	11.56	11.64	12.0
EDGE (8PSK, 3 Tx slots) – MCS5		15.75	15.82	15.87	16.5	11.49	11.56	11.61	12.24
EDGE (8PSK, 4 Tx slots) – MCS5		14.57	14.67	14.71	15.0	11.57	11.67	11.71	12.0

Remark: The frame-averaged power is linearly scaled the maximum burst averaged power over 8 time slots.

The calculated method are shown as below:

- Frame-averaged power = Maximum burst averaged power (1 Tx Slot) - 9 dB
- Frame-averaged power = Maximum burst averaged power (2 Tx Slots) - 6 dB
- Frame-averaged power = Maximum burst averaged power (3 Tx Slots) - 4.26 dB
- Frame-averaged power = Maximum burst averaged power (4 Tx Slots) - 3 dB



**<WCDMA Conducted Power>**

1. The following tests were conducted according to the test requirements outlines in 3GPP TS 34.121 specification.
2. The procedures in KDB 941225 D01 are applied for 3GPP Rel. 6 HSPA to configure the device in the required sub-test mode(s) to determine SAR test exclusion.

A summary of these settings are illustrated below:

**HSDPA Setup Configuration:**

- a. The EUT was connected to Base Station Agilent E5515C referred to the Setup Configuration.
- b. The RF path losses were compensated into the measurements.
- c. A call was established between EUT and Base Station with following setting:
  - i. Set Gain Factors ( $\beta_c$  and  $\beta_d$ ) and parameters were set according to each
  - ii. Specific sub-test in the following table, C10.1.4, quoted from the TS 34.121
  - iii. Set RMC 12.2Kbps + HSDPA mode.
  - iv. Set Cell Power = -86 dBm
  - v. Set HS-DSCH Configuration Type to FRC (H-set 1, QPSK)
  - vi. Select HSDPA Uplink Parameters
  - vii. Set Delta ACK, Delta NACK and Delta CQI = 8
  - viii. Set Ack-Nack Repetition Factor to 3
  - ix. Set CQI Feedback Cycle (k) to 4 ms
  - x. Set CQI Repetition Factor to 2
  - xi. Power Ctrl Mode = All Up bits
- d. The transmitted maximum output power was recorded.

**Table C.10.1.4:  $\beta$  values for transmitter characteristics tests with HS-DPCCH**

Sub-test	$\beta_c$	$\beta_d$	$\beta_d$ (SF)	$\beta_c/\beta_d$	$\beta_{HS}$ (Note 1, Note 2)	CM (dB) (Note 3)	MPR (dB) (Note 3)
1	2/15	15/15	64	2/15	4/15	0.0	0.0
2	12/15 (Note 4)	15/15 (Note 4)	64	12/15 (Note 4)	24/15	1.0	0.0
3	15/15	8/15	64	15/8	30/15	1.5	0.5
4	15/15	4/15	64	15/4	30/15	1.5	0.5

Note 1:  $\Delta_{ACK}, \Delta_{NACK}$  and  $\Delta_{CQI} = 30/15$  with  $\beta_{HS} = 30/15 * \beta_c$ .

Note 2: For the HS-DPCCH power mask requirement test in clause 5.2C, 5.7A, and the Error Vector Magnitude (EVM) with HS-DPCCH test in clause 5.13.1A, and HSDPA EVM with phase discontinuity in clause 5.13.1AA,  $\Delta_{ACK}$  and  $\Delta_{NACK} = 30/15$  with  $\beta_{HS} = 30/15 * \beta_c$ , and  $\Delta_{CQI} = 24/15$  with  $\beta_{HS} = 24/15 * \beta_c$ .

Note 3: CM = 1 for  $\beta_c/\beta_d = 12/15, \beta_{HS}/\beta_c = 24/15$ . For all other combinations of DPDCCH, DPCCH and HS-DPCCH the MPR is based on the relative CM difference. This is applicable for only UEs that support HSDPA in release 6 and later releases.

Note 4: For subtest 2 the  $\beta_c/\beta_d$  ratio of 12/15 for the TFC during the measurement period (TF1, TF0) is achieved by setting the signalled gain factors for the reference TFC (TF1, TF1) to  $\beta_c = 11/15$  and  $\beta_d = 15/15$ .

**Setup Configuration**

**HSUPA Setup Configuration:**

- a. The EUT was connected to Base Station Agilent E5515C referred to the Setup Configuration.
- b. The RF path losses were compensated into the measurements.
- c. A call was established between EUT and Base Station with following setting \* :
  - i. Call Configs = 5.2B, 5.9B, 5.10B, and 5.13.2B with QPSK
  - ii. Set the Gain Factors ( $\beta_c$  and  $\beta_d$ ) and parameters (AG Index) were set according to each specific sub-test in the following table, C11.1.3, quoted from the TS 34.121
  - iii. Set Cell Power = -86 dBm
  - iv. Set Channel Type = 12.2k + HSPA
  - v. Set UE Target Power
  - vi. Power Ctrl Mode= Alternating bits
  - vii. Set and observe the E-TFCl
  - viii. Confirm that E-TFCl is equal to the target E-TFCl of 75 for sub-test 1, and other subtest's E-TFCl
- d. The transmitted maximum output power was recorded.

**Table C.11.1.3:  $\beta$  values for transmitter characteristics tests with HS-DPCCH and E-DCH**

Sub-test	$\beta_c$	$\beta_d$	$\beta_d$ (SF)	$\beta_c/\beta_d$	$\beta_{HS}$ (Note 1)	$\beta_{ec}$	$\beta_{ed}$ (Note 5) (Note 6)	$\beta_{ed}$ (SF)	$\beta_{ed}$ (Codes)	CM (dB) (Note 2)	MPR (dB) (Note 2)	AG Index (Note 6)	E-TFCl
1	11/15 (Note 3)	15/15 (Note 3)	64	11/15 (Note 3)	22/15	209/25	1309/225	4	1	1.0	0.0	20	75
2	6/15	15/15	64	6/15	12/15	12/15	94/75	4	1	3.0	2.0	12	67
3	15/15	9/15	64	15/9	30/15	30/15	$\beta_{ed1}: 47/15$ $\beta_{ed2}: 47/15$	4 4	2	2.0	1.0	15	92
4	2/15	15/15	64	2/15	4/15	2/15	56/75	4	1	3.0	2.0	17	71
5	15/15 (Note 4)	15/15 (Note 4)	64	15/15 (Note 4)	30/15	24/15	134/15	4	1	1.0	0.0	21	81

Note 1:  $\Delta_{ACK}, \Delta_{NACK}$  and  $\Delta_{CQI} = 30/15$  with  $\beta_{hs} = 30/15 * \beta_c$ .

Note 2: CM = 1 for  $\beta_c/\beta_d = 12/15$ ,  $\beta_{hs}/\beta_c = 24/15$ . For all other combinations of DPDCH, DPCCH, HS-DPCCH, E-DPDCH and E-DPCCH the MPR is based on the relative CM difference.

Note 3: For subtest 1 the  $\beta_c/\beta_d$  ratio of 11/15 for the TFC during the measurement period (TF1, TF0) is achieved by setting the signalled gain factors for the reference TFC (TF1, TF1) to  $\beta_c = 10/15$  and  $\beta_d = 15/15$ .

Note 4: For subtest 5 the  $\beta_c/\beta_d$  ratio of 15/15 for the TFC during the measurement period (TF1, TF0) is achieved by setting the signalled gain factors for the reference TFC (TF1, TF1) to  $\beta_c = 14/15$  and  $\beta_d = 15/15$ .

Note 5: In case of testing by UE using E-DPDCH Physical Layer category 1, Sub-test 3 is omitted according to TS25.306 Table 5.1g.

Note 6:  $\beta_{ed}$  can not be set directly, it is set by Absolute Grant Value.

**Setup Configuration**



<WCDMA Conducted Power>

Maximum Average RF Power (Proximity Sensor Inactive)

Band			WCDMA Band V				WCDMA Band II			
Tx Channel			4132	4182	4233	Tune-up Limit (dBm)	9262	9400	9538	Tune-up Limit (dBm)
Rx Channel			4357	4407	4458		9662	9800	9938	
Frequency (MHz)			826.4	836.4	846.6		1852.4	1880	1907.6	
MPR (dB)	3GPP Rel 99	AMR 12.2Kbps	21.35	21.47	21.41	22.5	21.26	<b>21.38</b>	21.25	22.5
	3GPP Rel 99	RMC 12.2Kbps	21.37	<b>21.48</b>	21.42	22.5	21.27	<b>21.38</b>	21.26	22.5
0	3GPP Rel 6	HSDPA Subtest-1	20.63	20.70	20.65	21.5	20.15	20.23	20.06	21.5
0	3GPP Rel 6	HSDPA Subtest-2	20.60	20.71	20.67	21.5	20.14	20.22	20.04	21.5
0.5	3GPP Rel 6	HSDPA Subtest-3	20.13	20.23	19.86	21.5	19.68	19.78	19.58	21.5
0.5	3GPP Rel 6	HSDPA Subtest-4	20.11	20.22	19.44	21.5	19.65	19.75	19.58	21.5
0	3GPP Rel 6	HSUPA Subtest-1	18.66	18.76	18.71	20.0	18.14	18.26	18.15	19.5
2	3GPP Rel 6	HSUPA Subtest-2	18.64	18.74	18.68	20.0	18.16	18.26	18.14	19.5
1	3GPP Rel 6	HSUPA Subtest-3	19.61	19.73	19.72	20.0	19.17	19.25	19.14	19.5
2	3GPP Rel 6	HSUPA Subtest-4	18.08	18.20	18.19	20.0	17.63	17.73	17.62	19.5
0	3GPP Rel 6	HSUPA Subtest-5	20.60	20.80	20.70	21.0	20.20	20.20	20.10	21.0

Reduced Average RF Power (Proximity Sensor active)

Band			WCDMA Band V				WCDMA Band II			
Tx Channel			4132	4182	4233	Tune-up Limit (dBm)	9262	9400	9538	Tune-up Limit (dBm)
Rx Channel			4357	4407	4458		9662	9800	9938	
Frequency (MHz)			826.4	836.4	846.6		1852.4	1880	1907.6	
MPR (dB)	3GPP Rel 99	AMR 12.2Kbps	16.61	16.69	16.65	17.5	16.33	<b>16.43</b>	16.39	17.5
	3GPP Rel 99	RMC 12.2Kbps	16.62	<b>16.70</b>	16.66	17.5	16.34	<b>16.43</b>	16.40	17.5
0	3GPP Rel 6	HSDPA Subtest-1	16.60	16.65	16.64	17.0	16.17	16.28	16.17	16.5
0	3GPP Rel 6	HSDPA Subtest-2	16.56	16.62	16.60	17.0	16.17	16.27	16.18	16.5
0.5	3GPP Rel 6	HSDPA Subtest-3	16.21	16.29	16.28	16.5	15.68	15.81	15.72	16.0
0.5	3GPP Rel 6	HSDPA Subtest-4	16.19	16.28	16.28	16.5	15.69	15.78	15.73	16.0
0	3GPP Rel 6	HSUPA Subtest-1	14.75	14.83	14.80	15.0	14.33	14.47	14.24	15.0
2	3GPP Rel 6	HSUPA Subtest-2	14.67	14.79	14.74	15.0	14.31	14.44	14.23	15.0
1	3GPP Rel 6	HSUPA Subtest-3	15.67	15.81	15.77	16.0	14.39	14.52	14.26	15.0
2	3GPP Rel 6	HSUPA Subtest-4	14.24	14.30	14.30	15.0	13.82	13.93	13.70	14.0
0	3GPP Rel 6	HSUPA Subtest-5	16.60	16.67	16.63	17.0	16.20	16.30	16.20	16.5





**<WLAN Conducted Power>**

WLAN 2.4GHz 802.11b Average Power (dBm)							Tune up Limit (dBm)
Power vs. Channel			Power vs. Data Rate				
Channel	Frequency (MHz)	Data Rate 1Mbps	Channel	2Mbps	5.5Mbps	11Mbps	
CH 01	2412	11.64	CH 11	12.35	12.42	12.32	13.0
CH 06	2437	11.91					13.0
CH 11	2462	<b>12.43</b>					13.5

WLAN 2.4GHz 802.11g Average Power (dBm)											Tune up Limit (dBm)
Power vs. Channel			Power vs. Data Rate								
Channel	Frequency (MHz)	Data Rate 6Mbps	Channel	9Mbps	12Mbps	18Mbps	24Mbps	36Mbps	48Mbps	54Mbps	
CH 01	2412	7.73	CH 11	8.44	8.29	8.28	8.24	8.37	8.36	8.41	9.0
CH 06	2437	8.05									
CH 11	2462	<b>8.46</b>									

WLAN 2.4GHz 802.11n HT20 Average Power (dBm)											Tune up Limit (dBm)
Power vs. Channel			Power vs. MCS Index								
Channel	Frequency (MHz)	MCS Index MCS0	Channel	MCS1	MCS2	MCS3	MCS4	MCS5	MCS6	MCS7	
CH 01	2412	6.78	CH 11	7.52	7.54	7.56	7.55	7.47	7.40	7.40	8.0
CH 06	2437	7.16									
CH 11	2462	<b>7.59</b>									

WLAN 2.4GHz 802.11n HT40 Average Power (dBm)											Tune up Limit (dBm)
Power vs. Channel			Power vs. MCS Index								
Channel	Frequency (MHz)	MCS Index MCS0	Channel	MCS1	MCS2	MCS3	MCS4	MCS5	MCS6	MCS7	
CH 03	2422	6.75	CH 09	7.41	7.31	7.36	7.40	7.39	7.40	7.39	8.0
CH 06	2437	7.16									
CH 09	2452	<b>7.42</b>									

### **13. Bluetooth Exclusions Applied**

Mode Band	Average power(dBm)	
	Bluetooth v3.0+EDR	Bluetooth v4.0 LE
2.4GHz Bluetooth	3.0	-5.0

**Note:**

Per KDB 447498 D01v05r02, the 1-g and 10-g SAR test exclusion thresholds for 100 MHz to 6 GHz at *test separation distances* ≤ 50 mm are determined by:

$[(\text{max. power of channel, including tune-up tolerance, mW}) / (\text{min. test separation distance, mm})] \cdot [\sqrt{f(\text{GHz})}] \leq 3.0$  for 1-g SAR and ≤ 7.5 for 10-g extremity SAR

- f(GHz) is the RF channel transmit frequency in GHz
- Power and distance are rounded to the nearest mW and mm before calculation
- The result is rounded to one decimal place for comparison

Bluetooth Max Power (dBm)	Separation Distance (mm)	Frequency (GHz)	exclusion thresholds
3.0	0	2.48	0.6

**Note:**

Per KDB 447498 D01v05r02, when the minimum test separation distance is < 5 mm, a distance of 5 mm is applied to determine SAR test exclusion. The test exclusion threshold is 0.6 which is ≤ 3, SAR testing is not required.

### 14. Antenna Location

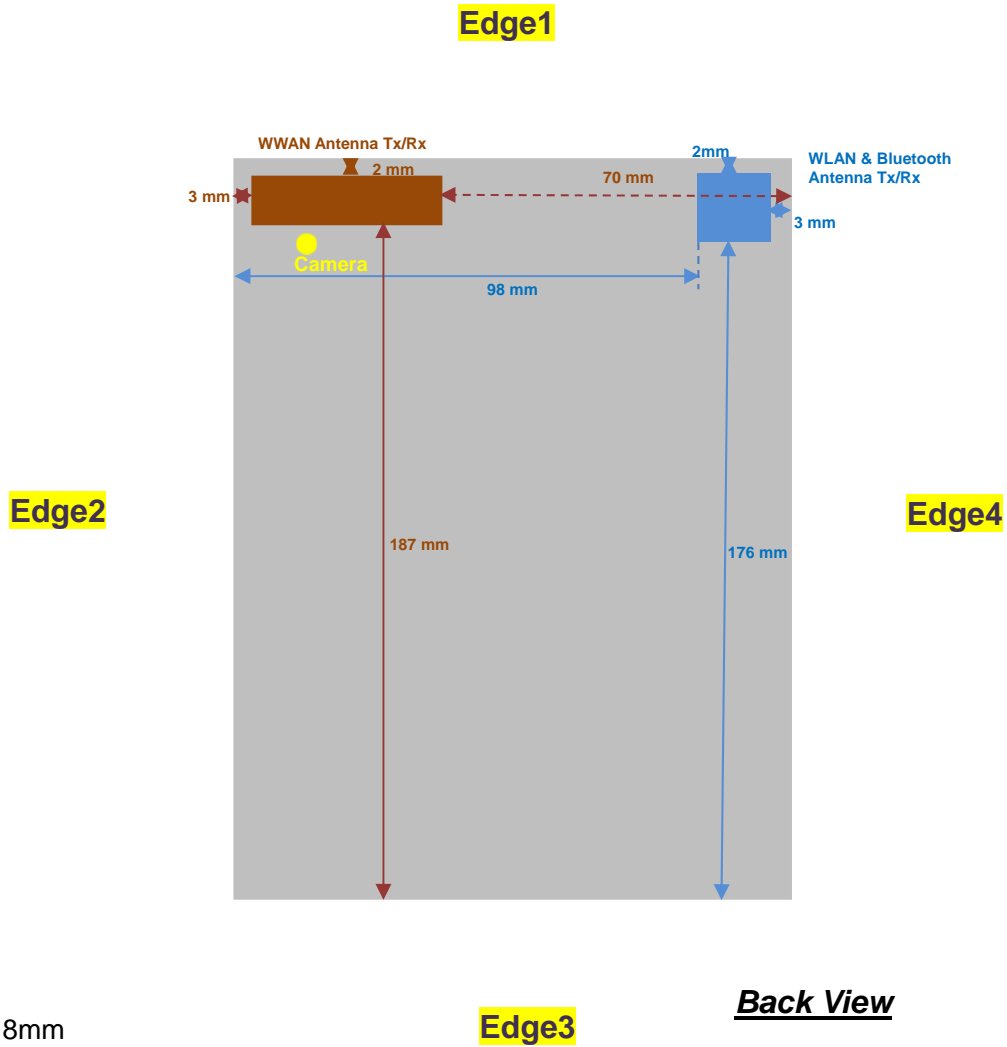

Diagonal: 218mm

**Back View**



## 15. SAR Test Results

**General Note:**

1. Per KDB 447498 D01v05r02, the reported SAR is the measured SAR value adjusted for maximum tune-up tolerance.
  - a. Tune-up scaling Factor = tune-up limit power (mW) / EUT RF power (mW), where tune-up limit is the maximum rated power among all production units.
  - b. Reported SAR(W/kg)= Measured SAR(W/kg)\*Tune-up Scaling Factor
2. Per KDB 447498 D01v05r02, for each exposure position, testing of other required channels within the operating mode of a frequency band is not required when the *reported* 1-g or 10-g SAR for the mid-band or highest output power channel is:
  - ≤ 0.8 W/kg or 2.0 W/kg, for 1-g or 10-g respectively, when the transmission band is ≤ 100 MHz
  - ≤ 0.6 W/kg or 1.5 W/kg, for 1-g or 10-g respectively, when the transmission band is between 100 MHz and 200 MHz
  - ≤ 0.4 W/kg or 1.0 W/kg, for 1-g or 10-g respectively, when the transmission band is ≥ 200 MHz
3. Additional WLAN 2.4GHz SAR with Left Cheek and Edge1 testing were performed for simultaneous transmission analysis.

### 15.1 Head SAR

**<GSM SAR>**

Plot No.	Band	Mode	Test Position	Power Back-off	Ch.	Freq. (MHz)	Average Power (dBm)	Tune-Up Limit (dBm)	Tune-up Scaling Factor	Power Drift (dB)	Measured 1g SAR (W/kg)	Reported 1g SAR (W/kg)
#01	GSM850	GPRS (4 Tx slots)	Left Cheek	Sensor on	251	848.8	21.31	23.00	1.476	0.08	0.292	<b>0.431</b>
	GSM1900	GPRS (4 Tx slots)	Left Cheek	Sensor on	661	1880	18.79	20.50	1.483	-0.04	0.570	0.845
	GSM1900	GPRS (4 Tx slots)	Left Cheek	Sensor on	512	1850.2	18.57	20.50	1.560	-0.09	0.479	0.747
#02	GSM1900	GPRS (4 Tx slots)	Left Cheek	Sensor on	810	1909.8	18.84	20.50	1.466	0.04	0.627	<b>0.919</b>

**<WCDMA SAR>**

Plot No.	Band	Mode	Test Position	Power Back-off	Ch.	Freq. (MHz)	Average Power (dBm)	Tune-Up Limit (dBm)	Tune-up Scaling Factor	Power Drift (dB)	Measured 1g SAR (W/kg)	Reported 1g SAR (W/kg)
#03	WCDMA Band V	RMC 12.2Kbps	Left Cheek	Sensor on	4182	836.4	16.70	17.50	1.202	0.01	0.299	<b>0.359</b>
#04	WCDMA Band II	RMC 12.2Kbps	Left Cheek	Sensor on	9538	1907.6	16.40	17.50	1.288	-0.02	0.715	<b>0.921</b>
	WCDMA Band II	RMC 12.2Kbps	Left Cheek	Sensor on	9262	1852.4	16.34	17.50	1.306	0.09	0.627	0.819
	WCDMA Band II	RMC 12.2Kbps	Left Cheek	Sensor on	9400	1880	16.43	17.50	1.279	-0.01	0.651	0.833

**<DTS WLAN SAR>**

Plot No.	Band	Mode	Test Position	Ch.	Freq. (MHz)	Average Power (dBm)	Tune-Up Limit (dBm)	Tune-up Scaling Factor	Power Drift (dB)	Measured 1g SAR (W/kg)	Reported 1g SAR (W/kg)
#05	WLAN 2.4GHz	802.11b 1Mbps	Right Cheek	11	2462	12.43	13.50	1.279	0.06	0.376	<b>0.481</b>
	WLAN 2.4GHz	802.11b 1Mbps	Left Cheek	11	2462	12.43	13.50	1.279	0.05	0.058	0.074



15.2 Body SAR

<GSM SAR>

Plot No.	Band	Mode	Test Position	Gap (cm)	Power Back-off	Ch.	Freq. (MHz)	Average Power (dBm)	Tune-Up Limit (dBm)	Tune-up Scaling Factor	Power Drift (dB)	Measured 1g SAR (W/kg)	Reported 1g SAR (W/kg)
#06	GSM850	GPRS (4 Tx slots)	Bottom Face	0	Sensor on	251	848.8	21.31	23.00	1.476	-0.09	0.472	0.697
#07	GSM1900	GPRS (4 Tx slots)	Edge 1	0.4	Sensor off	810	1909.8	24.29	24.50	1.050	-0.01	0.673	0.706

<WCDMA SAR>

Plot No.	Band	Mode	Test Position	Gap (cm)	Power Back-off	Ch.	Freq. (MHz)	Average Power (dBm)	Tune-Up Limit (dBm)	Tune-up Scaling Factor	Power Drift (dB)	Measured 1g SAR (W/kg)	Reported 1g SAR (W/kg)
#08	WCDMA Band V	RMC 12.2Kbps	Bottom Face	0	Sensor on	4182	836.4	16.70	17.50	1.202	0.04	0.482	0.579
#09	WCDMA Band II	RMC 12.2Kbps	Edge 1	0.4	Sensor off	9400	1880	21.38	22.50	1.294	-0.05	0.606	0.784

<DTS WLAN SAR>

Plot No.	Band	Mode	Test Position	Gap (cm)	Ch.	Freq. (MHz)	Average Power (dBm)	Tune-Up Limit (dBm)	Tune-up Scaling Factor	Power Drift (dB)	Measured 1g SAR (W/kg)	Reported 1g SAR (W/kg)
#10	WLAN 2.4GHz	802.11b 1Mbps	Bottom Face	0	11	2462	12.43	13.50	1.279	-0.09	1.050	1.343
	WLAN 2.4GHz	802.11b 1Mbps	Bottom Face	0	1	2412	11.64	13.00	1.368	-0.17	0.902	1.234
	WLAN 2.4GHz	802.11b 1Mbps	Bottom Face	0	6	2437	11.91	13.00	1.285	0.09	0.966	1.242
	WLAN 2.4GHz	802.11b 1Mbps	Edge 1	0	11	2462	12.43	13.50	1.279	0.02	0.144	0.184



15.3 Repeated SAR Measurement

No.	Band	Mode	Test Position	Gap (cm)	Ch.	Freq. (MHz)	Average Power (dBm)	Tune-Up Limit (dBm)	Tune-up Scaling Factor	Power Drift (dB)	Measured 1g SAR (W/kg)	Ratio	Reported 1g SAR (W/kg)
1st	WLAN 2.4GHz	802.11b 1Mbps	Bottom Face	0	11	2462	12.43	13.50	1.279	-0.09	1.050	1	1.343
2nd	WLAN 2.4GHz	802.11b 1Mbps	Bottom Face	0	11	2462	12.43	13.50	1.279	-0.01	0.984	1.067	1.259

General Note:

1. Per KDB 865664 D01v01r03, for each frequency band, repeated SAR measurement is required only when the measured SAR is  $\geq 0.8$ W/kg
2. Per KDB 865664 D01v01r03, if the ratio among the repeated measurement is  $\leq 1.2$  and the measured SAR  $< 1.45$ W/kg, only one repeated measurement is required.
3. The ratio is the difference in percentage between original and repeated *measured* SAR.
4. All measurement SAR result is scaled-up to account for tune-up tolerance and is compliant.

**16. Simultaneous Transmission Analysis**

NO.	Simultaneous Transmission Configurations	Head	Body	Note
1.	GSM(voice) + WLAN 2.4GHz(data)	Yes		
2.	WCDMA(voice) + WLAN 2.4GHz(data)	Yes		
3.	GSM(voice) + Bluetooth(data)	Yes		
4.	WCDMA(voice) + Bluetooth(data)	Yes		
5.	GPRS/EDGE(data) + WLAN 2.4GHz(data)	Yes	Yes	2.4GHz Hotspot
6.	WCDMA(data) + WLAN 2.4GHz(data)	Yes	Yes	2.4GHz Hotspot
7.	GPRS/EDGE(data) + Bluetooth(data)	Yes	Yes	Bluetooth Tethering
8.	WCDMA(data) + Bluetooth(data)	Yes	Yes	Bluetooth Tethering

**General Note:**

1. This device supported VoIP in GPRS, EGPRS and WCDMA (e.g. 3rd party VoIP).
2. WLAN 2.4GHz and Bluetooth share the same antenna, and cannot transmit simultaneously.
3. EUT will choose either GSM or WCDMA according to the network signal condition; therefore, they will not operate simultaneously at any moment.
4. For simultaneous transmission analysis for exposure position of edge1 0.4cm, WLAN SAR tested at 0mm separation is worse and the test data is used for conservative SAR summation.
5. The reported SAR summation is calculated based on the same configuration and test position.
6. Per KDB 447498 D01v05r02, simultaneous transmission SAR is compliant if,
  - i) Scalar SAR summation < 1.6W/kg.
  - ii)  $SPLSR = (SAR_1 + SAR_2)^{1.5} / (min. separation distance, mm)$ , and the peak separation distance is determined from the square root of  $[(x_1-x_2)^2 + (y_1-y_2)^2 + (z_1-z_2)^2]$ , where  $(x_1, y_1, z_1)$  and  $(x_2, y_2, z_2)$  are the coordinates of the extrapolated peak SAR locations in the zoom scan.
  - iii) If  $SPLSR \leq 0.04$ , simultaneously transmission SAR measurement is not necessary.
  - iv) Simultaneously transmission SAR measurement, and the reported multi-band SAR < 1.6W/kg.
7. For simultaneous transmission analysis, Bluetooth SAR is estimated per KDB 447498 D01v05r02 based on the formula below.
  - i)  $(max. power of channel, including tune-up tolerance, mW) / (min. test separation distance, mm) \cdot [\sqrt{f(GHz)} / x] W/kg$  for test separation distances  $\leq 50$  mm; where  $x = 7.5$  for 1-g SAR, and  $x = 18.75$  for 10-g SAR.
  - ii) When the minimum separation distance is < 5mm, the distance is used 5mm to determine SAR test exclusion.
  - iii) 0.4 W/kg for 1-g SAR and 1.0 W/kg for 10-g SAR, when the test separation distances is > 50 mm.
  - iv) Bluetooth estimated SAR is conservatively determined by 5mm separation, for all applicable exposure positions.

Bluetooth Max Power	Exposure Position	All Positions
3.0 dBm	Estimated SAR (W/kg)	0.084 W/kg



**16.1 Head Exposure Conditions**

**<WWAN PCB + WLAN DTS>**

WWAN Band		Exposure Position	WWAN PCB	WLAN DTS	Summed SAR (W/kg)	SPLSR	Case No
			Max. WWAN SAR (W/kg)	Max. WLAN SAR (W/kg)			
GSM	GSM850	Right Cheek		0.481	0.48		
		Left Cheek	0.431	0.074	0.51		
	GSM1900	Right Cheek		0.481	0.48		
		Left Cheek	0.919	0.074	0.99		
WCDMA	Band V	Right Cheek		0.481	0.48		
		Left Cheek	0.359	0.074	0.43		
	Band II	Right Cheek		0.481	0.48		
		Left Cheek	0.921	0.074	1.00		

**<WWAN PCB + Bluetooth DSS>**

WWAN Band		Exposure Position	WWAN PCB	Bluetooth DSS	Summed SAR (W/kg)	SPLSR	Case No
			Max. WWAN SAR (W/kg)	Max. Estimated SAR (W/kg)			
GSM	GSM850	Right Cheek		0.084	0.08		
		Left Cheek	0.431	0.084	0.52		
	GSM1900	Right Cheek		0.084	0.08		
		Left Cheek	0.919	0.084	1.00		
WCDMA	Band V	Right Cheek		0.084	0.08		
		Left Cheek	0.359	0.084	0.44		
	Band II	Right Cheek		0.084	0.08		
		Left Cheek	0.921	0.084	1.01		



**16.2 Body Exposure Conditions**

**<WWAN PCB + WLAN DTS>**

WWAN Band		Exposure Position	WWAN PCB	WLAN DTS	Summed SAR (W/kg)	SPLSR	Case No
			Max. WWAN SAR (W/kg)	Max. WLAN SAR (W/kg)			
GSM	GSM850	Bottom Face at 0cm	0.697	1.343	2.04	0.04	#1
		Edge1 at 0.4cm		0.184	0.18		
	GSM1900	Bottom Face at 0cm		1.343	1.34		
		Edge1 at 0.4cm	0.706	0.184	0.89		
WCDMA	Band V	Bottom Face at 0cm	0.579	1.343	1.92	0.03	#2
		Edge1 at 0.4cm		0.184	0.18		
	Band II	Bottom Face at 0cm		1.343	1.34		
		Edge1 at 0.4cm	0.784	0.184	0.97		

**<WWAN PCB + Bluetooth DSS>**

WWAN Band		Exposure Position	WWAN PCB	Bluetooth DSS	Summed SAR (W/kg)	SPLSR	Case No
			Max. WWAN SAR (W/kg)	Max. Estimated SAR (W/kg)			
GSM	GSM850	Bottom Face at 0cm	0.697	0.084	0.78		
	GSM1900	Edge1 at 0.4cm	0.706	0.084	0.79		
WCDMA	Band V	Bottom Face at 0cm	0.579	0.084	0.66		
	Band II	Edge1 at 0.4cm	0.784	0.084	0.87		

16.3 SPLSR Evaluation and Analysis

Case No #1	Band	SAR (W/kg)	Gap (cm)	SAR peak location (m)			3D distance (mm)	Pair SAR sum (W/kg)	SPLSR	Simultaneous SAR
				X	Y	Z				
Bottom Face	GSM850	0.697	0	-0.034	0.094	-0.181	71.8	2.04	0.04	Not required
	WLAN2.4GHz	1.343	0	0.0372	0.0844	-0.181				

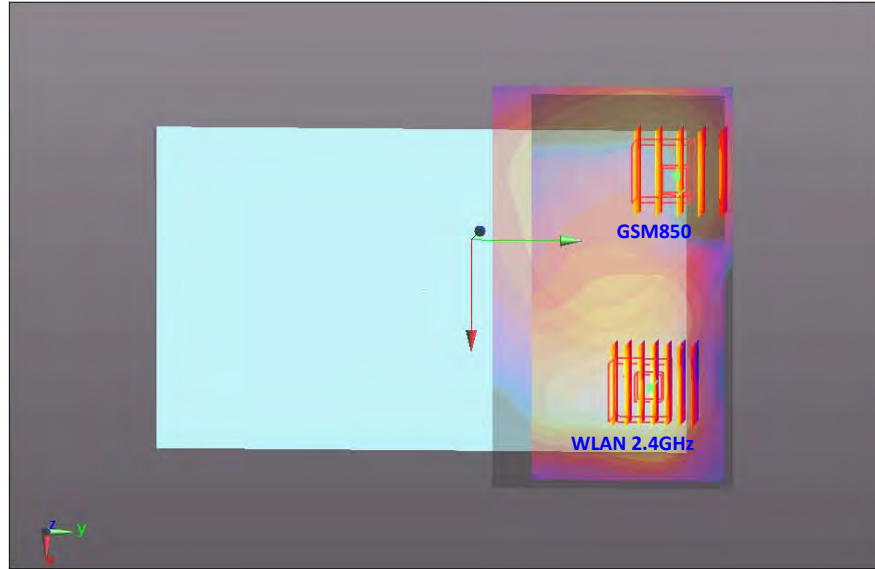

Case No #2	Band	SAR (W/kg)	Gap (cm)	SAR peak location (m)			3D distance (mm)	Pair SAR sum (W/kg)	SPLSR	Simultaneous SAR
				X	Y	Z				
Bottom Face	WCDMA Band V	0.579	0	-0.039	0.0925	-0.181	76.6	1.92	0.03	Not required
	WLAN2.4GHz	1.343	0	0.0372	0.0844	-0.181				

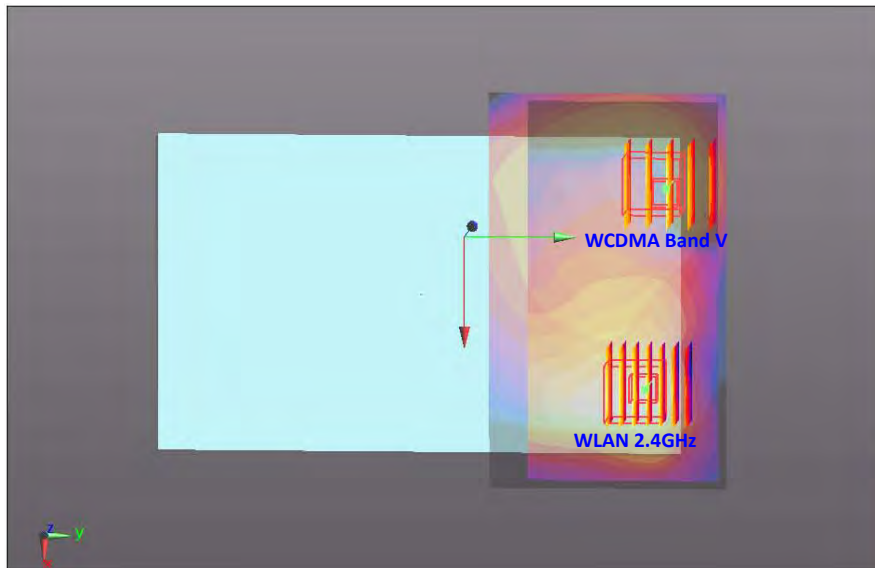

General Note:

$SPLSR = (SAR_1 + SAR_2)^{1.5} / (min. \text{ separation distance, mm})$ . If  $SPLSR \leq 0.04$ , simultaneously transmission SAR measurement is not necessary.

Test Engineer : Luke Lu

## **17. Uncertainty Assessment**

The component of uncertainty may generally be categorized according to the methods used to evaluate them. The evaluation of uncertainty by the statistical analysis of a series of observations is termed a Type A evaluation of uncertainty. The evaluation of uncertainty by means other than the statistical analysis of a series of observation is termed a Type B evaluation of uncertainty. Each component of uncertainty, however evaluated, is represented by an estimated standard deviation, termed standard uncertainty, which is determined by the positive square root of the estimated variance.

A Type A evaluation of standard uncertainty may be based on any valid statistical method for treating data. This includes calculating the standard deviation of the mean of a series of independent observations; using the method of least squares to fit a curve to the data in order to estimate the parameter of the curve and their standard deviations; or carrying out an analysis of variance in order to identify and quantify random effects in certain kinds of measurement.

A type B evaluation of standard uncertainty is typically based on scientific judgment using all of the relevant information available. These may include previous measurement data, experience, and knowledge of the behavior and properties of relevant materials and instruments, manufacture’s specification, data provided in calibration reports and uncertainties assigned to reference data taken from handbooks. Broadly speaking, the uncertainty is either obtained from an outdoor source or obtained from an assumed distribution, such as the normal distribution, rectangular or triangular distributions indicated in table below.

<b>Uncertainty Distributions</b>	<b>Normal</b>	<b>Rectangular</b>	<b>Triangular</b>	<b>U-Shape</b>
Multi-plying Factor <sup>(a)</sup>	1/k <sup>(b)</sup>	1/√3	1/√6	1/√2

(a) standard uncertainty is determined as the product of the multiplying factor and the estimated range of variations in the measured quantity

(b)  $\kappa$  is the coverage factor

**Table 17.1. Standard Uncertainty for Assumed Distribution**

The combined standard uncertainty of the measurement result represents the estimated standard deviation of the result. It is obtained by combining the individual standard uncertainties of both Type A and Type B evaluation using the usual “root-sum-squares” (RSS) methods of combining standard deviations by taking the positive square root of the estimated variances.

Expanded uncertainty is a measure of uncertainty that defines an interval about the measurement result within which the measured value is confidently believed to lie. It is obtained by multiplying the combined standard uncertainty by a coverage factor. Typically, the coverage factor ranges from 2 to 3. Using a coverage factor allows the true value of a measured quantity to be specified with a defined probability within the specified uncertainty range. For purpose of this document, a coverage factor two is used, which corresponds to confidence interval of about 95 %. The DASY uncertainty Budget is shown in the following tables.

Error Description	Uncertainty Value (±%)	Probability Distribution	Divisor	Ci (1g)	Ci (10g)	Standard Uncertainty (1g)	Standard Uncertainty (10g)
<b>Measurement System</b>							
Probe Calibration	6.0	Normal	1	1	1	± 6.0 %	± 6.0 %
Axial Isotropy	4.7	Rectangular	√3	0.7	0.7	± 1.9 %	± 1.9 %
Hemispherical Isotropy	9.6	Rectangular	√3	0.7	0.7	± 3.9 %	± 3.9 %
Boundary Effects	1.0	Rectangular	√3	1	1	± 0.6 %	± 0.6 %
Linearity	4.7	Rectangular	√3	1	1	± 2.7 %	± 2.7 %
System Detection Limits	1.0	Rectangular	√3	1	1	± 0.6 %	± 0.6 %
Readout Electronics	0.3	Normal	1	1	1	± 0.3 %	± 0.3 %
Response Time	0.8	Rectangular	√3	1	1	± 0.5 %	± 0.5 %
Integration Time	2.6	Rectangular	√3	1	1	± 1.5 %	± 1.5 %
RF Ambient Noise	3.0	Rectangular	√3	1	1	± 1.7 %	± 1.7 %
RF Ambient Reflections	3.0	Rectangular	√3	1	1	± 1.7 %	± 1.7 %
Probe Positioner	0.4	Rectangular	√3	1	1	± 0.2 %	± 0.2 %
Probe Positioning	2.9	Rectangular	√3	1	1	± 1.7 %	± 1.7 %
Max. SAR Eval.	1.0	Rectangular	√3	1	1	± 0.6 %	± 0.6 %
<b>Test Sample Related</b>							
Device Positioning	2.9	Normal	1	1	1	± 2.9 %	± 2.9 %
Device Holder	3.6	Normal	1	1	1	± 3.6 %	± 3.6 %
Power Drift	5.0	Rectangular	√3	1	1	± 2.9 %	± 2.9 %
<b>Phantom and Setup</b>							
Phantom Uncertainty	4.0	Rectangular	√3	1	1	± 2.3 %	± 2.3 %
Liquid Conductivity (Target)	5.0	Rectangular	√3	0.64	0.43	± 1.8 %	± 1.2 %
Liquid Conductivity (Meas.)	2.5	Normal	1	0.64	0.43	± 1.6 %	± 1.1 %
Liquid Permittivity (Target)	5.0	Rectangular	√3	0.6	0.49	± 1.7 %	± 1.4 %
Liquid Permittivity (Meas.)	2.5	Normal	1	0.6	0.49	± 1.5 %	± 1.2 %
<b>Combined Standard Uncertainty</b>						± 11.0 %	± 10.8 %
<b>Coverage Factor for 95 %</b>						K=2	
<b>Expanded Uncertainty</b>						± 22.0 %	± 21.5 %

**Table 17.2. Uncertainty Budget for frequency range 300 MHz to 3 GHz**



## **18. References**

- [1] FCC 47 CFR Part 2 “Frequency Allocations and Radio Treaty Matters; General Rules and Regulations”
- [2] ANSI/IEEE Std. C95.1-1992, “IEEE Standard for Safety Levels with Respect to Human Exposure to Radio Frequency Electromagnetic Fields, 3 kHz to 300 GHz”, September 1992
- [3] IEEE Std. 1528-2003, “Recommended Practice for Determining the Peak Spatial-Average Specific Absorption Rate (SAR) in the Human Head from Wireless Communications Devices: Measurement Techniques”, December 2003
- [4] SPEAG DASY System Handbook
- [5] FCC KDB 865664 D01 v01r03, "SAR Measurement Requirements for 100 MHz to 6 GHz", February 2014.
- [6] FCC KDB 865664 D02 v01r01, “RF Exposure Compliance Reporting and Documentation Considerations” May 2013
- [7] FCC KDB 447498 D01 v05r02, “Mobile and Portable Device RF Exposure Procedures and Equipment Authorization Policies”, Feb 2014
- [8] FCC KDB 248227 D01 v01r02, “SAR Measurement Procedures for 802.11 a/b/g Transmitters”, May 2007
- [9] FCC KDB 616217 D04 v01r01, “SAR Evaluation Considerations for Laptop, Notebook, Netbook and Tablet Computers”, May 2013
- [10] FCC KDB 941225 D01 3G SAR Procedures v03, “3G SAR measurement procedures”, October 2014



## **Appendix A. Plots of System Performance Check**

The plots are shown as follows.

### System Check\_Head\_835MHz\_141028

**DUT: D835V2 - SN: 4d151**

Communication System: UID 0, CW; Frequency: 835 MHz; Duty Cycle: 1:1

Medium: HSL\_835\_141028 Medium parameters used:  $f = 835 \text{ MHz}$ ;  $\sigma = 0.914 \text{ S/m}$ ;  $\epsilon_r = 41.826$ ;  $\rho = 1000 \text{ kg/m}^3$

Ambient Temperature :  $23.3 \text{ }^\circ\text{C}$ ; Liquid Temperature :  $22.6 \text{ }^\circ\text{C}$

DASY5 Configuration:

- Probe: EX3DV4 - SN3661; ConvF(9.5, 9.5, 9.5); Calibrated: 2014.03.10;
- Sensor-Surface: 2mm (Mechanical Surface Detection)
- Electronics: DAE4 Sn910; Calibrated: 2014.07.22
- Phantom: SAM2; Type: QD000P40CD; Serial: TP:1671
- Measurement SW: DASY52, Version 52.8 (7); SEMCAD X Version 14.6.10 (7164)

**Pin=250mW/Area Scan (61x61x1):** Interpolated grid:  $dx=15\text{mm}$ ,  $dy=15\text{mm}$

Maximum value of SAR (interpolated) =  $2.93 \text{ W/kg}$

**Pin=250mW/Zoom Scan (5x5x7)/Cube 0:** Measurement grid:  $dx=8\text{mm}$ ,  $dy=8\text{mm}$ ,  $dz=5\text{mm}$

Reference Value =  $56.955 \text{ V/m}$ ; Power Drift =  $0.00 \text{ dB}$

Peak SAR (extrapolated) =  $3.53 \text{ W/kg}$

**SAR(1 g) =  $2.3 \text{ W/kg}$ ; SAR(10 g) =  $1.5 \text{ W/kg}$**

Maximum value of SAR (measured) =  $2.94 \text{ W/kg}$

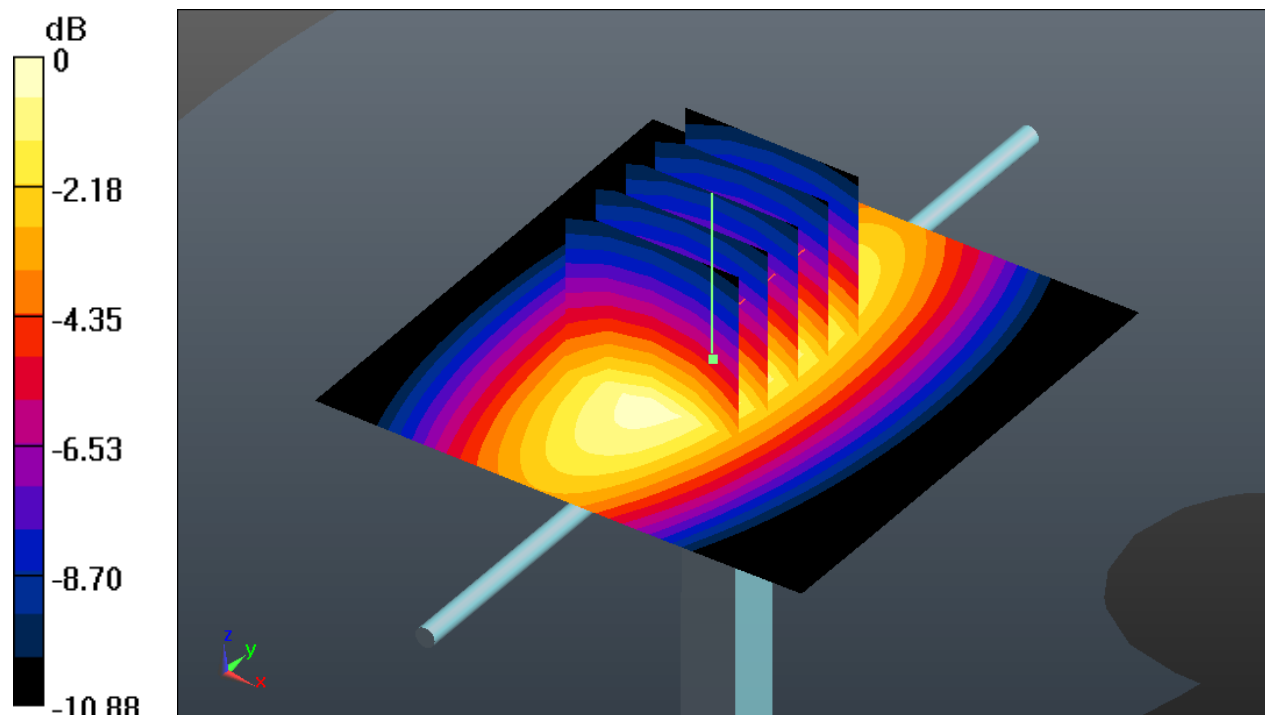

0 dB =  $2.94 \text{ W/kg}$

### System Check\_Head\_1900MHz\_141028

**DUT: D1900V2 - SN: 5d170**

Communication System: UID 0, CW; Frequency: 1900 MHz; Duty Cycle: 1:1

Medium: HSL\_1900\_141028 Medium parameters used:  $f = 1900$  MHz;  $\sigma = 1.422$  S/m;  $\epsilon_r = 40.315$ ;

$\rho = 1000$  kg/m<sup>3</sup>

Ambient Temperature : 23.5 °C; Liquid Temperature : 22.6 °C

DASY5 Configuration:

- Probe: EX3DV4 - SN3661; ConvF(8.18, 8.18, 8.18); Calibrated: 2014.03.10;
- Sensor-Surface: 2mm (Mechanical Surface Detection)
- Electronics: DAE4 Sn910; Calibrated: 2014.07.22
- Phantom: SAM1; Type: QD000P40CD; Serial: TP:1670
- Measurement SW: DASY52, Version 52.8 (7); SEMCAD X Version 14.6.10 (7164)

**Pin=250mW/Area Scan (61x61x1):** Interpolated grid: dx=15mm, dy=15mm

Maximum value of SAR (interpolated) = 12.9 W/kg

**Pin=250mW/Zoom Scan (5x5x7)/Cube 0:** Measurement grid: dx=8mm, dy=8mm, dz=5mm

Reference Value = 94.538 V/m; Power Drift = -0.01 dB

Peak SAR (extrapolated) = 16.1 W/kg

**SAR(1 g) = 9.39 W/kg; SAR(10 g) = 5.11 W/kg**

Maximum value of SAR (measured) = 12.7 W/kg

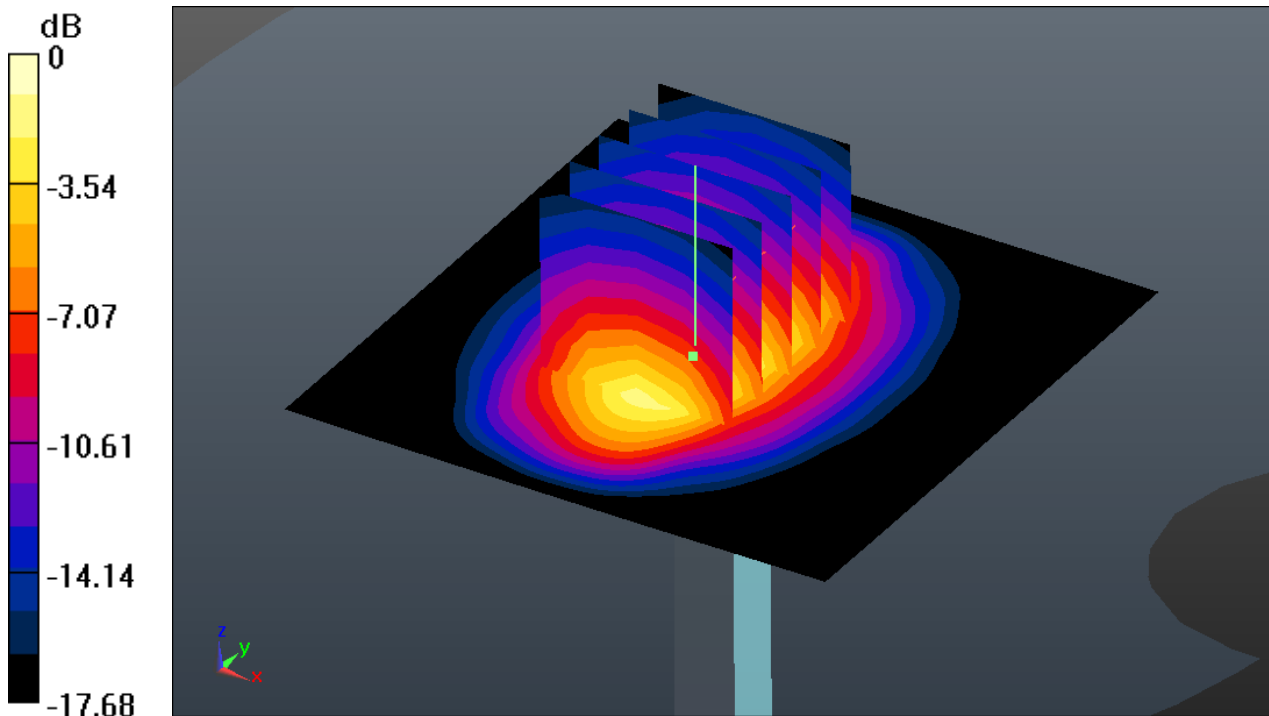

0 dB = 12.7 W/kg



**System Check\_Head\_2450MHz\_141028**

**DUT: D2450V2 - SN: 908**

Communication System: UID 0, CW; Frequency: 2450 MHz; Duty Cycle: 1:1  
 Medium: HSL\_2450\_141028 Medium parameters used:  $f = 2450 \text{ MHz}$ ;  $\sigma = 1.829 \text{ S/m}$ ;  $\epsilon_r = 40.081$ ;  
 $\rho = 1000 \text{ kg/m}^3$   
 Ambient Temperature : 23.5 °C; Liquid Temperature : 22.8 °C

**DASY5 Configuration:**

- Probe: EX3DV4 - SN3661; ConvF(7.59, 7.59, 7.59); Calibrated: 2014.03.10;
- Sensor-Surface: 2mm (Mechanical Surface Detection)
- Electronics: DAE4 Sn910; Calibrated: 2014.07.22
- Phantom: SAM1; Type: QD000P40CD; Serial: TP:1670
- Measurement SW: DASY52, Version 52.8 (7); SEMCAD X Version 14.6.10 (7164)

**Pin=250mW/Area Scan (81x81x1):** Interpolated grid: dx=12mm, dy=12mm

Maximum value of SAR (interpolated) = 20.8 W/kg

**Pin=250mW/Zoom Scan (7x7x7)/Cube 0:** Measurement grid: dx=5mm, dy=5mm, dz=5mm

Reference Value = 90.862 V/m; Power Drift = -0.06 dB

Peak SAR (extrapolated) = 29.0 W/kg

**SAR(1 g) = 13.4 W/kg; SAR(10 g) = 6.04 W/kg**

Maximum value of SAR (measured) = 21.0 W/kg

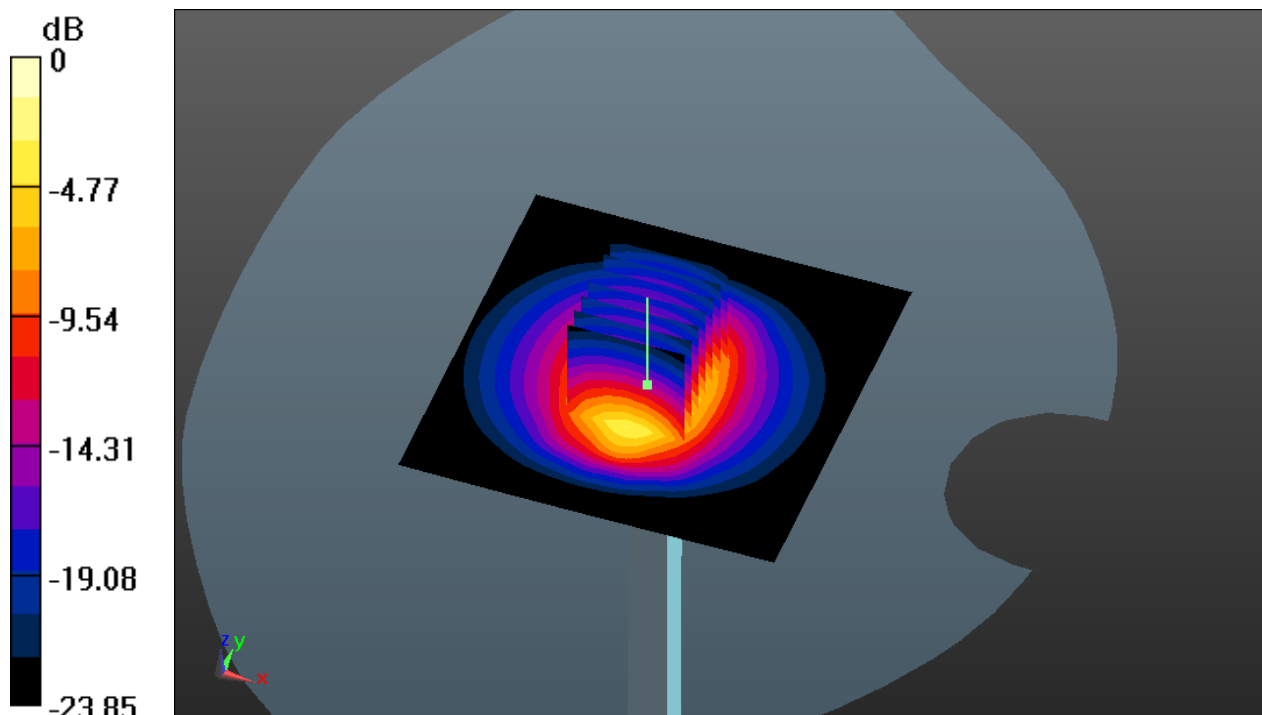

0 dB = 21.0 W/kg

### System Check\_Body\_835MHz\_141109

**DUT: D835V2 - SN: 4d151**

Communication System: UID 0, CW; Frequency: 835 MHz; Duty Cycle: 1:1  
Medium: MSL\_835\_141109 Medium parameters used:  $f = 835 \text{ MHz}$ ;  $\sigma = 0.974 \text{ S/m}$ ;  $\epsilon_r = 54.111$ ;  $\rho = 1000 \text{ kg/m}^3$   
Ambient Temperature :  $23.3 \text{ }^\circ\text{C}$ ; Liquid Temperature :  $22.8 \text{ }^\circ\text{C}$

#### DASY5 Configuration:

- Probe: EX3DV4 - SN3661; ConvF(9.45, 9.45, 9.45); Calibrated: 2014.03.10;
- Sensor-Surface: 2mm (Mechanical Surface Detection)
- Electronics: DAE4 Sn910; Calibrated: 2014.07.22
- Phantom: SAM3; Type: QDOVA002AA; Serial: TP:1149
- Measurement SW: DASY52, Version 52.8 (7); SEMCAD X Version 14.6.10 (7164)

**Pin=250mW/Area Scan (61x61x1):** Interpolated grid:  $dx=15\text{mm}$ ,  $dy=15\text{mm}$

Maximum value of SAR (interpolated) =  $2.65 \text{ W/kg}$

**Pin=250mW/Zoom Scan (5x5x7)/Cube 0:** Measurement grid:  $dx=8\text{mm}$ ,  $dy=8\text{mm}$ ,  $dz=5\text{mm}$

Reference Value =  $52.151 \text{ V/m}$ ; Power Drift =  $0.07 \text{ dB}$

Peak SAR (extrapolated) =  $3.57 \text{ W/kg}$

**SAR(1 g) =  $2.45 \text{ W/kg}$ ; SAR(10 g) =  $1.62 \text{ W/kg}$**

Maximum value of SAR (measured) =  $2.63 \text{ W/kg}$

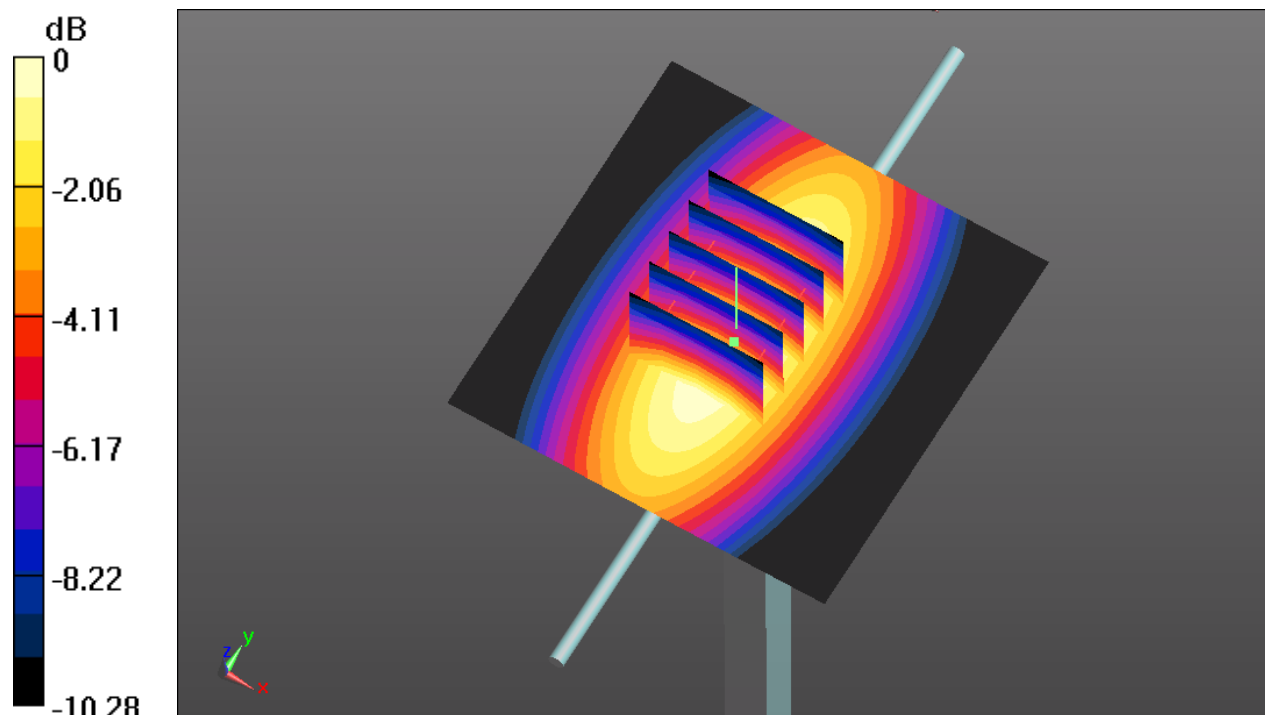

0 dB =  $2.63 \text{ W/kg}$

### System Check\_Body\_1900MHz\_141106

**DUT: D1900V2 - SN: 5d170**

Communication System: UID 0, CW; Frequency: 1900 MHz; Duty Cycle: 1:1

Medium: MSL\_1900\_141106 Medium parameters used:  $f = 1900$  MHz;  $\sigma = 1.542$  S/m;  $\epsilon_r = 53.532$ ;  
 $\rho = 1000$  kg/m<sup>3</sup>

Ambient Temperature : 23.3 °C; Liquid Temperature : 22.7 °C

DASY5 Configuration:

- Probe: EX3DV4 - SN3661; ConvF(7.75, 7.75, 7.75); Calibrated: 2014.03.10;
- Sensor-Surface: 2mm (Mechanical Surface Detection)
- Electronics: DAE4 Sn910; Calibrated: 2014.07.22
- Phantom: SAM1; Type: QD000P40CD; Serial: TP:1670
- Measurement SW: DASY52, Version 52.8 (7); SEMCAD X Version 14.6.10 (7164)

**Pin=250mW/Area Scan (61x61x1):** Interpolated grid: dx=15mm, dy=15mm

Maximum value of SAR (interpolated) = 14.1 W/kg

**Pin=250mW/Zoom Scan (5x5x7)/Cube 0:** Measurement grid: dx=8mm, dy=8mm, dz=5mm

Reference Value = 84.758 V/m; Power Drift = -0.07 dB

Peak SAR (extrapolated) = 17.4 W/kg

**SAR(1 g) = 10.1 W/kg; SAR(10 g) = 5.33 W/kg**

Maximum value of SAR (measured) = 14.0 W/kg

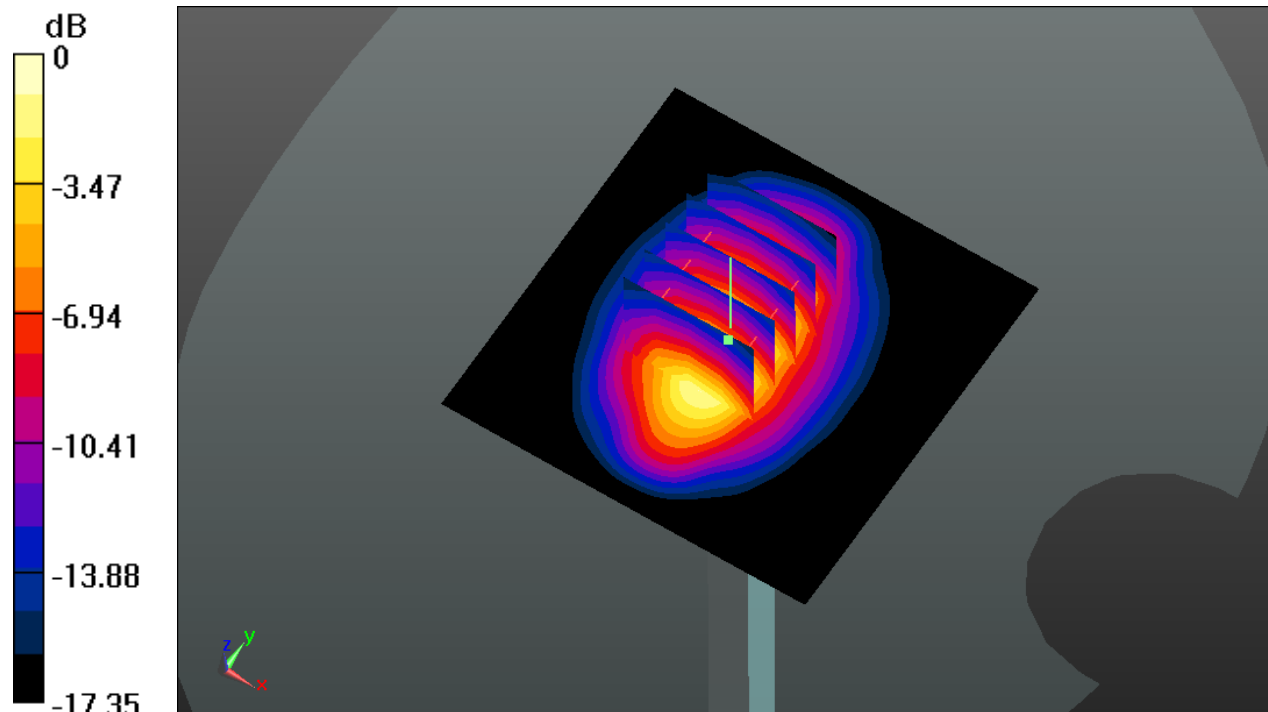

0 dB = 14.0 W/kg

### System Check\_Body\_2450MHz\_141110

**DUT: D2450V2 - SN: 908**

Communication System: UID 0, CW; Frequency: 2450 MHz; Duty Cycle: 1:1  
Medium: MSL\_2450\_141110 Medium parameters used:  $f = 2450$  MHz;  $\sigma = 1.992$  S/m;  $\epsilon_r = 52.319$ ;  
 $\rho = 1000$  kg/m<sup>3</sup>  
Ambient Temperature : 23.3 °C; Liquid Temperature : 22.7 °C

#### DASY5 Configuration:

- Probe: EX3DV4 - SN3661; ConvF(7.47, 7.47, 7.47); Calibrated: 2014.03.10;
- Sensor-Surface: 2mm (Mechanical Surface Detection)
- Electronics: DAE4 Sn910; Calibrated: 2014.07.22
- Phantom: SAM3; Type: QDOVA002AA; Serial: TP:1149
- Measurement SW: DASY52, Version 52.8 (7); SEMCAD X Version 14.6.10 (7164)

**Pin=250mW/Area Scan (81x81x1):** Interpolated grid: dx=12mm, dy=12mm

Maximum value of SAR (interpolated) = 18.6 W/kg

**Pin=250mW/Zoom Scan (7x7x7)/Cube 0:** Measurement grid: dx=5mm, dy=5mm, dz=5mm

Reference Value = 83.082 V/m; Power Drift = 0.02 dB

Peak SAR (extrapolated) = 24.8 W/kg

**SAR(1 g) = 12.2 W/kg; SAR(10 g) = 5.62 W/kg**

Maximum value of SAR (measured) = 18.5 W/kg

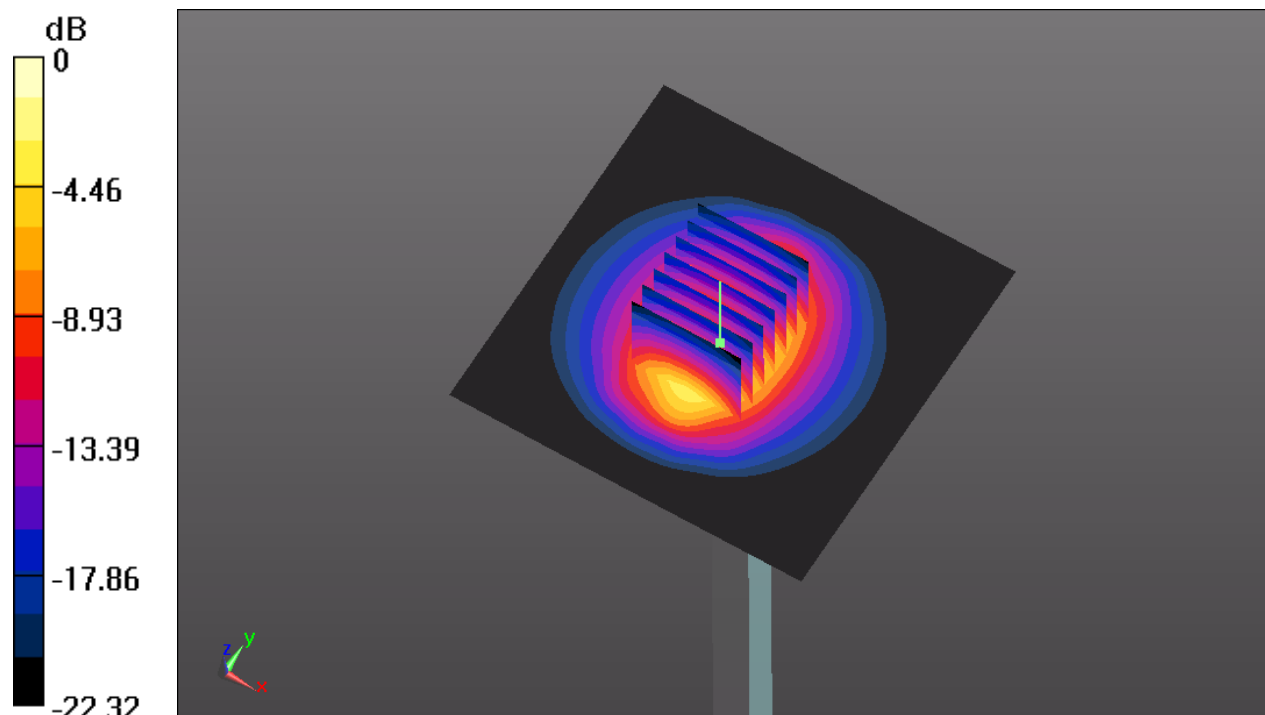

0 dB = 18.5 W/kg



**Appendix B. Plots of High SAR Measurement**

The plots are shown as follows.

**#01\_GSM850\_GPRS(4 Tx slots)\_Left Cheek\_Ch251\_Sensor on**

Communication System: UID 0, GPRS/EDGE12 (0); Frequency: 848.8 MHz; Duty Cycle: 1:2.08  
Medium: HSL\_835\_141028 Medium parameters used:  $f = 848.8$  MHz;  $\sigma = 0.925$  S/m;  $\epsilon_r = 41.676$ ;  $\rho = 1000$  kg/m<sup>3</sup>  
Ambient Temperature : 23.3 °C; Liquid Temperature : 22.6 °C

DASY5 Configuration:

- Probe: EX3DV4 - SN3661; ConvF(9.5, 9.5, 9.5); Calibrated: 2014.03.10;
- Sensor-Surface: 2mm (Mechanical Surface Detection)
- Electronics: DAE4 Sn910; Calibrated: 2014.07.22
- Phantom: SAM2; Type: QD000P40CD; Serial: TP:1671
- Measurement SW: DASY52, Version 52.8 (7); SEMCAD X Version 14.6.10 (7164)

**Ch251/Area Scan (101x151x1):** Interpolated grid: dx=15mm, dy=15mm

Maximum value of SAR (interpolated) = 0.323 W/kg

**Ch251/Zoom Scan (5x5x7)/Cube 0:** Measurement grid: dx=8mm, dy=8mm, dz=5mm

Reference Value = 0.341 V/m; Power Drift = 0.08 dB

Peak SAR (extrapolated) = 0.627 W/kg

**SAR(1 g) = 0.292 W/kg; SAR(10 g) = 0.164 W/kg**

Maximum value of SAR (measured) = 0.430 W/kg

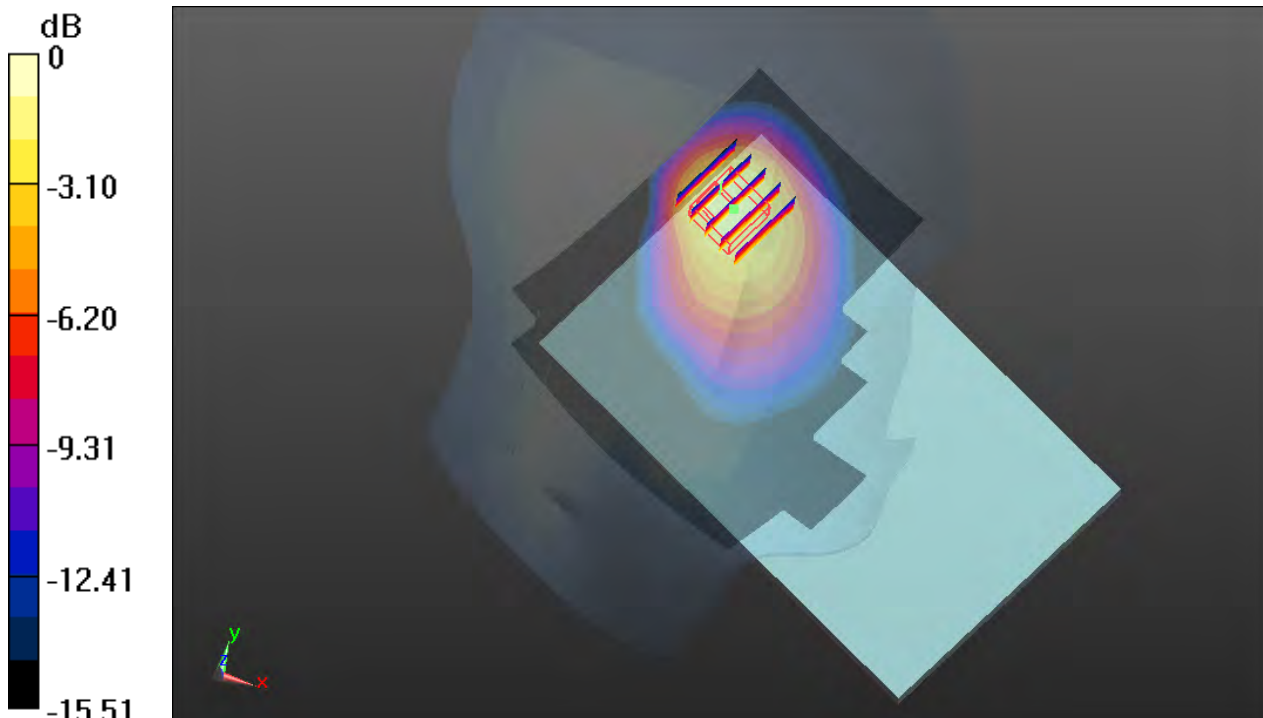

0 dB = 0.430 W/kg

**#02\_GSM1900\_GPRS(4 Tx slots)\_Left Cheek\_Ch810\_Sensor on**

Communication System: UID 0, GPRS/EDGE12 (0); Frequency: 1909.8 MHz; Duty Cycle: 1:2.08  
Medium: HSL\_1900\_141028 Medium parameters used:  $f = 1909.8$  MHz;  $\sigma = 1.432$  S/m;  $\epsilon_r = 40.266$ ;  
 $\rho = 1000$  kg/m<sup>3</sup>  
Ambient Temperature : 23.5 °C; Liquid Temperature : 22.6 °C

DASY5 Configuration:

- Probe: EX3DV4 - SN3661; ConvF(8.18, 8.18, 8.18); Calibrated: 2014.03.10;
- Sensor-Surface: 2mm (Mechanical Surface Detection)
- Electronics: DAE4 Sn910; Calibrated: 2014.07.22
- Phantom: SAM1; Type: QD000P40CD; Serial: TP:1670
- Measurement SW: DASY52, Version 52.8 (7); SEMCAD X Version 14.6.10 (7164)

**Ch810/Area Scan (101x151x1):** Interpolated grid: dx=15mm, dy=15mm

Maximum value of SAR (interpolated) = 0.749 W/kg

**Ch810/Zoom Scan (5x5x7)/Cube 0:** Measurement grid: dx=8mm, dy=8mm, dz=5mm

Reference Value = 3.940 V/m; Power Drift = 0.04 dB

Peak SAR (extrapolated) = 1.19 W/kg

**SAR(1 g) = 0.627 W/kg; SAR(10 g) = 0.297 W/kg**

Maximum value of SAR (measured) = 0.936 W/kg

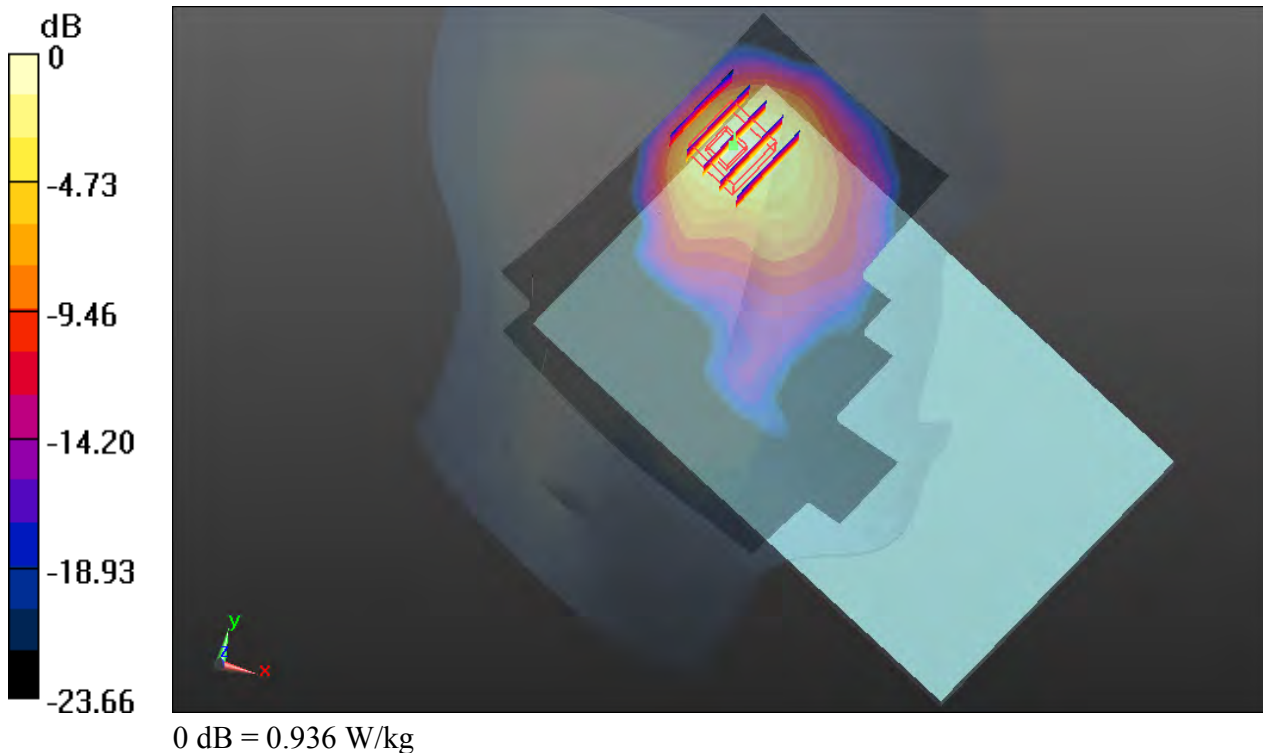

**#03\_WCDMA Band V\_RMC 12.2K\_Left Cheek\_Ch4182\_Sensor on**

Communication System: UID 0, UMTS (0); Frequency: 836.4 MHz; Duty Cycle: 1:1  
Medium: HSL\_835\_141028 Medium parameters used:  $f = 836.4$  MHz;  $\sigma = 0.915$  S/m;  $\epsilon_r = 41.816$ ;  
 $\rho = 1000$  kg/m<sup>3</sup>  
Ambient Temperature : 23.3 °C; Liquid Temperature : 22.6 °C

DASY5 Configuration:

- Probe: EX3DV4 - SN3661; ConvF(9.5, 9.5, 9.5); Calibrated: 2014.03.10;
- Sensor-Surface: 2mm (Mechanical Surface Detection)
- Electronics: DAE4 Sn910; Calibrated: 2014.07.22
- Phantom: SAM2; Type: QD000P40CD; Serial: TP:1671
- Measurement SW: DASY52, Version 52.8 (7); SEMCAD X Version 14.6.10 (7164)

**Ch4182/Area Scan (101x151x1):** Interpolated grid: dx=15mm, dy=15mm

Maximum value of SAR (interpolated) = 0.719 W/kg

**Ch4182/Zoom Scan (5x5x7)/Cube 0:** Measurement grid: dx=8mm, dy=8mm, dz=5mm

Reference Value = 0.393 V/m; Power Drift = 0.01 dB

Peak SAR (extrapolated) = 0.672 W/kg

**SAR(1 g) = 0.299 W/kg; SAR(10 g) = 0.162 W/kg**

Maximum value of SAR (measured) = 0.475 W/kg

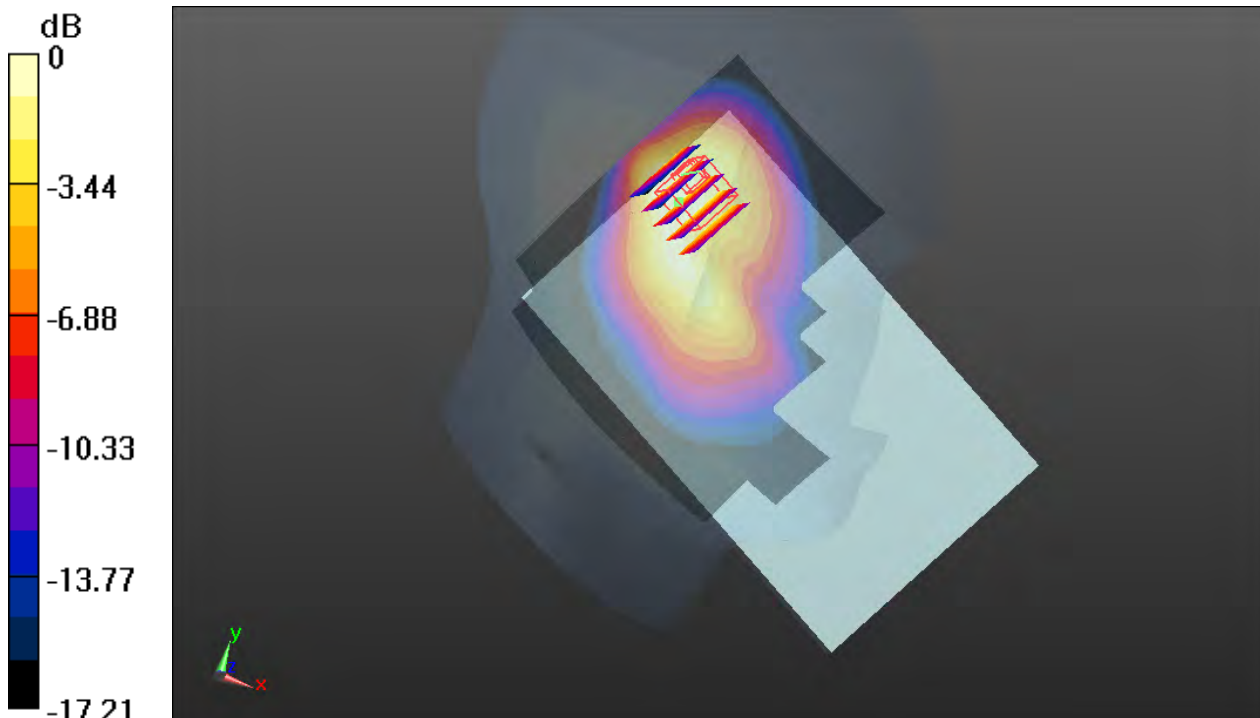

0 dB = 0.475 W/kg



**#04\_WCDMA Band II\_RMC 12.2K\_Left Cheek\_Ch9538\_Sensor on**

Communication System: UID 0, UMTS (0); Frequency: 1907.6 MHz; Duty Cycle: 1:1  
Medium: HSL\_1900\_141028 Medium parameters used:  $f = 1907.6$  MHz;  $\sigma = 1.43$  S/m;  $\epsilon_r = 40.274$ ;  $\rho = 1000$  kg/m<sup>3</sup>  
Ambient Temperature : 23.5 °C; Liquid Temperature : 22.6 °C

DASY5 Configuration:

- Probe: EX3DV4 - SN3661; ConvF(8.18, 8.18, 8.18); Calibrated: 2014.03.10;
- Sensor-Surface: 2mm (Mechanical Surface Detection)
- Electronics: DAE4 Sn910; Calibrated: 2014.07.22
- Phantom: SAM1; Type: QD000P40CD; Serial: TP:1670
- Measurement SW: DASY52, Version 52.8 (7); SEMCAD X Version 14.6.10 (7164)

**Ch9538/Area Scan (101x151x1):** Interpolated grid: dx=15mm, dy=15mm

Maximum value of SAR (interpolated) = 0.932 W/kg

**Ch9538/Zoom Scan (5x5x7)/Cube 0:** Measurement grid: dx=8mm, dy=8mm, dz=5mm

Reference Value = 1.680 V/m; Power Drift = -0.02 dB

Peak SAR (extrapolated) = 1.34 W/kg

**SAR(1 g) = 0.715 W/kg; SAR(10 g) = 0.343 W/kg**

Maximum value of SAR (measured) = 1.09 W/kg

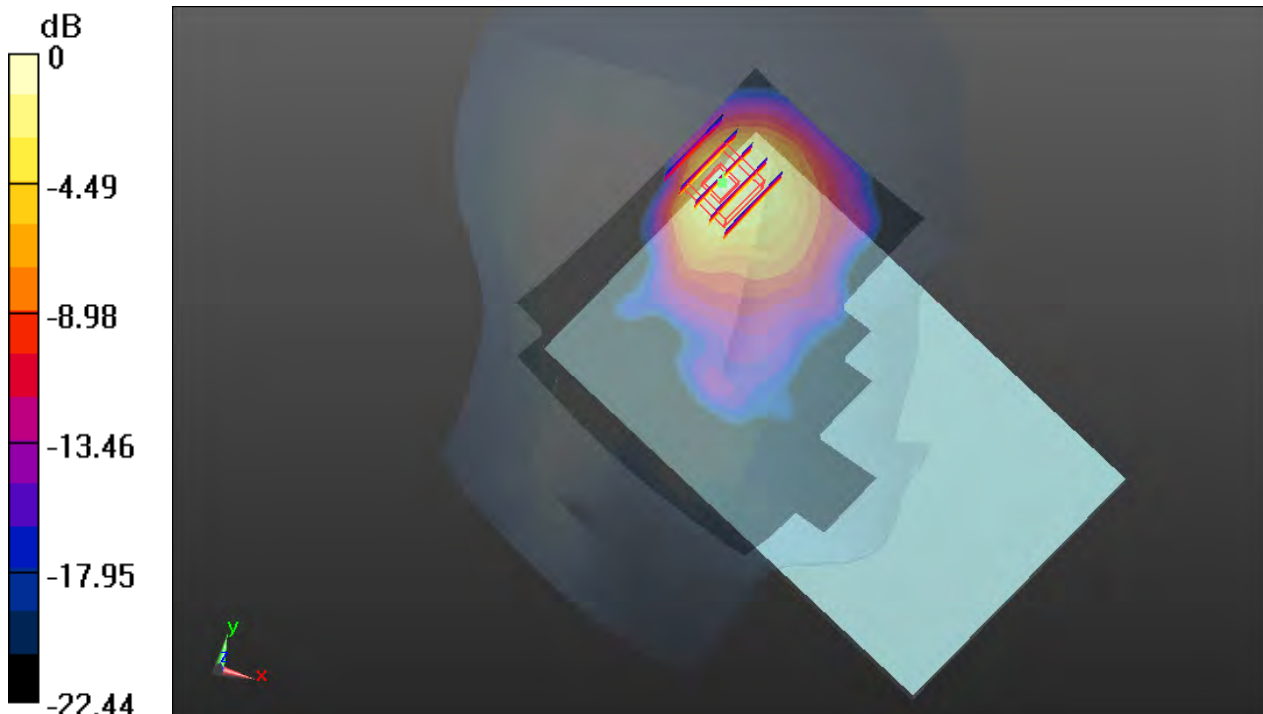

0 dB = 1.09 W/kg

### #05\_WLAN 2.4GHz\_802.11b 1Mbps\_Right Cheek\_Ch11

Communication System: UID 0, WIFI (0); Frequency: 2462 MHz;Duty Cycle: 1:1  
Medium: HSL\_2450\_141028 Medium parameters used:  $f = 2462$  MHz;  $\sigma = 1.847$  S/m;  $\epsilon_r = 39.609$ ;  
 $\rho = 1000$  kg/m<sup>3</sup>  
Ambient Temperature : 23.5 °C; Liquid Temperature : 22.8 °C

#### DASY5 Configuration:

- Probe: EX3DV4 - SN3661; ConvF(7.59, 7.59, 7.59); Calibrated: 2014.03.10;
- Sensor-Surface: 2mm (Mechanical Surface Detection)
- Electronics: DAE4 Sn910; Calibrated: 2014.07.22
- Phantom: SAM1; Type: QD000P40CD; Serial: TP:1670
- Measurement SW: DASY52, Version 52.8 (7); SEMCAD X Version 14.6.10 (7164)

#### Ch11/Area Scan (121x191x1): Interpolated grid: dx=12mm, dy=12mm

Maximum value of SAR (interpolated) = 0.625 W/kg

#### Ch11/Zoom Scan (7x7x7)/Cube 0: Measurement grid: dx=5mm, dy=5mm, dz=5mm

Reference Value = 0.539 V/m; Power Drift = 0.06 dB

Peak SAR (extrapolated) = 0.826 W/kg

**SAR(1 g) = 0.376 W/kg; SAR(10 g) = 0.170 W/kg**

Maximum value of SAR (measured) = 0.605 W/kg

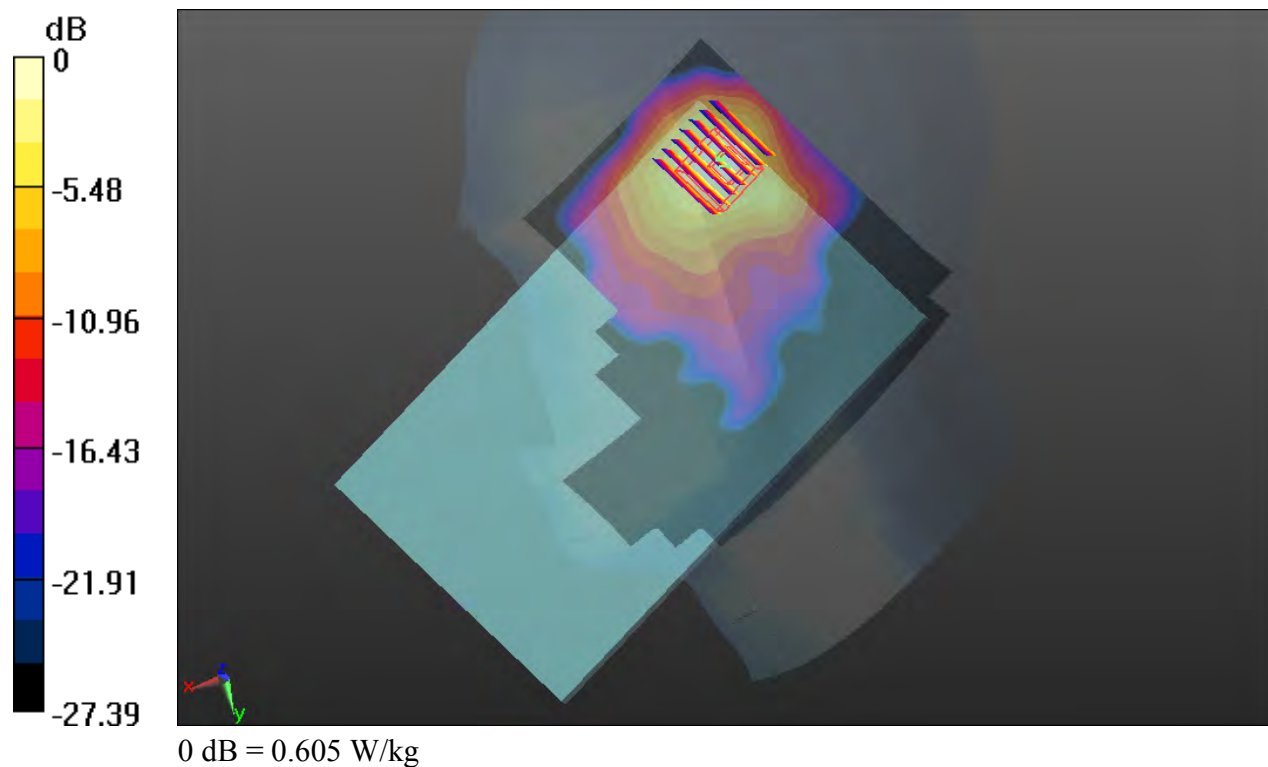

**#06\_GSM850\_GPRS(4 Tx slots)\_Bottom Face\_0cm\_Ch251\_Sensor on**

Communication System: UID 0, GPRS/EDGE12 (0); Frequency: 848.8 MHz; Duty Cycle: 1:2.08  
Medium: MSL\_835\_141109 Medium parameters used:  $f = 848.8$  MHz;  $\sigma = 1.026$  S/m;  $\epsilon_r = 56.11$ ;  $\rho = 1000$  kg/m<sup>3</sup>  
Ambient Temperature : 23.3 °C; Liquid Temperature : 22.8 °C

DASY5 Configuration:

- Probe: EX3DV4 - SN3661; ConvF(9.45, 9.45, 9.45); Calibrated: 2014.03.10;
- Sensor-Surface: 2mm (Mechanical Surface Detection)
- Electronics: DAE4 Sn910; Calibrated: 2014.07.22
- Phantom: SAM3; Type: QDOVA002AA; Serial: TP:1149
- Measurement SW: DASY52, Version 52.8 (7); SEMCAD X Version 14.6.10 (7164)

**Ch251/Area Scan (101x61x1):** Interpolated grid: dx=15mm, dy=15mm

Maximum value of SAR (interpolated) = 0.581 W/kg

**Ch251/Zoom Scan (5x5x7)/Cube 0:** Measurement grid: dx=8mm, dy=8mm, dz=5mm

Reference Value = 1.809 V/m; Power Drift = -0.09 dB

Peak SAR (extrapolated) = 0.937 W/kg

**SAR(1 g) = 0.472 W/kg; SAR(10 g) = 0.262 W/kg**

Maximum value of SAR (measured) = 0.712 W/kg

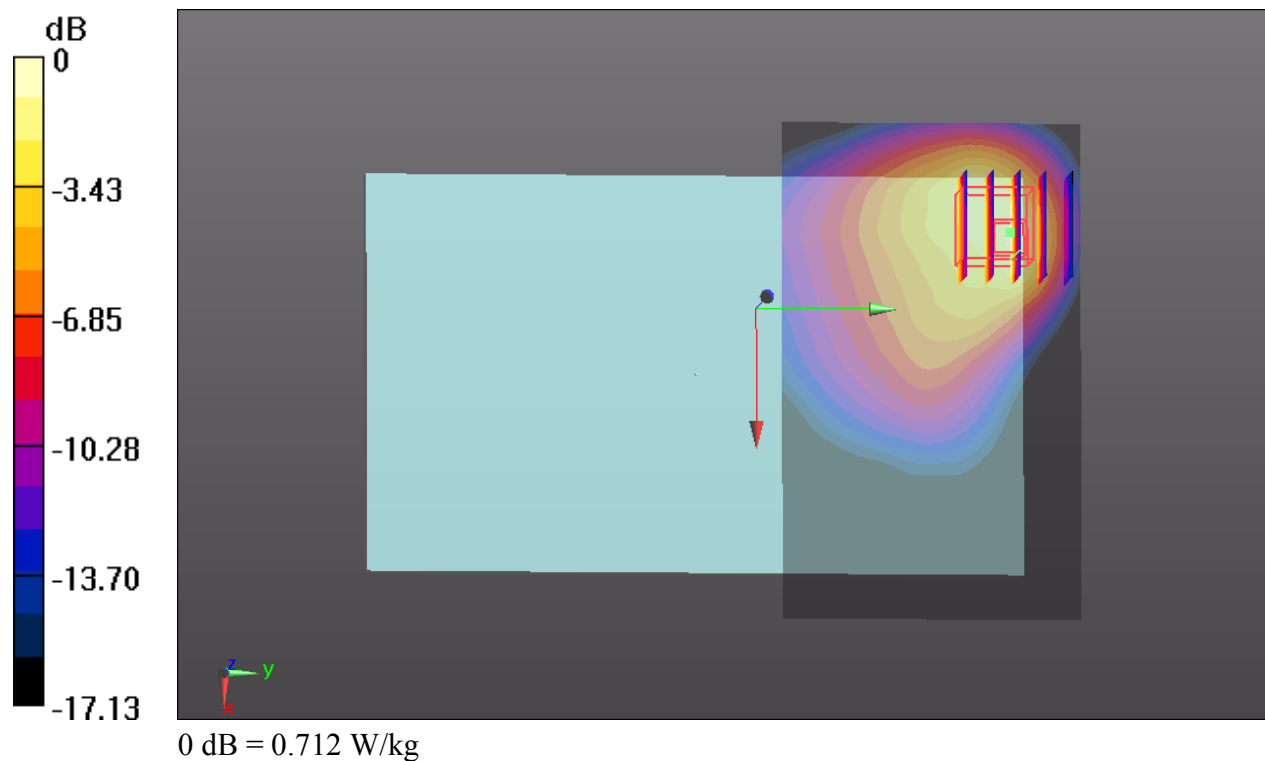

**#07\_GSM1900\_GPRS(4 Tx slots)\_Edge 1\_0.4cm\_Ch810\_Sensor off**

Communication System: UID 0, GPRS/EDGE12 (0); Frequency: 1909.8 MHz; Duty Cycle: 1:2.08  
Medium: MSL\_1900\_141106 Medium parameters used:  $f = 1909.8$  MHz;  $\sigma = 1.553$  S/m;  $\epsilon_r = 53.507$ ;  
 $\rho = 1000$  kg/m<sup>3</sup>  
Ambient Temperature : 23.3 °C; Liquid Temperature : 22.7 °C

DASY5 Configuration:

- Probe: EX3DV4 - SN3661; ConvF(7.75, 7.75, 7.75); Calibrated: 2014.03.10;
- Sensor-Surface: 2mm (Mechanical Surface Detection)
- Electronics: DAE4 Sn910; Calibrated: 2014.07.22
- Phantom: SAM1; Type: QD000P40CD; Serial: TP:1670
- Measurement SW: DASY52, Version 52.8 (7); SEMCAD X Version 14.6.10 (7164)

**Ch810/Area Scan (41x101x1):** Interpolated grid: dx=15mm, dy=15mm

Maximum value of SAR (interpolated) = 0.922 W/kg

**Ch810/Zoom Scan (5x5x7)/Cube 0:** Measurement grid: dx=8mm, dy=8mm, dz=5mm

Reference Value = 3.754 V/m; Power Drift = -0.01 dB

Peak SAR (extrapolated) = 1.15 W/kg

**SAR(1 g) = 0.673 W/kg; SAR(10 g) = 0.345 W/kg**

Maximum value of SAR (measured) = 0.951 W/kg

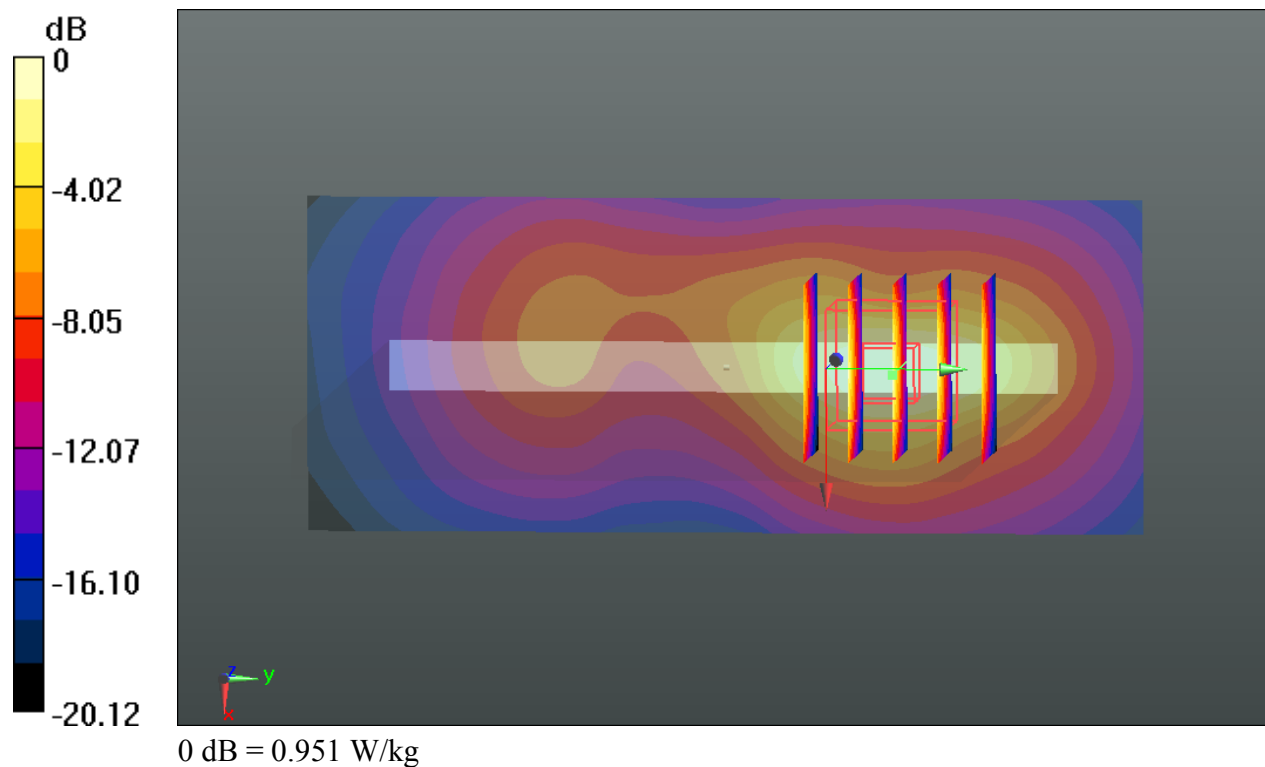

**#08\_WCDMA Band V\_RMC 12.2K\_Bottom Face\_0cm\_Ch4182\_Sensor on**

Communication System: UID 0, UMTS (0); Frequency: 836.4 MHz; Duty Cycle: 1:1  
Medium: MSL\_835\_141109 Medium parameters used:  $f = 836.4$  MHz;  $\sigma = 1.013$  S/m;  $\epsilon_r = 56.228$ ;  
 $\rho = 1000$  kg/m<sup>3</sup>  
Ambient Temperature : 23.3 °C; Liquid Temperature : 22.8 °C

DASY5 Configuration:

- Probe: EX3DV4 - SN3661; ConvF(9.45, 9.45, 9.45); Calibrated: 2014.03.10;
- Sensor-Surface: 2mm (Mechanical Surface Detection)
- Electronics: DAE4 Sn910; Calibrated: 2014.07.22
- Phantom: SAM3; Type: QDOVA002AA; Serial: TP:1149
- Measurement SW: DASY52, Version 52.8 (7); SEMCAD X Version 14.6.10 (7164)

**Ch4182/Area Scan (101x61x1):** Interpolated grid: dx=15mm, dy=15mm

Maximum value of SAR (interpolated) = 0.579 W/kg

**Ch4182/Zoom Scan (5x5x7)/Cube 0:** Measurement grid: dx=8mm, dy=8mm, dz=5mm

Reference Value = 1.247 V/m; Power Drift = 0.04 dB

Peak SAR (extrapolated) = 0.959 W/kg

**SAR(1 g) = 0.482 W/kg; SAR(10 g) = 0.269 W/kg**

Maximum value of SAR (measured) = 0.728 W/kg

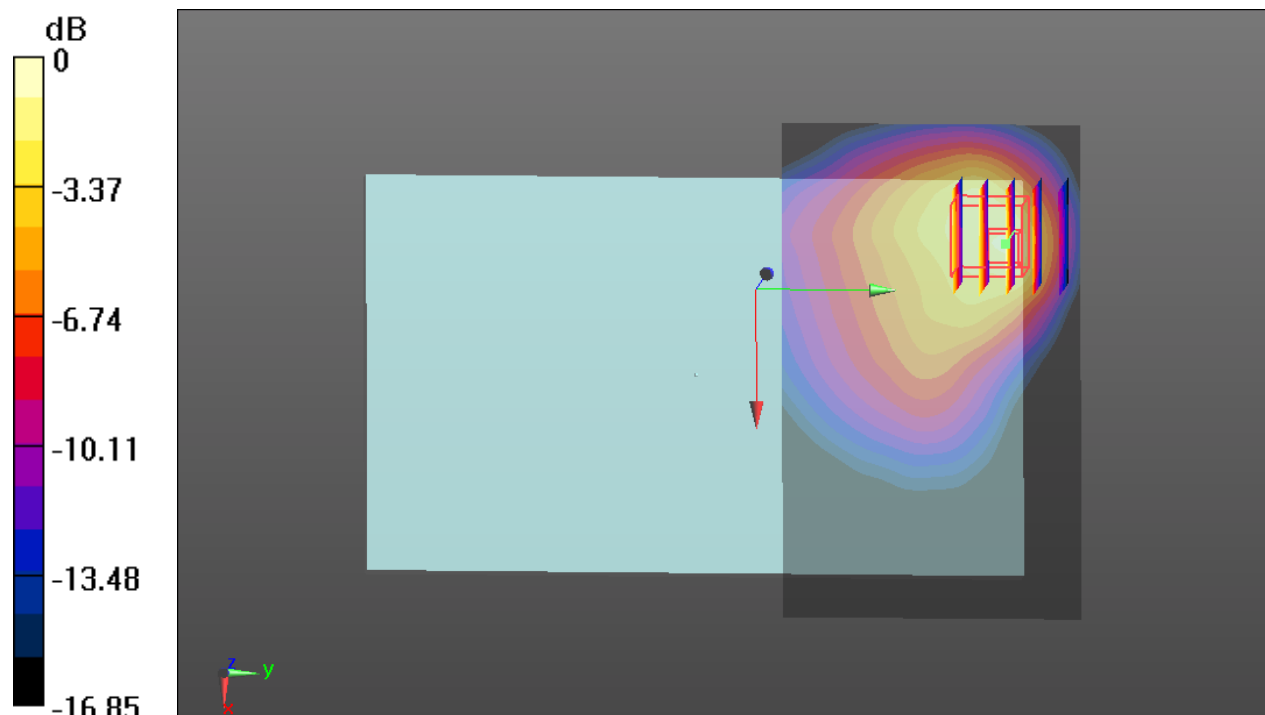

0 dB = 0.728 W/kg

**#09\_WCDMA Band II\_RMC 12.2K\_Edge 1\_0.4cm\_Ch9400\_Sensor off**

Communication System: UID 0, UMTS (0); Frequency: 1880 MHz; Duty Cycle: 1:1  
Medium: MSL\_1900\_141106 Medium parameters used:  $f = 1880$  MHz;  $\sigma = 1.517$  S/m;  $\epsilon_r = 53.569$ ;  
 $\rho = 1000$  kg/m<sup>3</sup>  
Ambient Temperature : 23.3 °C; Liquid Temperature : 22.7 °C

DASY5 Configuration:

- Probe: EX3DV4 - SN3661; ConvF(7.75, 7.75, 7.75); Calibrated: 2014.03.10;
- Sensor-Surface: 2mm (Mechanical Surface Detection)
- Electronics: DAE4 Sn910; Calibrated: 2014.07.22
- Phantom: SAM1; Type: QD000P40CD; Serial: TP:1670
- Measurement SW: DASY52, Version 52.8 (7); SEMCAD X Version 14.6.10 (7164)

**Ch9400/Area Scan (41x101x1):** Interpolated grid: dx=15mm, dy=15mm

Maximum value of SAR (interpolated) = 0.848 W/kg

**Ch9400/Zoom Scan (5x5x7)/Cube 0:** Measurement grid: dx=8mm, dy=8mm, dz=5mm

Reference Value = 4.142 V/m; Power Drift = -0.05 dB

Peak SAR (extrapolated) = 1.04 W/kg

**SAR(1 g) = 0.606 W/kg; SAR(10 g) = 0.309 W/kg**

Maximum value of SAR (measured) = 0.859 W/kg

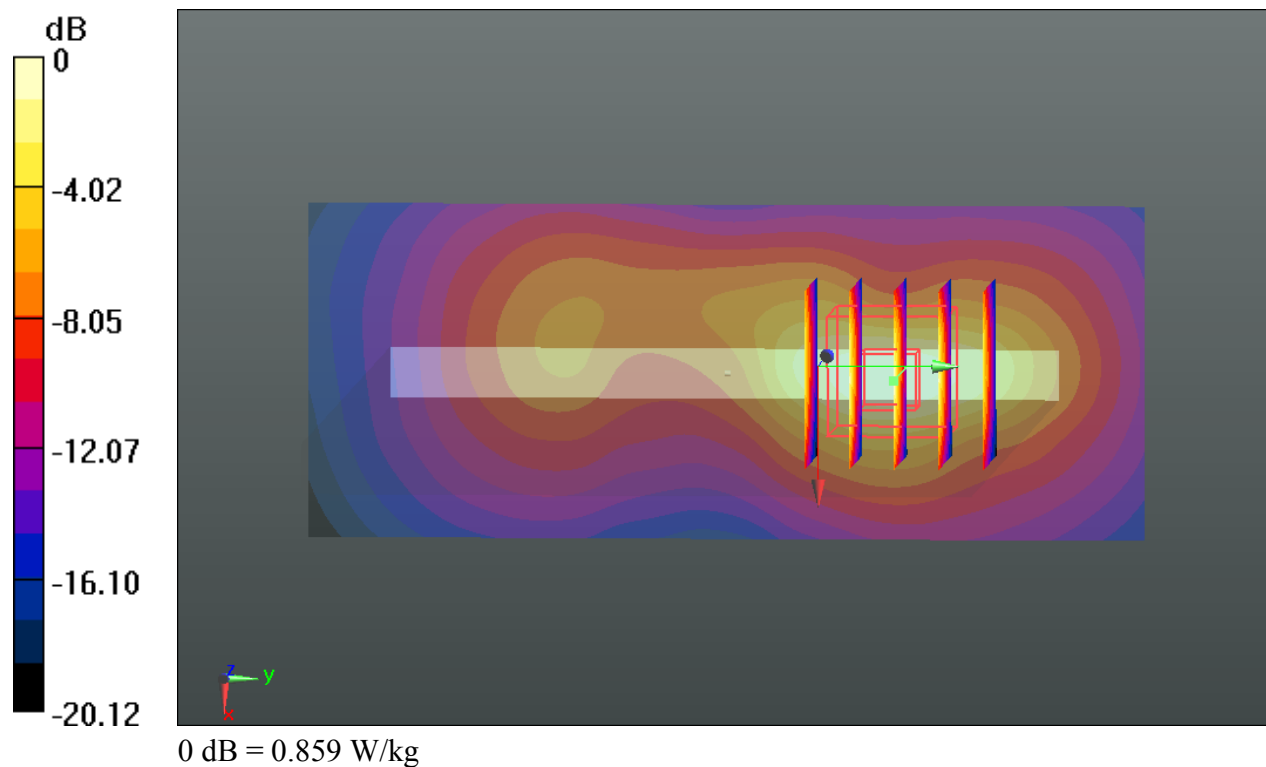

### #10\_WLAN2.4GHz\_802.11b 1Mbps\_Bottom Face\_0cm\_Ch11

Communication System: UID 0, WIFI (0); Frequency: 2462 MHz; Duty Cycle: 1:1  
Medium: MSL\_2450\_141110 Medium parameters used:  $f = 2462$  MHz;  $\sigma = 2.012$  S/m;  $\epsilon_r = 52.245$ ;  
 $\rho = 1000$  kg/m<sup>3</sup>  
Ambient Temperature : 23.3 °C; Liquid Temperature : 22.7 °C

#### DASY5 Configuration:

- Probe: EX3DV4 - SN3661; ConvF(7.47, 7.47, 7.47); Calibrated: 2014.03.10;
- Sensor-Surface: 2mm (Mechanical Surface Detection)
- Electronics: DAE4 Sn910; Calibrated: 2014.07.22
- Phantom: SAM3; Type: QDOVA002AA; Serial: TP:1149
- Measurement SW: DASY52, Version 52.8 (7); SEMCAD X Version 14.6.10 (7164)

#### Ch11/Area Scan (121x61x1): Interpolated grid: dx=12mm, dy=12mm

Maximum value of SAR (interpolated) = 1.98 W/kg

#### Ch11/Zoom Scan (7x7x7)/Cube 0: Measurement grid: dx=5mm, dy=5mm, dz=5mm

Reference Value = 0.626 V/m; Power Drift = -0.09 dB

Peak SAR (extrapolated) = 2.76 W/kg

**SAR(1 g) = 1.050 W/kg; SAR(10 g) = 0.448 W/kg**

Maximum value of SAR (measured) = 1.84 W/kg

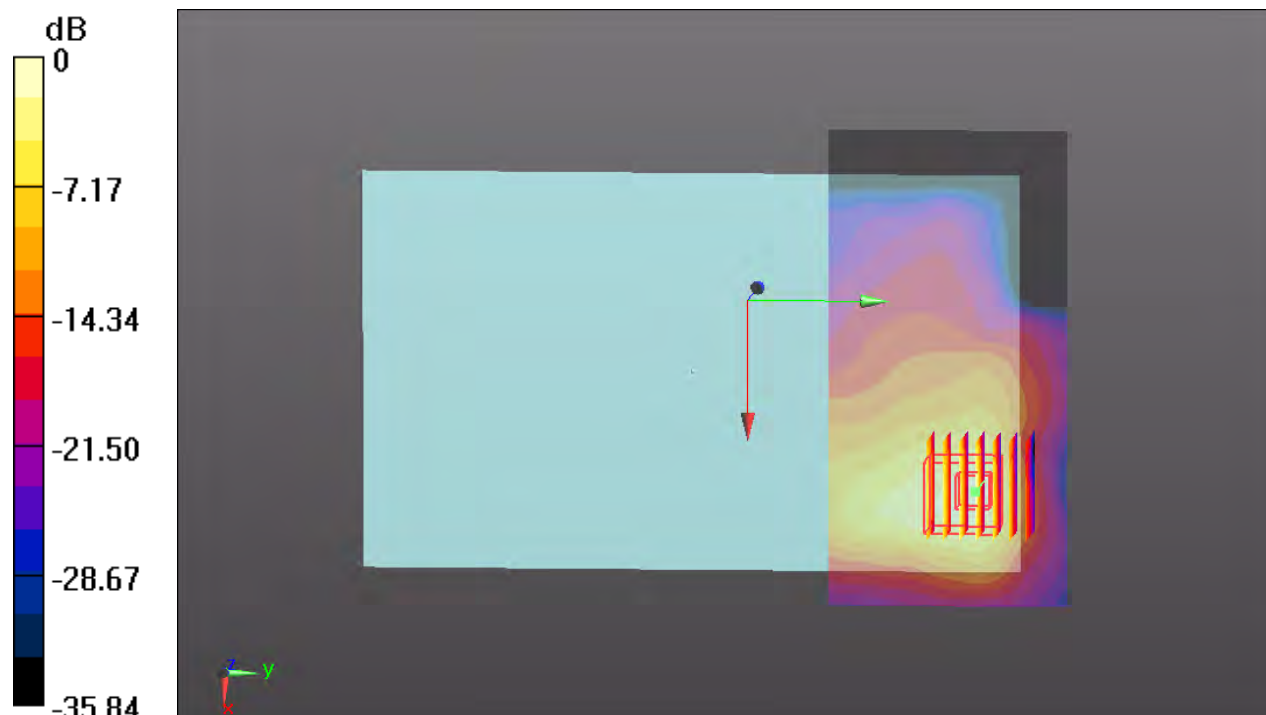

0 dB = 1.84 W/kg



**Appendix C. DASYS Calibration Certificate**

The DASYS calibration certificates are shown as follows.





Accredited by the Swiss Accreditation Service (SAS)  
The Swiss Accreditation Service is one of the signatories to the EA  
Multilateral Agreement for the recognition of calibration certificates

Accreditation No.: **SCS 108**

Client **Sporton-KS (Auden)**

Certificate No: **D835V2-4d151\_Mar13**

## CALIBRATION CERTIFICATE

Object **D835V2 - SN: 4d151**

Calibration procedure(s) **QA CAL-05.v9  
Calibration procedure for dipole validation kits above 700 MHz**

Calibration date: **March 25, 2013**

This calibration certificate documents the traceability to national standards, which realize the physical units of measurements (SI).  
The measurements and the uncertainties with confidence probability are given on the following pages and are part of the certificate.

All calibrations have been conducted in the closed laboratory facility; environment temperature (22 ± 3)°C and humidity < 70%.

Calibration Equipment used (M&TE critical for calibration)

Primary Standards	ID #	Cal Date (Certificate No.)	Scheduled Calibration
Power meter EPM-442A	GS37480704	01-Nov-12 (No. 217-01940)	Oct-13
Power sensor HP 8481A	US37292783	01-Nov-12 (No. 217-01640)	Oct-13
Reference 20 dB Attenuator	SN: 5058 (20k)	27-Mar-12 (No. 217-01530)	Apr-13
Type-N mismatch combination	SN: 5047.3 / 06327	27-Mar-12 (No. 217-01533)	Apr-13
Reference Probe ES3DV3	SN: 3205	28-Dec-12 (No. ES3-3205_Dec12)	Dec-13
DAE4	SN: 601	27-Jun-12 (No. DAE4-601_Jun12)	Jun-13

Secondary Standards	ID #	Check Date (in house)	Scheduled Check
Power sensor HP 8481A	MY41092317	18-Oct-02 (in house check Oct-11)	In house check: Oct-13
RF generator R&S SMT-06	100005	04-Aug-99 (in house check Oct-11)	In house check: Oct-13
Network Analyzer HP 8753E	US37990585 S4206	18-Oct-01 (in house check Oct-12)	In house check: Oct-13

	Name	Function	Signature
Calibrated by:	Jeton Kastati	Laboratory Technician	
Approved by:	Katja Pokovic	Technical Manager	

Issued: March 26, 2013

This calibration certificate shall not be reproduced except in full without written approval of the laboratory.

## Calibration Laboratory of

Schmid & Partner

Engineering AG

Zeughausstrasse 43, 8004 Zurich, Switzerland



S Schweizerischer Kalibrierdienst  
C Service suisse d'étalonnage  
S Servizio svizzero di taratura  
S Swiss Calibration Service

Accredited by the Swiss Accreditation Service (SAS)

The Swiss Accreditation Service is one of the signatories to the EA Multilateral Agreement for the recognition of calibration certificates

Accreditation No.: SCS 108

### Glossary:

TSL	tissue simulating liquid
ConvF	sensitivity in TSL / NORM $x,y,z$
N/A	not applicable or not measured

### Calibration is Performed According to the Following Standards:

- IEEE Std 1528-2003, "IEEE Recommended Practice for Determining the Peak Spatial-Averaged Specific Absorption Rate (SAR) in the Human Head from Wireless Communications Devices: Measurement Techniques", December 2003
- IEC 62209-1, "Procedure to measure the Specific Absorption Rate (SAR) for hand-held devices used in close proximity to the ear (frequency range of 300 MHz to 3 GHz)", February 2005
- Federal Communications Commission Office of Engineering & Technology (FCC OET), "Evaluating Compliance with FCC Guidelines for Human Exposure to Radiofrequency Electromagnetic Fields; Additional Information for Evaluating Compliance of Mobile and Portable Devices with FCC Limits for Human Exposure to Radiofrequency Emissions", Supplement C (Edition 01-01) to Bulletin 65

### Additional Documentation:

- DASY4/5 System Handbook

### Methods Applied and Interpretation of Parameters:

- Measurement Conditions:** Further details are available from the Validation Report at the end of the certificate. All figures stated in the certificate are valid at the frequency indicated.
- Antenna Parameters with TSL:** The dipole is mounted with the spacer to position its feed point exactly below the center marking of the flat phantom section, with the arms oriented parallel to the body axis.
- Feed Point Impedance and Return Loss:** These parameters are measured with the dipole positioned under the liquid filled phantom. The impedance stated is transformed from the measurement at the SMA connector to the feed point. The Return Loss ensures low reflected power. No uncertainty required.
- Electrical Delay:** One-way delay between the SMA connector and the antenna feed point. No uncertainty required.
- SAR measured:** SAR measured at the stated antenna input power.
- SAR normalized:** SAR as measured, normalized to an input power of 1 W at the antenna connector.
- SAR for nominal TSL parameters:** The measured TSL parameters are used to calculate the nominal SAR result.

The reported uncertainty of measurement is stated as the standard uncertainty of measurement multiplied by the coverage factor  $k=2$ , which for a normal distribution corresponds to a coverage probability of approximately 95%.



## Measurement Conditions

DASY system configuration, as far as not given on page 1.

DASY Version	DASY5	V52.8.5
Extrapolation	Advanced Extrapolation	
Phantom	Modular Flat Phantom	
Distance Dipole Center - TSL	15 mm	with Spacer
Zoom Scan Resolution	dx, dy, dz = 5 mm	
Frequency	835 MHz $\pm$ 1 MHz	

## Head TSL parameters

The following parameters and calculations were applied.

	Temperature	Permittivity	Conductivity
Nominal Head TSL parameters	22.0 °C	41.5	0.90 mho/m
Measured Head TSL parameters	(22.0 $\pm$ 0.2) °C	40.9 $\pm$ 6 %	0.94 mho/m $\pm$ 6 %
Head TSL temperature change during test	< 0.5 °C	—	—

## SAR result with Head TSL

SAR averaged over 1 cm <sup>3</sup> (1 g) of Head TSL	Condition	
SAR measured	250 mW input power	2.46 W/kg
SAR for nominal Head TSL parameters	normalized to 1W	<b>9.49 W/kg <math>\pm</math> 17.0 % (k=2)</b>

SAR averaged over 10 cm <sup>3</sup> (10 g) of Head TSL	condition	
SAR measured	250 mW input power	1.59 W/kg
SAR for nominal Head TSL parameters	normalized to 1W	<b>6.18 W/kg <math>\pm</math> 16.5 % (k=2)</b>

## Body TSL parameters

The following parameters and calculations were applied.

	Temperature	Permittivity	Conductivity
Nominal Body TSL parameters	22.0 °C	55.2	0.97 mho/m
Measured Body TSL parameters	(22.0 $\pm$ 0.2) °C	54.1 $\pm$ 6 %	1.02 mho/m $\pm$ 6 %
Body TSL temperature change during test	< 0.5 °C	—	—

## SAR result with Body TSL

SAR averaged over 1 cm <sup>3</sup> (1 g) of Body TSL	Condition	
SAR measured	250 mW input power	2.46 W/kg
SAR for nominal Body TSL parameters	normalized to 1W	<b>9.43 W/kg <math>\pm</math> 17.0 % (k=2)</b>

SAR averaged over 10 cm <sup>3</sup> (10 g) of Body TSL	condition	
SAR measured	250 mW input power	1.61 W/kg
SAR for nominal Body TSL parameters	normalized to 1W	<b>6.23 W/kg <math>\pm</math> 16.5 % (k=2)</b>

## Appendix

### Antenna Parameters with Head TSL

Impedance, transformed to feed point	51.7 $\Omega$ - 2.2 $j\Omega$
Return Loss	- 31.2 dB

### Antenna Parameters with Body TSL

Impedance, transformed to feed point	47.1 $\Omega$ - 4.3 $j\Omega$
Return Loss	- 25.4 dB

### General Antenna Parameters and Design

Electrical Delay (one direction)	1.391 ns
----------------------------------	----------

After long term use with 100W radiated power, only a slight warming of the dipole near the feedpoint can be measured.

The dipole is made of standard semirigid coaxial cable. The center conductor of the feeding line is directly connected to the second arm of the dipole. The antenna is therefore short-circuited for DC-signals. On some of the dipoles, small end caps are added to the dipole arms in order to improve matching when loaded according to the position as explained in the "Measurement Conditions" paragraph. The SAR data are not affected by this change. The overall dipole length is still according to the Standard.

No excessive force must be applied to the dipole arms, because they might bend or the soldered connections near the feedpoint may be damaged.

### Additional EUT Data

Manufactured by	SPEAG
Manufactured on	March 27, 2012

## DASY5 Validation Report for Head TSL

Date: 25.03.2013

Test Laboratory: SPEAG, Zurich, Switzerland

**DUT: Dipole 835 MHz; Type: D835V2; Serial: D835V2 - SN: 4d151**

Communication System: CW; Frequency: 835 MHz

Medium parameters used:  $f = 835$  MHz;  $\sigma = 0.94$  S/m;  $\epsilon_r = 40.9$ ;  $\rho = 1000$  kg/m<sup>3</sup>

Phantom section: Flat Section

Measurement Standard: DASY5 (IEEE/IEC/ANSI C63.19-2007)

DASY52 Configuration:

- Probe: ES3DV3 - SN3205; ConvF(6.05, 6.05, 6.05); Calibrated: 28.12.2012;
- Sensor-Surface: 3mm (Mechanical Surface Detection)
- Electronics: DAE4 Sn601; Calibrated: 27.06.2012
- Phantom: Flat Phantom 4.9L; Type: QD000P49AA; Serial: 1001
- DASY52 52.8.5(1059); SEMCAD X 14.6.8(7028)

### Dipole Calibration for Head Tissue/Pin=250 mW, d=15mm/Zoom Scan (7x7x7)/Cube 0:

Measurement grid:  $\Delta x=5$ mm,  $\Delta y=5$ mm,  $\Delta z=5$ mm

Reference Value = 56.742 V/m; Power Drift = 0.01 dB

Peak SAR (extrapolated) = 3.74 W/kg

**SAR(1 g) = 2.46 W/kg; SAR(10 g) = 1.59 W/kg**

Maximum value of SAR (measured) = 2.88 W/kg

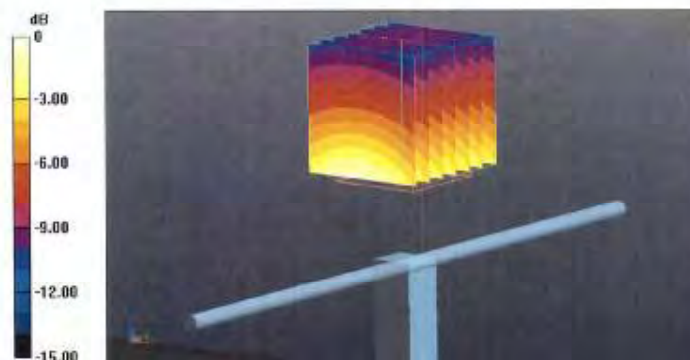

0 dB = 2.88 W/kg = 4.59 dBW/kg

# Impedance Measurement Plot for Head TSL

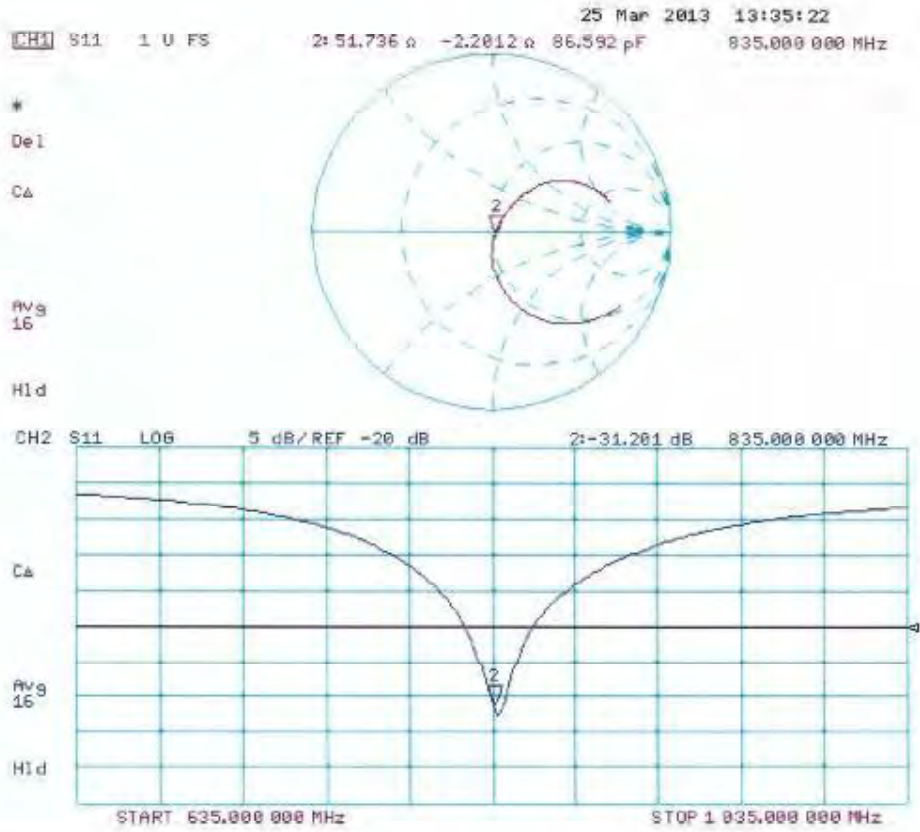



## DASY5 Validation Report for Body TSL

Date: 25.03.2013

Test Laboratory: SPEAG, Zurich, Switzerland

**DUT: Dipole 835 MHz; Type: D835V2; Serial: D835V2 - SN: 4d151**

Communication System: CW; Frequency: 835 MHz

Medium parameters used:  $f = 835$  MHz;  $\sigma = 1.02$  S/m;  $\epsilon_r = 54.1$ ;  $\rho = 1000$  kg/m<sup>3</sup>

Phantom section: Flat Section

Measurement Standard: DASY5 (IEEE/IEC/ANSI C63.19-2007)

DASY52 Configuration:

- Probe: ES3DV3 - SN3205; ConvF(6.04, 6.04, 6.04); Calibrated: 28.12.2012;
- Sensor-Surface: 3mm (Mechanical Surface Detection)
- Electronics: DAE4 Sn601; Calibrated: 27.06.2012
- Phantom: Flat Phantom 4.9L; Type: QD000P49AA; Serial: 1001
- DASY52 52.8.5(1059); SEMCAD X 14.6.8(7028)

### Dipole Calibration for Body Tissue/Pin=250 mW, d=15mm/Zoom Scan (7x7x7)/Cube 0:

Measurement grid: dx=5mm, dy=5mm, dz=5mm

Reference Value = 54.816 V/m; Power Drift = 0.01 dB

Peak SAR (extrapolated) = 3.63 W/kg

**SAR(1 g) = 2.46 W/kg; SAR(10 g) = 1.61 W/kg**

Maximum value of SAR (measured) = 2.87 W/kg

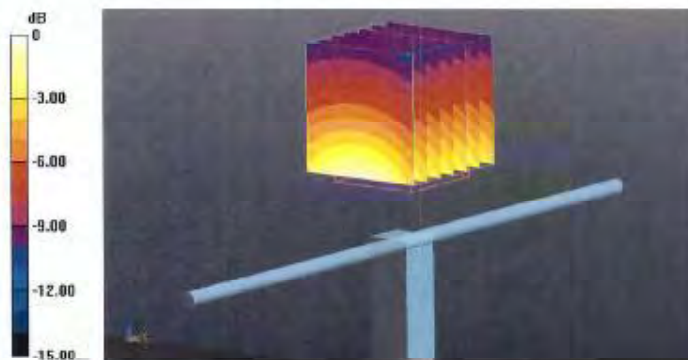

0 dB = 2.87 W/kg = 4.58 dBW/kg

# Impedance Measurement Plot for Body TSL

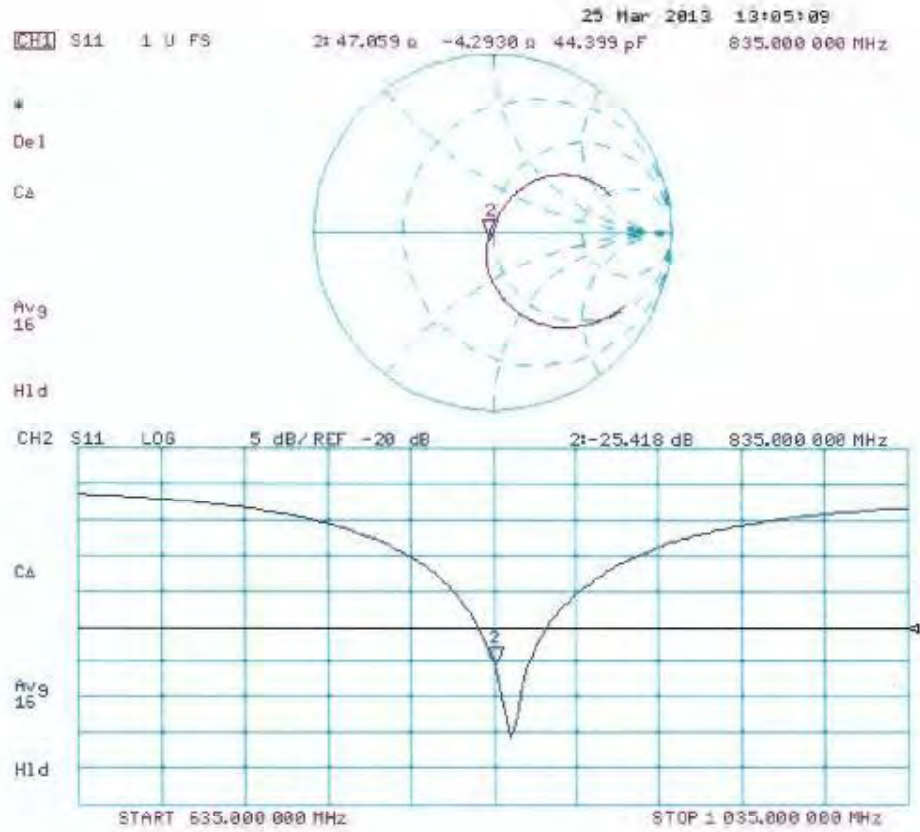





## Extended Dipole Calibrations

Referring to KDB 865664 D01 v01r03, if dipoles are verified in return loss ( $< -20\text{dB}$ , within 20% of prior calibration), and in impedance (within 5 ohm of prior calibration), the annual calibration is not necessary and the calibration interval can be extended.

**<Dipole Verification Data> - D835V2, serial no. 4d151(Date of Measurement 03.24.2014)**

### 835MHz - Head

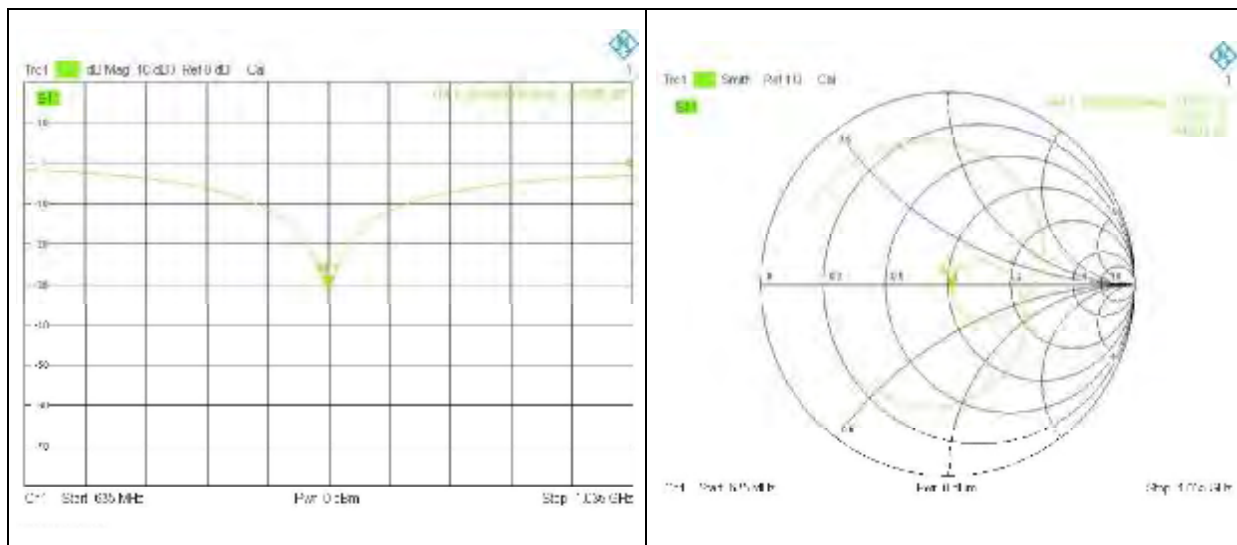

### 835MHz - Body

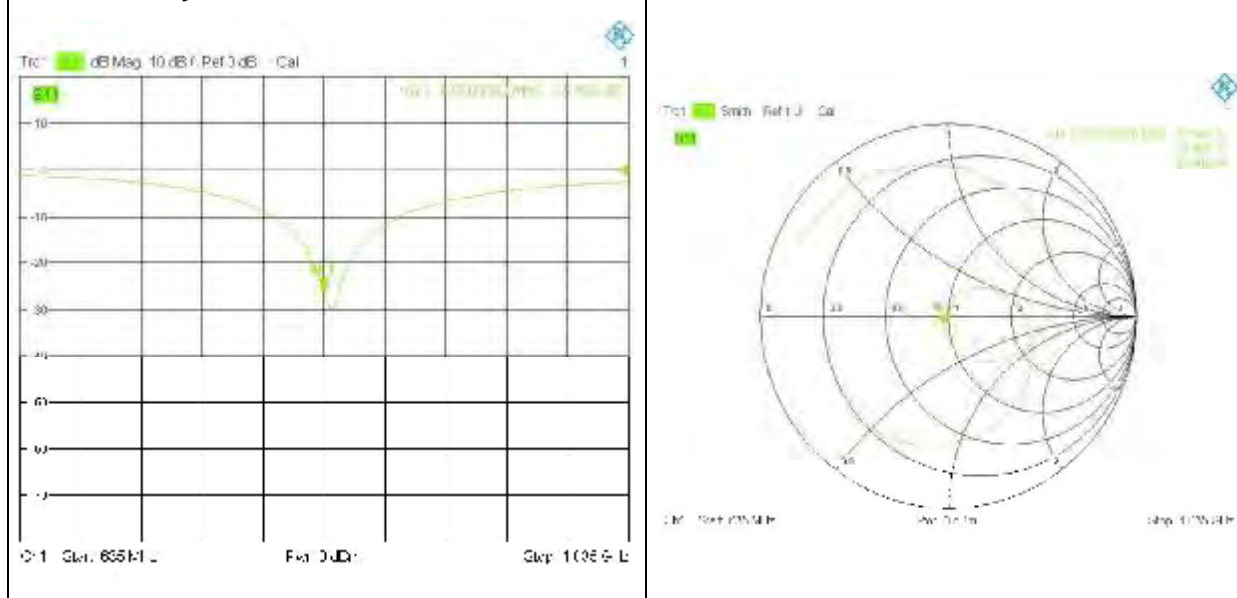



**<Justification of the extended calibration>**

D835V2 – serial no. 4d151												
TSL	Head						Body					
Date of Measurement	Return-Loss (dB)	Delta (%)	Real Impedance (ohm)	Delta (ohm)	Imaginary Impedance (ohm)	Delta (ohm)	Return-Loss (dB)	Delta (%)	Real Impedance (ohm)	Delta (ohm)	Imaginary Impedance (ohm)	Delta (ohm)
03.25.2013	-31.201		51.736		-2.201		-25.418		47.059		-4.2930	
03.24.2014	-30.505	2.23	51.767	0.031	-2.252	-0.051	-25.828	-1.613	47.599	0.54	-4.453	-0.16

The return loss is < -20dB, within 20% of prior calibration; the impedance is within 5 ohm of prior calibration.

Therefore the verification result should support extended calibration.



Accredited by the Swiss Accreditation Service (SAS)  
The Swiss Accreditation Service is one of the signatories to the EA  
Multilateral Agreement for the recognition of calibration certificates

Accreditation No.: **SCS 108**

Client **Sporton KS (Auden)**

Certificate No: **D1900V2-5d170\_Mar13**

## CALIBRATION CERTIFICATE

Object **D1900V2 - SN: 5d170**

Calibration procedure(s) **QA CAL-05.v9  
Calibration procedure for dipole validation kits above 700 MHz**

Calibration date: **March 27, 2013**

This calibration certificate documents the traceability to national standards, which realize the physical units of measurements (SI).  
The measurements and the uncertainties with confidence probability are given on the following pages and are part of the certificate.

All calibrations have been conducted in the closed laboratory facility; environment temperature  $(22 \pm 3)^\circ\text{C}$  and humidity  $< 70\%$ .

Calibration Equipment used (M&TE critical for calibration)

Primary Standards	ID #	Cal Date (Certificate No.)	Scheduled Calibration
Power meter EPM-442A	GB37480704	01-Nov-12 (No. 217-01640)	Oct-13
Power sensor HP 8481A	US37292783	01-Nov-12 (No. 217-01640)	Oct-13
Reference 20 dB Attenuator	SN: 5058 (20k)	27-Mar-12 (No. 217-01530)	Apr-13
Type-N mismatch combination	SN: 5047.3 / 06327	27-Mar-12 (No. 217-01533)	Apr-13
Reference Probe ES3DV3	SN: 3205	28-Dec-12 (No. ES3-3205_Dec12)	Dec-13
DAE4	SN: 601	27-Jun-12 (No. DAE4-601_Jun12)	Jun-13
Secondary Standards	ID #	Check Date (in house)	Scheduled Check
Power sensor HP 8481A	MY41092317	18-Oct-02 (in house check Oct-11)	In house check: Oct-13
RF generator R&S SMT-06	100005	04-Aug-99 (in house check Oct-11)	In house check: Oct-13
Network Analyzer HP 8753E	US37390585 54206	18-Oct-01 (in house check Oct-12)	In house check: Oct-13

	Name	Function	Signature
Calibrated by:	Leif Klysner	Laboratory Technician	
Approved by:	Katja Pokovic	Technical Manager	

Issued: March 27, 2013

This calibration certificate shall not be reproduced except in full without written approval of the laboratory.



**Calibration Laboratory of  
Schmid & Partner  
Engineering AG**  
Zeughausstrasse 43, 8004 Zurich, Switzerland



**S** Schweizerischer Kalibrierdienst  
**C** Service suisse d'étalonnage  
**S** Servizio svizzero di taratura  
**S** Swiss Calibration Service

Accredited by the Swiss Accreditation Service (SAS)

The Swiss Accreditation Service is one of the signatories to the EA  
Multilateral Agreement for the recognition of calibration certificates

Accreditation No.: **SCS 108**

**Glossary:**

TSL	tissue simulating liquid
ConvF	sensitivity in TSL / NORM x,y,z
N/A	not applicable or not measured

**Calibration is Performed According to the Following Standards:**

- IEEE Std 1528-2003, "IEEE Recommended Practice for Determining the Peak Spatial-Averaged Specific Absorption Rate (SAR) in the Human Head from Wireless Communications Devices: Measurement Techniques", December 2003
- IEC 62209-1, "Procedure to measure the Specific Absorption Rate (SAR) for hand-held devices used in close proximity to the ear (frequency range of 300 MHz to 3 GHz)", February 2005
- Federal Communications Commission Office of Engineering & Technology (FCC OET), "Evaluating Compliance with FCC Guidelines for Human Exposure to Radiofrequency Electromagnetic Fields; Additional Information for Evaluating Compliance of Mobile and Portable Devices with FCC Limits for Human Exposure to Radiofrequency Emissions", Supplement C (Edition 01-01) to Bulletin 65

**Additional Documentation:**

- DASY4/5 System Handbook

**Methods Applied and Interpretation of Parameters:**

- Measurement Conditions:** Further details are available from the Validation Report at the end of the certificate. All figures stated in the certificate are valid at the frequency indicated.
- Antenna Parameters with TSL:** The dipole is mounted with the spacer to position its feed point exactly below the center marking of the flat phantom section, with the arms oriented parallel to the body axis.
- Feed Point Impedance and Return Loss:** These parameters are measured with the dipole positioned under the liquid filled phantom. The impedance stated is transformed from the measurement at the SMA connector to the feed point. The Return Loss ensures low reflected power. No uncertainty required.
- Electrical Delay:** One-way delay between the SMA connector and the antenna feed point. No uncertainty required.
- SAR measured:** SAR measured at the stated antenna input power.
- SAR normalized:** SAR as measured, normalized to an input power of 1 W at the antenna connector.
- SAR for nominal TSL parameters:** The measured TSL parameters are used to calculate the nominal SAR result.

The reported uncertainty of measurement is stated as the standard uncertainty of measurement multiplied by the coverage factor  $k=2$ , which for a normal distribution corresponds to a coverage probability of approximately 95%.

## Measurement Conditions

DASY system configuration, as far as not given on page 1.

DASY Version	DASY5	V52.8.5
Extrapolation	Advanced Extrapolation	
Phantom	Modular Flat Phantom	
Distance Dipole Center - TSL	10 mm	with Spacer
Zoom Scan Resolution	dx, dy, dz = 5 mm	
Frequency	1900 MHz $\pm$ 1 MHz	

## Head TSL parameters

The following parameters and calculations were applied.

	Temperature	Permittivity	Conductivity
Nominal Head TSL parameters	22.0 °C	40.0	1.40 mho/m
Measured Head TSL parameters	(22.0 $\pm$ 0.2) °C	39.3 $\pm$ 6 %	1.38 mho/m $\pm$ 6 %
Head TSL temperature change during test	< 0.5 °C	----	----

## SAR result with Head TSL

SAR averaged over 1 cm <sup>3</sup> (1 g) of Head TSL	Condition	
SAR measured	250 mW input power	10.0 W/kg
SAR for nominal Head TSL parameters	normalized to 1W	40.2 W/kg $\pm$ 17.0 % (k=2)

SAR averaged over 10 cm <sup>3</sup> (10 g) of Head TSL	condition	
SAR measured	250 mW input power	5.25 W/kg
SAR for nominal Head TSL parameters	normalized to 1W	21.1 W/kg $\pm$ 16.5 % (k=2)

## Body TSL parameters

The following parameters and calculations were applied.

	Temperature	Permittivity	Conductivity
Nominal Body TSL parameters	22.0 °C	53.3	1.52 mho/m
Measured Body TSL parameters	(22.0 $\pm$ 0.2) °C	51.8 $\pm$ 6 %	1.53 mho/m $\pm$ 6 %
Body TSL temperature change during test	< 0.5 °C	----	---

## SAR result with Body TSL

SAR averaged over 1 cm <sup>3</sup> (1 g) of Body TSL	Condition	
SAR measured	250 mW input power	10.4 W/kg
SAR for nominal Body TSL parameters	normalized to 1W	41.2 W/kg $\pm$ 17.0 % (k=2)

SAR averaged over 10 cm <sup>3</sup> (10 g) of Body TSL	condition	
SAR measured	250 mW input power	5.49 W/kg
SAR for nominal Body TSL parameters	normalized to 1W	21.8 W/kg $\pm$ 16.5 % (k=2)

## Appendix

### Antenna Parameters with Head TSL

Impedance, transformed to feed point	$53.8 \Omega + 4.7 j\Omega$
Return Loss	- 24.7 dB

### Antenna Parameters with Body TSL

Impedance, transformed to feed point	$49.6 \Omega + 5.0 j\Omega$
Return Loss	- 26.0 dB

### General Antenna Parameters and Design

Electrical Delay (one direction)	1 202 ns
----------------------------------	----------

After long term use with 100W radiated power, only a slight warming of the dipole near the feedpoint can be measured.

The dipole is made of standard semirigid coaxial cable. The center conductor of the feeding line is directly connected to the second arm of the dipole. The antenna is therefore short-circuited for DC-signals. On some of the dipoles, small end caps are added to the dipole arms in order to improve matching when loaded according to the position as explained in the "Measurement Conditions" paragraph. The SAR data are not affected by this change. The overall dipole length is still according to the Standard.

No excessive force must be applied to the dipole arms, because they might bend or the soldered connections near the feedpoint may be damaged.

### Additional EUT Data

Manufactured by	SPEAG
Manufactured on	June 08, 2012



## DASY5 Validation Report for Head TSL

Date: 27.03.2013

Test Laboratory: SPEAG, Zurich, Switzerland

**DUT: Dipole 1900 MHz; Type: D1900V2; Serial: D1900V2 - SN: 5d170**

Communication System: CW; Frequency: 1900 MHz

Medium parameters used:  $f = 1900$  MHz;  $\sigma = 1.38$  S/m;  $\epsilon_r = 39.3$ ;  $\rho = 1000$  kg/m<sup>3</sup>

Phantom section: Flat Section

Measurement Standard: DASY5 (IEEE/IEC/ANSI C63.19-2007)

DASY52 Configuration:

- Probe: ES3DV3 - SN3205; ConvF(4.98, 4.98, 4.98); Calibrated: 28.12.2012;
- Sensor-Surface: 3mm (Mechanical Surface Detection)
- Electronics: DAE4 Sn601; Calibrated: 27.06.2012
- Phantom: Flat Phantom 5.0 (front); Type: QD000P50AA; Serial: 1001
- DASY52 52.8.5(1059); SEMCAD X 14.6.8(7028)

### Dipole Calibration for Head Tissue/Pin=250 mW, d=10mm/Zoom Scan (7x7x7)/Cube 0:

Measurement grid: dx=5mm, dy=5mm, dz=5mm

Reference Value = 96.871 V/m; Power Drift = 0.05 dB

Peak SAR (extrapolated) = 18.2 W/kg

**SAR(1 g) = 10 W/kg; SAR(10 g) = 5.25 W/kg**

Maximum value of SAR (measured) = 12.4 W/kg

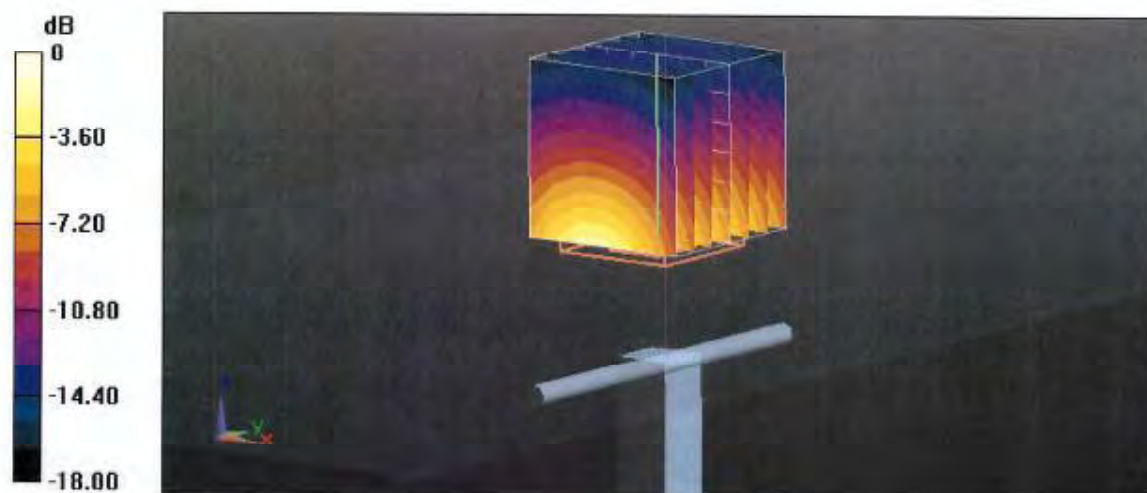

0 dB = 12.4 W/kg = 10.93 dBW/kg

# Impedance Measurement Plot for Head TSL

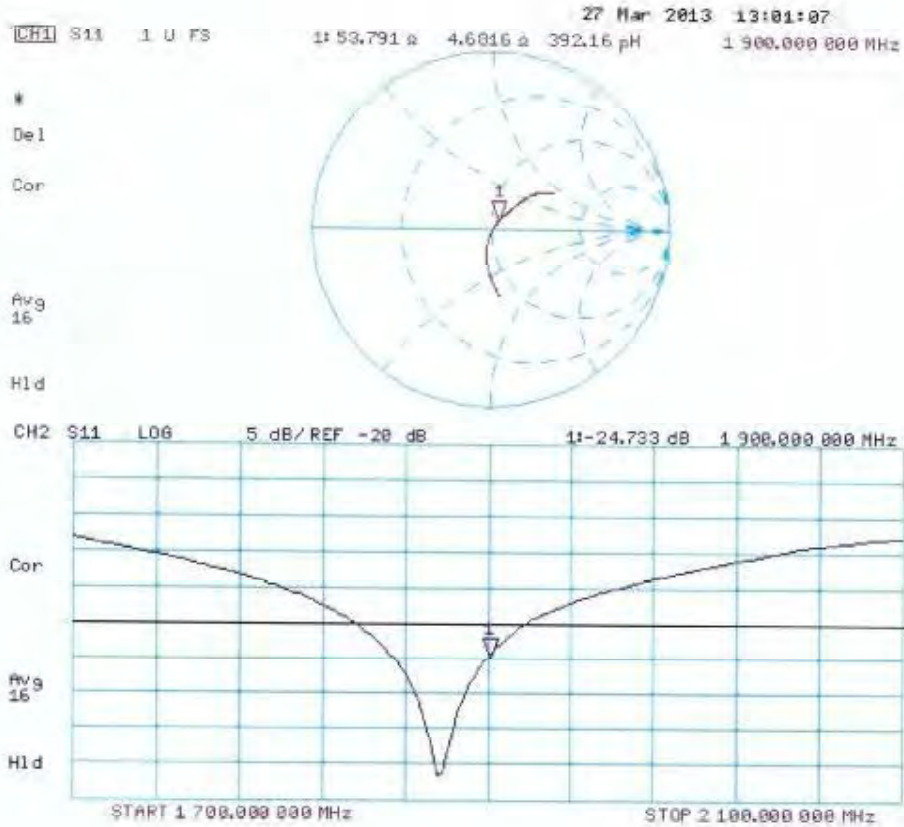



## DASY5 Validation Report for Body TSL

Date: 27.03.2013

Test Laboratory: SPEAG, Zurich, Switzerland

**DUT: Dipole 1900 MHz; Type: D1900V2; Serial: D1900V2 - SN: 5d170**

Communication System: CW; Frequency: 1900 MHz

Medium parameters used;  $f = 1900$  MHz;  $\sigma = 1.53$  S/m;  $\epsilon_r = 51.8$ ;  $\rho = 1000$  kg/m<sup>3</sup>

Phantom section: Flat Section

Measurement Standard: DASY5 (IEEE/IEC/ANSI C63.19-2007)

DASY52 Configuration:

- Probe: ES3DV3 - SN3205; ConvF(4.6, 4.6, 4.6); Calibrated: 28.12.2012;
- Sensor-Surface: 3mm (Mechanical Surface Detection)
- Electronics: DAF4 Sn601; Calibrated: 27.06.2012
- Phantom: Flat Phantom 5.0 (back); Type: QD000P50AA; Serial: 1002
- DASY52 52.8.5(1059); SEMCAD X 14.6.8(7028)

### Dipole Calibration for Body Tissue/Pin=250 mW, d=10mm/Zoom Scan (7x7x7)/Cube 0:

Measurement grid: dx=5mm, dy=5mm, dz=5mm

Reference Value = 96.871 V/m; Power Drift = 0.01 dB

Peak SAR (extrapolated) = 18.0 W/kg

**SAR(1 g) = 10.4 W/kg; SAR(10 g) = 5.49 W/kg**

Maximum value of SAR (measured) = 13.2 W/kg

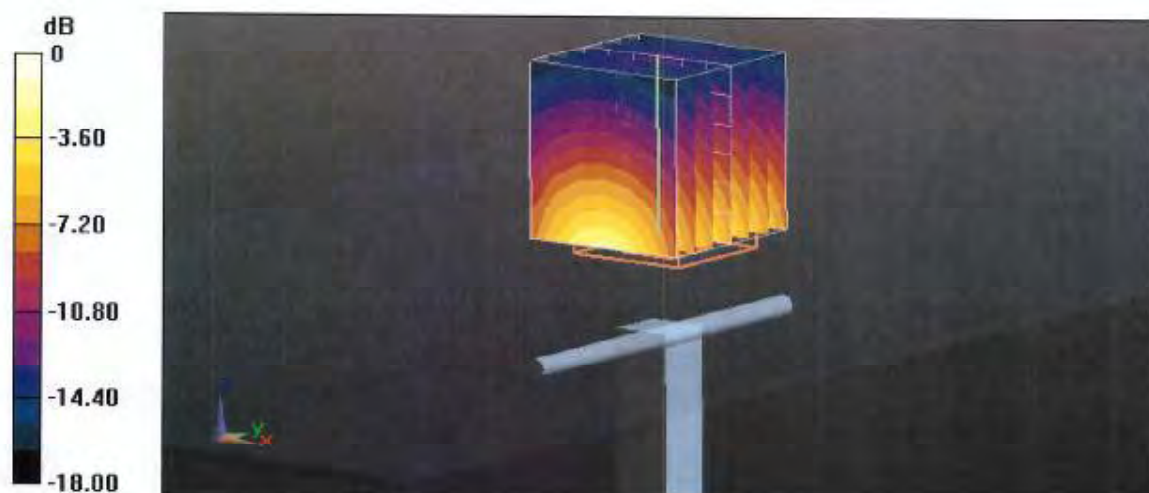

# Impedance Measurement Plot for Body TSL

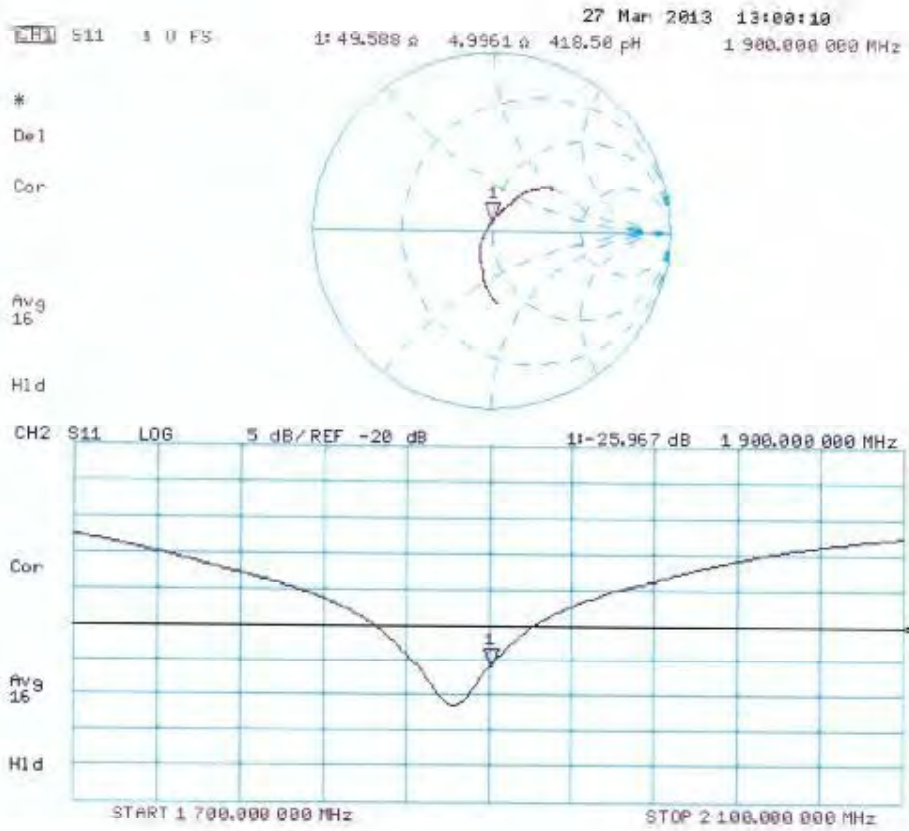



## Extended Dipole Calibrations

Referring to KDB 865664 D01 v01r03, if dipoles are verified in return loss ( $< -20\text{dB}$ , within 20% of prior calibration), and in impedance (within 5 ohm of prior calibration), the annual calibration is not necessary and the calibration interval can be extended.

**<Dipole Verification Data> - D1900V2, serial no. 5d170(Date of Measurement 03.26.2014)**

### 1900MHz - Head

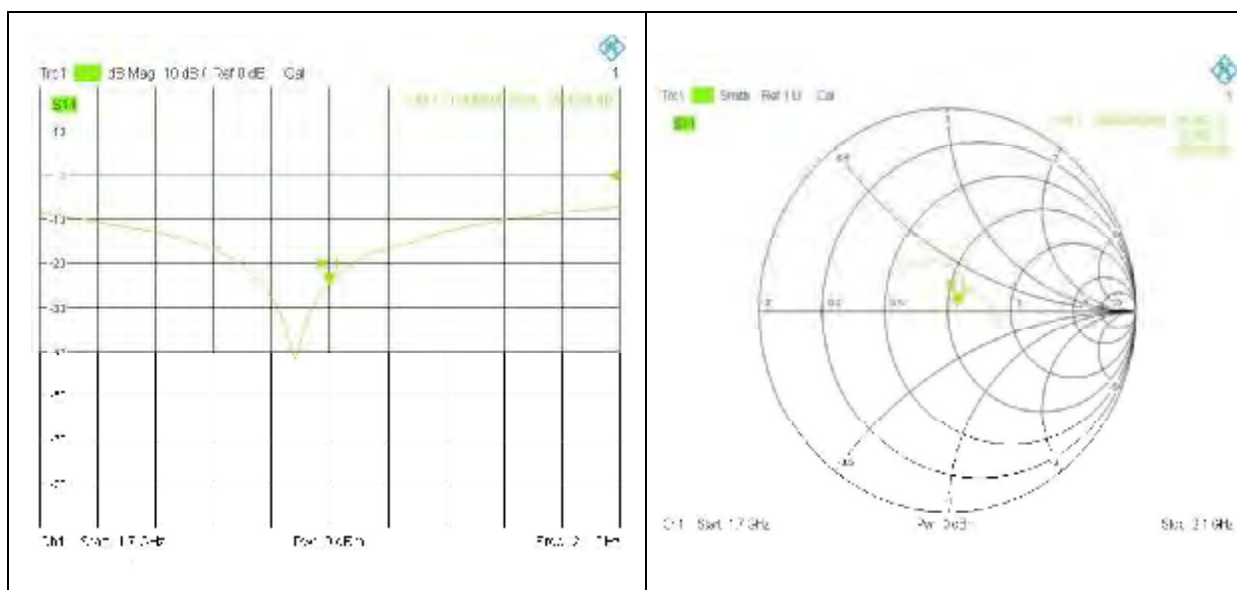

### 1900MHz - Body

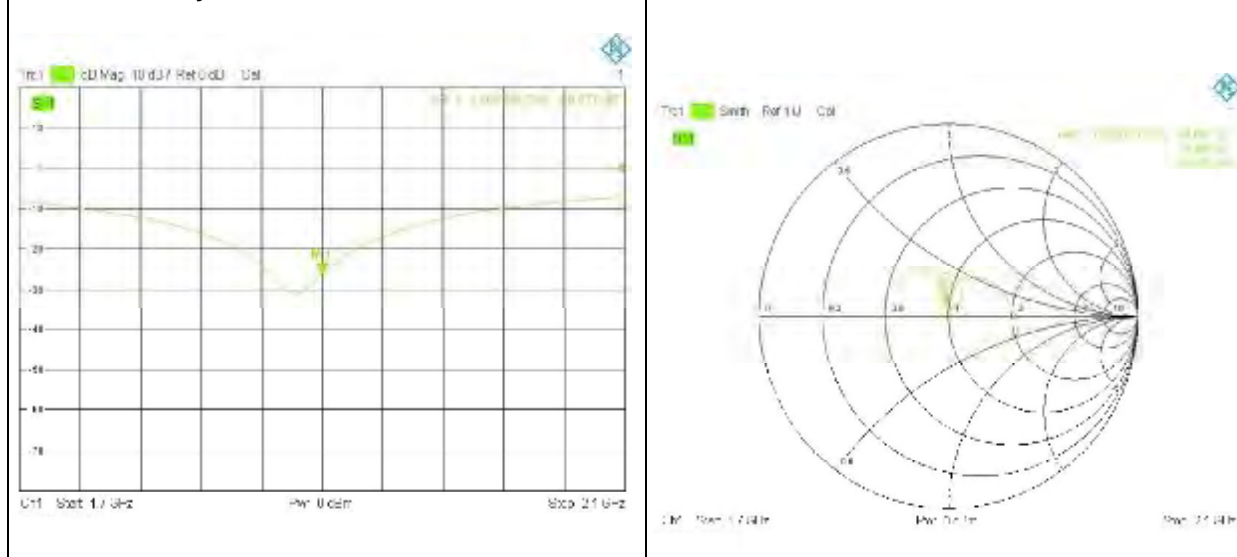

**SPORTON INTERNATIONAL INC.**

TEL : 886-3-327-3456

FAX : 886-3-328-4978



**<Justification of the extended calibration>**

D1900V2 – serial no. 5d170												
TSL	Head						Body					
Date of Measurement	Return-Loss (dB)	Delta (%)	Real Impedance (ohm)	Delta (ohm)	Imaginary Impedance (ohm)	Delta (ohm)	Return-Loss (dB)	Delta (%)	Real Impedance (ohm)	Delta (ohm)	Imaginary Impedance (ohm)	Delta (ohm)
03.27.2013	-24.733		53.791		4.682		-25.967		49.588		4.996	
03.26.2014	-24.628	0.425	55.002	1.211	3.868	-0.814	-26.017	-0.193	49.067	-0.521	5.486	0.490

The return loss is < -20dB, within 20% of prior calibration; the impedance is within 5 ohm of prior calibration.

Therefore the verification result should support extended calibration.



Accredited by the Swiss Accreditation Service (SAS)  
The Swiss Accreditation Service is one of the signatories to the EA  
Multilateral Agreement for the recognition of calibration certificates

Accreditation No.: **SCS 108**

Client **Sporton-KS (Auden)**

Certificate No: **D2450V2-908\_Mar13**

## CALIBRATION CERTIFICATE

Object **D2450V2 - SN: 908**

Calibration procedure(s) **QA CAL-05.v9  
Calibration procedure for dipole validation kits above 700 MHz**

Calibration date: **March 26, 2013**

This calibration certificate documents the traceability to national standards, which realize the physical units of measurements (SI).  
The measurements and the uncertainties with confidence probability are given on the following pages and are part of the certificate.

All calibrations have been conducted in the closed laboratory facility: environment temperature (22 ± 3)°C and humidity < 70%.

Calibration Equipment used (M&TE critical for calibration)

Primary Standards	ID #	Cal Date (Certificate No.)	Scheduled Calibration
Power meter EPM-442A	GB37480704	01-Nov-12 (No. 217-01640)	Oct-13
Power sensor HP 8481A	US37292783	01-Nov-12 (No. 217-01640)	Oct-13
Reference 20 dB Attenuator	SN: 5058 (20k)	27-Mar-12 (No. 217-01530)	Apr-13
Type-N mismatch combination	SN: 5047.3 / 06327	27-Mar-12 (No. 217-01533)	Apr-13
Reference Probe ES3DV3	SN: 3205	28-Dec-12 (No. ES3-3205_Dec12)	Dec-13
DAE4	SN: 601	27-Jun-12 (No. DAE4-601_Jun12)	Jun-13
Secondary Standards	ID #	Check Date (In house)	Scheduled Check
Power sensor HP 8481A	MY41092317	18-Oct-02 (In house check Oct-11)	In house check: Oct-13
RF generator R&S SMT-06	100005	04-Aug-99 (In house check Oct-11)	In house check: Oct-13
Network Analyzer HP 8753E	US37390585 S4206	18-Oct-01 (In house check Oct-12)	In house check: Oct-13

Calibrated by: **Name** Claudio Leubler **Function** Laboratory Technician

**Signature**

Approved by: **Name** Katja Pokovic **Function** Technical Manager

Issued: March 26, 2013

This calibration certificate shall not be reproduced except in full without written approval of the laboratory.



**Calibration Laboratory of  
Schmid & Partner  
Engineering AG**  
Zeughausstrasse 43, 8004 Zurich, Switzerland



**S** Schweizerischer Kalibrierdienst  
**C** Service suisse d'étalonnage  
**S** Servizio svizzero di taratura  
**S** Swiss Calibration Service

Accredited by the Swiss Accreditation Service (SAS)

The Swiss Accreditation Service is one of the signatories to the EA  
Multilateral Agreement for the recognition of calibration certificates

Accreditation No.: **SCS 108**

**Glossary:**

TSL	tissue simulating liquid
ConvF	sensitivity in TSL / NORM x,y,z
N/A	not applicable or not measured

**Calibration is Performed According to the Following Standards:**

- IEEE Std 1528-2003, "IEEE Recommended Practice for Determining the Peak Spatial-Averaged Specific Absorption Rate (SAR) in the Human Head from Wireless Communications Devices: Measurement Techniques", December 2003
- IEC 62209-1, "Procedure to measure the Specific Absorption Rate (SAR) for hand-held devices used in close proximity to the ear (frequency range of 300 MHz to 3 GHz)", February 2005
- Federal Communications Commission Office of Engineering & Technology (FCC OET), "Evaluating Compliance with FCC Guidelines for Human Exposure to Radiofrequency Electromagnetic Fields; Additional Information for Evaluating Compliance of Mobile and Portable Devices with FCC Limits for Human Exposure to Radiofrequency Emissions", Supplement C (Edition 01-01) to Bulletin 65

**Additional Documentation:**

- DASY4/5 System Handbook

**Methods Applied and Interpretation of Parameters:**

- Measurement Conditions:** Further details are available from the Validation Report at the end of the certificate. All figures stated in the certificate are valid at the frequency indicated.
- Antenna Parameters with TSL:** The dipole is mounted with the spacer to position its feed point exactly below the center marking of the flat phantom section, with the arms oriented parallel to the body axis.
- Feed Point Impedance and Return Loss:** These parameters are measured with the dipole positioned under the liquid filled phantom. The impedance stated is transformed from the measurement at the SMA connector to the feed point. The Return Loss ensures low reflected power. No uncertainty required.
- Electrical Delay:** One-way delay between the SMA connector and the antenna feed point. No uncertainty required.
- SAR measured:** SAR measured at the stated antenna input power.
- SAR normalized:** SAR as measured, normalized to an input power of 1 W at the antenna connector.
- SAR for nominal TSL parameters:** The measured TSL parameters are used to calculate the nominal SAR result.

The reported uncertainty of measurement is stated as the standard uncertainty of measurement multiplied by the coverage factor  $k=2$ , which for a normal distribution corresponds to a coverage probability of approximately 95%.

## Measurement Conditions

DASY system configuration, as far as not given on page 1.

DASY Version	DASY5	V52.8.5
Extrapolation	Advanced Extrapolation	
Phantom	Modular Flat Phantom	
Distance Dipole Center - TSL	10 mm	with Spacer
Zoom Scan Resolution	dx, dy, dz = 5 mm	
Frequency	2450 MHz $\pm$ 1 MHz	

## Head TSL parameters

The following parameters and calculations were applied.

	Temperature	Permittivity	Conductivity
Nominal Head TSL parameters	22.0 °C	39.2	1.80 mho/m
Measured Head TSL parameters	(22.0 $\pm$ 0.2) °C	37.8 $\pm$ 6 %	1.85 mho/m $\pm$ 6 %
Head TSL temperature change during test	< 0.5 °C	---	---

## SAR result with Head TSL

SAR averaged over 1 cm <sup>3</sup> (1 g) of Head TSL	Condition	
SAR measured	250 mW input power	13.8 W/kg
SAR for nominal Head TSL parameters	normalized to 1W	<b>54.0 W/kg <math>\pm</math> 17.0 % (k=2)</b>

SAR averaged over 10 cm <sup>3</sup> (10 g) of Head TSL	condition	
SAR measured	250 mW input power	6.36 W/kg
SAR for nominal Head TSL parameters	normalized to 1W	<b>25.1 W/kg <math>\pm</math> 16.5 % (k=2)</b>

## Body TSL parameters

The following parameters and calculations were applied.

	Temperature	Permittivity	Conductivity
Nominal Body TSL parameters	22.0 °C	52.7	1.95 mho/m
Measured Body TSL parameters	(22.0 $\pm$ 0.2) °C	50.7 $\pm$ 6 %	2.01 mho/m $\pm$ 6 %
Body TSL temperature change during test	< 0.5 °C	---	---

## SAR result with Body TSL

SAR averaged over 1 cm <sup>3</sup> (1 g) of Body TSL	Condition	
SAR measured	250 mW input power	12.9 W/kg
SAR for nominal Body TSL parameters	normalized to 1W	<b>50.4 W/kg <math>\pm</math> 17.0 % (k=2)</b>

SAR averaged over 10 cm <sup>3</sup> (10 g) of Body TSL	condition	
SAR measured	250 mW input power	5.94 W/kg
SAR for nominal Body TSL parameters	normalized to 1W	<b>23.4 W/kg <math>\pm</math> 16.5 % (k=2)</b>



## Appendix

### Antenna Parameters with Head TSL

Impedance, transformed to feed point	56.5 $\Omega$ - 0.1 $j\Omega$
Return Loss	- 24.3 dB

### Antenna Parameters with Body TSL

Impedance, transformed to feed point	52.6 $\Omega$ + 1.9 $j\Omega$
Return Loss	- 30.0 dB

### General Antenna Parameters and Design

Electrical Delay (one direction)	1.156 ns
----------------------------------	----------

After long term use with 100W radiated power, only a slight warming of the dipole near the feedpoint can be measured.

The dipole is made of standard semirigid coaxial cable. The center conductor of the feeding line is directly connected to the second arm of the dipole. The antenna is therefore short-circuited for DC-signals. On some of the dipoles, small end caps are added to the dipole arms in order to improve matching when loaded according to the position as explained in the "Measurement Conditions" paragraph. The SAR data are not affected by this change. The overall dipole length is still according to the Standard.

No excessive force must be applied to the dipole arms, because they might bend or the soldered connections near the feedpoint may be damaged.

### Additional EUT Data

Manufactured by	SPEAG
Manufactured on	December 19, 2012

## DASY5 Validation Report for Head TSL

Date: 26.03.2013

Test Laboratory: SPEAG, Zurich, Switzerland

**DUT: Dipole 2450 MHz; Type: D2450V2; Serial: D2450V2 - SN: 908**

Communication System: CW; Frequency: 2450 MHz

Medium parameters used:  $f = 2450$  MHz;  $\sigma = 1.85$  S/m;  $\epsilon_r = 37.8$ ;  $\rho = 1000$  kg/m<sup>3</sup>

Phantom section: Flat Section

Measurement Standard: DASY5 (IEEE/IEC/ANSI C63.19-2007)

DASY52 Configuration:

- Probe: ES3DV3 - SN3205; ConvF(4.52, 4.52, 4.52); Calibrated: 28.12.2012;
- Sensor-Surface: 3mm (Mechanical Surface Detection)
- Electronics: DAE4 Sn601; Calibrated: 27.06.2012
- Phantom: Flat Phantom 5.0 (front); Type: QD000P50AA; Serial: 1001
- DASY52 52.8.5(1059); SEMCAD X 14.6.8(7028)

### Dipole Calibration for Head Tissue/Pin=250 mW, d=10mm/Zoom Scan (7x7x7)/Cube 0:

Measurement grid: dx=5mm, dy=5mm, dz=5mm

Reference Value = 94.957 V/m; Power Drift = 0.04 dB

Peak SAR (extrapolated) = 28.8 W/kg

**SAR(1 g) = 13.8 W/kg; SAR(10 g) = 6.36 W/kg**

Maximum value of SAR (measured) = 17.9 W/kg

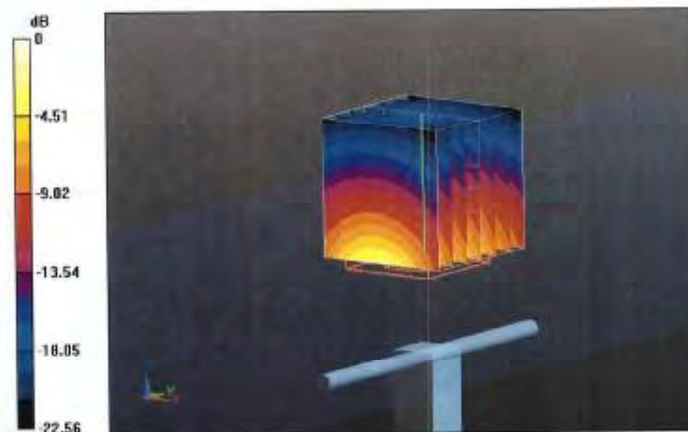

0 dB = 17.9 W/kg = 12.53 dBW/kg

# Impedance Measurement Plot for Head TSL

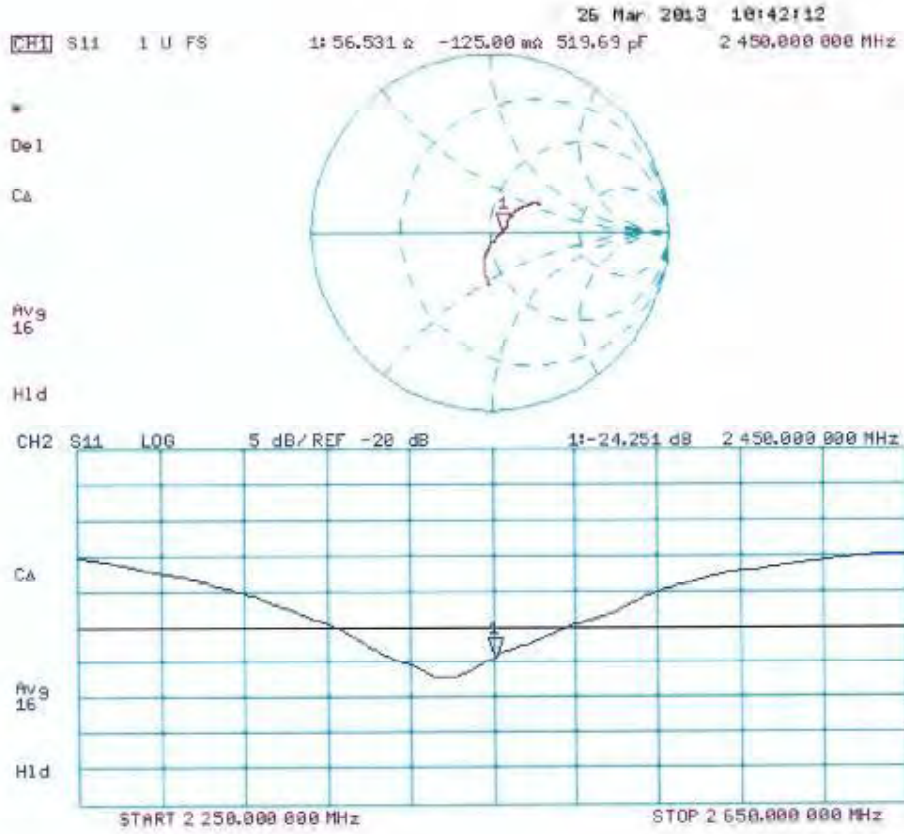

## DASY5 Validation Report for Body TSL

Date: 26.03.2013

Test Laboratory: SPEAG, Zurich, Switzerland

**DUT: Dipole 2450 MHz; Type: D2450V2; Serial: D2450V2 - SN: 908**

Communication System: CW; Frequency: 2450 MHz

Medium parameters used:  $f = 2450$  MHz;  $\sigma = 2.01$  S/m;  $\epsilon_r = 50.7$ ;  $\rho = 1000$  kg/m<sup>3</sup>

Phantom section: Flat Section

Measurement Standard: DASY5 (IEEE/IEC/ANSI C63.19-2007)

DASY52 Configuration:

- Probe: ES3DV3 - SN3205; ConvF(4.42, 4.42, 4.42); Calibrated: 28.12.2012;
- Sensor-Surface: 3mm (Mechanical Surface Detection)
- Electronics: DAE4 Sn601; Calibrated: 27.06.2012
- Phantom: Flat Phantom 5.0 (back); Type: QD000P50AA; Serial: 1002
- DASY52 52.8.5(1059); SEMCAD X 14.6.8(7028)

### Dipole Calibration for Body Tissue/Pin=250 mW, d=10mm/Zoom Scan (7x7x7)/Cube 0:

Measurement grid:  $dx=5$ mm,  $dy=5$ mm,  $dz=5$ mm

Reference Value = 94.957 V/m; Power Drift = 0.00 dB

Peak SAR (extrapolated) = 27.0 W/kg

**SAR(1 g) = 12.9 W/kg; SAR(10 g) = 5.94 W/kg**

Maximum value of SAR (measured) = 17.1 W/kg

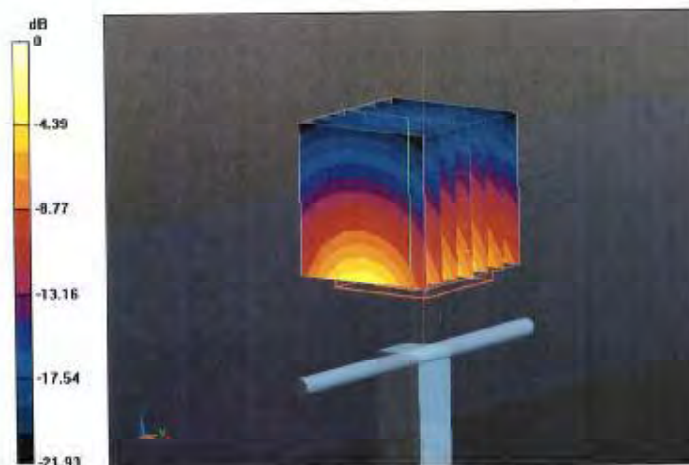

0 dB = 17.1 W/kg = 12.33 dBW/kg



# Impedance Measurement Plot for Body TSL

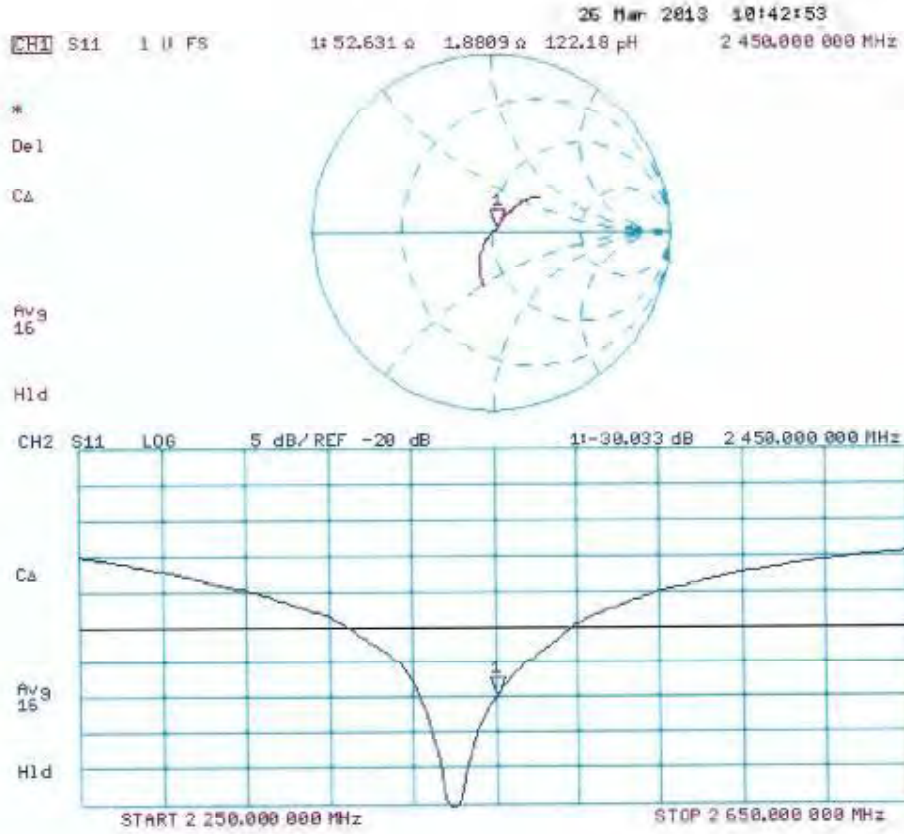



## Extended Dipole Calibrations

Referring to KDB 865664 D01 v01r03, if dipoles are verified in return loss ( $< -20\text{dB}$ , within 20% of prior calibration), and in impedance (within 5 ohm of prior calibration), the annual calibration is not necessary and the calibration interval can be extended.

**<Dipole Verification Data> - D2450V2, serial no. 908(Date of Measurement 03.25.2014)**

### 2450MHz - Head

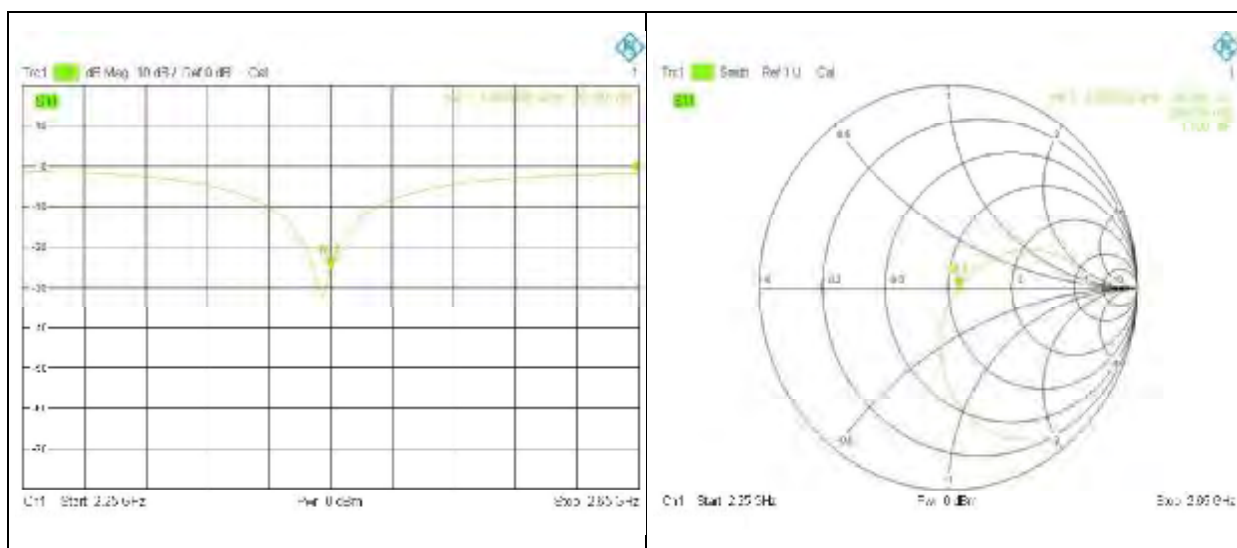

### 2450MHz - Body

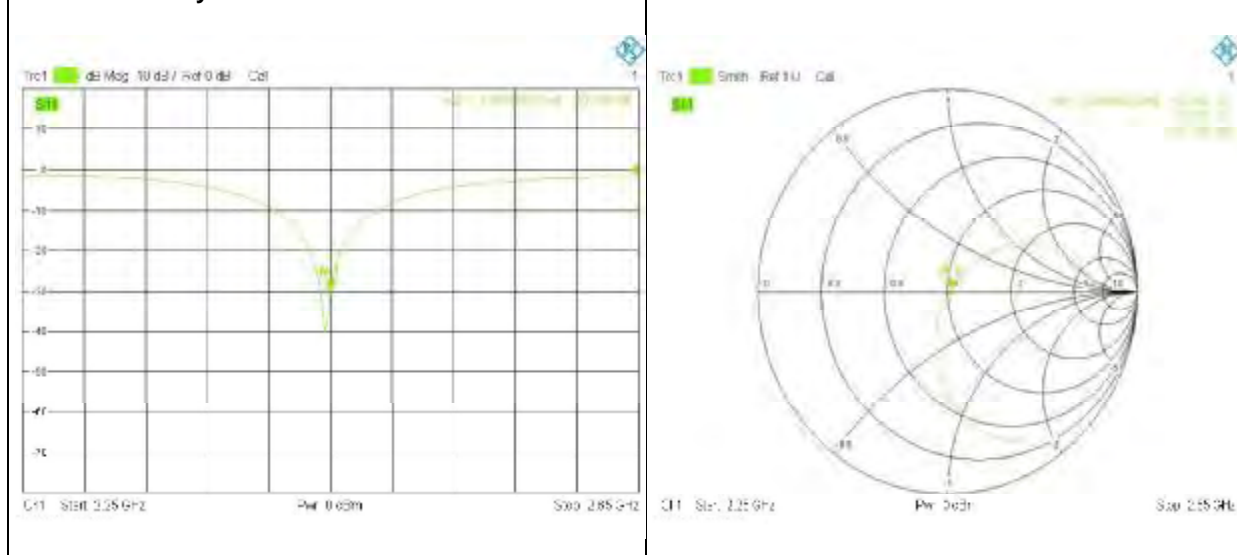



**<Justification of the extended calibration>**

D2450V2 – serial no. 908												
TSL	Head						Body					
Date of Measurement	Return-Loss (dB)	Delta (%)	Real Impedance (ohm)	Delta (ohm)	Imaginary Impedance (ohm)	Delta (ohm)	Return-Loss (dB)	Delta (%)	Real Impedance (ohm)	Delta (ohm)	Imaginary Impedance (ohm)	Delta (ohm)
03.26.2013	-24.251		56.531		-0.125		-30.033		52.631		1.881	
03.25.2014	-25.155	-0.373	56.061	-0.47	-0.059	0.066	-29.785	0.826	52.379	-0.252	1.510	-0.371

The return loss is < -20dB, within 20% of prior calibration; the impedance is within 5 ohm of prior calibration.

Therefore the verification result should support extended calibration.



910

## IMPORTANT NOTICE

### USAGE OF THE DAE 4

The DAE unit is a delicate, high precision instrument and requires careful treatment by the user. There are no serviceable parts inside the DAE. Special attention shall be given to the following points:

**Battery Exchange:** The battery cover of the DAE4 unit is closed using a screw, over tightening the screw may cause the threads inside the DAE to wear out.

**Shipping of the DAE:** Before shipping the DAE to SPEAG for calibration, remove the batteries and pack the DAE in an antistatic bag. This antistatic bag shall then be packed into a larger box or container which protects the DAE from impacts during transportation. The package shall be marked to indicate that a fragile instrument is inside.

**E-Stop Failures:** Touch detection may be malfunctioning due to broken magnets in the E-stop. Rough handling of the E-stop may lead to damage of these magnets. Touch and collision errors are often caused by dust and dirt accumulated in the E-stop. To prevent E-stop failure, the customer shall always mount the probe to the DAE carefully and keep the DAE unit in a non-dusty environment if not used for measurements.

**Repair:** Minor repairs are performed at no extra cost during the annual calibration. However, SPEAG reserves the right to charge for any repair especially if rough unprofessional handling caused the defect.

**DASY Configuration Files:** Since the exact values of the DAE input resistances, as measured during the calibration procedure of a DAE unit, are not used by the DASY software, a nominal value of 200 MOhm is given in the corresponding configuration file.

**Important Note:**

**Warranty and calibration is void if the DAE unit is disassembled partly or fully by the Customer.**

**Important Note:**

**Never attempt to grease or oil the E-stop assembly. Cleaning and readjusting of the E-stop assembly is allowed by certified SPEAG personnel only and is part of the annual calibration procedure.**

**Important Note:**

**To prevent damage of the DAE probe connector pins, use great care when installing the probe to the DAE. Carefully connect the probe with the connector notch oriented in the mating position. Avoid any rotational movement of the probe body versus the DAE while turning the locking nut of the connector. The same care shall be used when disconnecting the probe from the DAE.**

**Calibration Laboratory of  
Schmid & Partner  
Engineering AG**  
Zeughausstrasse 43, 8004 Zurich, Switzerland



**S** Schweizerischer Kalibrierdienst  
**C** Service suisse d'étalonnage  
**S** Servizio svizzero di taratura  
**S** Swiss Calibration Service

Accredited by the Swiss Accreditation Service (SAS)  
The Swiss Accreditation Service is one of the signatories to the EA  
Multilateral Agreement for the recognition of calibration certificates

Accreditation No.: **SCS 108**

Client **Auden**

Certificate No: **DAE4-910\_Jul14**

**CALIBRATION CERTIFICATE**

Object **DAE4 - SD 000 D04 BK - SN: 910**

Calibration procedure(s) **QA CAL-06.v26  
Calibration procedure for the data acquisition electronics (DAE)**

Calibration date: **July 22, 2014**

This calibration certificate documents the traceability to national standards, which realize the physical units of measurements (SI).  
The measurements and the uncertainties with confidence probability are given on the following pages and are part of the certificate.

All calibrations have been conducted in the closed laboratory facility: environment temperature (22 ± 3)°C and humidity < 70%.

Calibration Equipment used (M&TE critical for calibration)

Primary Standards	ID #	Cal Date (Certificate No.)	Scheduled Calibration
Keithley Multimeter Type 2001	SN: 0810278	01-Oct-13 (No:13976)	Oct-14
Secondary Standards	ID #	Check Date (in house)	Scheduled Check
Auto DAE Calibration Unit	SE UWS 053 AA 1001	07-Jan-14 (in house check)	In house check: Jan-15
Calibrator Box V2.1	SE UMS 006 AA 1002	07-Jan-14 (in house check)	In house check: Jan-15

Calibrated by:	Name <b>Eric Hairfeld</b>	Function <b>Technician</b>	Signature 
Approved by:	Name <b>Fin Bomholt</b>	Function <b>Deputy Technical Manager</b>	Signature 

Issued: July 22, 2014

This calibration certificate shall not be reproduced except in full without written approval of the laboratory.



Accredited by the Swiss Accreditation Service (SAS)  
The Swiss Accreditation Service is one of the signatories to the EA  
Multilateral Agreement for the recognition of calibration certificates

Accreditation No.: **SCS 108**

## Glossary

**DAE** data acquisition electronics  
**Connector angle** information used in DASY system to align probe sensor X to the robot coordinate system.

## Methods Applied and Interpretation of Parameters

- **DC Voltage Measurement:** Calibration Factor assessed for use in DASY system by comparison with a calibrated instrument traceable to national standards. The figure given corresponds to the full scale range of the voltmeter in the respective range.
- **Connector angle:** The angle of the connector is assessed measuring the angle mechanically by a tool inserted. Uncertainty is not required.
- The following parameters as documented in the Appendix contain technical information as a result from the performance test and require no uncertainty.
  - **DC Voltage Measurement Linearity:** Verification of the Linearity at +10% and -10% of the nominal calibration voltage. Influence of offset voltage is included in this measurement.
  - **Common mode sensitivity:** Influence of a positive or negative common mode voltage on the differential measurement.
  - **Channel separation:** Influence of a voltage on the neighbor channels not subject to an input voltage.
  - **AD Converter Values with inputs shorted:** Values on the internal AD converter corresponding to zero input voltage
  - **Input Offset Measurement:** Output voltage and statistical results over a large number of zero voltage measurements.
  - **Input Offset Current:** Typical value for information; Maximum channel input offset current, not considering the input resistance.
  - **Input resistance:** Typical value for information: DAE input resistance at the connector, during internal auto-zeroing and during measurement.
  - **Low Battery Alarm Voltage:** Typical value for information. Below this voltage, a battery alarm signal is generated.
  - **Power consumption:** Typical value for information. Supply currents in various operating modes.

## DC Voltage Measurement

A/D - Converter Resolution nominal

High Range: 1LSB = 6.1 $\mu$ V, full range = -100...+300 mV

Low Range: 1LSB = 61nV, full range = -1.....+3mV

DASY measurement parameters: Auto Zero Time: 3 sec; Measuring time: 3 sec

Calibration Factors	X	Y	Z
High Range	403.348 $\pm$ 0.02% (k=2)	402.752 $\pm$ 0.02% (k=2)	403.234 $\pm$ 0.02% (k=2)
Low Range	3.98201 $\pm$ 1.50% (k=2)	3.94344 $\pm$ 1.50% (k=2)	3.94847 $\pm$ 1.50% (k=2)

## Connector Angle

Connector Angle to be used in DASY system	316.0 $^{\circ}$ $\pm$ 1 $^{\circ}$
---	-------------------------------------



## Appendix (Additional assessments outside the scope of SCS108)

### 1. DC Voltage Linearity

High Range	Reading ( $\mu\text{V}$ )	Difference ( $\mu\text{V}$ )	Error (%)
Channel X + Input	199998.71	1.51	0.00
Channel X + Input	20000.48	-0.21	-0.00
Channel X - Input	-19998.81	2.28	-0.01
Channel Y + Input	199998.85	1.57	0.00
Channel Y + Input	19999.30	-1.40	-0.01
Channel Y - Input	-20000.58	0.74	-0.00
Channel Z + Input	199998.43	1.07	0.00
Channel Z + Input	19998.71	-1.96	-0.01
Channel Z - Input	-20000.94	0.37	-0.00

Low Range	Reading ( $\mu\text{V}$ )	Difference ( $\mu\text{V}$ )	Error (%)
Channel X + Input	2000.31	-0.38	-0.02
Channel X + Input	201.90	0.87	0.43
Channel X - Input	-198.05	0.69	-0.35
Channel Y + Input	2000.11	-0.54	-0.03
Channel Y + Input	199.75	-1.32	-0.66
Channel Y - Input	-199.53	-0.73	0.37
Channel Z + Input	2000.34	-0.27	-0.01
Channel Z + Input	199.99	-0.95	-0.47
Channel Z - Input	-199.35	-0.46	0.23

### 2. Common mode sensitivity

DASY measurement parameters: Auto Zero Time: 3 sec; Measuring time: 3 sec

	Common mode Input Voltage (mV)	High Range Average Reading ( $\mu\text{V}$ )	Low Range Average Reading ( $\mu\text{V}$ )
Channel X	200	-13.46	-15.29
	-200	17.07	15.06
Channel Y	200	5.80	5.24
	-200	-7.65	-8.04
Channel Z	200	-11.26	-11.22
	-200	10.76	10.71

### 3. Channel separation

DASY measurement parameters: Auto Zero Time: 3 sec; Measuring time: 3 sec

	Input Voltage (mV)	Channel X ( $\mu\text{V}$ )	Channel Y ( $\mu\text{V}$ )	Channel Z ( $\mu\text{V}$ )
Channel X	200	-	4.01	-2.63
Channel Y	200	9.95	-	5.72
Channel Z	200	10.54	7.37	-

#### 4. AD-Converter Values with inputs shorted

DASY measurement parameters: Auto Zero Time: 3 sec; Measuring time: 3 sec

	High Range (LSB)	Low Range (LSB)
Channel X	16188	16055
Channel Y	15380	16315
Channel Z	16713	16050

#### 5. Input Offset Measurement

DASY measurement parameters: Auto Zero Time: 3 sec; Measuring time: 3 sec

Input 10M $\Omega$

	Average ( $\mu$ V)	min. Offset ( $\mu$ V)	max. Offset ( $\mu$ V)	Std. Deviation ( $\mu$ V)
Channel X	0.64	-0.79	2.46	0.65
Channel Y	-1.22	-2.56	0.31	0.59
Channel Z	-0.57	-2.04	1.01	0.60

#### 6. Input Offset Current

Nominal Input circuitry offset current on all channels: <25fA

#### 7. Input Resistance (Typical values for information)

	Zeroing (kOhm)	Measuring (MOhm)
Channel X	200	200
Channel Y	200	200
Channel Z	200	200

#### 8. Low Battery Alarm Voltage (Typical values for information)

Typical values	Alarm Level (VDC)
Supply (+ Vcc)	+7.9
Supply (- Vcc)	-7.6

#### 9. Power Consumption (Typical values for information)

Typical values	Switched off (mA)	Stand by (mA)	Transmitting (mA)
Supply (+ Vcc)	+0.01	+6	+14
Supply (- Vcc)	-0.01	-8	-9





In Collaboration with  
**s p e a g**  
 CALIBRATION LABORATORY



Add: No.52 Huayuanbei Road, Haidian District, Beijing, 100191, China  
 Tel: +86-10-62304633-2079 Fax: +86-10-62304633-2504  
 E-mail: Info@cmcte.com Http://www.cmcte.com

Client **Auden**

Certificate No: **Z14-97002**

## CALIBRATION CERTIFICATE

Object **EX3DV4 - SN:3661**

Calibration Procedure(s) **TMC-OS-E-02-195**  
**Calibration Procedures for Dosimetric E-field Probes**

Calibration date: **March 10, 2014**

This calibration Certificate documents the traceability to national standards, which realize the physical units of measurements(SI). The measurements and the uncertainties with confidence probability are given on the following pages and are part of the certificate.

All calibrations have been conducted in the closed laboratory facility: environment temperature(22±3)°C and humidity<70%.

### Calibration Equipment used (M&TE critical for calibration)

Primary Standards	ID #	Cal Date(Calibrated by, Certificate No.)	Scheduled Calibration
Power Meter NRP2	101919	01-Jul-13 (TMC, No.JW13-044)	Jun-14
Power sensor NRP-Z91	101547	01-Jul-13 (TMC, No.JW13-044)	Jun-14
Power sensor NRP-Z91	101548	01-Jul-13 (TMC, No.JW13-044)	Jun-14
Reference10dBAttenuator	BT0520	12-Dec-12(TMC,No.JZ12-867)	Dec-14
Reference20dBAttenuator	BT0267	12-Dec-12(TMC,No.JZ12-866)	Dec-14
Reference Probe EX3DV4	SN 3846	03-Sep-13(SPEAG,No.EX3-3846_Sep13)	Sep-14
DAE4	SN 777	22-Feb-13 (SPEAG, DAE4-777_Feb13)	Feb -14
DAE4	SN 905	11-Jun-13 (SPEAG, DAE4-905_Jun13)	Jun -14
Secondary Standards	ID #	Cal Date(Calibrated by, Certificate No.)	Scheduled Calibration
SignalGeneratorMG3700A	6201052605	01-Jul-13 (TMC, No.JW13-045)	Jun-14
Network Analyzer E5071C	MY46110673	15-Feb-14 (TMC, No.JZ14-781)	Feb-15

	Name	Function	Signature
Calibrated by:	Yu Zongying	SAR Test Engineer	
Reviewed by:	Qi Dianyuan	SAR Project Leader	
Approved by:	Lu Bingsong	Deputy Director of the laboratory	

Issued: March 12, 2014

This calibration certificate shall not be reproduced except in full without written approval of the laboratory.



In Collaboration with

**s p e a g**  
CALIBRATION LABORATORY

Add: No.52 Huayuanbei Road, Haidian District, Beijing, 100191, China  
Tel: +86-10-62304633-2079 Fax: +86-10-62304633-2504  
E-mail: Info@emcite.com Http://www.emcite.com

### Glossary:

TSL	tissue simulating liquid
NORM <sub>x,y,z</sub>	sensitivity in free space
ConvF	sensitivity in TSL / NORM <sub>x,y,z</sub>
DCP	diode compression point
CF	crest factor (1/duty_cycle) of the RF signal
A,B,C,D	modulation dependent linearization parameters
Polarization $\Phi$	$\Phi$ rotation around probe axis
Polarization $\theta$	$\theta$ rotation around an axis that is in the plane normal to probe axis (at measurement center), $\theta=0$ is normal to probe axis

Connector Angle information used in DASY system to align probe sensor X to the robot coordinate system

### Calibration is Performed According to the Following Standards:

- IEEE Std 1528-2013, "IEEE Recommended Practice for Determining the Peak Spatial-Averaged Specific Absorption Rate (SAR) in the Human Head from Wireless Communications Devices: Measurement Techniques", June 2013
- IEC 62209-1, "Procedure to measure the Specific Absorption Rate (SAR) for hand-held devices used in close proximity to the ear (frequency range of 300MHz to 3GHz)", February 2005

### Methods Applied and Interpretation of Parameters:

- NORM<sub>x,y,z</sub>**: Assessed for E-field polarization  $\theta=0$  ( $f \leq 900\text{MHz}$  in TEM-cell;  $f > 1800\text{MHz}$ : waveguide). NORM<sub>x,y,z</sub> are only intermediate values, i.e., the uncertainties of NORM<sub>x,y,z</sub> does not effect the  $E^2$ -field uncertainty inside TSL (see below ConvF).
- NORM(f)<sub>x,y,z</sub>** = NORM<sub>x,y,z</sub> \* frequency\_response (see Frequency Response Chart). This linearization is implemented in DASY4 software versions later than 4.2. The uncertainty of the frequency response is included in the stated uncertainty of ConvF.
- DCP<sub>x,y,z</sub>**: DCP are numerical linearization parameters assessed based on the data of power sweep (no uncertainty required). DCP does not depend on frequency nor media.
- PAR**: PAR is the Peak to Average Ratio that is not calibrated but determined based on the signal characteristics.
- A<sub>x,y,z</sub>; B<sub>x,y,z</sub>; C<sub>x,y,z</sub>; VR<sub>x,y,z</sub>; A,B,C** are numerical linearization parameters assessed based on the data of power sweep for specific modulation signal. The parameters do not depend on frequency nor media. VR is the maximum calibration range expressed in RMS voltage across the diode.
- ConvF and Boundary Effect Parameters**: Assessed in flat phantom using E-field (or Temperature Transfer Standard for  $f \leq 800\text{MHz}$ ) and inside waveguide using analytical field distributions based on power measurements for  $f > 800\text{MHz}$ . The same setups are used for assessment of the parameters applied for boundary compensation (alpha, depth) of which typical uncertainty valued are given. These parameters are used in DASY4 software to improve probe accuracy close to the boundary. The sensitivity in TSL corresponds to NORM<sub>x,y,z</sub>\* ConvF whereby the uncertainty corresponds to that given for ConvF. A frequency dependent ConvF is used in DASY version 4.4 and higher which allows extending the validity from  $\pm 50\text{MHz}$  to  $\pm 100\text{MHz}$ .
- Spherical isotropy (3D deviation from isotropy)**: in a field of low gradients realized using a flat phantom exposed by a patch antenna.
- Sensor Offset**: The sensor offset corresponds to the offset of virtual measurement center from the probe tip (on probe axis). No tolerance required.
- Connector Angle**: The angle is assessed using the information gained by determining the NORM<sub>x</sub> (no uncertainty required).



In Collaboration with

***s p e a g***

**CALIBRATION LABORATORY**

Add: No.52 Huayuanbei Road, Haidian District, Beijing, 100191, China

Tel: +86-10-62304633-2079

Fax: +86-10-62304633-2504

E-mail: [Info@emcite.com](mailto:Info@emcite.com)

[Http://www.emcite.com](http://www.emcite.com)

# Probe EX3DV4

## SN: 3661

Calibrated: March 10, 2014

Calibrated for DASY/EASY Systems

(Note: non-compatible with DASY2 system!)



In Collaboration with

**s p e a g**  
CALIBRATION LABORATORY

Add: No.52 Huayuanbei Road, Haidian District, Beijing, 100191, China

Tel: +86-10-62304633-2079

Fax: +86-10-62304633-2504

E-mail: Info@emcite.com

Http://www.emcite.com

## DASY – Parameters of Probe: EX3DV4 - SN: 3661

### Basic Calibration Parameters

	Sensor X	Sensor Y	Sensor Z	Unc (k=2)
Norm( $\mu\text{V}/(\text{V}/\text{m})^2$ ) <sup>A</sup>	0.45	0.49	0.47	±10.8%
DCP(mV) <sup>B</sup>	102.2	100.3	100.2	

### Modulation Calibration Parameters

UID	Communication System Name		A dB	B dB/μV	C	D dB	VR mV	Unc <sup>E</sup> (k=2)
0	CW	X	0.0	0.0	1.0	0.00	198.0	±2.0%
		Y	0.0	0.0	1.0		204.8	
		Z	0.0	0.0	1.0		200.9	

The reported uncertainty of measurement is stated as the standard uncertainty of Measurement multiplied by the coverage factor k=2, which for a normal distribution Corresponds to a coverage probability of approximately 95%.

<sup>A</sup> The uncertainties of Norm X, Y, Z do not affect the E<sup>2</sup>-field uncertainty inside TSL (see Page 5 and Page 6).

<sup>B</sup> Numerical linearization parameter; uncertainty not required.

<sup>E</sup> Uncertainty is determined using the max. deviation from linear response applying rectangular distribution and is expressed for the square of the field value.



In Collaboration with

**s p e a g**

**CALIBRATION LABORATORY**

Add: No.52 Huayuanbei Road, Haidian District, Beijing, 100191, China

Tel: +86-10-62304633-2079

Fax: +86-10-62304633-2504

E-mail: Info@emeite.com

Http://www.emeite.com

## DASY – Parameters of Probe: EX3DV4 - SN: 3661

### Calibration Parameter Determined in Head Tissue Simulating Media

f [MHz] <sup>C</sup>	Relative Permittivity <sup>F</sup>	Conductivity (S/m) <sup>F</sup>	ConvF X	ConvF Y	ConvF Z	Alpha <sup>G</sup>	Depth <sup>G</sup> (mm)	Unct. (k=2)
750	41.9	0.89	10.13	10.13	10.13	2.70	0.45	±12%
850	41.5	0.92	9.50	9.50	9.50	0.08	1.39	±12%
900	41.5	0.97	9.73	9.73	9.73	0.09	1.72	±12%
1750	40.1	1.37	8.29	8.29	8.29	0.18	1.38	±12%
1900	40.0	1.40	8.18	8.18	8.18	0.17	1.50	±12%
2000	40.0	1.40	8.21	8.21	8.21	0.14	1.68	±12%
2450	39.2	1.80	7.59	7.59	7.59	0.60	0.67	±12%
2600	39.0	1.96	7.38	7.38	7.38	0.58	0.67	±12%
5200	36.0	4.66	5.43	5.43	5.43	0.35	1.51	±13%
5300	35.9	4.76	5.27	5.27	5.27	0.37	1.07	±13%
5500	35.6	4.96	4.90	4.90	4.90	0.39	1.27	±13%
5600	35.5	5.07	4.67	4.67	4.67	0.43	1.26	±13%
5800	35.3	5.27	4.81	4.81	4.81	0.47	1.22	±13%

<sup>C</sup> Frequency validity of ±100MHz only applies for DASY v4.4 and higher (Page 2), else it is restricted to ±50MHz. The uncertainty is the RSS of ConvF uncertainty at calibration frequency and the uncertainty for the indicated frequency band.

<sup>F</sup> At frequency below 3 GHz, the validity of tissue parameters ( $\epsilon$  and  $\sigma$ ) can be relaxed to ±10% if liquid compensation formula is applied to measured SAR values. At frequencies above 3 GHz, the validity of tissue parameters ( $\epsilon$  and  $\sigma$ ) is restricted to ±5%. The uncertainty is the RSS of the ConvF uncertainty for indicated target tissue parameters.

<sup>G</sup> Alpha/Depth are determined during calibration. SPEAG warrants that the remaining deviation due to the boundary effect after compensation is always less than ± 1% for frequencies below 3 GHz and below ± 2% for the frequencies between 3-6 GHz at any distance larger than half the probe tip diameter from the boundary.



Add: No.52 Huayuanbei Road, Haidian District, Beijing, 100191, China  
 Tel: +86-10-62304633-2079 Fax: +86-10-62304633-2504  
 E-mail: Info@emccte.com Http://www.emccte.com

## DASY – Parameters of Probe: EX3DV4 - SN: 3661

### Calibration Parameter Determined in Body Tissue Simulating Media

f [MHz] <sup>C</sup>	Relative Permittivity <sup>F</sup>	Conductivity (S/m) <sup>F</sup>	ConvF X	ConvF Y	ConvF Z	Alpha <sup>G</sup>	Depth <sup>G</sup> (mm)	Unct. (k=2)
750	55.5	0.96	9.92	9.92	9.92	0.93	0.64	±12%
850	55.2	0.99	9.45	9.45	9.45	0.20	1.21	±12%
900	55.0	1.05	9.38	9.38	9.38	0.26	1.06	±12%
1750	53.4	1.49	8.06	8.06	8.06	0.13	1.83	±12%
1900	53.3	1.52	7.75	7.75	7.75	0.16	1.86	±12%
2000	53.3	1.52	8.01	8.01	8.01	0.15	2.85	±12%
2450	52.7	1.95	7.47	7.47	7.47	0.45	0.83	±12%
2600	52.5	2.16	7.15	7.15	7.15	0.66	0.66	±12%
5200	49.0	5.30	4.77	4.77	4.77	0.41	1.44	±13%
5300	48.9	5.42	4.52	4.52	4.52	0.43	1.59	±13%
5500	48.6	5.65	4.28	4.28	4.28	0.44	1.57	±13%
5600	48.5	5.77	4.21	4.21	4.21	0.45	1.57	±13%
5800	48.2	6.00	4.30	4.30	4.30	0.47	1.69	±13%

<sup>C</sup> Frequency validity of ±100MHz only applies for DASY v4.4 and higher (Page 2), else it is restricted to ±50MHz. The uncertainty is the RSS of ConvF uncertainty at calibration frequency and the uncertainty for the indicated frequency band.

<sup>F</sup> At frequency below 3 GHz, the validity of tissue parameters ( $\epsilon$  and  $\sigma$ ) can be relaxed to ±10% if liquid compensation formula is applied to measured SAR values. At frequencies above 3 GHz, the validity of tissue parameters ( $\epsilon$  and  $\sigma$ ) is restricted to ±5%. The uncertainty is the RSS of the ConvF uncertainty for indicated target tissue parameters.

<sup>G</sup> Alpha/Depth are determined during calibration. SPEAG warrants that the remaining deviation due to the boundary effect after compensation is always less than ± 1% for frequencies below 3 GHz and below ± 2% for the frequencies between 3-6 GHz at any distance larger than half the probe tip diameter from the boundary.





Add: No.52 Huayuanbei Road, Haidian District, Beijing, 100191, China  
Tel: +86-10-62304633-2079 Fax: +86-10-62304633-2504  
E-mail: Info@emcicc.com Http://www.emcicc.com

## Frequency Response of E-Field (TEM-Cell: ifi110 EXX, Waveguide: R22)

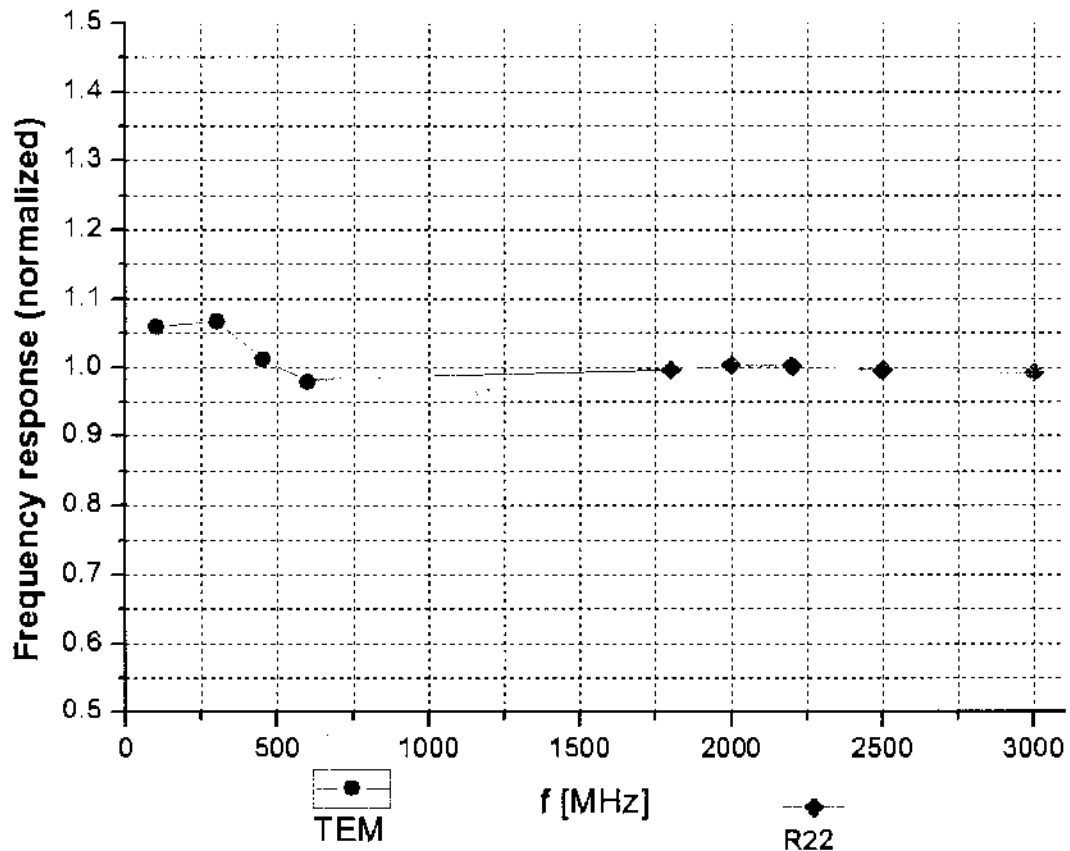

Uncertainty of Frequency Response of E-field:  $\pm 7.5\%$  ( $k=2$ )



In Collaboration with

**s p e a g**

**CALIBRATION LABORATORY**

Add: No.52 Huayuanbei Road, Haidian District, Beijing, 100191, China

Tel: +86-10-62304633-2079

Fax: +86-10-62304633-2504

E-mail: Info@emcite.com

Http://www.emcite.com

## Receiving Pattern ( $\Phi$ ), $\theta=0^\circ$

**f=600 MHz, TEM**

**f=1800 MHz, R22**

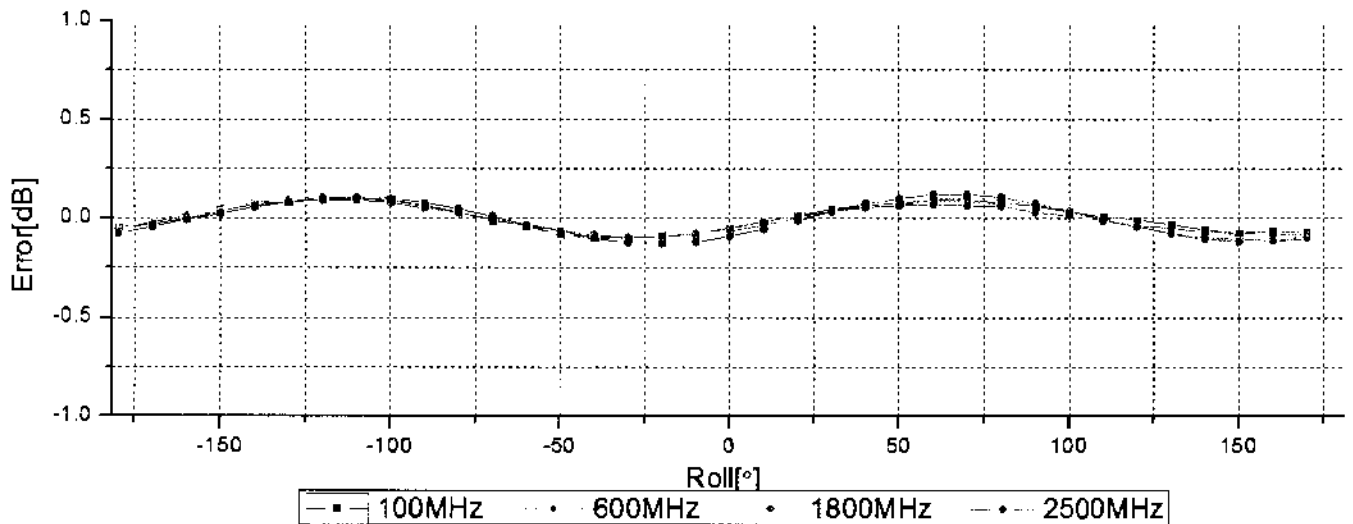
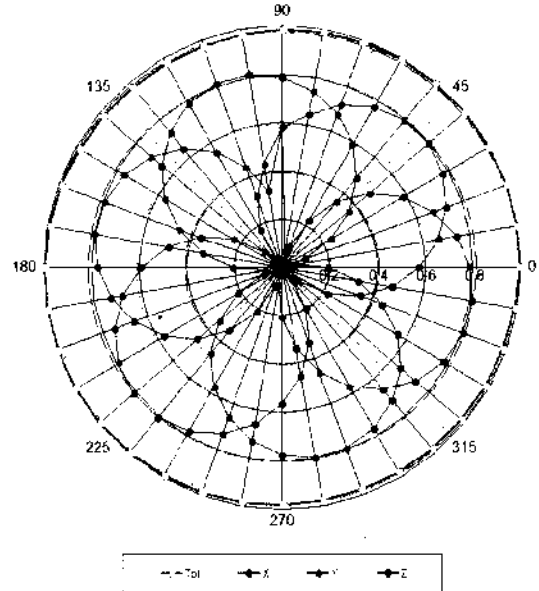
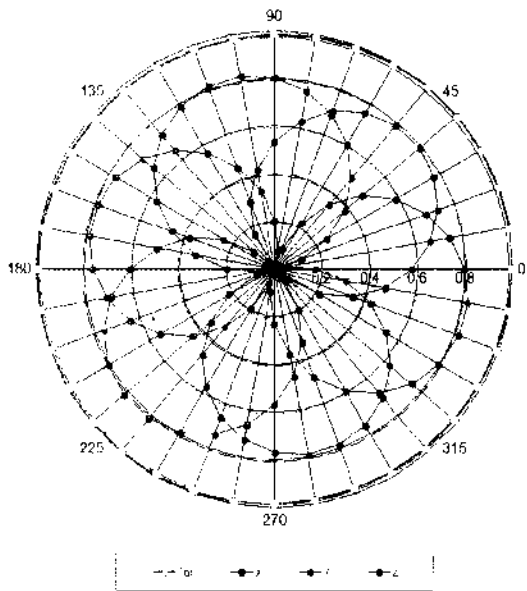

**Uncertainty of Axial Isotropy Assessment:  $\pm 0.9\%$  ( $k=2$ )**



Add: No.52 Huayuanbei Road, Haidian District, Beijing, 100191, China  
Tel: +86-10-62304633-2079 Fax: +86-10-62304633-2504  
E-mail: Info@emcite.com Http://www.emcite.com

### Dynamic Range f(SAR<sub>head</sub>) (TEM cell, f = 900 MHz)

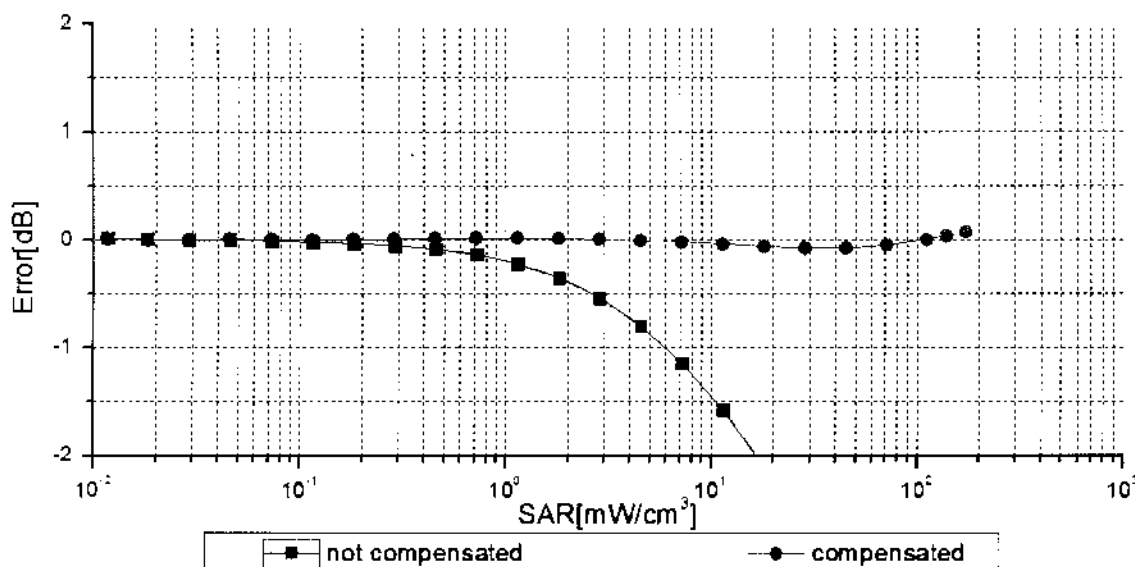
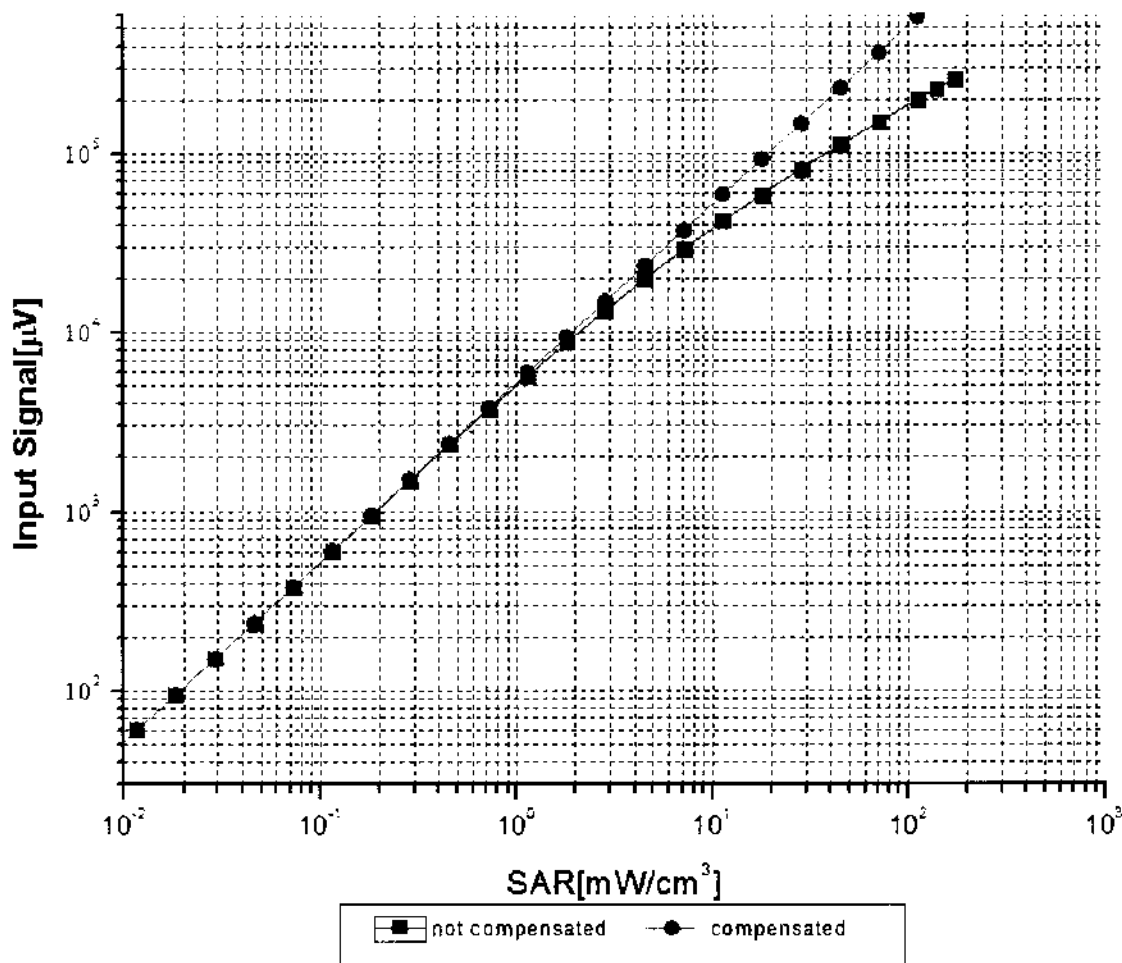

Uncertainty of Linearity Assessment: ±0.9% (k=2)

## Conversion Factor Assessment

f=900 MHz, WGLS R9(H\_convF)

f=2450 MHz, WGLS R26(H\_convF)

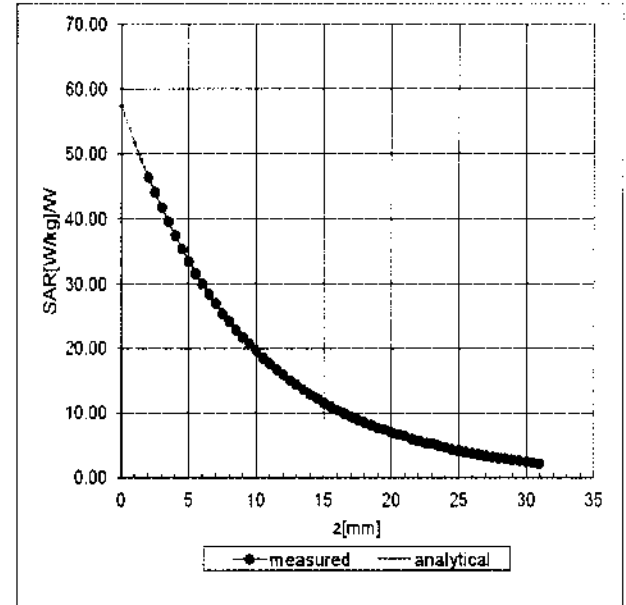
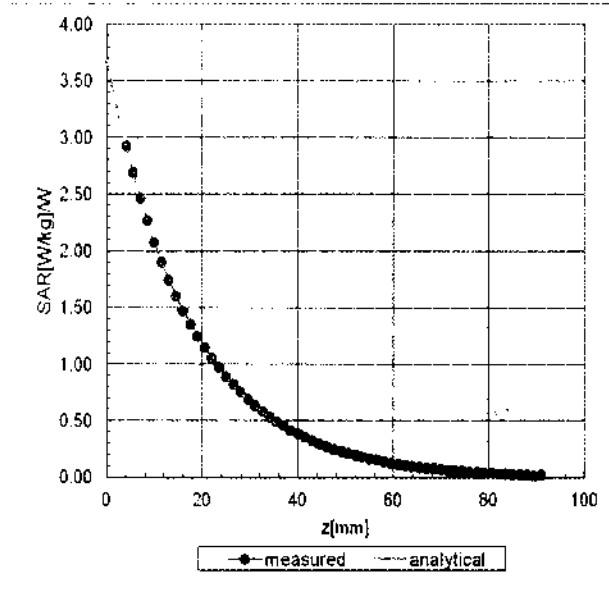

## Deviation from Isotropy in Liquid

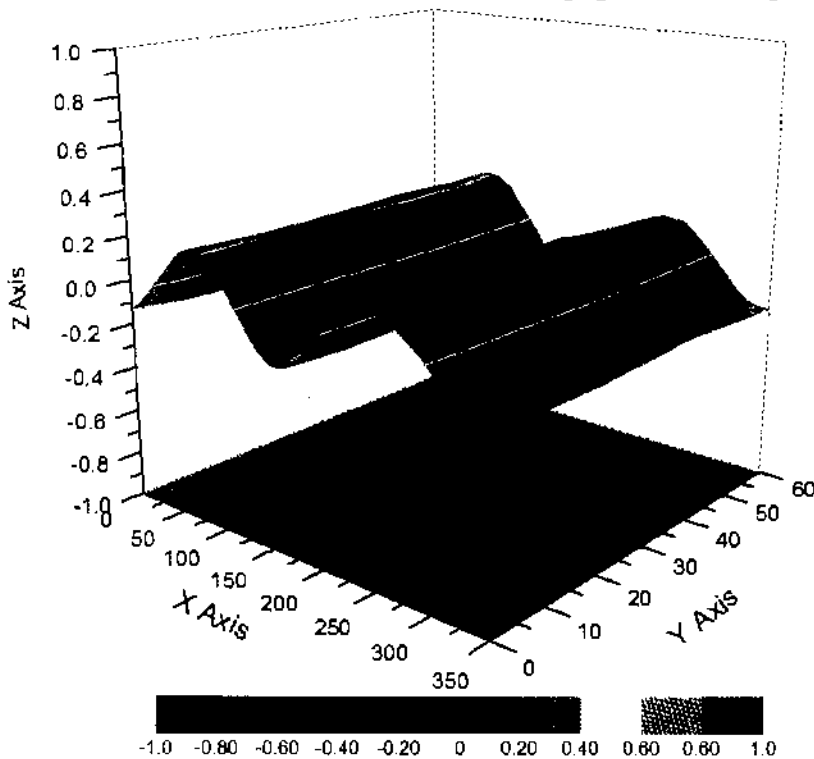

Uncertainty of Spherical Isotropy Assessment:  $\pm 2.8\%$  (K=2)



In Collaboration with

**s p e a g**

**CALIBRATION LABORATORY**

Add: No.52 Huayuanbei Road, Haidian District, Beijing, 100191, China

Tel: +86-10-62304633-2079

Fax: +86-10-62304633-2504

E-mail: [Info@emcite.com](mailto:Info@emcite.com)

[Http://www.emcite.com](http://www.emcite.com)

## DASY - Parameters of Probe: EX3DV4 - SN: 3661

### Other Probe Parameters

<b>Sensor Arrangement</b>	<b>Triangular</b>
<b>Connector Angle (°)</b>	<b>18.4</b>
<b>Mechanical Surface Detection Mode</b>	<b>enabled</b>
<b>Optical Surface Detection Mode</b>	<b>disable</b>
<b>Probe Overall Length</b>	<b>337mm</b>
<b>Probe Body Diameter</b>	<b>10mm</b>
<b>Tip Length</b>	<b>9mm</b>
<b>Tip Diameter</b>	<b>2.5mm</b>
<b>Probe Tip to Sensor X Calibration Point</b>	<b>1mm</b>
<b>Probe Tip to Sensor Y Calibration Point</b>	<b>1mm</b>
<b>Probe Tip to Sensor Z Calibration Point</b>	<b>1mm</b>
<b>Recommended Measurement Distance from Surface</b>	<b>2mm</b>

**Acceptable Conditions for SAR Measurements Using Probes and Dipoles  
Calibrated under the SPEAG-TMC Dual-Logo Calibration Program to  
Support FCC Equipment Certification**

The acceptable conditions for SAR measurements using probes, dipoles and DAEs calibrated by TMC (*Telecommunication Metrology Center of MITT in Beijing, China*), under the Dual-Logo Calibration Certificate program and quality assurance (QA) protocols established between SPEAG (*Schmid & Partner Engineering AG, Switzerland*) and TMC, to support FCC (*U.S. Federal Communications Commission*) equipment certification are defined and described in the following.

- 1) The agreement established between SPEAG and TMC is only applicable to calibration services performed by TMC where its clients (companies and divisions of such companies) are headquartered in the Greater China Region, including Taiwan and Hong Kong. This agreement is subject to renewal at the end of each calendar year between SPEAG and TMC. TMC shall inform the FCC of any changes or early termination to the agreement.
- 2) Only a subset of the calibration services specified in the SPEAG-TMC agreement, while it remains valid, are applicable to SAR measurements performed using such equipment for supporting FCC equipment certification. These are identified in the following.
  - a) Calibration of dosimetric (SAR) probes EX3DVx, ET3DVx and ES3DVx.
    - i) Free-space E-field and H-field probes, including those used for HAC (hearing aid compatibility) evaluation, temperature probes, other probes or equipment not identified in this document, when calibrated by TMC, are excluded and cannot be used for measurements to support FCC equipment certification.
    - ii) Signal specific and bundled probe calibrations based on PMR (probe modulation response) characteristics or other test signal based probe linearization methods not fully described in SAR standards are handled according to the requirements of KDB 865664; that is, "Until standardized procedures are available to make such determination, the applicability of a signal specific probe calibration for testing specific wireless modes and technologies is determined on a case-by-case basis through KDB inquiries, including SAR system verification requirements."
  - b) Calibration of SAR system validation dipoles, excluding HAC dipoles.
  - c) Calibration of data acquisition electronics DAE3Vx, DAE4Vx and DAEasyVx.
  - d) For FCC equipment certification purposes, the frequency range of SAR probe and dipole calibrations is limited to 700 MHz - 6 GHz and provided it is supported by the equipment identified in the TMC QA protocol (a separate attachment to this document).
  - e) The identical system and equipment setup, measurement configurations, hardware, evaluation algorithms, calibration and QA protocols, including the format of calibration certificates and reports used by SPEAG shall be applied by TMC. Equivalent test equipment and measurement configurations may be considered only when agreed by both SPEAG and the FCC.



- f) The calibrated items are only applicable to SPEAG DASY 4 and DASY 5 systems or higher version systems that satisfy the requirements of this KDB.
- 3) The SPEAG-TMC agreement includes specific protocols identified in the following to ensure the quality of calibration services provided by TMC under this SPEAG-TMC Dual-Logo calibration agreement are equivalent to the calibration services provided by SPEAG. TMC shall apply the required protocols without modification and, upon request, provide copies of documentation to the FCC to substantiate program implementation.
  - a) The Inter-laboratory Calibration Evaluation (ILCE) stated in the TMC QA protocol shall be performed between SPEAG and TMC at least once every 12 months. The ILCE acceptance criteria defined in the TMC QA protocol shall be satisfied for the TMC, SPEAG and FCC agreements to remain valid.
  - b) Check of Calibration Certificate (CCC) shall be performed by SPEAG for all calibrations performed by TMC. Written confirmation from SPEAG is required for TMC to issue calibration certificates under the SPEAG-TMC Dual-Logo calibration program. Quarterly reports for all calibrations performed by TMC under the program are also issued by SPEAG.
  - c) The calibration equipment and measurement system used by TMC shall be verified before each calibration service according to the specific reference SAR probes, dipoles, and DAE calibrated by SPEAG. The results shall be reproducible and within the defined acceptance criteria specified in the TMC QA protocol before each actual calibration can commence. TMC shall maintain records of the measurement and calibration system verification results for all calibrations.
  - d) Quality Check of Calibration (QCC) certificates shall be performed by SPEAG at least once every 12 months. SPEAG shall visit TMC facilities to verify the laboratory, equipment, applied procedures and plausibility of randomly selected certificates.
- 4) A copy of this document, to be updated annually, shall be provided to TMC clients that accept calibration services according to the SPEAG-TMC Dual-Logo calibration program, which should be presented to a TCB (*Telecommunication Certification Body*), to facilitate FCC equipment approval.
- 5) TMC shall address any questions raised by its clients or TCBs relating to the SPEAG-TMC Dual-Logo calibration program and inform the FCC and SPEAG of any critical issues.

Note: It is expected that TMC (*Telecommunication Metrology Center*) may change its name in 2014. For this KDB to remain valid, it must be updated by TMC before the name change occurs. The SPEAG-TMC Dual-Logo calibration certificate shall also be updated accordingly to reflect the change.



**Appendix E. Product Equality Declaration**

## **Lenovo (Shanghai) Electronics Technology Co., Ltd.**

No. 68 Building, 199 Fenju Road, Wai Gao Qiao FTZ , Shanghai , China

Tel: 86-21-50504500-8237

**Date: November 18, 2014**

### **Product Equality Declaration**

We, Lenovo (Shanghai) Electronics Technology Co., Ltd., declare on our sole responsibility for product of Lenovo A3300-HV that the difference between the present product and the original product is only different supplier for LCD Panel.

Should you have any questions or comments regarding this matter, please have my best attention.

Declared by : *Li Wei*

on behalf of Lenovo (Shanghai) Electronics Technology Co., Ltd.