

FCC RF Test Report

APPLICANT : Lenovo (Shanghai) Electronics Technology Co., Ltd.
EQUIPMENT : Portable Tablet Computer
BRAND NAME : lenovo
MODEL NAME : Lenovo A3300-HV
MARKETING NAME : Lenovo A3300-HV
FCC ID : O57A3300HV
STANDARD : FCC Part 15 Subpart C §15.247
CLASSIFICATION : (DTS) Digital Transmission System

The product was testing completed on May 26, 2014. We, SPORTON INTERNATIONAL (SHENZHEN) INC., would like to declare that the tested sample has been evaluated in accordance with the test procedures and has been in compliance with the applicable technical standards.

The test results in this report apply exclusively to the tested model / sample. Without written approval of SPORTON INTERNATIONAL (SHENZHEN) INC., the test report shall not be reproduced except in full.



Reviewed by: Joseph Lin / Supervisor



Approved by: Jones Tsai / Manager



SPORTON INTERNATIONAL (SHENZHEN) INC.

No. 3 Building, the third floor of south, Shahe River west, Fengzeyuan warehouse, Nanshan District, Shenzhen, Guangdong, P.R.C.



TABLE OF CONTENTS

REVISION HISTORY..... 3

SUMMARY OF TEST RESULT 4

1 GENERAL DESCRIPTION..... 5

 1.1 Applicant 5

 1.2 Manufacturer..... 5

 1.3 Feature of Equipment Under Test 5

 1.4 Product Specification of Equipment Under Test..... 5

 1.5 Modification of EUT 6

 1.6 Testing Location 6

 1.7 Applicable Standards..... 6

2 TEST CONFIGURATION OF EQUIPMENT UNDER TEST..... 7

 2.1 Descriptions of Test Mode 7

 2.2 Test Mode..... 8

 2.3 Connection Diagram of Test System..... 9

 2.4 Support Unit used in test configuration and system 10

 2.5 EUT Operation Test Setup 10

 2.6 Measurement Results Explanation Example..... 10

3 TEST RESULT 11

 3.1 6dB Bandwidth Measurement 11

 3.2 Peak Output Power Measurement 14

 3.3 Power Spectral Density Measurement 16

 3.4 Conducted Band Edges and Spurious Emission Measurement 22

 3.5 Radiated Band Edges and Spurious Emission Measurement 31

 3.6 AC Conducted Emission Measurement..... 40

 3.7 Antenna Requirements..... 44

4 LIST OF MEASURING EQUIPMENT..... 45

5 UNCERTAINTY OF EVALUATION..... 46

APPENDIX A. SETUP PHOTOGRAPHS

SUMMARY OF TEST RESULT

| Report Section | FCC Rule | Description | Limit | Result | Remark |
|----------------|--------------------|--|-----------------------|--------|---|
| 3.1 | 15.247(a)(2) | 6dB Bandwidth | $\geq 0.5\text{MHz}$ | Pass | - |
| 3.2 | 15.247(b)(1) | Peak Output Power | $\leq 30\text{dBm}$ | Pass | - |
| 3.3 | 15.247(e) | Power Spectral Density | $\leq 8\text{dBm}$ | Pass | - |
| 3.4 | 15.247(d) | Conducted Band Edges and Spurious Emission | $\leq 20\text{dBc}$ | Pass | - |
| 3.5 | 15.247(d) | Radiated Band Edges and Spurious Emission | 15.209(a) & 15.247(d) | Pass | Under limit 6.33 dB at 40.670 MHz |
| 3.6 | 15.207 | AC Conducted Emission | 15.207(a) | Pass | Under limit 12.89 dB at 4.550 MHz |
| 3.7 | 15.203 & 15.247(b) | Antenna Requirement | N/A | Pass | - |

1 General Description

1.1 Applicant

Lenovo (Shanghai) Electronics Technology Co., Ltd.

No. 68 Building, 199 Fenju Road, Wai Gao Qiao FTZ, Shanghai, China

1.2 Manufacturer

Lenovo PC HK Limited

23/F, Lincoln House, Taikoo Place 979 King's Road, Quarry Bay, Hong Kong

1.3 Feature of Equipment Under Test

| Product Feature | |
|--|---|
| Equipment | Portable Tablet Computer |
| Brand Name | lenovo |
| Model Name | Lenovo A3300-HV |
| Marketing Name | Lenovo A3300-HV |
| FCC ID | O57A3300HV |
| EUT supports Radios application | GSM/GPRS/EGPRS/WCDMA/HSPA/HSPA+(Downlink Only) WLAN2.4GHz 802.11b/g/n HT20/HT40 Bluetooth v3.0+EDR Bluetooth v4.0 LE |
| HW Version | A977_MB_PCB_V4.0 |
| SW Version | A3300HV_A442_01_06_140505_ROW_ENG |
| EUT Stage | Pre-Production |

Remark: The above EUT's information was declared by manufacturer. Please refer to the specifications or user's manual for more detailed description.

1.4 Product Specification of Equipment Under Test

| Product Specification subjective to this standard | |
|---|--|
| Tx/Rx Frequency Range | 2402 MHz ~ 2480 MHz |
| Number of Channels | 40 |
| Carrier Frequency of Each Channel | 40 Channel(37 hopping + 3 advertising channel) |
| Maximum Output Power to Antenna | -3.04 dBm (0.0005 W) |
| Antenna Type | PIFA Antenna with gain -2.88 dBi |
| Type of Modulation | GFSK |

1.5 Modification of EUT

No modifications are made to the EUT during all test items.

1.6 Testing Location

| | | | | |
|---------------------------|--|-----------|---------|-----------------------------|
| Test Site | SPORTON INTERNATIONAL (SHENZHEN) INC. | | | |
| Test Site Location | No. 3 Building, the third floor of south, Shahe River west, Fengzeyuan warehouse, Nanshan District, Shenzhen, Guangdong, P.R.C. TEL: +86-755- 3320-2398 | | | |
| Test Site No. | Sporton Site No. | | | FCC Registration No. |
| | TH01-SZ | 03CH01-SZ | CO01-SZ | 831040 |

Note: The test site complies with ANSI C63.4 2003 requirement.

1.7 Applicable Standards

According to the specifications of the manufacturer, the EUT must comply with the requirements of the following standards:

- ♦ FCC Part 15 Subpart C §15.247
- ♦ FCC KDB Publication No. 558074 D01 DTS Meas. Guidance v03r01
- ♦ ANSI C63.4-2003

Remark:

1. All test items were verified and recorded according to the standards and without any deviation during the test.
2. This EUT has also been tested and complied with the requirements of FCC Part 15, Subpart B, recorded in a separate test report.

2 Test Configuration of Equipment Under Test

2.1 Descriptions of Test Mode

The RF output power was recorded in the following table:

| Channel | Frequency | Bluetooth 4.0 LE RF Output Power | |
|---------|-----------|----------------------------------|--|
| | | Data Rate / Modulation | |
| | | GFSK | |
| | | 1Mbps | |
| Ch00 | 2402MHz | -3.08 dBm | |
| Ch19 | 2440MHz | -3.05 dBm | |
| Ch39 | 2480MHz | -3.04 dBm | |

- a. The EUT has been associated with peripherals and configuration operated in a manner tended to maximize its emission characteristics in a typical application. Frequency range investigated: conduction (150 kHz to 30 MHz), radiation (9 kHz to the 10th harmonic of the highest fundamental frequency or to 40 GHz, whichever is lower). Pre-scanned tests, X, Y, Z in three orthogonal panels to determine the final configuration (Z plane as worst plane) from all possible combinations.
- b. AC power line Conducted Emission was tested under maximum output power.

2.2 Test Mode

The following summary table is showing all test modes to demonstrate in compliance with the standard.

| Summary table of Test Cases | |
|---|--|
| Test Item | Data Rate / Modulation |
| | Bluetooth 4.0 LE / GFSK |
| Conducted TCs | Mode 1: Bluetooth Tx CH00_2402 MHz_1Mbps Mode 2: Bluetooth Tx CH19_2440 MHz_1Mbps Mode 3: Bluetooth Tx CH39_2480 MHz_1Mbps |
| Radiated TCs | Mode 1: Bluetooth Tx CH00_2402 MHz_1Mbps Mode 2: Bluetooth Tx CH19_2440 MHz_1Mbps Mode 3: Bluetooth Tx CH39_2480 MHz_1Mbps |
| AC Conducted Emission | Mode 1: GSM850 Idle + Bluetooth Link + WLAN Link + USB Cable (Charging from Adapter) + Earphone for Sample 1 Mode 2: GSM850 Idle + Bluetooth Link + WLAN Link + USB Cable (Charging from Adapter) + Earphone for Sample 2 |
| Remark: | |
| <ol style="list-style-type: none"> The worst case of conducted emission is mode 1; only the test data of it was reported. For Radiated TCs, The tests were performance with Adapter, Earphone, and USB Cable. | |

2.3 Connection Diagram of Test System

<Bluetooth 4.0 LE Tx Mode>

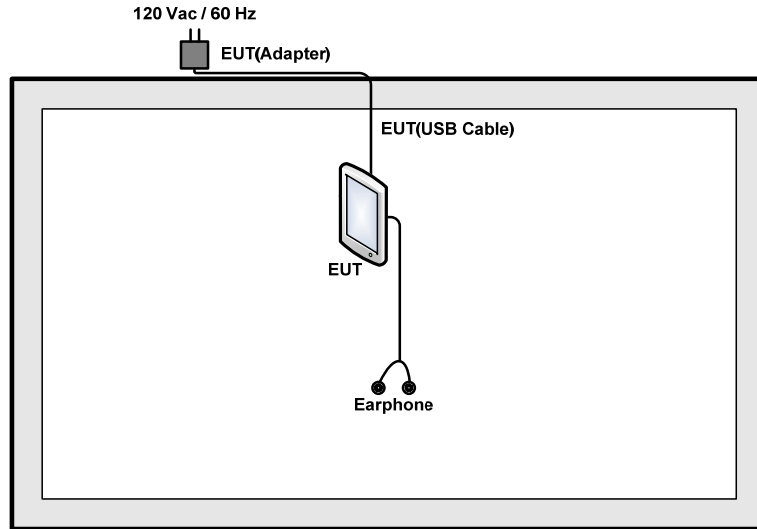

<AC Conducted Emission Mode>

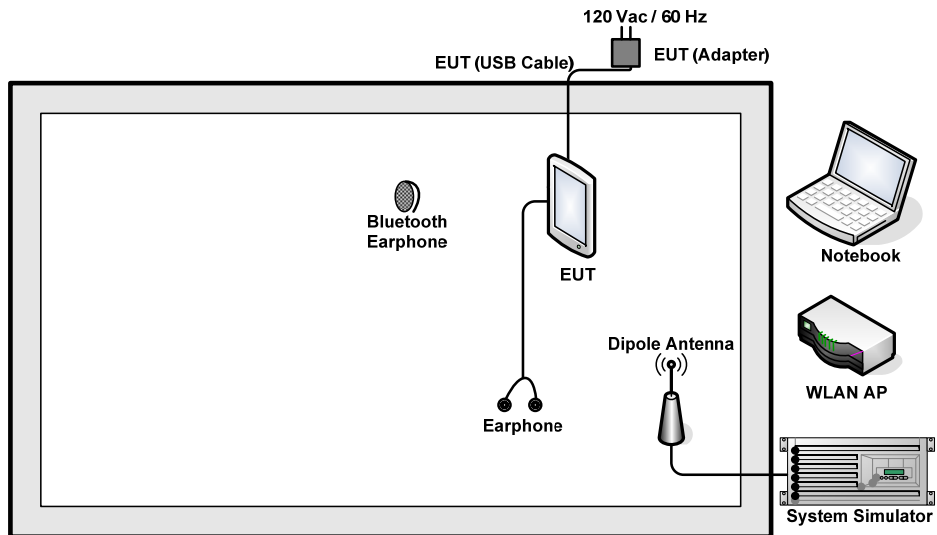

2.4 Support Unit used in test configuration and system

| Item | Equipment | Trade Name | Model Name | FCC ID | Data Cable | Power Cord |
|------|--------------------|------------|------------|-------------|-------------------|--|
| 1. | System Simulator | Anritsu | MT8820C | N/A | N/A | Unshielded, 1.8 m |
| 2. | WLAN AP | D-Link | DIR-628 | KA2DIR628A2 | N/A | Unshielded, 1.8 m |
| 3. | Notebook | Lenovo | G480 | FCC DoC | N/A | AC I/P: Unshielded, 1.2 m DC O/P: Shielded, 1.8 m |
| 4. | Bluetooth Earphone | Nokia | BH-108 | PYAHS-107W | N/A | N/A |
| 5. | Earphone | Lenovo | SH100 | FCC DoC | Unshielded, 1.6 m | N/A |

2.5 EUT Operation Test Setup

For Bluetooth v4.0 LE function, the engineering test program was provided and enabled to make EUT continuous transmit/receive.

For AC power line conducted emissions, the EUT was set to connect with the WLAN AP under large package sizes transmission.

2.6 Measurement Results Explanation Example

For all conducted test items:

The offset level is set in the spectrum analyzer to compensate the RF cable loss and attenuator factor between EUT conducted output port and spectrum analyzer. With the offset compensation, the spectrum analyzer reading level is exactly the EUT RF output level.

Example :

The spectrum analyzer offset is derived from RF cable loss and attenuator factor.

Offset = RF cable loss + attenuator factor.

Following shows an offset computation example with cable loss 7.5 dB and 10dB attenuator.

$$\begin{aligned} \text{Offset(dB)} &= \text{RF cable loss(dB)} + \text{attenuator factor(dB)}. \\ &= 7.5 + 10 = 17.5 \text{ (dB)} \end{aligned}$$

3 Test Result

3.1 6dB Bandwidth Measurement

3.1.1 Limit of 6dB Bandwidth

The minimum 6 dB bandwidth shall be at least 500 kHz.

3.1.2 Measuring Instruments

The section 4.0 of List of Measuring Equipment of this test report is used for test.

3.1.3 Test Procedures

1. The testing follows FCC KDB Publication No. 558074 D01 DTS Meas. Guidance v03r01.
2. The RF output of EUT was connected to the spectrum analyzer by RF cable and attenuator. The path loss was compensated to the results for each measurement.
3. Set to the maximum power setting and enable the EUT transmit continuously.
4. Make the measurement with the spectrum analyzer's resolution bandwidth (RBW) = 100 kHz. Set the Video bandwidth (VBW) = 300 kHz. In order to make an accurate measurement. The 6 dB bandwidth must be greater than 500 kHz.
5. Measure and record the results in the test report.

3.1.4 Test Setup

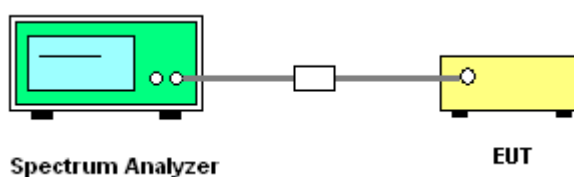

3.1.5 Test Result of 6dB Bandwidth

| | | | |
|-----------------|------------------|---------------------|---------|
| Test Mode : | Bluetooth 4.0 LE | Temperature : | 24~26°C |
| Test Engineer : | Blithe Li | Relative Humidity : | 50~53% |

| Channel | Frequency (MHz) | 6dB Bandwidth (MHz) | 6dB Bandwidth Min. Limit (MHz) | Pass/Fail |
|---------|-----------------|---------------------|--------------------------------|-----------|
| 00 | 2402 | 0.688 MHz | 0.5 | Pass |
| 19 | 2440 | 0.700 MHz | 0.5 | Pass |
| 39 | 2480 | 0.700 MHz | 0.5 | Pass |

6 dB Bandwidth Plot on Channel 00

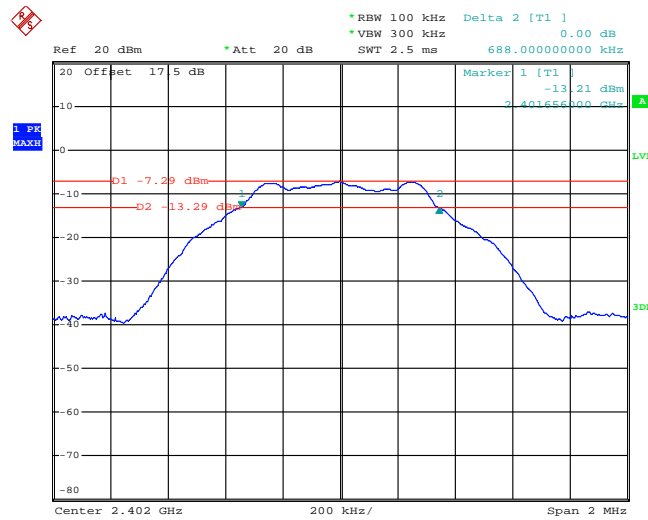

Date: 23.MAY.2014 11:41:37



6 dB Bandwidth Plot on Channel 19

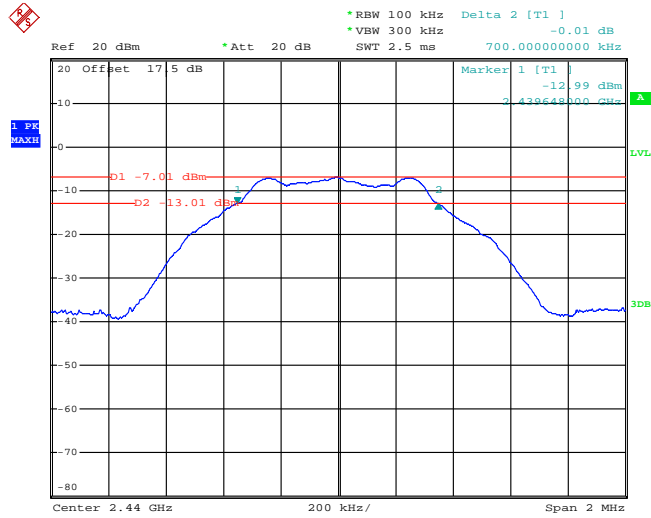

Date: 23.MAY.2014 11:48:53

6 dB Bandwidth Plot on Channel 39

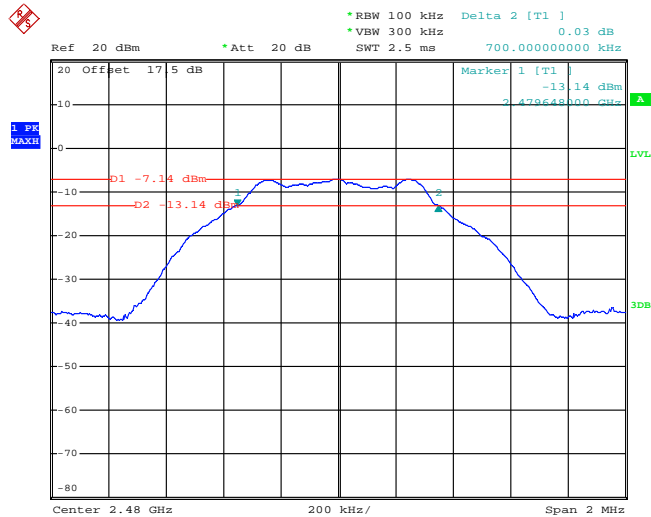

Date: 23.MAY.2014 11:53:13

3.2 Peak Output Power Measurement

3.2.1 Limit of Peak Output Power

For systems using digital modulation in the 2400-2483.5MHz, the limit for peak output power is 30dBm. If transmitting antenna of directional gain greater than 6dBi is used, the peak output power from the intentional radiator shall be reduced below the above stated value by the amount in dB that the directional gain of the antenna exceeds 6 dBi. In case of point-to-point operation, the limit has to be reduced by 1dB for every 3dB that the directional gain of the antenna exceeds 6dBi.

3.2.2 Measuring Instruments

The section 4.0 of List of Measuring Equipment of this test report is used for test.

3.2.3 Test Procedures

1. The testing follows the Measurement Procedure of FCC KDB No. 558074 DTS D01 Meas. Guidance v03r01.
2. The RF output of EUT was connected to the power meter by RF cable and attenuator. The path loss was compensated to the results for each measurement.
3. Set to the maximum power setting and enable the EUT transmit continuously.
4. Measure the conducted output power and record the results in the test report.

3.2.4 Test Setup

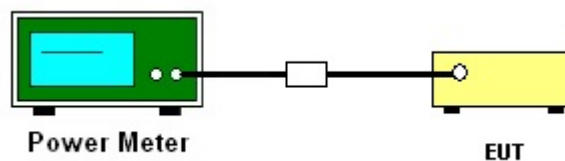



3.2.5 Test Result of Peak Output Power

| | | | |
|-----------------|------------------|---------------------|---------|
| Test Mode : | Bluetooth 4.0 LE | Temperature : | 24~26°C |
| Test Engineer : | Blithe Li | Relative Humidity : | 50~53% |

| Channel | Frequency (MHz) | RF Power (dBm) | | |
|---------|-----------------|----------------|-------------------|-----------|
| | | GFSK | Max. Limits (dBm) | Pass/Fail |
| | | 1 Mbps | | |
| 00 | 2402 | -3.08 | 30.00 | Pass |
| 19 | 2440 | -3.05 | 30.00 | Pass |
| 39 | 2480 | -3.04 | 30.00 | Pass |

3.3 Power Spectral Density Measurement

3.3.1 Limit of Power Spectral Density

The peak power spectral density shall not be greater than 8dBm in any 3kHz band at any time interval of continuous transmission.

3.3.2 Measuring Instruments

The section 4.0 of List of Measuring Equipment of this test report is used for test.

3.3.3 Test Procedures

1. The testing follows Measurement Procedure 10.2 Method PKPSD of FCC KDB Publication No. 558074 D01 DTS Meas. Guidance v03r01
2. The RF output of EUT was connected to the spectrum analyzer by RF cable and attenuator. The path loss was compensated to the results for each measurement.
3. Set to the maximum power setting and enable the EUT transmit continuously.
4. Make the measurement with the spectrum analyzer's resolution bandwidth (RBW) = 3 kHz. Video bandwidth VBW = 10 kHz In order to make an accurate measurement, set the span to 1.5 times DTS Channel Bandwidth. (6dB BW)
5. Detector = peak, Sweep time = auto couple, Trace mode = max hold, Allow trace to fully stabilize. Use the peak marker function to determine the maximum power level.
6. Measure and record the results in the test report.
7. The Measured power density (dBm)/ 100kHz is a reference level and used as 20dBc down limit line for Conducted Band Edges and Conducted Spurious Emission.

3.3.4 Test Setup

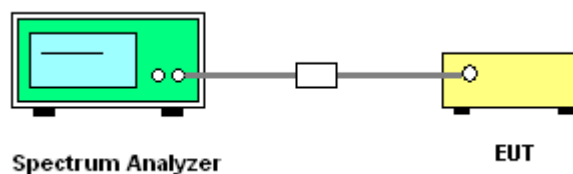

3.3.5 Test Result of Power Spectral Density

| | | | |
|------------------------|------------------|----------------------------|---------|
| Test Mode : | Bluetooth 4.0 LE | Temperature : | 24~26°C |
| Test Engineer : | Blithe Li | Relative Humidity : | 50~53% |

| Channel | Frequency (MHz) | Power Density | | Max. Limits (dBm/3kHz) | Pass/Fail |
|---------|-----------------|------------------|----------------|------------------------|-----------|
| | | PSD/100kHz (dBm) | PSD/3kHz (dBm) | | |
| 00 | 2402 | -7.33 | -21.79 | 8 | Pass |
| 19 | 2440 | -7.03 | -21.50 | 8 | Pass |
| 39 | 2480 | -7.13 | -21.61 | 8 | Pass |

Note:

1. Measured power density (dBm) has offset with cable loss.
2. The Measured power density (dBm)/ 100kHz is reference level and used as 20dBc down for Conducted Band Edges and Conducted Spurious Emission limit line.



3.3.6 Test Result of Power Spectral Density Plots (100kHz)

PSD 100kHz Plot on Channel 00

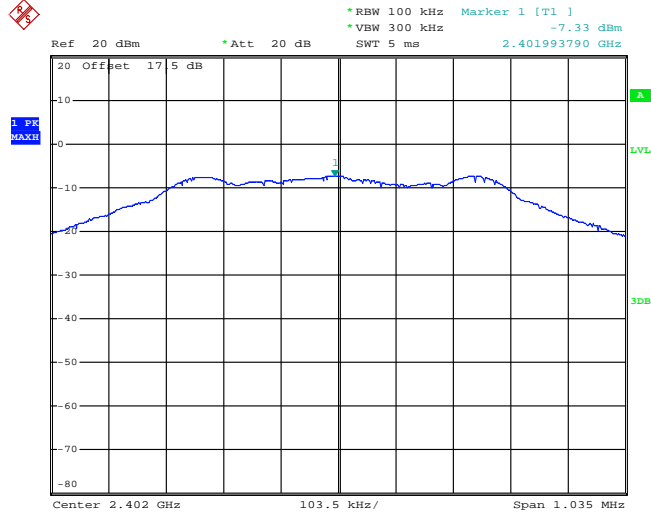

Date: 23.MAY.2014 11:42:06



3.3.7 Test Result of Power Spectral Density Plots (3kHz)

PSD 3kHz Plot on Channel 00

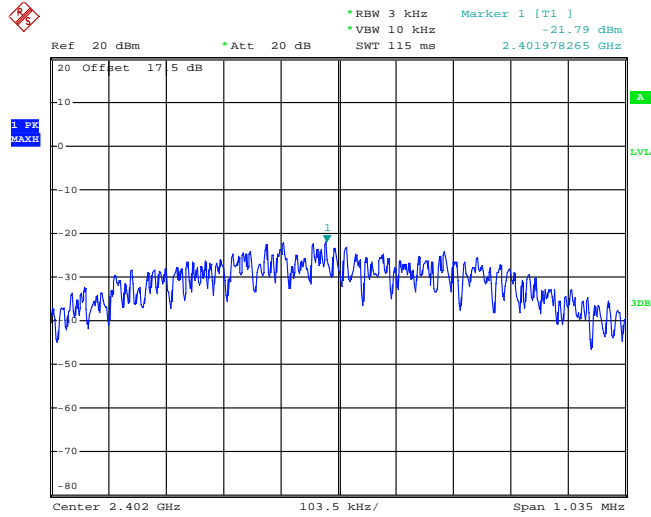

Date: 23.MAY.2014 11:41:57



PSD 3kHz Plot on Channel 19

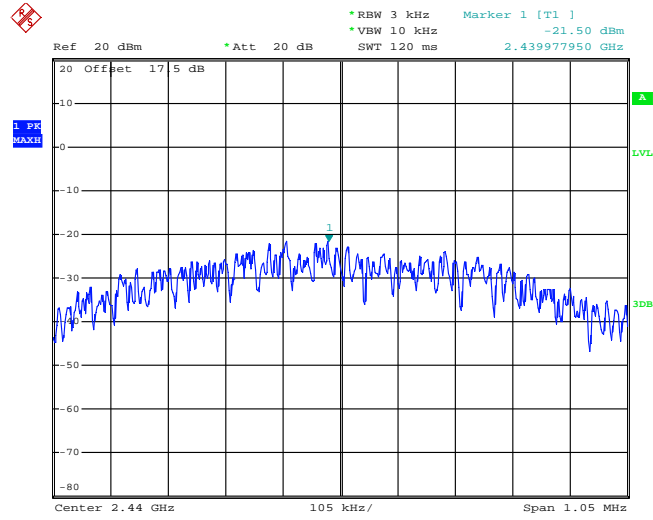

Date: 23.MAY.2014 11:49:13

PSD 3kHz Plot on Channel 39

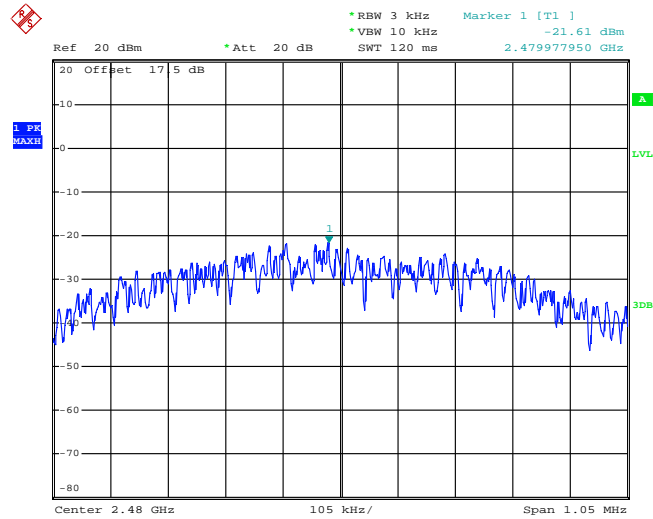

Date: 23.MAY.2014 11:53:33

3.4 Conducted Band Edges and Spurious Emission Measurement

3.4.1 Limit of Conducted Band Edges and Spurious Emission

All harmonics/spurious must be at least 20 dB down from the highest emission level within the authorized band.

3.4.2 Measuring Instruments

The section 4.0 of List of Measuring Equipment of this test report is used for test.

3.4.3 Test Procedure

1. The testing follows FCC KDB Publication No. 558074 D01 DTS Meas. Guidance v03r01.
2. The RF output of EUT was connected to the spectrum analyzer by RF cable and attenuator. The path loss was compensated to the results for each measurement.
3. Set to the maximum power setting and enable the EUT transmit continuously.
4. Set RBW = 100 kHz, VBW=300 kHz, Peak Detector. Unwanted Emissions measured in any 100 kHz bandwidth outside of the authorized frequency band shall be attenuated by at least 20 dB relative to the maximum in-band peak PSD level in 100 kHz when maximum peak conducted output power procedure is used. If the transmitter complies with the conducted power limits based on the use of RMS averaging over a time interval, the attenuation required under this paragraph shall be 30 dB instead of 20 dB per 15.247(d).
5. Measure and record the results in the test report.
6. The RF fundamental frequency should be excluded against the limit line in the operating frequency band.

3.4.4 Test Setup

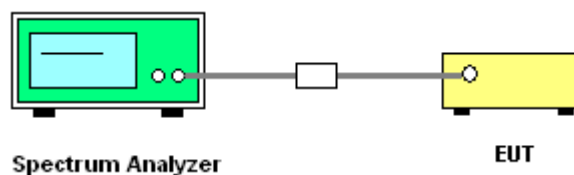



3.4.5 Test Result of Conducted Band Edges

| | | | |
|----------------|------------------|---------------------|-----------|
| Test Mode : | Bluetooth 4.0 LE | Temperature : | 24~26°C |
| Test Channel : | 00 and 39 | Relative Humidity : | 50~53% |
| | | Test Engineer : | Blithe Li |

Low Band Edge Plot on Channel 00

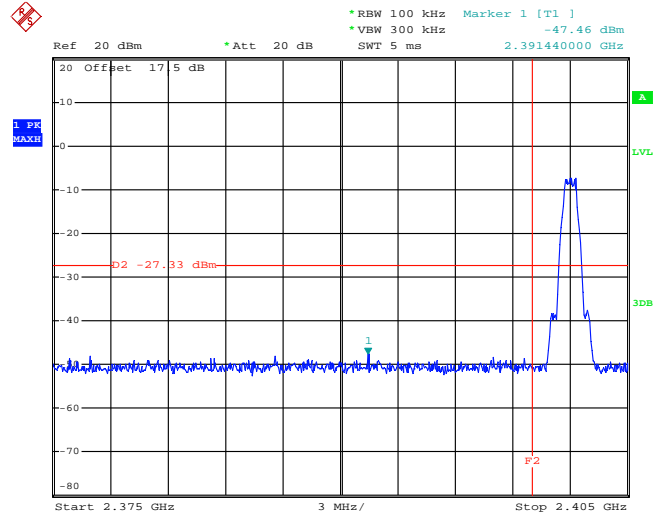

Date: 23.MAY.2014 11:42:20



High Band Edge Plot on Channel 39

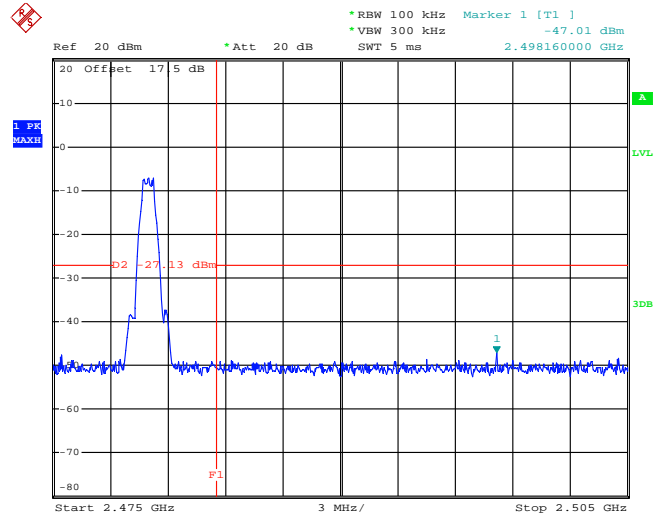

Date: 23.MAY.2014 11:53:56



3.4.6 Test Result of Conducted Spurious Emission

| | | | |
|----------------|------------------|---------------------|-----------|
| Test Mode : | Bluetooth 4.0 LE | Temperature : | 24~26°C |
| Test Channel : | 00 | Relative Humidity : | 50~53% |
| | | Test Engineer : | Blithe Li |

Conducted Spurious Emission Plot on Bluetooth LE 1Mbps
GFSK Channel 00

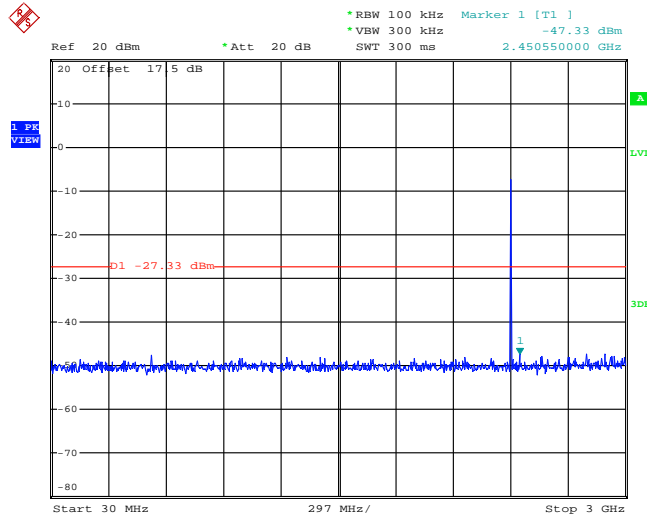

Date: 23.MAY.2014 11:42:39



Conducted Spurious Emission Plot on Bluetooth LE 1Mbps GFSK Channel 00

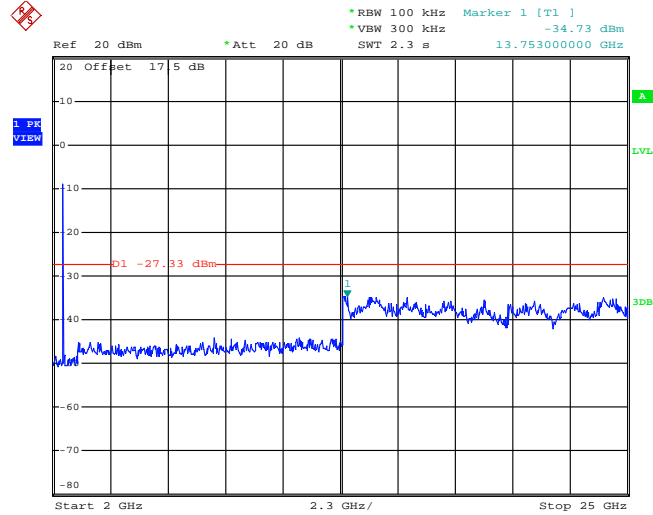

Date: 23.MAY.2014 11:42:58



| | | | |
|----------------|------------------|---------------------|-----------|
| Test Mode : | Bluetooth 4.0 LE | Temperature : | 24~26°C |
| Test Channel : | 19 | Relative Humidity : | 50~53% |
| | | Test Engineer : | Blithe Li |

Conducted Spurious Emission Plot on Bluetooth LE 1Mbps
GFSK Channel 19

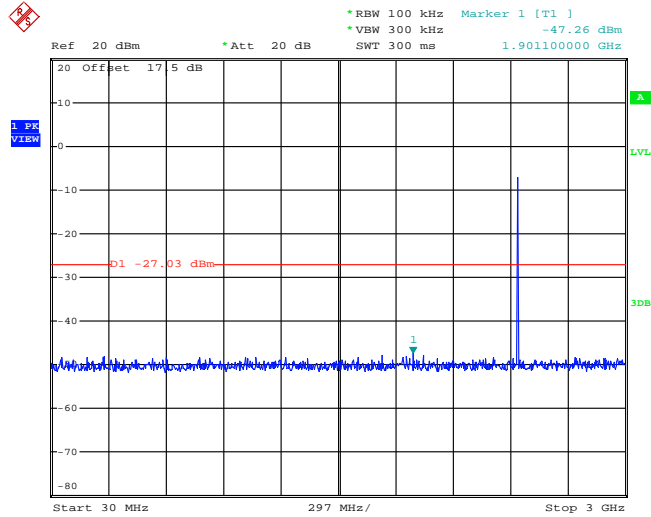

Date: 23.MAY.2014 11:49:42



Conducted Spurious Emission Plot on Bluetooth LE 1Mbps GFSK Channel 19

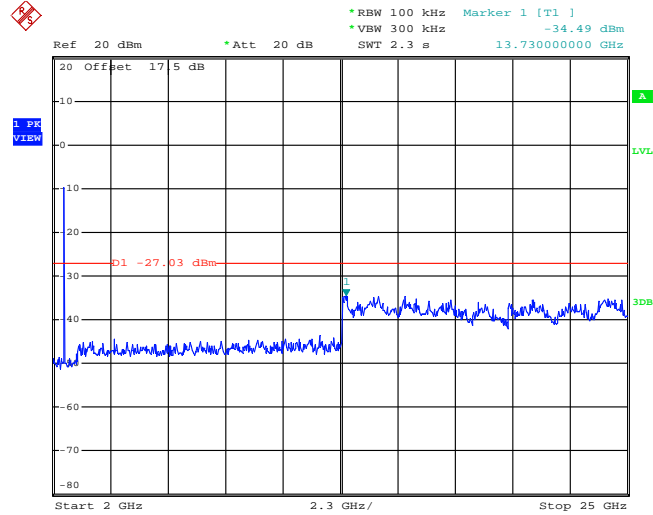

Date: 23.MAY.2014 11:50:00



| | | | |
|----------------|------------------|---------------------|-----------|
| Test Mode : | Bluetooth 4.0 LE | Temperature : | 24~26°C |
| Test Channel : | 39 | Relative Humidity : | 50~53% |
| | | Test Engineer : | Blithe Li |

Conducted Spurious Emission Plot on Bluetooth LE 1Mbps
GFSK Channel 39

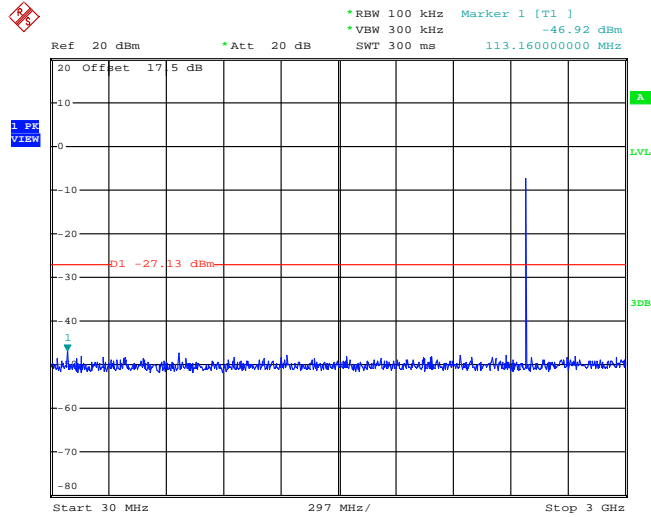

Date: 23.MAY.2014 11:54:15



Conducted Spurious Emission Plot on Bluetooth LE 1Mbps GFSK Channel 39

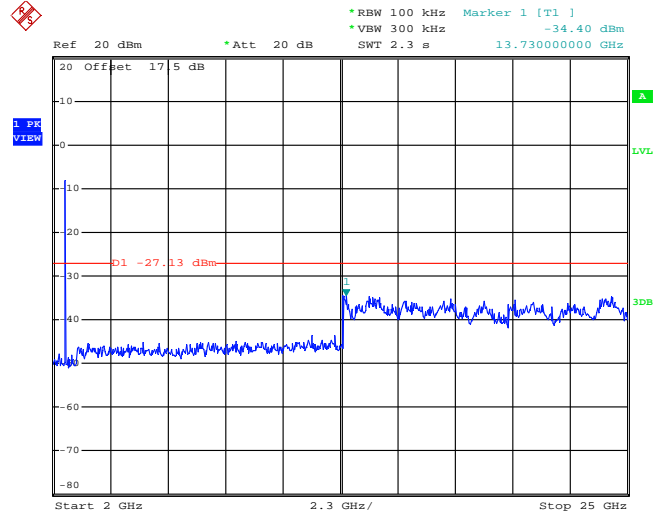

Date: 23.MAY.2014 11:54:34

3.5 Radiated Band Edges and Spurious Emission Measurement

3.5.1 Limit of Radiated Band Edges and Spurious Emission

In any 100 kHz bandwidth outside the intentional radiator frequency band, all harmonics/spurious must be at least 20 dB below the highest emission level within the authorized band. If the output power of this device was measured by spectrum analyzer, the attenuation under this paragraph shall be 30 dB instead of 20 dB. In addition, radiated emissions which fall in the restricted bands must also comply with the FCC section 15.209 limits as below.

| Frequency (MHz) | Field Strength (microvolts/meter) | Measurement Distance (meters) |
|-----------------|-----------------------------------|-------------------------------|
| 0.009 – 0.490 | 2400/F(kHz) | 300 |
| 0.490 – 1.705 | 24000/F(kHz) | 30 |
| 1.705 – 30.0 | 30 | 30 |
| 30 – 88 | 100 | 3 |
| 88 – 216 | 150 | 3 |
| 216 - 960 | 200 | 3 |
| Above 960 | 500 | 3 |

3.5.2 Measuring Instruments

The section 4.0 of List of Measuring Equipment of this test report is used for test.

3.5.3 Test Procedures

1. The testing follows FCC KDB Publication No. 558074 D01 DTS Meas. Guidance v03r01.
2. The EUT was arranged to its worst case and then tune the antenna tower (from 1 m to 4 m) and turntable (from 0 degree to 360 degrees) to find the maximum reading. A pre-amp and a high pass filter are used for the test in order to get better signal level.
3. The EUT was placed on a turntable with 0.8 meter above ground.
4. The EUT was set 3 meters from the interference receiving antenna, which was mounted on the top of a variable height antenna tower.
5. Corrected Reading: Antenna Factor + Cable Loss + Read Level - Preamp Factor = Level
6. For measurement below 1GHz, If the emission level of the EUT measured by the peak detector is 3 dB lower than the applicable limit, the peak emission level will be reported. Otherwise, the emission measurement will be repeated using the quasi-peak detector and reported.
7. Use the following spectrum analyzer settings:
 - (1) Span shall wide enough to fully capture the emission being measured;
 - (2) Set RBW=100 kHz for $f < 1$ GHz; $VBW \geq RBW$; Sweep = auto; Detector function = peak; Trace = max hold;
 - (3) Set RBW = 1 MHz, VBW= 3MHz for $f \geq 1$ GHz for peak measurement.
 For average measurement:
 - $VBW = 10$ Hz, when duty cycle is no less than 98 percent.
 - $VBW \geq 1/T$, when duty cycle is less than 98 percent where T is the minimum transmission duration over which the transmitter is on and is transmitting at its maximum power control level for the tested mode of operation.

| Band | Duty Cycle(%) | T(ms) | 1/T(kHz) | VBW Setting |
|------------------|---------------|-------|----------|-------------|
| Bluetooth 4.0 LE | 60.13 | 0.38 | 2.63 | 3kHz |

3.5.4 Test Setup

For radiated emissions below 30MHz

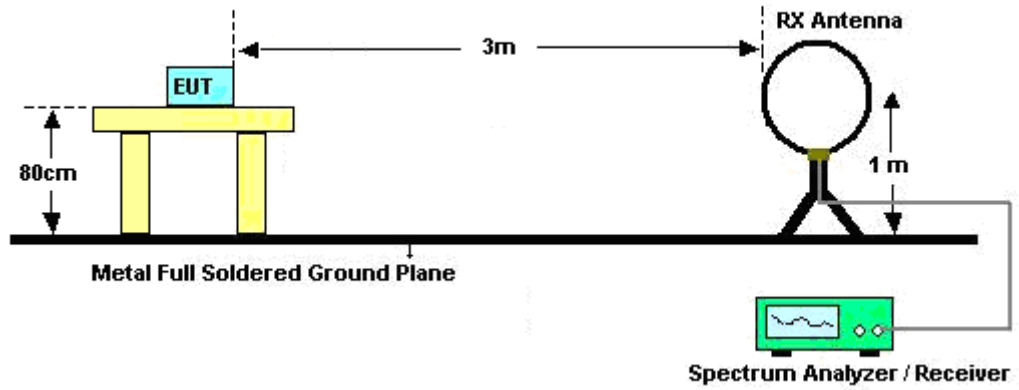

For radiated emissions from 30MHz to 1GHz

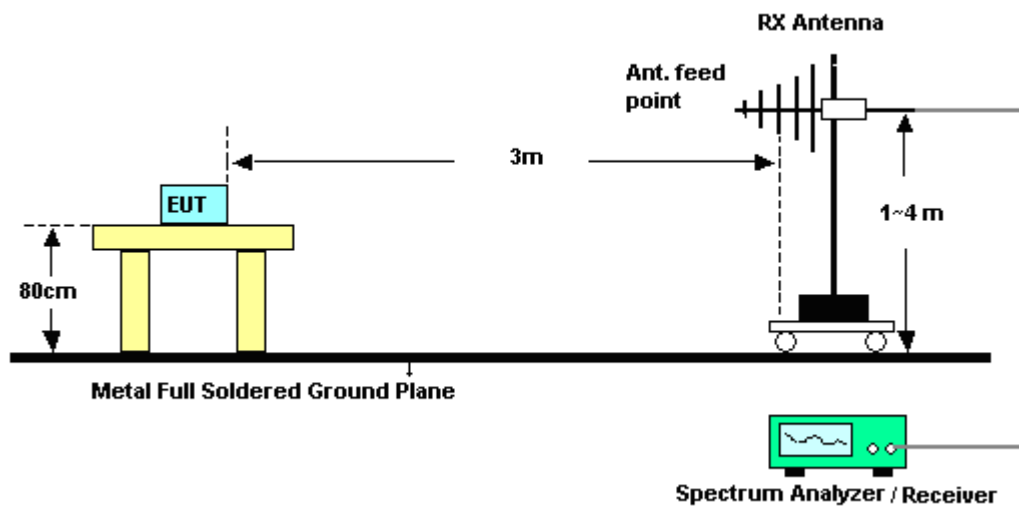

For radiated emissions above 1GHz

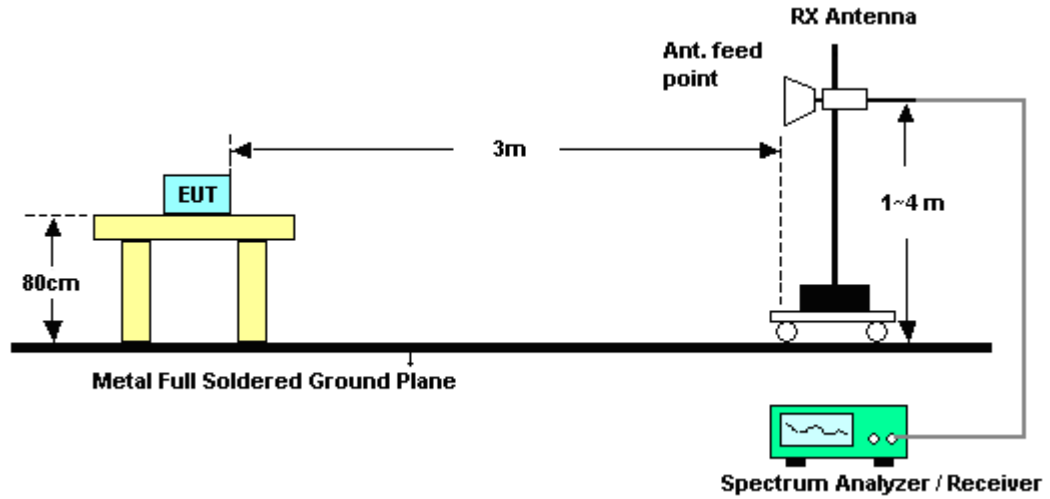

3.5.5 Test Results of Radiated Spurious Emissions (9 kHz ~ 30 MHz)

The low frequency, which started from 9 kHz to 30MHz, was pre-scanned and the result which was 20dB lower than the limit line per 15.31(o) was not reported.



3.5.6 Test Result of Radiated Spurious at Band Edges

| | | | |
|----------------|--------|---------------------|----------|
| Test Mode : | Mode 1 | Temperature : | 24~25°C |
| Test Channel : | 00 | Relative Humidity : | 48~49% |
| | | Test Engineer : | Leo Liao |

| ANTENNA POLARITY : HORIZONTAL | | | | | | | | | | |
|-------------------------------|---------------------|-------------------------|-----------------------------|-------------------------|-----------------------------|-------------------------|----------------------------|----------------------|-------------------------|---------|
| Frequency (MHz) | Level (dBμV /m) | Over Limit (dB) | Limit Line (dBμV /m) | Read Level (dBμV) | Antenna Factor (dB) | Cable Loss (dB) | Preamp Factor (dB) | Ant Pos (cm) | Table Pos (deg) | Remark |
| 2384.70 | 45.99 | -28.01 | 74 | 38.29 | 31.9 | 5.59 | 29.79 | 100 | 136 | Peak |
| 2374.17 | 35.93 | -18.07 | 54 | 28.23 | 31.9 | 5.59 | 29.79 | 100 | 136 | Average |

| ANTENNA POLARITY : VERTICAL | | | | | | | | | | |
|-----------------------------|---------------------|-------------------------|-----------------------------|-------------------------|-----------------------------|-------------------------|----------------------------|----------------------|-------------------------|---------|
| Frequency (MHz) | Level (dBμV /m) | Over Limit (dB) | Limit Line (dBμV /m) | Read Level (dBμV) | Antenna Factor (dB) | Cable Loss (dB) | Preamp Factor (dB) | Ant Pos (cm) | Table Pos (deg) | Remark |
| 2359.68 | 46.22 | -27.78 | 74 | 38.64 | 31.81 | 5.56 | 29.79 | 100 | 242 | Peak |
| 2388.75 | 35.96 | -18.04 | 54 | 28.18 | 31.98 | 5.59 | 29.79 | 100 | 242 | Average |

| | | | |
|----------------|--------|---------------------|----------|
| Test Mode : | Mode 3 | Temperature : | 24~25°C |
| Test Channel : | 39 | Relative Humidity : | 48~49% |
| | | Test Engineer : | Leo Liao |

| ANTENNA POLARITY : HORIZONTAL | | | | | | | | | | |
|-------------------------------|---------------------|-------------------------|-----------------------------|-------------------------|-----------------------------|-------------------------|----------------------------|----------------------|-------------------------|---------|
| Frequency (MHz) | Level (dBμV /m) | Over Limit (dB) | Limit Line (dBμV /m) | Read Level (dBμV) | Antenna Factor (dB) | Cable Loss (dB) | Preamp Factor (dB) | Ant Pos (cm) | Table Pos (deg) | Remark |
| 2483.95 | 47.94 | -26.06 | 74 | 39.58 | 32.41 | 5.71 | 29.76 | 100 | 126 | Peak |
| 2483.62 | 37.13 | -16.87 | 54 | 28.77 | 32.41 | 5.71 | 29.76 | 100 | 126 | Average |

| ANTENNA POLARITY : VERTICAL | | | | | | | | | | |
|-----------------------------|---------------------|-------------------------|-----------------------------|-------------------------|-----------------------------|-------------------------|----------------------------|----------------------|-------------------------|---------|
| Frequency (MHz) | Level (dBμV /m) | Over Limit (dB) | Limit Line (dBμV /m) | Read Level (dBμV) | Antenna Factor (dB) | Cable Loss (dB) | Preamp Factor (dB) | Ant Pos (cm) | Table Pos (deg) | Remark |
| 2488.63 | 47.61 | -26.39 | 74 | 39.16 | 32.5 | 5.71 | 29.76 | 100 | 277 | Peak |
| 2483.50 | 37.05 | -16.95 | 54 | 28.69 | 32.41 | 5.71 | 29.76 | 100 | 277 | Average |

3.5.7 Test Result of Radiated Spurious Emission (30MHz ~ 10th Harmonic)

Note: Pre-scanned all test modes and only choose the worst case mode recorded in the test report for radiated spurious emission below 1GHz.

| | | | |
|------------------------|--|----------------------------|------------|
| Test Mode : | Mode 1 | Temperature : | 24~25°C |
| Test Channel : | 00 | Relative Humidity : | 48~49% |
| Test Engineer : | Leo Liao | Polarization : | Horizontal |
| Remark : | 1. 2402 MHz is fundamental signal which can be ignored. 2. Average measurement was not performed if peak level went lower than the average limit. | | |

| Frequency (MHz) | Level (dBμV/m) | Over Limit (dB) | Limit Line (dBμV/m) | Read Level (dBμV) | Antenna Factor (dB) | Cable Loss (dB) | Preamp Factor (dB) | Ant Pos (cm) | Table Pos (deg) | Remark |
|-------------------|------------------|-------------------|-----------------------|---------------------|-----------------------|-------------------|----------------------|----------------|-------------------|---------|
| 2402 | 92.40 | - | - | 84.58 | 31.98 | 5.62 | 29.78 | 100 | 136 | Peak |
| 2402 | 91.74 | - | - | 83.92 | 31.98 | 5.62 | 29.78 | 100 | 136 | Average |
| 4804 | 34.33 | -39.67 | 74 | 49.51 | 33.78 | 8.33 | 57.29 | 119 | 148 | Peak |

Note: Other harmonics are lower than background noise.

| | | | |
|------------------------|--|----------------------------|----------|
| Test Mode : | Mode 1 | Temperature : | 24~25°C |
| Test Channel : | 00 | Relative Humidity : | 48~49% |
| Test Engineer : | Leo Liao | Polarization : | Vertical |
| Remark : | 1. 2402 MHz is fundamental signal which can be ignored. 2. Average measurement was not performed if peak level went lower than the average limit. | | |

| Frequency (MHz) | Level (dBμV/m) | Over Limit (dB) | Limit Line (dBμV/m) | Read Level (dBμV) | Antenna Factor (dB) | Cable Loss (dB) | Preamp Factor (dB) | Ant Pos (cm) | Table Pos (deg) | Remark |
|-------------------|------------------|-------------------|-----------------------|---------------------|-----------------------|-------------------|----------------------|----------------|-------------------|---------|
| 2402 | 89.11 | - | - | 81.29 | 31.98 | 5.62 | 29.78 | 100 | 242 | Peak |
| 2402 | 88.42 | - | - | 80.6 | 31.98 | 5.62 | 29.78 | 100 | 242 | Average |
| 4804 | 35.61 | -38.39 | 74 | 50.79 | 33.78 | 8.33 | 57.29 | 119 | 148 | Peak |

Note: Other harmonics are lower than background noise.



| | | | |
|------------------------|--|----------------------------|------------|
| Test Mode : | Mode 2 | Temperature : | 24~25°C |
| Test Channel : | 19 | Relative Humidity : | 48~49% |
| Test Engineer : | Leo Liao | Polarization : | Horizontal |
| Remark : | 1. 2440 MHz is fundamental signal which can be ignored. 2. Average measurement was not performed if peak level went lower than the average limit. | | |

| Frequency (MHz) | Level (dBμV/m) | Over Limit (dB) | Limit Line (dBμV/m) | Read Level (dBμV) | Antenna Factor (dB) | Cable Loss (dB) | Preamp Factor (dB) | Ant Pos (cm) | Table Pos (deg) | Remark |
|-------------------|------------------|-------------------|-----------------------|---------------------|-----------------------|-------------------|----------------------|----------------|-------------------|---------|
| 2440 | 92.36 | - | - | 84.24 | 32.24 | 5.65 | 29.77 | 100 | 49 | Peak |
| 2440 | 92.04 | - | - | 83.92 | 32.24 | 5.65 | 29.77 | 100 | 49 | Average |
| 4880 | 36.07 | -37.93 | 74 | 50.9 | 33.93 | 8.41 | 57.17 | 110 | 245 | Peak |
| 7320 | 36.85 | -37.15 | 74 | 50.09 | 33.9 | 10 | 57.14 | 184 | 225 | Peak |

Note: Other harmonics are lower than background noise.

| | | | |
|------------------------|--|----------------------------|----------|
| Test Mode : | Mode 2 | Temperature : | 24~25°C |
| Test Channel : | 19 | Relative Humidity : | 48~49% |
| Test Engineer : | Leo Liao | Polarization : | Vertical |
| Remark : | 1. 2440 MHz is fundamental signal which can be ignored. 2. Average measurement was not performed if peak level went lower than the average limit. | | |

| Frequency (MHz) | Level (dBμV/m) | Over Limit (dB) | Limit Line (dBμV/m) | Read Level (dBμV) | Antenna Factor (dB) | Cable Loss (dB) | Preamp Factor (dB) | Ant Pos (cm) | Table Pos (deg) | Remark |
|-------------------|------------------|-------------------|-----------------------|---------------------|-----------------------|-------------------|----------------------|----------------|-------------------|---------|
| 2440 | 91.10 | - | - | 82.98 | 32.24 | 5.65 | 29.77 | 123 | 248 | Peak |
| 2440 | 90.54 | - | - | 82.42 | 32.24 | 5.65 | 29.77 | 123 | 248 | Average |
| 4880 | 36.76 | -37.24 | 74 | 51.59 | 33.93 | 8.41 | 57.17 | 110 | 245 | Peak |
| 7320 | 37.26 | -36.74 | 74 | 50.50 | 33.90 | 10.00 | 57.14 | 184 | 225 | Peak |

Note: Other harmonics are lower than background noise.



| | | | |
|------------------------|--|----------------------------|------------|
| Test Mode : | Mode 3 | Temperature : | 24~25°C |
| Test Channel : | 39 | Relative Humidity : | 48~49% |
| Test Engineer : | Leo Liao | Polarization : | Horizontal |
| Remark : | 1. 2480 MHz is fundamental signal which can be ignored. 2. Average measurement was not performed if peak level went lower than the average limit. | | |

| Frequency (MHz) | Level (dBμV/m) | Over Limit (dB) | Limit Line (dBμV/m) | Read Level (dBμV) | Antenna Factor (dB) | Cable Loss (dB) | Preamp Factor (dB) | Ant Pos (cm) | Table Pos (deg) | Remark |
|----------------------|---------------------|-------------------------|-----------------------------|---------------------------|-----------------------------|-------------------------|----------------------------|----------------------|-------------------------|---------|
| 98.87 | 27.16 | -16.34 | 43.5 | 44.84 | 11.01 | 1.25 | 29.94 | 100 | 200 | Peak |
| 158.04 | 23.05 | -20.45 | 43.5 | 42.39 | 9.06 | 1.54 | 29.94 | - | - | Peak |
| 188.11 | 22.61 | -20.89 | 43.5 | 42.39 | 8.52 | 1.64 | 29.94 | - | - | Peak |
| 622.67 | 23.38 | -22.62 | 46 | 31.88 | 18.6 | 2.82 | 29.92 | - | - | Peak |
| 751.68 | 25.45 | -20.55 | 46 | 31.87 | 20.45 | 3.06 | 29.93 | - | - | Peak |
| 935.98 | 25.23 | -20.77 | 46 | 30.68 | 21.06 | 3.43 | 29.94 | - | - | Peak |
| 2480 | 93.05 | - | - | 84.69 | 32.41 | 5.71 | 29.76 | 100 | 126 | Peak |
| 2480 | 92.44 | - | - | 84.08 | 32.41 | 5.71 | 29.76 | 100 | 126 | Average |
| 4960 | 36.78 | -37.22 | 74 | 51.19 | 34.12 | 8.49 | 57.02 | 150 | 135 | Peak |
| 7440 | 36.11 | -37.89 | 74 | 49.09 | 33.97 | 10.04 | 56.99 | 175 | 260 | Peak |

Note: Other harmonics are lower than background noise.



| | | | |
|------------------------|--|----------------------------|----------|
| Test Mode : | Mode 3 | Temperature : | 24~25°C |
| Test Channel : | 39 | Relative Humidity : | 48~49% |
| Test Engineer : | Leo Liao | Polarization : | Vertical |
| Remark : | 1. 2480 MHz is fundamental signal which can be ignored. 2. Average measurement was not performed if peak level went lower than the average limit. | | |

| Frequency (MHz) | Level (dBμV/m) | Over Limit (dB) | Limit Line (dBμV/m) | Read Level (dBμV) | Antenna Factor (dB) | Cable Loss (dB) | Preamp Factor (dB) | Ant Pos (cm) | Table Pos (deg) | Remark |
|----------------------|---------------------|-------------------------|----------------------------|-------------------------|-----------------------------|-------------------------|----------------------------|----------------------|-------------------------|---------|
| 40.67 | 33.67 | -6.33 | 40 | 50.24 | 12.5 | 0.86 | 29.93 | 100 | 120 | Peak |
| 104.69 | 34.11 | -9.39 | 43.5 | 51.16 | 11.6 | 1.29 | 29.94 | - | - | Peak |
| 469.41 | 21.34 | -24.66 | 46 | 31.78 | 17.03 | 2.45 | 29.92 | - | - | Peak |
| 720.64 | 23.26 | -22.74 | 46 | 30.9 | 19.3 | 2.99 | 29.93 | - | - | Peak |
| 853.53 | 24.79 | -21.21 | 46 | 30.71 | 20.74 | 3.27 | 29.93 | - | - | Peak |
| 909.79 | 24.85 | -21.15 | 46 | 30.34 | 21.1 | 3.35 | 29.94 | - | - | Peak |
| 2480 | 91.96 | - | - | 83.6 | 32.41 | 5.71 | 29.76 | 100 | 277 | Peak |
| 2480 | 91.08 | - | - | 82.72 | 32.41 | 5.71 | 29.76 | 100 | 277 | Average |
| 4960 | 36.14 | -37.86 | 74 | 50.55 | 34.12 | 8.49 | 57.02 | 150 | 135 | Peak |
| 7440 | 36.72 | -37.28 | 74 | 49.7 | 33.97 | 10.04 | 56.99 | 175 | 260 | Peak |

Note: Other harmonics are lower than background noise.

3.6 AC Conducted Emission Measurement

3.6.1 Limit of AC Conducted Emission

For equipment that is designed to be connected to the public utility (AC) power line, the radio frequency voltage that is conducted back onto the AC power line on any frequency or frequencies within the band 150 kHz to 30 MHz shall not exceed the limits in the following table.

| Frequency of emission (MHz) | Conducted limit (dB μ V) | |
|-----------------------------|------------------------------|-----------|
| | Quasi-peak | Average |
| 0.15-0.5 | 66 to 56* | 56 to 46* |
| 0.5-5 | 56 | 46 |
| 5-30 | 60 | 50 |

*Decreases with the logarithm of the frequency.

3.6.2 Measuring Instruments

The section 4.0 of List of Measuring Equipment of this test report is used for test.

3.6.3 Test Procedures

1. The EUT was placed 0.4 meter from the conducting wall of the shielding room was kept at least 80 centimeters from any other grounded conducting surface.
2. Connect EUT to the power mains through a line impedance stabilization network (LISN).
3. All the support units are connecting to the other LISN.
4. The LISN provides 50 ohm coupling impedance for the measuring instrument.
5. The FCC states that a 50 ohm, 50 microhenry LISN should be used.
6. Both sides of AC line were checked for maximum conducted interference.
7. The frequency range from 150 kHz to 30 MHz was searched.
8. Set the test-receiver system to Peak Detect Function and specified bandwidth with Maximum Hold Mode.

3.6.4 Test Setup

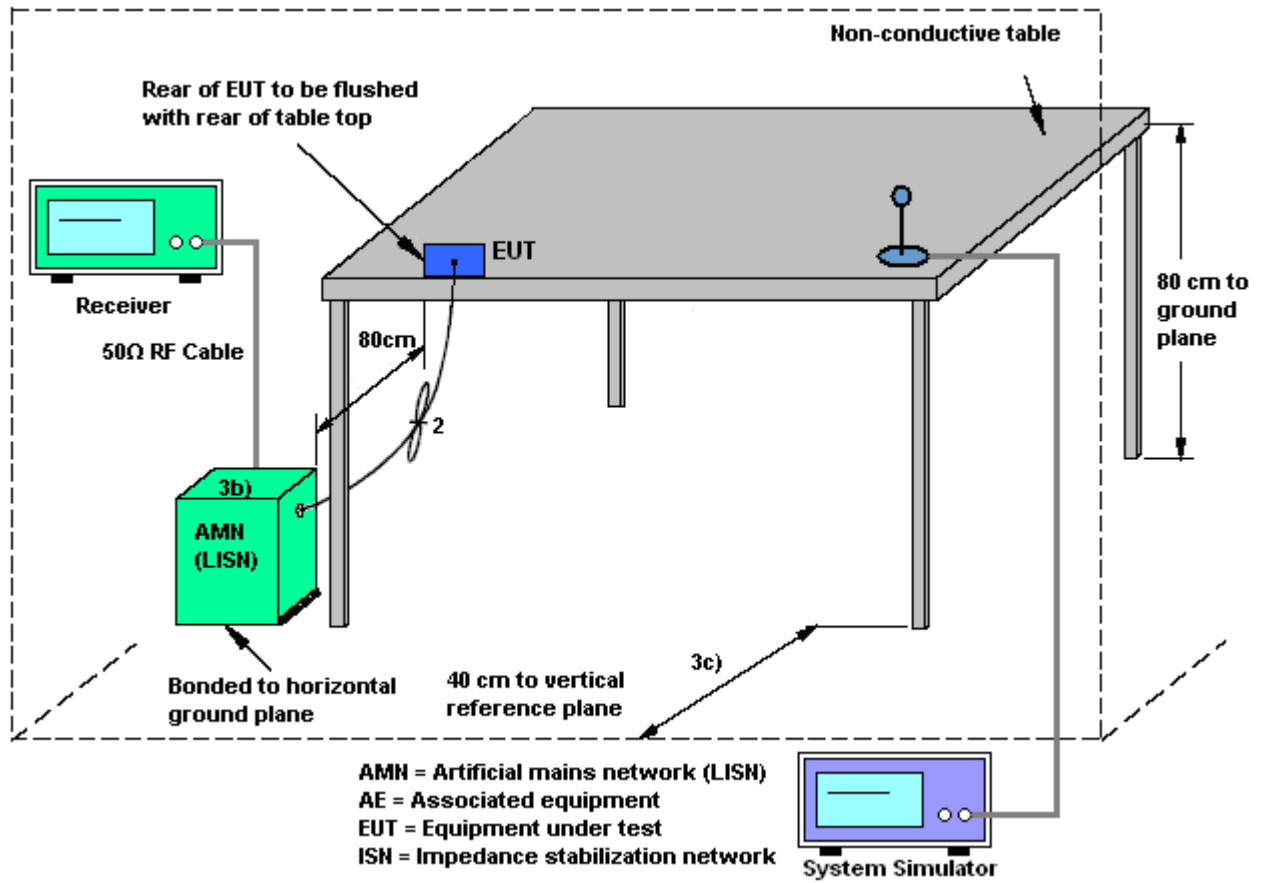



3.6.5 Test Result of AC Conducted Emission

| | | | |
|-----------------|--|---------------------|---------|
| Test Mode : | Mode 1 | Temperature : | 21~22°C |
| Test Engineer : | Jack Tian | Relative Humidity : | 41~42% |
| Test Voltage : | 120Vac / 60Hz | Phase : | Line |
| Function Type : | GSM850 Idle + Bluetooth Link + WLAN Link + USB Cable (Charging from Adapter) + Earphone for Sample 1 | | |

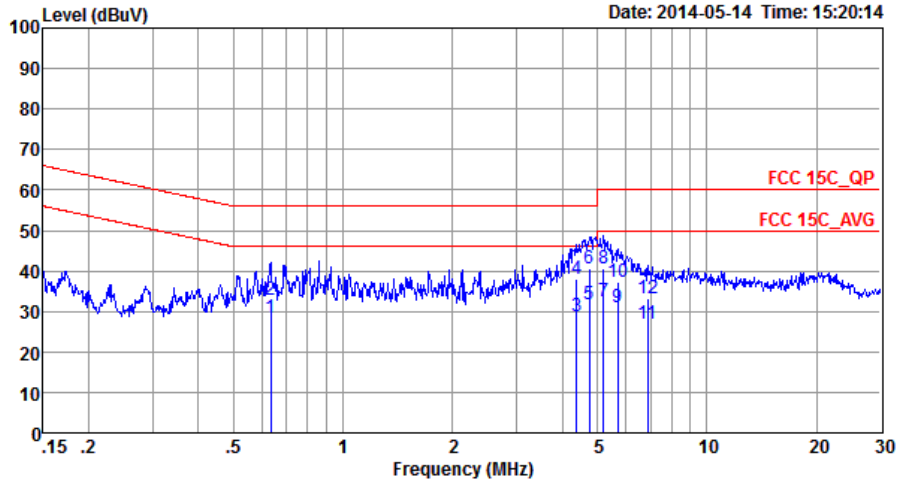

Site : CO01-SZ
 Condition: FCC 15C_QP LISN_L_20140304 LINE

| | Freq | Level | Over Limit | Limit Line | Read Level | LISN Factor | Cable Loss | Remark |
|-----|------|-------|------------|------------|------------|-------------|------------|---------|
| | MHz | dBuV | dB | dBuV | dBuV | dB | dB | |
| 1 | 0.63 | 28.57 | -17.43 | 46.00 | 18.20 | 0.22 | 10.15 | Average |
| 2 | 0.63 | 32.87 | -23.13 | 56.00 | 22.50 | 0.22 | 10.15 | QP |
| 3 | 4.38 | 28.92 | -17.08 | 46.00 | 18.30 | 0.39 | 10.23 | Average |
| 4 | 4.38 | 38.12 | -17.88 | 56.00 | 27.50 | 0.39 | 10.23 | QP |
| 5 * | 4.75 | 31.65 | -14.35 | 46.00 | 21.00 | 0.41 | 10.24 | Average |
| 6 | 4.75 | 40.65 | -15.35 | 56.00 | 30.00 | 0.41 | 10.24 | QP |
| 7 | 5.19 | 32.46 | -17.54 | 50.00 | 21.80 | 0.42 | 10.24 | Average |
| 8 | 5.19 | 40.76 | -19.24 | 60.00 | 30.10 | 0.42 | 10.24 | QP |
| 9 | 5.68 | 30.96 | -19.04 | 50.00 | 20.31 | 0.40 | 10.25 | Average |
| 10 | 5.68 | 37.36 | -22.64 | 60.00 | 26.71 | 0.40 | 10.25 | QP |
| 11 | 6.88 | 26.86 | -23.14 | 50.00 | 16.20 | 0.38 | 10.28 | Average |
| 12 | 6.88 | 33.26 | -26.74 | 60.00 | 22.60 | 0.38 | 10.28 | QP |



| | | | |
|-----------------|--|---------------------|---------|
| Test Mode : | Mode 1 | Temperature : | 21~22°C |
| Test Engineer : | Jack Tian | Relative Humidity : | 41~42% |
| Test Voltage : | 120Vac / 60Hz | Phase : | Neutral |
| Function Type : | GSM850 Idle + Bluetooth Link + WLAN Link + USB Cable (Charging from Adapter) + Earphone for Sample 1 | | |

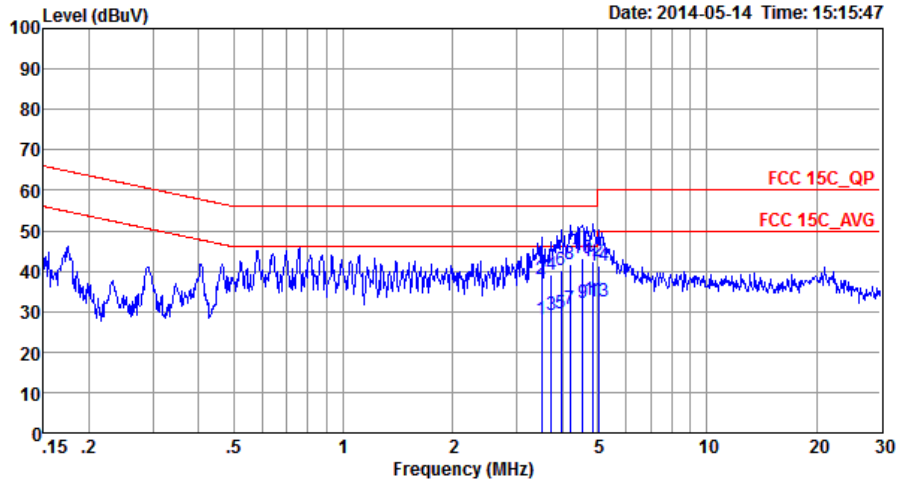

Site : CO01-SZ
 Condition: FCC 15C_QP LISN_N_20140304 NEUTRAL

| | Freq | Level | Over Limit | Limit Line | Read Level | LISN Factor | Cable Loss | Remark |
|------|------|-------|------------|------------|------------|-------------|------------|---------|
| | MHz | dBuV | dB | dBuV | dBuV | dB | dB | |
| 1 | 3.51 | 27.86 | -18.14 | 46.00 | 17.20 | 0.44 | 10.22 | Average |
| 2 | 3.51 | 37.86 | -18.14 | 56.00 | 27.20 | 0.44 | 10.22 | QP |
| 3 | 3.74 | 28.98 | -17.02 | 46.00 | 18.31 | 0.45 | 10.22 | Average |
| 4 | 3.74 | 39.18 | -16.82 | 56.00 | 28.51 | 0.45 | 10.22 | QP |
| 5 | 3.96 | 29.69 | -16.31 | 46.00 | 19.00 | 0.46 | 10.23 | Average |
| 6 | 3.96 | 40.39 | -15.61 | 56.00 | 29.70 | 0.46 | 10.23 | QP |
| 7 | 4.20 | 30.80 | -15.20 | 46.00 | 20.10 | 0.47 | 10.23 | Average |
| 8 | 4.20 | 41.60 | -14.40 | 56.00 | 30.90 | 0.47 | 10.23 | QP |
| 9 | 4.55 | 32.01 | -13.99 | 46.00 | 21.30 | 0.48 | 10.23 | Average |
| 10 * | 4.55 | 43.11 | -12.89 | 56.00 | 32.40 | 0.48 | 10.23 | QP |
| 11 | 4.87 | 32.83 | -13.17 | 46.00 | 22.10 | 0.49 | 10.24 | Average |
| 12 | 4.87 | 42.43 | -13.57 | 56.00 | 31.70 | 0.49 | 10.24 | QP |
| 13 | 5.03 | 32.43 | -17.57 | 50.00 | 21.70 | 0.49 | 10.24 | Average |
| 14 | 5.03 | 41.33 | -18.67 | 60.00 | 30.60 | 0.49 | 10.24 | QP |

3.7 Antenna Requirements

3.7.1 Standard Applicable

If directional gain of transmitting antennas is greater than 6dBi, the power shall be reduced by the same level in dB comparing to gain minus 6dBi. The use of a permanently attached antenna or of an antenna that uses a unique coupling to the intentional radiator shall be considered sufficient to comply with the FCC rule.

3.7.2 Antenna Anti-Replacement Construction

An embedded-in antenna design is used.

3.7.3 Antenna Gain

The antenna peak gain of EUT is less than 6 dBi. Therefore, it is not necessary to reduce maximum peak output power limit.



4 List of Measuring Equipment

| Instrument | Manufacturer | Model No. | Serial No. | Characteristics | Calibration Date | Test Date | Due Date | Remark |
|-----------------------------------|----------------|-----------|--------------|-----------------|------------------|--------------|---------------|-----------------------|
| Spectrum Analyzer | R&S | FSV40 | 101078 | 10Hz~40GHz | Jun. 17, 2013 | May 23, 2014 | Jun. 16, 2014 | Conducted (TH01-SZ) |
| Power Meter | Anritsu | ML2495A | 1218010 | 13dBm~-20dBm | Mar. 03, 2014 | May 23, 2014 | Mar. 02, 2015 | Conducted (TH01-SZ) |
| Power Sensor | Anritsu | MA2411B | 1207253 | 0.3GHz~40GHz | Mar. 03, 2014 | May 23, 2014 | Mar. 02, 2015 | Conducted (TH01-SZ) |
| ESCIO TEST Receiver | R&S | ESCI | 100724 | 9kHz~3GHz | Feb. 21, 2014 | May 26, 2014 | Feb. 20, 2015 | Radiation (03CH01-SZ) |
| Signal Analyzer | R&S | FSV40 | 101078 | 10Hz~40GHz | Jun. 17, 2013 | May 26, 2014 | Jun. 16, 2014 | Radiation (03CH01-SZ) |
| Loop Antenna | R&S | HFH2-Z2 | 100354 | 9kHz~30MHz | May 29, 2013 | May 26, 2014 | May 28, 2014 | Radiation (03CH01-SZ) |
| Bilog Antenna | TESEQ | CBL 6112D | 23188 | 30MHz~2GHz | Oct. 26, 2013 | May 26, 2014 | Oct. 25, 2014 | Radiation (03CH01-SZ) |
| Double Ridge Horn Antenna | ETS Lindgren | 3117 | 00119436 | 1GHz~18GHz | Oct. 26, 2013 | May 26, 2014 | Oct. 25, 2014 | Radiation (03CH01-SZ) |
| Double Ridged Horn Antenna | COM-POWER | AH-840 | 101073 | 18GHz~40GHz | Jan. 27, 2014 | May 26, 2014 | Jan. 26, 2015 | Radiation (03CH01-SZ) |
| Amplifier | ADVANTEST | BB525C | E9007003 | 9kHz~3000MHz | Feb. 21, 2014 | May 26, 2014 | Feb. 20, 2015 | Radiation (03CH01-SZ) |
| Amplifier | Agilent | 83017A | MY39501302 | 3Hz~26.5GHz | Mar. 03, 2014 | May 26, 2014 | Mar. 02, 2015 | Radiation (03CH01-SZ) |
| AC Source(AVR) | Chroma | 61601 | 616010001985 | 100Vac~250Vac | Mar. 25, 2014 | May 26, 2014 | Mar. 24, 2015 | Radiation (03CH01-SZ) |
| Turn Table | EM Electronics | EM 1000 | N/A | 0~360 degree | NCR | May 26, 2014 | NCR | Radiation (03CH01-SZ) |
| Antenna Mast | EM Electronics | EM 1000 | N/A | 1 m~4 m | NCR | May 26, 2014 | NCR | Radiation (03CH01-SZ) |
| ESCIO TEST Receiver | R&S | ESCI | 100724 | 9kHz~3GHz | Feb. 21, 2014 | May 14, 2014 | Feb. 20, 2015 | Conduction (CO01-SZ) |
| AC LISN | EMCO | 3816/2SH | 00103912 | 9kHz~30MHz | Mar. 04, 2014 | May 14, 2014 | Mar. 03, 2015 | Conduction (CO01-SZ) |
| AC LISN (for auxiliary equipment) | EMCO | 3816/2SH | 00103892 | 9kHz~30MHz | Mar. 04, 2014 | May 14, 2014 | Mar. 03, 2015 | Conduction (CO01-SZ) |
| AC Power Source | Chroma | 61602 | 616020000891 | 100Vac~250Vac | Dec. 17, 2013 | May 14, 2014 | Dec. 16, 2014 | Conduction (CO01-SZ) |



5 Uncertainty of Evaluation

Uncertainty of Conducted Emission Measurement (150 kHz ~ 30 MHz)

| | |
|---|------|
| Measuring Uncertainty for a Level of Confidence of 95% ($U = 2Uc(y)$) | 2.31 |
|---|------|

Uncertainty of Radiated Emission Measurement (30 MHz ~ 1000 MHz)

| | |
|---|------|
| Measuring Uncertainty for a Level of Confidence of 95% ($U = 2Uc(y)$) | 3.90 |
|---|------|