

# FCC RF Test Report

**APPLICANT** : Lenovo (Shanghai) Electronics Technology Co., Ltd.  
**EQUIPMENT** : Portable Tablet Computer  
**BRAND NAME** : lenovo  
**MODEL NAME** : Lenovo A3300-HV  
**MARKETING NAME** : Lenovo A3300-HV  
**FCC ID** : O57A3300HV  
**STANDARD** : FCC Part 15 Subpart C §15.247  
**CLASSIFICATION** : (DTS) Digital Transmission System

The product was testing completed on May 26, 2014. We, SPORTON INTERNATIONAL (SHENZHEN) INC., would like to declare that the tested sample has been evaluated in accordance with the test procedures and the testing has shown the tested sample to be in compliance with the applicable technical standards.

The test results in this report apply exclusively to the tested model / sample. Without written approval of SPORTON INTERNATIONAL (SHENZHEN) INC., the test report shall not be reproduced except in full.



Reviewed by: Joseph Lin / Supervisor



Approved by: Jones Tsai / Manager



**SPORTON INTERNATIONAL (SHENZHEN) INC.**

**No. 3 Building, the third floor of south, Shahe River west, Fengzeyuan warehouse, Nanshan District, Shenzhen, Guangdong, P.R.C.**



# TABLE OF CONTENTS

**REVISION HISTORY..... 3**

**SUMMARY OF TEST RESULT ..... 4**

**1 GENERAL DESCRIPTION ..... 5**

    1.1 Applicant ..... 5

    1.2 Manufacturer ..... 5

    1.3 Feature of Equipment Under Test ..... 5

    1.4 Product Specification of Equipment Under Test ..... 5

    1.5 Modification of EUT ..... 6

    1.6 Testing Location ..... 6

    1.7 Applicable Standards ..... 6

**2 TEST CONFIGURATION OF EQUIPMENT UNDER TEST ..... 7**

    2.1 Carrier Frequency Channel ..... 7

    2.2 Pre-Scanned RF Power ..... 8

    2.3 Test Mode ..... 10

    2.4 Connection Diagram of Test System ..... 11

    2.5 Support Unit used in test configuration and system ..... 12

    2.6 EUT Operation Test Setup ..... 12

    2.7 Measurement Results Explanation Example ..... 12

**3 TEST RESULT ..... 13**

    3.1 6dB Bandwidth Measurement ..... 13

    3.2 Output Power Measurement ..... 15

    3.3 Power Spectral Density Measurement ..... 18

    3.4 Conducted Band Edges and Spurious Emission Measurement ..... 20

    3.5 Radiated Band Edges and Spurious Emission Measurement ..... 33

    3.6 AC Conducted Emission Measurement ..... 56

    3.7 Antenna Requirements ..... 60

**4 LIST OF MEASURING EQUIPMENT ..... 61**

**5 UNCERTAINTY OF EVALUATION ..... 62**

**APPENDIX A. SETUP PHOTOGRAPHS**





### SUMMARY OF TEST RESULT

Report Section	FCC Rule	Description	Limit	Result	Remark
3.1	15.247(a)(2)	6dB Bandwidth	$\geq 0.5\text{MHz}$	Pass	-
3.2	15.247(b)	Power Output Measurement	$\leq 30\text{dBm}$	Pass	-
3.3	15.247(e)	Power Spectral Density	$\leq 8\text{dBm}/3\text{kHz}$	Pass	-
3.4	15.247(d)	Conducted Band Edges	$\leq 20\text{dBc}$	Pass	-
		Conducted Spurious Emission		Pass	-
3.5	15.247(d)	Radiated Band Edges and Radiated Spurious Emission	15.209(a) & 15.247(d)	Pass	Under limit 3.13 dB at 33.880 MHz
3.6	15.207	AC Conducted Emission	15.207(a)	Pass	Under limit 12.89 dB at 4.550 MHz
3.7	15.203 & 15.247(b)	Antenna Requirement	N/A	Pass	-

# 1 General Description

## 1.1 Applicant

Lenovo (Shanghai) Electronics Technology Co., Ltd.

No. 68 Building, 199 Fenju Road, Wai Gao Qiao FTZ, Shanghai, China

## 1.2 Manufacturer

Lenovo PC HK Limited

23/F, Lincoln House, Taikoo Place 979 King's Road, Quarry Bay, Hong Kong

## 1.3 Feature of Equipment Under Test

Product Feature	
Equipment	Portable Tablet Computer
Brand Name	lenovo
Model Name	Lenovo A3300-HV
Marketing Name	Lenovo A3300-HV
FCC ID	O57A3300HV
EUT supports Radios application	GSM/GPRS/EGPRS/WCDMA/HSPA/HSPA+(Downlink Only)/WLAN2.4GHz 802.11b/g/n HT20/HT40 Bluetooth v3.0 + EDR/Bluetooth v4.0 LE
HW Version	A977_MB_PCB_V4.0
SW Version	A3300HV_A442_01_06_140505_ROW_ENG
EUT Stage	Pre-Production

**Remark:** The above EUT's information was declared by manufacturer. Please refer to the specifications or user's manual for more detailed description.

## 1.4 Product Specification of Equipment Under Test

Product Specification subjective to this standard	
Tx/Rx Channel Frequency Range	2412 MHz ~ 2462 MHz
Maximum (Peak) Output Power to Antenna	802.11b : 15.30 dBm (0.0339 W) 802.11g : 18.71 dBm (0.0743 W) 802.11n HT20 : 18.52 dBm (0.0711 W) 802.11n HT40 : 18.51 dBm (0.0710 W)
Antenna Type	PIFA Antenna with gain -2.88 dBi
Type of Modulation	802.11b : DSSS (DBPSK / DQPSK / CCK) 802.11g/n : OFDM (BPSK / QPSK / 16QAM / 64QAM)

## 1.5 Modification of EUT

No modifications are made to the EUT during all test items.

## 1.6 Testing Location

<b>Test Site</b>	SPORTON INTERNATIONAL (SHENZHEN) INC.			
<b>Test Site Location</b>	No. 3 Building, the third floor of south, Shahe River west, Fengzeyuan warehouse, Nanshan District, Shenzhen, Guangdong, P.R.C. TEL: +86-755-3320-2398			
<b>Test Site No.</b>	<b>Sporton Site No.</b>			<b>FCC Registration No.</b>
	TH01-SZ	03CH01-SZ	CO01-SZ	831040

**Note:** The test site complies with ANSI C63.4 2003 requirement.

## 1.7 Applicable Standards

According to the specifications of the manufacturer, the EUT must comply with the requirements of the following standards:

- ♦ FCC Part 15 Subpart C §15.247
- ♦ FCC KDB Publication No. 558074 D01 DTS Meas. Guidance v03r01
- ♦ ANSI C63.4-2003

**Remark:**

1. All test items were verified and recorded according to the standards and without any deviation during the test.
2. This EUT has also been tested and complied with the requirements of FCC Part 15, Subpart B, recorded in a separate test report.

## 2 Test Configuration of Equipment Under Test

The EUT has been associated with peripherals and configuration operated in a manner tended to maximize its emission characteristics in a typical application. Frequency range investigated: conducted emission (150 kHz to 30 MHz) and radiated emission (9 kHz to the 10th harmonic of the highest fundamental frequency or to 40 GHz, whichever is lower). For radiated measurement, pre-scanned in three orthogonal panels, X, Y, Z. The worst cases (X plane) were recorded in this report.

The final configuration from all the combinations and the worst-case data rates were investigated by measuring the maximum power across all the data rates and modulation modes under section 2.2.

Based on the worst configuration found above, the RF power setting is set individually to meet FCC compliance limit for the final conducted and radiated tests shown in section 2.3.

### 2.1 Carrier Frequency Channel

Frequency Band	Channel	Freq. (MHz)	Channel	Freq. (MHz)
2400-2483.5 MHz	1	2412	7	2442
	2	2417	8	2447
	3	2422	9	2452
	4	2427	10	2457
	5	2432	11	2462
	6	2437	-	-

## 2.2 Pre-Scanned RF Power

Preliminary tests were performed in different data rate and data rate associated with the highest power were chosen for full test shown in the following tables.

2.4GHz 802.11b RF Power (dBm)						
Power vs. Channel			Power vs. Data Rate			
Channel	Frequency (MHz)	Data Rate	Channel	2Mbps	5.5Mbps	11Mbps
		1Mbps				
CH 1	2412	14.50	CH 11	15.27	15.21	15.22
CH 6	2437	14.77				
CH 11	2462	15.30				

2.4GHz 802.11g RF Power (dBm)										
Power vs. Channel			Power vs. Data Rate							
Channel	Frequency (MHz)	Data Rate	Channel	9Mbps	12Mbps	18Mbps	24Mbps	36Mbps	48Mbps	54Mbps
		6Mbps								
CH 1	2412	17.97	CH 11	18.69	18.67	18.64	18.60	18.58	18.55	18.54
CH 6	2437	18.12								
CH 11	2462	18.71								

2.4GHz 802.11n HT20 RF Power (dBm)										
Power vs. Channel			Power vs. MCS Index							
Channel	Frequency (MHz)	MCS Index	Channel	MCS1	MCS2	MCS3	MCS4	MCS5	MCS6	MCS7
		MCS0								
CH 1	2412	17.49	CH 11	18.49	18.46	18.38	18.41	18.40	18.42	18.43
CH 6	2437	17.86								
CH 11	2462	18.52								





2.4GHz 802.11n HT40 RF Power (dBm)										
Power vs. Channel			Power vs. MCS Index							
Channel	Frequency (MHz)	MCS Index	Channel	MCS1	MCS2	MCS3	MCS4	MCS5	MCS6	MCS7
		MCS0								
CH 03	2422 MHz	17.87	CH 09	18.34	18.32	18.25	18.22	18.20	18.13	18.12
CH 06	2437 MHz	18.12								
CH 09	2452 MHz	18.51								



### 2.3 Test Mode

Final results of test modes, data rates and test channels are shown as following table.

Test Cases				
	Test Items	Mode	Data Rate	Test Channel
Conducted TCs	6dB BW Power Spectral Density Output Power	802.11b	1 Mbps	1/6/11
		802.11g	6 Mbps	1/6/11
		802.11n HT20	MCS0	1/6/11
		802.11n HT40	MCS0	3/6/9
	Conducted Band Edge	802.11b	1 Mbps	1/11
		802.11g	6 Mbps	1/11
		802.11n HT20	MCS0	1/6/11
		802.11n HT40	MCS0	3/6/9
	Conducted Spurious Emission	802.11b	1 Mbps	1/6/11
		802.11g	6 Mbps	1/6/11
		802.11n HT20	MCS0	1/6/11
		802.11n HT40	MCS0	3/6/9
Radiated TCs	Radiated Band Edge	802.11b	1 Mbps	1/11
		802.11g	6 Mbps	1/11
		802.11n HT20	MCS0	1/6/11
		802.11n HT40	MCS0	3/6/9
	Radiated Spurious Emission	802.11b	1 Mbps	1/6/11
		802.11g	6 Mbps	1/6/11
		802.11n HT20	MCS0	1/6/11
		802.11n HT40	MCS0	3/6/9

Test Cases	
AC Conducted Emission	Mode 1 : GSM850 Idle + Bluetooth Link + WLAN Link + USB Cable (Charging from Adapter) + Earphone for Sample 1 Mode 2 : GSM850 Idle + Bluetooth Link + WLAN Link + USB Cable (Charging from Adapter) + Earphone for Sample 2

**Remark:**

1. The worst case of conducted emission is mode 1; only the test data of it was reported.
2. For Radiated TCs, all the test modes are performed with Sample 1, only the worst mode (802.11g CH11) based on Sample 1 need to verify Sample 2.

## 2.4 Connection Diagram of Test System

### <WLAN Tx Mode>

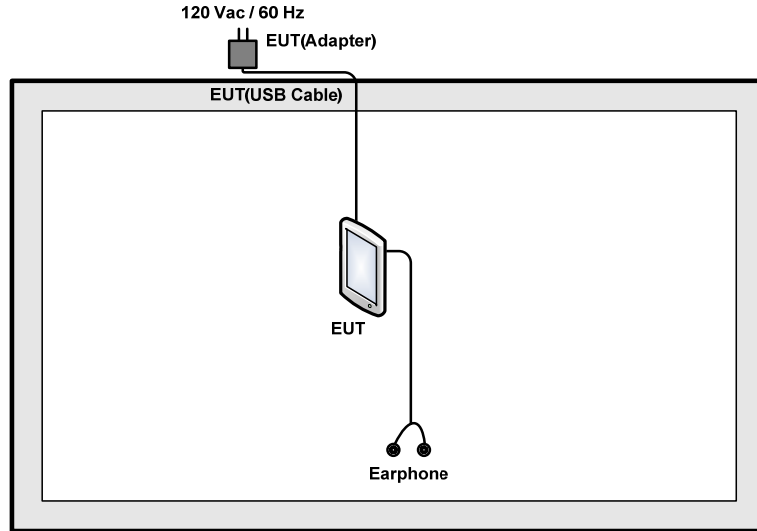

### <AC Conducted Emission Mode>

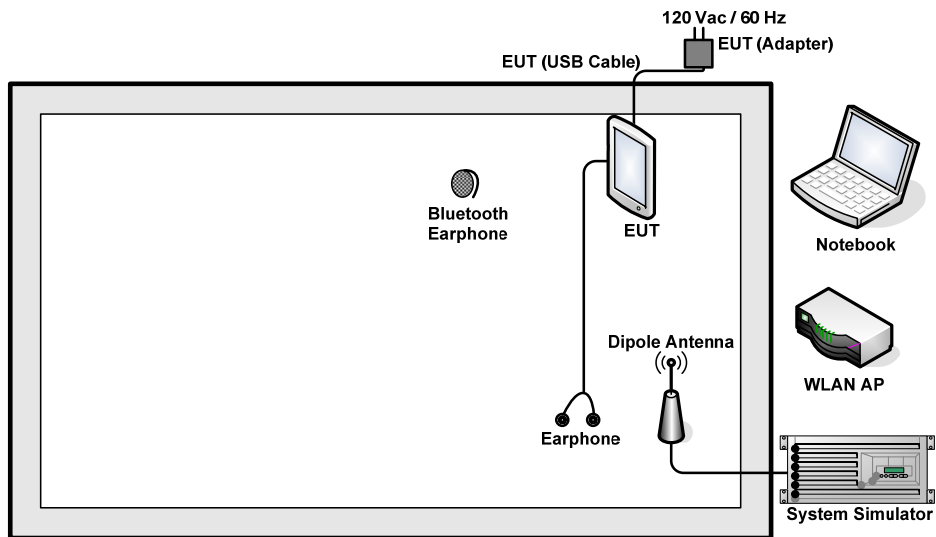

## 2.5 Support Unit used in test configuration and system

Item	Equipment	Trade Name	Model Name	FCC ID	Data Cable	Power Cord
1.	System Simulator	R&S	CMU 200	N/A	N/A	Unshielded, 1.8 m
2.	WLAN AP	D-link	DIR-628	KA2DIR628A2	N/A	Unshielded, 1.8 m
3.	Notebook	Lenovo	G480	PRC4	N/A	AC I/P: Unshielded, 1.8 m DC O/P: Shielded, 1.8 m
4.	Bluetooth Earphone	Nokia	BH-108	PYAHS-107W	N/A	N/A
5.	Earphone	Lenovo	SH100	N/A	N/A	Unshielded, 1.2 m

## 2.6 EUT Operation Test Setup

For WLAN RF test items, an engineering test program was provided and enabled to make EUT continuous transmit/receive.

For AC power line conducted emissions, the EUT was set to connect with the WLAN AP under large package sizes transmission.

## 2.7 Measurement Results Explanation Example

**For all conducted test items:**

The offset level is set in the spectrum analyzer to compensate the RF cable loss and attenuator factor between EUT conducted output port and spectrum analyzer. With the offset compensation, the spectrum analyzer reading level is exactly the EUT RF output level.

Example :

The spectrum analyzer offset is derived from RF cable loss and attenuator factor.

*Offset = RF cable loss + attenuator factor.*

Following shows an offset computation example with cable loss 7.5 dB and 10dB attenuator.

$$\begin{aligned} \text{Offset (dB)} &= \text{RF cable loss (dB)} + \text{attenuator factor (dB)} \\ &= 7.5 + 10 = 17.5 \text{ (dB)} \end{aligned}$$

### 3 Test Result

#### 3.1 6dB Bandwidth Measurement

##### 3.1.1 Limit of 6dB Bandwidth

The minimum 6 dB bandwidth shall be at least 500 kHz.

##### 3.1.2 Measuring Instruments

The measuring equipment is listed in the section 4 of this test report.

##### 3.1.3 Test Procedures

1. The testing follows FCC KDB Publication No. 558074 DTS D01 Meas. Guidance v03r01.
2. The RF output of EUT was connected to the spectrum analyzer by RF cable and attenuator. The path loss was compensated to the results for each measurement.
3. Set to the maximum power setting and enable the EUT transmit continuously.
4. Make the measurement with the spectrum analyzer's resolution bandwidth (RBW) = 100 kHz. Set the Video bandwidth (VBW) = 300 kHz. In order to make an accurate measurement. The 6 dB bandwidth must be greater than 500 kHz.
5. Measure and record the results in the test report.

##### 3.1.4 Test Setup

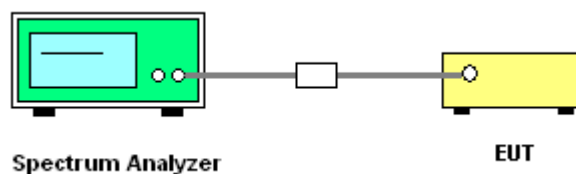

3.1.5 Test Result of 6dB Bandwidth

Test Band :	2.4GHz	Temperature :	24~26°C
Test Engineer :	Blithe Li	Relative Humidity :	50~53%

Mod.	Data Rate	N <sub>TX</sub>	Channel	Freq. (MHz)	6dB Bandwidth (MHz)	6dB Bandwidth Min. Limit (MHz)	Pass/Fail
11b	1Mbps	1	1	2412	9.52	0.5	Pass
11b	1Mbps	1	6	2437	10.00	0.5	Pass
11b	1Mbps	1	11	2462	9.56	0.5	Pass
11g	6Mbps	1	1	2412	16.36	0.5	Pass
11g	6Mbps	1	6	2437	16.36	0.5	Pass
11g	6Mbps	1	11	2462	16.34	0.5	Pass
HT20	MCS0	1	1	2412	17.56	0.5	Pass
HT20	MCS0	1	6	2437	17.58	0.5	Pass
HT20	MCS0	1	11	2462	17.58	0.5	Pass
HT40	MCS0	1	3	2422	36.00	0.5	Pass
HT40	MCS0	1	6	2437	36.32	0.5	Pass
HT40	MCS0	1	9	2452	36.28	0.5	Pass

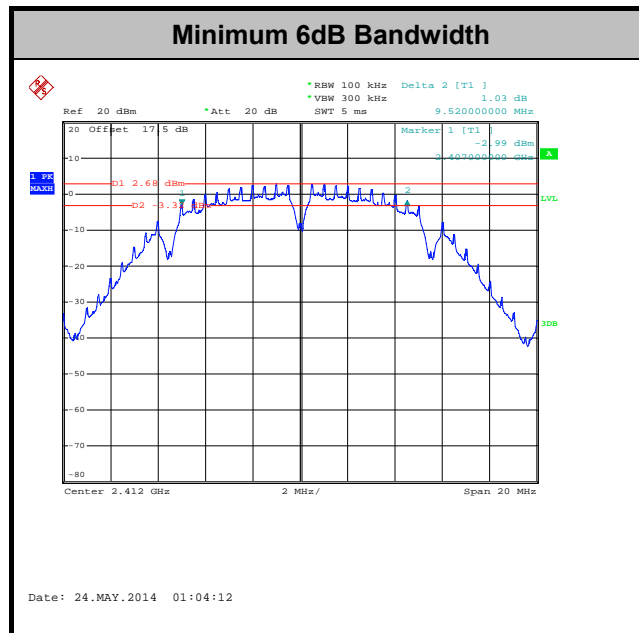

## 3.2 Output Power Measurement

### 3.2.1 Limit of Output Power

For systems using digital modulation in the 2400-2483.5MHz, the limit for peak output power is 30dBm. If transmitting Antenna of directional gain greater than 6dBi are used the peak output power from the intentional radiator shall be reduced below the above stated value by the amount in dB that the directional gain of the Antenna exceeds 6 dBi. In case of point-to-point operation, the limit has to be reduced by 1dB for every 3dB that the directional gain of the Antenna exceeds 6dBi.

### 3.2.2 Measuring Instruments

The measuring equipment is listed in the section 4 of this test report.

### 3.2.3 Test Procedures

1. The testing follows the Measurement Procedure of FCC KDB No. 558074 DTS D01 Meas. Guidance v03r01.
2. The RF output of EUT was connected to the power meter by RF cable and attenuator. The path loss was compensated to the results for each measurement.
3. Set to the maximum power setting and enable the EUT transmit continuously.
4. Measure the conducted output power and record the results in the test report.

### 3.2.4 Test Setup

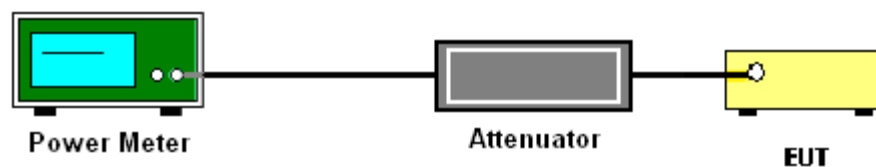



3.2.5 Test Result of Peak Output Power

Test Mode :	2.4GHz	Temperature :	24~26°C
Test Engineer :	Blithe Li	Relative Humidity :	50~53%

Mod.	Data Rate	N <sub>TX</sub>	Channel	Freq. (MHz)	RF Output Power (dBm)	Power Limit (dBm)	DG (dBi)	Pass/Fail
11b	1Mbps	1	1	2412	14.50	30	-2.88	Pass
11b	1Mbps	1	6	2437	14.77	30	-2.88	Pass
11b	1Mbps	1	11	2462	15.30	30	-2.88	Pass
11g	6Mbps	1	1	2412	17.97	30	-2.88	Pass
11g	6Mbps	1	6	2437	18.12	30	-2.88	Pass
11g	6Mbps	1	11	2462	18.71	30	-2.88	Pass
HT20	MCS0	1	1	2412	17.49	30	-2.88	Pass
HT20	MCS0	1	6	2437	17.86	30	-2.88	Pass
HT20	MCS0	1	11	2462	18.52	30	-2.88	Pass
HT40	MCS0	1	3	2422	17.87	30	-2.88	Pass
HT40	MCS0	1	6	2437	18.12	30	-2.88	Pass
HT40	MCS0	1	9	2452	18.51	30	-2.88	Pass

Note: Measured power (dBm) has offset with cable loss.





3.2.6 Test Result of Average output Power (Reporting Only)

Test Mode :	2.4GHz + 5GHz band 4	Temperature :	24~26°C
Test Engineer :	Blithe Li	Relative Humidity :	50~53%

Mod.	Data Rate	N <sub>TX</sub>	Channel	Freq. (MHz)	Duty Factor (dB)	Average Output Power (dBm)	Power Limit (dBm)	DG (dBi)	Pass/Fail
11b	1Mbps	1	1	2412	0.06	11.64	30	-2.88	Pass
11b	1Mbps	1	6	2437	0.06	11.91	30	-2.88	Pass
11b	1Mbps	1	11	2462	0.06	12.43	30	-2.88	Pass
11g	6Mbps	1	1	2412	0.50	7.73	30	-2.88	Pass
11g	6Mbps	1	6	2437	0.50	8.05	30	-2.88	Pass
11g	6Mbps	1	11	2462	0.50	8.46	30	-2.88	Pass
HT20	MCS0	1	1	2412	0.54	6.78	30	-2.88	Pass
HT20	MCS0	1	6	2437	0.54	7.16	30	-2.88	Pass
HT20	MCS0	1	11	2462	0.54	7.59	30	-2.88	Pass
HT40	MCS0	1	3	2422	1.00	6.75	30	-2.88	Pass
HT40	MCS0	1	6	2437	1.00	7.16	30	-2.88	Pass
VHT40	MCS0	1	9	2452	1.00	7.42	30	-2.88	Pass

Note: Measured power (dBm) has offset with cable loss and duty factor.

### 3.3 Power Spectral Density Measurement

#### 3.3.1 Limit of Power Spectral Density

The peak power spectral density shall not be greater than 8dBm in any 3kHz band at any time interval of continuous transmission.

#### 3.3.2 Measuring Instruments

The measuring equipment is listed in the section 4 of this test report.

#### 3.3.3 Test Procedures

1. The testing follows Measurement Procedure 10.2 Method PKPSD of FCC KDB Publication No. 558074 D01 DTS Meas. Guidance v03r01
2. The RF output of EUT was connected to the spectrum analyzer by RF cable and attenuator. The path loss was compensated to the results for each measurement.
3. Set to the maximum power setting and enable the EUT transmit continuously.
4. Make the measurement with the spectrum analyzer's resolution bandwidth (RBW) = 3 kHz. Video bandwidth VBW = 10 kHz In order to make an accurate measurement, set the span to 1.5 times DTS Channel Bandwidth. (6dB BW)
5. Detector = peak, Sweep time = auto couple, Trace mode = max hold, Allow trace to fully stabilize. Use the peak marker function to determine the maximum power level.
6. Measure and record the results in the test report.

#### 3.3.4 Test Setup

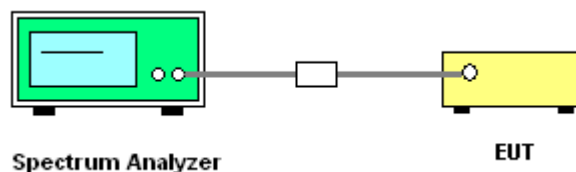

### 3.3.5 Test Result of Power Spectral Density

Test Mode :	2.4GHz	Temperature :	24~26°C
Test Engineer :	Blithe Li	Relative Humidity :	50~53%

Mod.	Data Rate	N <sub>TX</sub>	Channel	Freq. (MHz)	Peak Power Density (dBm/3kHz)	Max. Limits (dBm/3kHz)	DG (dBi)	Pass/Fail
11b	1Mbps	1	1	2412	-11.21	8	-2.88	Pass
11b	1Mbps	1	6	2437	-11.80	8	-2.88	Pass
11b	1Mbps	1	11	2462	-9.83	8	-2.88	Pass
11g	6Mbps	1	1	2412	-18.16	8	-2.88	Pass
11g	6Mbps	1	6	2437	-18.21	8	-2.88	Pass
11g	6Mbps	1	11	2462	-16.84	8	-2.88	Pass
HT20	MCS0	1	1	2412	-19.09	8	-2.88	Pass
HT20	MCS0	1	6	2437	-18.76	8	-2.88	Pass
HT20	MCS0	1	11	2462	-19.42	8	-2.88	Pass
HT40	MCS0	1	3	2422	-22.42	8	-2.88	Pass
HT40	MCS0	1	6	2437	-21.13	8	-2.88	Pass
HT40	MCS0	1	9	2452	-22.05	8	-2.88	Pass

Note: Measured power density (dBm) has offset with cable loss.

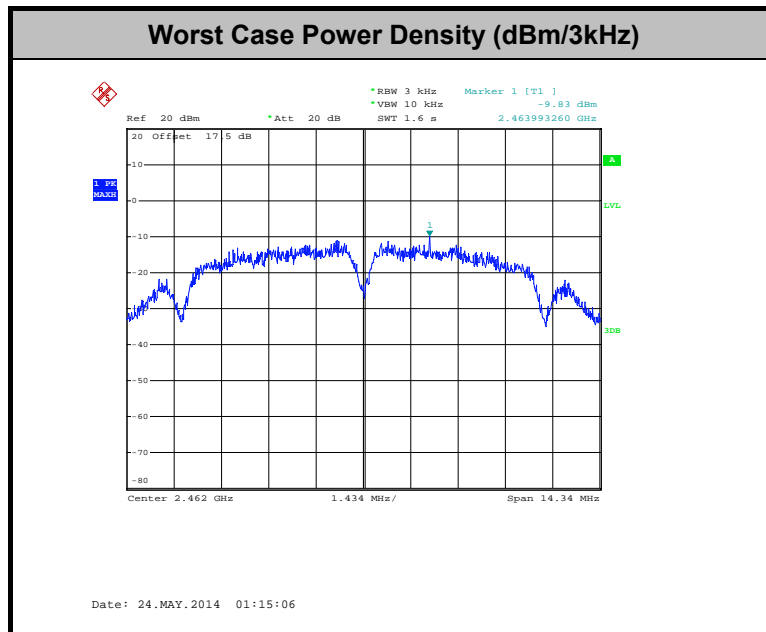

## 3.4 Conducted Band Edges and Spurious Emission Measurement

### 3.4.1 Limit of Conducted Band Edges and Spurious Emission Measurement

In any 100 kHz bandwidth outside of the authorized frequency band, the emissions which fall in the non-restricted bands shall be attenuated at least 20 dB / 30dB relative to the maximum PSD level in 100 kHz by RF conducted measurement and radiated emissions which fall in the restricted bands, as defined in Section 15.205(a), must also comply with the radiated emission limits specified in Section 15.209(a).

### 3.4.2 Measuring Instruments

The measuring equipment is listed in the section 4 of this test report.

### 3.4.3 Test Procedures

1. The testing follows FCC KDB Publication No. 558074 D01 DTS Meas. Guidance v03r01.
2. The RF output of EUT was connected to the spectrum analyzer by RF cable and attenuator. The path loss was compensated to the results for each measurement.
3. Set to the maximum power setting and enable the EUT transmit continuously.
4. Set RBW = 100 kHz, VBW=300 kHz, Peak Detector. Unwanted Emissions measured in any 100 kHz bandwidth outside of the authorized frequency band shall be attenuated by at least 20 dB relative to the maximum in-band peak PSD level in 100 kHz when maximum peak conducted output power procedure is used. If the transmitter complies with the conducted power limits based on the use of RMS averaging over a time interval, the attenuation required under this paragraph shall be 30 dB instead of 20 dB per 15.247(d).
5. Measure and record the results in the test report.
6. The RF fundamental frequency should be excluded against the limit line in the operating frequency band.

### 3.4.4 Test Setup

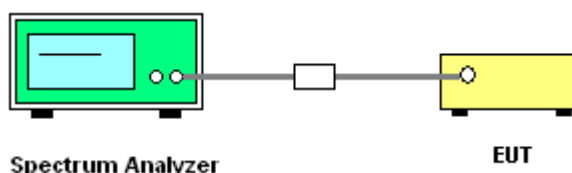



3.4.5 Test Result of Conducted Band Edges and Spurious Emission

Test Mode :	802.11b	Temperature :	24~26°C
Test Band :	2.4GHz Low	Relative Humidity :	50~53%
Test Channel :	01	Test Engineer :	Blithe Li

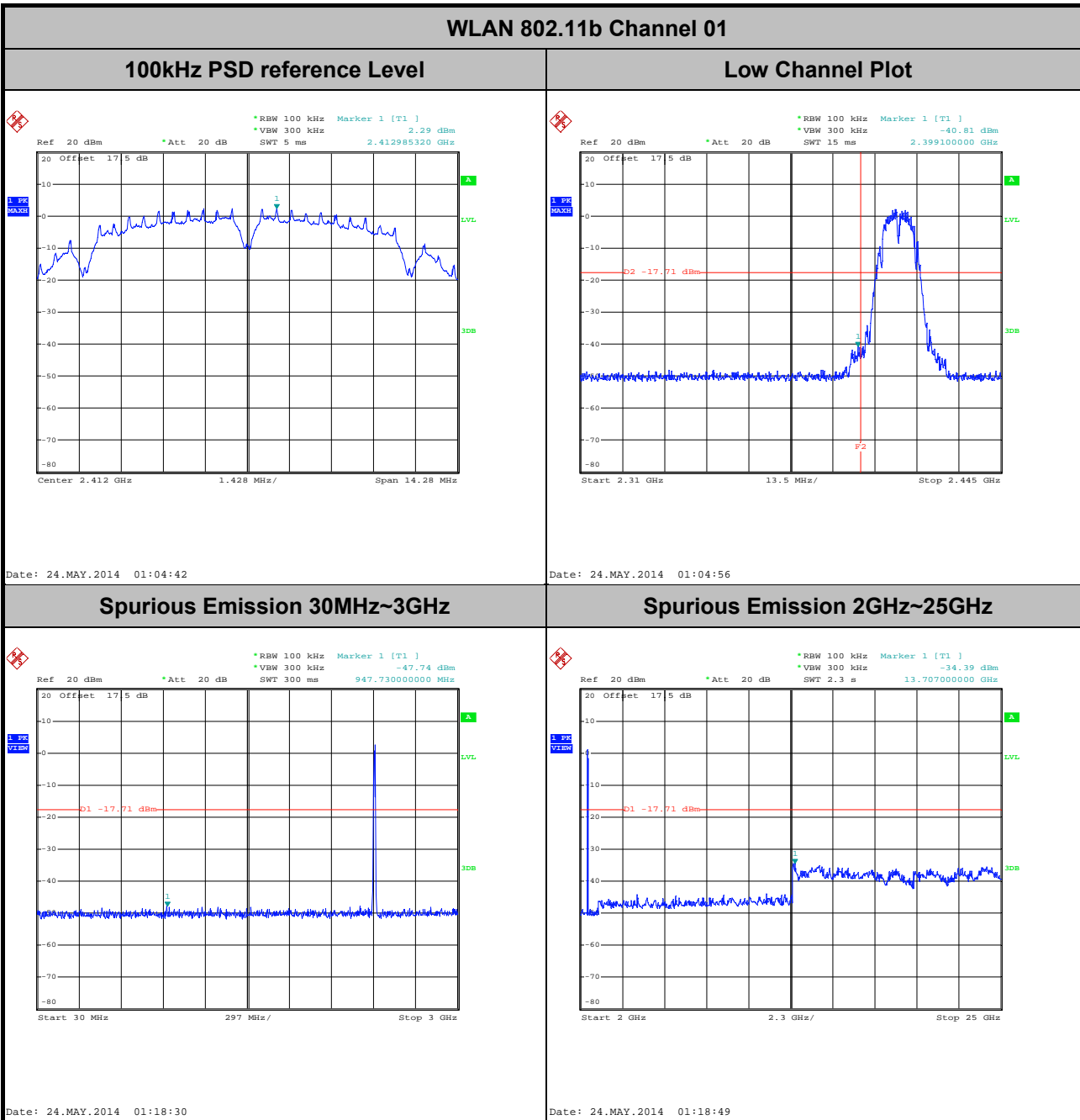



Test Mode :	802.11b	Temperature :	24~26°C
Test Band :	2.4GHz Mid	Relative Humidity :	50~53%
Test Channel :	06	Test Engineer :	Blithe Li

WLAN 802.11b Channel 06

100kHz PSD reference Level

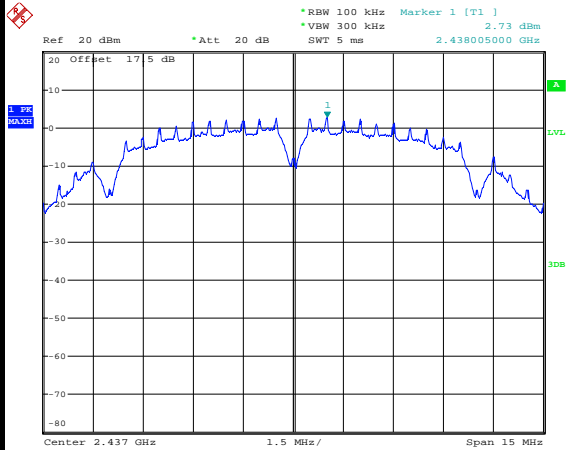

Date: 24.MAY.2014 01:11:05

Spurious Emission 30MHz~3GHz

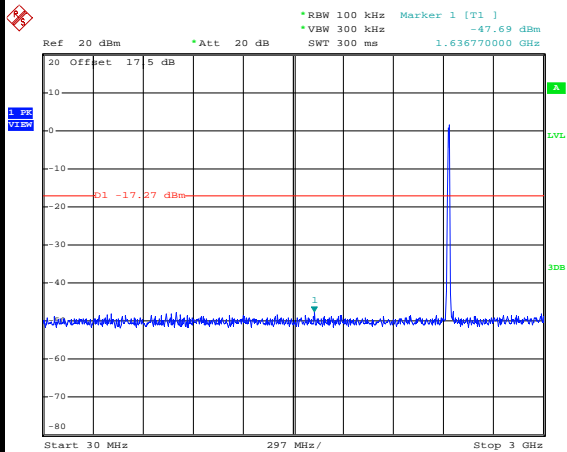

Date: 24.MAY.2014 01:20:03

Spurious Emission 2GHz~25GHz

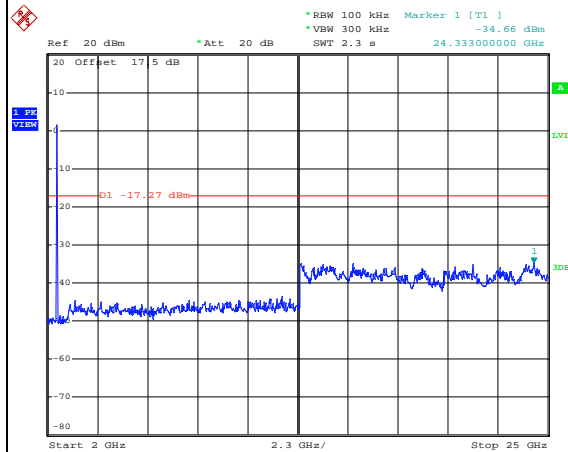

Date: 24.MAY.2014 01:20:22



Test Mode :	802.11b	Temperature :	24~26°C
Test Band :	2.4GHz High	Relative Humidity :	50~53%
Test Channel :	11	Test Engineer :	Blithe Li

WLAN 802.11b Channel 11

100kHz PSD reference Level

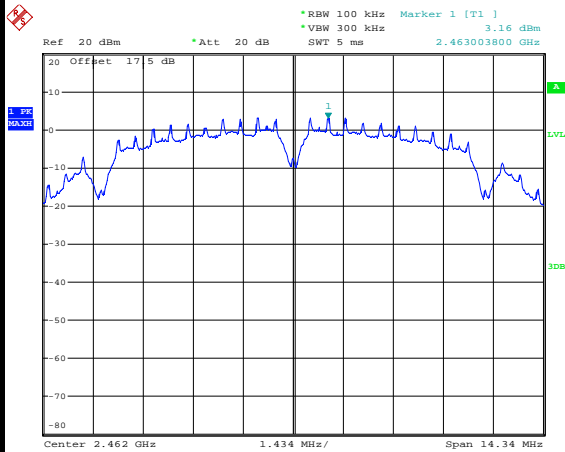

Date: 24.MAY.2014 01:15:15

High Channel Plot

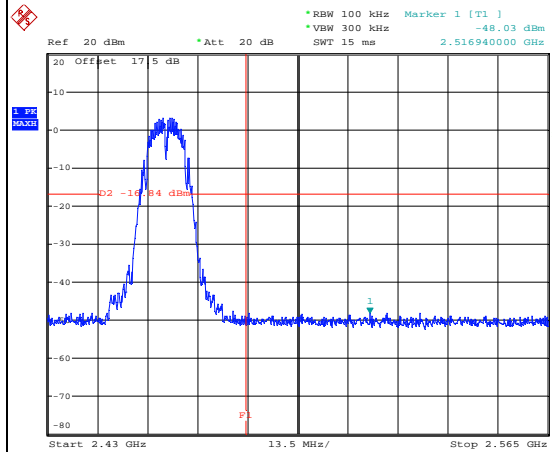

Date: 24.MAY.2014 01:15:28

Spurious Emission 30MHz~3GHz

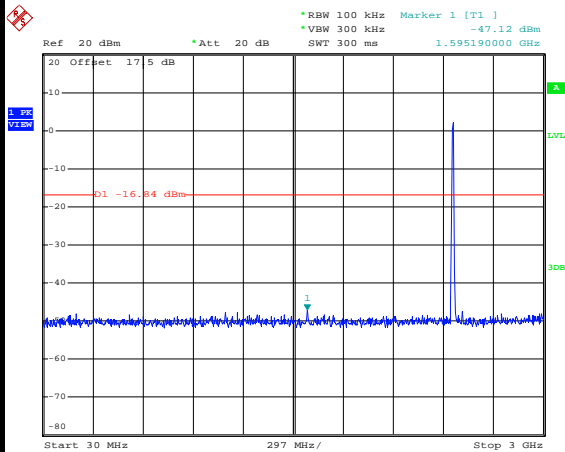

Date: 24.MAY.2014 01:15:48

Spurious Emission 2GHz~25GHz

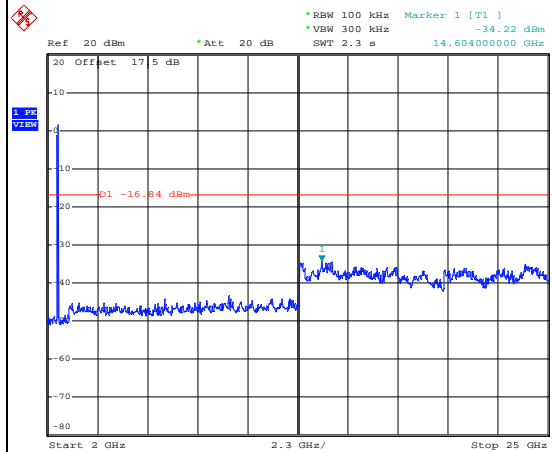

Date: 24.MAY.2014 01:16:06



Test Mode :	802.11g	Temperature :	24~26°C
Test Band :	2.4GHz Low	Relative Humidity :	50~53%
Test Channel :	01	Test Engineer :	Blithe Li

WLAN 802.11g Channel 01

100kHz PSD reference Level

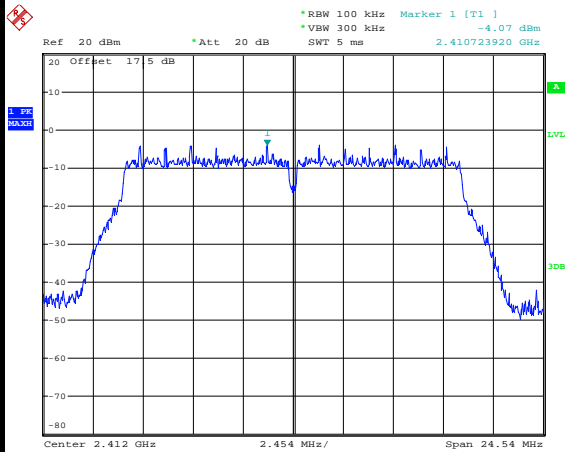

Date: 24.MAY.2014 01:22:37

Low Channel Plot

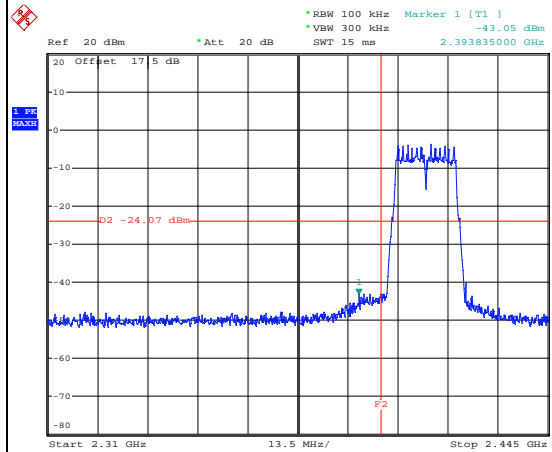

Date: 24.MAY.2014 01:22:51

Spurious Emission 30MHz~3GHz

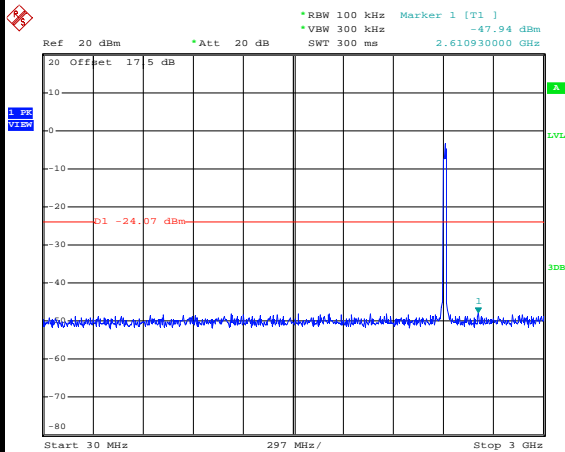

Date: 24.MAY.2014 01:23:10

Spurious Emission 2GHz~25GHz

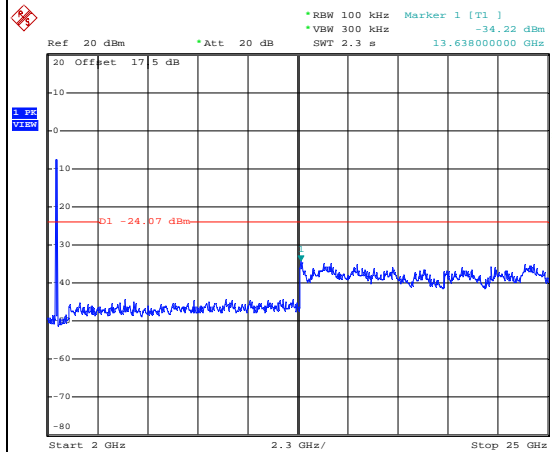

Date: 24.MAY.2014 01:23:29





Test Mode :	802.11g	Temperature :	24~26°C
Test Band :	2.4GHz Mid	Relative Humidity :	50~53%
Test Channel :	06	Test Engineer :	Blithe Li

WLAN 802.11g Channel 06

100kHz PSD reference Level

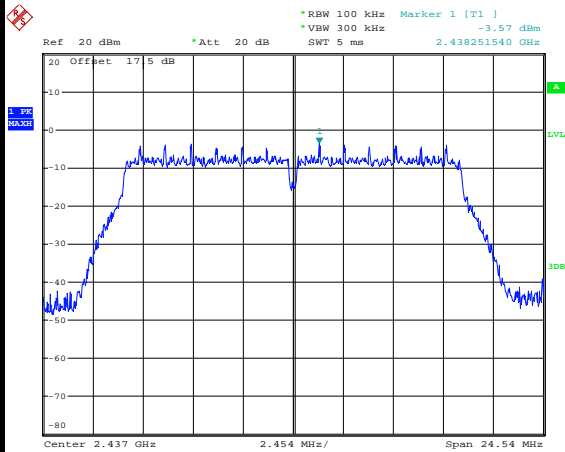

Date: 24.MAY.2014 01:26:05

Spurious Emission 30MHz~3GHz

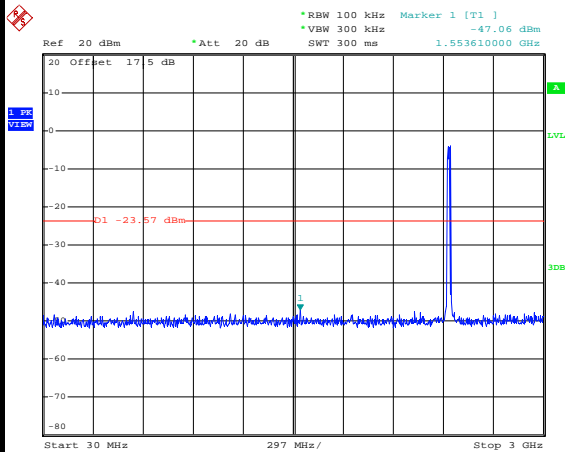

Date: 24.MAY.2014 01:27:23

Spurious Emission 2GHz~25GHz

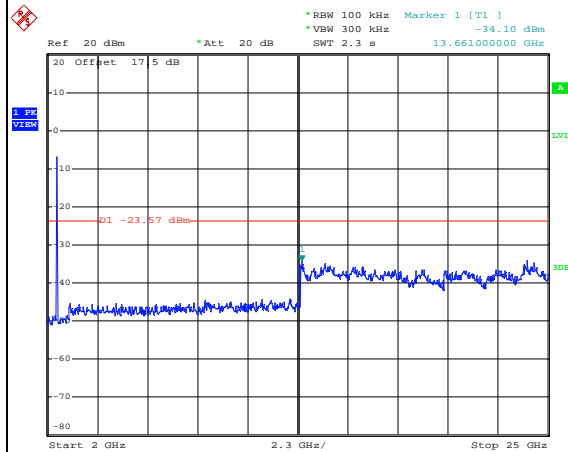

Date: 24.MAY.2014 01:27:42



Test Mode :	802.11g	Temperature :	24~26°C
Test Band :	2.4GHz High	Relative Humidity :	50~53%
Test Channel :	11	Test Engineer :	Blithe Li

WLAN 802.11g Channel 11

100kHz PSD reference Level

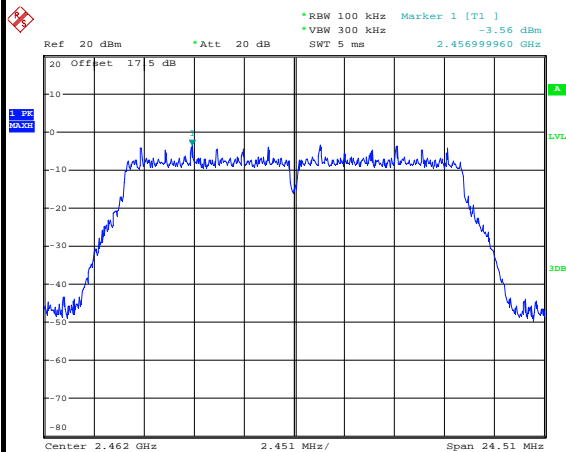

Date: 24.MAY.2014 01:30:17

High Channel Plot

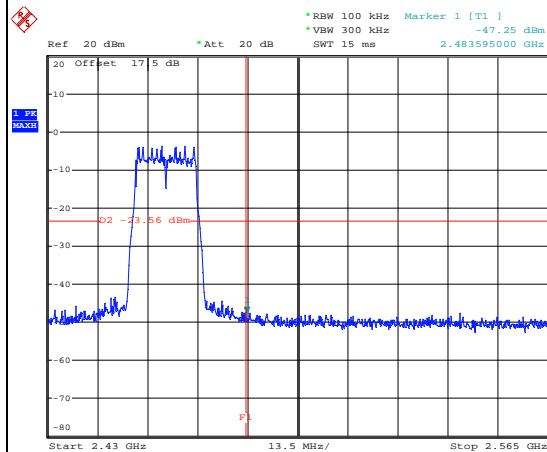

Date: 24.MAY.2014 01:30:31

Spurious Emission 30MHz~3GHz

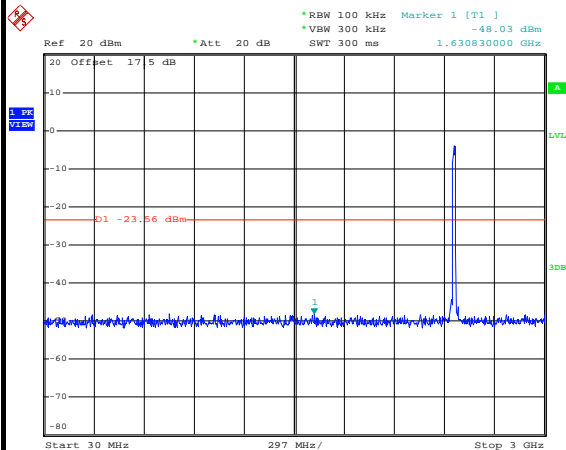

Date: 24.MAY.2014 01:31:46

Spurious Emission 2GHz~25GHz

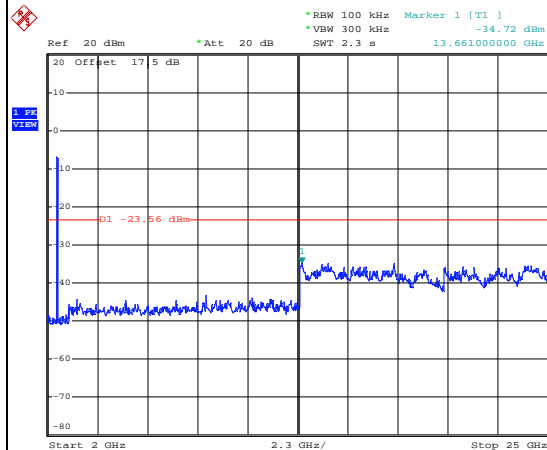

Date: 24.MAY.2014 01:32:04



Test Mode :	802.11n HT20	Temperature :	24~26°C
Test Band :	2.4GHz Low	Relative Humidity :	50~53%
Test Channel :	01	Test Engineer :	Blithe Li

WLAN 802.11n HT20 Channel 01

100kHz PSD reference Level

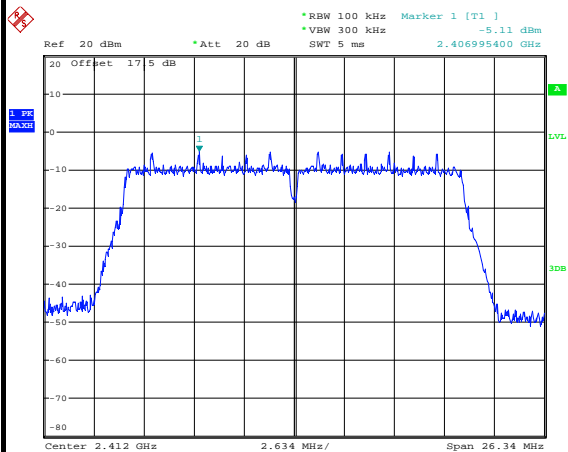

Date: 24.MAY.2014 01:35:03

Low Channel Plot

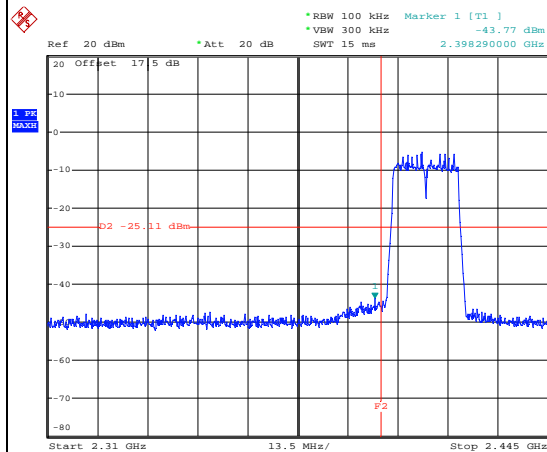

Date: 24.MAY.2014 01:35:17

Spurious Emission 30MHz~3GHz

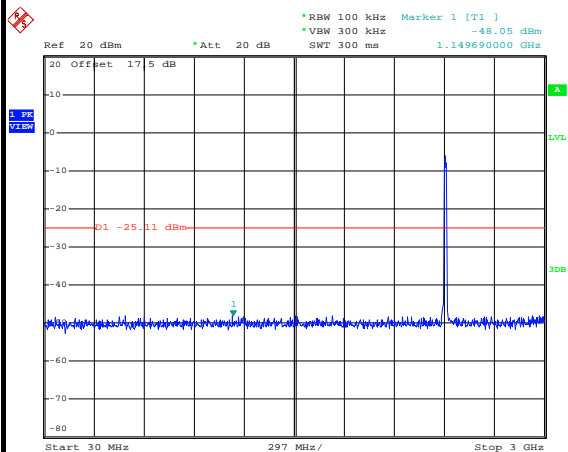

Date: 24.MAY.2014 01:35:36

Spurious Emission 2GHz~25GHz

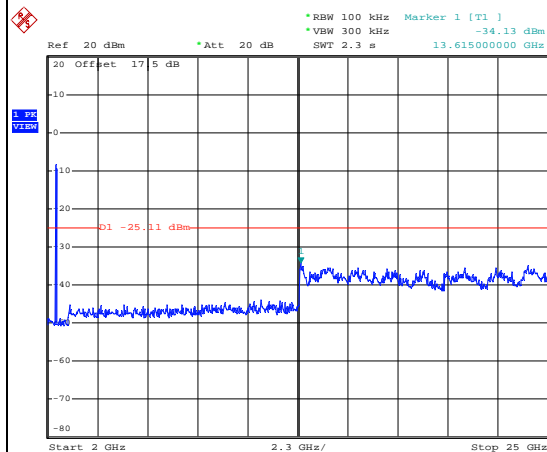

Date: 24.MAY.2014 01:35:55



Test Mode :	802.11n HT20	Temperature :	24~26°C
Test Band :	2.4GHz Mid	Relative Humidity :	50~53%
Test Channel :	06	Test Engineer :	Blithe Li

WLAN 802.11n HT20 Channel 06

100kHz PSD reference Level

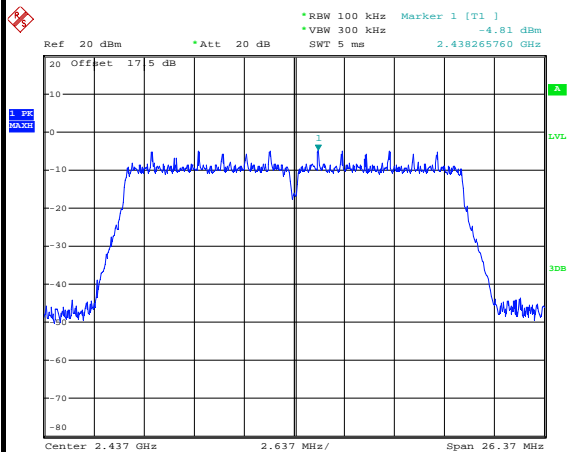

Date: 24.MAY.2014 01:38:34

Spurious Emission 30MHz~3GHz

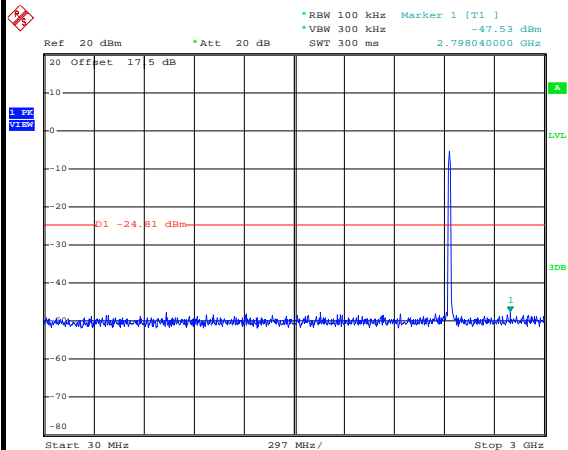

Date: 24.MAY.2014 01:38:54

Spurious Emission 2GHz~25GHz

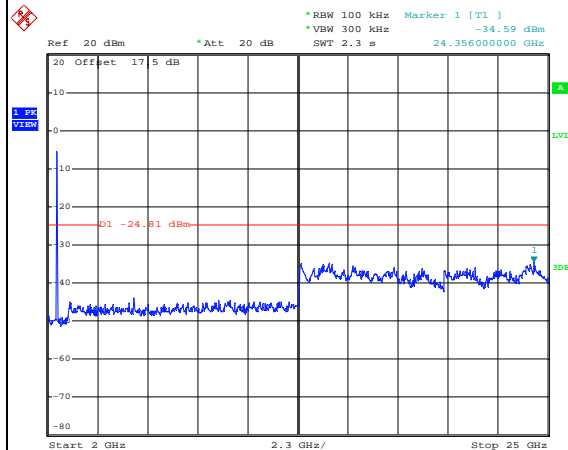

Date: 24.MAY.2014 01:39:13



Test Mode :	802.11n HT20	Temperature :	24~26°C
Test Band :	2.4GHz High	Relative Humidity :	50~53%
Test Channel :	11	Test Engineer :	Blithe Li

WLAN 802.11n HT20 Channel 11

100kHz PSD reference Level

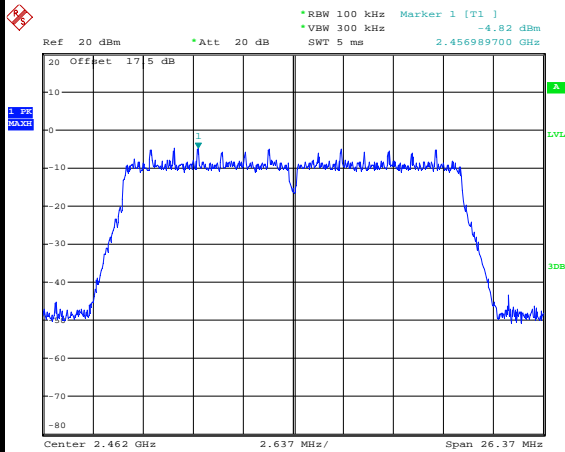

Date: 24.MAY.2014 01:45:19

High Channel Plot

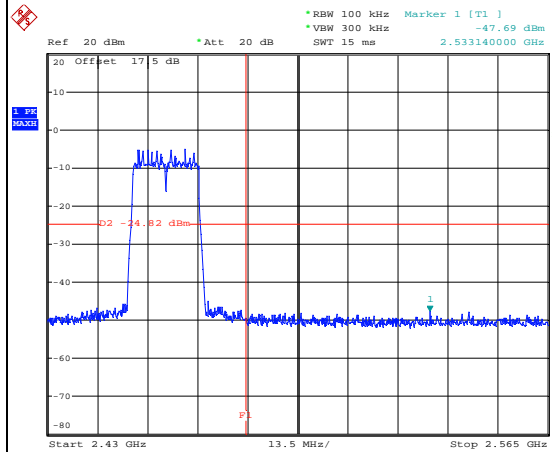

Date: 24.MAY.2014 01:45:33

Spurious Emission 30MHz~3GHz

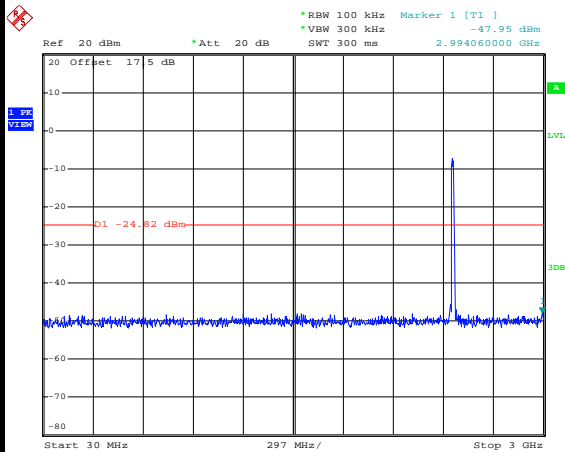

Date: 24.MAY.2014 01:45:53

Spurious Emission 2GHz~25GHz

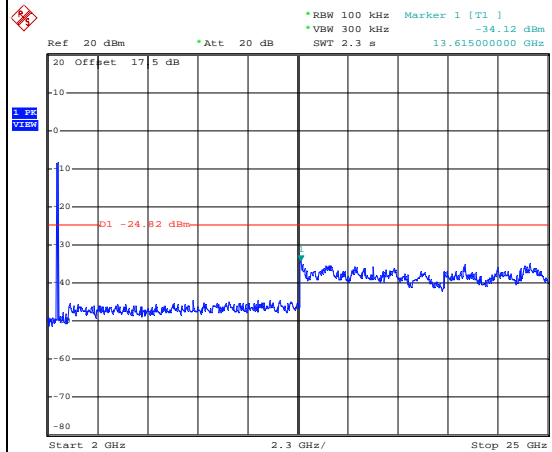

Date: 24.MAY.2014 01:46:11



Test Mode :	802.11n HT40	Temperature :	24~26°C
Test Band :	2.4GHz Low	Relative Humidity :	50~53%
Test Channel :	03	Test Engineer :	Blithe Li

WLAN 802.11n HT40 Channel 03

100kHz PSD reference Level

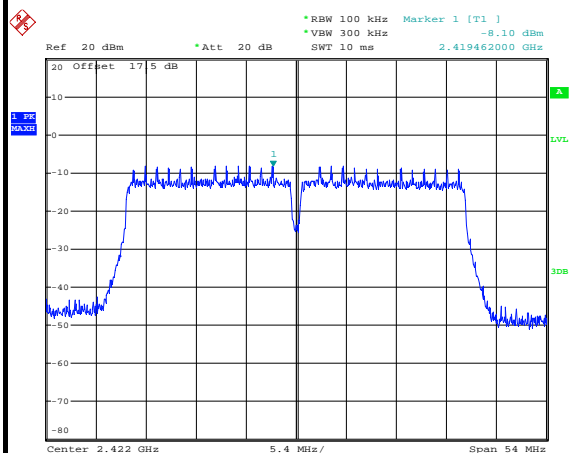

Date: 24.MAY.2014 02:01:23

Low Channel Plot

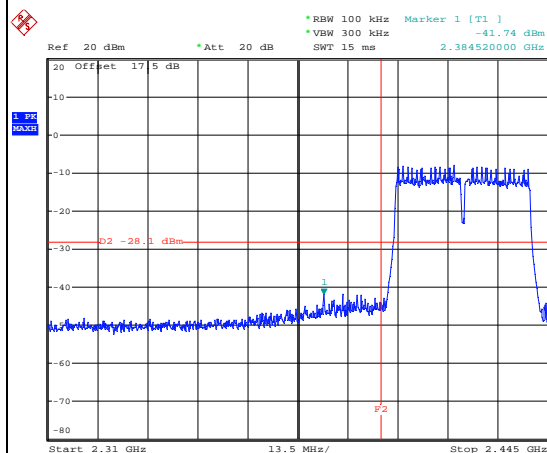

Date: 24.MAY.2014 02:01:37

Spurious Emission 30MHz~3GHz

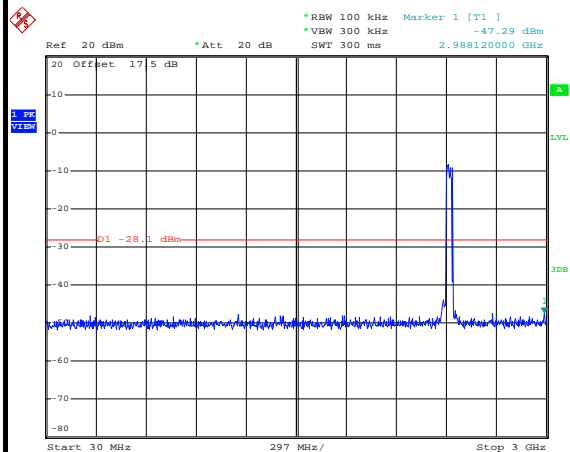

Date: 24.MAY.2014 02:03:52

Spurious Emission 2GHz~25GHz

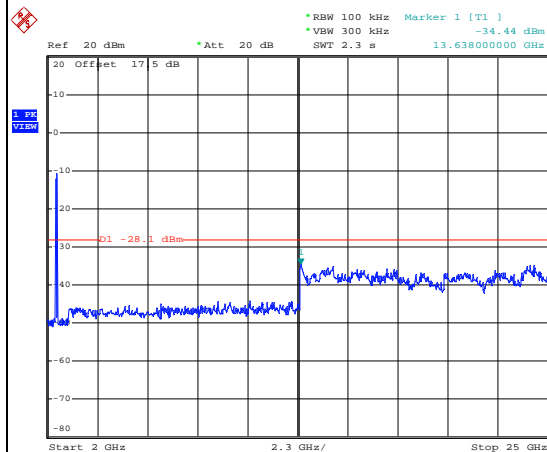

Date: 24.MAY.2014 02:04:11



Test Mode :	802.11n HT40	Temperature :	24~26°C
Test Band :	2.4GHz Mid	Relative Humidity :	50~53%
Test Channel :	06	Test Engineer :	Blithe Li

WLAN 802.11n HT40 Channel 06

100kHz PSD reference Level

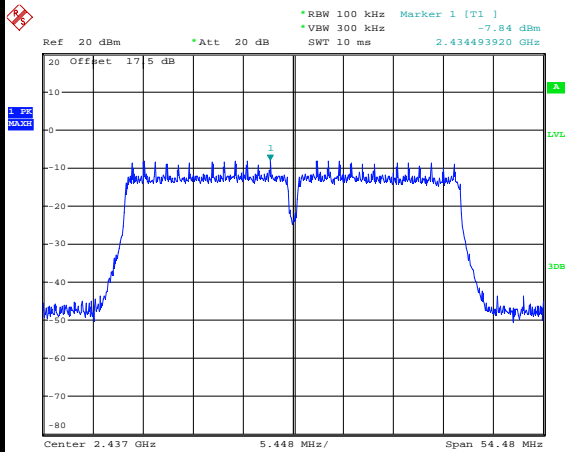

Date: 24.MAY.2014 02:06:47

Spurious Emission 30MHz~3GHz

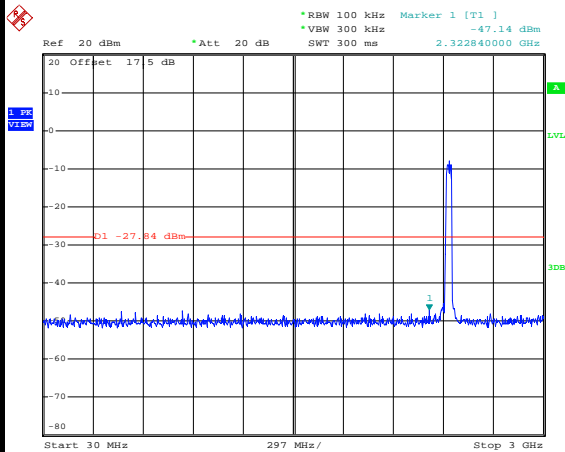

Date: 24.MAY.2014 02:09:08

Spurious Emission 2GHz~25GHz

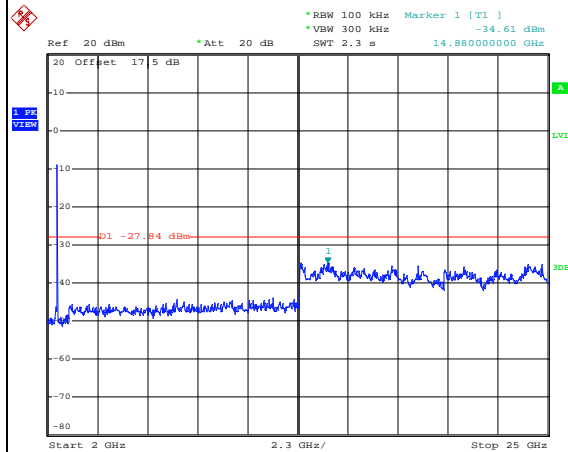

Date: 24.MAY.2014 02:09:26



Test Mode :	802.11n HT40	Temperature :	24~26°C
Test Band :	2.4GHz High	Relative Humidity :	50~53%
Test Channel :	09	Test Engineer :	Blithe Li

WLAN 802.11n HT40 Channel 09

100kHz PSD reference Level

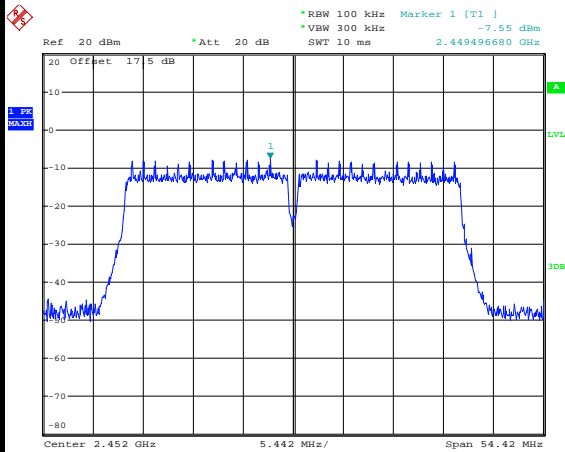

Date: 24.MAY.2014 02:11:53

High Channel Plot

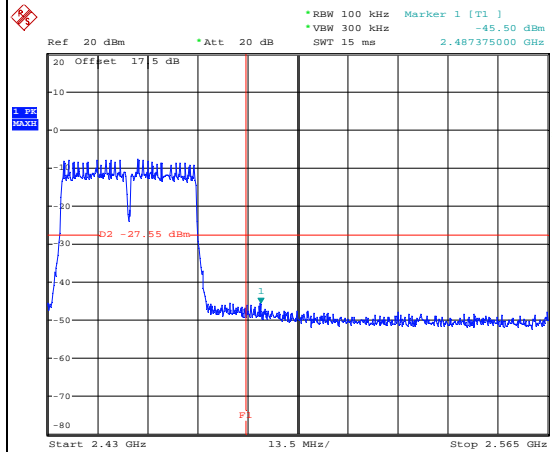

Date: 24.MAY.2014 02:12:07

Spurious Emission 30MHz~3GHz

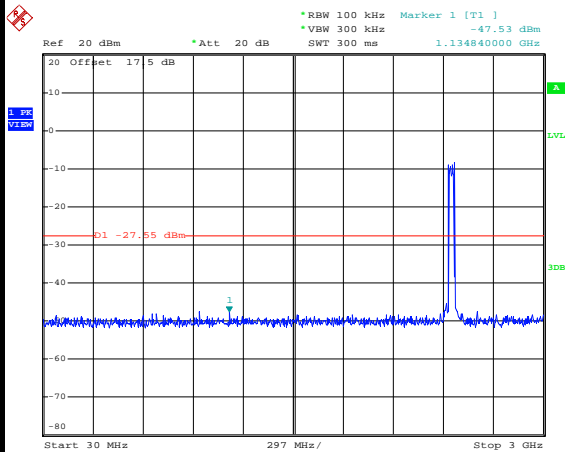

Date: 24.MAY.2014 02:13:30

Spurious Emission 2GHz~25GHz

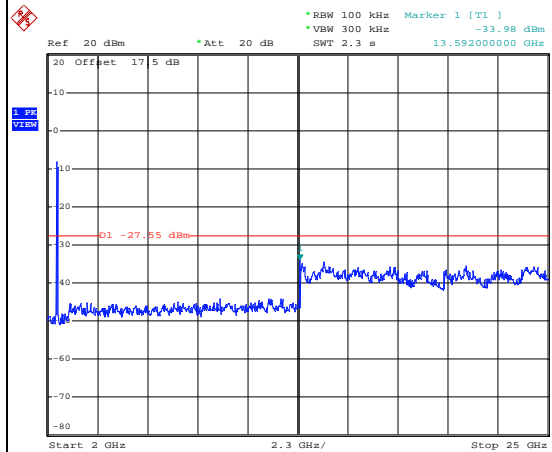

Date: 24.MAY.2014 02:13:48



### 3.5 Radiated Band Edges and Spurious Emission Measurement

#### 3.5.1 Limit of Radiated band edge and Spurious Emission Measurement

In any 100 kHz bandwidth outside the intentional radiator frequency band, all harmonics/spurious must be at least 20 dB below the highest emission level within the authorized band. If the output power of this device was measured by spectrum analyzer, the attenuation under this paragraph shall be 30 dB instead of 20 dB. In addition, radiated emissions which fall in the restricted bands must also comply with the FCC section 15.209 limits as below.

Frequency (MHz)	Field Strength (microvolts/meter)	Measurement Distance (meters)
0.009 – 0.490	2400/F(kHz)	300
0.490 – 1.705	24000/F(kHz)	30
1.705 – 30.0	30	30
30 – 88	100	3
88 – 216	150	3
216 - 960	200	3
Above 960	500	3

#### 3.5.2 Measuring Instruments

The measuring equipment is listed in the section 4 of this test report.

**3.5.3 Test Procedures**

1. The testing follows FCC KDB Publication No. 558074 D01 DTS Meas. Guidance v03r01.
2. The EUT was arranged to its worst case and then tune the antenna tower (from 1 m to 4 m) and turntable (from 0 degree to 360 degrees) to find the maximum reading. A pre-amp and a high pass filter are used for the test in order to get better signal level.
3. The EUT was placed on a turntable with 0.8 meter above ground.
4. The EUT was set 3 meters from the interference receiving antenna, which was mounted on the top of a variable height antenna tower.
5. Corrected Reading: Antenna Factor + Cable Loss + Read Level - Preamp Factor = Level
6. For measurement below 1GHz, If the emission level of the EUT measured by the peak detector is 3 dB lower than the applicable limit, the peak emission level will be reported. Otherwise, the emission measurement will be repeated using the quasi-peak detector and reported.
7. Use the following spectrum analyzer settings:
  - (1) Span shall wide enough to fully capture the emission being measured;
  - (2) Set RBW=100 kHz for  $f < 1$  GHz;  $VBW \geq RBW$ ; Sweep = auto; Detector function = peak; Trace = max hold;
  - (3) Set RBW = 1 MHz, VBW= 3MHz for  $f \geq 1$  GHz for peak measurement.  
 For average measurement:
    - $VBW = 10$  Hz, when duty cycle is no less than 98 percent.
    - $VBW \geq 1/T$ , when duty cycle is less than 98 percent where T is the minimum transmission duration over which the transmitter is on and is transmitting at its maximum power control level for the tested mode of operation.

Band	Duty Cycle(%)	T(ms)	1/T(kHz)	VBW Setting
802.11b	98.595	-	-	10Hz
802.11g	89.186	1.402	0.713	1kHz
2.4GHz 802.11n HT20	88.347	1.304	0.767	1kHz
2.4GHz 802.11n HT40	79.369	0.654	1.529	3kHz

### 3.5.4 Test Setup

For radiated emissions below 30MHz

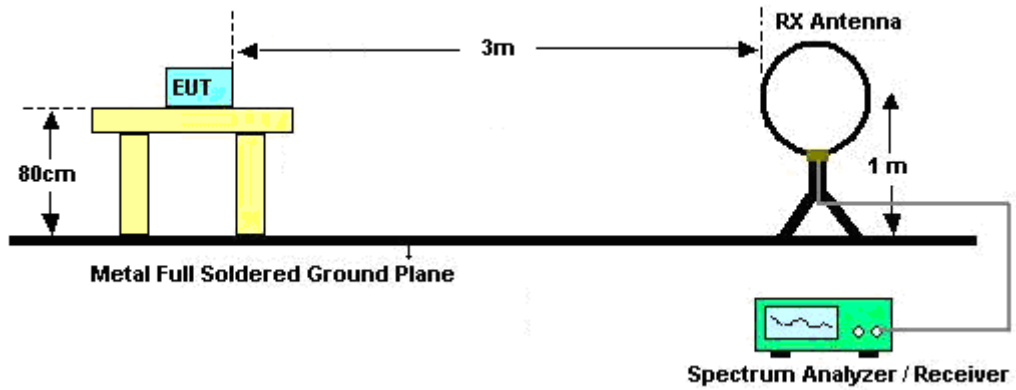

For radiated emissions from 30MHz to 1GHz

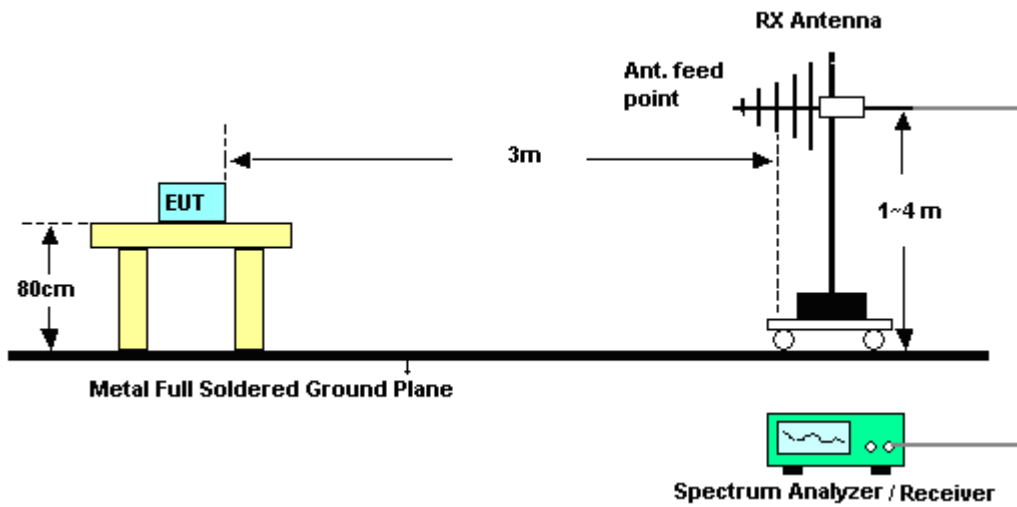

For radiated emissions above 1GHz

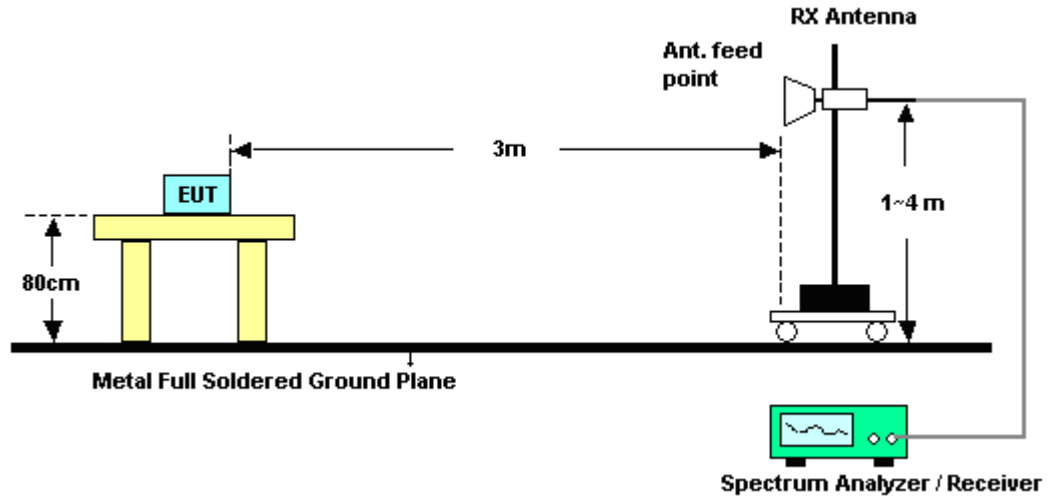

### 3.5.5 Test Results of Radiated Spurious Emissions (9kHz ~ 30MHz)

The low frequency, which started from 9 kHz to 30MHz, was pre-scanned and the result which was 20dB lower than the limit line per 15.31(o) was not reported.

3.5.6 Test Result of Radiated Spurious at Band Edges

<Sample 1>

Test Mode :	802.11b	Temperature :	24~25°C
Test Band :	Low	Relative Humidity :	48~49%
Test Channel :	01	Test Engineer :	Leo Liao

ANTENNA POLARITY : HORIZONTAL										
Frequency ( MHz )	Level ( dBµV/m )	Over Limit ( dB )	Limit Line ( dBµV/m )	Read Level ( dBµV )	Antenna Factor ( dB )	Cable Loss ( dB )	Preamp Factor ( dB )	Ant Pos ( cm )	Table Pos ( deg )	Remark
2386.86	55.89	-18.11	74	48.11	31.98	5.59	29.79	100	187	Peak
2387.31	39.74	-14.26	54	31.96	31.98	5.59	29.79	100	187	Average

ANTENNA POLARITY : VERTICAL										
Frequency ( MHz )	Level ( dBµV/m )	Over Limit ( dB )	Limit Line ( dBµV/m )	Read Level ( dBµV )	Antenna Factor ( dB )	Cable Loss ( dB )	Preamp Factor ( dB )	Ant Pos ( cm )	Table Pos ( deg )	Remark
2389.83	48.26	-25.74	74	40.44	31.98	5.62	29.78	100	188	Peak
2387.4	35.99	-18.01	54	28.21	31.98	5.59	29.79	100	188	Average

Test Mode :	802.11b	Temperature :	24~25°C
Test Band :	High	Relative Humidity :	48~49%
Test Channel :	11	Test Engineer :	Leo Liao

ANTENNA POLARITY : HORIZONTAL										
Frequency ( MHz )	Level ( dBµV/m )	Over Limit ( dB )	Limit Line ( dBµV/m )	Read Level ( dBµV )	Antenna Factor ( dB )	Cable Loss ( dB )	Preamp Factor ( dB )	Ant Pos ( cm )	Table Pos ( deg )	Remark
2493.46	58.26	-15.74	74	49.77	32.5	5.74	29.75	103	230	Peak
2483.89	45.17	-8.83	54	36.81	32.41	5.71	29.76	103	230	Average

ANTENNA POLARITY : VERTICAL										
Frequency ( MHz )	Level ( dBµV/m )	Over Limit ( dB )	Limit Line ( dBµV/m )	Read Level ( dBµV )	Antenna Factor ( dB )	Cable Loss ( dB )	Preamp Factor ( dB )	Ant Pos ( cm )	Table Pos ( deg )	Remark
2483.89	53.36	-20.64	74	45	32.41	5.71	29.76	128	286	Peak
2483.86	39.75	-14.25	54	31.39	32.41	5.71	29.76	128	286	Average



Test Mode :	802.11g	Temperature :	24~25°C
Test Band :	Low	Relative Humidity :	48~49%
Test Channel :	01	Test Engineer :	Leo Liao

ANTENNA POLARITY : HORIZONTAL										
Frequency ( MHz )	Level ( dBμV/m )	Over Limit ( dB )	Limit Line ( dBμV/m )	Read Level ( dBμV )	Antenna Factor ( dB )	Cable Loss ( dB )	Preamp Factor ( dB )	Ant Pos ( cm )	Table Pos ( deg )	Remark
2389.02	62.85	-11.15	74	55.07	31.98	5.59	29.79	100	235	Peak
2389.74	49	-5	54	41.22	31.98	5.59	29.79	100	235	Average

ANTENNA POLARITY : VERTICAL										
Frequency ( MHz )	Level ( dBμV/m )	Over Limit ( dB )	Limit Line ( dBμV/m )	Read Level ( dBμV )	Antenna Factor ( dB )	Cable Loss ( dB )	Preamp Factor ( dB )	Ant Pos ( cm )	Table Pos ( deg )	Remark
2389.83	61.27	-12.73	74	53.45	31.98	5.62	29.78	100	338	Peak
2389.83	46.4	-7.6	54	38.58	31.98	5.62	29.78	100	338	Average

Test Mode :	802.11g	Temperature :	24~25°C
Test Band :	High	Relative Humidity :	48~49%
Test Channel :	11	Test Engineer :	Leo Liao

ANTENNA POLARITY : HORIZONTAL										
Frequency ( MHz )	Level ( dBμV/m )	Over Limit ( dB )	Limit Line ( dBμV/m )	Read Level ( dBμV )	Antenna Factor ( dB )	Cable Loss ( dB )	Preamp Factor ( dB )	Ant Pos ( cm )	Table Pos ( deg )	Remark
2485.33	67.55	-6.45	74	59.19	32.41	5.71	29.76	100	242	Peak
2483.53	50.79	-3.21	54	42.43	32.41	5.71	29.76	100	242	Average

ANTENNA POLARITY : VERTICAL										
Frequency ( MHz )	Level ( dBμV/m )	Over Limit ( dB )	Limit Line ( dBμV/m )	Read Level ( dBμV )	Antenna Factor ( dB )	Cable Loss ( dB )	Preamp Factor ( dB )	Ant Pos ( cm )	Table Pos ( deg )	Remark
2487.58	67.17	-6.83	74	58.72	32.5	5.71	29.76	100	342	Peak
2484.67	47.47	-6.53	54	39.11	32.41	5.71	29.76	100	342	Average



Test Mode :	802.11n HT20	Temperature :	24~25°C
Test Band :	Low	Relative Humidity :	48~49%
Test Channel :	01	Test Engineer :	Leo Liao

ANTENNA POLARITY : HORIZONTAL										
Frequency ( MHz )	Level ( dBμV/m )	Over Limit ( dB )	Limit Line ( dBμV/m )	Read Level ( dBμV )	Antenna Factor ( dB )	Cable Loss ( dB )	Preamp Factor ( dB )	Ant Pos ( cm )	Table Pos ( deg )	Remark
2389.74	63.22	-10.78	74	55.44	31.98	5.59	29.79	100	240	Peak
2389.83	49.98	-4.02	54	42.16	31.98	5.62	29.78	100	240	Average

ANTENNA POLARITY : VERTICAL										
Frequency ( MHz )	Level ( dBμV/m )	Over Limit ( dB )	Limit Line ( dBμV/m )	Read Level ( dBμV )	Antenna Factor ( dB )	Cable Loss ( dB )	Preamp Factor ( dB )	Ant Pos ( cm )	Table Pos ( deg )	Remark
2389.65	61.93	-12.07	74	54.15	31.98	5.59	29.79	100	346	Peak
2389.92	47.72	-6.28	54	39.9	31.98	5.62	29.78	100	346	Average

Test Mode :	802.11n HT20	Temperature :	24~25°C
Test Band :	High	Relative Humidity :	48~49%
Test Channel :	11	Test Engineer :	Leo Liao

ANTENNA POLARITY : HORIZONTAL										
Frequency ( MHz )	Level ( dBμV/m )	Over Limit ( dB )	Limit Line ( dBμV/m )	Read Level ( dBμV )	Antenna Factor ( dB )	Cable Loss ( dB )	Preamp Factor ( dB )	Ant Pos ( cm )	Table Pos ( deg )	Remark
2483.83	62.71	-11.29	74	54.35	32.41	5.71	29.76	100	187	Peak
2483.62	49.6	-4.4	54	41.24	32.41	5.71	29.76	100	187	Average

ANTENNA POLARITY : VERTICAL										
Frequency ( MHz )	Level ( dBμV/m )	Over Limit ( dB )	Limit Line ( dBμV/m )	Read Level ( dBμV )	Antenna Factor ( dB )	Cable Loss ( dB )	Preamp Factor ( dB )	Ant Pos ( cm )	Table Pos ( deg )	Remark
2484.25	67.55	-6.45	74	59.19	32.41	5.71	29.76	100	349	Peak
2483.8	47.33	-6.67	54	38.97	32.41	5.71	29.76	100	349	Average



Test Mode :	802.11n HT40	Temperature :	24~25°C
Test Band :	Low	Relative Humidity :	48~49%
Test Channel :	03	Test Engineer :	Leo Liao

ANTENNA POLARITY : HORIZONTAL										
Frequency ( MHz )	Level ( dBμV/m )	Over Limit ( dB )	Limit Line ( dBμV/m )	Read Level ( dBμV )	Antenna Factor ( dB )	Cable Loss ( dB )	Preamp Factor ( dB )	Ant Pos ( cm )	Table Pos ( deg )	Remark
2379.3	63.83	-10.17	74	56.13	31.9	5.59	29.79	155	145	Peak
2385.51	49.83	-4.17	54	42.05	31.98	5.59	29.79	155	145	Average
2483.56	65.17	-8.83	74	56.81	32.41	5.71	29.76	155	145	Peak
2487.94	42.26	-11.74	54	33.81	32.5	5.71	29.76	155	145	Average

ANTENNA POLARITY : VERTICAL										
Frequency ( MHz )	Level ( dBμV/m )	Over Limit ( dB )	Limit Line ( dBμV/m )	Read Level ( dBμV )	Antenna Factor ( dB )	Cable Loss ( dB )	Preamp Factor ( dB )	Ant Pos ( cm )	Table Pos ( deg )	Remark
2379.03	60.49	-13.51	74	52.79	31.9	5.59	29.79	195	284	Peak
2385.42	45.74	-8.26	54	38.04	31.9	5.59	29.79	195	284	Average
2487.34	59.86	-14.14	74	51.5	32.41	5.71	29.76	195	284	Peak
2484.34	39.5	-14.5	54	31.14	32.41	5.71	29.76	195	284	Average





Test Mode :	802.11n HT40	Temperature :	24~25°C
Test Band :	High	Relative Humidity :	48~49%
Test Channel :	09	Test Engineer :	Leo Liao

ANTENNA POLARITY : HORIZONTAL										
Frequency ( MHz )	Level ( dBμV/m )	Over Limit ( dB )	Limit Line ( dBμV/m )	Read Level ( dBμV )	Antenna Factor ( dB )	Cable Loss ( dB )	Preamp Factor ( dB )	Ant Pos ( cm )	Table Pos ( deg )	Remark
2389.83	59.67	-14.33	74	51.85	31.98	5.62	29.78	100	293	Peak
2387.67	40.76	-13.24	54	32.98	31.98	5.59	29.79	100	293	Average
2487.76	65.65	-8.35	74	57.2	32.5	5.71	29.76	100	293	Peak
2486.08	50.05	-3.95	54	41.69	32.41	5.71	29.76	100	293	Average

ANTENNA POLARITY : VERTICAL										
Frequency ( MHz )	Level ( dBμV/m )	Over Limit ( dB )	Limit Line ( dBμV/m )	Read Level ( dBμV )	Antenna Factor ( dB )	Cable Loss ( dB )	Preamp Factor ( dB )	Ant Pos ( cm )	Table Pos ( deg )	Remark
2389.29	59.98	-14.02	74	52.2	31.98	5.59	29.79	100	295	Peak
2387.76	41.17	-12.83	54	33.39	31.98	5.59	29.79	100	295	Average
2486.35	65.27	-8.73	74	56.91	32.41	5.71	29.76	100	295	Peak
2484.79	49.27	-4.73	54	40.91	32.41	5.71	29.76	100	295	Average

<Sample 2>

Test Mode :	802.11g	Temperature :	24~25°C
Test Band :	High	Relative Humidity :	48~49%
Test Channel :	11	Test Engineer :	Leo Liao

ANTENNA POLARITY : HORIZONTAL										
Frequency ( MHz )	Level ( dBμV/m )	Over Limit ( dB )	Limit Line ( dBμV/m )	Read Level ( dBμV )	Antenna Factor ( dB )	Cable Loss ( dB )	Preamp Factor ( dB )	Ant Pos ( cm )	Table Pos ( deg )	Remark
2485.81	65.01	-8.99	74	56.65	32.41	5.71	29.76	103	232	Peak
2483.5	47.64	-6.36	54	39.28	32.41	5.71	29.76	103	232	Average

ANTENNA POLARITY : VERTICAL										
Frequency ( MHz )	Level ( dBμV/m )	Over Limit ( dB )	Limit Line ( dBμV/m )	Read Level ( dBμV )	Antenna Factor ( dB )	Cable Loss ( dB )	Preamp Factor ( dB )	Ant Pos ( cm )	Table Pos ( deg )	Remark
2484.01	58.53	-15.47	74	50.17	32.41	5.71	29.76	100	345	Peak
2483.53	41.49	-12.51	54	33.13	32.41	5.71	29.76	100	345	Average

### 3.5.7 Test Result of Radiated Spurious Emission (30MHz ~ 10<sup>th</sup> Harmonic)

**Note:** Pre-scanned all test modes and only choose the worst case mode recorded in the test report for radiated spurious emission below 1GHz.

<Sample 1>

<b>Test Mode :</b>	802.11b	<b>Temperature :</b>	24~25°C
<b>Test Channel :</b>	01	<b>Relative Humidity :</b>	48~49%
<b>Test Engineer :</b>	Leo Liao	<b>Polarization :</b>	Horizontal
<b>Remark :</b>	1. 2412 MHz is fundamental signal which can be ignored. 2. Average measurement was not performed if peak level went lower than the average limit.		

Frequency ( MHz )	Level ( dBμV/m )	Over Limit ( dB )	Limit Line ( dBμV/m )	Read Level ( dBμV )	Antenna Factor ( dB )	Cable Loss ( dB )	Preamp Factor ( dB )	Ant Pos ( cm )	Table Pos ( deg )	Remark
2412	106.61	-	-	98.7	32.07	5.62	29.78	100	187	Peak
2412	104.15	-	-	96.24	32.07	5.62	29.78	100	187	Average
4824	37.58	-36.42	74	52.66	33.82	8.36	57.26	105	198	Peak

<b>Test Mode :</b>	802.11b	<b>Temperature :</b>	24~25°C
<b>Test Channel :</b>	01	<b>Relative Humidity :</b>	48~49%
<b>Test Engineer :</b>	Leo Liao	<b>Polarization :</b>	Vertical
<b>Remark :</b>	1. 2412 MHz is fundamental signal which can be ignored. 2. Average measurement was not performed if peak level went lower than the average limit.		

Frequency ( MHz )	Level ( dBμV/m )	Over Limit ( dB )	Limit Line ( dBμV/m )	Read Level ( dBμV )	Antenna Factor ( dB )	Cable Loss ( dB )	Preamp Factor ( dB )	Ant Pos ( cm )	Table Pos ( deg )	Remark
2412	102.36	-	-	94.45	32.07	5.62	29.78	100	188	Peak
2412	100.16	-	-	92.25	32.07	5.62	29.78	100	188	Average
4824	38.71	-35.29	74	53.79	33.82	8.36	57.26	105	198	Peak



<b>Test Mode :</b>	802.11b	<b>Temperature :</b>	24~25°C
<b>Test Channel :</b>	06	<b>Relative Humidity :</b>	48~49%
<b>Test Engineer :</b>	Leo Liao	<b>Polarization :</b>	Horizontal
<b>Remark :</b>	1. 2437 MHz is fundamental signal which can be ignored. 2. Average measurement was not performed if peak level went lower than the average limit.		

Frequency ( MHz )	Level ( dBμV/m )	Over Limit ( dB )	Limit Line ( dBμV/m )	Read Level (dBμV)	Antenna Factor ( dB )	Cable Loss ( dB )	Preamp Factor ( dB )	Ant Pos ( cm )	Table Pos ( deg )	Remark
2437	108.54	-	-	100.42	32.24	5.65	29.77	100	150	Peak
2437	106.35	-	-	98.23	32.24	5.65	29.77	100	150	Average
4874	39.52	-34.48	74	54.35	33.93	8.41	57.17	145	265	Peak
7311	40.23	-33.77	74	53.51	33.89	9.99	57.16	174	321	Peak

<b>Test Mode :</b>	802.11b	<b>Temperature :</b>	24~25°C
<b>Test Channel :</b>	06	<b>Relative Humidity :</b>	48~49%
<b>Test Engineer :</b>	Leo Liao	<b>Polarization :</b>	Vertical
<b>Remark :</b>	1. 2437 MHz is fundamental signal which can be ignored. 2. Average measurement was not performed if peak level went lower than the average limit.		

Frequency ( MHz )	Level ( dBμV/m )	Over Limit ( dB )	Limit Line ( dBμV/m )	Read Level (dBμV)	Antenna Factor ( dB )	Cable Loss ( dB )	Preamp Factor ( dB )	Ant Pos ( cm )	Table Pos ( deg )	Remark
2437	104.66	-	-	96.54	32.24	5.65	29.77	186	268	Peak
2437	102.35	-	-	94.23	32.24	5.65	29.77	186	268	Average
4874	38.35	-35.65	74	53.18	33.93	8.41	57.17	145	265	Peak
7311	38.82	-35.18	74	52.1	33.89	9.99	57.16	174	321	Peak



<b>Test Mode :</b>	802.11b	<b>Temperature :</b>	24~25°C
<b>Test Channel :</b>	11	<b>Relative Humidity :</b>	48~49%
<b>Test Engineer :</b>	Leo Liao	<b>Polarization :</b>	Horizontal
<b>Remark :</b>	1. 2462 MHz is fundamental signal which can be ignored. 2. Average measurement was not performed if peak level went lower than the average limit.		

Frequency ( MHz )	Level ( dBμV/m )	Over Limit ( dB )	Limit Line ( dBμV/m )	Read Level (dBμV)	Antenna Factor ( dB )	Cable Loss ( dB )	Preamp Factor ( dB )	Ant Pos ( cm )	Table Pos ( deg )	Remark
2462	109.74	-	-	101.49	32.33	5.68	29.76	103	230	Peak
2462	107.5	-	-	99.25	32.33	5.68	29.76	103	230	Average
4924	41.76	-32.24	74	56.33	34.05	8.46	57.08	146	347	Peak
7386	39.73	-34.27	74	52.82	33.94	10.02	57.05	145	274	Peak

<b>Test Mode :</b>	802.11b	<b>Temperature :</b>	24~25°C
<b>Test Channel :</b>	11	<b>Relative Humidity :</b>	48~49%
<b>Test Engineer :</b>	Leo Liao	<b>Polarization :</b>	Vertical
<b>Remark :</b>	1. 2462 MHz is fundamental signal which can be ignored. 2. Average measurement was not performed if peak level went lower than the average limit.		

Frequency ( MHz )	Level ( dBμV/m )	Over Limit ( dB )	Limit Line ( dBμV/m )	Read Level (dBμV)	Antenna Factor ( dB )	Cable Loss ( dB )	Preamp Factor ( dB )	Ant Pos ( cm )	Table Pos ( deg )	Remark
2462	103.91	-	-	95.66	32.33	5.68	29.76	128	286	Peak
2462	100.92	-	-	92.67	32.33	5.68	29.76	128	286	Average
4924	39.3	-34.7	74	53.87	34.05	8.46	57.08	146	347	Peak
7386	39.45	-34.55	74	52.54	33.94	10.02	57.05	145	274	Peak



<b>Test Mode :</b>	802.11g	<b>Temperature :</b>	24~25°C
<b>Test Channel :</b>	01	<b>Relative Humidity :</b>	48~49%
<b>Test Engineer :</b>	Leo Liao	<b>Polarization :</b>	Horizontal
<b>Remark :</b>	1. 2412 MHz is fundamental signal which can be ignored. 2. Average measurement was not performed if peak level went lower than the average limit.		

Frequency ( MHz )	Level ( dBμV/m )	Over Limit ( dB )	Limit Line ( dBμV/m )	Read Level (dBμV)	Antenna Factor ( dB )	Cable Loss ( dB )	Preamp Factor ( dB )	Ant Pos ( cm )	Table Pos ( deg )	Remark
2412	104.38	-	-	96.47	32.07	5.62	29.78	100	235	Peak
2412	95.86	-	-	87.95	32.07	5.62	29.78	100	235	Average
4824	35.91	-38.09	74	50.99	33.82	8.36	57.26	105	198	Peak

<b>Test Mode :</b>	802.11g	<b>Temperature :</b>	24~25°C
<b>Test Channel :</b>	01	<b>Relative Humidity :</b>	48~49%
<b>Test Engineer :</b>	Leo Liao	<b>Polarization :</b>	Vertical
<b>Remark :</b>	1. 2412 MHz is fundamental signal which can be ignored. 2. Average measurement was not performed if peak level went lower than the average limit.		

Frequency ( MHz )	Level ( dBμV/m )	Over Limit ( dB )	Limit Line ( dBμV/m )	Read Level (dBμV)	Antenna Factor ( dB )	Cable Loss ( dB )	Preamp Factor ( dB )	Ant Pos ( cm )	Table Pos ( deg )	Remark
2412	97.87	-	-	89.96	32.07	5.62	29.78	100	338	Peak
2412	88.28	-	-	80.37	32.07	5.62	29.78	100	338	Average
4824	36.26	-37.74	74	51.34	33.82	8.36	57.26	105	198	Peak



<b>Test Mode :</b>	802.11g	<b>Temperature :</b>	24~25°C
<b>Test Channel :</b>	06	<b>Relative Humidity :</b>	48~49%
<b>Test Engineer :</b>	Leo Liao	<b>Polarization :</b>	Horizontal
<b>Remark :</b>	1. 2437 MHz is fundamental signal which can be ignored. 2. Average measurement was not performed if peak level went lower than the average limit.		

Frequency ( MHz )	Level ( dBμV/m )	Over Limit ( dB )	Limit Line ( dBμV/m )	Read Level (dBμV)	Antenna Factor ( dB )	Cable Loss ( dB )	Preamp Factor ( dB )	Ant Pos ( cm )	Table Pos ( deg )	Remark
2437	105.58	-	-	97.46	32.24	5.65	29.77	100	185	Peak
2437	97.35	-	-	89.23	32.24	5.65	29.77	100	185	Average
4874	36.2	-37.8	74	51.03	33.93	8.41	57.17	145	265	Peak
7311	37.62	-36.38	74	50.9	33.89	9.99	57.16	174	321	Peak

<b>Test Mode :</b>	802.11g	<b>Temperature :</b>	24~25°C
<b>Test Channel :</b>	06	<b>Relative Humidity :</b>	48~49%
<b>Test Engineer :</b>	Leo Liao	<b>Polarization :</b>	Vertical
<b>Remark :</b>	1. 2437 MHz is fundamental signal which can be ignored. 2. Average measurement was not performed if peak level went lower than the average limit.		

Frequency ( MHz )	Level ( dBμV/m )	Over Limit ( dB )	Limit Line ( dBμV/m )	Read Level (dBμV)	Antenna Factor ( dB )	Cable Loss ( dB )	Preamp Factor ( dB )	Ant Pos ( cm )	Table Pos ( deg )	Remark
2437	98.08	-	-	89.96	32.24	5.65	29.77	167	334	Peak
2437	88.56	-	-	80.44	32.24	5.65	29.77	167	334	Average
4874	36.9	-37.1	74	51.73	33.93	8.41	57.17	145	265	Peak
7311	37.06	-36.94	74	50.34	33.89	9.99	57.16	174	321	Peak



<b>Test Mode :</b>	802.11g	<b>Temperature :</b>	24~25°C
<b>Test Channel :</b>	11	<b>Relative Humidity :</b>	48~49%
<b>Test Engineer :</b>	Leo Liao	<b>Polarization :</b>	Horizontal
<b>Remark :</b>	1. 2462 MHz is fundamental signal which can be ignored. 2. Average measurement was not performed if peak level went lower than the average limit.		

Frequency ( MHz )	Level ( dBμV/m )	Over Limit ( dB )	Limit Line ( dBμV/m )	Read Level (dBμV)	Antenna Factor ( dB )	Cable Loss ( dB )	Preamp Factor ( dB )	Ant Pos ( cm )	Table Pos ( deg )	Remark
103.72	34.49	-9.01	43.5	51.63	11.52	1.28	29.94	200	0	Peak
188.11	29.78	-13.72	43.5	49.56	8.52	1.64	29.94	-	-	Peak
267.65	24.97	-21.03	46	40.79	12.2	1.91	29.93	-	-	Peak
500.45	21.56	-24.44	46	31.95	17	2.53	29.92	-	-	Peak
750.71	24.16	-21.84	46	30.5	20.53	3.06	29.93	-	-	Peak
908.82	25.57	-20.43	46	31.09	21.07	3.35	29.94	-	-	Peak
2462	105.59	-	-	97.34	32.33	5.68	29.76	100	242	Peak
2462	96.81	-	-	88.56	32.33	5.68	29.76	100	242	Average
4924	36.66	-37.34	74	51.23	34.05	8.46	57.08	146	347	Peak
7386	37.35	-36.65	74	50.44	33.94	10.02	57.05	145	274	Peak



<b>Test Mode :</b>	802.11g	<b>Temperature :</b>	24~25°C
<b>Test Channel :</b>	11	<b>Relative Humidity :</b>	48~49%
<b>Test Engineer :</b>	Leo Liao	<b>Polarization :</b>	Vertical
<b>Remark :</b>	1. 2462 MHz is fundamental signal which can be ignored. 2. Average measurement was not performed if peak level went lower than the average limit.		

Frequency ( MHz )	Level ( dBμV/m )	Over Limit ( dB )	Limit Line ( dBμV/m )	Read Level (dBμV)	Antenna Factor ( dB )	Cable Loss ( dB )	Preamp Factor ( dB )	Ant Pos ( cm )	Table Pos ( deg )	Remark
33.88	36.87	-3.13	40	49.3	16.7	0.8	29.93	100	0	Peak
103.72	32.8	-10.7	43.5	49.94	11.52	1.28	29.94	-	-	Peak
189.08	27.89	-15.61	43.5	47.57	8.61	1.65	29.94	-	-	Peak
384.05	19.86	-26.14	46	32.1	15.44	2.25	29.93	-	-	Peak
644.98	23.51	-22.49	46	32	18.6	2.84	29.93	-	-	Peak
811.82	25.88	-20.12	46	32.22	20.4	3.19	29.93	-	-	Peak
2462	98.48	-	-	90.23	32.33	5.68	29.76	100	342	Peak
2462	89.5	-	-	81.25	32.33	5.68	29.76	100	342	Average
4924	37.12	-36.88	74	51.69	34.05	8.46	57.08	146	347	Peak
7386	37.52	-36.48	74	50.61	33.94	10.02	57.05	145	274	Peak





<b>Test Mode :</b>	2.4GHz 802.11n HT20	<b>Temperature :</b>	24~25°C
<b>Test Channel :</b>	01	<b>Relative Humidity :</b>	48~49%
<b>Test Engineer :</b>	Leo Liao	<b>Polarization :</b>	Horizontal
<b>Remark :</b>	1. 2412 MHz is fundamental signal which can be ignored. 2. Average measurement was not performed if peak level went lower than the average limit.		

Frequency ( MHz )	Level ( dBμV/m )	Over Limit ( dB )	Limit Line ( dBμV/m )	Read Level (dBμV)	Antenna Factor ( dB )	Cable Loss ( dB )	Preamp Factor ( dB )	Ant Pos ( cm )	Table Pos ( deg )	Remark
2412	104.81	-	-	96.9	32.07	5.62	29.78	100	240	Peak
2412	95.16	-	-	87.25	32.07	5.62	29.78	100	240	Average
4824	37.24	-36.76	74	52.32	33.82	8.36	57.26	105	198	Peak

<b>Test Mode :</b>	2.4GHz 802.11n HT20	<b>Temperature :</b>	24~25°C
<b>Test Channel :</b>	01	<b>Relative Humidity :</b>	48~49%
<b>Test Engineer :</b>	Leo Liao	<b>Polarization :</b>	Vertical
<b>Remark :</b>	1. 2412 MHz is fundamental signal which can be ignored. 2. Average measurement was not performed if peak level went lower than the average limit.		

Frequency ( MHz )	Level ( dBμV/m )	Over Limit ( dB )	Limit Line ( dBμV/m )	Read Level (dBμV)	Antenna Factor ( dB )	Cable Loss ( dB )	Preamp Factor ( dB )	Ant Pos ( cm )	Table Pos ( deg )	Remark
2412	97.24	-	-	89.33	32.07	5.62	29.78	100	346	Peak
2412	87.94	-	-	80.03	32.07	5.62	29.78	100	346	Average
4824	36.6	-37.4	74	51.68	33.82	8.36	57.26	105	198	Peak



<b>Test Mode :</b>	2.4GHz 802.11n HT20	<b>Temperature :</b>	24~25°C
<b>Test Channel :</b>	06	<b>Relative Humidity :</b>	48~49%
<b>Test Engineer :</b>	Leo Liao	<b>Polarization :</b>	Horizontal
<b>Remark :</b>	1. 2437 MHz is fundamental signal which can be ignored. 2. Average measurement was not performed if peak level went lower than the average limit.		

Frequency ( MHz )	Level ( dBμV/m )	Over Limit ( dB )	Limit Line ( dBμV/m )	Read Level (dBμV)	Antenna Factor ( dB )	Cable Loss ( dB )	Preamp Factor ( dB )	Ant Pos ( cm )	Table Pos ( deg )	Remark
2437	104.13	-	-	96.01	32.24	5.65	29.77	100	147	Peak
2437	94.3	-	-	86.18	32.24	5.65	29.77	100	147	Average
4874	37.3	-36.7	74	52.13	33.93	8.41	57.17	145	265	Peak
7311	37.49	-36.51	74	50.77	33.89	9.99	57.16	174	321	Peak

<b>Test Mode :</b>	2.4GHz 802.11n HT20	<b>Temperature :</b>	24~25°C
<b>Test Channel :</b>	06	<b>Relative Humidity :</b>	48~49%
<b>Test Engineer :</b>	Leo Liao	<b>Polarization :</b>	Vertical
<b>Remark :</b>	1. 2437 MHz is fundamental signal which can be ignored. 2. Average measurement was not performed if peak level went lower than the average limit.		

Frequency ( MHz )	Level ( dBμV/m )	Over Limit ( dB )	Limit Line ( dBμV/m )	Read Level (dBμV)	Antenna Factor ( dB )	Cable Loss ( dB )	Preamp Factor ( dB )	Ant Pos ( cm )	Table Pos ( deg )	Remark
2437	97.93	-	-	89.81	32.24	5.65	29.77	118	353	Peak
2437	87.71	-	-	79.59	32.24	5.65	29.77	118	353	Average
4874	36.84	-37.16	74	51.67	33.93	8.41	57.17	145	265	Peak
7311	37.89	-36.11	74	51.17	33.89	9.99	57.16	174	321	Peak



<b>Test Mode :</b>	2.4GHz 802.11n HT20	<b>Temperature :</b>	24~25°C
<b>Test Channel :</b>	11	<b>Relative Humidity :</b>	48~49%
<b>Test Engineer :</b>	Leo Liao	<b>Polarization :</b>	Horizontal
<b>Remark :</b>	1. 2462 MHz is fundamental signal which can be ignored. 2. Average measurement was not performed if peak level went lower than the average limit.		

Frequency ( MHz )	Level ( dBμV/m )	Over Limit ( dB )	Limit Line ( dBμV/m )	Read Level (dBμV)	Antenna Factor ( dB )	Cable Loss ( dB )	Preamp Factor ( dB )	Ant Pos ( cm )	Table Pos ( deg )	Remark
2462	104.69	-	-	96.44	32.33	5.68	29.76	100	187	Peak
2462	95.84	-	-	87.59	32.33	5.68	29.76	100	187	Average
4924	37.91	-36.09	74	52.48	34.05	8.46	57.08	146	347	Peak
7386	37.94	-36.06	74	51.03	33.94	10.02	57.05	145	274	Peak

<b>Test Mode :</b>	2.4GHz 802.11n HT20	<b>Temperature :</b>	24~25°C
<b>Test Channel :</b>	11	<b>Relative Humidity :</b>	48~49%
<b>Test Engineer :</b>	Leo Liao	<b>Polarization :</b>	Vertical
<b>Remark :</b>	1. 2462 MHz is fundamental signal which can be ignored. 2. Average measurement was not performed if peak level went lower than the average limit.		

Frequency ( MHz )	Level ( dBμV/m )	Over Limit ( dB )	Limit Line ( dBμV/m )	Read Level (dBμV)	Antenna Factor ( dB )	Cable Loss ( dB )	Preamp Factor ( dB )	Ant Pos ( cm )	Table Pos ( deg )	Remark
2462	98.1	-	-	89.85	32.33	5.68	29.76	100	349	Peak
2462	88.83	-	-	80.58	32.33	5.68	29.76	100	349	Average
4924	37.27	-36.73	74	51.84	34.05	8.46	57.08	146	347	Peak
7386	37.77	-36.23	74	50.86	33.94	10.02	57.05	145	274	Peak



<b>Test Mode :</b>	2.4GHz 802.11n HT40	<b>Temperature :</b>	24~25°C
<b>Test Channel :</b>	03	<b>Relative Humidity :</b>	48~49%
<b>Test Engineer :</b>	Leo Liao	<b>Polarization :</b>	Horizontal
<b>Remark :</b>	1. 2422 MHz is fundamental signal which can be ignored. 2. Average measurement was not performed if peak level went lower than the average limit.		

Frequency ( MHz )	Level ( dBμV/m )	Over Limit ( dB )	Limit Line ( dBμV/m )	Read Level (dBμV)	Antenna Factor ( dB )	Cable Loss ( dB )	Preamp Factor ( dB )	Ant Pos ( cm )	Table Pos ( deg )	Remark
2422	101.5	-	-	93.46	32.16	5.65	29.77	155	145	Peak
2422	91.35	-	-	83.31	32.16	5.65	29.77	155	145	Average
4844	39.47	-34.53	74	54.46	33.86	8.38	57.23	126	248	Peak
7266	38	-36	74	51.35	33.87	9.98	57.2	185	252	Peak

<b>Test Mode :</b>	2.4GHz 802.11n HT40	<b>Temperature :</b>	24~25°C
<b>Test Channel :</b>	03	<b>Relative Humidity :</b>	48~49%
<b>Test Engineer :</b>	Leo Liao	<b>Polarization :</b>	Vertical
<b>Remark :</b>	1. 2422 MHz is fundamental signal which can be ignored. 2. Average measurement was not performed if peak level went lower than the average limit.		

Frequency ( MHz )	Level ( dBμV/m )	Over Limit ( dB )	Limit Line ( dBμV/m )	Read Level (dBμV)	Antenna Factor ( dB )	Cable Loss ( dB )	Preamp Factor ( dB )	Ant Pos ( cm )	Table Pos ( deg )	Remark
2422	98.31	-	-	90.27	32.16	5.65	29.77	195	284	Peak
2422	88.72	-	-	80.68	32.16	5.65	29.77	195	284	Average
4844	39.31	-34.69	74	54.3	33.86	8.38	57.23	126	248	Peak
7266	39.41	-34.59	74	52.76	33.87	9.98	57.2	185	252	Peak



<b>Test Mode :</b>	2.4GHz 802.11n HT40	<b>Temperature :</b>	24~25°C
<b>Test Channel :</b>	06	<b>Relative Humidity :</b>	48~49%
<b>Test Engineer :</b>	Leo Liao	<b>Polarization :</b>	Horizontal
<b>Remark :</b>	1. 2437 MHz is fundamental signal which can be ignored. 2. Average measurement was not performed if peak level went lower than the average limit.		

Frequency ( MHz )	Level ( dBμV/m )	Over Limit ( dB )	Limit Line ( dBμV/m )	Read Level (dBμV)	Antenna Factor ( dB )	Cable Loss ( dB )	Preamp Factor ( dB )	Ant Pos ( cm )	Table Pos ( deg )	Remark
2437	101.58	-	-	93.46	32.24	5.65	29.77	100	231	Peak
2437	92.52	-	-	84.4	32.24	5.65	29.77	100	231	Average
4874	39.39	-34.61	74	54.22	33.93	8.41	57.17	132	224	Peak
7311	38.93	-35.07	74	52.21	33.89	9.99	57.16	119	347	Peak

<b>Test Mode :</b>	2.4GHz 802.11n HT40	<b>Temperature :</b>	24~25°C
<b>Test Channel :</b>	06	<b>Relative Humidity :</b>	48~49%
<b>Test Engineer :</b>	Leo Liao	<b>Polarization :</b>	Vertical
<b>Remark :</b>	1. 2437 MHz is fundamental signal which can be ignored. 2. Average measurement was not performed if peak level went lower than the average limit.		

Frequency ( MHz )	Level ( dBμV/m )	Over Limit ( dB )	Limit Line ( dBμV/m )	Read Level (dBμV)	Antenna Factor ( dB )	Cable Loss ( dB )	Preamp Factor ( dB )	Ant Pos ( cm )	Table Pos ( deg )	Remark
2437	100.1	-	-	91.98	32.24	5.65	29.77	159	287	Peak
2437	89.76	-	-	81.64	32.24	5.65	29.77	159	287	Average
4874	39.55	-34.45	74	54.38	33.93	8.41	57.17	132	224	Peak
7311	39.43	-34.57	74	52.71	33.89	9.99	57.16	119	347	Peak



<b>Test Mode :</b>	2.4GHz 802.11n HT40	<b>Temperature :</b>	24~25°C
<b>Test Channel :</b>	09	<b>Relative Humidity :</b>	48~49%
<b>Test Engineer :</b>	Leo Liao	<b>Polarization :</b>	Horizontal
<b>Remark :</b>	1. 2452 MHz is fundamental signal which can be ignored. 2. Average measurement was not performed if peak level went lower than the average limit.		

Frequency ( MHz )	Level ( dBμV/m )	Over Limit ( dB )	Limit Line ( dBμV/m )	Read Level (dBμV)	Antenna Factor ( dB )	Cable Loss ( dB )	Preamp Factor ( dB )	Ant Pos ( cm )	Table Pos ( deg )	Remark
2452	99.42	-	-	91.26	32.24	5.68	29.76	100	293	Peak
2452	89.6	-	-	81.44	32.24	5.68	29.76	100	293	Average
4904	38.64	-35.36	74	53.3	34.01	8.44	57.11	125	214	Peak
7356	38.29	-35.71	74	51.46	33.92	10.01	57.1	127	315	Peak

<b>Test Mode :</b>	2.4GHz 802.11n HT40	<b>Temperature :</b>	24~25°C
<b>Test Channel :</b>	09	<b>Relative Humidity :</b>	48~49%
<b>Test Engineer :</b>	Leo Liao	<b>Polarization :</b>	Vertical
<b>Remark :</b>	1. 2452 MHz is fundamental signal which can be ignored. 2. Average measurement was not performed if peak level went lower than the average limit.		

Frequency ( MHz )	Level ( dBμV/m )	Over Limit ( dB )	Limit Line ( dBμV/m )	Read Level (dBμV)	Antenna Factor ( dB )	Cable Loss ( dB )	Preamp Factor ( dB )	Ant Pos ( cm )	Table Pos ( deg )	Remark
2452	99.31	-	-	91.15	32.24	5.68	29.76	100	295	Peak
2452	89.22	-	-	81.06	32.24	5.68	29.76	100	295	Average
4904	39.53	-34.47	74	54.19	34.01	8.44	57.11	125	214	Peak
7356	39.42	-34.58	74	52.59	33.92	10.01	57.1	127	315	Peak



<Sample 2>

<b>Test Mode :</b>	802.11g	<b>Temperature :</b>	24~25°C
<b>Test Channel :</b>	11	<b>Relative Humidity :</b>	48~49%
<b>Test Engineer :</b>	Leo Liao	<b>Polarization :</b>	Horizontal
<b>Remark :</b>	1. 2462 MHz is fundamental signal which can be ignored. 2. Average measurement was not performed if peak level went lower than the average limit.		

Frequency ( MHz )	Level ( dBμV/m )	Over Limit ( dB )	Limit Line ( dBμV/m )	Read Level (dBμV)	Antenna Factor ( dB )	Cable Loss ( dB )	Preamp Factor ( dB )	Ant Pos ( cm )	Table Pos ( deg )	Remark
2462	107.13	-	-	98.88	32.33	5.68	29.76	103	232	Peak
2462	97.15	-	-	88.9	32.33	5.68	29.76	103	232	Average
4924	37.9	-36.1	74	52.47	34.05	8.46	57.08	146	347	Peak
7386	36.8	-37.2	74	49.89	33.94	10.02	57.05	145	274	Peak

<b>Test Mode :</b>	802.11g	<b>Temperature :</b>	24~25°C
<b>Test Channel :</b>	11	<b>Relative Humidity :</b>	48~49%
<b>Test Engineer :</b>	Leo Liao	<b>Polarization :</b>	Vertical
<b>Remark :</b>	1. 2462 MHz is fundamental signal which can be ignored. 2. Average measurement was not performed if peak level went lower than the average limit.		

Frequency ( MHz )	Level ( dBμV/m )	Over Limit ( dB )	Limit Line ( dBμV/m )	Read Level (dBμV)	Antenna Factor ( dB )	Cable Loss ( dB )	Preamp Factor ( dB )	Ant Pos ( cm )	Table Pos ( deg )	Remark
2462	101.84	-	-	93.59	32.33	5.68	29.76	100	345	Peak
2462	91.36	-	-	83.11	32.33	5.68	29.76	100	345	Average
4924	37.15	-36.85	74	51.72	34.05	8.46	57.08	146	347	Peak
7386	37.98	-36.02	74	51.07	33.94	10.02	57.05	145	274	Peak

## 3.6 AC Conducted Emission Measurement

### 3.6.1 Limit of AC Conducted Emission

For equipment that is designed to be connected to the public utility (AC) power line, the radio frequency voltage that is conducted back onto the AC power line on any frequency or frequencies within the band 150 kHz to 30 MHz shall not exceed the limits in the following table.

Frequency of Emission (MHz)	Conducted Limit (dB $\mu$ V)	
	Quasi-Peak	Average
0.15-0.5	66 to 56*	56 to 46*
0.5-5	56	46
5-30	60	50

\*Decreases with the logarithm of the frequency.

### 3.6.2 Measuring Instruments

The measuring equipment is listed in the section 4 of this test report.

### 3.6.3 Test Procedures

1. The EUT was placed 0.4 meter from the conducting wall of the shielding room, and it was kept at least 80 centimeters from any other grounded conducting surface.
2. Connect EUT to the power mains through a line impedance stabilization network (LISN).
3. All the support units are connecting to the other LISN.
4. The LISN provides 50 ohm coupling impedance for the measuring instrument.
5. The FCC states that a 50 ohm, 50 microhenry LISN should be used.
6. Both sides of AC line were checked for maximum conducted interference.
7. The frequency range from 150 kHz to 30 MHz was searched.
8. Set the test-receiver system to Peak Detect Function and specified bandwidth with Maximum Hold Mode.



### 3.6.4 Test Setup

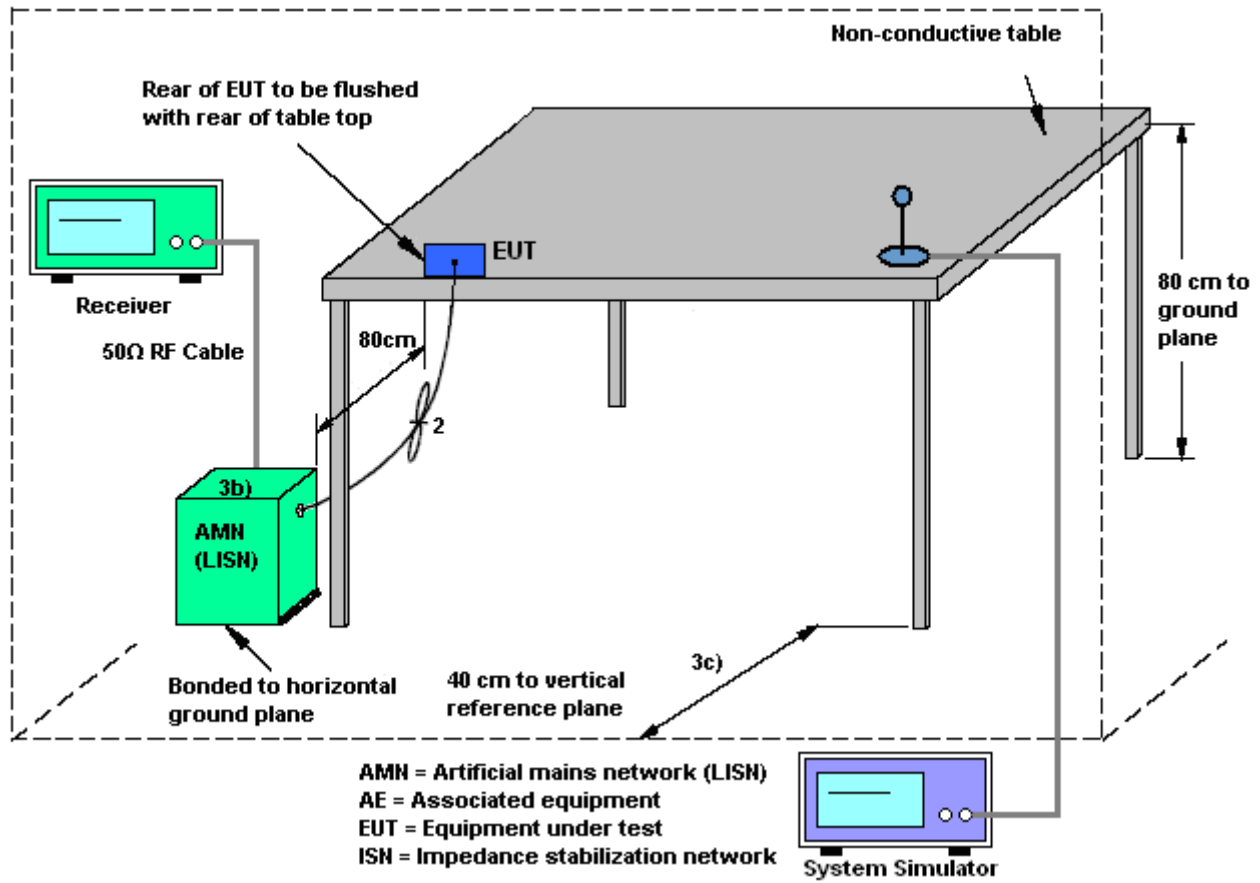

3.6.5 Test Result of AC Conducted Emission

Test Mode :	Mode 1	Temperature :	21~22°C
Test Engineer :	Jack Tian	Relative Humidity :	41~42%
Test Voltage :	120Vac / 60Hz	Phase :	Line
Function Type :	GSM850 Idle + Bluetooth Link + WLAN Link + USB Cable (Charging from Adapter) + Earphone for Sample 1		

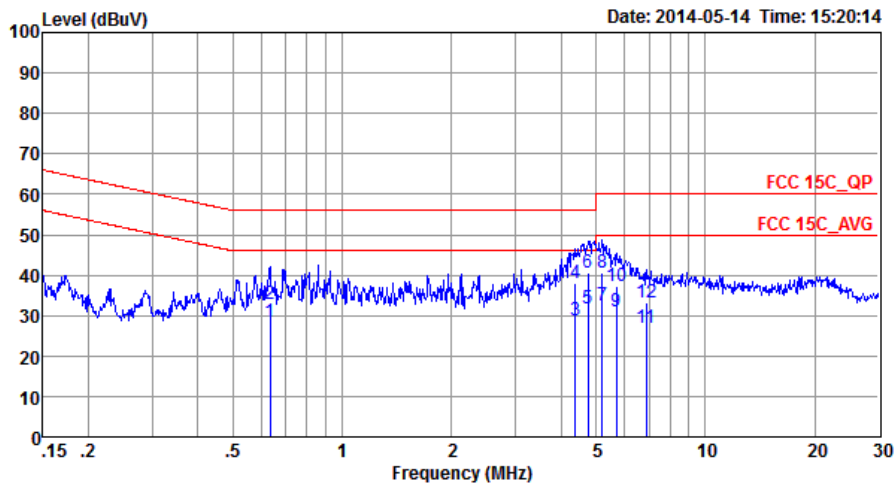

Site : CO01-SZ  
Condition: FCC 15C QP LISN\_L\_20140304 LINE

	Freq	Level	Over Limit	Limit Line	Read Level	LISN Factor	Cable Loss	Remark
	MHz	dBuV	dB	dBuV	dBuV	dB	dB	
1	0.63	28.57	-17.43	46.00	18.20	0.22	10.15	Average
2	0.63	32.87	-23.13	56.00	22.50	0.22	10.15	QP
3	4.38	28.92	-17.08	46.00	18.30	0.39	10.23	Average
4	4.38	38.12	-17.88	56.00	27.50	0.39	10.23	QP
5 *	4.75	31.65	-14.35	46.00	21.00	0.41	10.24	Average
6	4.75	40.65	-15.35	56.00	30.00	0.41	10.24	QP
7	5.19	32.46	-17.54	50.00	21.80	0.42	10.24	Average
8	5.19	40.76	-19.24	60.00	30.10	0.42	10.24	QP
9	5.68	30.96	-19.04	50.00	20.31	0.40	10.25	Average
10	5.68	37.36	-22.64	60.00	26.71	0.40	10.25	QP
11	6.88	26.86	-23.14	50.00	16.20	0.38	10.28	Average
12	6.88	33.26	-26.74	60.00	22.60	0.38	10.28	QP



Test Mode :	Mode 1	Temperature :	21~22°C
Test Engineer :	Jack Tian	Relative Humidity :	41~42%
Test Voltage :	120Vac / 60Hz	Phase :	Neutral
Function Type :	GSM850 Idle + Bluetooth Link + WLAN Link + USB Cable (Charging from Adapter) + Earphone for Sample 1		

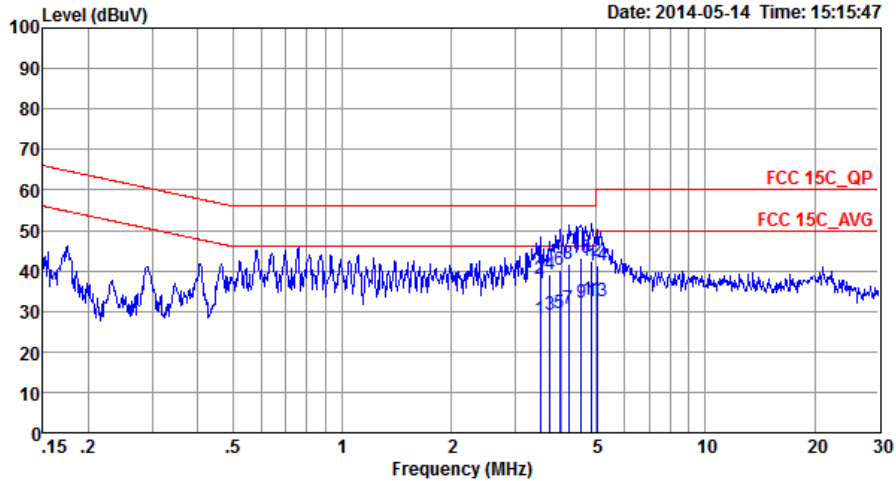

Site : C001-SZ  
Condition: FCC 15C\_QP LISN\_N\_20140304 NEUTRAL

	Freq	Level	Over Limit	Limit Line	Read Level	LISN Factor	Cable Loss	Remark
	MHz	dBuV	dB	dBuV	dBuV	dB	dB	
1	3.51	27.86	-18.14	46.00	17.20	0.44	10.22	Average
2	3.51	37.86	-18.14	56.00	27.20	0.44	10.22	QP
3	3.74	28.98	-17.02	46.00	18.31	0.45	10.22	Average
4	3.74	39.18	-16.82	56.00	28.51	0.45	10.22	QP
5	3.96	29.69	-16.31	46.00	19.00	0.46	10.23	Average
6	3.96	40.39	-15.61	56.00	29.70	0.46	10.23	QP
7	4.20	30.80	-15.20	46.00	20.10	0.47	10.23	Average
8	4.20	41.60	-14.40	56.00	30.90	0.47	10.23	QP
9	4.55	32.01	-13.99	46.00	21.30	0.48	10.23	Average
10 *	4.55	43.11	-12.89	56.00	32.40	0.48	10.23	QP
11	4.87	32.83	-13.17	46.00	22.10	0.49	10.24	Average
12	4.87	42.43	-13.57	56.00	31.70	0.49	10.24	QP
13	5.03	32.43	-17.57	50.00	21.70	0.49	10.24	Average
14	5.03	41.33	-18.67	60.00	30.60	0.49	10.24	QP



## **3.7 Antenna Requirements**

### **3.7.1 Standard Applicable**

If directional gain of transmitting antennas is greater than 6dBi, the power shall be reduced by the same level in dB comparing to gain minus 6dBi. For the fixed point-to-point operation, the power shall be reduced by one dB for every 3 dB that the directional gain of the antenna exceeds 6 dBi. The use of a permanently attached antenna or of an antenna that uses a unique coupling to the intentional radiator shall be considered sufficient to comply with the FCC rule.

### **3.7.2 Antenna Anti-Replacement Construction**

An embedded-in antenna design is used.

### **3.7.3 Antenna Gain**

The antenna peak gain of EUT is less than 6 dBi. Therefore, it is not necessary to reduce maximum peak output power limit.



## 4 List of Measuring Equipment

Instrument	Manufacturer	Model No.	Serial No.	Characteristics	Calibration Date	Test Date	Due Date	Remark
Spectrum Analyzer	R&S	FSP30	101400	9kHz~30GHz	Mar. 03, 2014	May 24, 2014	Mar. 02, 2015	Conducted (TH01-SZ)
Power Meter	Anritsu	ML2495A	1218010	13dBm~-20dBm	Mar. 03, 2014	May 24, 2014	Mar. 02, 2015	Conducted (TH01-SZ)
Power Sensor	Anritsu	MA2411B	1207253	0.3GHz~40GHz	Mar. 03, 2014	May 24, 2014	Mar. 02, 2015	Conducted (TH01-SZ)
ESCIO TEST Receiver	R&S	ESCI	100724	9kHz~3GHz	Feb. 21, 2014	May 26, 2014	Feb. 20, 2015	Radiation (03CH01-SZ)
Signal Analyzer	R&S	FSV40	101078	10Hz~40GHz	Jun. 17, 2013	May 26, 2014	Jun. 16, 2014	Radiation (03CH01-SZ)
Loop Antenna	R&S	HFH2-Z2	100354	9kHz~30MHz	May 29, 2013	May 26, 2014	May 28, 2014	Radiation (03CH01-SZ)
Bilog Antenna	TESEQ	CBL 6112D	23188	30MHz~2GHz	Oct. 26, 2013	May 26, 2014	Oct. 25, 2014	Radiation (03CH01-SZ)
Double Ridge Horn Antenna	ETS Lindgren	3117	00119436	1GHz~18GHz	Oct. 26, 2013	May 26, 2014	Oct. 25, 2014	Radiation (03CH01-SZ)
Double Ridged Horn Antenna	COM-POWER	AH-840	101073	18GHz~40GHz	Jan. 27, 2014	May 26, 2014	Jan. 26, 2015	Radiation (03CH01-SZ)
Amplifier	ADVANTEST	BB525C	E9007003	9kHz~3000MHz	Feb. 21, 2014	May 26, 2014	Feb. 20, 2015	Radiation (03CH01-SZ)
Amplifier	Agilent	83017A	MY39501302	3Hz~26.5GHz	Mar. 03, 2014	May 26, 2014	Mar. 02, 2015	Radiation (03CH01-SZ)
AC Source(AVR)	Chroma	61601	616010001985	100Vac~250Vac	Mar. 25, 2014	May 26, 2014	Mar. 24, 2015	Radiation (03CH01-SZ)
Turn Table	EM Electronics	EM 1000	N/A	0~360 degree	NCR	May 26, 2014	NCR	Radiation (03CH01-SZ)
Antenna Mast	EM Electronics	EM 1000	N/A	1 m~4 m	NCR	May 26, 2014	NCR	Radiation (03CH01-SZ)
ESCIO TEST Receiver	R&S	ESCI	100724	9kHz~3GHz	Feb. 21, 2014	May 14, 2014	Feb. 20, 2015	Conduction (CO01-SZ)
AC LISN	EMCO	3816/2SH	00103912	9kHz~30MHz	Mar. 04, 2014	May 14, 2014	Mar. 03, 2015	Conduction (CO01-SZ)
AC LISN (for auxiliary equipment)	EMCO	3816/2SH	00103892	9kHz~30MHz	Mar. 04, 2014	May 14, 2014	Mar. 03, 2015	Conduction (CO01-SZ)
AC Power Source	Chroma	61602	616020000891	100Vac~250Vac	Dec. 17, 2013	May 14, 2014	Dec. 16, 2014	Conduction (CO01-SZ)



## 5 Uncertainty of Evaluation

### Uncertainty of Conducted Emission Measurement (150kHz ~ 30MHz)

Measuring Uncertainty for a Level of Confidence of 95% ( $U = 2Uc(y)$ )	2.31
---	------

### Uncertainty of Radiated Emission Measurement (30 MHz ~ 1000 MHz)

Measuring Uncertainty for a Level of Confidence of 95% ( $U = 2Uc(y)$ )	3.90
---	------