



FCC RF Test Report

APPLICANT : Lenovo (Shanghai) Electronics Technology Co., Ltd.
EQUIPMENT : Portable Tablet Computer
BRAND NAME : lenovo
MODEL NAME : Lenovo A3300-H
MARKETING NAME : Lenovo A3300-H
FCC ID : O57A3300H
STANDARD : FCC 47 CFR Part 2, 22(H), 24(E)
CLASSIFICATION : PCS Licensed Transmitter (PCB)

The product was testing completed on May 27, 2014. We, SPORTON INTERNATIONAL (SHENZHEN) INC., would like to declare that the tested sample has been evaluated in accordance with the test procedures given in ANSI / TIA / EIA-603-C-2004 and has been in compliance with the applicable technical standards.

The test results in this report apply exclusively to the tested model / sample. Without written approval of SPORTON INTERNATIONAL (SHENZHEN) INC., the test report shall not be reproduced except in full.

Reviewed by: Joseph Lin / Supervisor

Approved by: Jones Tsai / Manager



SPORTON INTERNATIONAL (SHENZHEN) INC.

No. 3 Building, the third floor of south, Shahe River west, Fengzeyuan warehouse, Nanshan District, Shenzhen, Guangdong, P.R.C.



TABLE OF CONTENTS

REVISION HISTORY..... 3
SUMMARY OF TEST RESULT 4
1 GENERAL DESCRIPTION 5
1.1 Applicant..... 5
1.2 Manufacturer 5
1.3 Product Feature of Equipment Under Test 5
1.4 Product Specification subjective to this standard..... 6
1.5 Modification of EUT 7
1.6 Maximum ERP/EIRP Power, Frequency Tolerance, and Emission Designator 7
1.7 Testing Location 8
1.8 Applicable Standards 8
2 TEST CONFIGURATION OF EQUIPMENT UNDER TEST 9
2.1 Test Mode..... 9
2.2 Connection Diagram of Test System 11
2.3 Support Unit used in test configuration 11
2.4 Measurement Results Explanation Example 12
3 TEST RESULT..... 13
3.1 Conducted Output Power Measurement..... 13
3.2 Peak-to-Average Ratio 15
3.3 Effective Radiated Power and Effective Isotropic Radiated Power Measurement 23
3.4 99% Occupied Bandwidth and 26dB Bandwidth Measurement..... 29
3.5 Band Edge Measurement..... 49
3.6 Conducted Spurious Emission Measurement 62
3.7 Field Strength of Spurious Radiation Measurement 78
3.8 Frequency Stability Measurement..... 96
4 LIST OF MEASURING EQUIPMENT 101
5 UNCERTAINTY OF EVALUATION 102
APPENDIX A. SETUP PHOTOGRAPHS



SUMMARY OF TEST RESULT

Report Section	FCC Rule	Description	Limit	Result	Remark
3.1	§2.1046	Conducted Output Power	N/A	PASS	-
3.2	§24.232(d)	Peak-to-Average Ratio	<13 dB	PASS	-
3.3	§22.913(a)(2)	Effective Radiated Power	< 7 Watts	PASS	-
3.3	§24.232(c)	Equivalent Isotropic Radiated Power	< 2 Watts	PASS	-
3.4	§2.1049 §22.917(b) §24.238(b)	Occupied Bandwidth	N/A	PASS	-
3.5	§2.1051 §22.917(a) §24.238(a)	Band Edge Measurement	< $43+10\log_{10}(P[\text{Watts}])$	PASS	-
3.6	§2.1051 §22.917(a) §24.238(a)	Conducted Spurious Emission	< $43+10\log_{10}(P[\text{Watts}])$	PASS	-
3.7	§2.1053 §22.917(a) §24.238(a)	Field Strength of Spurious Radiation	< $43+10\log_{10}(P[\text{Watts}])$	PASS	Under limit 6.50 dB at 1672.000 MHz
3.8	§2.1055 §22.355 §24.235	Frequency Stability for Temperature & Voltage	< 2.5 ppm	PASS	-



1 General Description

1.1 Applicant

Lenovo (Shanghai) Electronics Technology Co., Ltd.
No. 68 Building, 199 Fenju Road, Wai Gao Qiao FTZ, Shanghai, China

1.2 Manufacturer

Lenovo PC HK Limited
23/F, Lincoln House, Taikoo Place 979 King's Road, Quarry Bay, Hong Kong

1.3 Product Feature of Equipment Under Test

Product Feature	
Equipment	Portable Tablet Computer
Brand Name	lenovo
Model Name	Lenovo A3300-H
Marketing Name	Lenovo A3300-H
FCC ID	O57A3300H
EUT supports Radios application	GSM/GPRS/EGPRS/WCDMA/HSPA/HSPA+(Downlink Only)/ WLAN 2.4GHz 802.11b/g/n HT20/HT40/ Bluetooth v3.0 + EDR/Bluetooth v4.0 LE
HW Version	A977_MB_PCB_V4.0
SW Version	A3300H_A442_01_04_140522_ROW
EUT Stage	Pre-Production

Remark: The above EUT's information was declared by manufacturer. Please refer to the specifications or user's manual for more detailed description.

1.4 Product Specification subjective to this standard

Product Specification subjective to this standard	
Tx Frequency	GSM850: 824.2 MHz ~ 848.8 MHz GSM1900: 1850.2 MHz ~ 1909.8MHz WCDMA Band V: 826.4 MHz ~ 846.6 MHz WCDMA Band II: 1852.4 MHz ~ 1907.6 MHz
Rx Frequency	GSM850: 869.2 MHz ~ 893.8 MHz GSM1900: 1930.2 MHz ~ 1989.8 MHz WCDMA Band V: 871.4 MHz ~ 891.6 MHz WCDMA Band II: 1932.4 MHz ~ 1987.6 MHz
Maximum Output Power to Antenna	GSM850 : 32.38 dBm GSM1900 : 29.27 dBm WCDMA Band V : 21.68 dBm WCDMA Band II : 21.52 dBm
Antenna Type	IFA Antenna
Type of Modulation	GSM: GMSK GPRS: GMSK EDGE: GMSK / 8PSK WCDMA: QPSK (Uplink) HSDPA: QPSK (Uplink) HSUPA: QPSK (Uplink) HSPA+: 16QAM (Downlink Only)



1.5 Modification of EUT

No modifications are made to the EUT during all test items.

1.6 Maximum ERP/EIRP Power, Frequency Tolerance, and Emission Designator

FCC Rule	System	Type of Modulation	Maximum ERP/EIRP (W)	Frequency Tolerance (ppm)	Emission Designator
Part 22	GSM850 GSM	GMSK	0.56	0.013 ppm	246KGXW
Part 22	GSM850 EDGE class 8	8PSK	0.12	0.032 ppm	249KG7W
Part 22	WCDMA Band V RMC 12.2Kbps	QPSK	0.06	0.007 ppm	4M20F9W
Part 24	GSM1900 GSM	GMSK	0.95	0.023 ppm	247KGXW
Part 24	GSM1900 EDGE class 8	8PSK	0.47	0.026 ppm	249KG7W
Part 24	WCDMA Band II RMC 12.2Kbps	QPSK	0.16	0.005 ppm	4M17F9W

1.7 Testing Location

Test Site	SPORTON INTERNATIONAL (SHENZHEN) INC.		
Test Site Location	No. 3 Building, the third floor of south, Shahe River west, Fengzeyuan warehouse, Nanshan District, Shenzhen, Guangdong, P.R.C. TEL: +86-755- 3320-2398		
Test Site No.	Sporton Site No.		FCC Registration No.
	TH01-SZ	03CH01-SZ	831040

Note: The test site complies with ANSI C63.4 2003 requirement

Test Site	SPORTON INTERNATIONAL (SHENZHEN) INC.		
Test Site Location	No. 101, Complex Building C, Guanlong Village, Xili Town, Nanshan District, Shenzhen, Guangdong, P.R.C. TEL:+86-755-8637-9589 FAX: +86-755-8637-9595		
Test Site No.	Sporton Site No.		
	OTA01-SZ		

Note: The test site complies with ANSI C63.4 2003 requirement

1.8 Applicable Standards

According to the specifications of the manufacturer, the EUT must comply with the requirements of the following standards:

- ♦ FCC 47 CFR Part 2, 22(H), 24(E)
- ♦ ANSI / TIA / EIA-603-C-2004
- ♦ FCC KDB 971168 D01 Power Meas. License Digital Systems v02r01

Remark:

1. All test items were verified and recorded according to the standards and without any deviation during the test.
2. This EUT has also been tested and complied with the requirements of FCC Part 15, Subpart B, recorded in a separate test report.

2 Test Configuration of Equipment Under Test

2.1 Test Mode

Antenna port conducted and radiated test items were performed according to KDB 971168 D01 Power Meas. License Digital Systems v02r01 with maximum output power.

Radiated measurements were performed with rotating EUT in different three orthogonal test planes to find the maximum emission.

Radiated emissions were investigated as following frequency range:

1. 30 MHz to 9000 MHz for GSM850 and WCDMA Band V.
2. 30 MHz to 19000 MHz for GSM1900 and WCDMA Band II.

Test Modes		
Band	Radiated TCs	Conducted TCs
GSM 850	<ul style="list-style-type: none"> ■ GSM Link ■ EDGE class 8 Link 	<ul style="list-style-type: none"> ■ GSM Link ■ EDGE class 8 Link
GSM 1900	<ul style="list-style-type: none"> ■ GSM Link ■ EDGE class 8 Link 	<ul style="list-style-type: none"> ■ GSM Link ■ EDGE class 8 Link
WCDMA Band V	<ul style="list-style-type: none"> ■ RMC 12.2Kbps Link 	<ul style="list-style-type: none"> ■ RMC 12.2Kbps Link
WCDMA Band II	<ul style="list-style-type: none"> ■ RMC 12.2Kbps Link 	<ul style="list-style-type: none"> ■ RMC 12.2Kbps Link

Note: The maximum power levels are chosen to test as the worst case configuration as follows:

GSM mode for GMSK modulation,

EDGE multi-slot class 8 mode for 8PSK modulation,

RMC 12.2Kbps mode for WCDMA band V,

RMC 12.2Kbps mode for WCDMA band II, only these modes were used for all tests.



Conducted Power Measurement Results:

Conducted Power (*Unit: dBm)						
Band	GSM850			GSM1900		
Channel	128	189	251	512	661	810
Frequency	824.2	836.4	848.8	1850.2	1880.0	1909.8
GSM	31.86	32.31	32.38	28.96	29.21	29.27
GPRS class 8	31.85	32.29	32.35	28.94	29.13	29.25
GPRS class 10	29.01	29.38	29.43	25.92	26.11	26.27
GPRS class 11	27.06	27.42	27.47	23.94	24.06	24.21
GPRS class 12	26.03	26.49	26.51	23.03	23.27	23.31
EGPRS class 8	26.56	26.49	26.45	25.60	25.86	26.18
EGPRS class 10	25.64	25.49	25.46	24.62	24.82	25.11
EGPRS class 11	23.58	23.46	23.44	22.50	22.78	23.13
EGPRS class 12	22.62	22.47	22.46	21.52	21.70	22.06

Conducted Power (*Unit: dBm)						
Band	WCDMA Band V			WCDMA Band II		
Channel	4132	4182	4233	9262	9400	9538
Frequency	826.4	836.4	846.6	1852.4	1880.0	1907.6
AMR 12.2K	21.36	21.65	21.54	21.50	21.43	21.26
RMC 12.2K	21.40	21.68	21.58	21.52	21.46	21.27
HSDPA Subtest-1	20.91	21.13	21.09	21.13	21.06	20.98
HSDPA Subtest-2	20.89	21.07	20.96	21.11	21.03	20.96
HSDPA Subtest-3	20.68	20.82	20.71	21.06	20.94	20.89
HSDPA Subtest-4	20.57	20.77	20.69	20.96	20.93	20.87
HSUPA Subtest-1	20.87	21.09	20.95	20.89	20.76	20.68
HSUPA Subtest-2	20.41	20.83	20.64	20.66	20.41	20.35
HSUPA Subtest-3	20.68	20.97	20.79	20.73	20.62	20.55
HSUPA Subtest-4	20.49	20.88	20.56	20.67	20.46	20.33
HSUPA Subtest-5	20.77	20.98	20.86	20.79	20.66	20.57

2.2 Connection Diagram of Test System

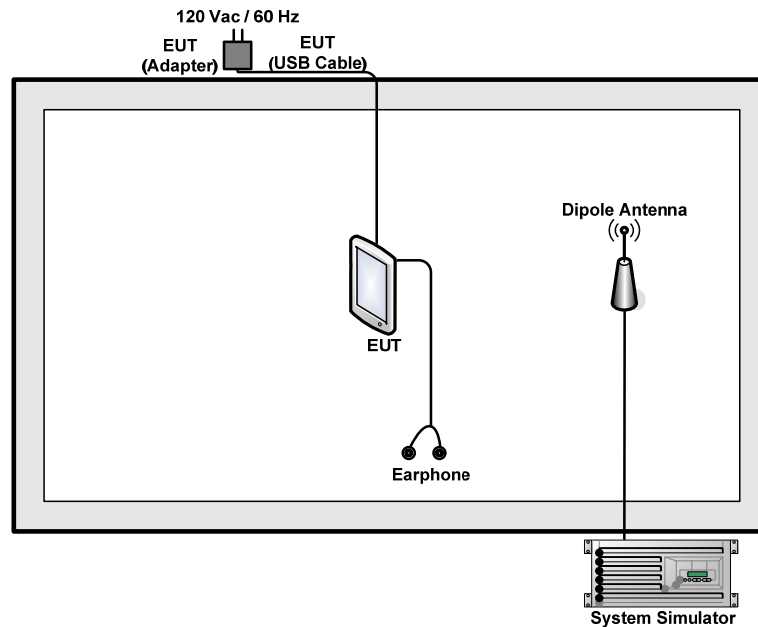

2.3 Support Unit used in test configuration

Item	Equipment	Trade Name	Model No.	FCC ID	Data Cable	Power Cord
1.	System Simulator	R&S	CMU 200	N/A	N/A	Unshielded, 1.8 m
2.	DC Power Supply	TOPWORD	3303DR	N/A	N/A	Unshielded, 1.8 m
3.	Earphone	Lenovo	SH100	N/A	Unshielded, 1.2 m	N/A



2.4 Measurement Results Explanation Example

For all conducted test items:

The offset level is set in the spectrum analyzer to compensate the RF cable loss and attenuator factor between RF conducted output port and spectrum analyzer. With the offset compensation, the spectrum analyzer reading level will be exactly the RF output level.

Example:

The spectrum analyzer offset is derived from RF cable loss and attenuator factor.

Offset = RF cable loss + attenuator factor.

The following shows an offset computation example with RF cable loss 7 dB and a 10dB attenuator.

$$\begin{aligned} \text{Offset (dB)} &= \text{RF cable loss(dB)} + \text{attenuator factor (dB)} \\ &= 7 + 10 = 17 \text{ (dB)} \end{aligned}$$

3 Test Result

3.1 Conducted Output Power Measurement

3.1.1 Description of the Conducted Output Power Measurement

A system simulator was used to establish communication with the EUT. Its parameters were set to enforce EUT transmitting at the maximum power. The measured power in the radio frequency on the transmitter output terminals shall be reported.

3.1.2 Measuring Instruments

The measuring equipment is listed in the section 4 of this test report.

3.1.3 Test Procedures

1. The transmitter output port was connected to the system simulator.
2. Set EUT at maximum power through system simulator.
3. Select lowest, middle, and highest channels for each band and different modulation.
4. Measure the maximum burst average power for GSM and maximum average power for other modulation signal.

3.1.4 Test Setup

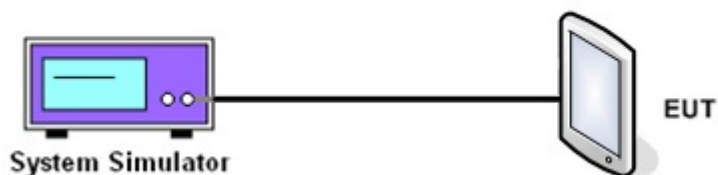

3.1.5 Test Result of Conducted Output Power

Cellular Band									
Modes	GSM850 (GSM)			GSM850 (EDGE class 8)			WCDMA Band V (RMC 12.2Kbps)		
Channel	128 (Low)	189 (Mid)	251 (High)	128 (Low)	189 (Mid)	251 (High)	4132 (Low)	4182 (Mid)	4233 (High)
Frequency (MHz)	824.2	836.4	848.8	824.2	836.4	848.8	826.4	836.4	846.6
Conducted Power (dBm)	31.86	32.31	32.38	26.56	26.49	26.45	21.40	21.68	21.58
Conducted Power (Watts)	1.53	1.70	1.73	0.45	0.45	0.44	0.14	0.15	0.14

PCS Band									
Modes	GSM1900 (GSM)			GSM1900 (EDGE class 8)			WCDMA Band II (RMC 12.2Kbps)		
Channel	512 (Low)	661 (Mid)	810 (High)	512 (Low)	661 (Mid)	810 (High)	9262 (Low)	9400 (Mid)	9538 (High)
Frequency (MHz)	1850.2	1880	1909.8	1850.2	1880	1909.8	1852.4	1880	1907.6
Conducted Power (dBm)	28.96	29.21	29.27	25.60	25.86	26.18	21.52	21.46	21.27
Conducted Power (Watts)	0.79	0.83	0.85	0.36	0.39	0.41	0.14	0.14	0.13

Note: maximum burst average power for GSM, and maximum average power for WCDMA.

3.2 Peak-to-Average Ratio

3.2.1 Description of the PAR Measurement

The peak-to-average ratio (PAR) of the transmission may not exceed 13 dB.

3.2.2 Measuring Instruments

The measuring equipment is listed in the section 4 of this test report.

3.2.3 Test Procedures

1. The EUT was connected to the spectrum analyzer and system simulator via a power divider.
2. For GSM/EGPRS operating modes:
 - a. Set EUT in maximum power output.
 - b. Set the RBW = 1MHz, VBW = 3MHz, Peak detector on spectrum analyzer for first trace.
 - c. Set the RBW = 1MHz, VBW = 3MHz, RMS detector on spectrum analyzer for second trace.
 - d. The wanted burst signal is triggered by spectrum analyzer, and measured respectively the peak level and Mean level without burst-off time, after system simulator has synchronized with the spectrum analyzer.
3. For UMTS operating modes:
 - a. Set the CCDF (Complementary Cumulative Distribution Function) option on the spectrum analyzer.
 - b. The highest RF powers were measured and recorded the maximum PAPR level associated with a probability of 0.1 %.
4. Record the deviation as Peak to Average Ratio.

3.2.4 Test Setup

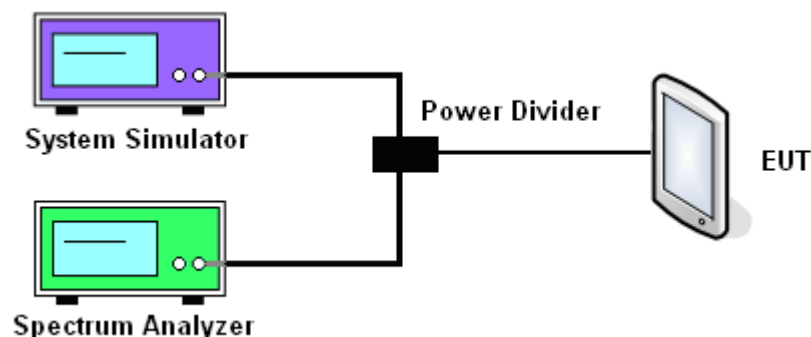



3.2.5 Test Result of Peak-to-Average Ratio

PCS Band									
Modes	GSM1900 (GSM)			GSM1900 (EDGE class 8)			WCDMA Band II (RMC 12.2Kbps)		
Channel	512 (Low)	661 (Mid)	810 (High)	512 (Low)	661 (Mid)	810 (High)	9262 (Low)	9400 (Mid)	9538 (High)
Frequency (MHz)	1850.2	1880	1909.8	1850.2	1880	1909.8	1852.4	1880	1907.6
Peak-to-Average Ratio (dB)	0.30	0.30	0.29	2.98	2.81	2.61	2.84	3.01	2.78



3.2.6 Test Result (Plots) of Peak-to-Average Ratio

Band :	GSM 1900	Test Mode :	GSM Link (GMSK)
--------	----------	-------------	-----------------

Peak-to-Average Ratio on Channel 512 (1850.2 MHz)

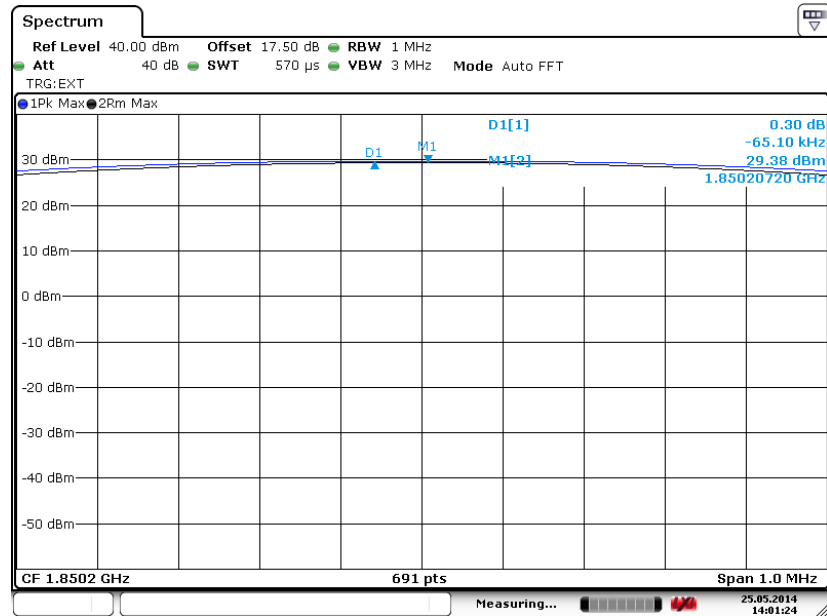

Date: 25.MAY.2014 14:01:24

Peak-to-Average Ratio on Channel 661 (1880.0 MHz)

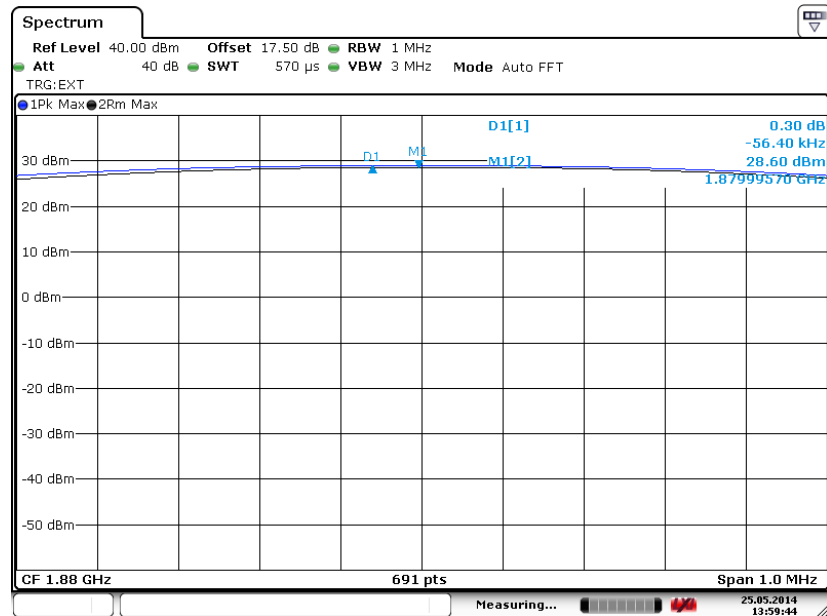

Date: 25.MAY.2014 13:59:44



Peak-to-Average Ratio on Channel 810 (1909.8 MHz)

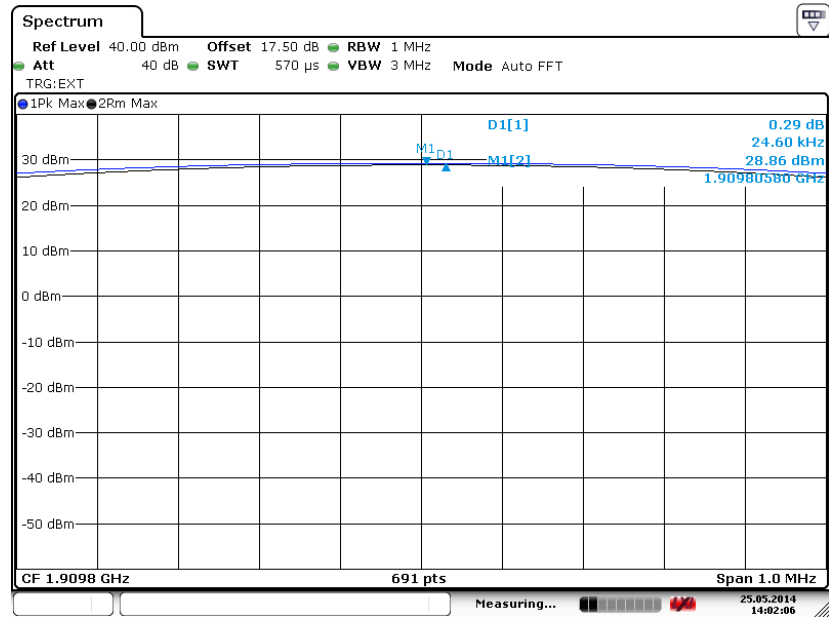

Date: 25.MAY.2014 14:02:06



Band :	GSM 1900	Test Mode :	EDGE class 8 Link (8PSK)
---------------	----------	--------------------	--------------------------

Peak-to-Average Ratio on Channel 512 (1850.2 MHz)

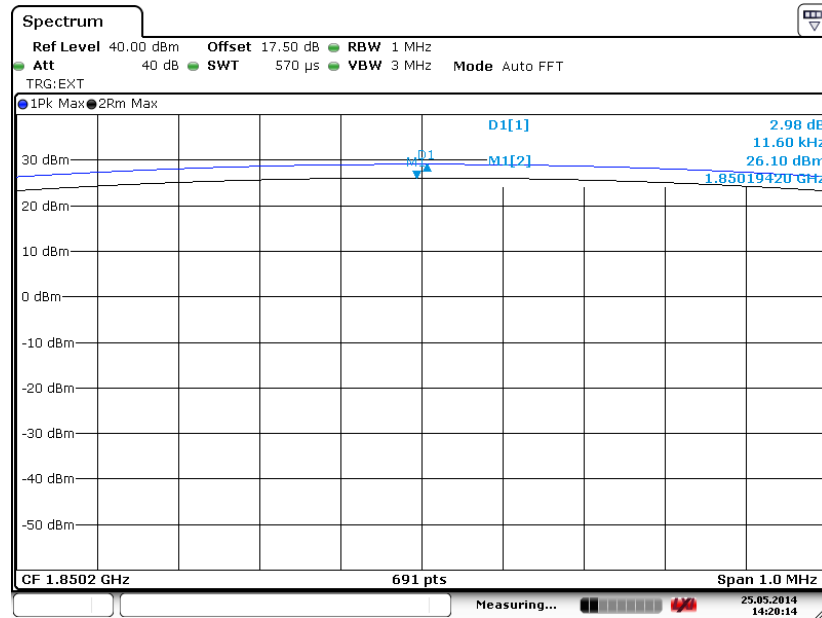

Date: 25.MAY.2014 14:20:15

Peak-to-Average Ratio on Channel 661 (1880.0 MHz)

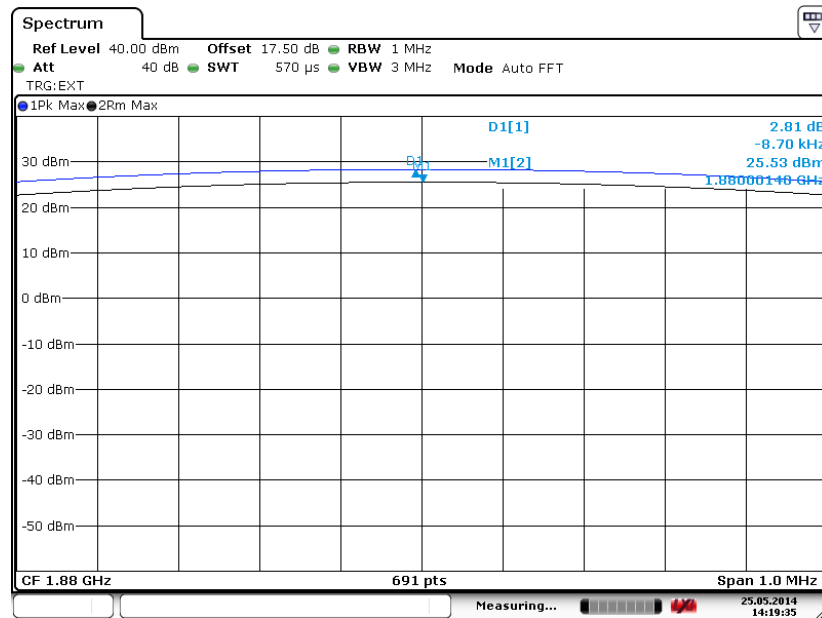

Date: 25.MAY.2014 14:19:35



Peak-to-Average Ratio on Channel 810 (1909.8 MHz)

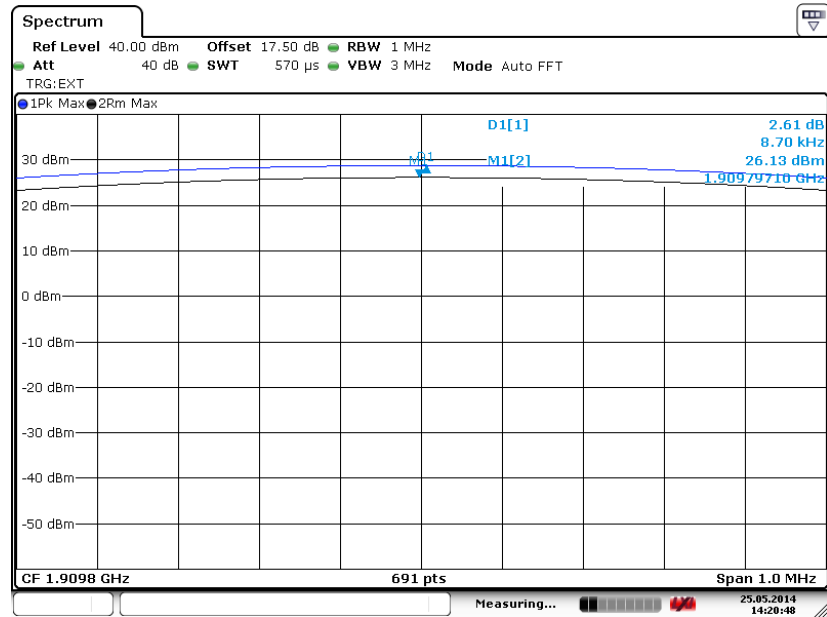

Date: 25.MAY.2014 14:20:48



Band :	WCDMA Band II	Test Mode :	RMC 12.2Kbps Link (QPSK)
---------------	---------------	--------------------	--------------------------

Peak-to-Average Ratio on Channel 9262 (1852.4 MHz)

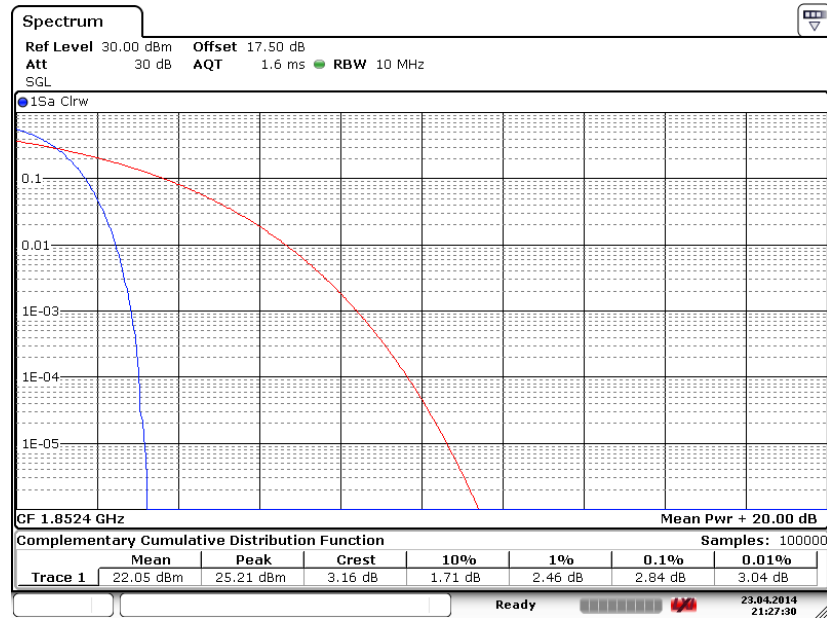

Date: 23.APR.2014 21:27:30

Peak-to-Average Ratio on Channel 9400 (1880.0 MHz)

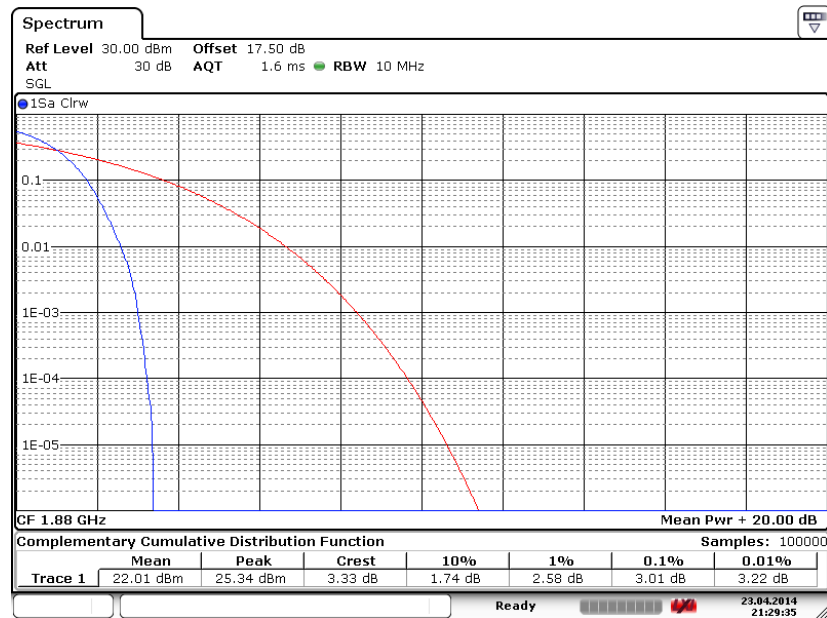

Date: 23.APR.2014 21:29:35



Peak-to-Average Ratio on Channel 9538 (1907.6 MHz)

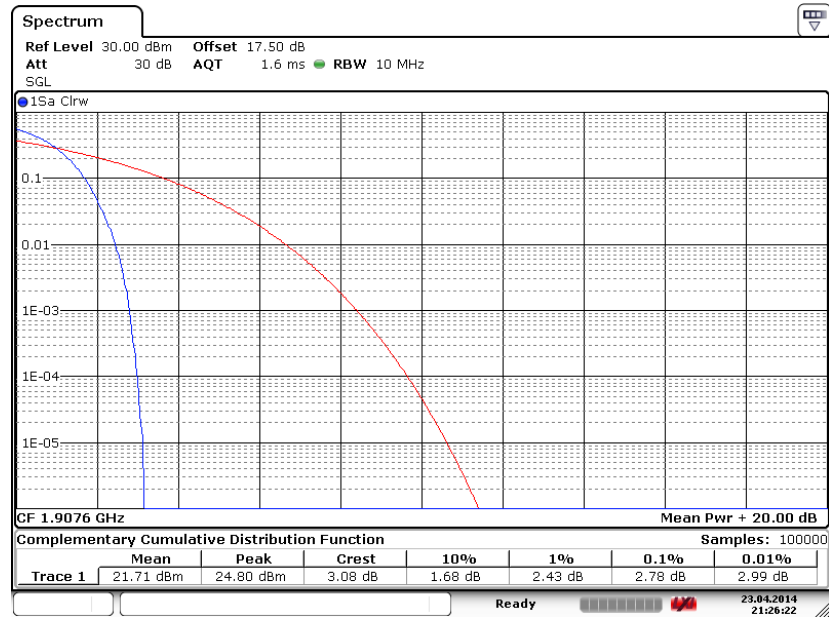

Date: 23. APR. 2014 21:26:22

3.3 Effective Radiated Power and Effective Isotropic Radiated Power Measurement

3.3.1 Description of the ERP/EIRP Measurement

The substitution method, in ANSI / TIA / EIA-603-C-2004, was used for ERP/EIRP measurement, and the spectrum analyzer configuration follows KDB 971168 D01 Power Meas. License Digital Systems v02r01. The ERP of mobile transmitters must not exceed 7 Watts and the EIRP of mobile transmitters are limited to 2 Watts.

3.3.2 Measuring Instruments

The measuring equipment is listed in the section 4 of this test report.

3.3.3 Test Procedures

1. The EUT was placed on a turntable 1.5 meters high in a fully anechoic chamber.
2. The EUT was placed 3 meters from the receiving antenna, which was mounted on the antenna tower.
3. GSM operating modes: Set RBW= 1MHz, VBW= 3MHz, RMS detector over burst;
UMTS operating modes: Set RBW= 100 kHz, VBW= 300 kHz, RMS detector over frame, and use channel power option with bandwidth=5MHz, per KDB 971168 D01.
4. The table was rotated 360 degrees to determine the position of the highest radiated power.
5. The height of the receiving antenna is adjusted to look for the maximum ERP/EIRP.
6. Taking the record of maximum ERP/EIRP.
7. A dipole antenna was substituted in place of the EUT and was driven by a signal generator.
8. The conducted power at the terminal of the dipole antenna is measured.
9. Repeat step 3 to step 5 to get the maximum ERP/EIRP of the substitution antenna.
10. $ERP/EIRP = P_s + E_t - E_s + G_s = P_s + R_t - R_s + G_s$

P_s (dBm) : Input power to substitution antenna.

G_s (dBi or dBd) : Substitution antenna Gain.

$E_t = R_t + AF$

$E_s = R_s + AF$

AF (dB/m) : Receive antenna factor

R_t : The highest received signal in spectrum analyzer for EUT.

R_s : The highest received signal in spectrum analyzer for substitution antenna.

3.3.4 Test Setup

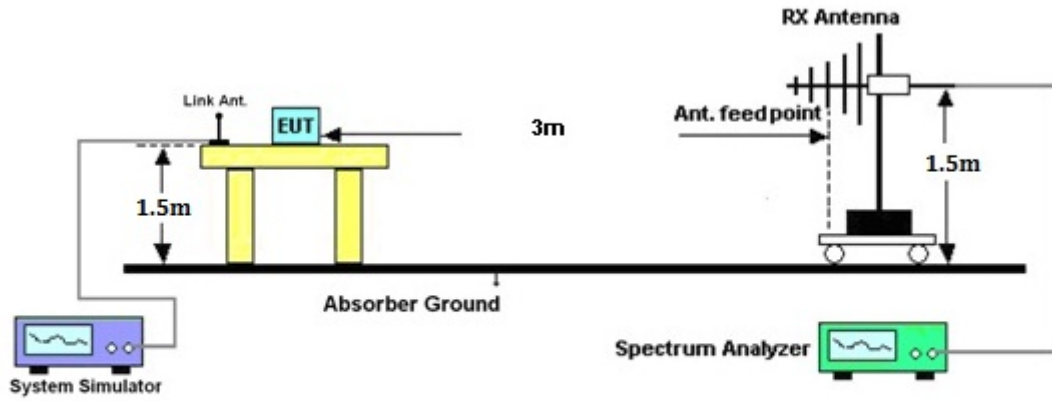

3.3.5 Test Result of ERP

GSM850 (GSM) Radiated Power ERP						
Horizontal Polarization						
Frequency (MHz)	Rt (dBm)	Rs (dBm)	Ps (dBm)	Gs (dBd)	ERP (dBm)	ERP (W)
824.20	-20.06	-48.12	0.00	-1.08	26.98	0.50
836.40	-19.88	-48.28	0.00	-0.93	27.47	0.56
848.80	-20.09	-48.35	0.00	-0.76	27.50	0.56
Vertical Polarization						
Frequency (MHz)	Rt (dBm)	Rs (dBm)	Ps (dBm)	Gs (dBd)	ERP (dBm)	ERP (W)
824.20	-19.92	-47.97	0.00	-1.08	26.97	0.50
836.40	-19.70	-48.01	0.00	-0.93	27.38	0.55
848.80	-20.01	-48.05	0.00	-0.76	27.28	0.53

GSM850 (EDGE class 8) Radiated Power ERP						
Horizontal Polarization						
Frequency (MHz)	Rt (dBm)	Rs (dBm)	Ps (dBm)	Gs (dBd)	ERP (dBm)	ERP (W)
824.20	-26.16	-48.12	0.00	-1.08	20.88	0.12
836.40	-26.66	-48.28	0.00	-0.93	20.69	0.12
848.80	-27.03	-48.35	0.00	-0.76	20.56	0.11
Vertical Polarization						
Frequency (MHz)	Rt (dBm)	Rs (dBm)	Ps (dBm)	Gs (dBd)	ERP (dBm)	ERP (W)
824.20	-25.96	-47.97	0.00	-1.08	20.93	0.12
836.40	-26.62	-48.01	0.00	-0.93	20.46	0.11
848.80	-26.95	-48.05	0.00	-0.76	20.34	0.11



WCDMA Band V (RMC 12.2Kbps) Radiated Power ERP						
Horizontal Polarization						
Frequency (MHz)	Rt (dBm)	Rs (dBm)	Ps (dBm)	Gs (dBd)	ERP (dBm)	ERP (W)
826.40	-29.87	-48.12	0.00	-1.08	17.17	0.05
836.40	-29.60	-48.28	0.00	-0.93	17.75	0.06
846.60	-30.75	-48.35	0.00	-0.76	16.84	0.05
Vertical Polarization						
Frequency (MHz)	Rt (dBm)	Rs (dBm)	Ps (dBm)	Gs (dBd)	ERP (dBm)	ERP (W)
826.40	-29.79	-47.97	0.00	-1.08	17.10	0.05
836.40	-29.43	-48.01	0.00	-0.93	17.65	0.06
846.60	-30.50	-48.05	0.00	-0.76	16.79	0.05

3.3.6 Test Result of EIRP

GSM1900 (GSM) Radiated Power EIRP						
Horizontal Polarization						
Frequency (MHz)	Rt (dBm)	Rs (dBm)	Ps (dBm)	Gs (dBi)	EIRP (dBm)	EIRP (W)
1850.20	-27.83	-51.88	0.00	1.96	26.01	0.40
1880.00	-28.56	-52.99	0.00	2.00	26.43	0.44
1909.80	-29.02	-54.28	0.00	1.98	27.24	0.53
Vertical Polarization						
Frequency (MHz)	Rt (dBm)	Rs (dBm)	Ps (dBm)	Gs (dBi)	EIRP (dBm)	EIRP (W)
1850.20	-25.07	-52.13	0.00	1.96	29.02	0.80
1880.00	-25.62	-53.17	0.00	2.00	29.55	0.90
1909.80	-26.34	-54.13	0.00	1.98	29.77	0.95

GSM1900 (EDGE class 8) Radiated Power EIRP						
Horizontal Polarization						
Frequency (MHz)	Rt (dBm)	Rs (dBm)	Ps (dBm)	Gs (dBi)	EIRP (dBm)	EIRP (W)
1850.20	-30.84	-51.88	0.00	1.96	23.00	0.20
1880.00	-31.53	-52.99	0.00	2.00	23.46	0.22
1909.80	-31.96	-54.28	0.00	1.98	24.30	0.27
Vertical Polarization						
Frequency (MHz)	Rt (dBm)	Rs (dBm)	Ps (dBm)	Gs (dBi)	EIRP (dBm)	EIRP (W)
1850.20	-27.83	-52.13	0.00	1.96	26.26	0.42
1880.00	-28.69	-53.17	0.00	2.00	26.48	0.44
1909.80	-29.38	-54.13	0.00	1.98	26.73	0.47



WCDMA Band II (RMC 12.2Kbps) Radiated Power EIRP						
Horizontal Polarization						
Frequency (MHz)	Rt (dBm)	Rs (dBm)	Ps (dBm)	Gs (dBi)	EIRP (dBm)	EIRP (W)
1852.40	-34.83	-51.88	0.00	1.96	19.01	0.08
1880.00	-35.76	-52.99	0.00	2.00	19.23	0.08
1907.60	-36.65	-54.28	0.00	1.98	19.61	0.09
Vertical Polarization						
Frequency (MHz)	Rt (dBm)	Rs (dBm)	Ps (dBm)	Gs (dBi)	EIRP (dBm)	EIRP (W)
1852.40	-32.64	-52.13	0.00	1.96	21.45	0.14
1880.00	-33.16	-53.17	0.00	2.00	22.01	0.16
1907.60	-34.14	-54.13	0.00	1.98	21.97	0.16

3.4 99% Occupied Bandwidth and 26dB Bandwidth Measurement

3.4.1 Description of 99% Occupied Bandwidth and 26dB Bandwidth Measurement

The 99% occupied bandwidth is the width of a frequency band such that, below the lower and above the upper frequency limits, the mean powers emitted are each equal to a specified percentage 0.5% of the total mean transmitted power.

The emission bandwidth is defined as the width of the signal between two points, located at the 2 sides of the carrier frequency, outside of which all emissions are attenuated at least 26 dB below the transmitter power.

3.4.2 Measuring Instruments

The measuring equipment is listed in the section 4 of this test report.

3.4.3 Test Procedures

1. The EUT was connected to the spectrum analyzer and system simulator via a power divider.
2. The RF output of the EUT was connected to the spectrum analyzer by RF cable and attenuator. The path loss was compensated to the results for each measurement.
3. The 99% occupied bandwidth were measured, set RBW= 1% of span, VBW= 3*RBW, sample detector, trace maximum hold.
4. The 26dB bandwidth were measured, set RBW= 1% of EBW, VBW= 3*RBW, peak detector, trace maximum hold.

3.4.4 Test Setup

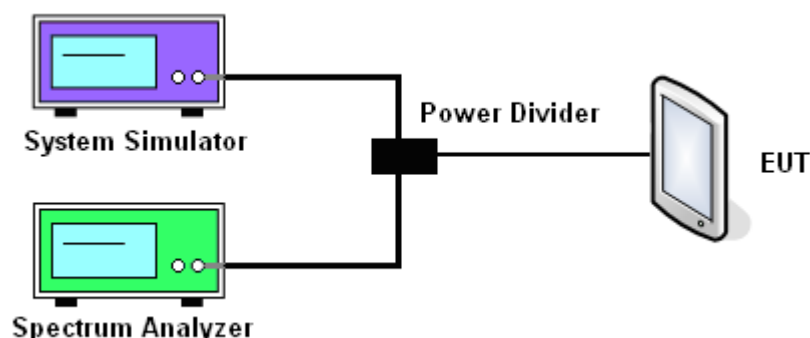

3.4.5 Test Result of Occupied Bandwidth and 26dB Bandwidth

Cellular Band						
Modes	GSM850 (GSM)			GSM850 (EDGE class 8)		
Channel	128 (Low)	189 (Mid)	251 (High)	128 (Low)	189 (Mid)	251 (High)
Frequency (MHz)	824.2	836.4	848.8	824.2	836.4	848.8
99% OBW (kHz)	246.02	246.02	246.02	248.91	248.91	247.47
26dB BW (kHz)	312.60	305.40	308.20	312.60	312.60	314.00

PCS Band						
Modes	GSM1900 (GSM)			GSM1900 (EDGE class 8)		
Channel	512 (Low)	661 (Mid)	810 (High)	512 (Low)	661 (Mid)	810 (High)
Frequency (MHz)	1850.2	1880	1909.8	1850.2	1880	1909.8
99% OBW (kHz)	247.47	244.57	246.02	248.91	247.47	243.13
26dB BW (kHz)	305.40	312.60	305.40	309.70	308.20	308.20

Cellular Band			
Modes	WCDMA Band V (RMC 12.2Kbps)		
Channel	4132 (Low)	4182 (Mid)	4233 (High)
Frequency (MHz)	826.4	836.4	846.6
99% OBW (MHz)	4.15	4.20	4.17
26dB BW (MHz)	4.69	4.70	4.69

PCS Band			
Modes	WCDMA Band II (RMC 12.2Kbps)		
Channel	9262 (Low)	9400 (Mid)	9538 (High)
Frequency (MHz)	1852.4	1880	1907.6
99% OBW (MHz)	4.17	4.17	4.17
26dB BW (MHz)	4.69	4.69	4.67



3.4.6 Test Result (Plots) of Occupied Bandwidth and 26dB Bandwidth

Band :	GSM 850	Test Mode :	GSM Link (GMSK)
--------	---------	-------------	-----------------

99% Occupied Bandwidth Plot on Channel 128 (824.2 MHz)

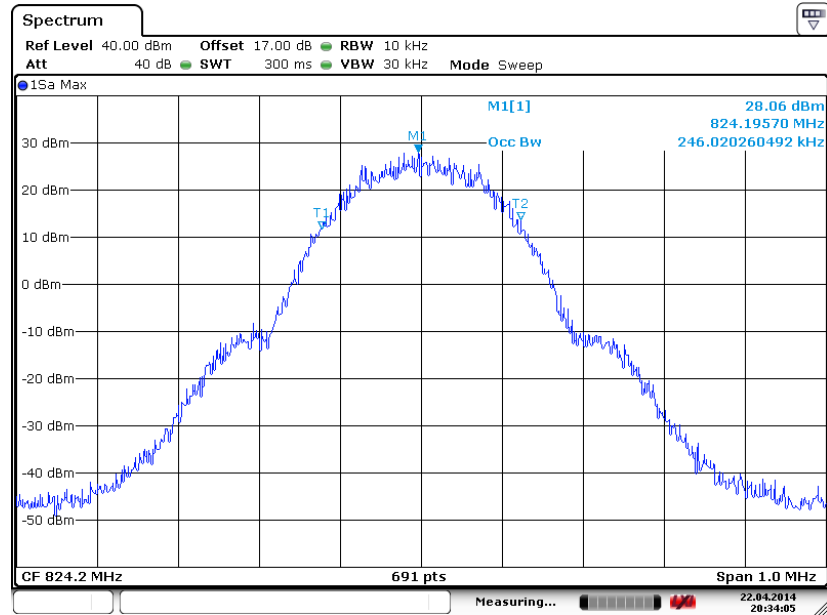

Date: 22.APR.2014 20:34:05

26dB Bandwidth Plot on Channel 128 (824.2 MHz)

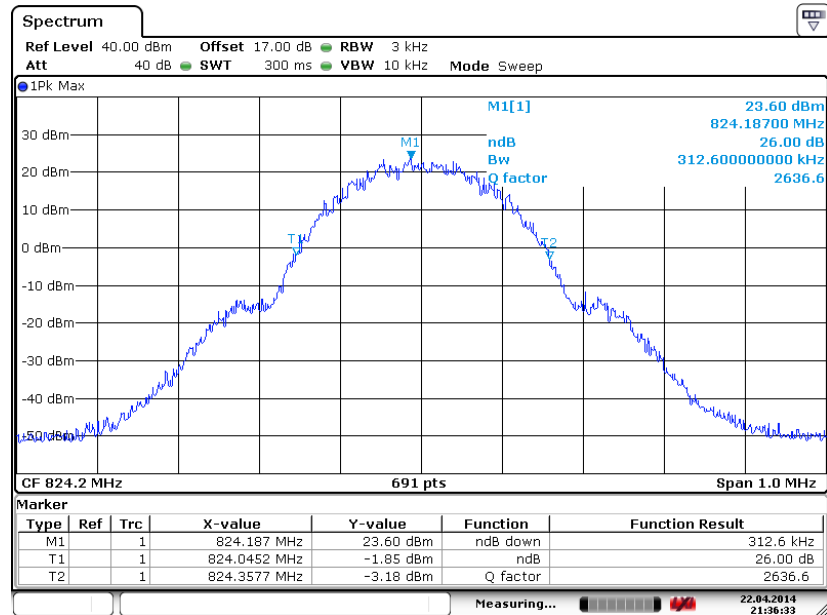

Date: 22.APR.2014 21:36:33



99% Occupied Bandwidth Plot on Channel 189 (836.4 MHz)

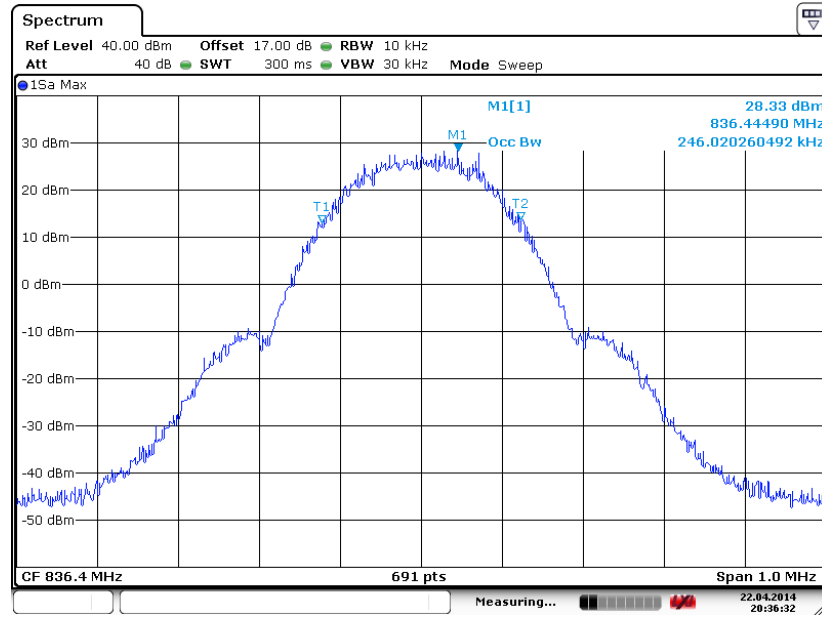

Date: 22.APR.2014 20:36:32

26dB Bandwidth Plot on Channel 189 (836.4 MHz)

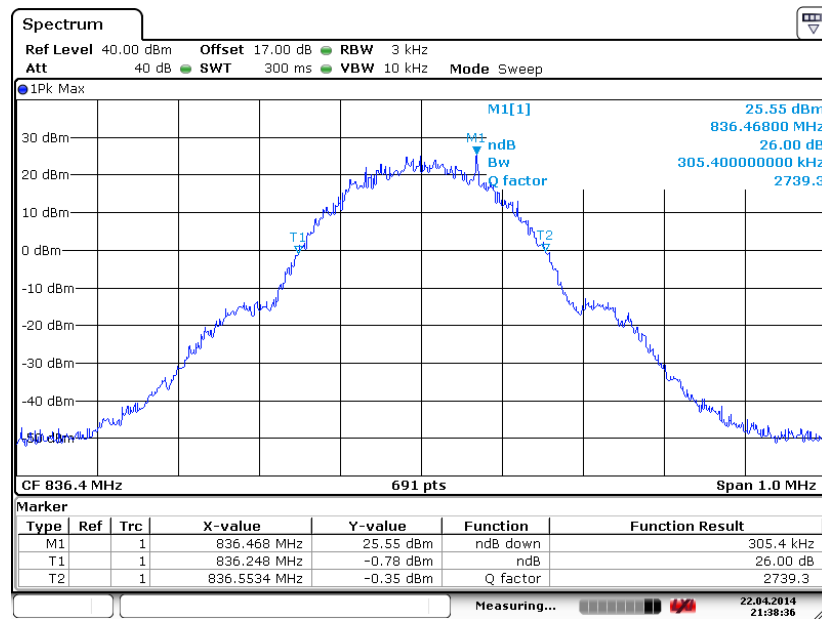

Date: 22.APR.2014 21:38:36



99% Occupied Bandwidth Plot on Channel 251 (848.8 MHz)

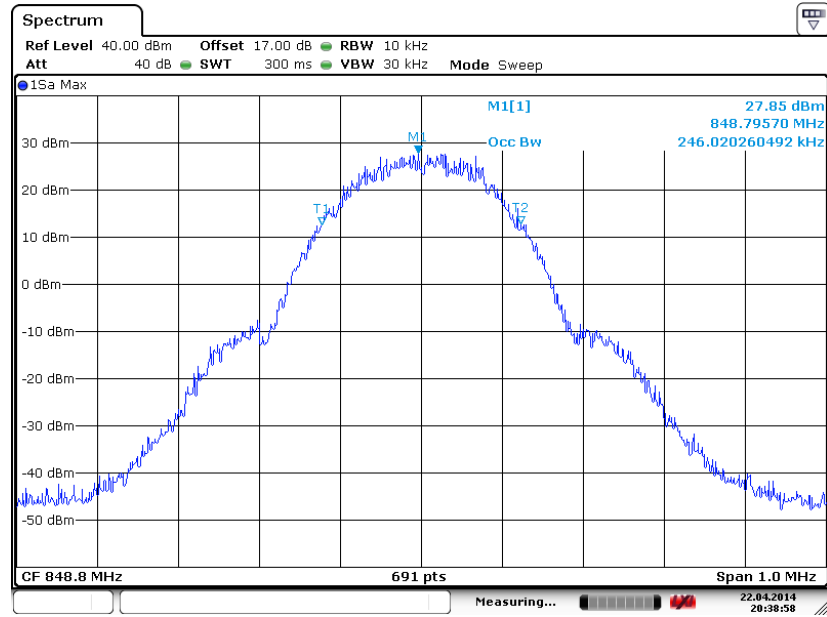

Date: 22.APR.2014 20:38:59

26dB Bandwidth Plot on Channel 251 (848.8 MHz)

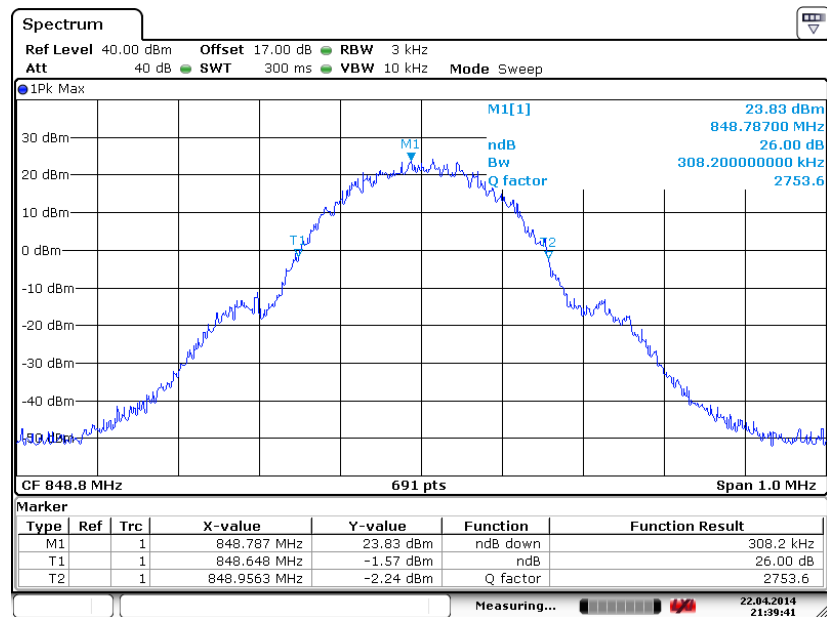

Date: 22.APR.2014 21:39:41



Band :	GSM 850	Test Mode :	EDGE class 8 Link (8PSK)
--------	---------	-------------	--------------------------

99% Occupied Bandwidth Plot on Channel 128 (824.2 MHz)

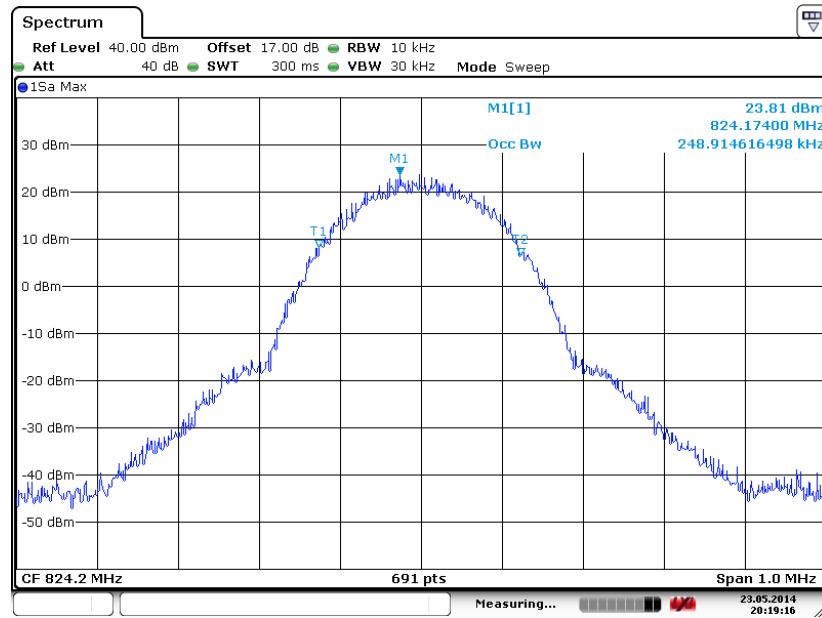

Date: 23.MAY.2014 20:19:16

26dB Bandwidth Plot on Channel 128 (824.2 MHz)

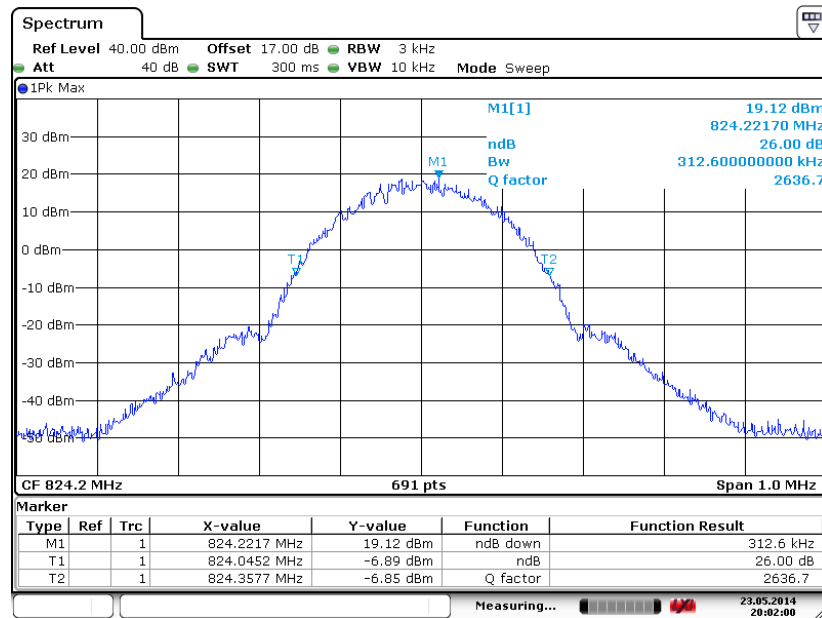

Date: 23.MAY.2014 20:02:00



99% Occupied Bandwidth Plot on Channel 189 (836.4 MHz)

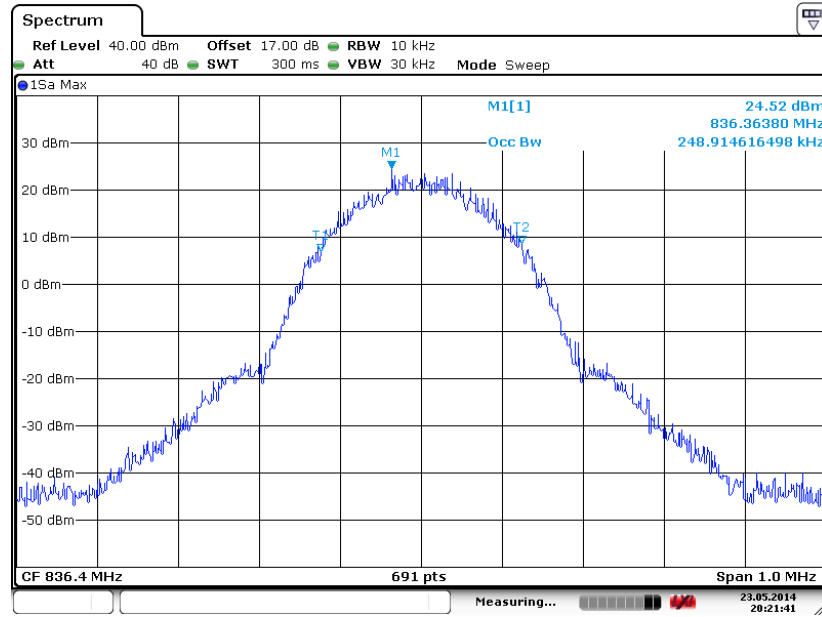

Date: 23.MAY.2014 20:21:41

26dB Bandwidth Plot on Channel 189 (836.4 MHz)

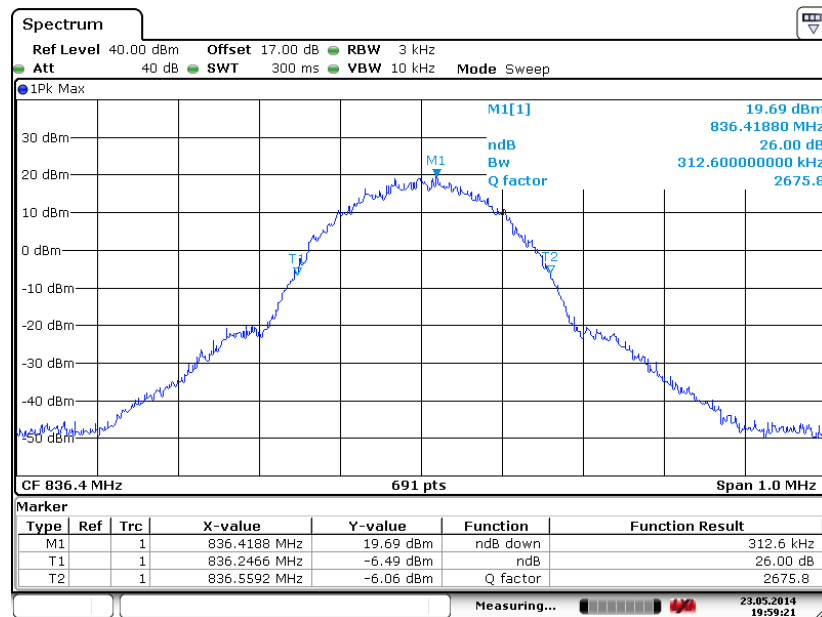

Date: 23.MAY.2014 19:59:21



99% Occupied Bandwidth Plot on Channel 251 (848.8 MHz)

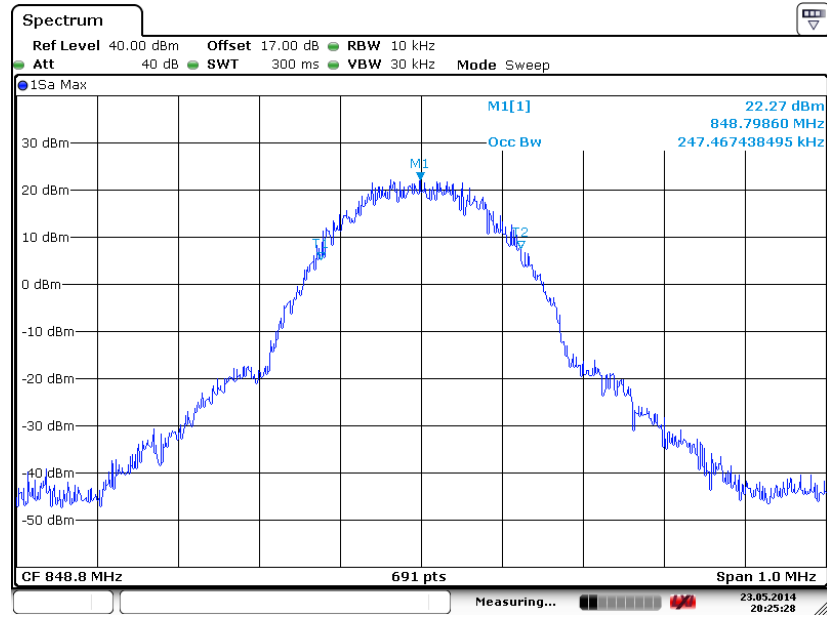

Date: 23.MAY.2014 20:25:28

26dB Bandwidth Plot on Channel 251 (848.8 MHz)

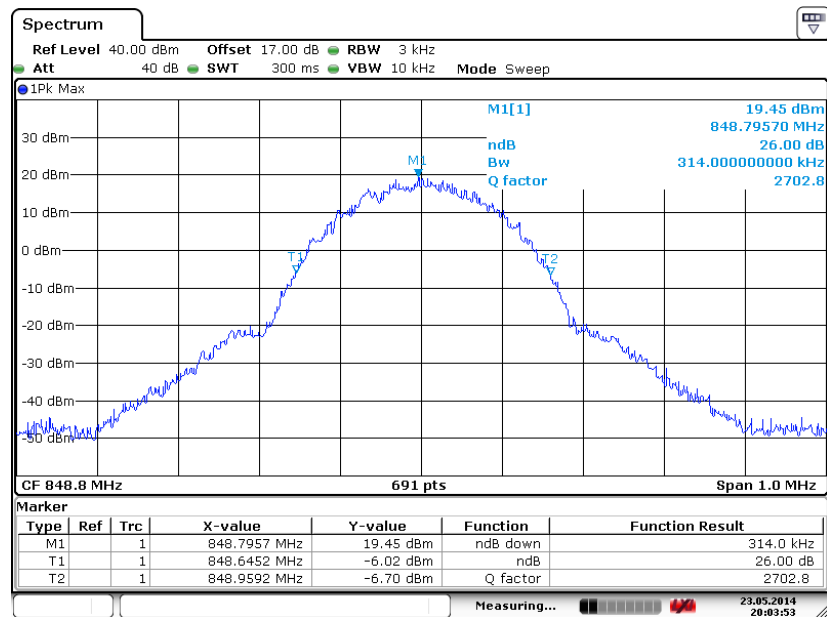

Date: 23.MAY.2014 20:03:53



Band :	GSM 1900	Test Mode :	GSM Link (GMSK)
--------	----------	-------------	-----------------

99% Occupied Bandwidth Plot on Channel 512 (1850.2 MHz)

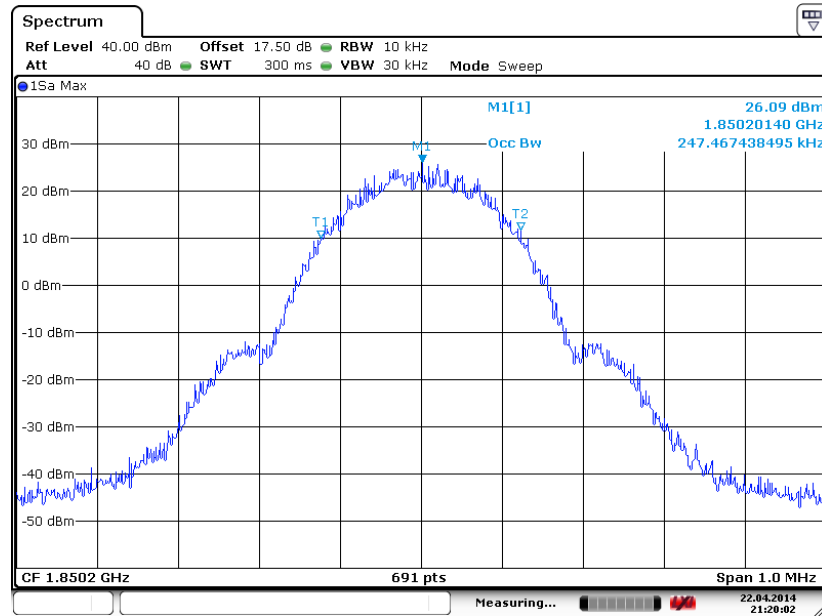

Date: 22. APR. 2014 21:20:02

26dB Bandwidth Plot on Channel 512 (1850.2 MHz)

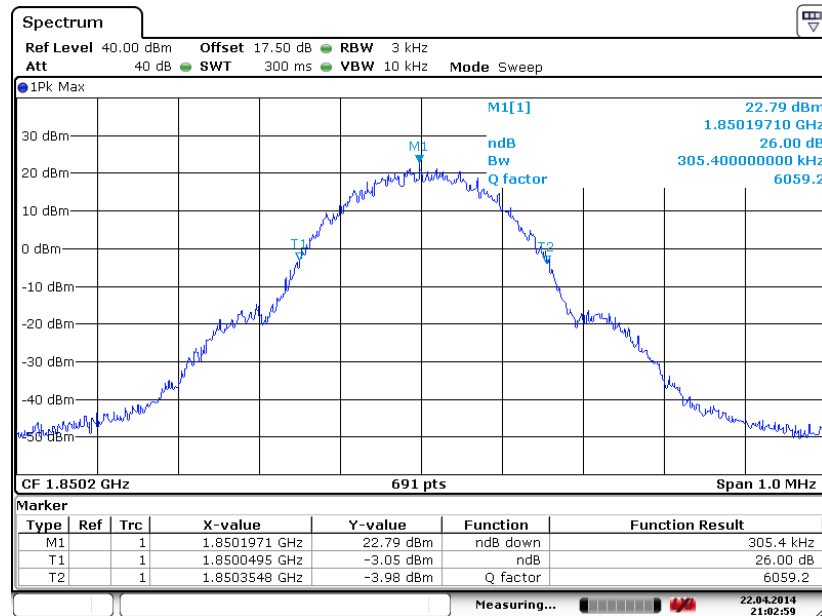

Date: 22. APR. 2014 21:02:59



99% Occupied Bandwidth Plot on Channel 661 (1880.0 MHz)

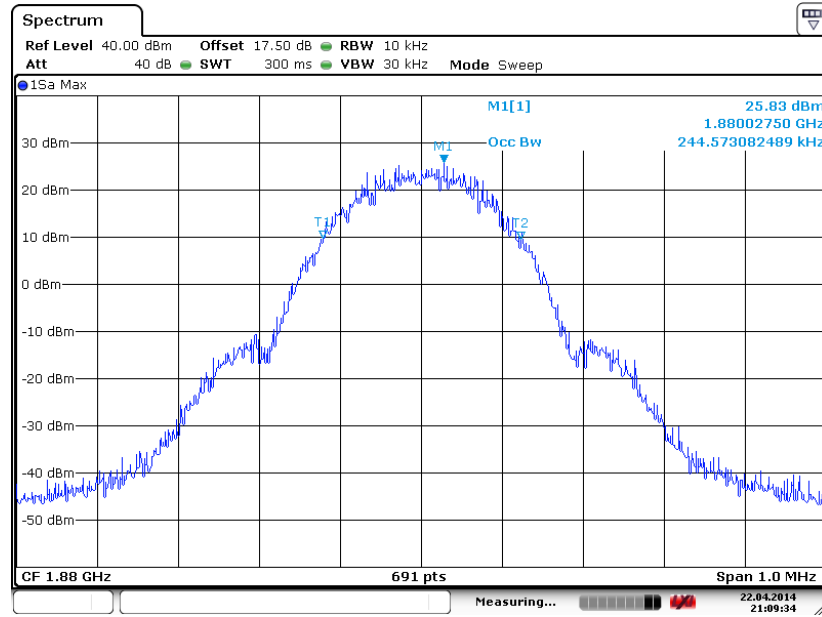

Date: 22.APR.2014 21:09:34

26dB Bandwidth Plot on Channel 661 (1880.0 MHz)

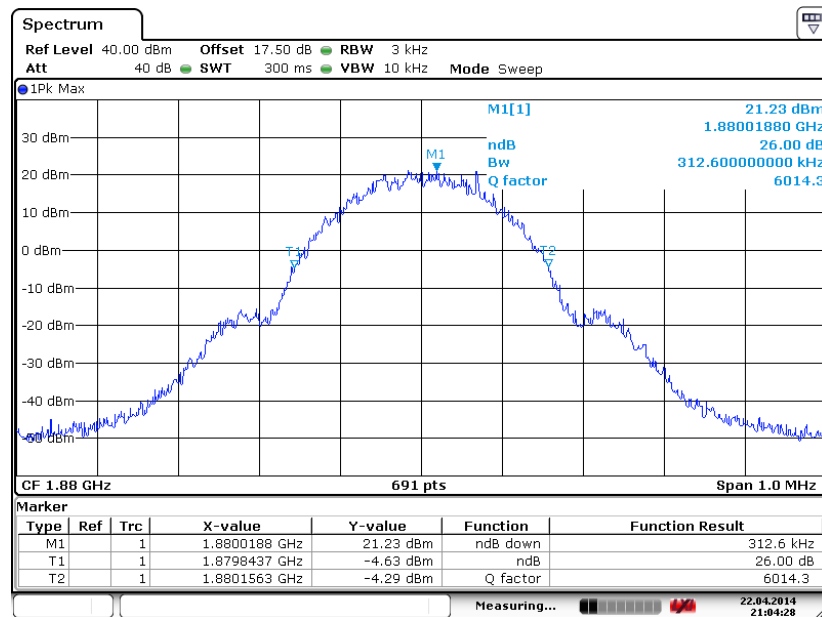

Date: 22.APR.2014 21:04:28



99% Occupied Bandwidth Plot on Channel 810 (1909.8 MHz)

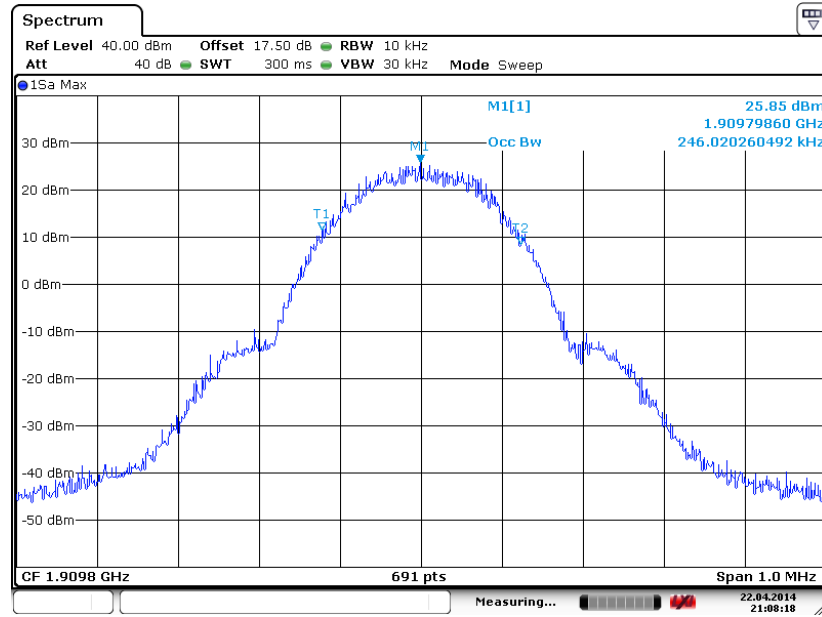

Date: 22.APR.2014 21:08:19

26dB Bandwidth Plot on Channel 810 (1909.8 MHz)

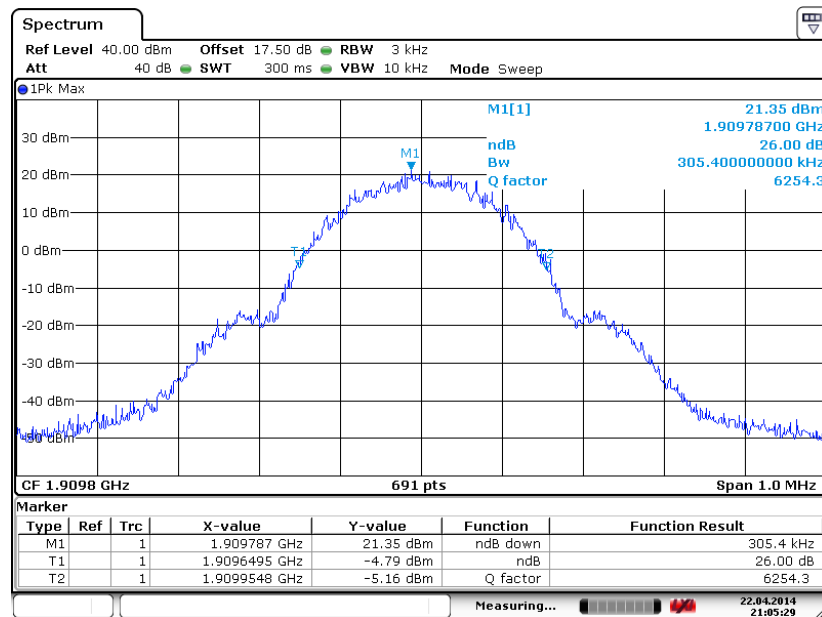

Date: 22.APR.2014 21:05:29



Band :	GSM 1900	Test Mode :	EDGE class 8 Link (8PSK)
--------	----------	-------------	--------------------------

99% Occupied Bandwidth Plot on Channel 512 (1850.2 MHz)

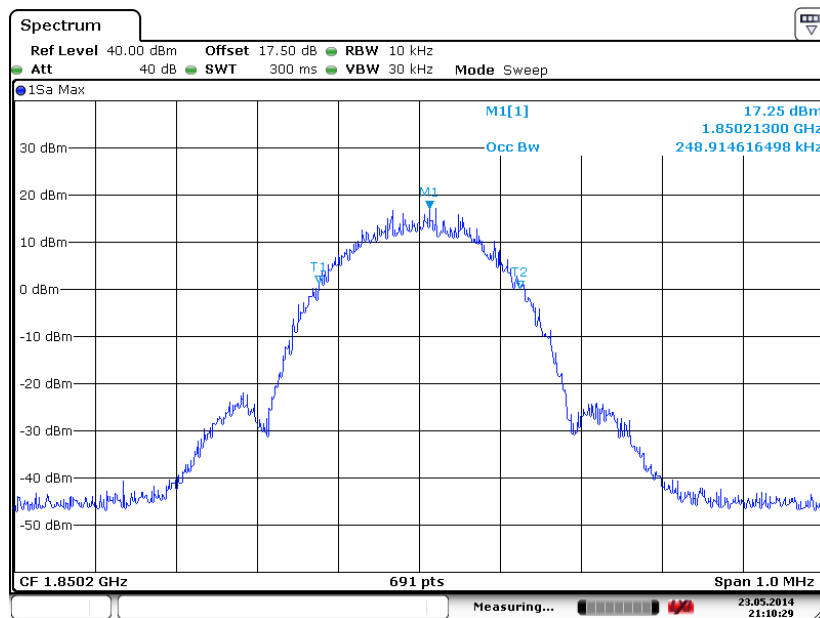

Date: 23.MAY.2014 21:10:30

26dB Bandwidth Plot on Channel 512 (1850.2 MHz)

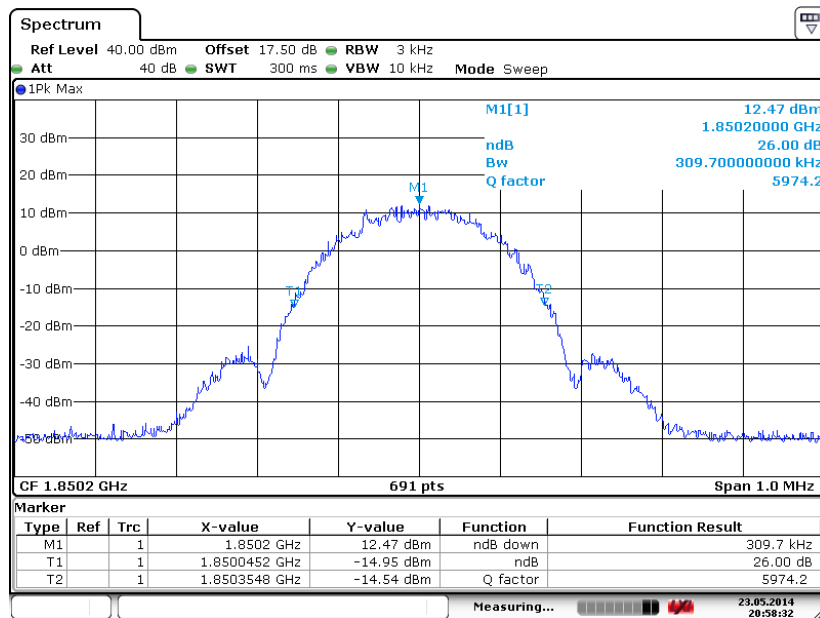

Date: 23.MAY.2014 20:58:32



99% Occupied Bandwidth Plot on Channel 661 (1880.0 MHz)

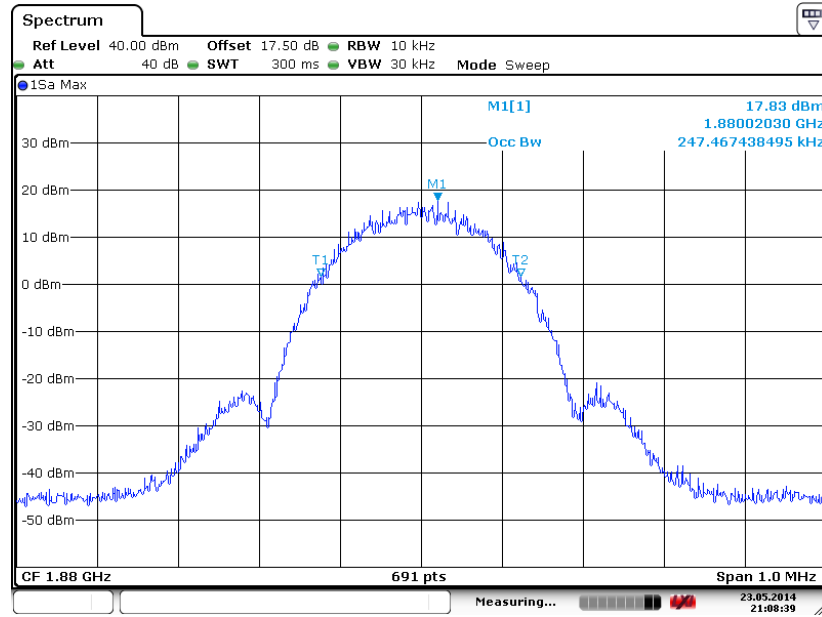

Date: 23.MAY.2014 21:08:40

26dB Bandwidth Plot on Channel 661 (1880.0 MHz)

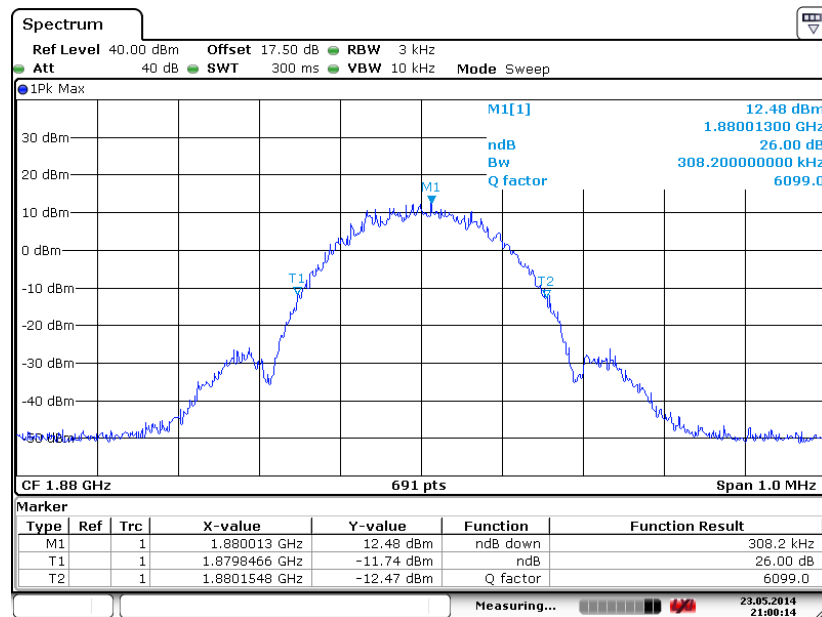

Date: 23.MAY.2014 21:00:14



99% Occupied Bandwidth Plot on Channel 810 (1909.8 MHz)

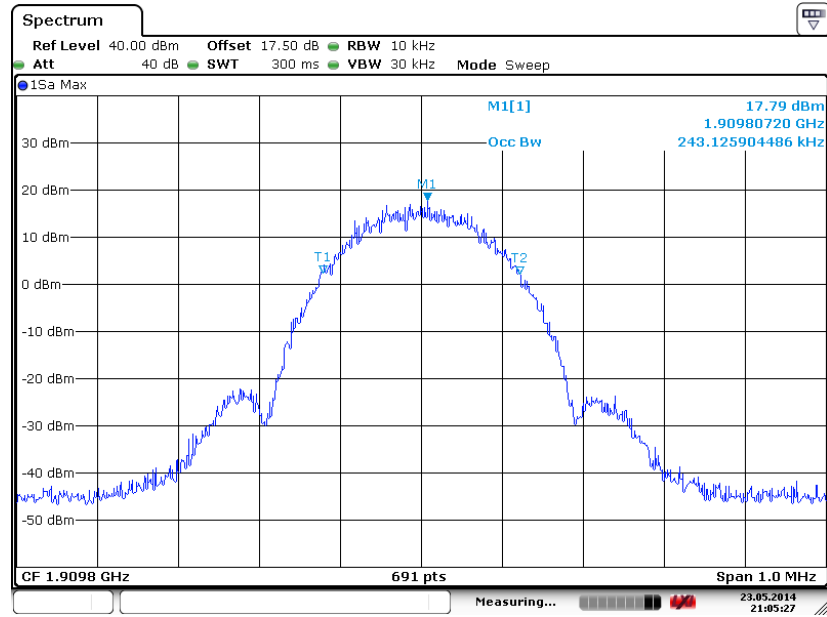

Date: 23.MAY.2014 21:05:27

26dB Bandwidth Plot on Channel 810 (1909.8 MHz)

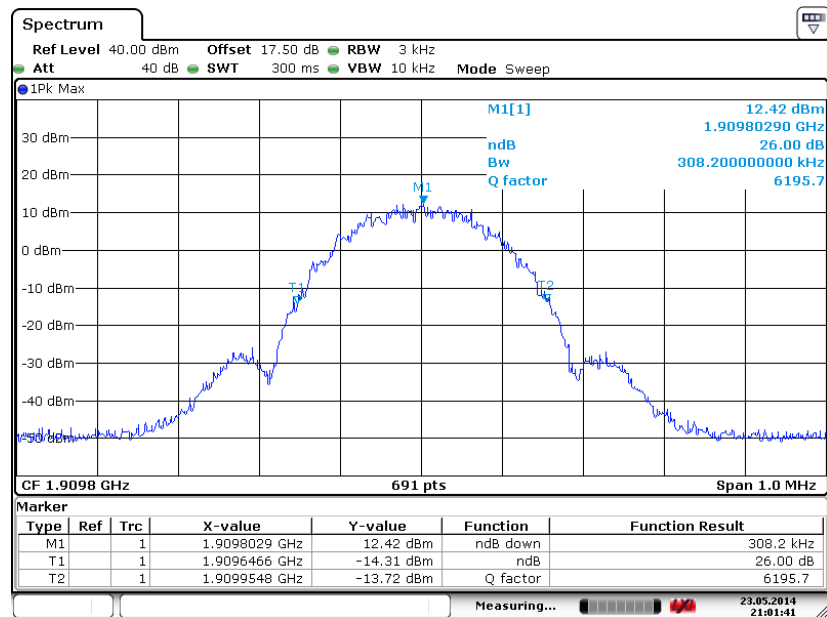

Date: 23.MAY.2014 21:01:41



Band :	WCDMA Band V	Test Mode :	RMC 12.2Kbps Link (QPSK)
--------	--------------	-------------	--------------------------

99% Occupied Bandwidth Plot on Channel 4132 (826.4 MHz)

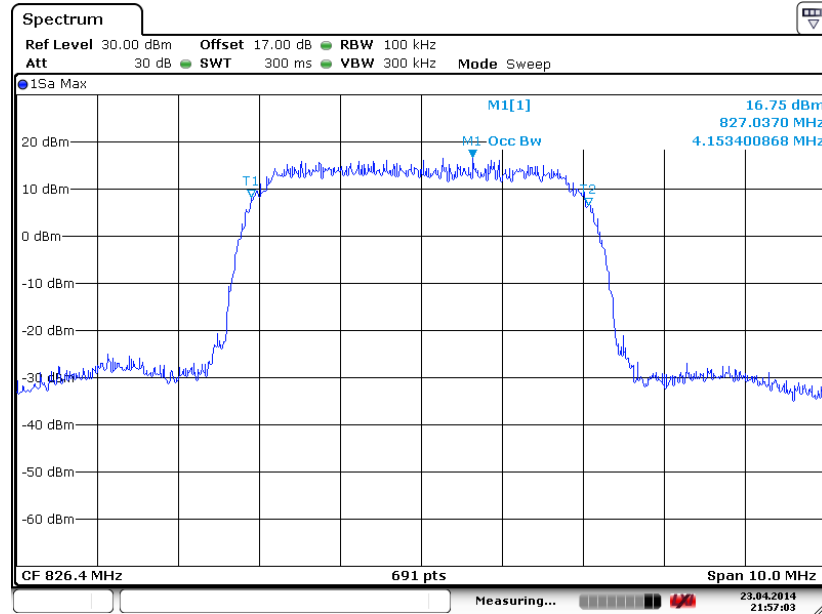

Date: 23. APR. 2014 21:57:03

26dB Bandwidth Plot on Channel 4132 (826.4 MHz)

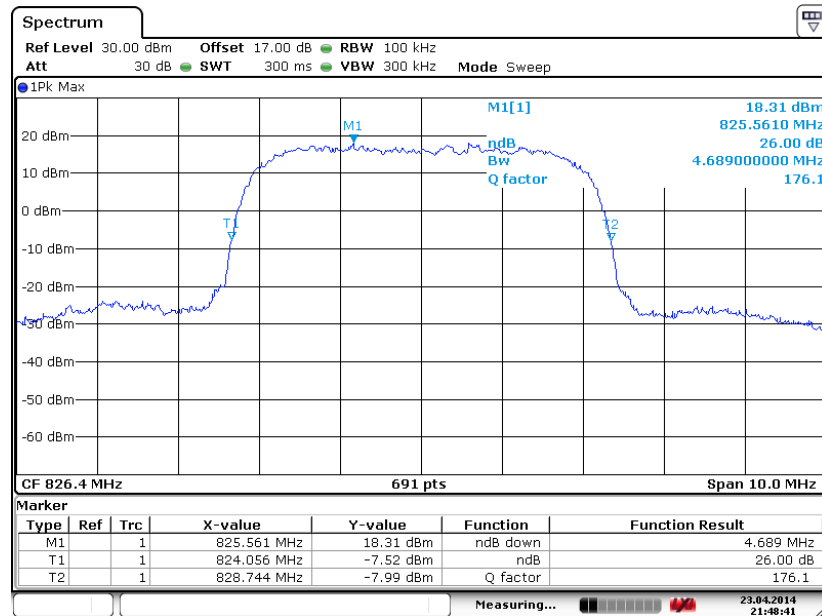

Date: 23. APR. 2014 21:48:41



99% Occupied Bandwidth Plot on Channel 4182 (836.4 MHz)

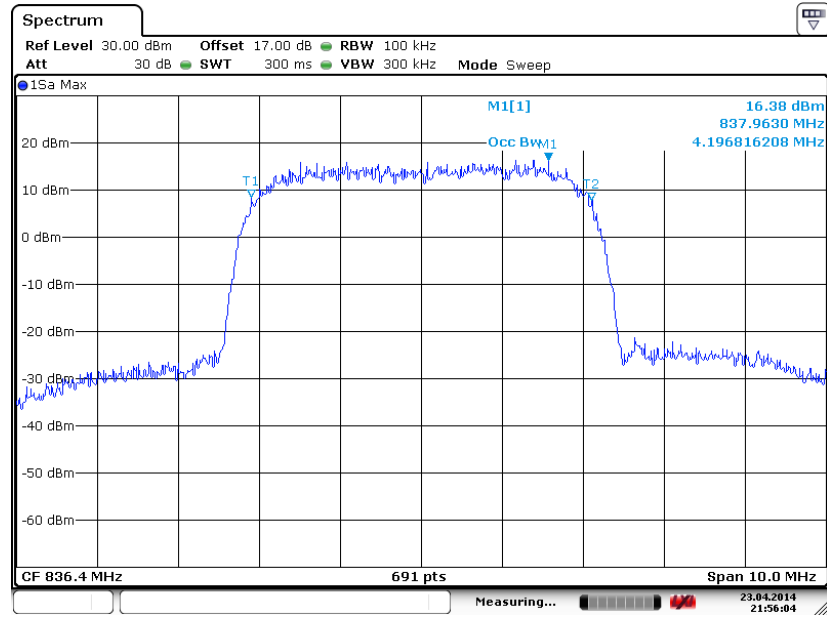

Date: 23.APR.2014 21:56:04

26dB Bandwidth Plot on Channel 4182 (836.4 MHz)

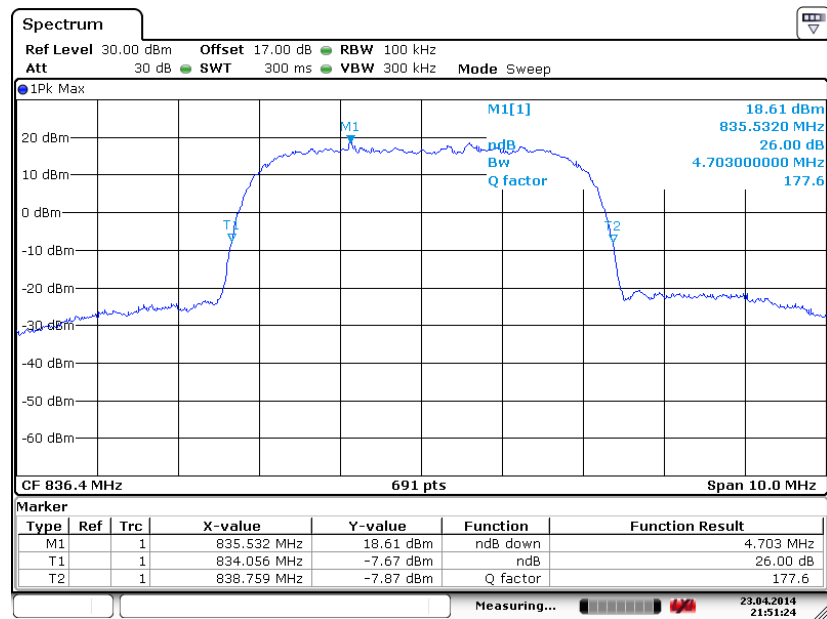

Date: 23.APR.2014 21:51:25



99% Occupied Bandwidth Plot on Channel 4233 (846.6 MHz)

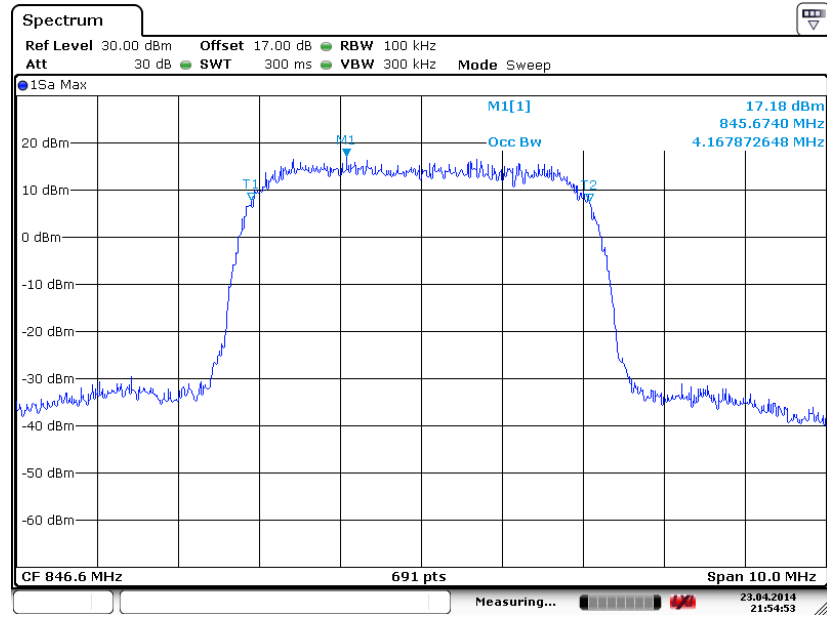

Date: 23.APR.2014 21:54:53

26dB Bandwidth Plot on Channel 4233 (846.6 MHz)

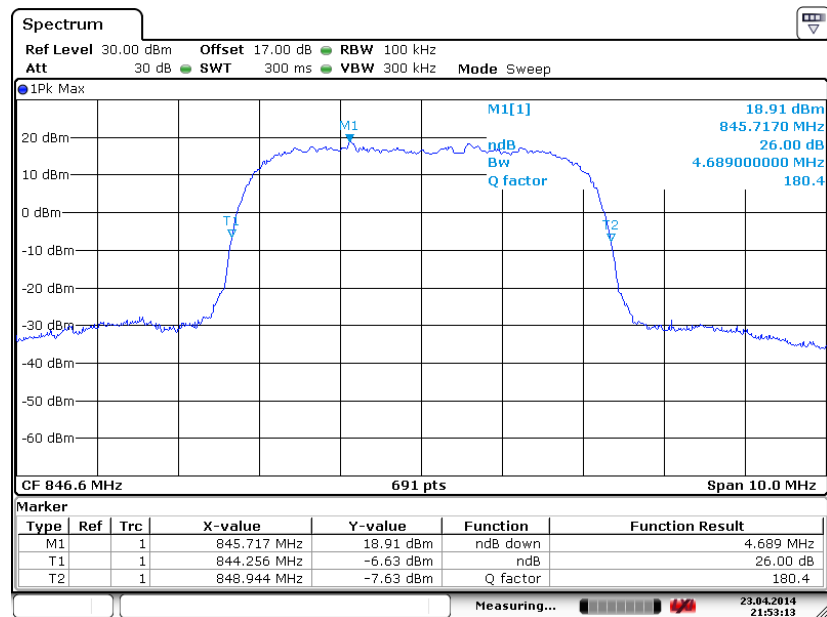

Date: 23.APR.2014 21:53:13



Band :	WCDMA Band II	Test Mode :	RMC 12.2Kbps Link (QPSK)
--------	---------------	-------------	--------------------------

99% Occupied Bandwidth Plot on Channel 9262 (1852.4 MHz)

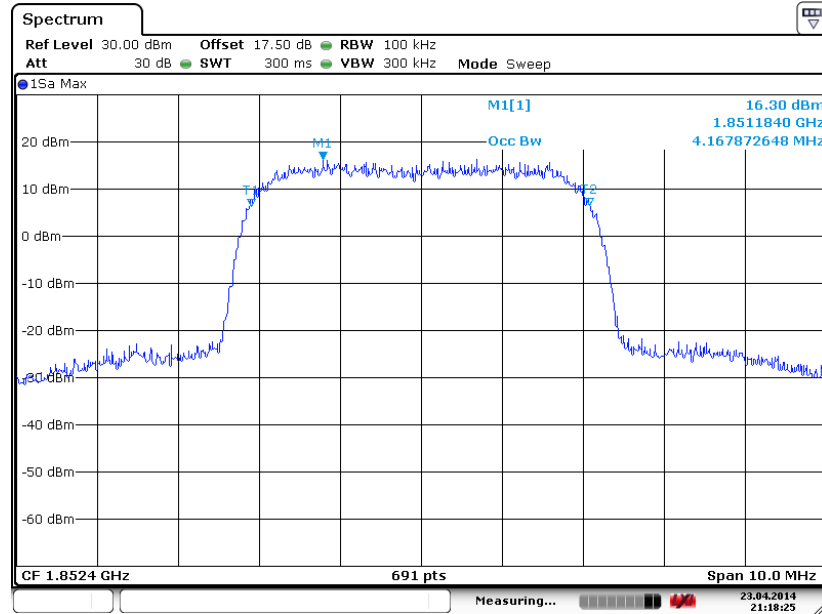

Date: 23. APR. 2014 21:18:26

26dB Bandwidth Plot on Channel 9262 (1852.4 MHz)

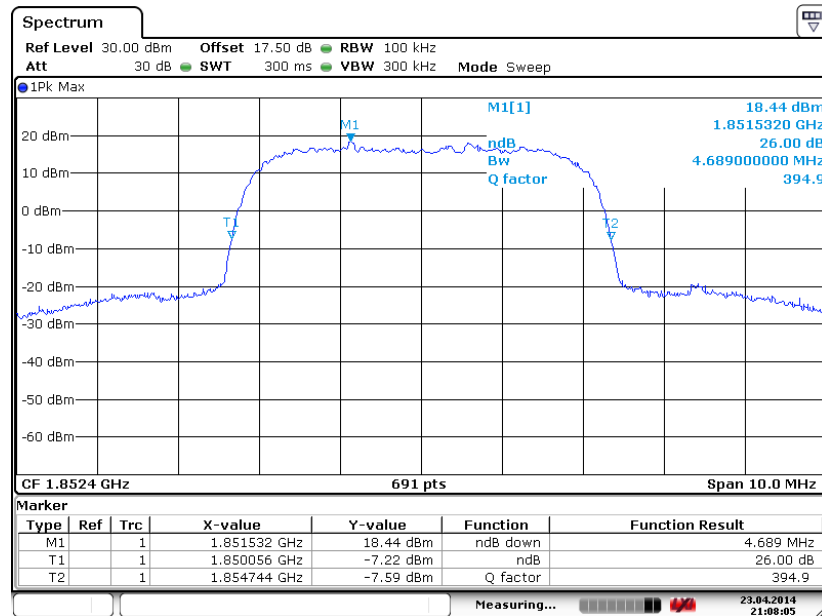

Date: 23. APR. 2014 21:08:05



99% Occupied Bandwidth Plot on Channel 9400 (1880.0 MHz)

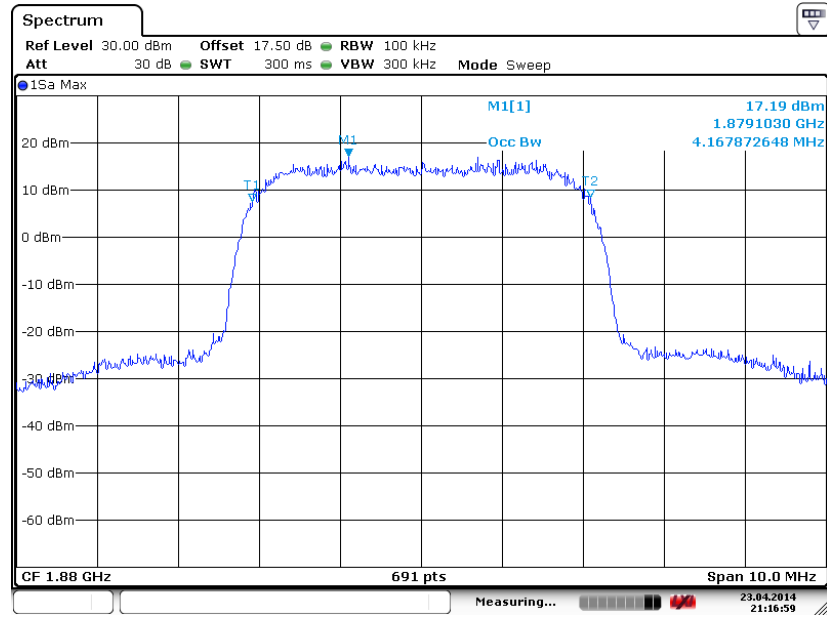

Date: 23.APR.2014 21:17:00

26dB Bandwidth Plot on Channel 9400 (1880.0 MHz)

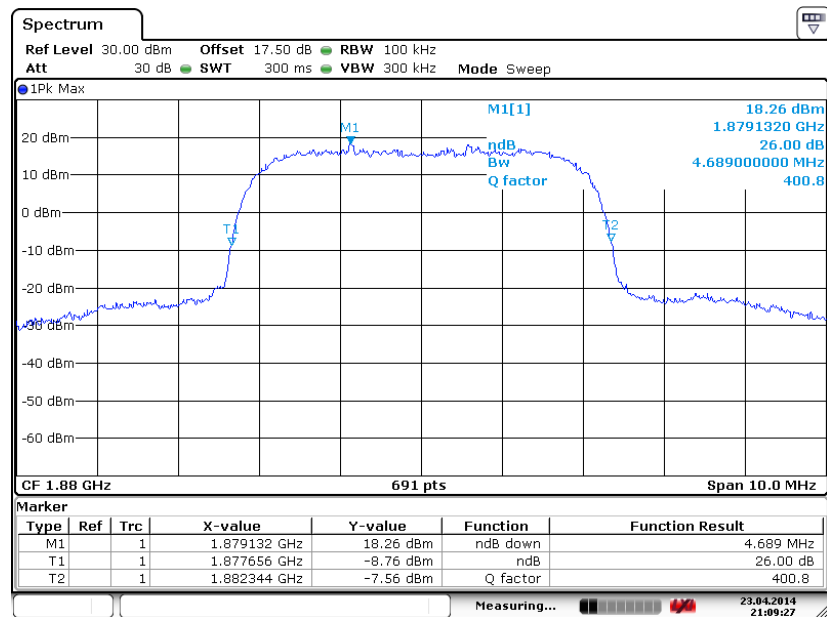

Date: 23.APR.2014 21:09:27



99% Occupied Bandwidth Plot on Channel 9538 (1907.6 MHz)

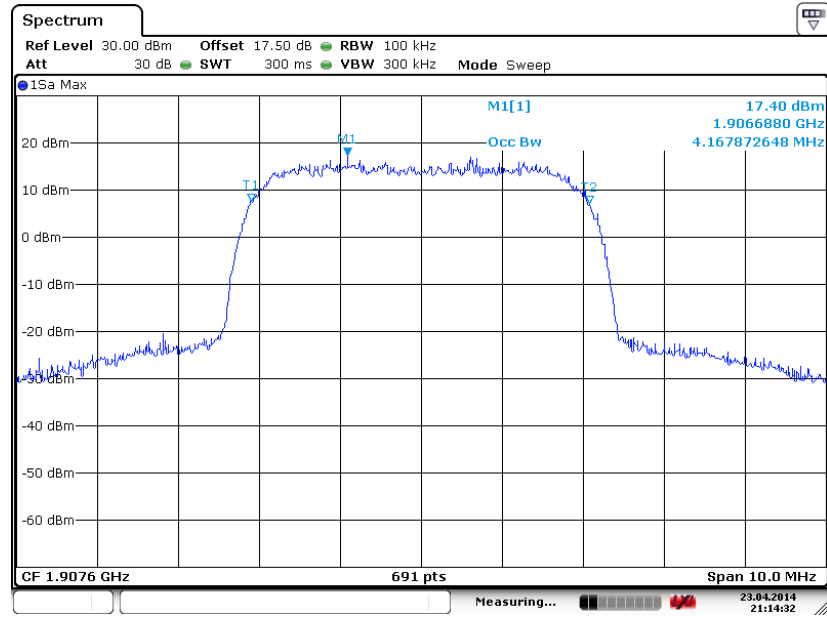

Date: 23.APR.2014 21:14:33

26dB Bandwidth Plot on Channel 9538 (1907.6 MHz)

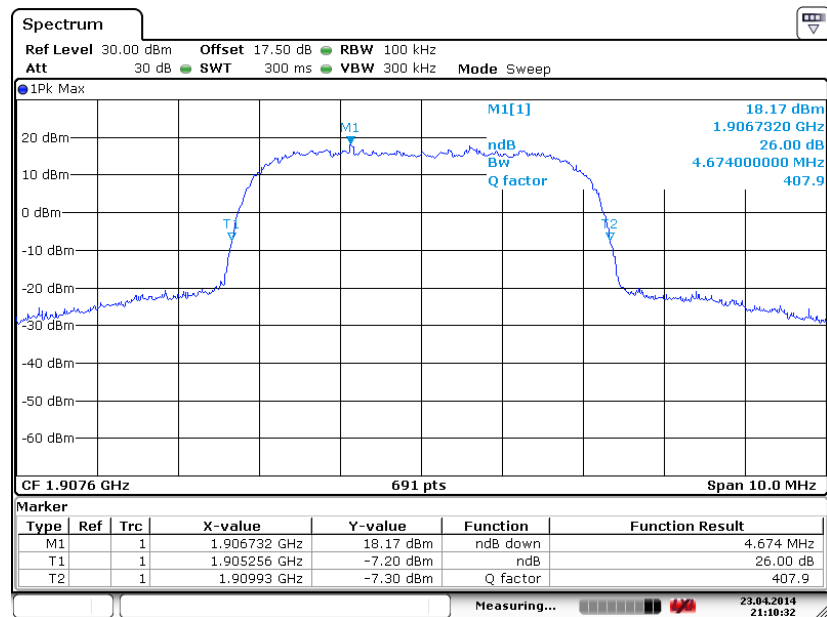

Date: 23.APR.2014 21:10:32

3.5 Band Edge Measurement

3.5.1 Description of Band Edge Measurement

The power of any emission outside of the authorized operating frequency ranges must be lower than the transmitter power (P) by a factor of at least $43 + 10 \log (P)$ dB.

3.5.2 Measuring Instruments

The measuring equipment is listed in the section 4 of this test report.

3.5.3 Test Procedures

1. The EUT was connected to the spectrum analyzer and system simulator via a power divider.
2. The RF output of EUT was connected to the spectrum analyzer by an RF cable and attenuator. The path loss was compensated to the results for each measurement.
3. The band edges of low and high channels for the highest RF powers were measured.
4. The RF fundamental frequency should be excluded against the limit line in the operating frequency band.
5. The limit line is derived from $43 + 10\log(P)$ dB below the transmitter power P(Watts)
 $= P(W) - [43 + 10\log(P)] \text{ (dB)}$
 $= [30 + 10\log(P)] \text{ (dBm)} - [43 + 10\log(P)] \text{ (dB)}$
 $= -13\text{dBm}.$

3.5.4 Test Setup

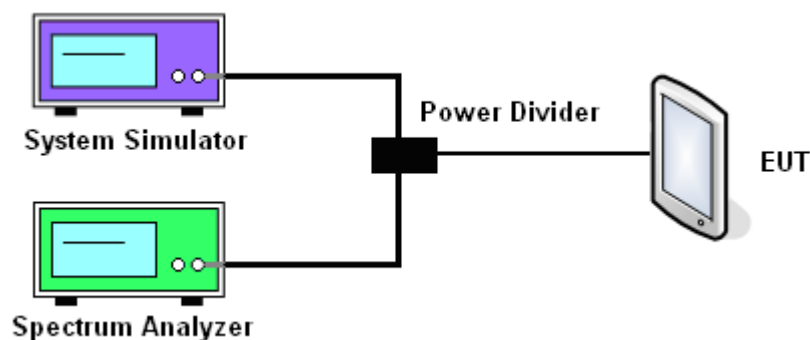

3.5.5 Test Result (Plots) of Conducted Band Edge

Band :	GSM850	Test Mode :	GSM Link (GMSK)
Correction Factor :	0.18dB	Maximum 26dB Bandwidth :	0.313MHz
Band Edge :	-16.43dBm	Measurement Value :	-16.61dBm

Lower Band Edge Plot on Channel 128 (824.2 MHz)

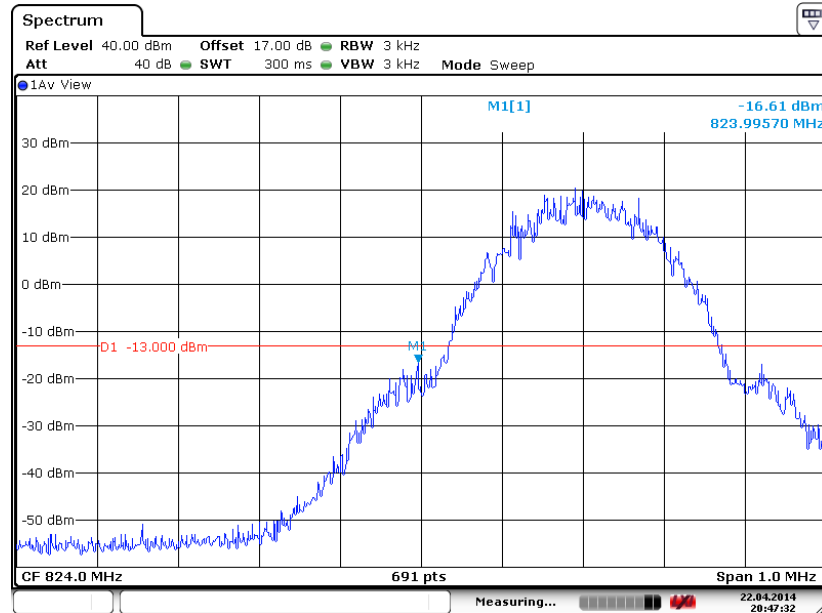

Date: 22.APR.2014 20:47:32

1. Correction Factor(dB)= $10\log(1\% \text{ Emission BW/RBW})$
2. Band Edge= Measurement Value + Correction Factor(dB)



Band :	GSM850	Test Mode :	GSM Link (GMSK)
Correction Factor :	0.18dB	Maximum 26dB Bandwidth :	0.313MHz
Band Edge :	-17.09 dBm	Measurement Value :	-17.27dBm

Higher Band Edge Plot on Channel 251 (848.8 MHz)

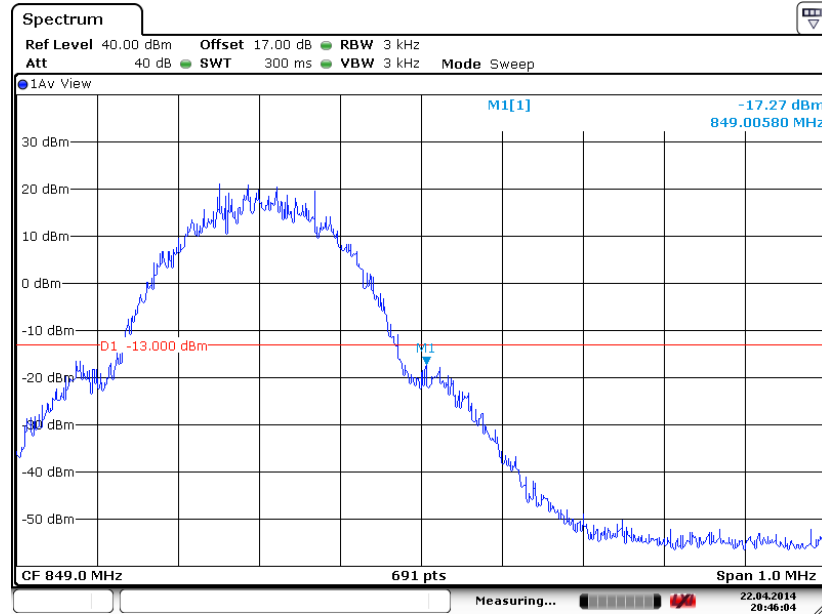

Date: 22.APR.2014 20:46:04

1. Correction Factor(dB)= 10log(1% Emission BW/RBW)
2. Band Edge= Measurement Value + Correction Factor(dB)



Band :	GSM850	Test Mode :	EDGE class 8 Link (8PSK)
Correction Factor :	0.20dB	Maximum 26dB Bandwidth :	0.314MHz
Band Edge :	-24.77dBm	Measurement Value :	-24.97dBm

Lower Band Edge Plot on Channel 128 (824.2 MHz)

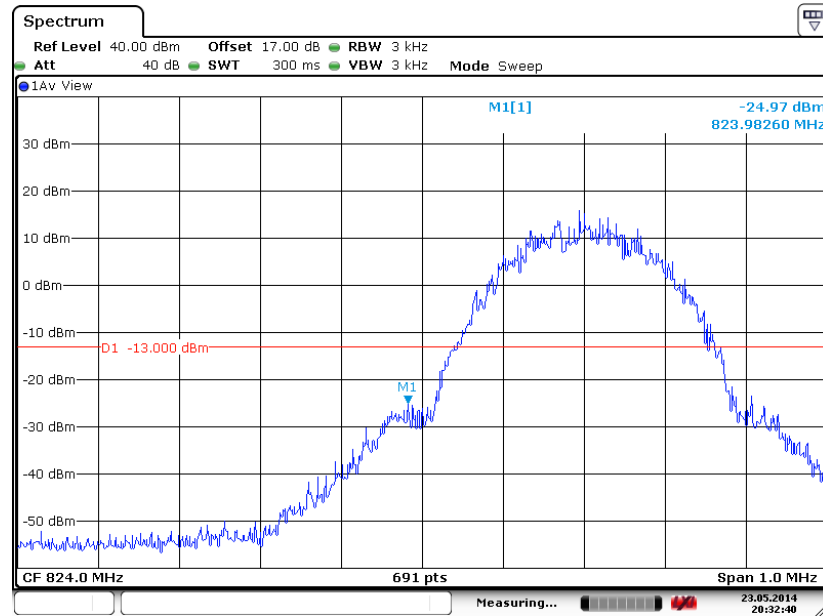

Date: 23.MAY.2014 20:32:40

1. Correction Factor(dB)= $10\log(1\% \text{ Emission BW/RBW})$
2. Band Edge= Measurement Value + Correction Factor(dB)



Band :	GSM850	Test Mode :	EDGE class 8 Link (8PSK)
Correction Factor :	0.20dB	Maximum 26dB Bandwidth :	0.314MHz
Band Edge :	-24.86dBm	Measurement Value :	-25.06dBm

Higher Band Edge Plot on Channel 251 (848.8 MHz)

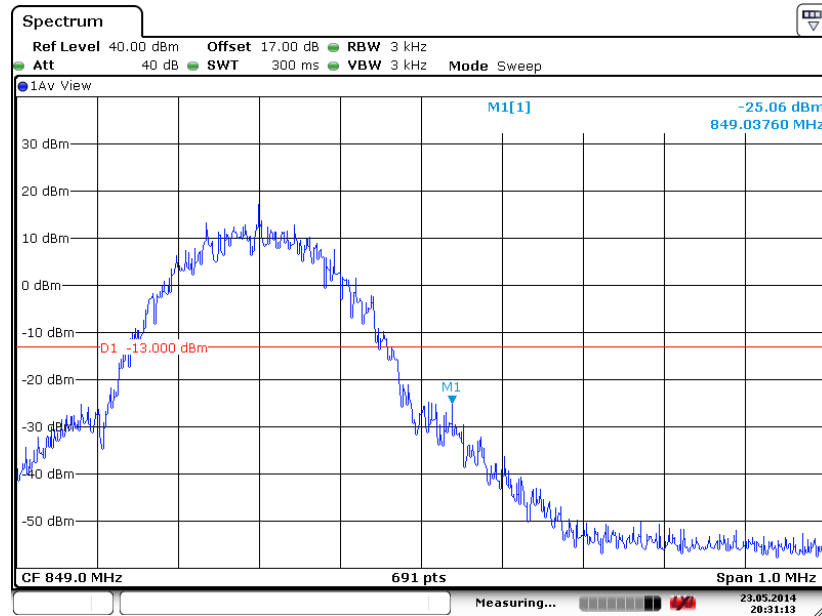

Date: 23.MAY.2014 20:31:13

1. Correction Factor(dB)= $10\log(1\% \text{ Emission BW/RBW})$
2. Band Edge= Measurement Value + Correction Factor(dB)



Band :	GSM1900	Test Mode :	GSM Link (GMSK)
Correction Factor :	0.18dB	Maximum 26dB Bandwidth :	0.313MHz
Band Edge :	-18.45dBm	Measurement Value :	-18.63dBm

Lower Band Edge Plot on Channel 512 (1850.2 MHz)

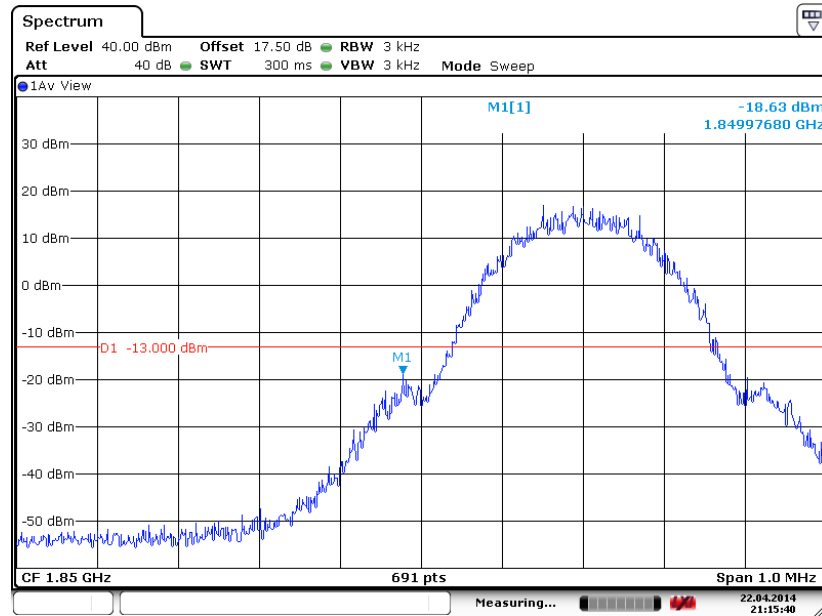

Date: 22.APR.2014 21:15:40

1. Correction Factor(dB)= $10\log(1\% \text{ Emission BW/RBW})$
2. Band Edge= Measurement Value + Correction Factor(dB)

Band :	GSM1900	Test Mode :	GSM Link (GMSK)
Correction Factor :	0.18dB	Maximum 26dB Bandwidth :	0.313MHz
Band Edge :	-18.01dBm	Measurement Value :	-18.19dBm

Higher Band Edge Plot on Channel 810 (1909.8 MHz)

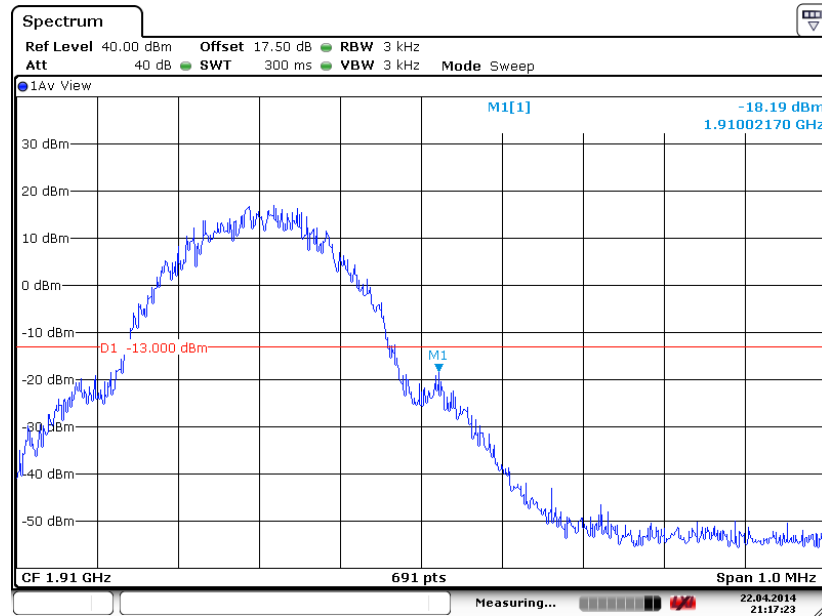

Date: 22.APR.2014 21:17:23

1. Correction Factor(dB)= $10\log(1\% \text{ Emission BW/RBW})$
2. Band Edge= Measurement Value + Correction Factor(dB)



Band :	GSM1900	Test Mode :	EDGE class 8 Link (8PSK)
Correction Factor :	0.14dB	Maximum 26dB Bandwidth :	0.310MHz
Band Edge :	-30.73dBm	Measurement Value :	-30.87dBm

Lower Band Edge Plot on Channel 512 (1850.2 MHz)

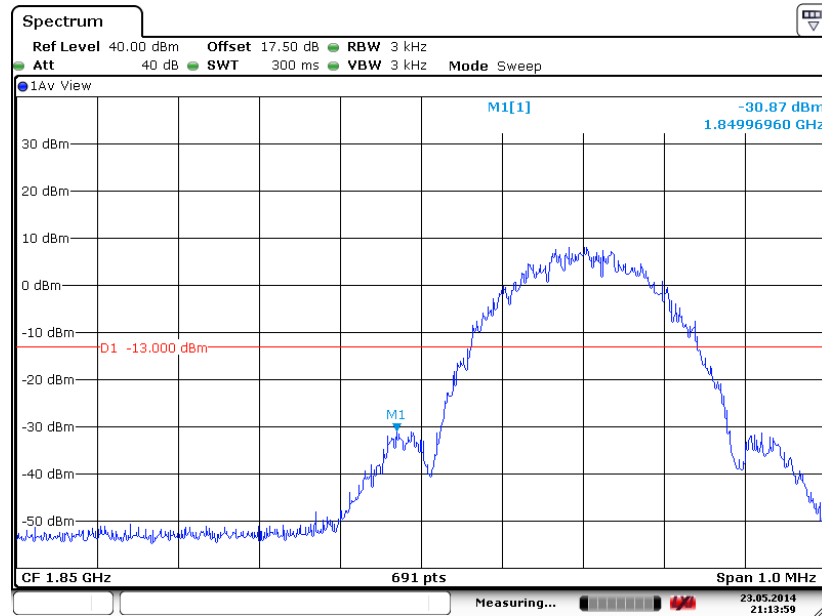

Date: 23.MAY.2014 21:13:59

1. Correction Factor(dB)= $10\log(1\% \text{ Emission BW/RBW})$
2. Band Edge= Measurement Value + Correction Factor(dB)

Band :	GSM1900	Test Mode :	EDGE class 8 Link (8PSK)
Correction Factor :	0.14dB	Maximum 26dB Bandwidth :	0.310MHz
Band Edge :	-31.04dBm	Measurement Value :	-31.18dBm

Higher Band Edge Plot on Channel 810 (1909.8 MHz)

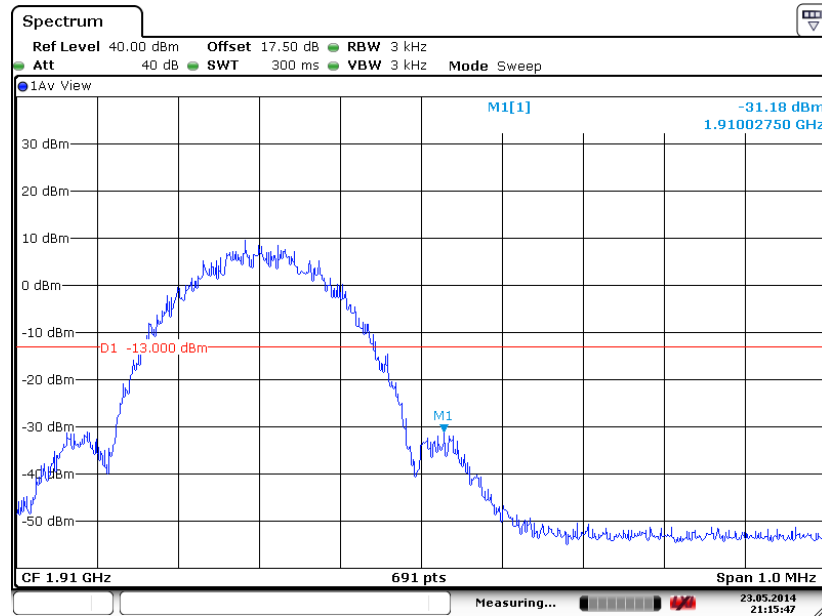

Date: 23.MAY.2014 21:15:47

1. Correction Factor(dB)= $10\log(1\% \text{ Emission BW/RBW})$
2. Band Edge= Measurement Value + Correction Factor(dB)



Band :	WCDMA Band V	Test Mode :	RMC 12.2Kbps Link (QPSK)
Correction Factor :	-3.28dB	Maximum 26dB Bandwidth :	4.700MHz
Band Edge :	-27.62dBm	Measurement Value :	-24.34dBm

Lower Band Edge Plot on Channel 4132 (826.4 MHz)

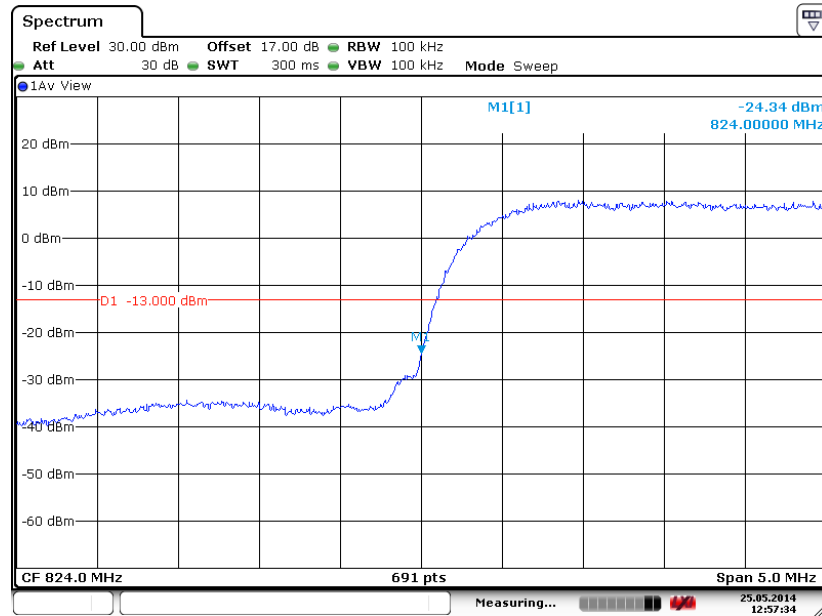

Date: 25.MAY.2014 12:57:34

1. Correction Factor(dB)= $10\log(1\% \text{ Emission BW/RBW})$
2. Band Edge= Measurement Value + Correction Factor(dB)



Band :	WCDMA Band V	Test Mode :	RMC 12.2Kbps Link (QPSK)
Correction Factor :	-3.28dB	Maximum 26dB Bandwidth :	4.700MHz
Band Edge :	-28.79dBm	Measurement Value :	-25.51dBm

Higher Band Edge Plot on Channel 4233 (846.6 MHz)

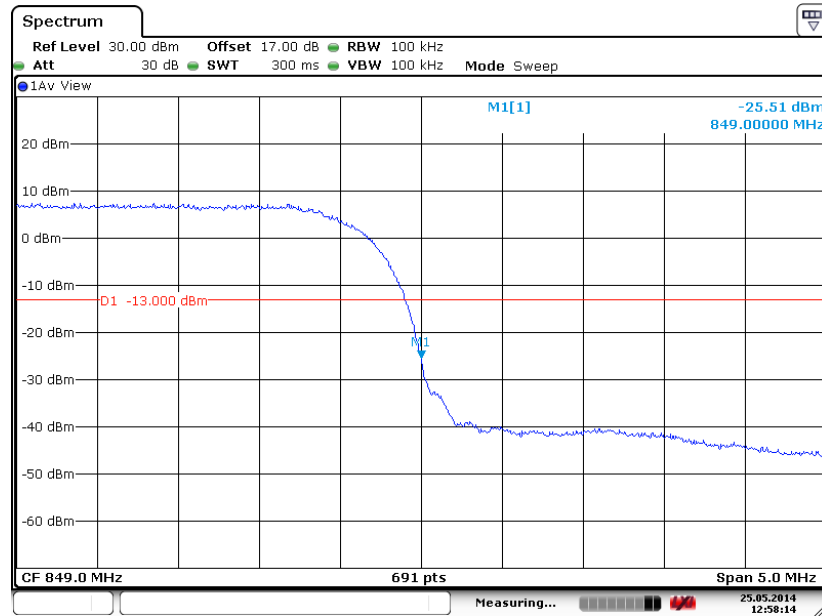

Date: 25.MAY.2014 12:58:14

1. Correction Factor(dB)= $10\log(1\% \text{ Emission BW/RBW})$
2. Band Edge= Measurement Value + Correction Factor(dB)



Band :	WCDMA Band II	Test Mode :	RMC 12.2Kbps Link (QPSK)
Correction Factor :	-3.29dB	Maximum 26dB Bandwidth :	4.690MHz
Band Edge :	-27.42dBm	Measurement Value :	-24.13dBm

Lower Band Edge Plot on Channel 9262 (1852.4 MHz)

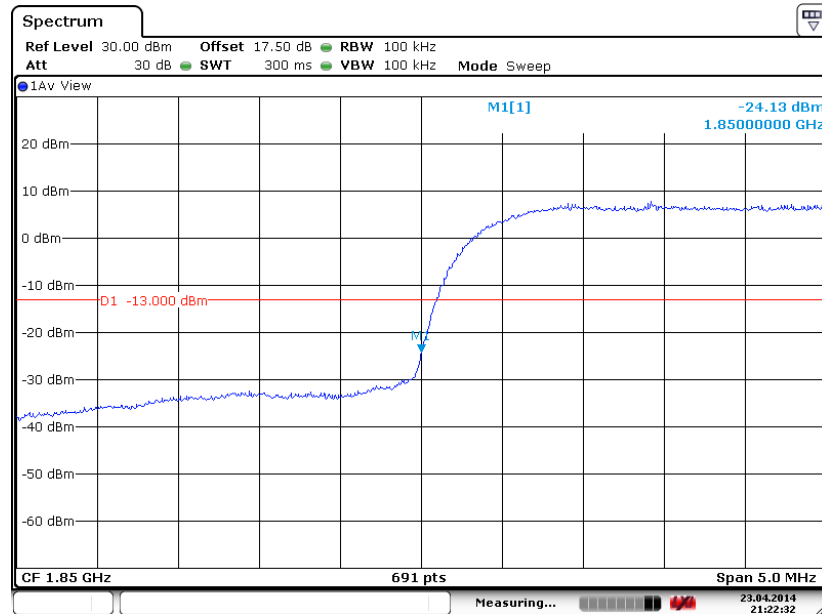

Date: 23.APR.2014 21:22:33

1. Correction Factor(dB)= $10\log(1\% \text{ Emission BW/RBW})$
2. Band Edge= Measurement Value + Correction Factor(dB)



Band :	WCDMA Band II	Test Mode :	RMC 12.2Kbps Link (QPSK)
Correction Factor :	-3.29dB	Maximum 26dB Bandwidth :	4.690MHz
Band Edge :	-27.95dBm	Measurement Value :	-24.66dBm

Higher Band Edge Plot on Channel 9538 (1907.6 MHz)

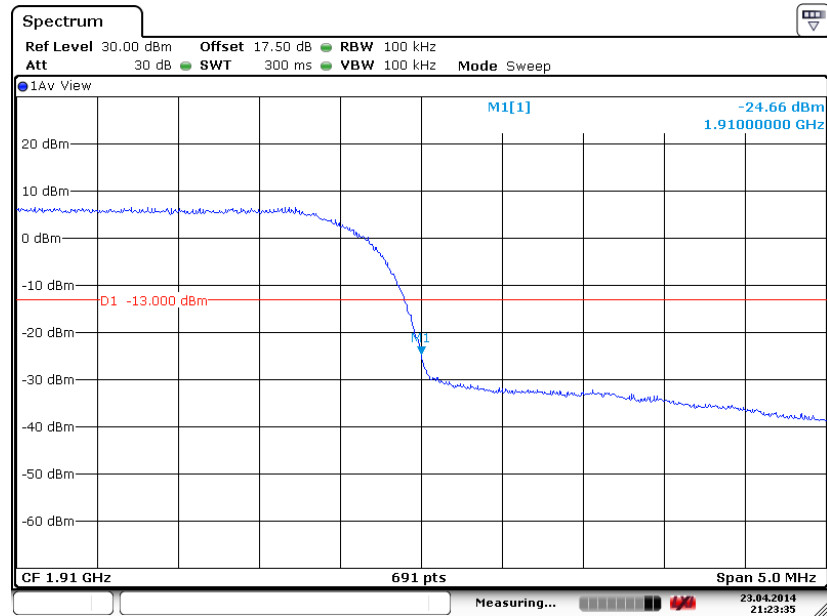

Date: 23.APR.2014 21:23:36

1. Correction Factor(dB)= $10\log(1\% \text{ Emission BW/RBW})$
2. Band Edge= Measurement Value + Correction Factor(dB)

3.6 Conducted Spurious Emission Measurement

3.6.1 Description of Conducted Spurious Emission Measurement

The power of any emission outside of the authorized operating frequency ranges must be lower than the transmitter power (P) by a factor of at least $43 + 10 \log (P)$ dB.

It is measured by means of a calibrated spectrum analyzer and scanned from 30 MHz up to a frequency including its 10th harmonic.

3.6.2 Measuring Instruments

The measuring equipment is listed in the section 4 of this test report.

3.6.3 Test Procedures

1. The EUT was connected to the spectrum analyzer and system simulator via a power divider.
2. The RF output of EUT was connected to the spectrum analyzer by an RF cable and attenuator. The path loss was compensated to the results for each measurement.
3. The middle channel for the highest RF power within the transmitting frequency was measured.
4. The conducted spurious emission for the whole frequency range was taken.
5. The RF fundamental frequency should be excluded against the limit line in the operating frequency band.
6. The limit line is derived from $43 + 10\log(P)$ dB below the transmitter power P(Watts)

$$= P(W) - [43 + 10\log(P)] \text{ (dB)}$$

$$= [30 + 10\log(P)] \text{ (dBm)} - [43 + 10\log(P)] \text{ (dB)}$$

$$= -13\text{dBm}.$$

3.6.4 Test Setup

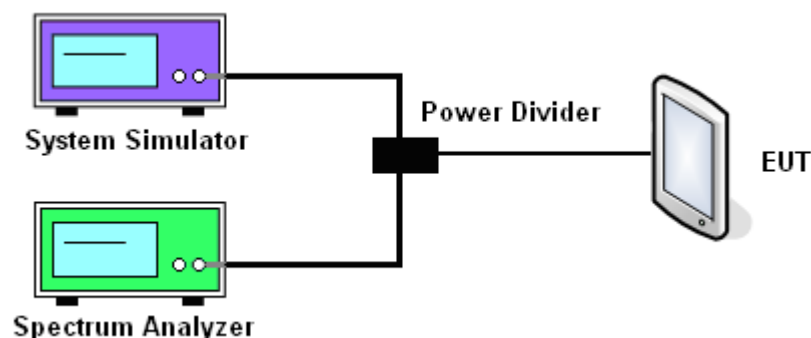



3.6.5 Test Result (Plots) of Conducted Spurious Emission

Band :	GSM850	Channel :	CH189
Test Mode :	GSM Link (GMSK)	Frequency :	836.4 MHz

Conducted Spurious Emission Plot between 30MHz ~ 1GHz

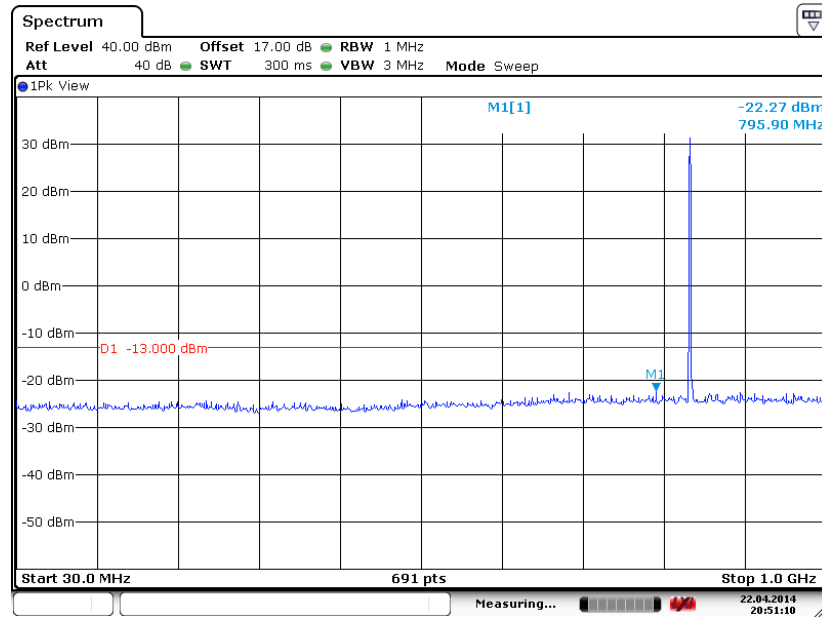

Date: 22.APR.2014 20:51:10

Conducted Spurious Emission Plot between 1GHz ~ 3GHz

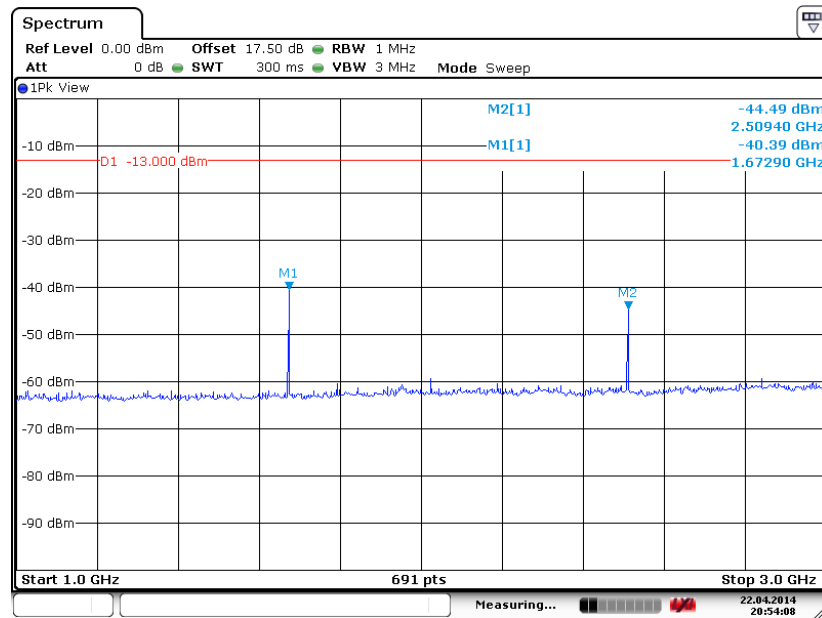

Date: 22.APR.2014 20:54:08



Conducted Spurious Emission Plot between 3GHz ~ 7GHz

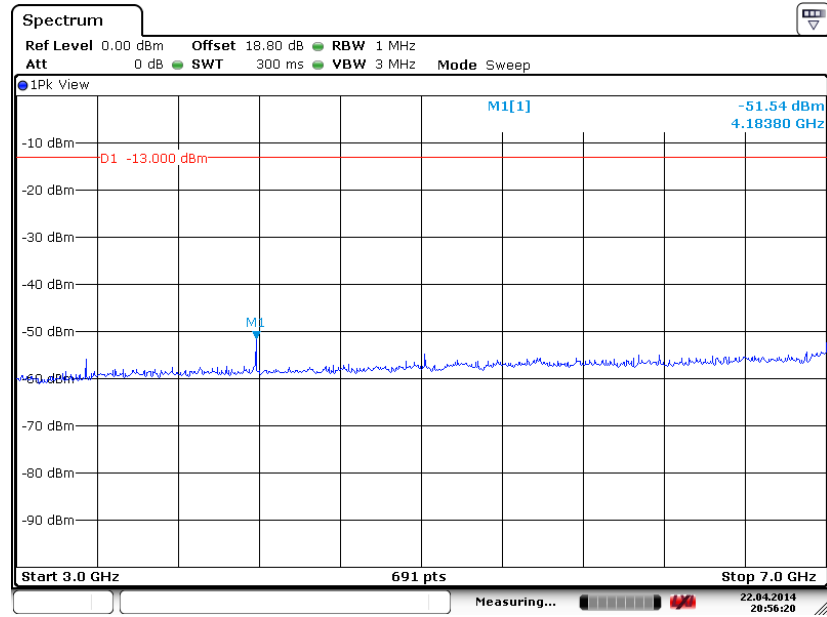

Date: 22.APR.2014 20:56:20

Conducted Spurious Emission Plot between 7GHz ~ 9GHz

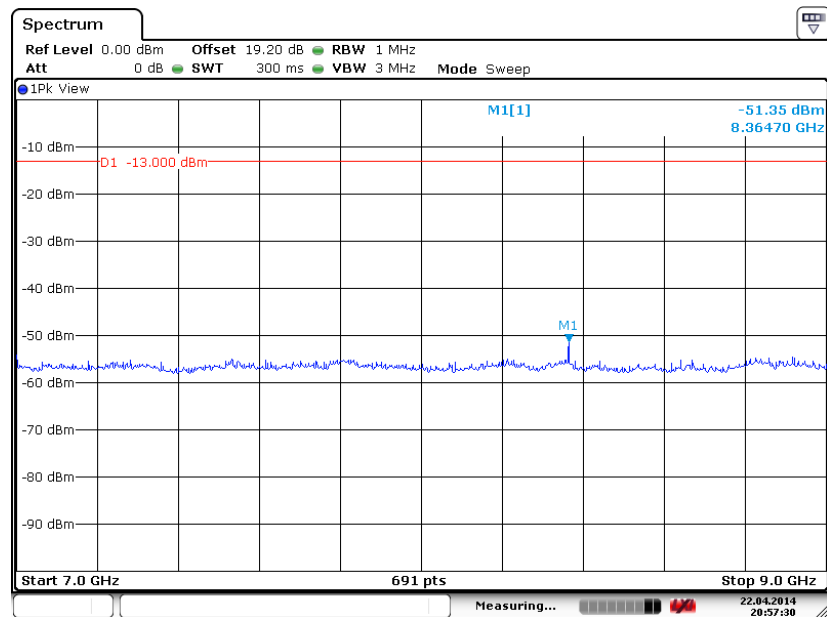

Date: 22.APR.2014 20:57:30



Band :	GSM850	Channel :	CH189
Test Mode :	EDGE class 8 Link (8PSK)	Frequency :	836.4 MHz

Conducted Spurious Emission Plot between 30MHz ~ 1GHz

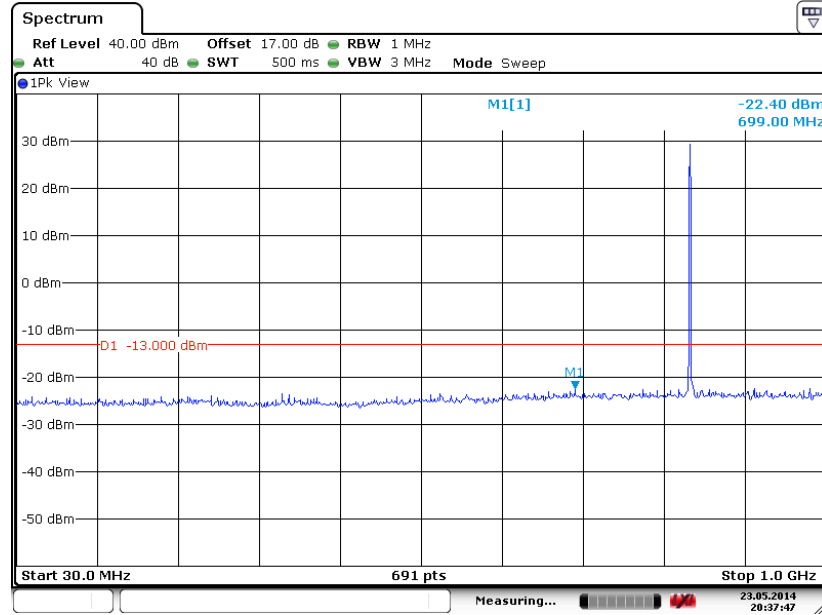

Date: 23.MAY.2014 20:37:47

Conducted Spurious Emission Plot between 1GHz ~ 3GHz

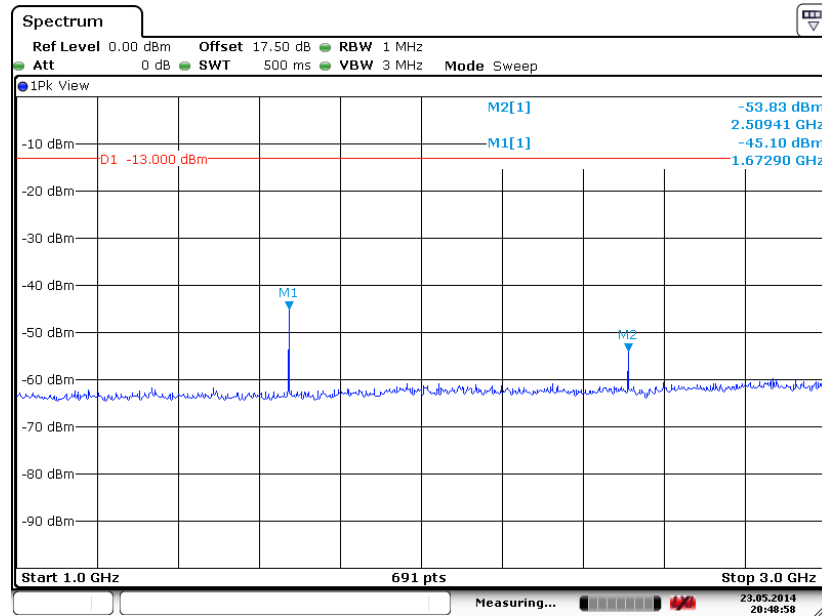

Date: 23.MAY.2014 20:48:58



Conducted Spurious Emission Plot between 3GHz ~ 7GHz

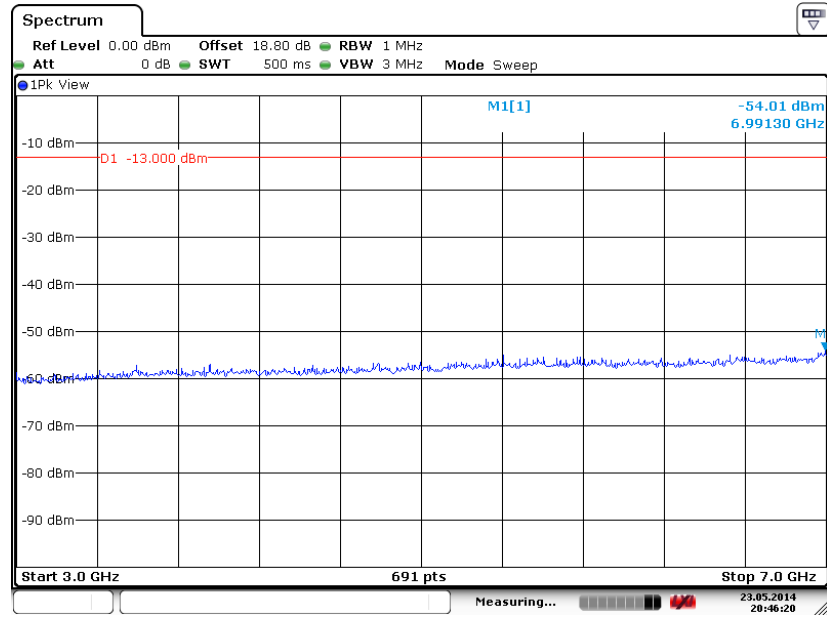

Date: 23.MAY.2014 20:46:21

Conducted Spurious Emission Plot between 7GHz ~ 9GHz

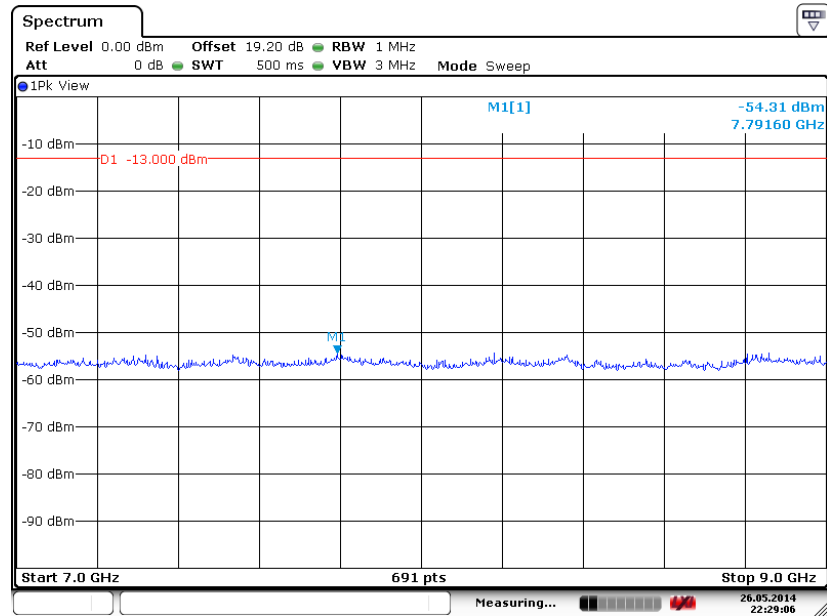

Date: 26.MAY.2014 22:29:05



Band :	GSM1900	Channel :	CH661
Test Mode :	GSM Link (GMSK)	Frequency :	1880.0 MHz

Conducted Spurious Emission Plot between 30MHz ~ 1GHz

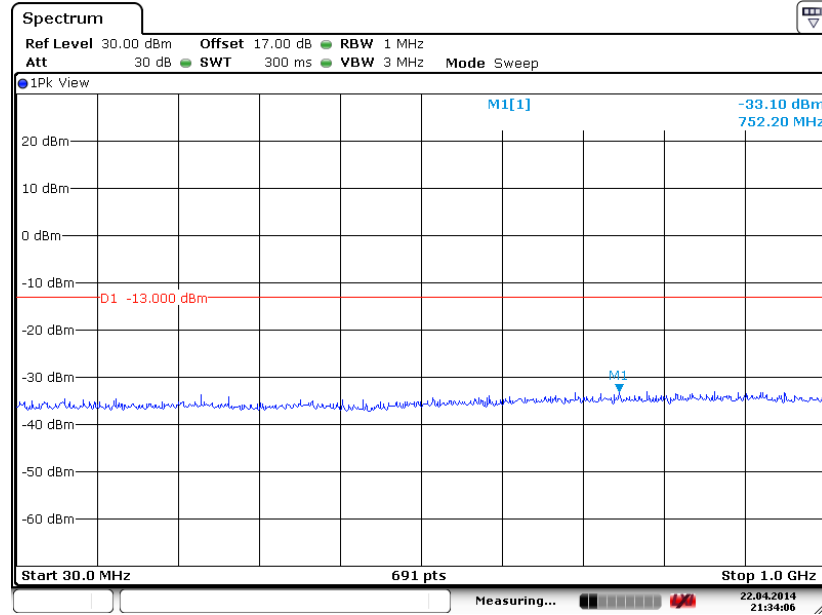

Date: 22.APR.2014 21:34:06

Conducted Spurious Emission Plot between 1GHz ~ 3GHz

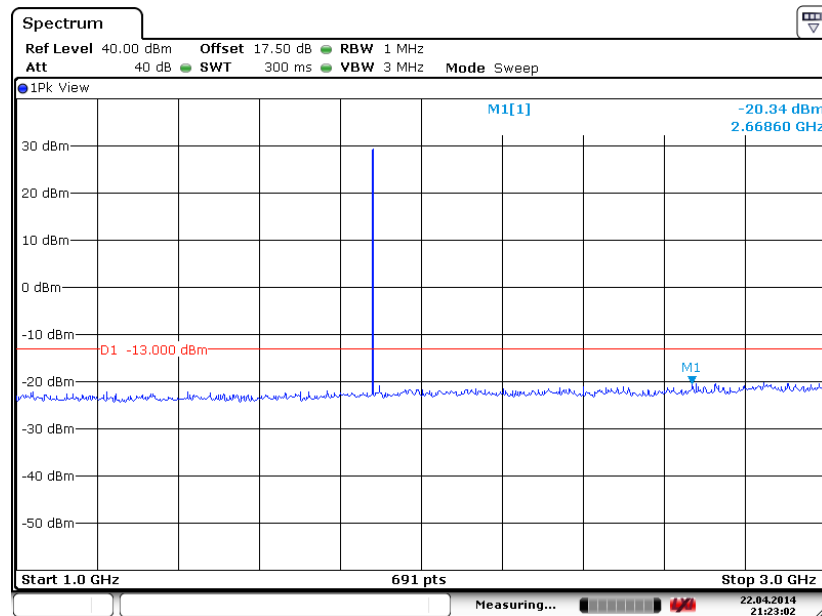

Date: 22.APR.2014 21:23:02



Conducted Spurious Emission Plot between 3GHz ~ 7GHz

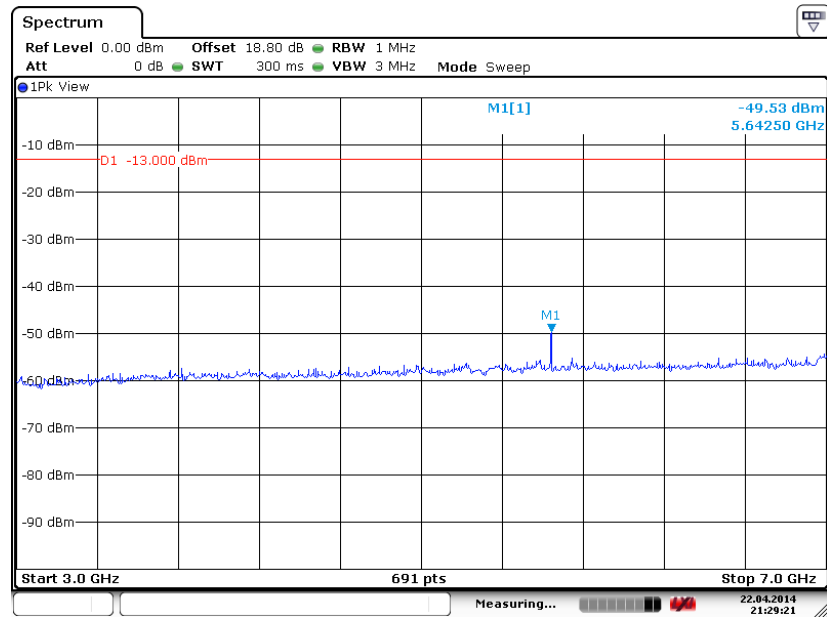

Date: 22.APR.2014 21:29:21

Conducted Spurious Emission Plot between 7GHz ~ 13.6GHz

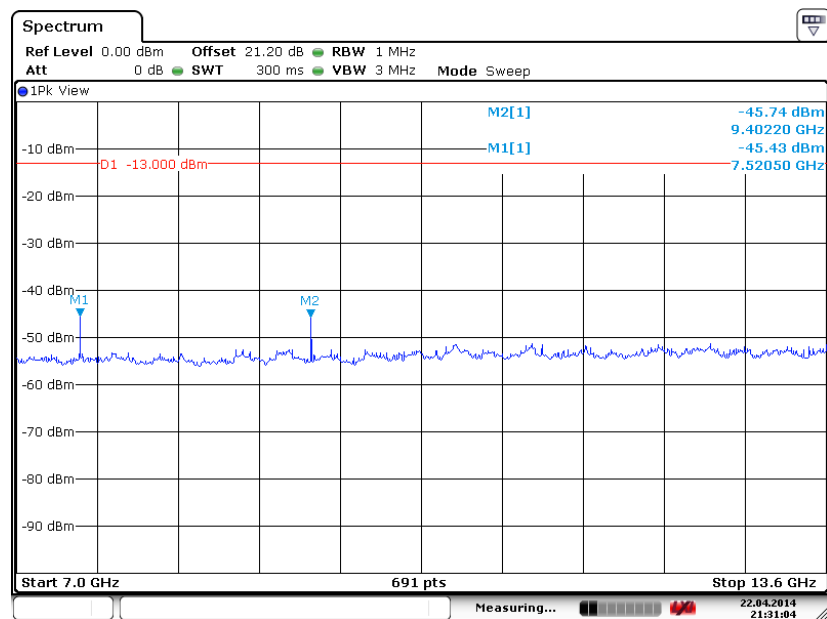

Date: 22.APR.2014 21:31:05



Conducted Spurious Emission Plot between 13.6GHz ~ 19.1GHz

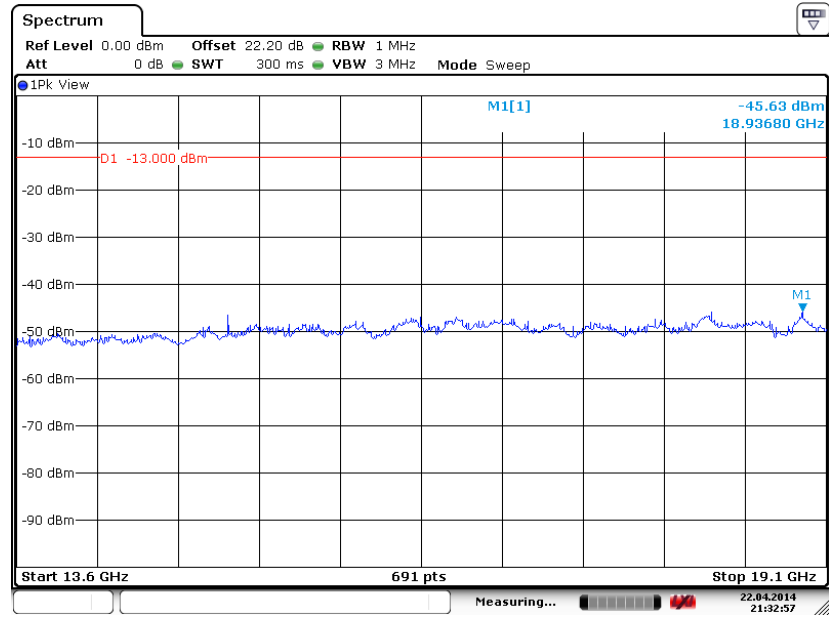

Date: 22.APR.2014 21:32:57



Band :	GSM1900	Channel :	CH661
Test Mode :	EDGE class 8 Link (8PSK)	Frequency :	1880.0 MHz

Conducted Spurious Emission Plot between 30MHz ~ 1GHz

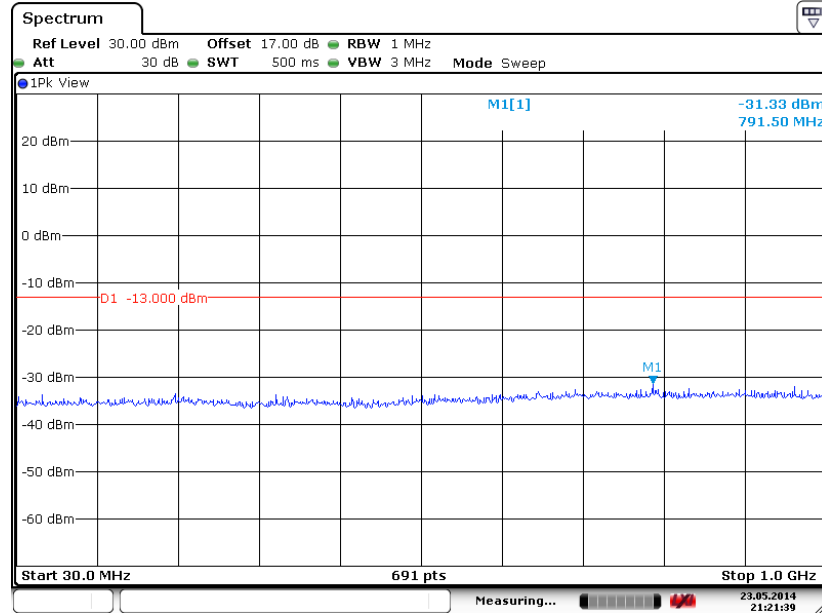

Date: 23.MAY.2014 21:21:40

Conducted Spurious Emission Plot between 1GHz ~ 3GHz

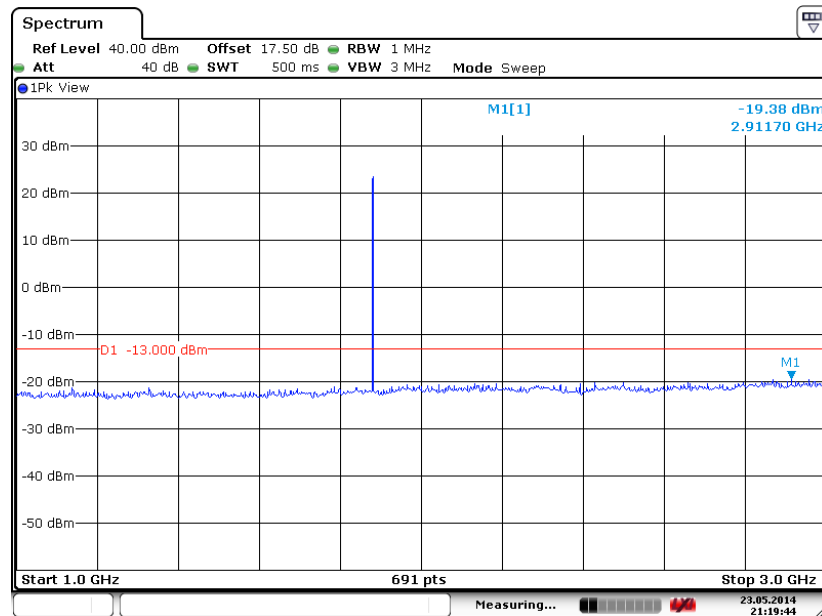

Date: 23.MAY.2014 21:19:44



Conducted Spurious Emission Plot between 3GHz ~ 7GHz

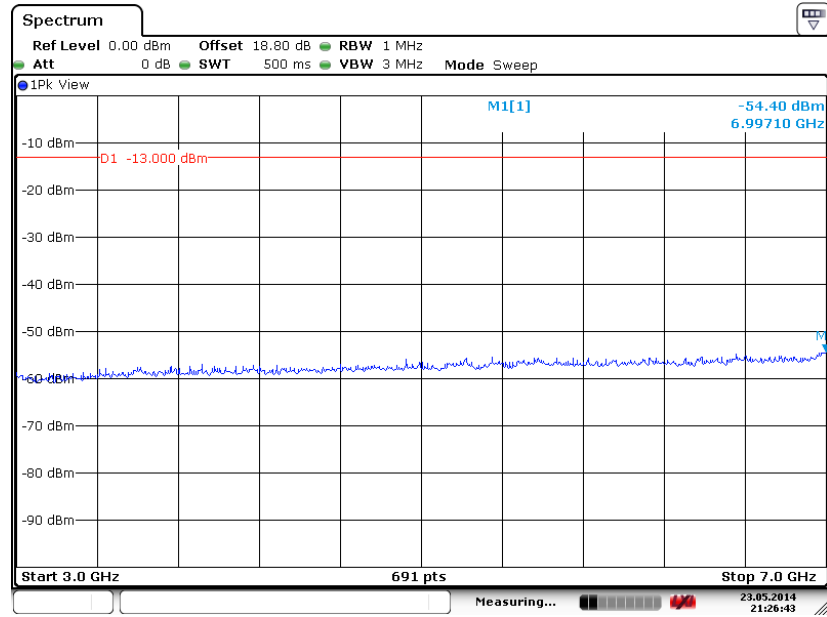

Date: 23.MAY.2014 21:26:44

Conducted Spurious Emission Plot between 7GHz ~ 13.6GHz

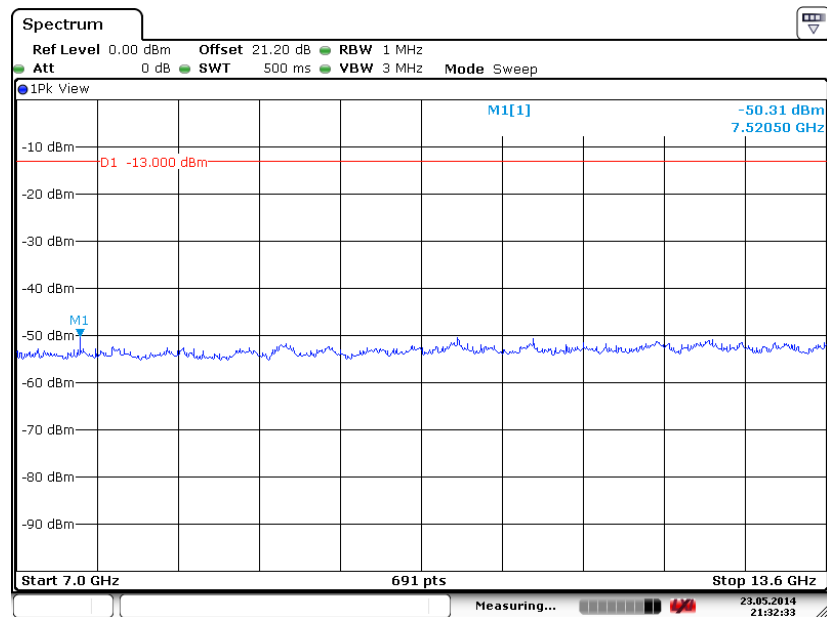

Date: 23.MAY.2014 21:32:33



Conducted Spurious Emission Plot between 13.6GHz ~ 19.1GHz

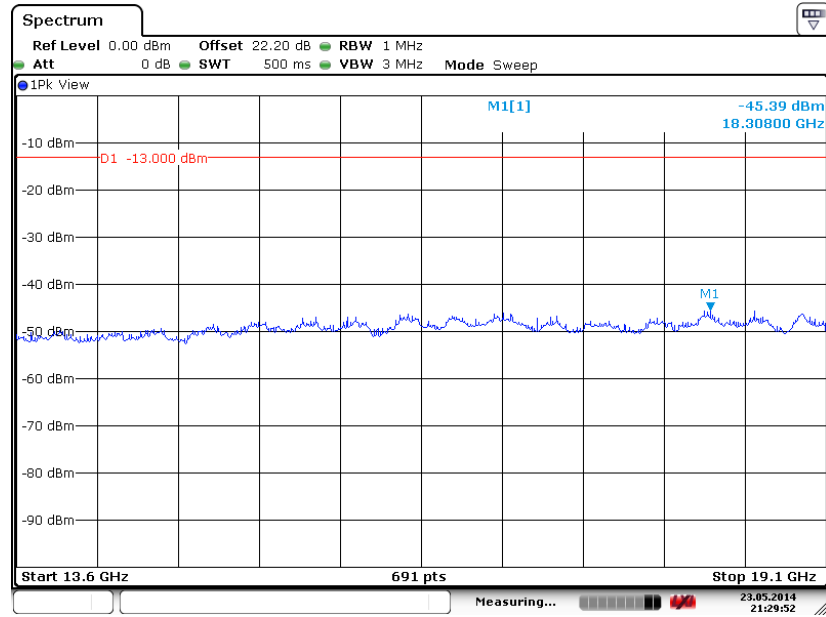

Date: 23.MAY.2014 21:29:53



Band :	WCDMA Band V	Channel :	CH4182
Test Mode :	RMC 12.2Kbps Link (QPSK)	Frequency :	836.4 MHz

Conducted Spurious Emission Plot between 30MHz ~ 1GHz

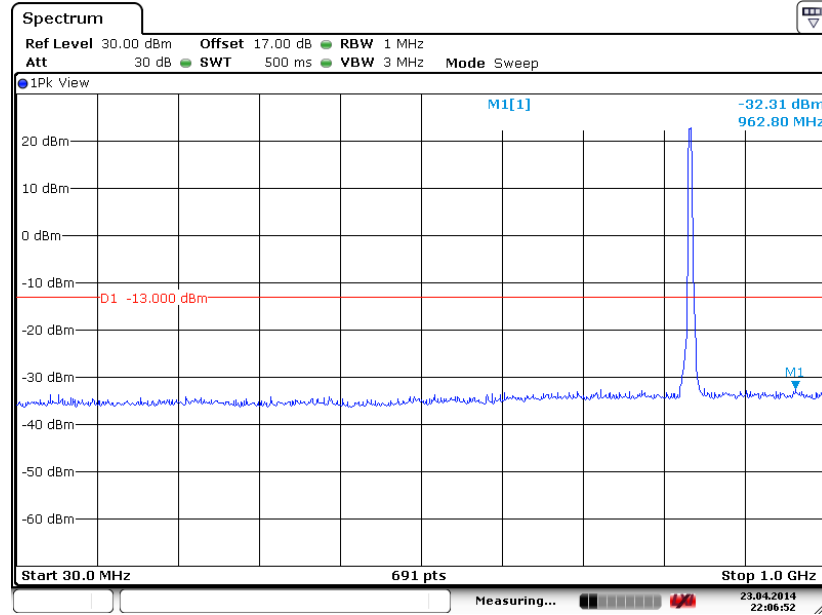

Date: 23.APR.2014 22:06:53

Conducted Spurious Emission Plot between 1GHz ~ 3GHz

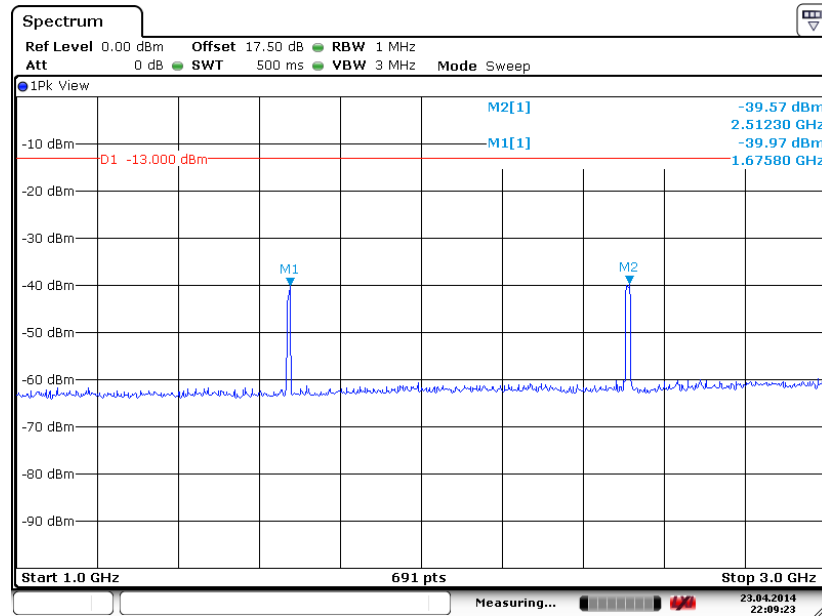

Date: 23.APR.2014 22:09:23



Conducted Spurious Emission Plot between 3GHz ~ 7GHz

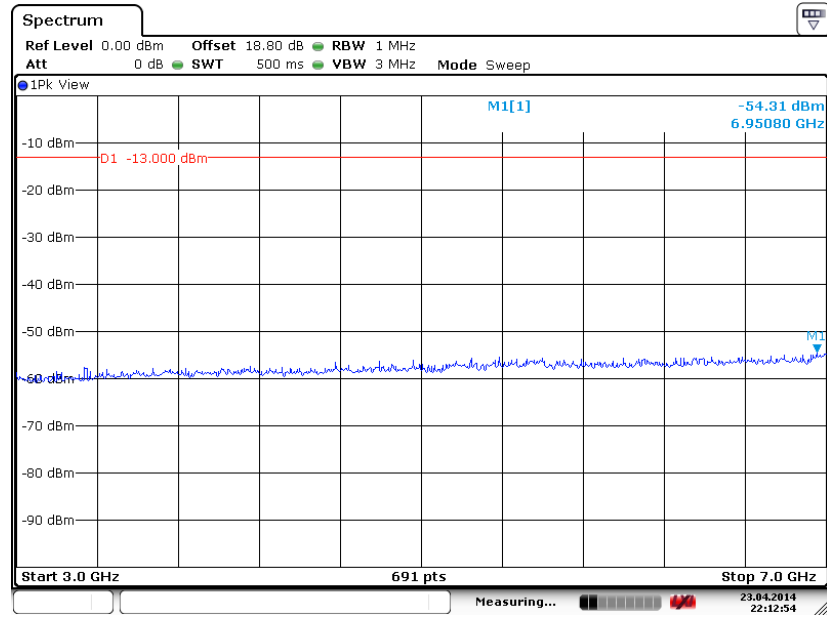

Date: 23.APR.2014 22:12:54

Conducted Spurious Emission Plot between 7GHz ~ 9GHz

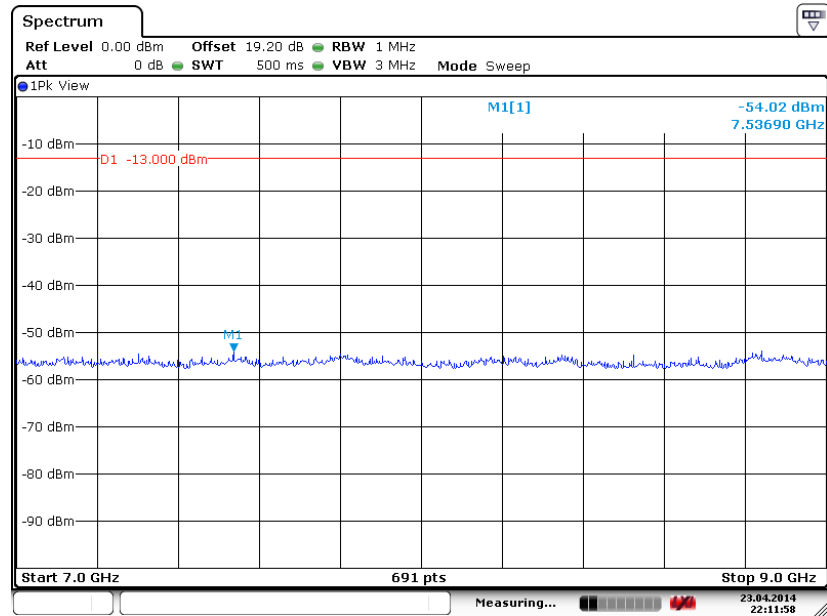

Date: 23.APR.2014 22:11:58



Band :	WCDMA Band II	Channel :	CH9400
Test Mode :	RMC 12.2Kbps Link (QPSK)	Frequency :	1880.0 MHz

Conducted Spurious Emission Plot between 30MHz ~ 1GHz

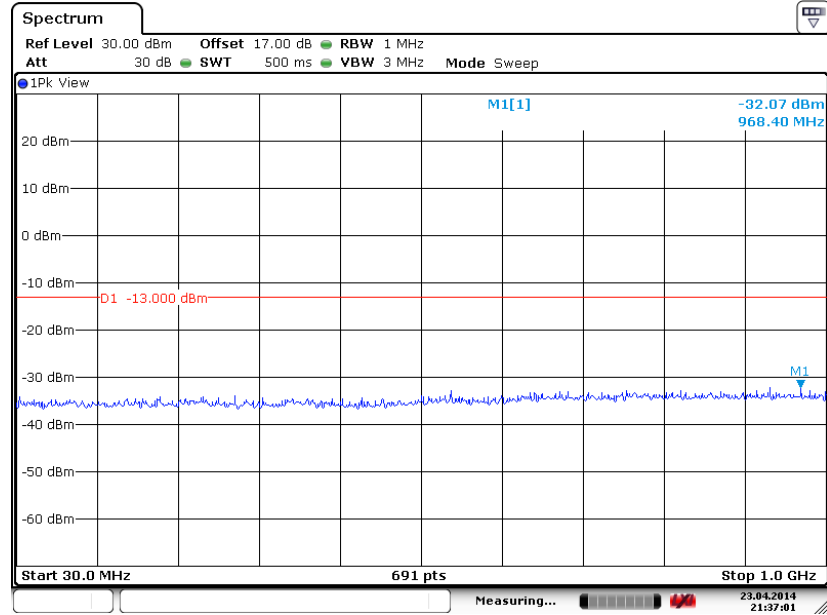

Date: 23.APR.2014 21:37:01

Conducted Spurious Emission Plot between 1GHz ~ 3GHz

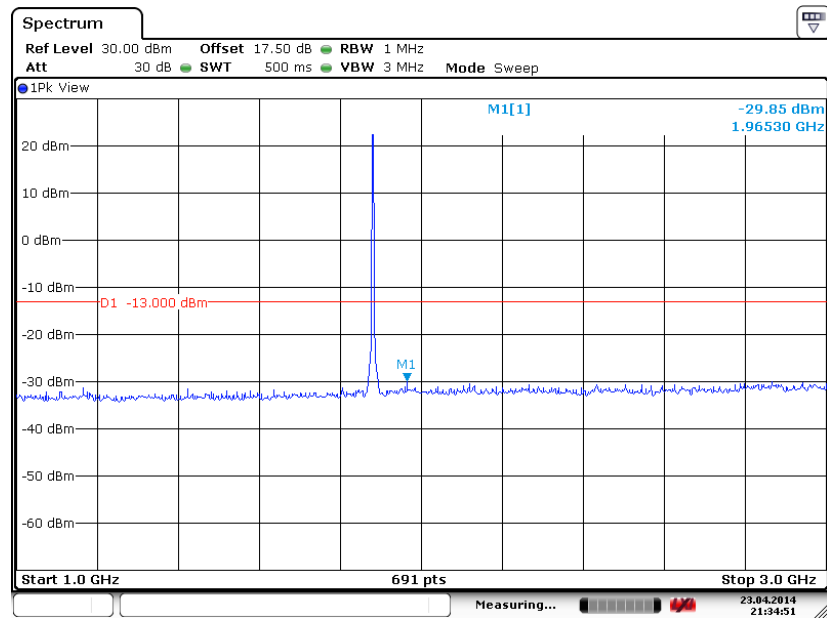

Date: 23.APR.2014 21:34:52



Conducted Spurious Emission Plot between 3GHz ~ 7GHz

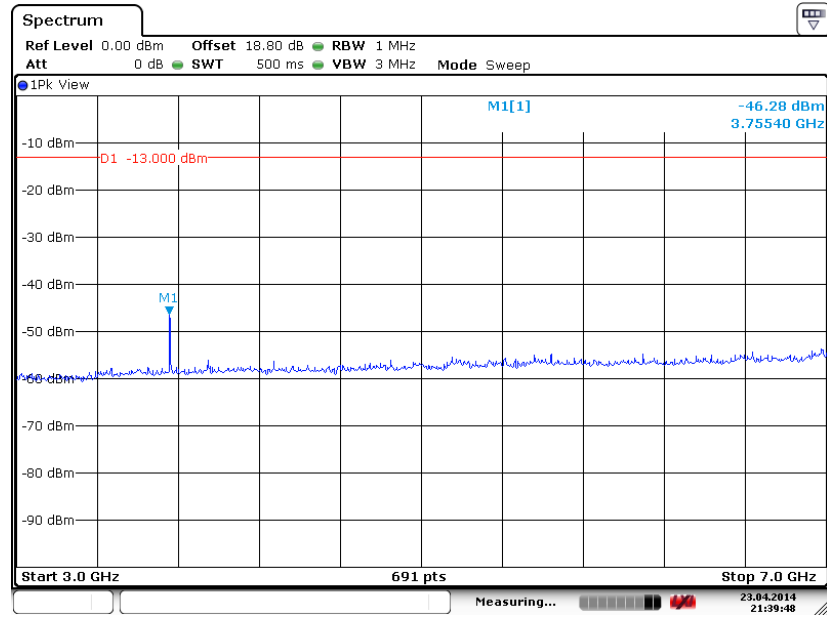

Date: 23.APR.2014 21:39:49

Conducted Spurious Emission Plot between 7GHz ~ 13.6GHz

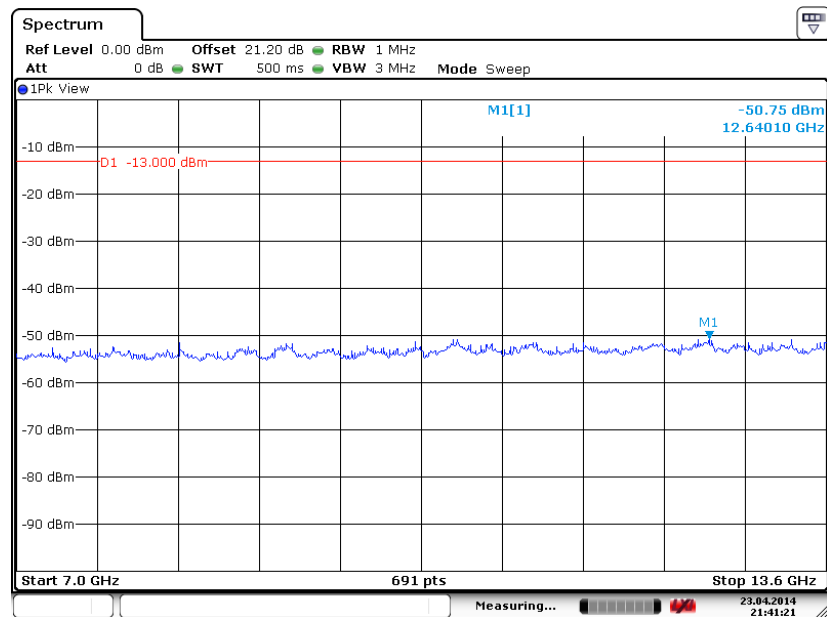

Date: 23.APR.2014 21:41:22



Conducted Spurious Emission Plot between 13.6GHz ~ 19.1GHz

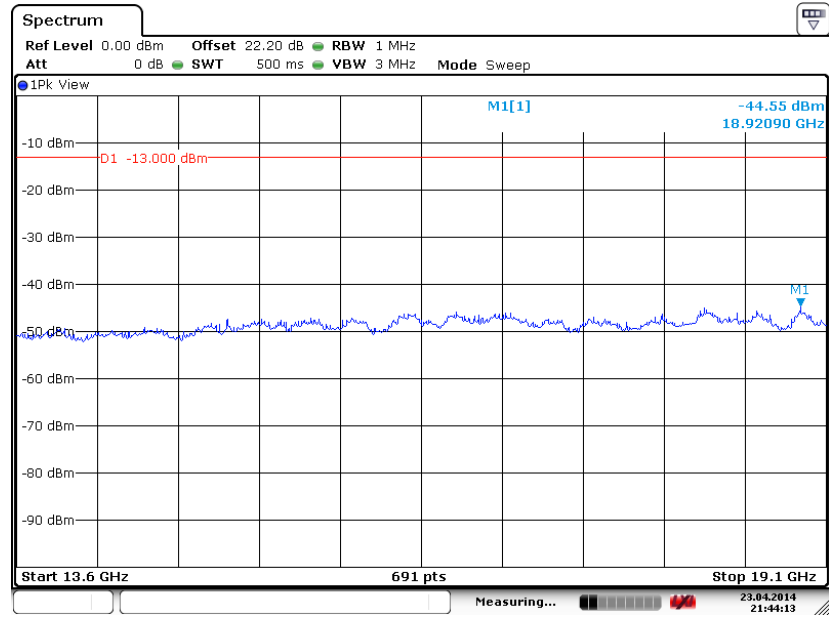

Date: 23.APR.2014 21:44:13



3.7 Field Strength of Spurious Radiation Measurement

3.7.1 Description of Field Strength of Spurious Radiated Measurement

The power of any emission outside of the authorized operating frequency ranges must be attenuated below the transmitter power (P) by a factor of at least $43 + 10 \log (P)$ dB. The spectrum is scanned from 30 MHz up to a frequency including its 10th harmonic.

3.7.2 Measuring Instruments

The measuring equipment is listed in the section 4 of this test report.

3.7.3 Test Procedures

1. The EUT was placed on a rotatable wooden table 0.8 meters above the ground.
2. The EUT was set 3 meters from the receiving antenna, which was mounted on the antenna tower.
3. The table was rotated 360 degrees to determine the position of the highest spurious emission.
4. The height of the receiving antenna is varied between one meter and four meters to search for the maximum spurious emission for both horizontal and vertical polarizations.
5. Make the measurement with the spectrum analyzer's RBW = 1MHz, VBW = 3MHz, taking record of maximum spurious emission.
6. A horn antenna was substituted in place of the EUT and was driven by a signal generator.
7. Tune the output power of signal generator to the same emission level with EUT maximum spurious emission.
8. Taking the record of output power at antenna port.
9. Repeat step 7 to step 8 for another polarization.
10. $EIRP \text{ (dBm)} = S.G. \text{ Power} - Tx \text{ Cable Loss} + Tx \text{ Antenna Gain}$
11. $ERP \text{ (dBm)} = EIRP - 2.15$
12. The RF fundamental frequency should be excluded against the limit line in the operating frequency band.
13. The limit line is derived from $43 + 10\log(P)$ dB below the transmitter power P(Watts)
 $= P(W) - [43 + 10\log(P)] \text{ (dB)}$
 $= [30 + 10\log(P)] \text{ (dBm)} - [43 + 10\log(P)] \text{ (dB)}$
 $= -13\text{dBm}.$

3.7.4 Test Setup

For radiated emissions from 30MHz to 1GHz

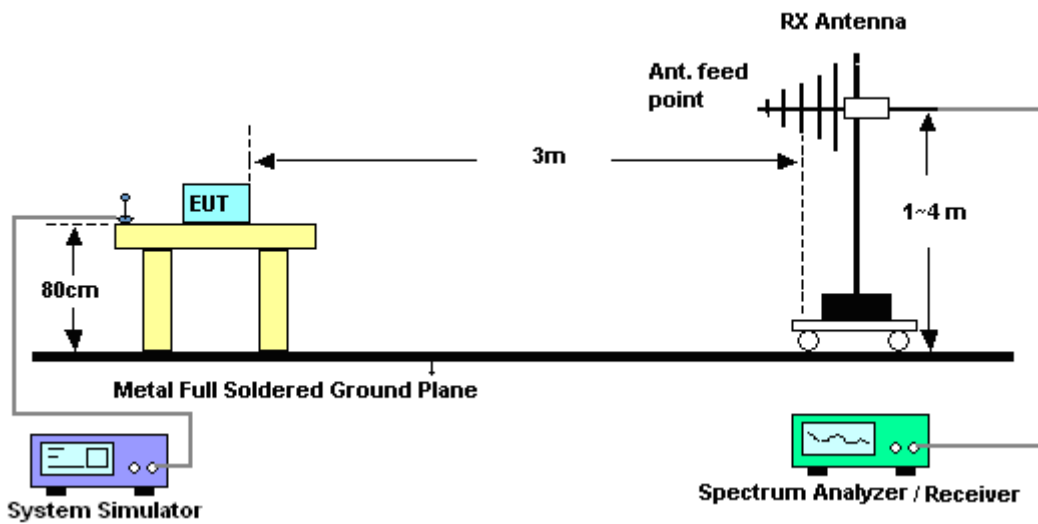

For radiated emissions above 1GHz

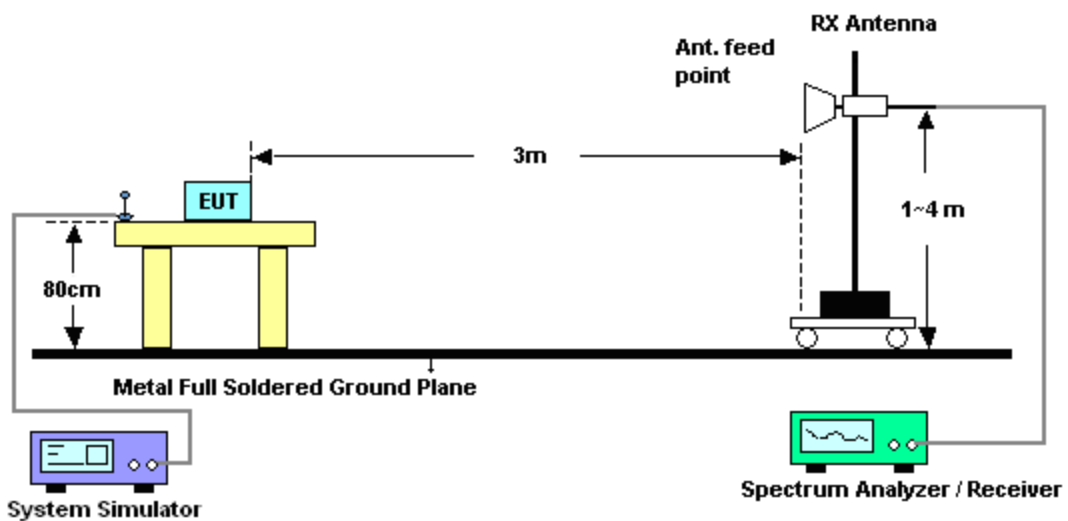



3.7.5 Test Result of Field Strength of Spurious Radiated

Band :	GSM850 for Sample 1	Temperature :	24~25°C
Test Mode :	GSM Link (GMSK)	Relative Humidity :	48~49%
Test Engineer :	Leo Liao	Polarization :	Horizontal
Remark :	Spurious emissions within 30-1000MHz were found more than 20dB below limit line.		

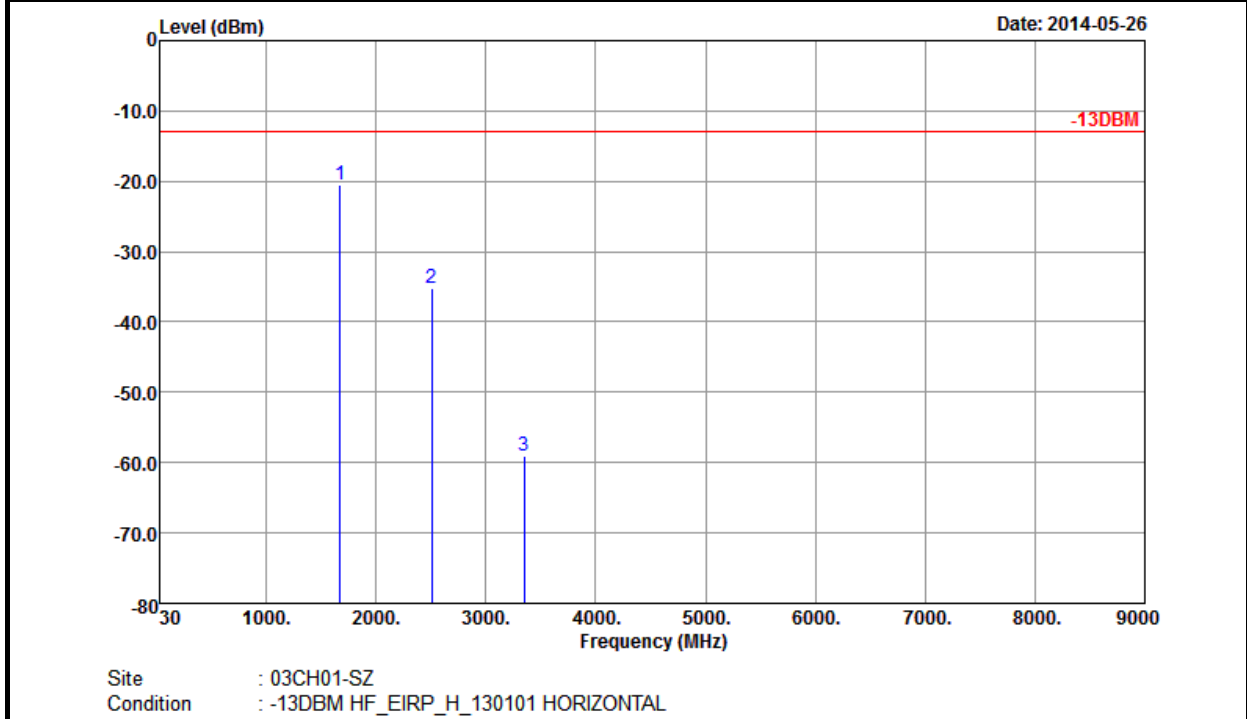

Frequency (MHz)	ERP (dBm)	Limit (dBm)	Over Limit (dB)	SPA Reading (dBm)	S.G. Power (dBm)	TX Cable loss (dB)	TX Antenna Gain (dBi)	Polarization (H/V)	Result
1672	-20.56	-13	-7.56	-37.19	-23.53	0.88	6.00	H	Pass
2510	-35.20	-13	-22.20	-60.13	-37.81	1.08	5.84	H	Pass
3346	-59.16	-13	-46.16	-69.76	-63.53	1.14	7.66	H	Pass



Band :	GSM850 for Sample 1	Temperature :	24~25°C
Test Mode :	GSM Link (GMSK)	Relative Humidity :	48~49%
Test Engineer :	Leo Liao	Polarization :	Vertical
Remark :	Spurious emissions within 30-1000MHz were found more than 20dB below limit line.		

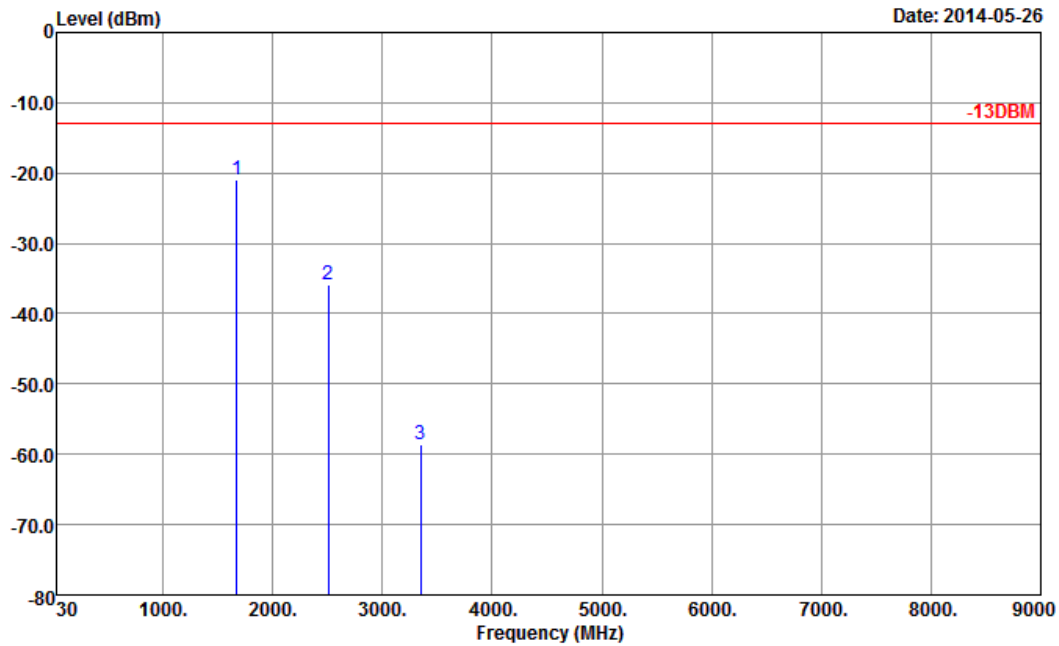

Site : 03CH01-SZ
 Condition : -13DBM HF_EIRP_V_130101 VERTICAL

Frequency (MHz)	ERP (dBm)	Limit (dBm)	Over Limit (dB)	SPA Reading (dBm)	S.G. Power (dBm)	TX Cable loss (dB)	TX Antenna Gain (dBi)	Polarization (H/V)	Result
1672	-20.98	-13	-7.98	-35.22	-23.95	0.88	6.00	V	Pass
2510	-35.96	-13	-22.96	-58.52	-38.57	1.08	5.84	V	Pass
3346	-58.59	-13	-45.59	-70.42	-62.96	1.14	7.66	V	Pass



Band :	GSM850 for Sample 2	Temperature :	24~25°C
Test Mode :	GSM Link (GMSK)	Relative Humidity :	48~49%
Test Engineer :	Leo Liao	Polarization :	Horizontal
Remark :	Spurious emissions within 30-1000MHz were found more than 20dB below limit line.		

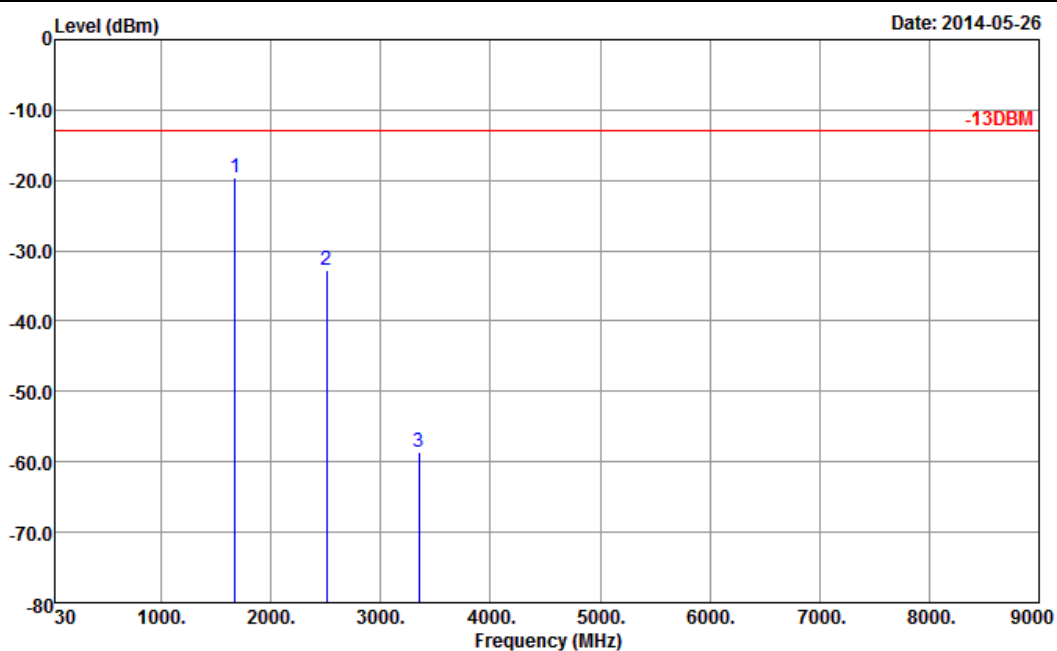

Site : 03CH01-SZ
 Condition : -13DBM HF_EIRP_H_130101 HORIZONTAL

Frequency (MHz)	ERP (dBm)	Limit (dBm)	Over Limit (dB)	SPA Reading (dBm)	S.G. Power (dBm)	TX Cable loss (dB)	TX Antenna Gain (dBi)	Polarization (H/V)	Result
1672	-19.50	-13	-6.50	-36.16	-22.47	0.88	6.00	H	Pass
2510	-32.81	-13	-19.81	-58.00	-35.42	1.08	5.84	H	Pass
3346	-58.51	-13	-45.51	-69.11	-62.88	1.14	7.66	H	Pass



Band :	GSM850 for Sample 2	Temperature :	24~25°C
Test Mode :	GSM Link (GMSK)	Relative Humidity :	48~49%
Test Engineer :	Leo Liao	Polarization :	Vertical
Remark :	Spurious emissions within 30-1000MHz were found more than 20dB below limit line.		

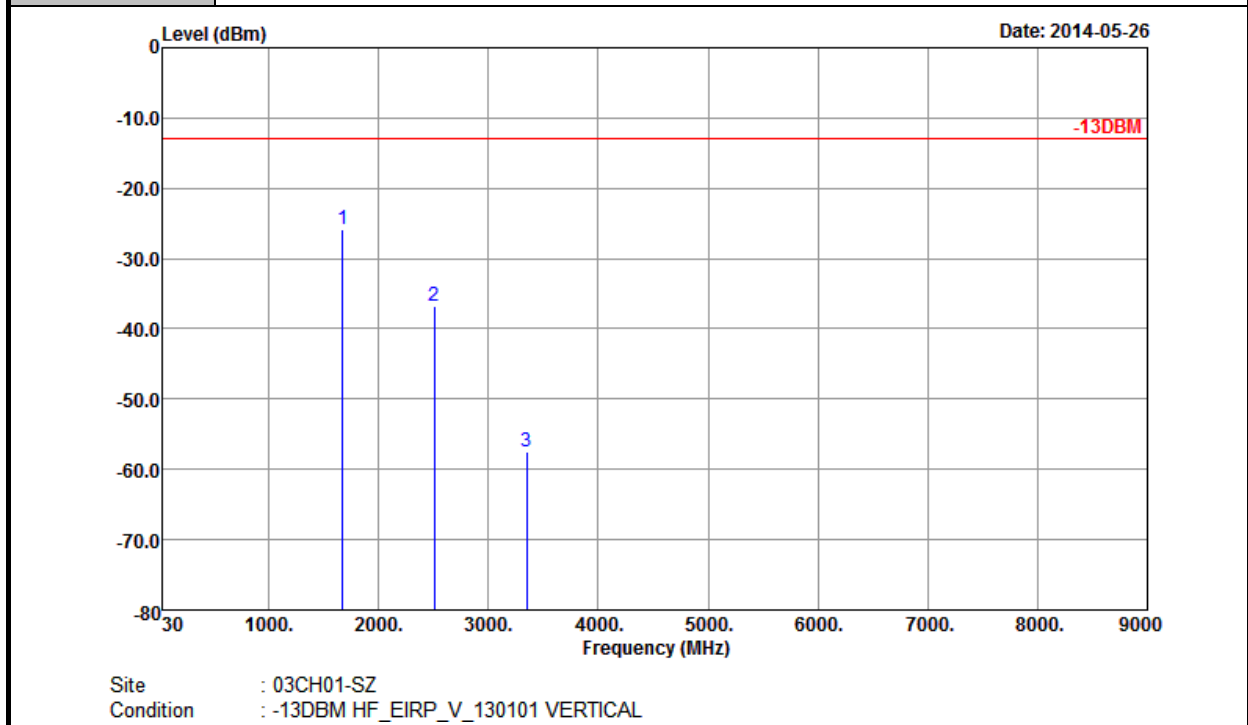

Frequency (MHz)	ERP (dBm)	Limit (dBm)	Over Limit (dB)	SPA Reading (dBm)	S.G. Power (dBm)	TX Cable loss (dB)	TX Antenna Gain (dBi)	Polarization (H/V)	Result
1672	-25.76	-13	-12.76	-40.06	-28.73	0.88	6.00	V	Pass
2510	-36.80	-13	-23.80	-59.31	-39.41	1.08	5.84	V	Pass
3346	-57.59	-13	-44.59	-69.42	-61.96	1.14	7.66	V	Pass



Band :	GSM850 for Sample 1	Temperature :	24~25°C
Test Mode :	EDGE class 8 Link (8PSK)	Relative Humidity :	48~49%
Test Engineer :	Leo Liao	Polarization :	Horizontal
Remark :	Spurious emissions within 30-1000MHz were found more than 20dB below limit line.		

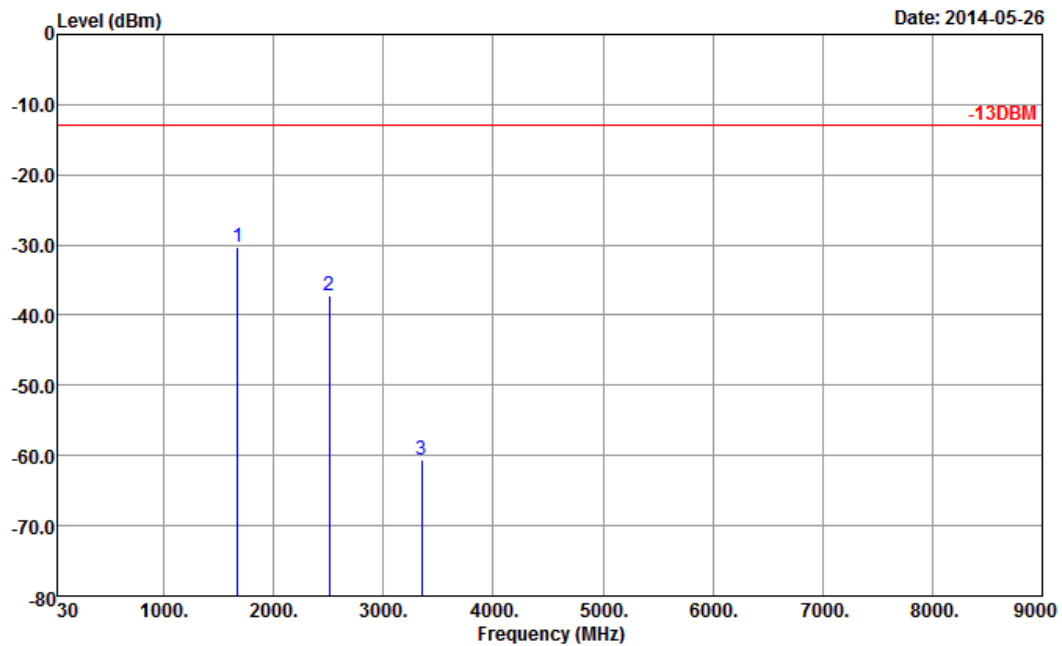

Site : 03CH01-SZ
 Condition : -13DBM HF_EIRP_H_130101 HORIZONTAL

Frequency (MHz)	ERP (dBm)	Limit (dBm)	Over Limit (dB)	SPA Reading (dBm)	S.G. Power (dBm)	TX Cable loss (dB)	TX Antenna Gain (dBi)	Polarization (H/V)	Result
1672	-30.22	-13	-17.22	-46.60	-33.19	0.88	6.00	H	Pass
2510	-37.21	-13	-24.21	-61.94	-39.82	1.08	5.84	H	Pass
3346	-60.70	-13	-47.70	-71.30	-65.07	1.14	7.66	H	Pass



Band :	GSM850 for Sample 1	Temperature :	24~25°C
Test Mode :	EDGE class 8 Link (8PSK)	Relative Humidity :	48~49%
Test Engineer :	Leo Liao	Polarization :	Vertical
Remark :	Spurious emissions within 30-1000MHz were found more than 20dB below limit line.		

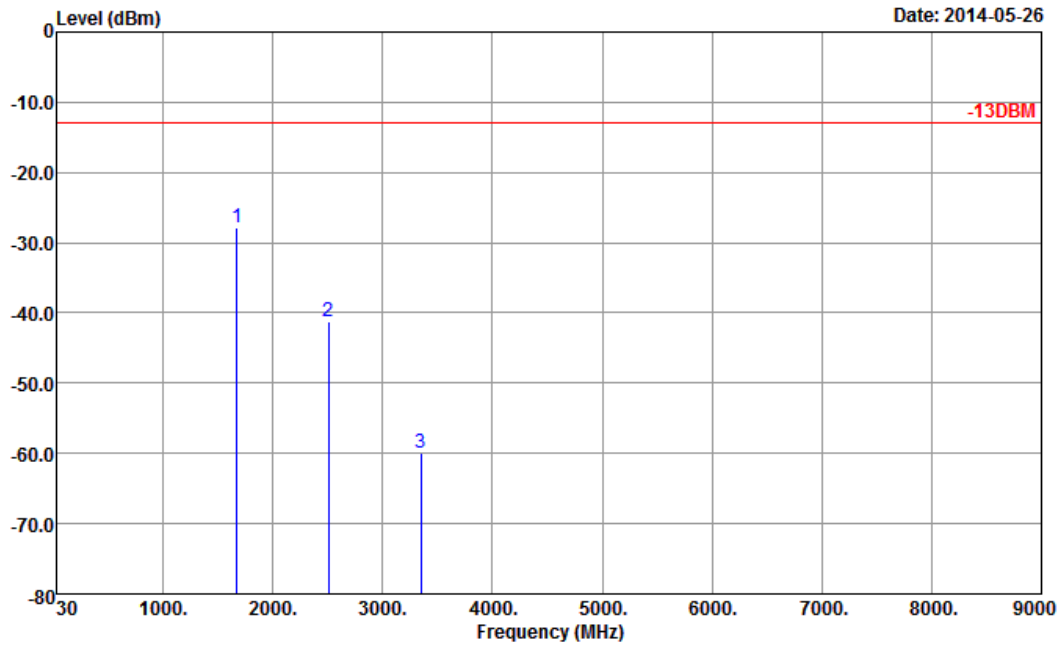

Site : 03CH01-SZ
 Condition : -13DBM HF_EIRP_V_130101 VERTICAL

Frequency (MHz)	ERP (dBm)	Limit (dBm)	Over Limit (dB)	SPA Reading (dBm)	S.G. Power (dBm)	TX Cable loss (dB)	TX Antenna Gain (dBi)	Polarization (H/V)	Result
1672	-27.87	-13	-14.87	-42.02	-30.84	0.88	6.00	V	Pass
2510	-41.25	-13	-28.25	-63.30	-43.86	1.08	5.84	V	Pass
3346	-59.95	-13	-46.95	-71.78	-64.32	1.14	7.66	V	Pass



Band :	GSM1900 for Sample 1	Temperature :	24~25°C
Test Mode :	GSM Link (GMSK)	Relative Humidity :	48~49%
Test Engineer :	Leo Liao	Polarization :	Horizontal
Remark :	Spurious emissions within 30-1000MHz were found more than 20dB below limit line.		

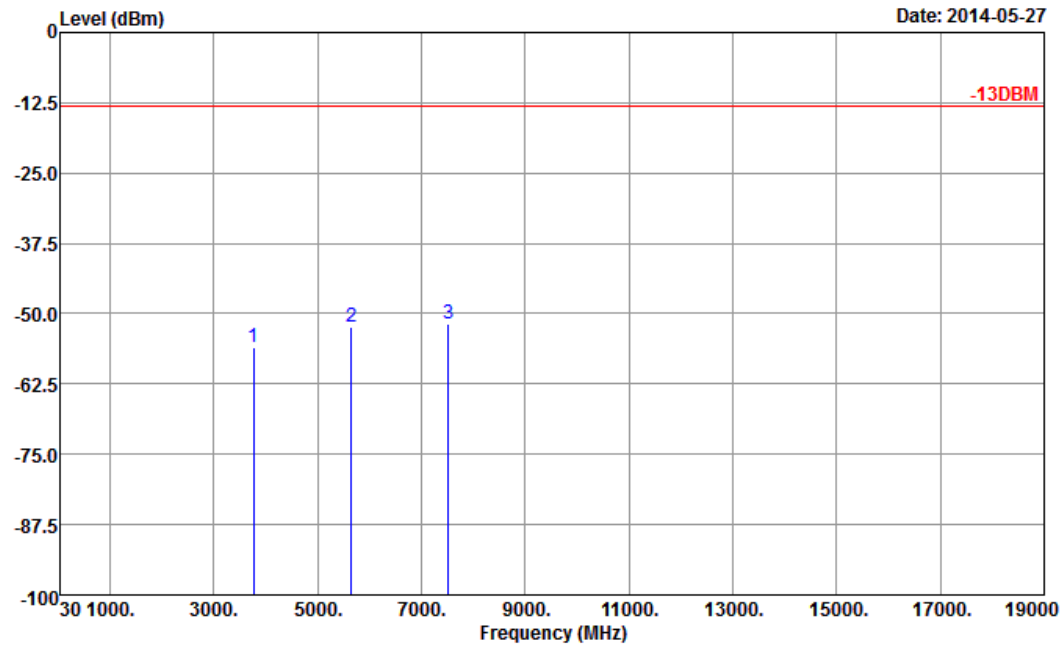

Site : 03CH01-SZ
 Condition : -13DBM LF_EIRP_H_130101 HORIZONTAL

Frequency (MHz)	EIRP (dBm)	Limit (dBm)	Over Limit (dB)	SPA Reading (dBm)	S.G. Power (dBm)	TX Cable loss (dB)	TX Antenna Gain (dBi)	Polarization (H/V)	Result
3760	-55.96	-13	-42.96	-68.11	-62.70	1.28	8.02	H	Pass
5640	-52.49	-13	-39.49	-70.48	-60.91	1.58	10.00	H	Pass
7520	-51.82	-13	-38.82	-73.76	-62.14	1.78	12.10	H	Pass



Band :	GSM1900 for Sample 1	Temperature :	24~25°C
Test Mode :	GSM Link (GMSK)	Relative Humidity :	48~49%
Test Engineer :	Leo Liao	Polarization :	Vertical
Remark :	Spurious emissions within 30-1000MHz were found more than 20dB below limit line.		

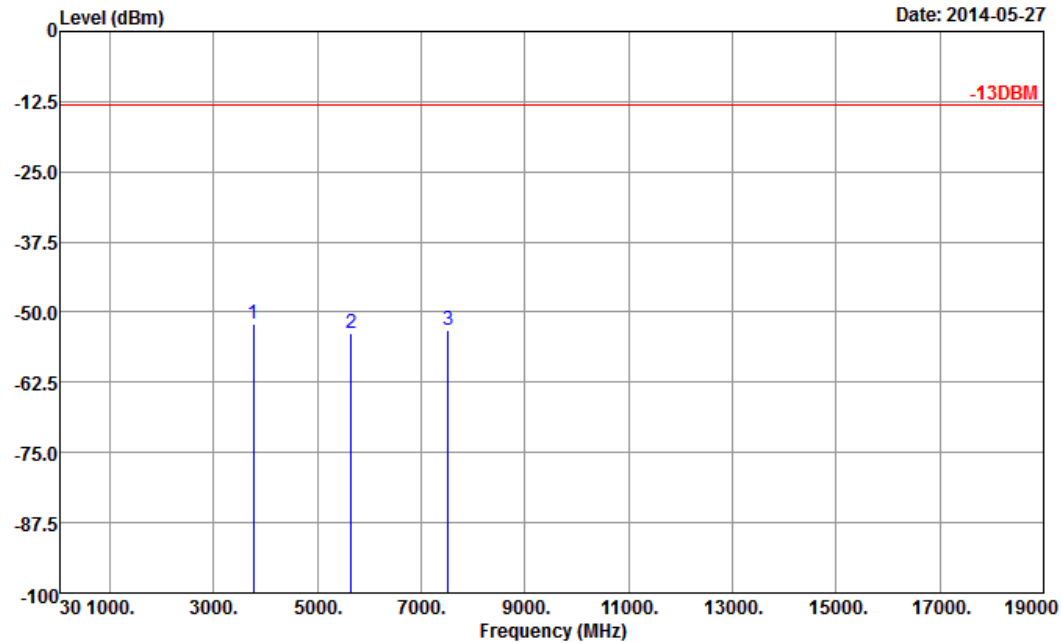

Site : 03CH01-SZ
 Condition : -13DBM LF_EIRP_V_130101 VERTICAL

Frequency (MHz)	EIRP (dBm)	Limit (dBm)	Over Limit (dB)	SPA Reading (dBm)	S.G. Power (dBm)	TX Cable loss (dB)	TX Antenna Gain (dBi)	Polarization (H/V)	Result
3760	-52.05	-13	-39.05	-67.08	-58.79	1.28	8.02	V	Pass
5640	-53.72	-13	-40.72	-70.8	-62.14	1.58	10.00	V	Pass
7520	-53.21	-13	-40.21	-75.46	-63.53	1.78	12.10	V	Pass



Band :	GSM1900 for Sample 2	Temperature :	24~25°C
Test Mode :	GSM Link (GMSK)	Relative Humidity :	48~49%
Test Engineer :	Leo Liao	Polarization :	Horizontal
Remark :	Spurious emissions within 30-1000MHz were found more than 20dB below limit line.		

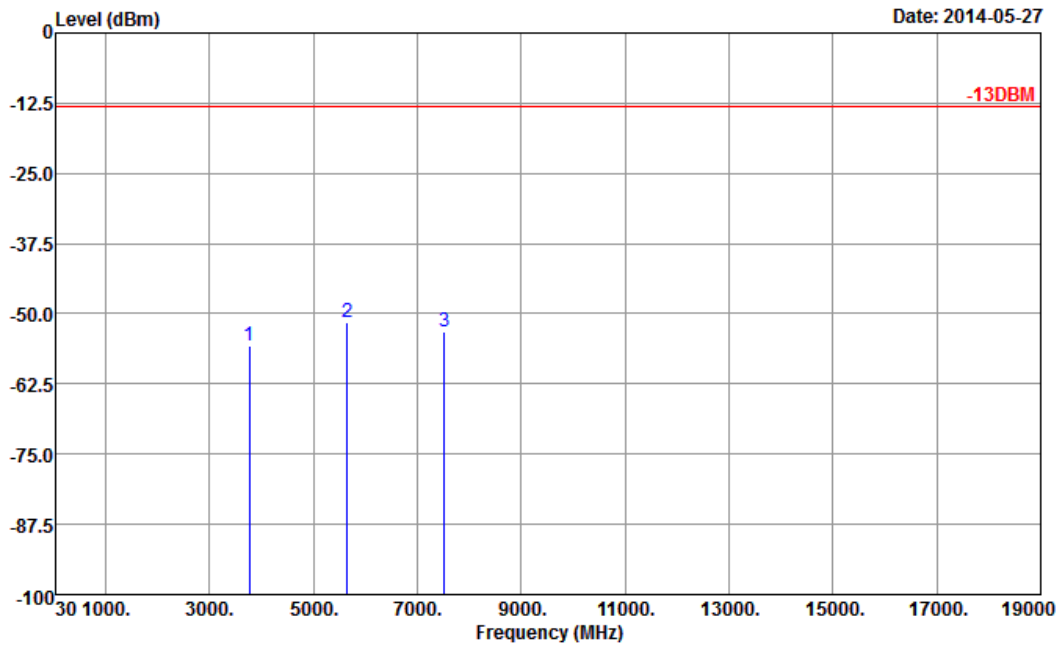

Site : 03CH01-SZ
 Condition : -13DBM LF_EIRP_H_130101 HORIZONTAL

Frequency (MHz)	EIRP (dBm)	Limit (dBm)	Over Limit (dB)	SPA Reading (dBm)	S.G. Power (dBm)	TX Cable loss (dB)	TX Antenna Gain (dBi)	Polarization (H/V)	Result
3760	-55.74	-13	-42.74	-67.89	-62.48	1.28	8.02	H	Pass
5640	-51.62	-13	-38.62	-69.61	-60.04	1.58	10.00	H	Pass
7520	-53.21	-13	-40.21	-75.15	-63.53	1.78	12.10	H	Pass



Band :	GSM1900 for Sample 2	Temperature :	24~25°C
Test Mode :	GSM Link (GMSK)	Relative Humidity :	48~49%
Test Engineer :	Leo Liao	Polarization :	Vertical
Remark :	Spurious emissions within 30-1000MHz were found more than 20dB below limit line.		

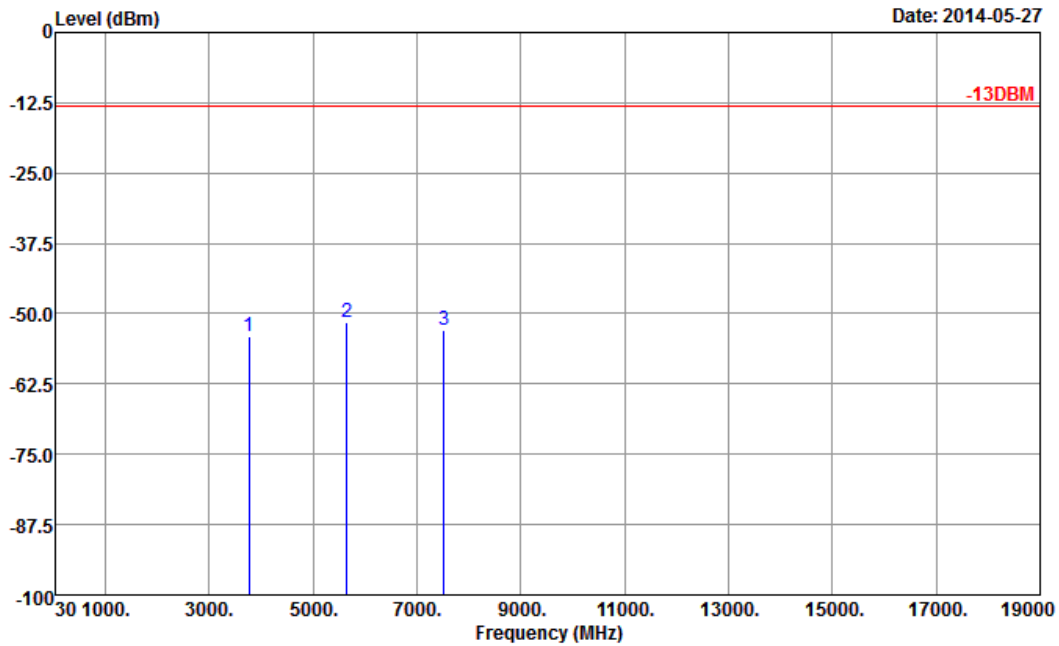

Site : 03CH01-SZ
 Condition : -13DBM LF_EIRP_V_130101 VERTICAL

Frequency (MHz)	EIRP (dBm)	Limit (dBm)	Over Limit (dB)	SPA Reading (dBm)	S.G. Power (dBm)	TX Cable loss (dB)	TX Antenna Gain (dBi)	Polarization (H/V)	Result
3760	-54.13	-13	-41.13	-69.16	-60.87	1.28	8.02	V	Pass
5640	-51.52	-13	-38.52	-68.6	-59.94	1.58	10.00	V	Pass
7520	-52.98	-13	-39.98	-75.23	-63.30	1.78	12.10	V	Pass



Band :	GSM1900 for Sample 1	Temperature :	24~25°C
Test Mode :	EDGE class 8 Link (8PSK)	Relative Humidity :	48~49%
Test Engineer :	Leo Liao	Polarization :	Horizontal
Remark :	Spurious emissions within 30-1000MHz were found more than 20dB below limit line.		

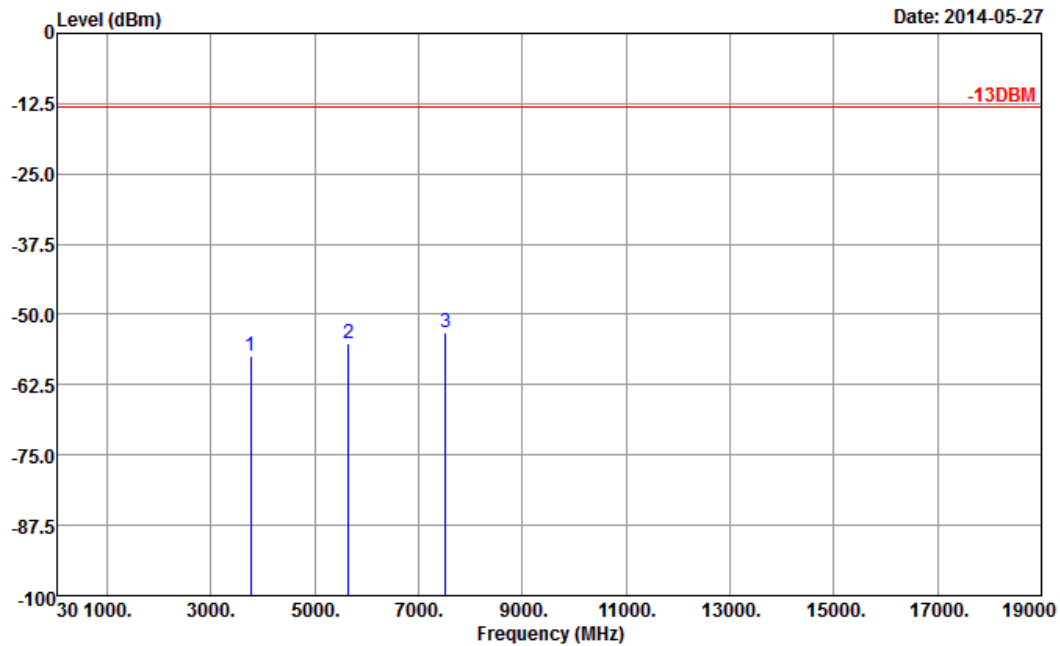

Site : 03CH01-SZ
 Condition : -13DBM LF EIRP H 130101 HORIZONTAL

Frequency (MHz)	EIRP (dBm)	Limit (dBm)	Over Limit (dB)	SPA Reading (dBm)	S.G. Power (dBm)	TX Cable loss (dB)	TX Antenna Gain (dBi)	Polarization (H/V)	Result
3760	-57.37	-13	-44.37	-69.52	-64.11	1.28	8.02	H	Pass
5640	-55.02	-13	-42.02	-73.01	-63.44	1.58	10.00	H	Pass
7520	-53.28	-13	-40.28	-75.22	-63.60	1.78	12.10	H	Pass



Band :	GSM1900 for Sample 1	Temperature :	24~25°C
Test Mode :	EDGE class 8 Link (8PSK)	Relative Humidity :	48~49%
Test Engineer :	Leo Liao	Polarization :	Vertical
Remark :	Spurious emissions within 30-1000MHz were found more than 20dB below limit line.		

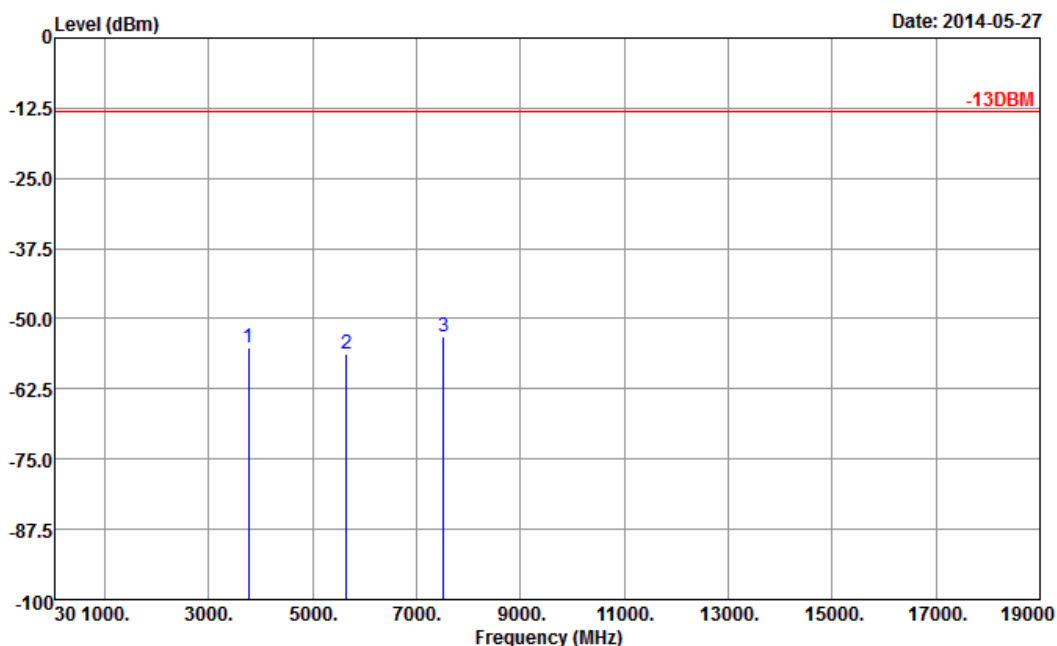

Site : 03CH01-SZ
 Condition : -13DBM LF_EIRP_V_130101 VERTICAL

Frequency (MHz)	EIRP (dBm)	Limit (dBm)	Over Limit (dB)	SPA Reading (dBm)	S.G. Power (dBm)	TX Cable loss (dB)	TX Antenna Gain (dBi)	Polarization (H/V)	Result
3760	-55.06	-13	-42.06	-70.09	-61.80	1.28	8.02	V	Pass
5640	-56.14	-13	-43.14	-73.22	-64.56	1.58	10.00	V	Pass
7520	-53.14	-13	-40.14	-75.39	-63.46	1.78	12.10	V	Pass



Band :	WCDMA Band V for Sample 1	Temperature :	24~25°C
Test Mode :	RMC 12.2Kbps Link (QPSK)	Relative Humidity :	48~49%
Test Engineer :	Leo Liao	Polarization :	Horizontal
Remark :	Spurious emissions within 30-1000MHz were found more than 20dB below limit line.		

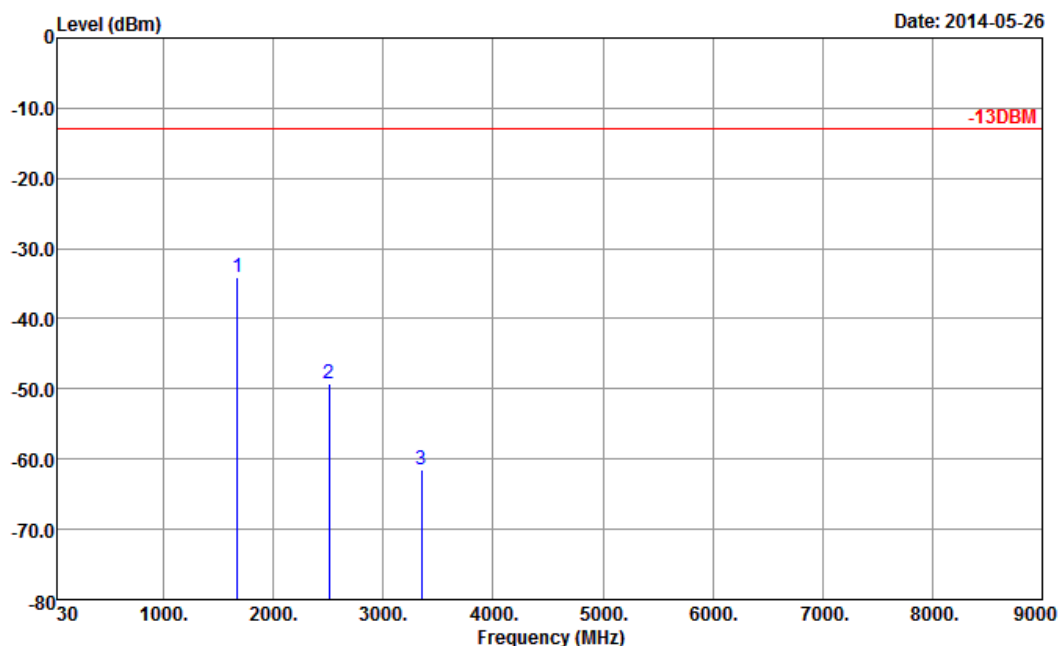

Site : 03CH01-SZ
 Condition : -13DBM HF_EIRP_H_130101 HORIZONTAL

Frequency (MHz)	ERP (dBm)	Limit (dBm)	Over Limit (dB)	SPA Reading (dBm)	S.G. Power (dBm)	TX Cable loss (dB)	TX Antenna Gain (dBi)	Polarization (H/V)	Result
1672	-34.19	-13	-21.19	-51.07	-37.16	0.88	6.00	H	Pass
2510	-49.27	-13	-36.27	-70.73	-51.88	1.08	5.84	H	Pass
3346	-61.41	-13	-48.41	-72.01	-65.78	1.14	7.66	H	Pass



Band :	WCDMA Band V for Sample 1	Temperature :	24~25°C
Test Mode :	RMC 12.2Kbps Link (QPSK)	Relative Humidity :	48~49%
Test Engineer :	Leo Liao	Polarization :	Vertical
Remark :	Spurious emissions within 30-1000MHz were found more than 20dB below limit line.		

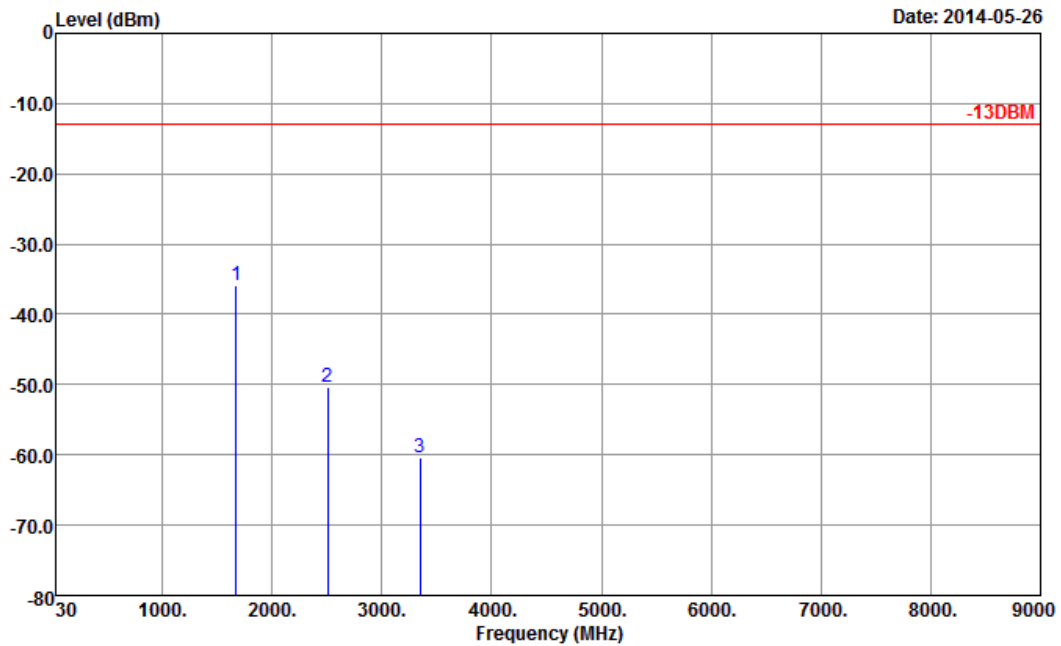

Site : 03CH01-SZ
 Condition : -13DBM HF_EIRP_V_130101 VERTICAL

Frequency (MHz)	ERP (dBm)	Limit (dBm)	Over Limit (dB)	SPA Reading (dBm)	S.G. Power (dBm)	TX Cable loss (dB)	TX Antenna Gain (dBi)	Polarization (H/V)	Result
1672	-35.90	-13	-22.90	-49.93	-38.87	0.88	6.00	V	Pass
2510	-50.27	-13	-37.27	-70.05	-52.88	1.08	5.84	V	Pass
3346	-60.46	-13	-47.46	-72.29	-64.83	1.14	7.66	V	Pass



Band :	WCDMA Band II for Sample 1	Temperature :	24~25°C
Test Mode :	RMC 12.2Kbps Link (QPSK)	Relative Humidity :	48~49%
Test Engineer :	Leo Liao	Polarization :	Horizontal
Remark :	Spurious emissions within 30-1000MHz were found more than 20dB below limit line.		

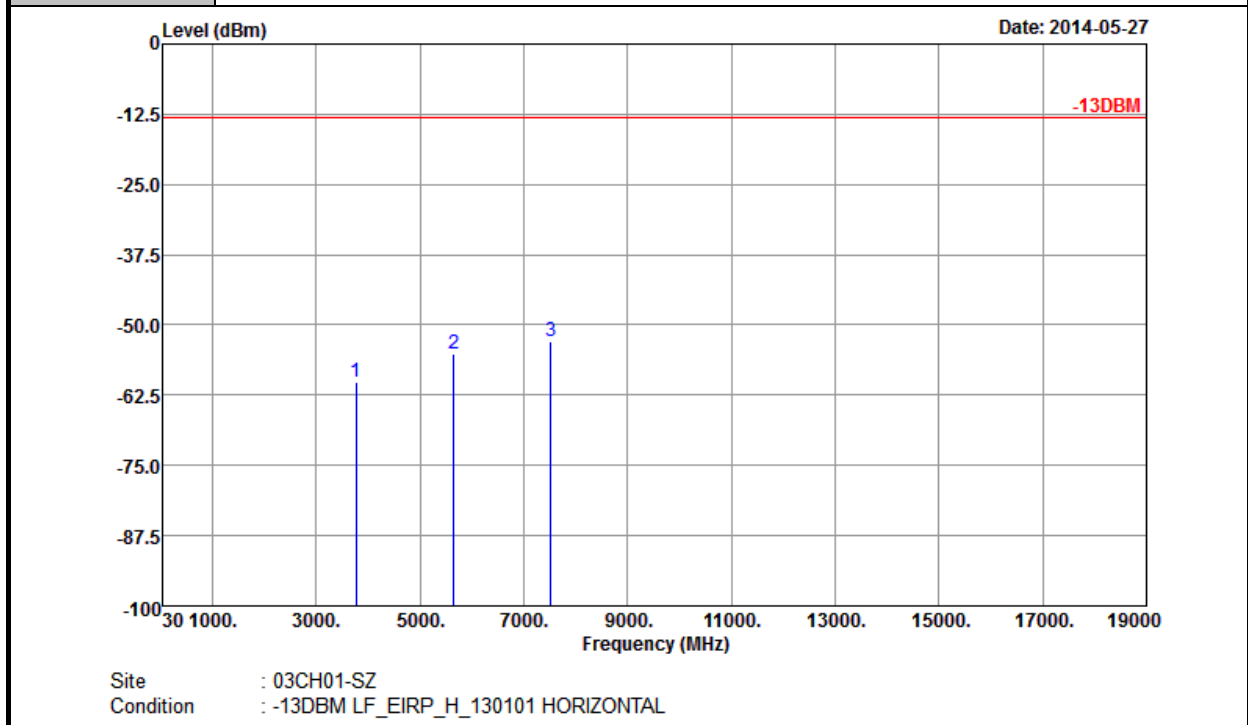

Frequency (MHz)	EIRP (dBm)	Limit (dBm)	Over Limit (dB)	SPA Reading (dBm)	S.G. Power (dBm)	TX Cable loss (dB)	TX Antenna Gain (dBi)	Polarization (H/V)	Result
3760	-60.17	-13	-47.17	-72.32	-66.91	1.28	8.02	H	Pass
5640	-55.19	-13	-42.19	-73.18	-63.61	1.58	10.00	H	Pass
7520	-52.79	-13	-39.79	-74.73	-63.11	1.78	12.10	H	Pass



Band :	WCDMA Band II for Sample 1	Temperature :	24~25°C
Test Mode :	RMC 12.2Kbps Link (QPSK)	Relative Humidity :	48~49%
Test Engineer :	Leo Liao	Polarization :	Vertical
Remark :	Spurious emissions within 30-1000MHz were found more than 20dB below limit line.		

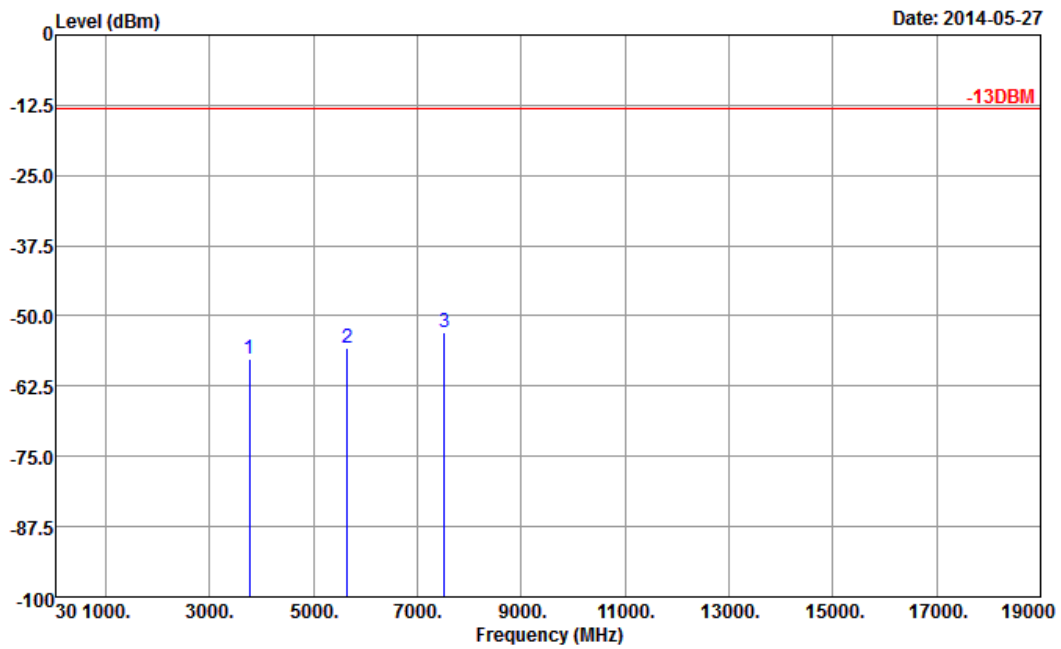

Site : 03CH01-SZ
 Condition : -13DBM LF_EIRP_V_130101 VERTICAL

Frequency (MHz)	EIRP (dBm)	Limit (dBm)	Over Limit (dB)	SPA Reading (dBm)	S.G. Power (dBm)	TX Cable loss (dB)	TX Antenna Gain (dBi)	Polarization (H/V)	Result
3760	-57.69	-13	-44.69	-72.72	-64.43	1.28	8.02	V	Pass
5640	-55.82	-13	-42.82	-72.9	-64.24	1.58	10.00	V	Pass
7520	-52.90	-13	-39.90	-75.15	-63.22	1.78	12.10	V	Pass

3.8 Frequency Stability Measurement

3.8.1 Description of Frequency Stability Measurement

The frequency stability shall be measured by variation of ambient temperature and variation of primary supply voltage to ensure that the fundamental emission stays within the authorized frequency block. The frequency stability of the transmitter shall be maintained within $\pm 0.00025\%$ ($\pm 2.5\text{ppm}$) of the center frequency.

3.8.2 Measuring Instruments

The measuring equipment is listed in the section 4 of this test report.

3.8.3 Test Procedures for Temperature Variation

1. The EUT was set up in the thermal chamber and connected with the system simulator.
2. With power OFF, the temperature was decreased to -30°C and the EUT was stabilized before testing. Power was applied and the maximum change in frequency was recorded within one minute.
3. With power OFF, the temperature was raised in 10°C steps up to 50°C . The EUT was stabilized at each step for at least half an hour. Power was applied and the maximum frequency change was recorded within one minute.

3.8.4 Test Procedures for Voltage Variation

1. The EUT was placed in a temperature chamber at $25\pm 5^{\circ}\text{C}$ and connected with the system simulator.
2. The power supply voltage to the EUT was varied from BEP to 115% of the nominal value measured at the input to the EUT.
3. The variation in frequency was measured for the worst case.

3.8.5 Test Setup

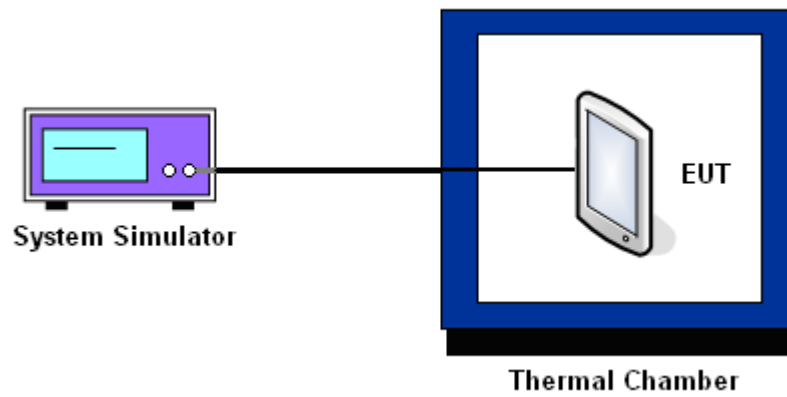

3.8.6 Test Result of Temperature Variation

Band :	GSM 850	Channel :	189
Limit (ppm) :	2.5	Frequency :	836.4 MHz

Temperature (°C)	GSM		EDGE class 8		Result
	Freq. Dev. (Hz)	Deviation (ppm)	Freq. Dev. (Hz)	Deviation (ppm)	
-30	9	+0.011	22	+0.026	PASS
-20	11	+0.013	24	+0.028	
-10	10	+0.012	21	+0.025	
0	8	+0.009	23	+0.027	
10	9	+0.011	25	+0.029	
20	10	+0.012	26	+0.031	
30	7	+0.008	27	+0.032	
40	8	+0.009	26	+0.031	
50	9	+0.011	27	+0.032	

Band :	GSM 1900	Channel :	661
Limit (ppm) :	2.5	Frequency :	1880.0 MHz

Temperature (°C)	GSM		EDGE class 8		Result
	Freq. Dev. (Hz)	Deviation (ppm)	Freq. Dev. (Hz)	Deviation (ppm)	
-30	43	+0.023	48	+0.025	PASS
-20	40	+0.021	49	+0.026	
-10	37	+0.019	42	+0.022	
0	35	+0.018	43	+0.023	
10	38	+0.020	40	+0.021	
20	42	+0.022	46	+0.024	
30	39	+0.021	45	+0.024	
40	42	+0.022	47	+0.025	
50	44	+0.023	48	+0.025	



Band :	WCDMA Band V	Channel :	4182
Limit (ppm) :	2.5	Frequency :	836.4 MHz

Temperature (°C)	RMC 12.2Kbps		Result
	Freq. Dev. (Hz)	Deviation (ppm)	
-30	-4	-0.005	PASS
-20	-6	-0.007	
-10	-5	-0.006	
0	-5	-0.006	
10	-4	-0.005	
20	-6	-0.007	
30	-4	-0.005	
40	-5	-0.006	
50	-6	-0.007	

Band :	WCDMA Band II	Channel :	9400
Limit (ppm) :	2.5	Frequency :	1880.0 MHz

Temperature (°C)	RMC 12.2Kbps		Result
	Freq. Dev. (Hz)	Deviation (ppm)	
-30	-10	-0.005	PASS
-20	-8	-0.004	
-10	-7	-0.004	
0	-8	-0.004	
10	-9	-0.005	
20	-9	-0.005	
30	-8	-0.004	
40	-7	-0.004	
50	-9	-0.005	



3.8.7 Test Result of Voltage Variation

Band & Channel	Mode	Voltage (Volt)	Freq. Dev. (Hz)	Deviation (ppm)	Limit (ppm)	Result
GSM 850 CH189	GSM	3.7	9	+0.011	2.5	PASS
		BEP	8	+0.009		
		4.2	10	+0.012		
	EDGE class 8	3.7	23	+0.027		
		BEP	25	+0.029		
		4.2	26	+0.031		
GSM 1900 CH661	GSM	3.7	42	+0.022		
		BEP	39	+0.021		
		4.2	44	+0.023		
	EDGE class 8	3.7	46	+0.024		
		BEP	45	+0.024		
		4.2	48	+0.025		
WCDMA Band V CH4182	RMC 12.2Kbps	3.7	-6	-0.007		
		BEP	-4	-0.005		
		4.2	-5	-0.006		
WCDMA Band II CH9400	RMC 12.2Kbps	3.7	-9	-0.005		
		BEP	-8	-0.004		
		4.2	-9	-0.005		

Note:

1. Normal Voltage = 3.7V.
2. Battery End Point (BEP) = 3.6 V.



4 List of Measuring Equipment

Instrument	Manufacturer	Model No.	Serial No.	Characteristics	Calibration Date	Test Date	Due Date	Remark
Spectrum Analyzer	R&S	FSV40	101078	10Hz~40GHz	Jun. 17, 2013	Apr. 22, 2014~ May 26, 2014	Jun. 16, 2014	Conducted (TH01-SZ)
Thermal Chamber	Hongzhan	LP-150U	HD20120425	-40°C~150°C	Feb. 21, 2014	Apr. 22, 2014~ May 26, 2014	Feb. 20, 2015	Conducted (TH01-SZ)
ESCIO TEST Receiver	R&S	ESCI	100724	9kHz~3GHz	Feb. 21, 2014	May 26, 2014~ May 27, 2014	Feb. 20, 2015	Radiation (03CH01-SZ)
Signal Analyzer	R&S	FSV40	101078	10Hz~40GHz	Jun. 17, 2013	May 26, 2014~ May 27, 2014	Jun. 16, 2014	Radiation (03CH01-SZ)
Bilog Antenna	TESEQ	CBL 6112D	23188	30MHz~2GHz	Oct. 26, 2013	May 26, 2014~ May 27, 2014	Oct. 25, 2014	Radiation (03CH01-SZ)
Double Ridge Horn Antenna	ETS Lindgren	3117	00119436	1GHz~18GHz	Oct. 26, 2013	May 26, 2014~ May 27, 2014	Oct. 25, 2014	Radiation (03CH01-SZ)
Double Ridged Horn Antenna	COM-POWER	AH-840	101073	18GHz~40GHz	Jan. 27, 2014	May 26, 2014~ May 27, 2014	Jan. 26, 2015	Radiation (03CH01-SZ)
Amplifier	ADVANTEST	BB525C	E9007003	9kHz~3000MHz	Feb. 21, 2014	May 26, 2014~ May 27, 2014	Feb. 20, 2015	Radiation (03CH01-SZ)
Amplifier	Agilent	83017A	MY39501302	3Hz~26.5GHz	Mar. 03, 2014	May 26, 2014~ May 27, 2014	Mar. 02, 2015	Radiation (03CH01-SZ)
AC Source(AVR)	Chroma	61601	61601000198 5	100Vac~250Vac	Mar. 25, 2014	May 26, 2014~ May 27, 2014	Mar. 24, 2015	Radiation (03CH01-SZ)
Turn Table	EM Electronics	EM 1000	N/A	0~360 degree	NCR	May 26, 2014~ May 27, 2014	NCR	Radiation (03CH01-SZ)
Antenna Mast	EM Electronics	EM 1000	N/A	1 m~4 m	NCR	May 26, 2014~ May 27, 2014	NCR	Radiation (03CH01-SZ)
Spectrum Analyzer	R&S	FSP 7	100818	9kHz~7GHz	Sep. 03, 2013	May 22, 2014	Sep. 02, 2014	ERP/EIRP (OTA01-SZ)
Quad-Ridged Horn	ETS-Lindgren	3164-08	00102954	700MHz~1000MHz	N/A	May 22, 2014	N/A	ERP/EIRP (OTA01-SZ)
Multi-Devices Controller	ETS-Lindgren	2090-OPT1	00108147	N/A	N/A	May 22, 2014	N/A	ERP/EIRP (OTA01-SZ)
Switch Control Mainframe	Agilent	3499A	MY42005451	N/A	N/A	May 22, 2014	N/A	ERP/EIRP (OTA01-SZ)



5 Uncertainty of Evaluation

Uncertainty of Radiated Emission Measurement (30 MHz ~ 1000 MHz)

Measuring Uncertainty for a Level of Confidence of 95% ($U = 2Uc(y)$)	3.90
---	------