

FCC RF Test Report

APPLICANT : Lenovo (Shanghai) Electronics Technology Co., Ltd.
EQUIPMENT : Tablet PC
BRAND NAME : Vodafone
MODEL NAME : Smart Tab III⁷
MARKETING NAME : Vodafone Smart Tab III7
FCC ID : O57A3000VDF3G
STANDARD : FCC Part 15 Subpart C §15.247
CLASSIFICATION : (DSS) Spread Spectrum Transmitter

The product was received on Feb. 27, 2013 and completely tested on Mar. 17, 2013. We, SPORTON INTERNATIONAL (KUNSHAN) INC., would like to declare that the tested sample has been evaluated in accordance with the procedures and shown the compliance with the applicable technical standards.

The test results in this report apply exclusively to the tested model / sample. Without written approval of SPORTON INTERNATIONAL (KUNSHAN) INC., the test report shall not be reproduced except in full.



Reviewed by: Joseph Lin / Supervisor



Approved by: Jones Tsai / Manager



SPORTON INTERNATIONAL (KUNSHAN) INC.
No. 3-2, PingXiang Road, Kunshan, Jiangsu Province, P.R.C.



TABLE OF CONTENTS

REVISION HISTORY..... 3

SUMMARY OF TEST RESULT 4

1 GENERAL DESCRIPTION..... 5

 1.1 Applicant 5

 1.2 Manufacturer..... 5

 1.3 Feature of Equipment Under Test 5

 1.4 Product Specification of Equipment Under Test..... 5

 1.5 Modification of EUT 6

 1.6 Testing Site..... 6

 1.7 Applied Standards 6

2 TEST CONFIGURATION OF EQUIPMENT UNDER TEST..... 7

 2.1 Descriptions of Test Mode 7

 2.2 Test Mode..... 8

 2.3 Connection Diagram of Test System..... 9

 2.4 Support Unit used in test configuration and system 10

 2.5 Description of RF Function Operation Test Setup..... 10

 2.6 Measurement Results Explanation Example..... 11

3 TEST RESULT 12

 3.1 Number of Channel Measurement 12

 3.2 Hopping Channel Separation Measurement 14

 3.3 Dwell Time Measurement..... 21

 3.4 20dB Bandwidth Measurement 23

 3.5 Peak Output Power Measurement 30

 3.6 Conducted Band Edges Measurement 33

 3.7 Conducted Spurious Emission Measurement 40

 3.8 Radiated Band Edges and Spurious Emission Measurement 44

 3.9 AC Conducted Emission Measurement..... 56

 3.10 Antenna Requirements..... 60

4 LIST OF MEASURING EQUIPMENT..... 61

5 UNCERTAINTY OF EVALUATION..... 62

APPENDIX A. PHOTOGRAPHS OF EUT

APPENDIX B. SETUP PHOTOGRAPHS



REVISION HISTORY

REPORT NO.	VERSION	DESCRIPTION	ISSUED DATE
FR350204A	Rev. 01	Initial issue of report	Jul. 11, 2013



SUMMARY OF TEST RESULT

Report Section	FCC Rule	Description	Limit	Result	Remark
3.1	15.247(a)(1)	Number of Channels	≥ 15Chs	Pass	-
3.2	15.247(a)(1)	Hopping Channel Separation	≥ 2/3 of 20dB BW	Pass	-
3.3	15.247(a)(1)	Dwell Time of Each Channel	≤ 0.4sec in 31.6sec period	Pass	-
3.4	15.247(a)(1)	20dB Bandwidth	NA	Pass	-
3.5	15.247(b)(1)	Peak Output Power	≤ 1 w for 1Mbps ≤ 125 Mw for 2, 3Mbps	Pass	-
3.6	15.247(d)	Conducted Band Edges	≤ 20dBc	Pass	-
3.7	15.247(d)	Conducted Spurious Emission	≤ 20dBc	Pass	-
3.8	15.247(d)	Radiated Band Edges and Radiated Spurious Emission	15.209(a) & 15.247(d)	Pass	Under limit 3.17 dB at 43.770 MHz
3.9	15.207	AC Conducted Emission	15.207(a)	Pass	Under limit 11.32 dB at 1.070 MHz
3.10	15.203 & 15.247(b)	Antenna Requirement	N/A	Pass	-

1 General Description

1.1 Applicant

Lenovo (Shanghai) Electronics Technology Co., Ltd.

No. 68 Building, 199 Fenju Road, Wai Gao Qiao FTZ, Shanghai, China

1.2 Manufacturer

Lenovo PC HK Limited

23/F, Lincoln House, Taikoo Place 979 King's Road, Quarry Bay, Hong Kong

1.3 Feature of Equipment Under Test

Product Feature	
Equipment	Tablet PC
Brand Name	Vodafone
Model Name	Smart Tab III ⁷
Marketing Name	Vodafone Smart Tab III7
FCC ID	O57A3000VDF3G
EUT supports Radios application	GPRS/EGPRS/WCDMA/HSPA/HSPA+/DC-HSDPA/WLAN 11bgn/Bluetooth/Bluetooth 4.0 - LE
HW Version	H402
SW Version	A3000-S3
EUT Stage	Identical Prototype

Remark: The above EUT's information was declared by manufacturer. Please refer to the specifications or user's manual for more detailed description.

1.4 Product Specification of Equipment Under Test

Product Specification subjective to this standard	
Tx/Rx Frequency Range	2402 MHz ~ 2480 MHz
Number of Channels	79
Carrier Frequency of Each Channel	2402+n*1 MHz; n=0~78
Maximum Output Power to Antenna	Bluetooth BR (1Mbps) : 6.57 dBm (0.0045 W) Bluetooth EDR (2Mbps) : 6.29 dBm (0.0043 W) Bluetooth EDR (3Mbps) : 6.62 dBm (0.0046 W)
Antenna Type	Fixed Internal Antenna with gain 3.10 dBi
Type of Modulation	Bluetooth BR (1Mbps) : GFSK Bluetooth EDR (2Mbps) : $\pi/4$ -DQPSK Bluetooth EDR (3Mbps) : 8-DPSK

1.5 Modification of EUT

No modifications are made to the EUT during all test items.

1.6 Testing Site

Test Site	SPORTON INTERNATIONAL INC.	
Test Site Location	No. 52, Hwa Ya 1 st Rd., Hwa Ya Technology Park, Kwei-Shan Hsiang, Tao Yuan Hsien, Taiwan, R.O.C. TEL: +886-3-3273456 / FAX: +886-3-3284978	
Test Site No.	Sporton Site No.	FCC/IC Registration No.
	03CH06-HY	722060/4086B-1

Test Site	SPORTON INTERNATIONAL (KUNSHAN) INC.	
Test Site Location	No. 3-2, PingXiang Road, Kunshan, Jiangsu Province, P.R.C. TEL: +86-0512-5790-0158 FAX: +86-0512-5790-0958	
Test Site No.	Sporton Site No.	FCC/IC Registration No.
	TH01-KS	CO01-KS
		149928/4086E-1

The test site complies with ANSI C63.4 2003 requirement.

1.7 Applied Standards

According to the specifications of the manufacturer, the EUT must comply with the requirements of the following standards:

- ♦ FCC Part 15 Subpart C §15.247
- ♦ FCC Public Notice DA 00-705
- ♦ ANSI C63.10-2009

Remark:

1. All test items were verified and recorded according to the standards and without any deviation during the test.
2. This EUT has also been tested and complied with the requirements of FCC Part 15, Subpart B, recorded in a separate test report.

2 Test Configuration of Equipment Under Test

2.1 Descriptions of Test Mode

Preliminary tests were performed in different data rate and recorded the RF output power in the following table:

Channel	Frequency	Bluetooth RF Output Power		
		Data Rate / Modulation		
		GFSK	$\pi/4$ -DQPSK	8-DPSK
		1Mbps	2Mbps	3Mbps
Ch00	2402MHz	6.57 dBm	6.29 dBm	6.62 dBm
Ch39	2441MHz	6.12 dBm	5.79 dBm	6.04 dBm
Ch78	2480MHz	6.44 dBm	6.11 dBm	6.36 dBm

Remark:

1. All the test data for each data rate were verified, but only the worst case was reported.
 2. The data rate was set in 3Mbps for all the test items due to the highest RF output power.
- a. The EUT has been associated with peripherals pursuant to ANSI C63.10-2009 and configuration operated in a manner tended to maximize its emission characteristics in a typical application. Frequency range investigated: conduction (150 kHz to 30 MHz), radiation (9 kHz to the 10th harmonic of the highest fundamental frequency or to 40 GHz, whichever is lower). Pre-scanned tests, X, Y, Z in three orthogonal panels, and different data rates were conducted to determine the final configuration (X plane as worst plane) from all possible combinations, and the worst mode of radiated spurious emissions is Bluetooth 3Mbps mode, and recorded in this report
 - b. AC power line Conducted Emission was tested under maximum output power.

2.2 Test Mode

The following summary table is showing all test modes to demonstrate in compliance with the standard.

Summary table of Test Cases			
Test Item	Data Rate / Modulation		
	Bluetooth BR 1Mbps GFSK	Bluetooth EDR 2Mbps $\pi/4$ -DQPSK	Bluetooth EDR 3Mbps 8-DPSK
Conducted Test Cases	Mode 1: CH00_2402 MHz	Mode 4: CH00_2402 MHz	Mode 7: CH00_2402 MHz
	Mode 2: CH39_2441 MHz	Mode 5: CH39_2441 MHz	Mode 8: CH39_2441 MHz
	Mode 3: CH78_2480 MHz	Mode 6: CH78_2480 MHz	Mode 9: CH78_2480 MHz
Radiated Test Cases	Bluetooth EDR 3Mbps 8-DPSK		
	Mode 1: CH00_2402 MHz		
	Mode 2: CH39_2441 MHz		
	Mode 3: CH78_2480 MHz		
AC Conducted Emission	Mode 1 :GSM850 Idle + Bluetooth Link + WLAN Link + USB Cable 1 (Charging from Adapter) + Battery + Earphone		
	Mode 2 : GSM850 Idle + Bluetooth Link + WLAN Link + USB Cable 2 (Charging from Adapter) + Battery + Earphone		
Remark: 1. For radiated test cases, the worst mode data rate 3Mbps was reported only, because this data rate has the highest RF output power at preliminary tests, and the conducted spurious emissions and conducted band edge measurement for each data rate are no worse than 3Mbps, and no other significantly frequencies found in conducted spurious emission. 2. The worst case of conducted emission is mode 1; only the test data of this mode is reported.			

2.3 Connection Diagram of Test System

<Bluetooth Tx Mode>

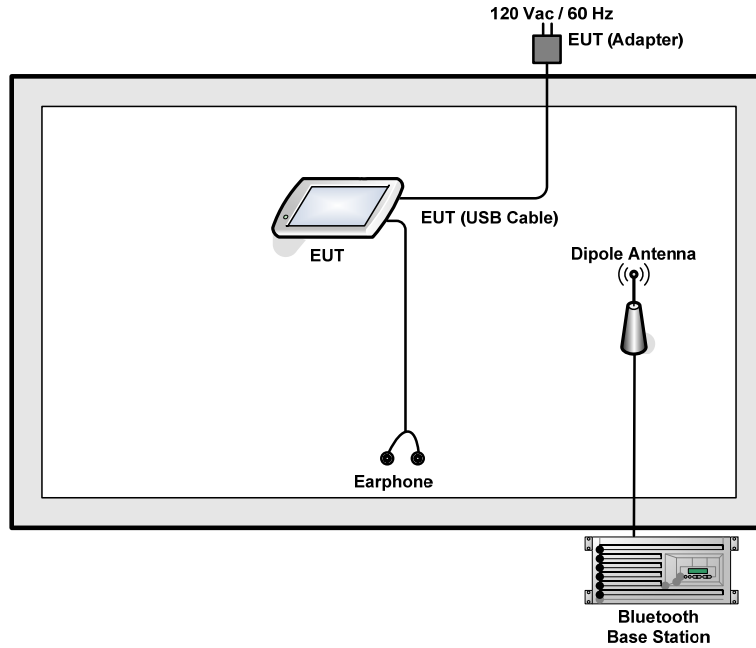

<AC Conducted Emission Mode>

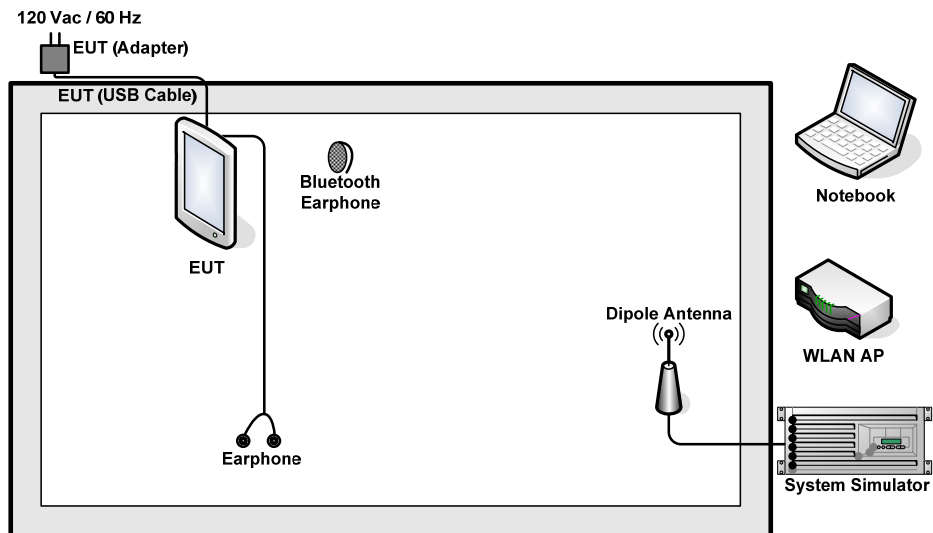

2.4 Support Unit used in test configuration and system

Item	Equipment	Trade Name	Model Name	FCC ID	Data Cable	Power Cord
1.	System Simulator	R&S	CMU 200	N/A	N/A	Unshielded, 1.8 m
2.	Bluetooth Base Station	R&S	CBT	FCC DoC	N/A	Unshielded, 1.8 m
3.	Bluetooth Base Station	R&S	CBT32	FCC DoC	N/A	Unshielded, 1.8 m
4.	DC Power Supply	GWINSTEK	GPS-3030D	N/A	N/A	Unshielded, 1.8 m
5.	WLAN AP	D-Link	DIR-855	KA2DIR855A2	N/A	Unshielded, 1.8 m
6.	Notebook	DELL	P08S	QDS-BRCM1030	N/A	AC I/P: Unshielded, 0.9 m DC O/P: Shielded, 1.8 m
7.	Bluetooth Earphone	Lenovo	LBH301	N/A	N/A	N/A

2.5 Description of RF Function Operation Test Setup

For Bluetooth function, turn on “Enter Engineer” software on the EUT directly. Then, the EUT will get into the engineering modes to contact with Bluetooth base station for continuous transmitting and receiving signals.

2.6 Measurement Results Explanation Example

For conducted test items:

The offset level is set in the spectrum analyzer to compensate the RF cable loss and 10dB attenuator between EUT conducted output port and spectrum analyzer. With the offset compensation, the spectrum analyzer reading level is exactly the EUT RF output level.

The spectrum analyzer offset is derived from RF cable loss and 10dB attenuator factor.

Offset = RF cable loss + attenuator factor.

Following table shows an offset computation example with cable loss 5.6 dB.

Example :

$$\begin{aligned} \text{Offset(dB)} &= \text{RF cable loss(dB)} + \text{attenuator factor(dB)}. \\ &= 5.6 + 10 = 15.6 \text{ (dB)} \end{aligned}$$

3 Test Result

3.1 Number of Channel Measurement

3.1.1 Limits of Number of Hopping Frequency

Frequency hopping systems in the 2400-2483.5 MHz band shall use at least 15 channels.

3.1.2 Measuring Instruments

See list of measuring instruments of this test report.

3.1.3 Test Procedure

1. The testing follows FCC Public Notice DA 00-705 Measurement Guidelines.
2. The RF output of EUT was connected to the spectrum analyzer by RF cable and attenuator. The path loss was compensated to the results for each measurement.
3. Set to the maximum power setting and enable the EUT transmit continuously.
4. Enable the EUT hopping function.
5. Use the following spectrum analyzer settings: Span = the frequency band of operation; RBW \geq 1% of the span; VBW \geq RBW; Sweep = auto; Detector function = peak; Trace = max hold.
6. The number of hopping frequency used is defined as the number of total channel.
7. Record the measurement data derived from spectrum analyzer.

3.1.4 Test Setup

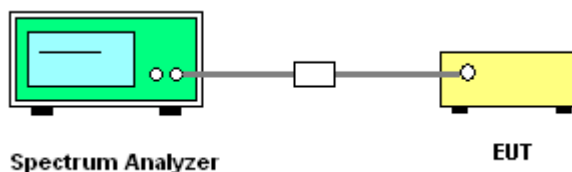

3.1.5 Test Result of Number of Hopping Frequency

Test Mode :	3Mbps	Temperature :	23~24°C
Test Engineer :	Lizy Li	Relative Humidity :	47~48%

Number of Hopping (Channel)	Adaptive Frequency Hopping (Channel)	Limits (Channel)	Pass/Fail
79	>= 20	> 15	Pass



Number of Hopping Channel Plot on Channel 00 - 78

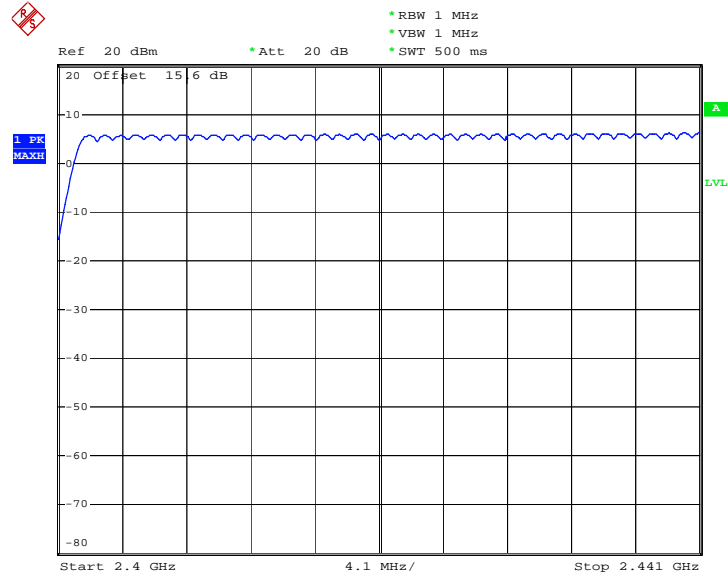

Date: 14.MAR.2013 06:19:35

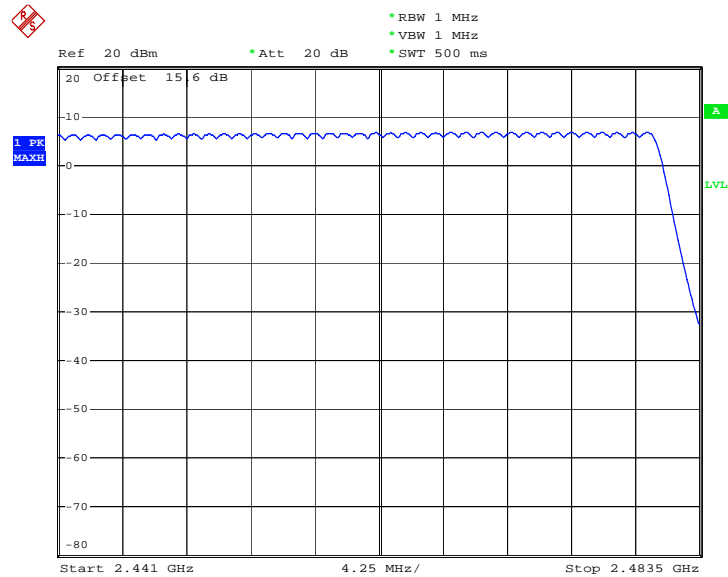

Date: 14.MAR.2013 06:24:30

3.2 Hopping Channel Separation Measurement

3.2.1 Limit of Hopping Channel Separation

Frequency hopping systems operating in the 2400-2483.5 MHz band may have hopping channel carrier frequencies that are separated by 25 kHz or two-thirds of the 20 dB bandwidth of the hopping channel, whichever is greater.

3.2.2 Measuring Instruments

See list of measuring instruments of this test report.

3.2.3 Test Procedures

1. The testing follows FCC Public Notice DA 00-705 Measurement Guidelines.
2. The RF output of EUT was connected to the spectrum analyzer by RF cable and attenuator. The path loss was compensated to the results for each measurement.
3. Set to the maximum power setting and enable the EUT transmit continuously.
4. Enable the EUT hopping function.
5. Use the following spectrum analyzer settings:
Span = wide enough to capture the peaks of two adjacent channels; $RBW \geq 1\%$ of the span;
 $VBW \geq RBW$; Sweep = auto; Detector function = peak; Trace = max hold.
6. Measure and record the results in the test report.

3.2.4 Test Setup

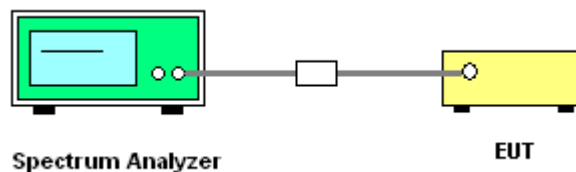



3.2.5 Test Result of Hopping Channel Separation

Test Mode :	1Mbps	Temperature :	23~24°C
Test Engineer :	Lizy Li	Relative Humidity :	47~48%

Channel	Frequency (MHz)	Frequency Separation (MHz)	(2/3 of 20dB BW) Limits (MHz)	Pass/Fail
00	2402	1.008	0.6053	Pass
39	2441	1.002	0.6240	Pass
78	2480	1.002	0.5653	Pass

Channel Separation Plot on Channel 00 - 01

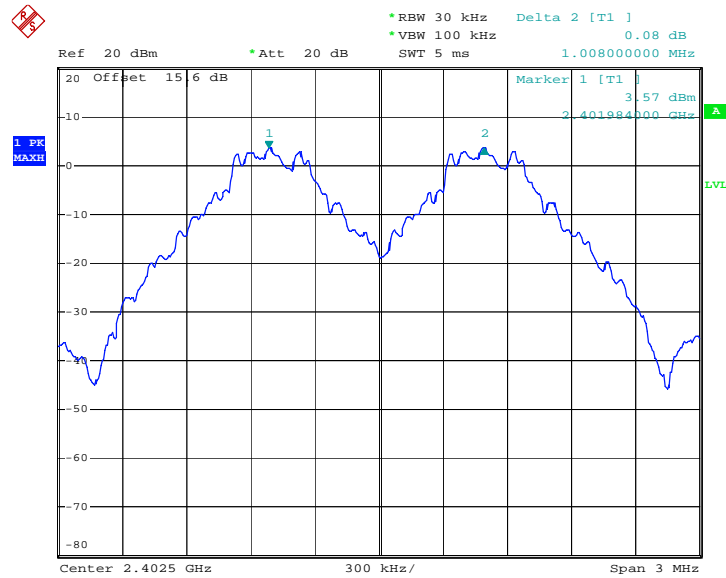

Date: 14.MAR.2013 05:31:01



Channel Separation Plot on Channel 39 - 40

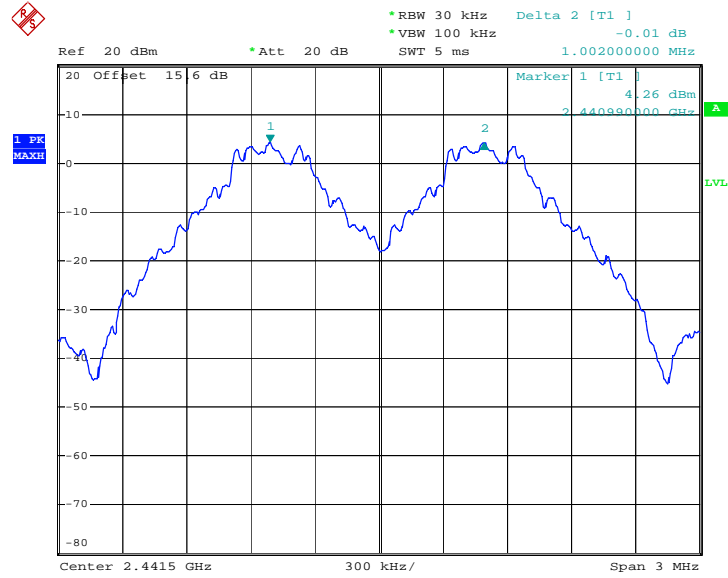

Date: 14.MAR.2013 05:31:53

Channel Separation Plot on Channel 77 - 78

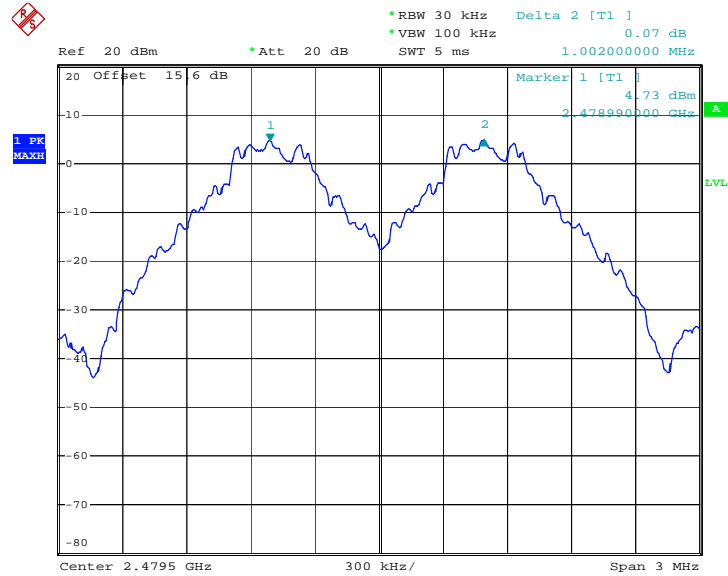

Date: 14.MAR.2013 05:51:29



Test Mode :	2Mbps	Temperature :	23~24°C
Test Engineer :	Lizy Li	Relative Humidity :	47~48%

Channel	Frequency (MHz)	Frequency Separation (MHz)	(2/3 of 20dB BW) Limits (MHz)	Pass/Fail
00	2402	1.002	0.8520	Pass
39	2441	1.002	0.8560	Pass
78	2480	1.002	0.8440	Pass

Channel Separation Plot on Channel 00 - 01

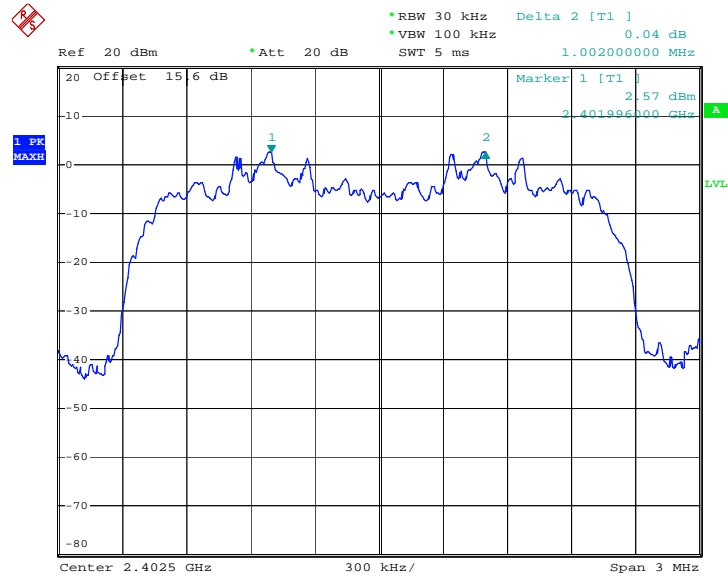

Date: 14.MAR.2013 05:52:48



Channel Separation Plot on Channel 39 - 40

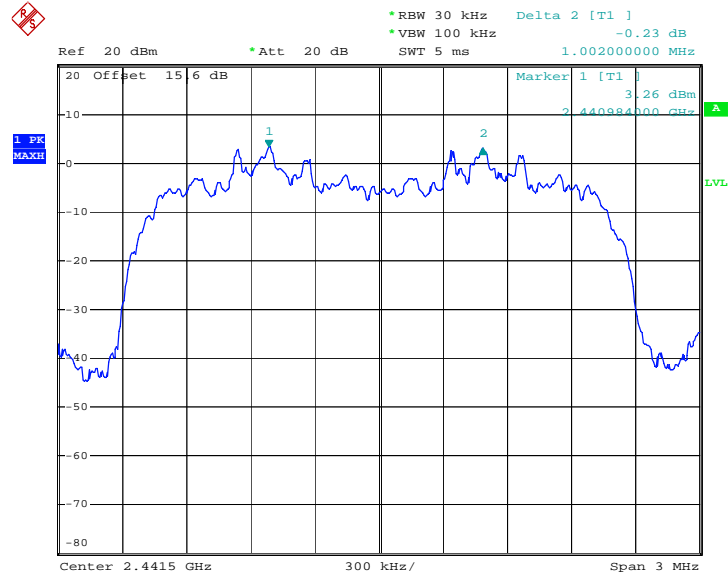

Date: 14.MAR.2013 05:54:13

Channel Separation Plot on Channel 77 - 78

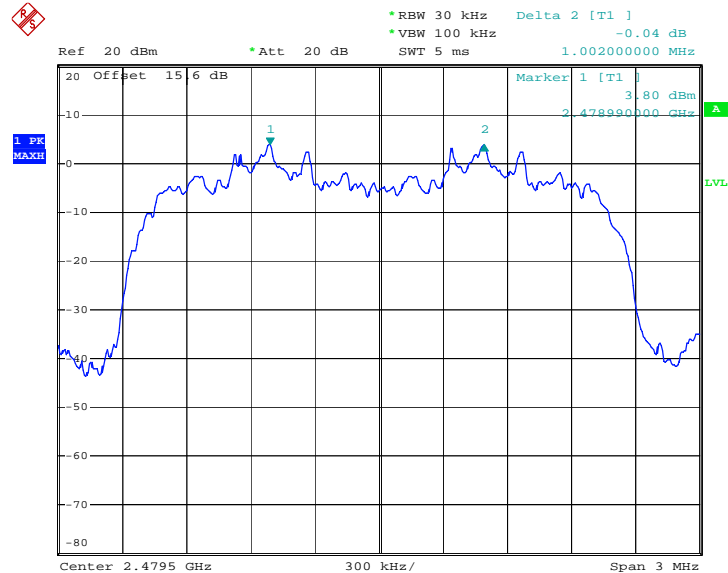

Date: 14.MAR.2013 05:54:57



Test Mode :	3Mbps	Temperature :	23~24°C
Test Engineer :	Lizy Li	Relative Humidity :	47~48%

Channel	Frequency (MHz)	Frequency Separation (MHz)	(2/3 of 20dB BW) Limits (MHz)	Pass/Fail
00	2402	1.002	0.8640	Pass
39	2441	1.002	0.8640	Pass
78	2480	1.002	0.8440	Pass

Channel Separation Plot on Channel 00 - 01

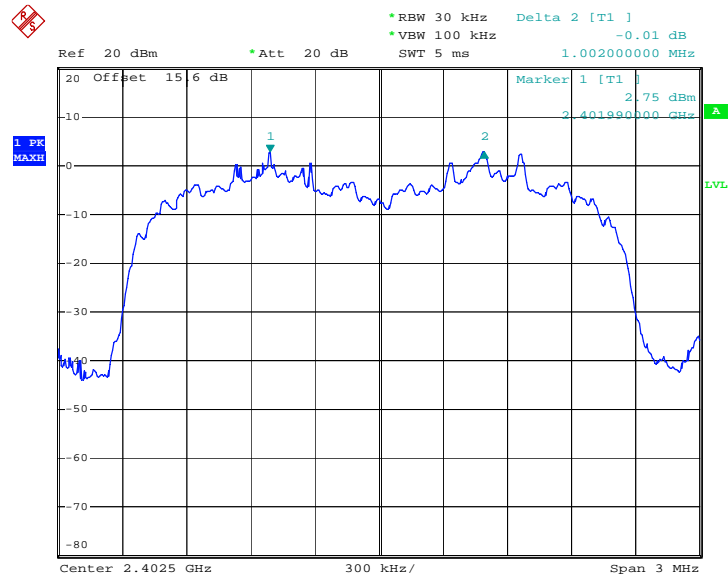

Date: 14.MAR.2013 05:56:18



Channel Separation Plot on Channel 39 - 40

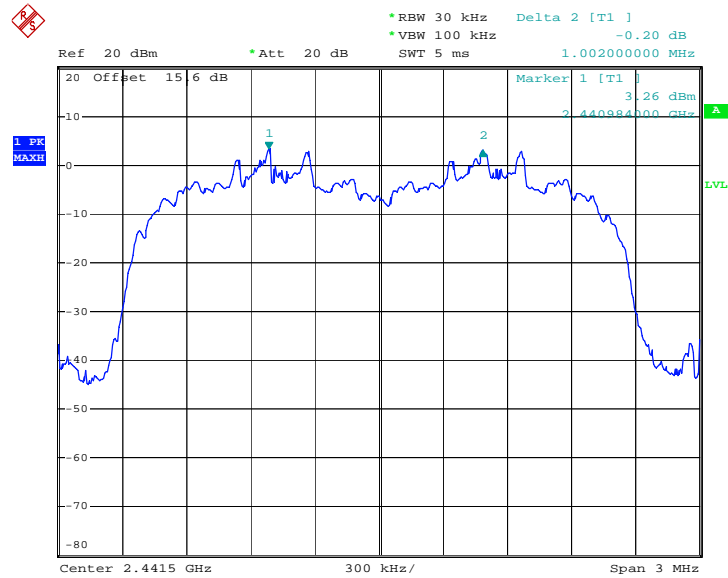

Date: 14.MAR.2013 05:58:01

Channel Separation Plot on Channel 77 - 78

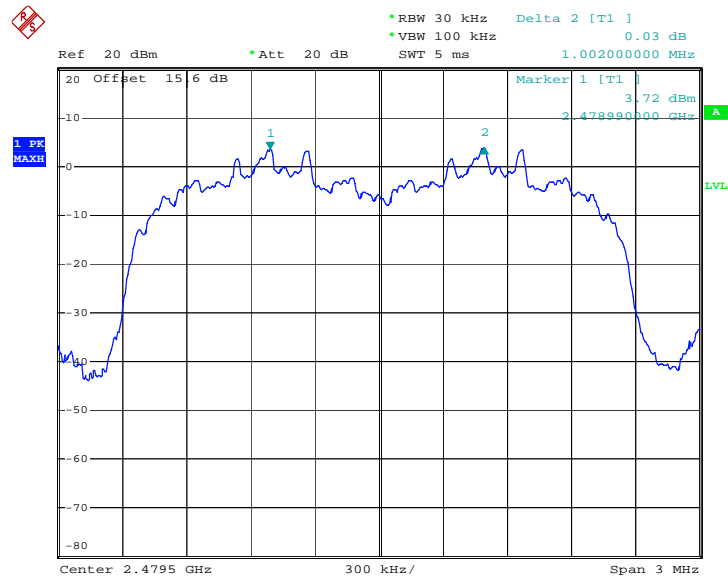

Date: 14.MAR.2013 05:58:40

3.3 Dwell Time Measurement

3.3.1 Limit of Dwell Time

The average time of occupancy on any channel shall not be greater than 0.4 seconds within a period of 0.4 seconds multiplied by the number of hopping channels employed.

3.3.2 Measuring Instruments

See list of measuring instruments of this test report.

3.3.3 Test Procedures

1. The testing follows FCC Public Notice DA 00-705 Measurement Guidelines.
2. The RF output of EUT was connected to the spectrum analyzer by RF cable and attenuator. The path loss was compensated to the results for each measurement.
3. Set to the maximum power setting and enable the EUT transmit continuously.
4. Enable the EUT hopping function.
5. Use the following spectrum analyzer settings: Span = zero span, centered on a hopping channel; RBW = 1 MHz; VBW ≥ RBW; Sweep = as necessary to capture the entire dwell time per hopping channel; Detector function = peak; Trace = max hold.
6. Measure and record the results in the test report.

3.3.4 Test Setup

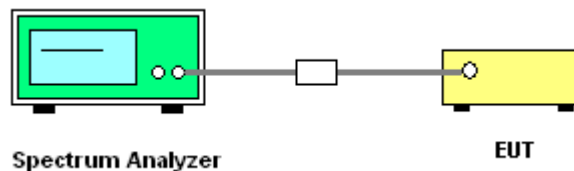

3.3.5 Test Result of Dwell Time

Test Mode :	3DH5	Temperature :	23~24°C
Test Engineer :	Lizy Li	Relative Humidity :	47~48%

Mode	Hopping Channel Number	Hops Over Occupancy Time(hops)	Package Transfer Time (msec)	Dwell Time (sec)	Limits (sec)	Pass/Fail
Normal	79	106.67	2.962	0.32	0.4	Pass
AFH	20	53.34	2.962	0.16	0.4	Pass

Remark:

1. In normal mode, hopping rate is 1600hops/s with 6 slots in 79 hopping channels.
 With channel hopping rate (1600 / 6 / 79) in Occupancy Time Limit (0.4 x 79) (s),
 Hops Over Occupancy Time comes to (1600 / 6 / 79) x (0.4 x 79) = 106.67 hops.

2. In AFH mode, hopping rate is 800hops/s with 6 slots in 20 hopping channels.
 With channel hopping rate (800 / 6 / 20) in Occupancy Time Limit (0.4 x 20) (s),
 Hops Over Occupancy Time comes to (800 / 6 / 20) x (0.4 x 20) = 53.34 hops.

3. Dwell Time(s) = Hops Over Occupancy Time (hops) x Package Transfer Time

Package Transfer Time Plot

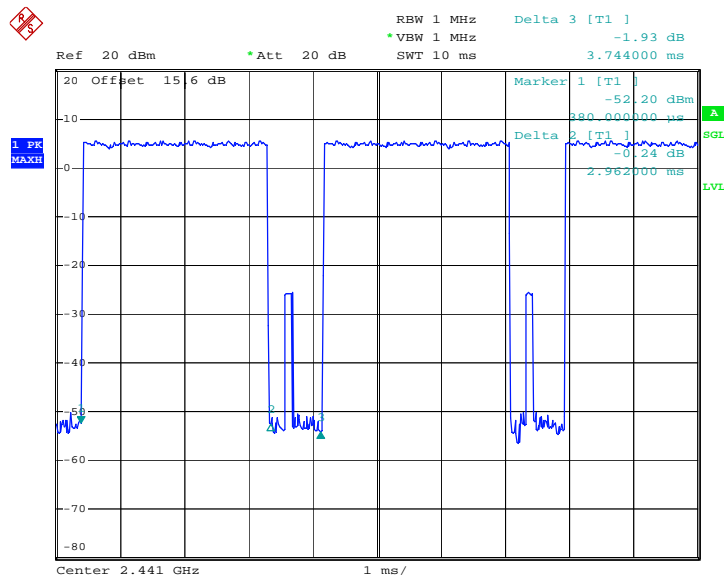

Date: 11.MAR.2013 07:26:29

3.4 20dB Bandwidth Measurement

3.4.1 Limit of 20dB Bandwidth

Reporting only

3.4.2 Measuring Instruments

See list of measuring instruments of this test report.

3.4.3 Test Procedures

1. The testing follows FCC Public Notice DA 00-705 Measurement Guidelines.
2. The RF output of EUT was connected to the spectrum analyzer by RF cable and attenuator. The path loss was compensated to the results for each measurement.
3. Set to the maximum power setting and enable the EUT transmit continuously.
4. Use the following spectrum analyzer settings for 20dB Bandwidth measurement.
Span = approximately 2 to 3 times the 20 dB bandwidth, centered on a hopping channel;
RBW \geq 1% of the 20 dB bandwidth; VBW \geq RBW; Sweep = auto; Detector function = peak;
Trace = max hold.
5. Measure and record the results in the test report.

3.4.4 Test Setup

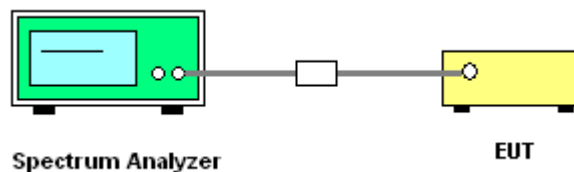

3.4.5 Test Result of 20dB Bandwidth

Test Mode :	1Mbps	Temperature :	23~24°C
Test Engineer :	Lizy Li	Relative Humidity :	47~48%

Channel	Frequency (MHz)	20dB Bandwidth (MHz)
00	2402	0.908
39	2441	0.936
78	2480	0.848

20 dB Bandwidth Plot on Channel 00

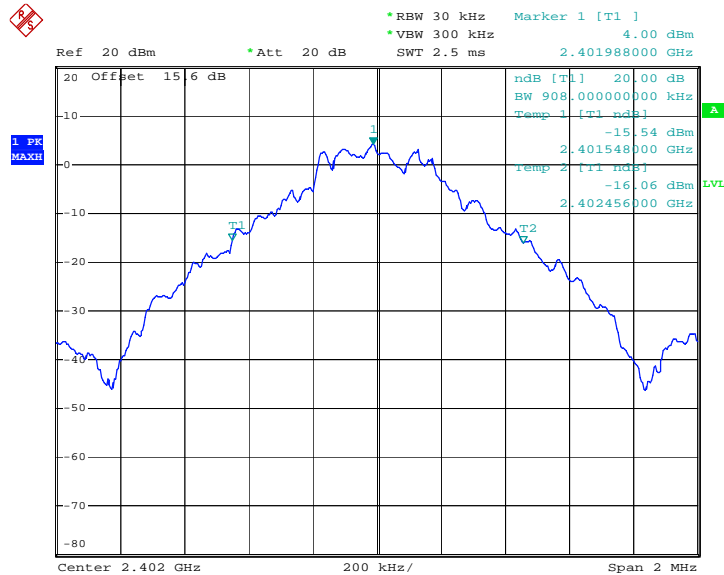

Date: 14.MAR.2013 05:58:54



20 dB Bandwidth Plot on Channel 39

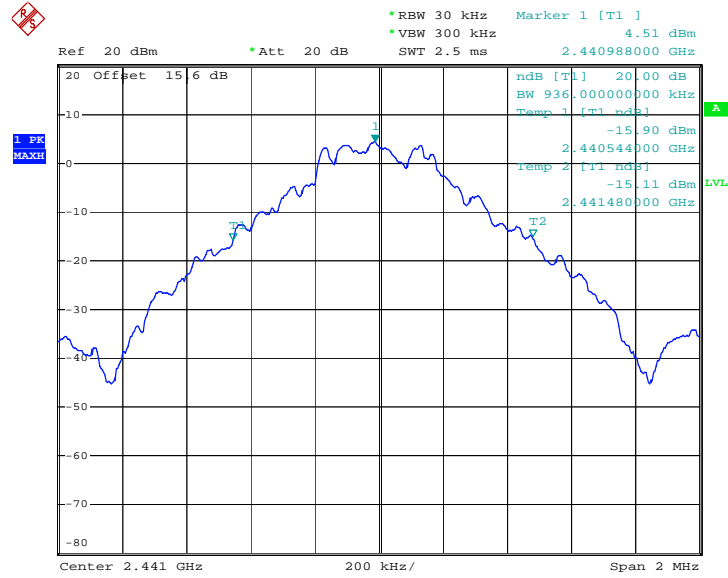

Date: 14.MAR.2013 05:59:04

20 dB Bandwidth Plot on Channel 78

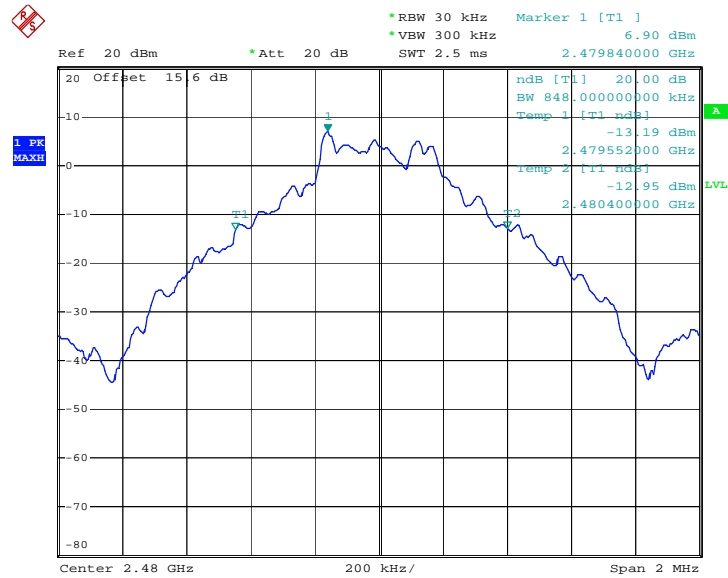

Date: 14.MAR.2013 05:59:16



Test Mode :	2Mbps	Temperature :	23~24°C
Test Engineer :	Lizy Li	Relative Humidity :	47~48%

Channel	Frequency (MHz)	20dB Bandwidth (MHz)
00	2402	1.278
39	2441	1.284
78	2480	1.266

20 dB Bandwidth Plot on Channel 00

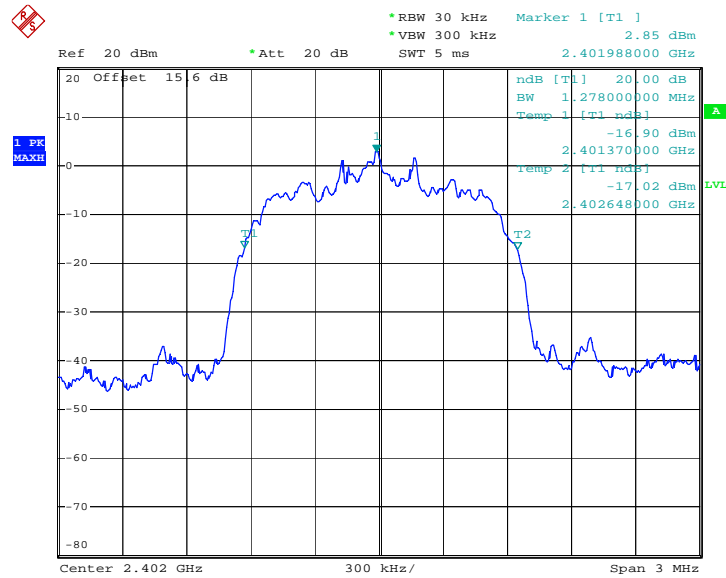

Date: 14.MAR.2013 05:59:30



20 dB Bandwidth Plot on Channel 39

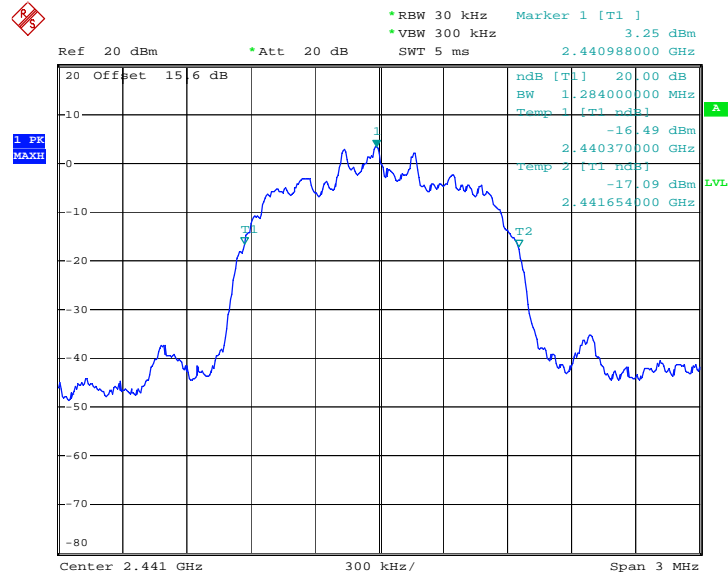

Date: 14.MAR.2013 05:59:44

20 dB Bandwidth Plot on Channel 78

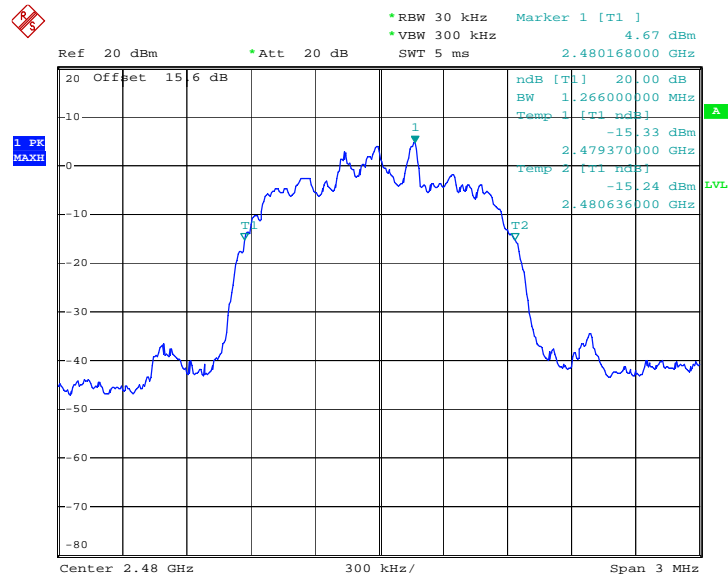

Date: 14.MAR.2013 05:59:58



Test Mode :	3Mbps	Temperature :	23~24°C
Test Engineer :	Lizy Li	Relative Humidity :	47~48%

Channel	Frequency (MHz)	20dB Bandwidth (MHz)
00	2402	1.296
39	2441	1.296
78	2480	1.266

20 dB Bandwidth Plot on Channel 00

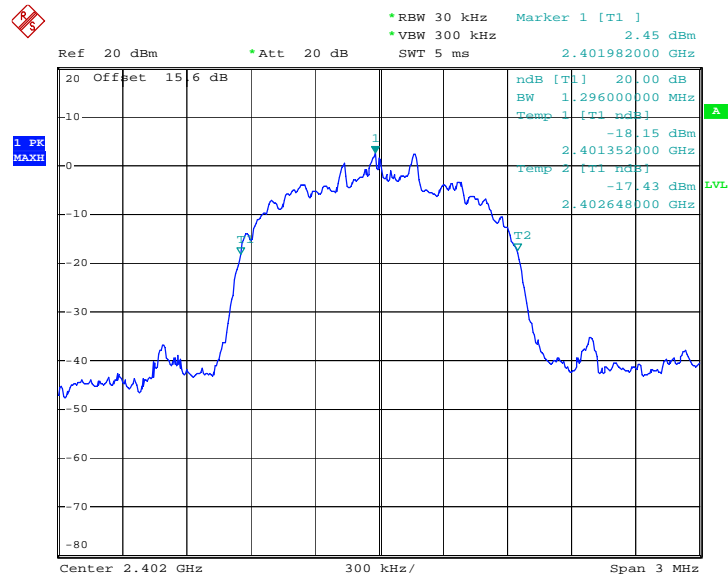

Date: 14.MAR.2013 06:00:11



20 dB Bandwidth Plot on Channel 39

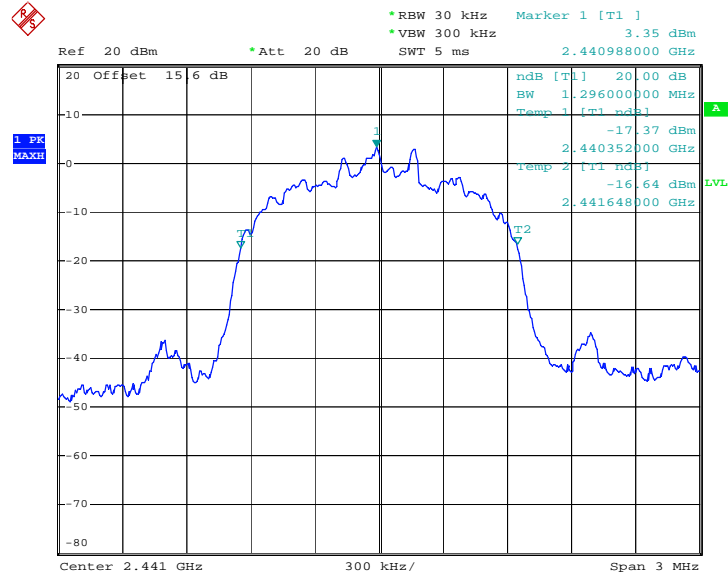

Date: 14.MAR.2013 06:00:34

20 dB Bandwidth Plot on Channel 78

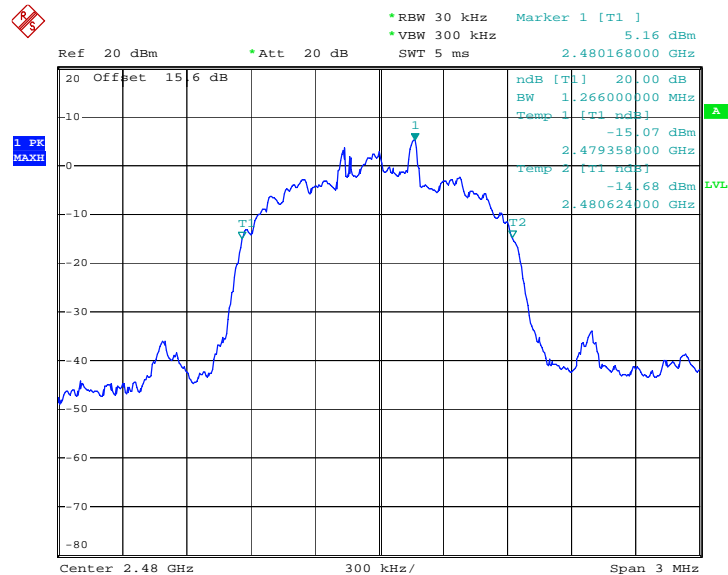

Date: 14.MAR.2013 06:00:46

3.5 Peak Output Power Measurement

3.5.1 Limit of Peak Output Power

Section 15.247 (b) The maximum peak conducted output power of the intentional radiator shall not exceed the following: (1) For frequency hopping systems operating in the 2400-2483.5 MHz band employing at least 75 non-overlapping hopping channels, and all frequency hopping systems in the 5725-5850 MHz band: 1 watt. For all other frequency hopping systems in the 2400-2483.5 MHz band 0.125 watts. The power limit for 1Mbps is 1watt, and for 2Mbps, and 3Mbps are 0.125 watts.

3.5.2 Measuring Instruments

See list of measuring instruments of this test report.

3.5.3 Test Procedures

1. The testing follows FCC Public Notice DA 00-705 Measurement Guidelines.
2. The RF output of EUT was connected to the spectrum analyzer by RF cable and attenuator. The path loss was compensated to the results for each measurement.
3. Set to the maximum power setting and enable the EUT transmit continuously.
4. Measure the conducted output power with cable loss and record the results in the test report.
5. Measure and record the results in the test report.

3.5.4 Test Setup

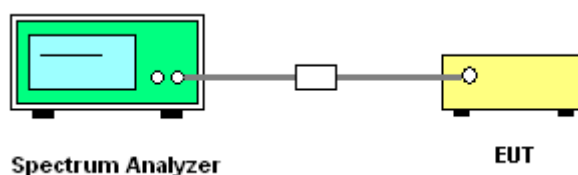



3.5.5 Test Result of Peak Output Power

Test Mode :	3Mbps	Temperature :	23~24°C
Test Engineer :	Lizy Li	Relative Humidity :	47~48%

Channel	Frequency (MHz)	RF Power (dBm)		
		8-DPSK	Max. Limits (dBm)	Pass/Fail
		3 Mbps		
00	2402	6.62	20.97	Pass
39	2441	6.04	20.97	Pass
78	2480	6.36	20.97	Pass

Peak Output Power Plot on Channel 00

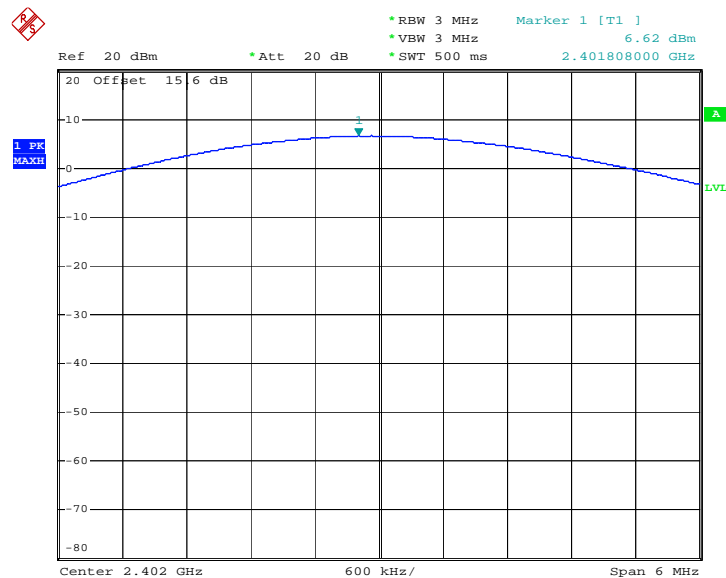

Date: 11.MAR.2013 07:19:40



Peak Output Power Plot on Channel 39

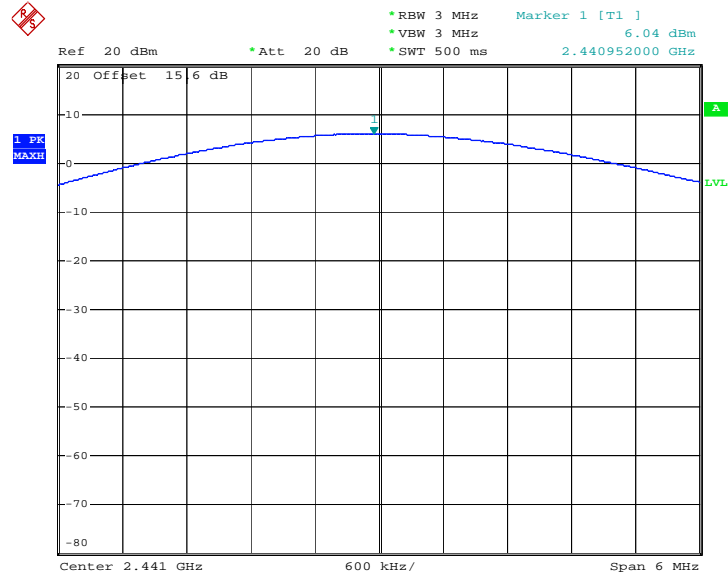

Date: 11.MAR.2013 07:20:55

Peak Output Power Plot on Channel 78

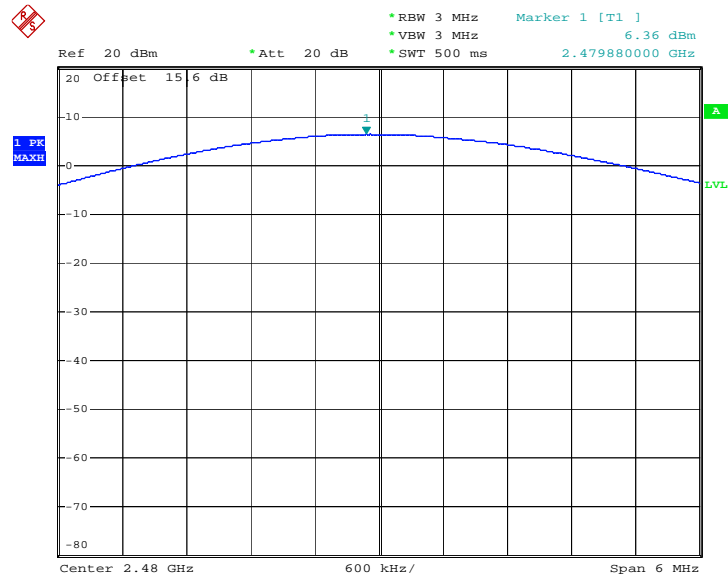

Date: 11.MAR.2013 07:22:10

3.6 Conducted Band Edges Measurement

3.6.1 Limit of Band Edges

In any 100 kHz bandwidth outside the intentional radiation frequency band, the radio frequency power shall be at least 20 dB below the highest level of the radiated power. In addition, radiated emissions which fall in the restricted bands must also comply with the radiated emission limits.

3.6.2 Measuring Instruments

See list of measuring instruments of this test report.

3.6.3 Test Procedures

1. The testing follows the guidelines in Band-edge Compliance of RF Conducted Emissions of FCC Public Notice DA 00-705 Measurement Guidelines.
2. Set to the maximum power setting and enable the EUT transmit continuously.
3. Set RBW = 300kHz ($\geq 1\%$ span=30MHz), VBW = 300kHz (\geq RBW). Band edge emissions must be at least 20 dB down from the highest emission level within the authorized band as measured with a 300kHz RBW. The attenuation shall be 30 dB instead of 20 dB when RMS conducted output power procedure is used.
4. Enable hopping function of the EUT and then repeat step 2. and 3.
5. Measure and record the results in the test report.

3.6.4 Test Setup

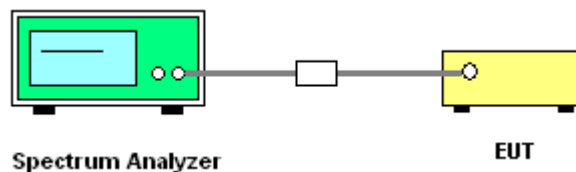



3.6.6 Test Result of Conducted Band Edges

Test Mode :	1Mbps	Temperature :	23~24°C
Test Channel :	00 and 78	Relative Humidity :	47~48%
		Test Engineer :	Lizy Li

Low Band Edge Plot on Channel 00

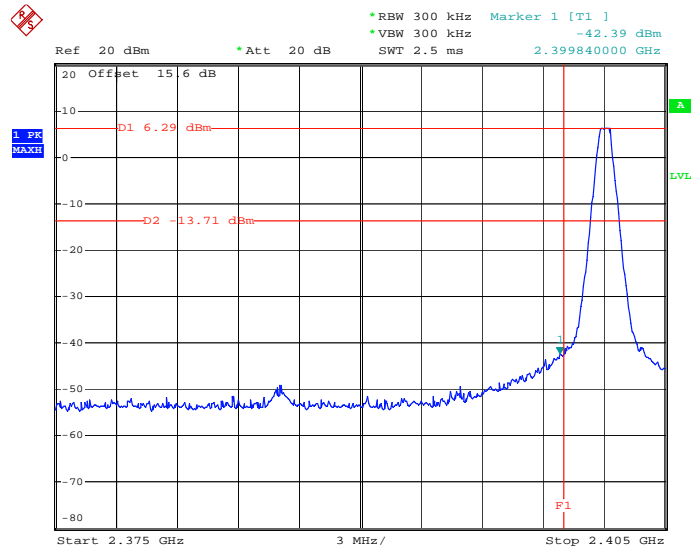

Date: 14.MAR.2013 06:01:41

High Band Edge Plot on Channel 78

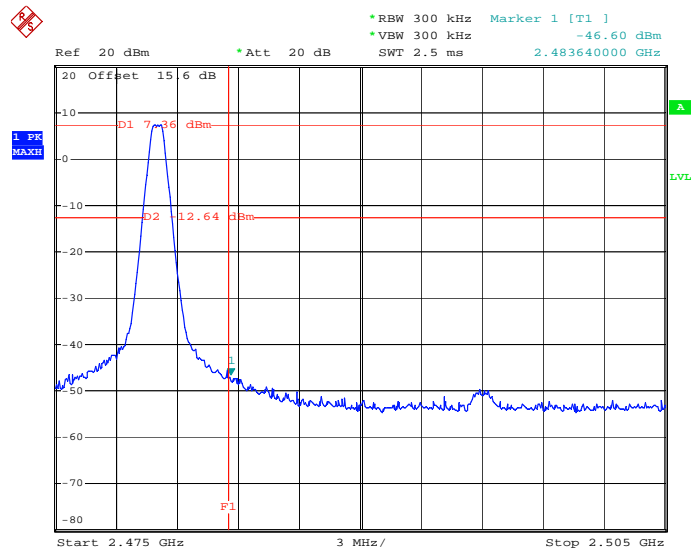

Date: 14.MAR.2013 06:02:43



Test Mode :	2Mbps	Temperature :	23~24°C
Test Channel :	00 and 78	Relative Humidity :	47~48%
		Test Engineer :	Lizy Li

Low Band Edge Plot on Channel 00

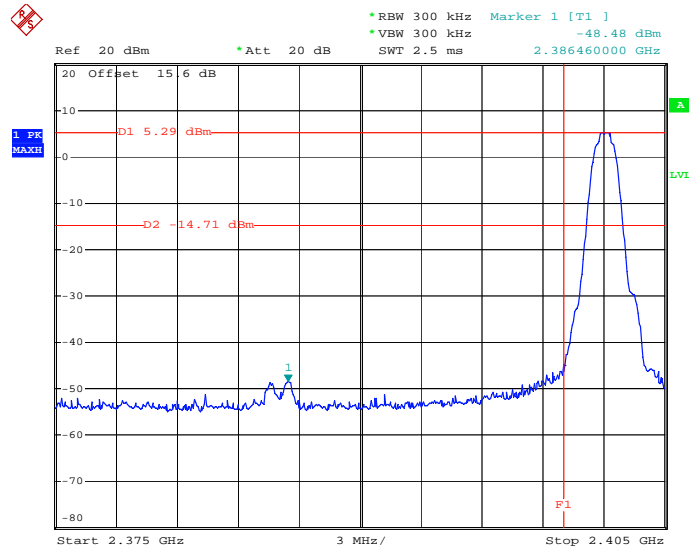

Date: 14.MAR.2013 07:04:40

High Band Edge Plot on Channel 78

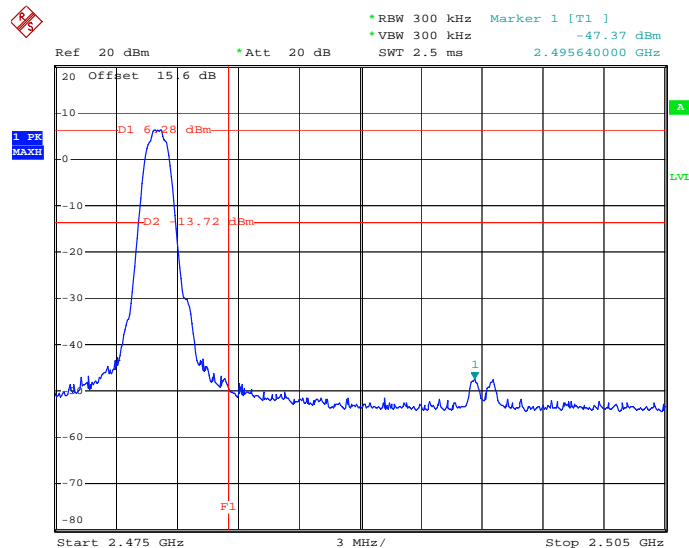

Date: 14.MAR.2013 06:04:38



Test Mode :	3Mbps	Temperature :	23~24°C
Test Channel :	00 and 78	Relative Humidity :	47~48%
		Test Engineer :	Lizy Li

Low Band Edge Plot on Channel 00

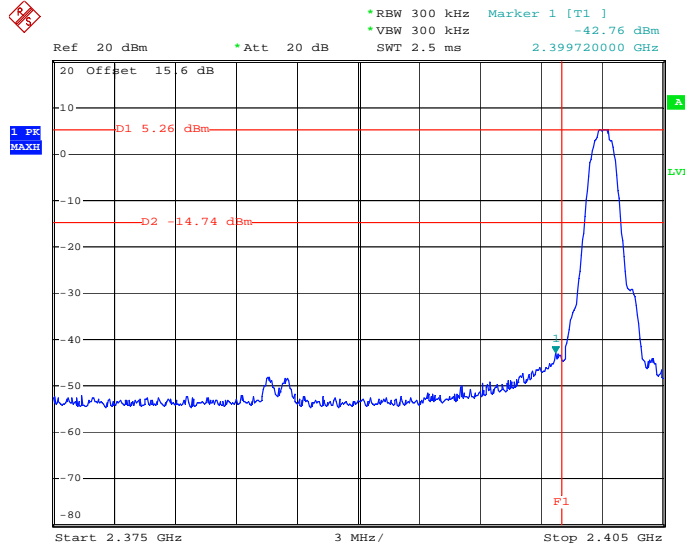

Date: 14.MAR.2013 06:05:30

High Band Edge Plot on Channel 78

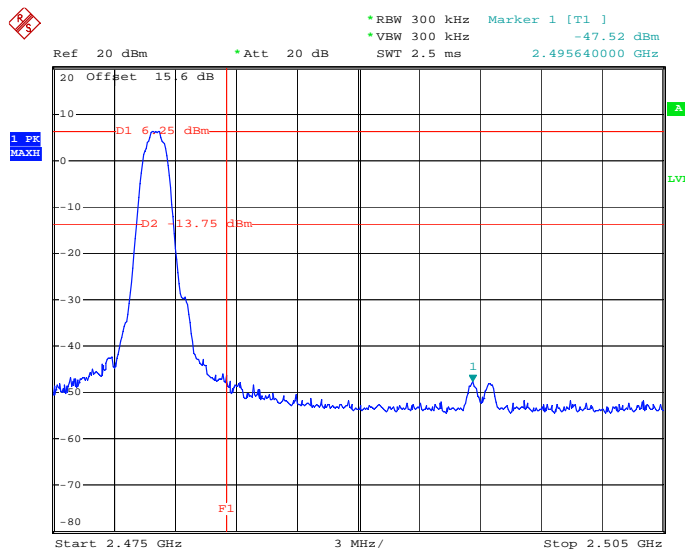

Date: 14.MAR.2013 06:06:32



3.6.7 Test Result of Conducted Hopping Mode Band Edges

Test Mode :	1Mbps	Temperature :	23~24°C
Test Engineer :	Lizy Li	Relative Humidity :	47~48%

Hopping Mode Low Band Edge Plot on Channel 00

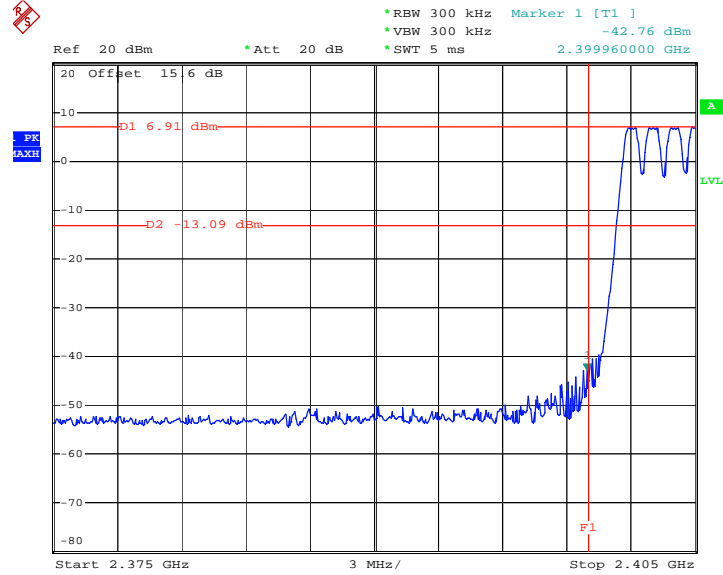

Date: 16.MAR.2013 22:06:11

Hopping Mode High Band Edge Plot on Channel 78

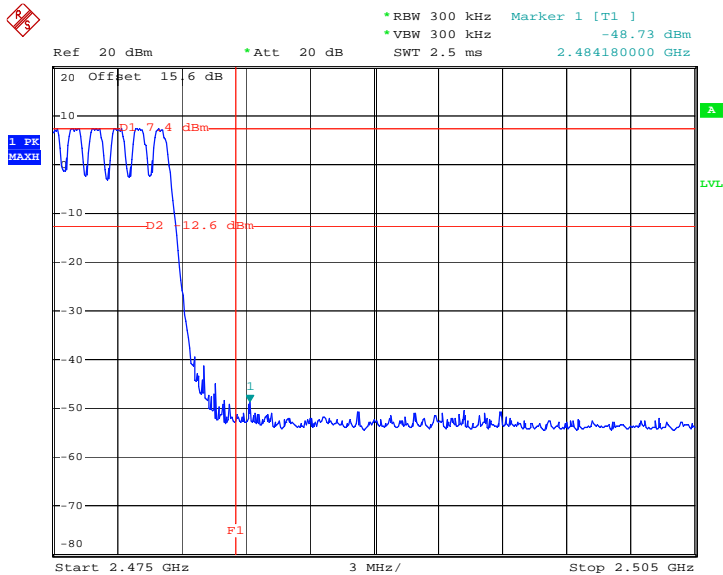

Date: 14.MAR.2013 07:03:16



Test Mode :	2Mbps	Temperature :	23~24°C
Test Engineer :	Lizy Li	Relative Humidity :	47~48%

Hopping Mode Low Band Edge Plot on Channel 00

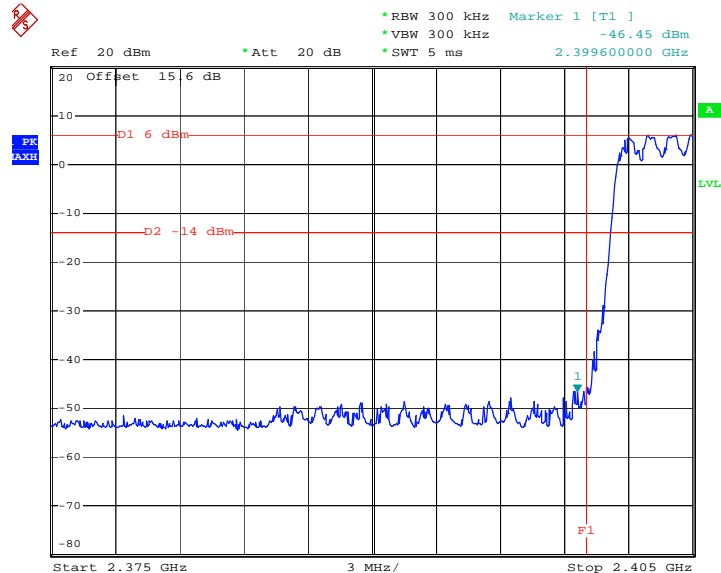

Date: 16.MAR.2013 22:13:51

Hopping Mode High Band Edge Plot on Channel 78

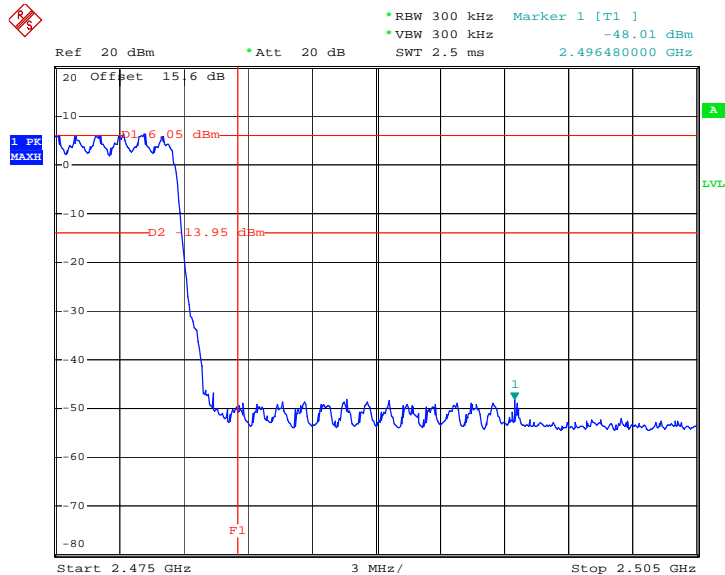

Date: 14.MAR.2013 07:01:31



Test Mode :	3Mbps	Temperature :	23~24°C
Test Engineer :	Lizy Li	Relative Humidity :	47~48%

Hopping Mode Low Band Edge Plot on Channel 00

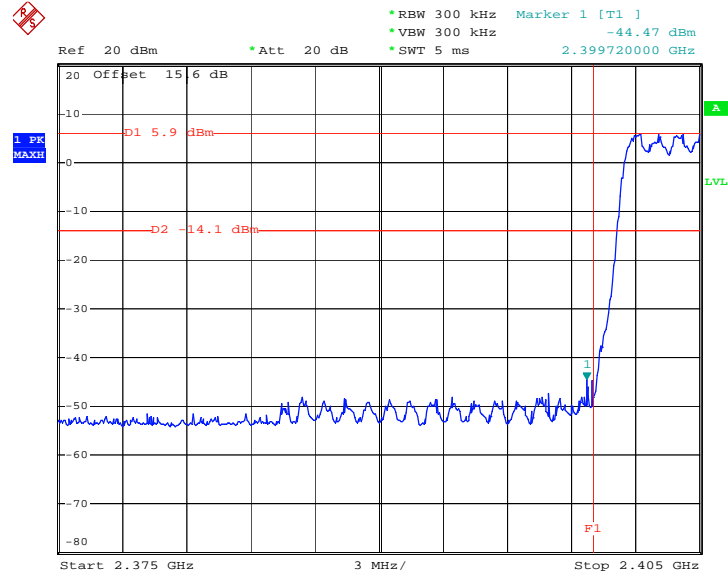

Date: 16.MAR.2013 22:15:53

Hopping Mode High Band Edge Plot on Channel 78

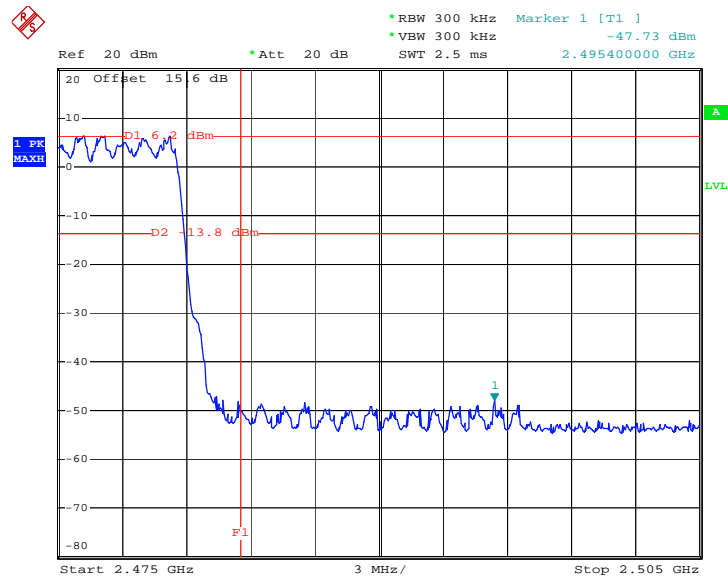

Date: 14.MAR.2013 07:02:22

3.7 Conducted Spurious Emission Measurement

3.7.1 Limit of Spurious Emission Measurement

In any 100 kHz bandwidth outside the intentional radiation frequency band, the radio frequency power shall be at least 20 dB below the highest level of the radiated power. In addition, radiated emissions which fall in the restricted bands must also comply with the radiated emission limits.

3.7.2 Measuring Instruments

See list of measuring instruments of this test report.

3.7.3 Test Procedure

1. The testing follows the guidelines in Spurious RF Conducted Emissions of FCC Public Notice DA 00-705 Measurement Guidelines
2. The RF output of EUT was connected to the spectrum analyzer by RF cable and attenuator. The path loss was compensated to the results for each measurement.
3. Set to the maximum power setting and enable the EUT transmit continuously.
4. Set RBW = 100 kHz, VBW = 300kHz, scan up through 10th harmonic. All harmonics / spurs must be at least 20 dB down from the highest emission level within the authorized band as measured with a 100 kHz RBW.
5. Measure and record the results in the test report.

3.7.4 Test Setup

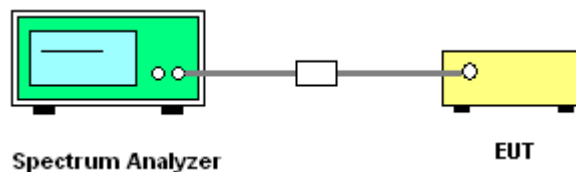



3.7.5 Test Results

Test Mode :	3Mbps	Temperature :	23~24°C
Test Channel :	00	Relative Humidity :	47~48%
		Test Engineer :	Lizy Li

Conducted Spurious Emission Plot between 30MHz ~ 3 GHz

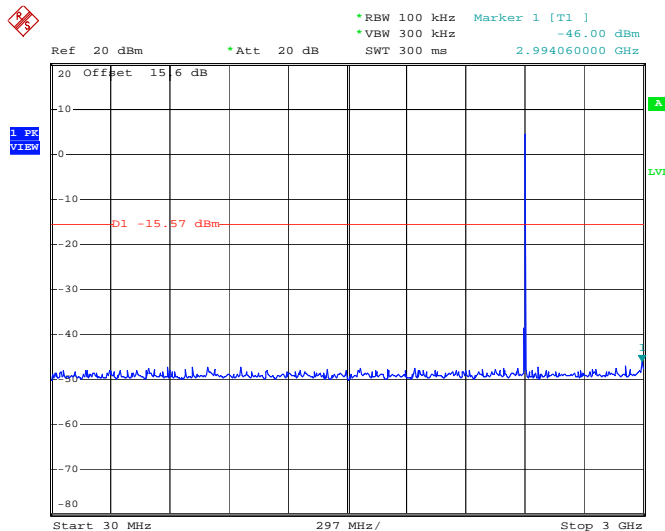

Date: 14.MAR.2013 06:12:52

Conducted Spurious Emission Plot between 2 GHz ~ 25 GHz

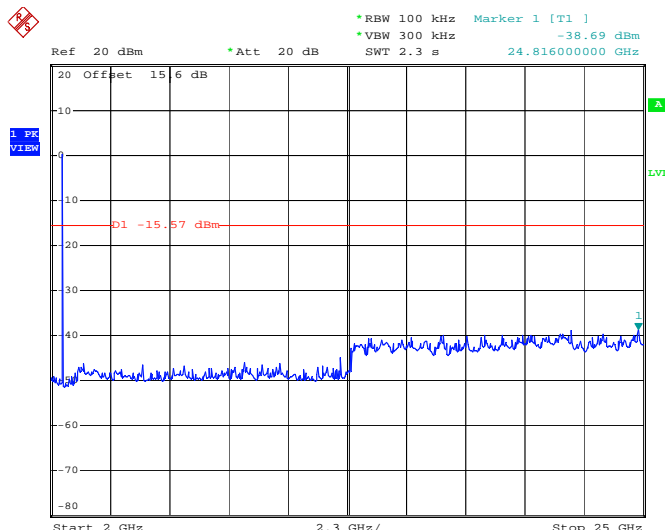

Date: 16.MAR.2013 02:01:36



Test Mode :	3Mbps	Temperature :	23~24°C
Test Channel :	39	Relative Humidity :	47~48%
		Test Engineer :	Lizy Li

Conducted Spurious Emission Plot between 30MHz ~ 3 GHz

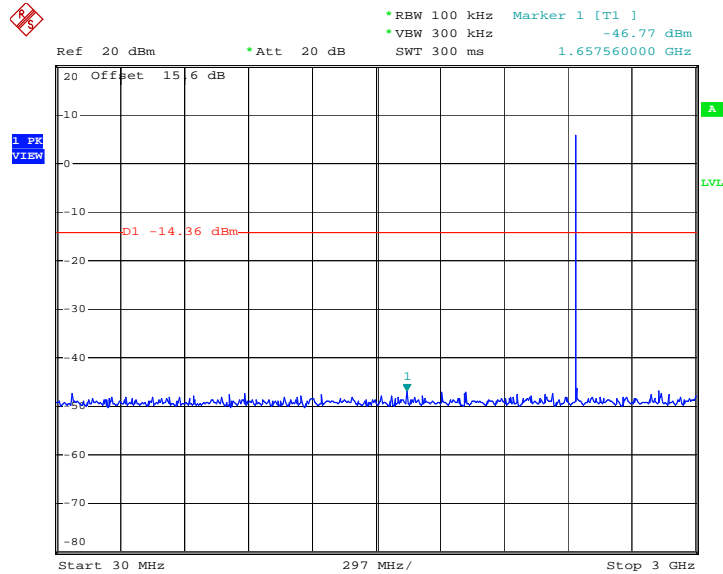

Date: 14.MAR.2013 06:13:56

Conducted Spurious Emission Plot between 2 GHz ~ 25 GHz

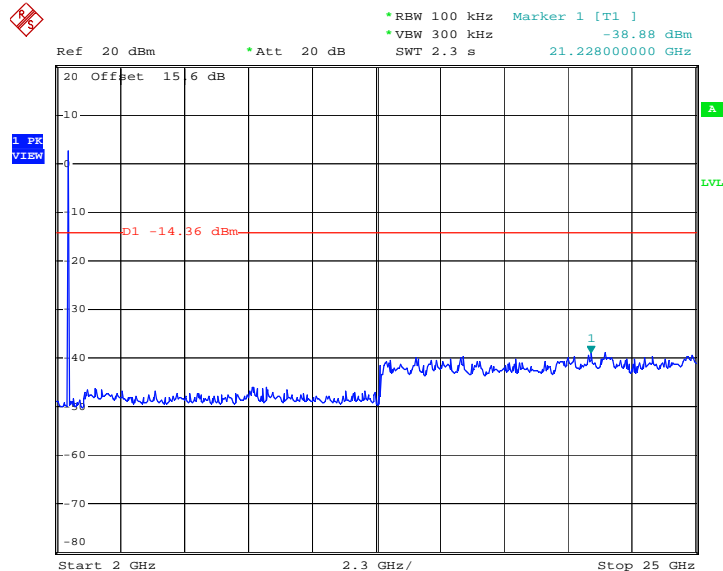

Date: 16.MAR.2013 02:00:44



Test Mode :	3Mbps	Temperature :	23~24°C
Test Channel :	78	Relative Humidity :	47~48%
		Test Engineer :	Lizy Li

Conducted Spurious Emission Plot between 30MHz ~ 3 GHz

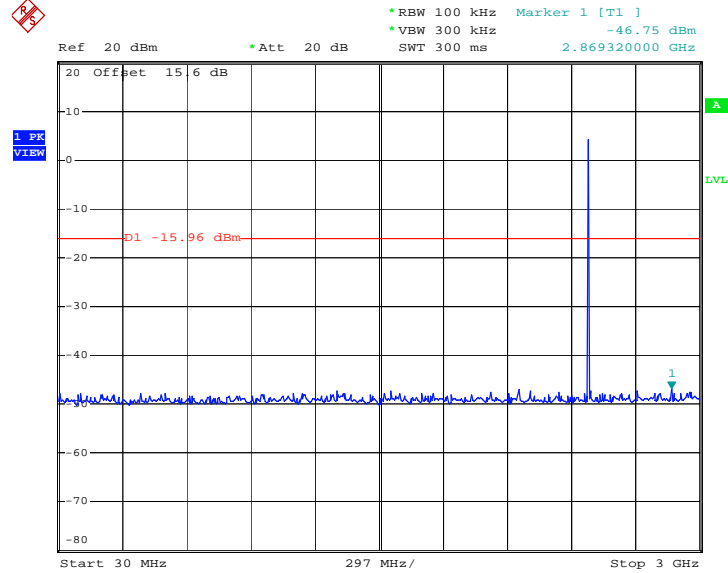

Date: 14.MAR.2013 06:15:00

Conducted Spurious Emission Plot between 2 GHz ~ 25 GHz

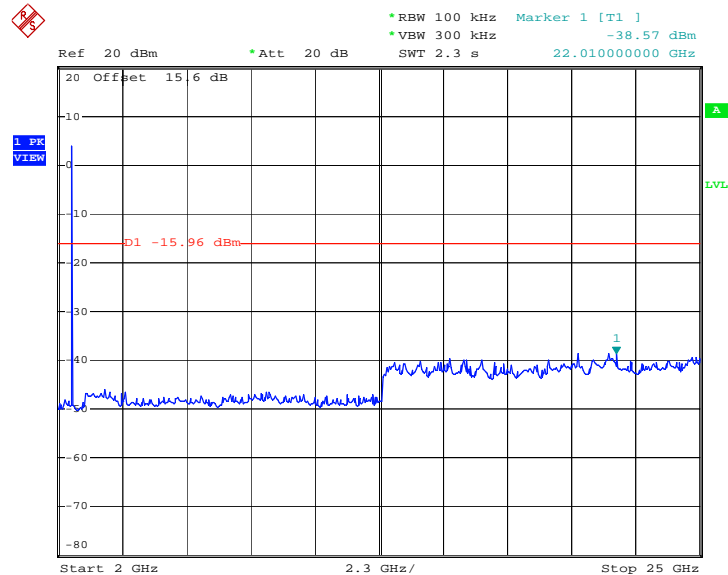

Date: 16.MAR.2013 02:00:07

3.8 Radiated Band Edges and Spurious Emission Measurement

3.8.1 Limit of Radiated Band Edges and Spurious Emission

In any 100 kHz bandwidth outside the intentional radiator frequency band, all harmonics/spurious must be at least 20 dB below the highest emission level within the authorized band. In addition, radiated emissions which fall in the restricted bands must also comply with the FCC section 15.209 limits as below.

Frequency (MHz)	Field Strength (microvolts/meter)	Measurement Distance (meters)
0.009 – 0.490	2400/F(kHz)	300
0.490 – 1.705	24000/F(kHz)	30
1.705 – 30.0	30	30
30 – 88	100	3
88 – 216	150	3
216 - 960	200	3
Above 960	500	3

3.8.2 Measuring Instruments

See list of measuring instruments of this test report.



3.8.3 Test Procedures

1. The testing follows the guidelines in Spurious Radiated Emissions of FCC Public Notice DA 00-705 Measurement Guidelines and fulfills ANSI C63.4-2003 and the guidelines in ANSI C63.10-2009 test site requirement.
2. The EUT was placed on a turntable with 0.8 meter above ground.
3. The EUT was set 3 meters from the interference receiving antenna, which was mounted on the top of a variable height antenna tower.
4. For each suspected emission, the EUT was arranged to its worst case and then tune the Antenna tower (from 1 m to 4 m) and turntable (from 0 degree to 360 degrees) to find the maximum reading. A pre-amp and a high pass filter are used for the test in order to get better signal level to comply with the guidelines.
5. Set to the maximum power setting and enable the EUT transmit continuously.
6. For measurement below 1GHz, If the emission level of the EUT measured by the peak detector is 3 dB lower than the applicable limit, the peak emission level will be reported. Otherwise, the emission measurement will be repeated using the quasi-peak detector and reported
7. Use the following spectrum analyzer settings:
 - (1) Span shall wide enough to fully capture the emission being measured;
 - (2) Set RBW=100 kHz for $f < 1$ GHz, RBW=1MHz for $f > 1$ GHz ; VBW \geq RBW; Sweep = auto; Detector function = peak; Trace = max hold for peak
 - (3) For average measurement: use duty cycle correction factor method per 15.35(c).
Duty cycle = On time/100 milliseconds
On time = $N_1 * L_1 + N_2 * L_2 + \dots + N_{n-1} * L_{n-1} + N_n * L_n$
Where N_1 is number of type 1 pulses, L_1 is length of type 1 pulses, etc.
Average Level = Peak Level + $20 * \log(\text{Duty cycle})$
8. Corrected Reading: Antenna Factor + Cable Loss + Read Level - Preamp Factor = Level

Note: The average levels were calculated from the peak level corrected with duty cycle correction factor (24.78dB) derived from $20 \log(\text{dwell time}/100\text{ms})$.

3.8.4 Test Setup

For radiated emissions below 30MHz

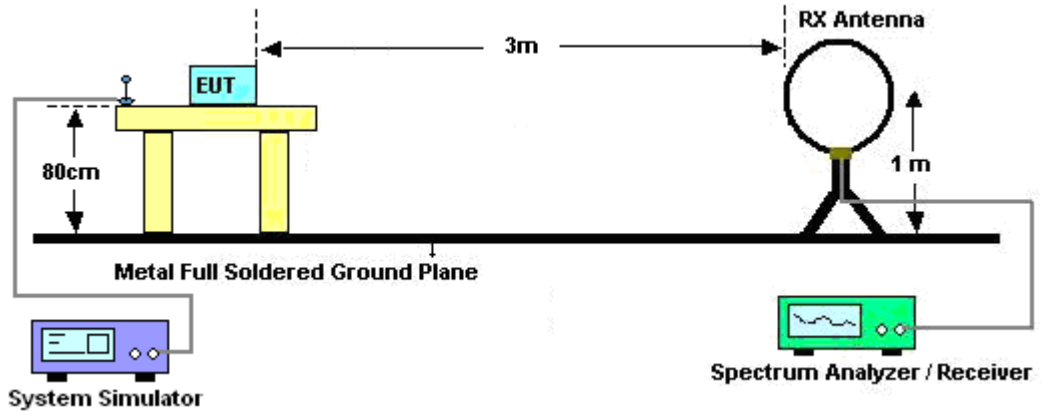

For radiated emissions from 30MHz to 1GHz

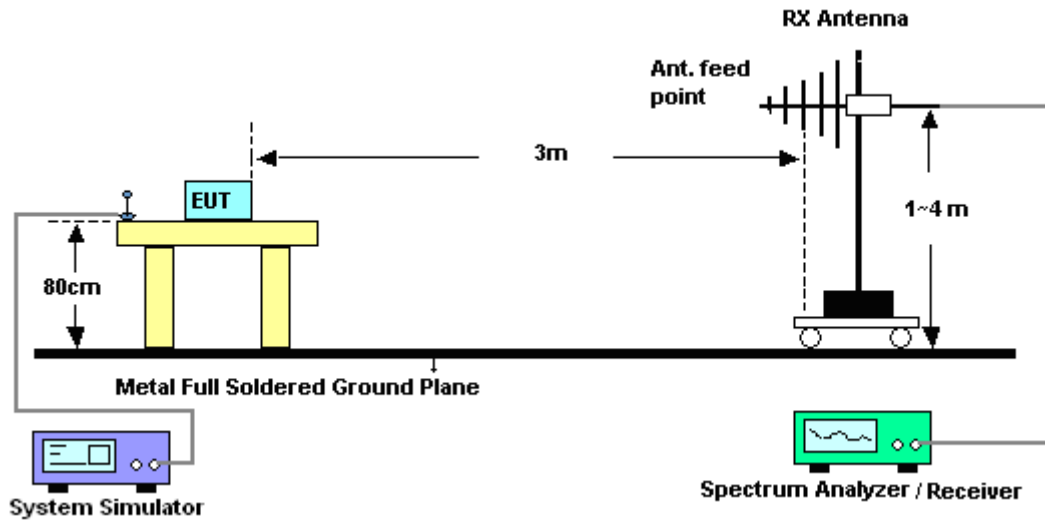

For radiated emissions above 1GHz

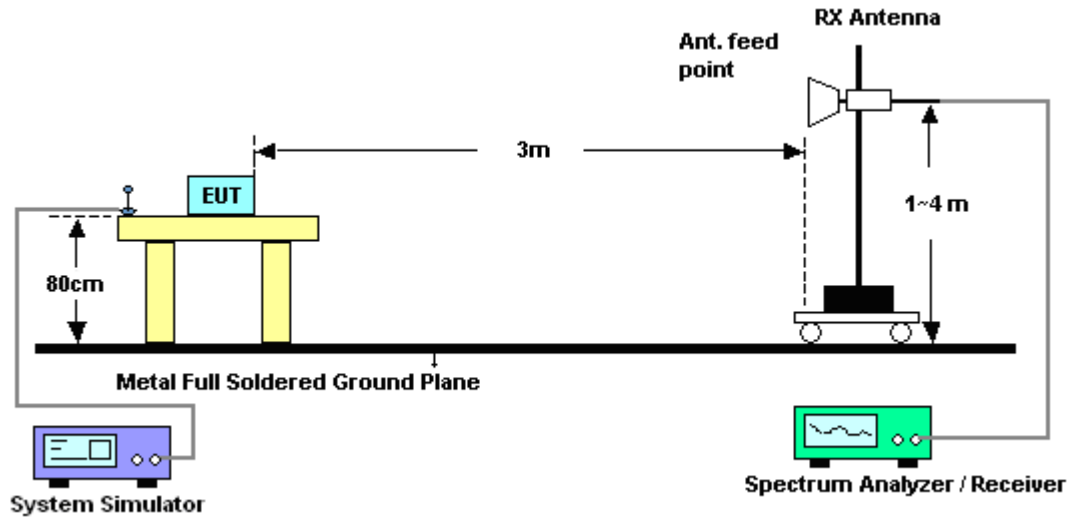

3.8.5 Test Results of Radiated Emissions (9 kHz ~ 30 MHz)

The low frequency, which started from 9 kHz to 30MHz, was pre-scanned and the result which was 20dB lower than the limit line per 15.31(o) was not reported.

3.8.6 Duty cycle correction factor for average measurement

3DH5 on time (One Pulse) Plot on Channel 39

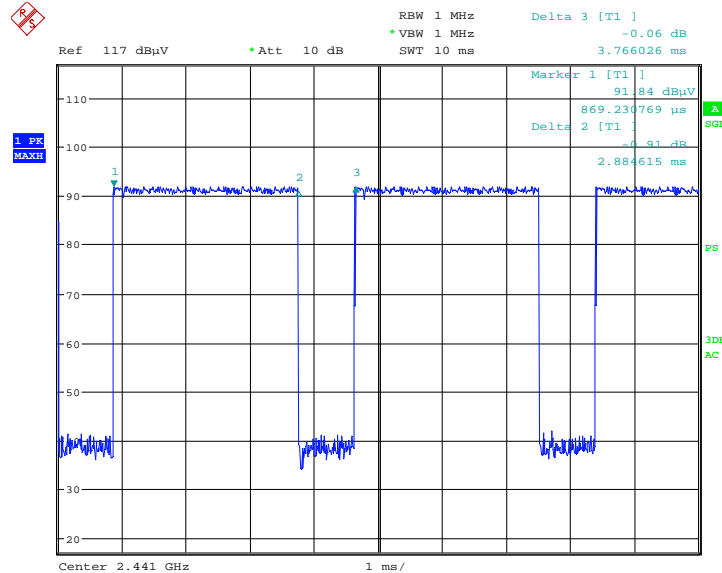

Date: 16.MAR.2013 22:12:14

3DH5 on time/100ms (Count Pulses) Plot on Channel 39

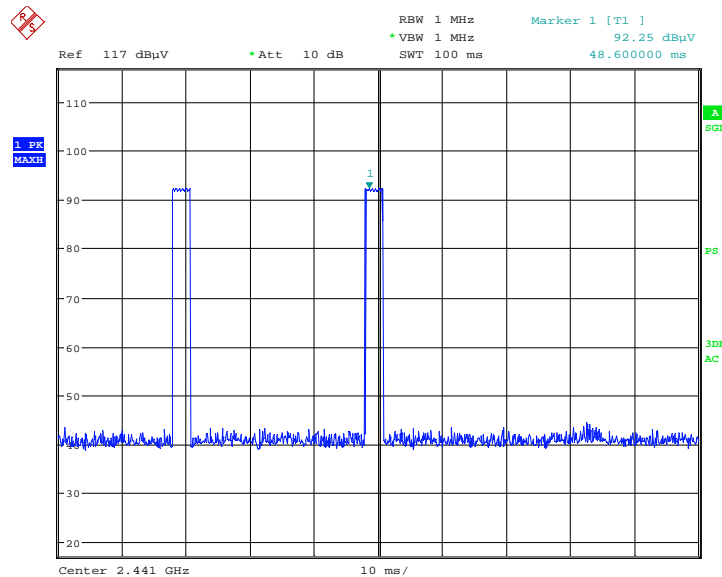

Date: 16.MAR.2013 22:13:44

Note:

1. Duty cycle = on time/100 milliseconds = $2 * 2.884615 / 100 = 5.77 \%$
2. Duty cycle correction factor = $20 * \log(\text{Duty cycle}) = -24.78 \text{ dB}$
3. 3DH5 has the highest duty cycle and is reported.

Duty Cycle Correction Factor Consideration for AFH mode:

Bluetooth normal hopping rate is 1600Hz and reduced to 800Hz in AFH mode; due to the reduced number of hopping frequencies, with the same packet configuration the dwell time in each channel frequency within 100msec period is longer in AFH mode than normal mode.

In AFH mode, the minimum hopping frequencies are 20, to get the longest dwell time DH5 packet is observed; the period to have DH5 packet completing one hopping sequence is

$$2.884615 \text{ ms} \times 20 \text{ channels} = 57.7 \text{ ms}$$

There cannot be 2 complete hopping sequences within 100ms period, considering the random hopping behavior, maximum 2 hops can be possibly observed within the period. $[100\text{ms} / 57.6\text{ms}] = 2$ hops

Thus, the maximum possible ON time:

$$2.884615 \text{ ms} \times 2 = 5.77 \text{ ms}$$

Worst case Duty Cycle Correction factor, which is derived from the maximum possible on time,

$$20 \times \log(5.77 \text{ ms}/100\text{ms}) = -24.78 \text{ dB}$$



3.8.7 Test Result of Radiated Band Edges

Test Mode :	3Mbps	Temperature :	23~24°C
Test Channel :	00	Relative Humidity :	42~43%
		Test Engineer :	Marlboro Wang

ANTENNA POLARITY : HORIZONTAL										
Frequency (MHz)	Level (dBμV/m)	Over Limit (dB)	Limit Line (dBμV/m)	Read Level (dBμV)	Antenna Factor (dB)	Cable Loss (dB)	Preamp Factor (dB)	Ant Pos (cm)	Table Pos (deg)	Remark
2386.32	54.8	-19.2	74	50.55	32.36	6.45	34.56	106	108	Peak
2386.32	30.02	-23.98	54	-	-	-	-	-	-	Average

ANTENNA POLARITY : VERTICAL										
Frequency (MHz)	Level (dBμV/m)	Over Limit (dB)	Limit Line (dBμV/m)	Read Level (dBμV)	Antenna Factor (dB)	Cable Loss (dB)	Preamp Factor (dB)	Ant Pos (cm)	Table Pos (deg)	Remark
2386.32	51.65	-22.35	74	47.4	32.36	6.45	34.56	142	270	Peak
2386.32	26.87	-27.13	54	-	-	-	-	-	-	Average

Note: The average levels were calculated from the peak level corrected with duty cycle correction factor (24.78dB) derived from 20log (dwell time/100ms).

For example: Average level = 51.65dBuV/m – 24.78 (dB) = 26.87dBuV/m.

Test Mode :	3Mbps	Temperature :	23~24°C
Test Channel :	78	Relative Humidity :	42~43%
		Test Engineer :	Marlboro Wang

ANTENNA POLARITY : HORIZONTAL										
Frequency (MHz)	Level (dBμV/m)	Over Limit (dB)	Limit Line (dBμV/m)	Read Level (dBμV)	Antenna Factor (dB)	Cable Loss (dB)	Preamp Factor (dB)	Ant Pos (cm)	Table Pos (deg)	Remark
2483.5	63.4	-10.6	74	58.88	32.48	6.59	34.55	100	161	Peak
2483.5	38.62	-15.38	54	-	-	-	-	-	-	Average

ANTENNA POLARITY : VERTICAL										
Frequency (MHz)	Level (dBμV/m)	Over Limit (dB)	Limit Line (dBμV/m)	Read Level (dBμV)	Antenna Factor (dB)	Cable Loss (dB)	Preamp Factor (dB)	Ant Pos (cm)	Table Pos (deg)	Remark
2483.53	60.12	-13.88	74	55.6	32.48	6.59	34.55	198	284	Peak
2483.53	35.34	-18.66	54	-	-	-	-	-	-	Average

3.8.8 Test Result of Radiated Emission (30 MHz ~ 10th Harmonic)

Note: Below 1GHz for radiated emission measurement, pre-scanned all test modes and only choose the worst case mode was recorded in the report.

Test Mode :	3Mbps	Temperature :	23~24°C
Test Channel :	00	Relative Humidity :	42~43%
Test Engineer :	Marlboro Wang	Polarization :	Horizontal
Remark :	<ol style="list-style-type: none"> 2402 MHz is fundamental signal which can be ignored. 7206 MHz is not within a restricted band, and its limit line is 20dB below the highest emission level. For example, 106.24dBuV/m - 20dB = 86.24 dBuV/m. Average measurement was not performed if peak level went lower than the average limit. 		

Frequency (MHz)	Level (dBμV/m)	Over Limit (dB)	Limit Line (dBμV/m)	Read Level (dBμV)	Antenna Factor (dB)	Cable Loss (dB)	Preamp Factor (dB)	Ant Pos (cm)	Table Pos (deg)	Remark
2402	106.24	-	-	101.99	32.36	6.45	34.56	106	108	Peak
2402	81.46	-	-	-	-	-	-	-	-	Average
4803	48.42	-25.58	74	58.94	34.88	10.16	55.56	100	0	Peak
4803	23.64	-30.36	54	-	-	-	-	-	-	Average
7206	48.81	-37.43	86.24	58.17	36.16	10.97	56.49	100	0	Peak

Note: Other harmonics are lower than background noise.



Test Mode :	3Mbps	Temperature :	23~24°C
Test Channel :	00	Relative Humidity :	42~43%
Test Engineer :	Marlboro Wang	Polarization :	Vertical
Remark :	1. 2402 MHz is fundamental signal which can be ignored. 2. 7206 MHz is not within a restricted band, and its limit line is 20dB below the highest emission level. 3. Average measurement was not performed if peak level went lower than the average limit.		

Frequency (MHz)	Level (dBμV/m)	Over Limit (dB)	Limit Line (dBμV/m)	Read Level (dBμV)	Antenna Factor (dB)	Cable Loss (dB)	Preamp Factor (dB)	Ant Pos (cm)	Table Pos (deg)	Remark
2402	102.33	-	-	98.08	32.36	6.45	34.56	142	270	Peak
2402	77.55	-	-	-	-	-	-	-	-	Average
4803	47.88	-26.12	74	58.4	34.88	10.16	55.56	100	0	Peak
4803	23.1	-30.9	54	-	-	-	-	-	-	Average
7206	49.06	-33.27	82.33	58.42	36.16	10.97	56.49	100	0	Peak

Note: Other harmonics are lower than background noise.



Test Mode :	3Mbps	Temperature :	23~24°C
Test Channel :	39	Relative Humidity :	42~43%
Test Engineer :	Marlboro Wang	Polarization :	Horizontal
Remark :	1. 2442 MHz is fundamental signal which can be ignored. 2. Average measurement was not performed if peak level went lower than the average limit.		

Frequency (MHz)	Level (dBμV/m)	Over Limit (dB)	Limit Line (dBμV/m)	Read Level (dBμV)	Antenna Factor (dB)	Cable Loss (dB)	Preamp Factor (dB)	Ant Pos (cm)	Table Pos (deg)	Remark
2442	106.01	-	-	101.62	32.43	6.52	34.56	100	109	Peak
2442	81.23	-	-	-	-	-	-	-	-	Average
4881	48.12	-25.88	74	58.76	34.85	10.19	55.68	100	0	Peak
4881	23.34	-30.66	54	-	-	-	-	-	-	Average
7323	49.36	-24.64	74	58.53	36.13	10.94	56.24	100	0	Peak
7323	24.58	-29.42	54	-	-	-	-	-	-	Average

Note: Other harmonics are lower than background noise.

Test Mode :	3Mbps	Temperature :	23~24°C
Test Channel :	39	Relative Humidity :	42~43%
Test Engineer :	Marlboro Wang	Polarization :	Vertical
Remark :	1. 2442 MHz is fundamental signal which can be ignored. 2. Average measurement was not performed if peak level went lower than the average limit.		

Frequency (MHz)	Level (dBμV/m)	Over Limit (dB)	Limit Line (dBμV/m)	Read Level (dBμV)	Antenna Factor (dB)	Cable Loss (dB)	Preamp Factor (dB)	Ant Pos (cm)	Table Pos (deg)	Remark
2442	104.33	-	-	99.94	32.43	6.52	34.56	197	287	Peak
2442	79.55	-	-	-	-	-	-	-	-	Average
4881	48.42	-25.58	74	59.06	34.85	10.19	55.68	100	0	Peak
4881	23.64	-30.36	54	-	-	-	-	-	-	Average
7323	48.66	-25.34	74	57.83	36.13	10.94	56.24	100	0	Peak
7323	23.88	-30.12	54	-	-	-	-	-	-	Average

Note: Other harmonics are lower than background noise.



Test Mode :	3Mbps	Temperature :	23~24°C
Test Channel :	78	Relative Humidity :	42~43%
Test Engineer :	Marlboro Wang	Polarization :	Horizontal
Remark :	1. 2480 MHz is fundamental signal which can be ignored. 2. Average measurement was not performed if peak level went lower than the average limit.		

Frequency (MHz)	Level (dBμV/m)	Over Limit (dB)	Limit Line (dBμV/m)	Read Level (dBμV)	Antenna Factor (dB)	Cable Loss (dB)	Preamp Factor (dB)	Ant Pos (cm)	Table Pos (deg)	Remark
102.09	34.64	-8.86	43.5	53.86	11.36	1.11	31.69	-	-	Peak
165.54	36.23	-7.27	43.5	56.43	9.94	1.52	31.66	-	-	Peak
249.51	42.8	-3.2	46	60.42	12.3	1.73	31.65	100	141	Peak
300	35.97	-10.03	46	52.54	13.2	1.9	31.67	-	-	Peak
360.2	34.22	-11.78	46	49.09	14.6	2.09	31.56	-	-	Peak
561.1	26.53	-19.47	46	37	18.88	2.59	31.94	-	-	Peak
2480	106.94	-	-	102.42	32.48	6.59	34.55	100	161	Peak
2480	82.16	-	-	-	-	-	-	-	-	Average
4959	48.43	-25.57	74	59.25	34.81	10.21	55.84	100	0	Peak
4959	23.65	-30.35	54	-	-	-	-	-	-	Average
7440	49.95	-24.05	74	58.94	36.11	10.9	56	100	0	Peak
7440	25.17	-28.83	54	-	-	-	-	-	-	Average

Note: Other harmonics are lower than background noise.



Test Mode :	3Mbps	Temperature :	23~24°C
Test Channel :	78	Relative Humidity :	42~43%
Test Engineer :	Marlboro Wang	Polarization :	Vertical
Remark :	1. 2480 MHz is fundamental signal which can be ignored. 2. Average measurement was not performed if peak level went lower than the average limit.		

Frequency (MHz)	Level (dBμV/m)	Over Limit (dB)	Limit Line (dBμV/m)	Read Level (dBμV)	Antenna Factor (dB)	Cable Loss (dB)	Preamp Factor (dB)	Ant Pos (cm)	Table Pos (deg)	Remark
43.77	36.83	-3.17	40	57.44	10.38	0.71	31.7	100	77	Peak
102.09	30.99	-12.51	43.5	50.21	11.36	1.11	31.69	-	-	Peak
163.38	27.64	-15.86	43.5	47.8	9.98	1.52	31.66	-	-	Peak
302.1	29.33	-16.67	46	45.8	13.28	1.91	31.66	-	-	Peak
356.7	28.67	-17.33	46	43.64	14.51	2.08	31.56	-	-	Peak
556.2	25.49	-20.51	46	35.73	19.1	2.57	31.91	-	-	Peak
2480	103.45	-	-	98.93	32.48	6.59	34.55	198	284	Peak
2480	78.67	-	-	-	-	-	-	-	-	Average
4959	48.04	-25.96	74	58.86	34.81	10.21	55.84	100	0	Peak
4959	23.26	-30.74	54	-	-	-	-	-	-	Average
7440	49.44	-24.56	74	58.43	36.11	10.9	56	100	0	Peak
7440	24.66	-29.34	54	-	-	-	-	-	-	Average

Note: Other harmonics are lower than background noise.

3.9 AC Conducted Emission Measurement

3.9.1 Limit of AC Conducted Emission

For equipment that is designed to be connected to the public utility (AC) power line, the radio frequency voltage that is conducted back onto the AC power line on any frequency or frequencies within the band 150 kHz to 30 MHz shall not exceed the limits in the following table.

Frequency of emission (MHz)	Conducted limit (dBuV)	
	Quasi-peak	Average
0.15-0.5	66 to 56*	56 to 46*
0.5-5	56	46
5-30	60	50

*Decreases with the logarithm of the frequency.

3.9.2 Measuring Instruments

See list of measuring instruments of this test report.

3.9.3 Test Procedures

1. The test follows the guidelines in ANSI C63.10-2009 test site requirement.
2. The EUT was placed 0.4 meter from the conducting wall of the shielding room was kept at least 80 centimeters from any other grounded conducting surface.
3. Connect EUT to the power mains through a line impedance stabilization network (LISN).
4. All the support units are connecting to the other LISN.
5. The LISN provides 50 ohm coupling impedance for the measuring instrument.
6. The FCC states that a 50 ohm, 50 microhenry LISN should be used.
7. Both sides of AC line were checked for maximum conducted interference.
8. The frequency range from 150 kHz to 30 MHz was searched.
9. Set the test-receiver system to Peak Detect Function and specified bandwidth with Maximum Hold Mode.

3.9.4 Test Setup

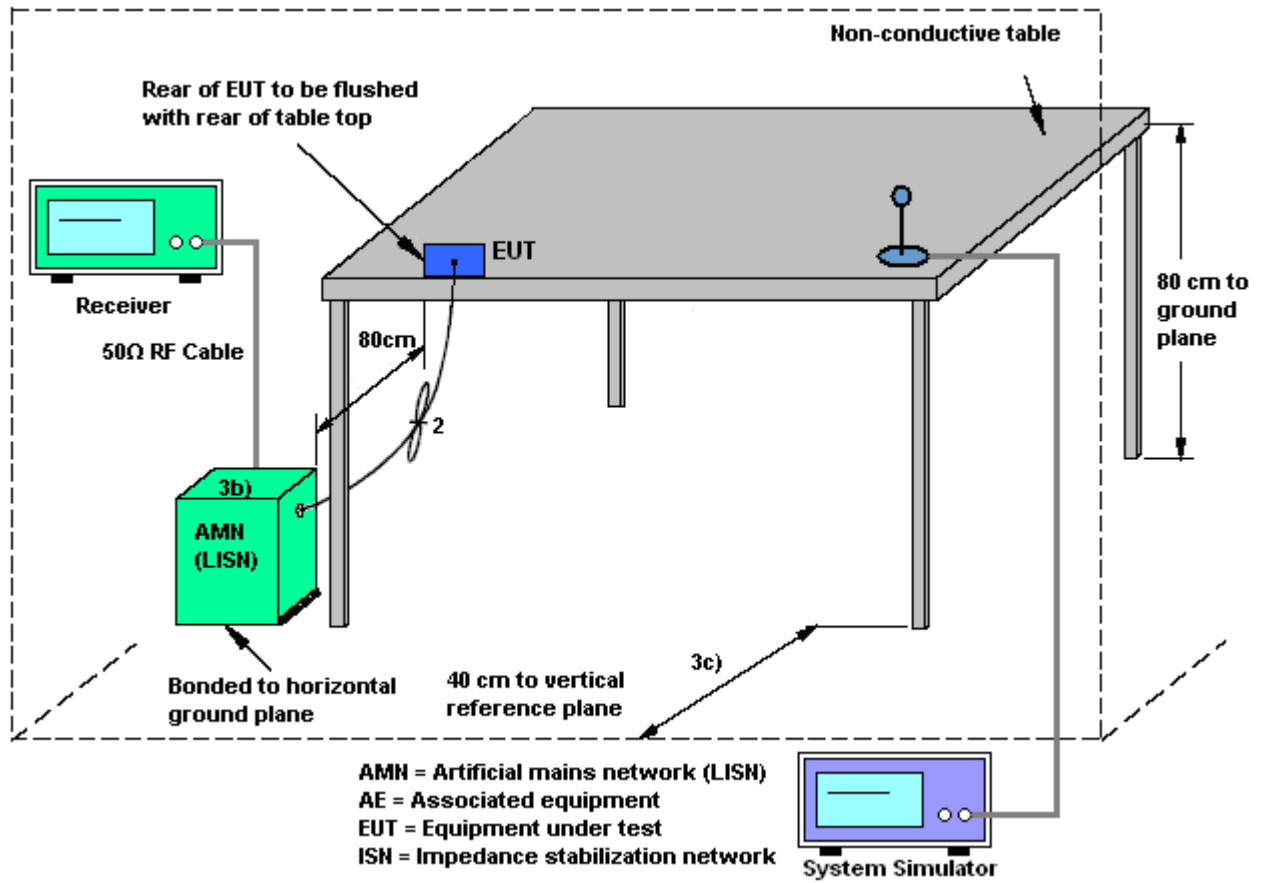



3.9.5 Test Result of AC Conducted Emission

Test Mode :	Mode 1	Temperature :	19~20°C
Test Engineer :	Tom Wang	Relative Humidity :	39~40%
Test Voltage :	120Vac / 60Hz	Phase :	Line
Function Type :	GSM850 Idle + Bluetooth Link + WLAN Link + USB Cable 1 (Charging from Adapter) + Battery + Earphone		

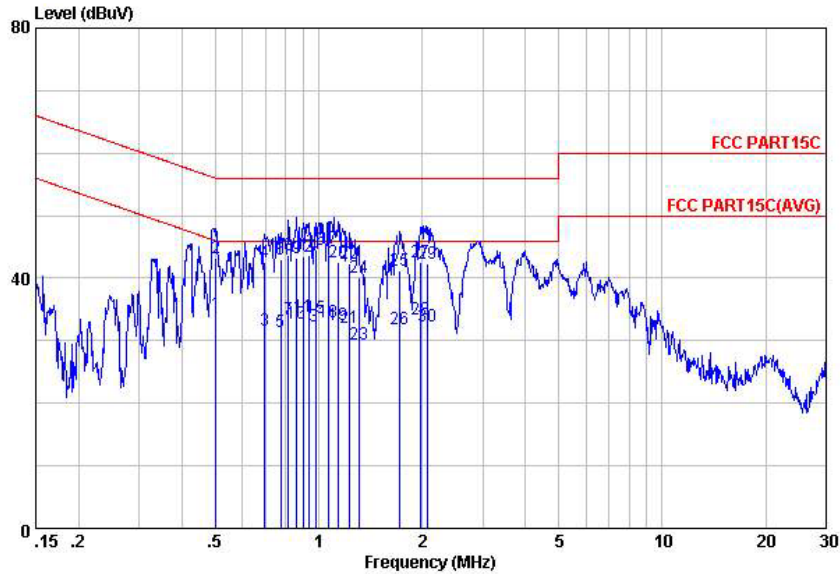

Site : C001-KS
 Condition: FCC PART15C LISN-L20130306 LINE

	Freq	Level	Over	Limit	Read	LISN	Cable	Remark
	MHz	dBuV	Limit	Line	Level	Factor	Loss	
			dB	dBuV	dBuV	dB	dB	
1	0.50	34.35	-11.65	46.00	23.90	0.20	10.25	Average
2	0.50	43.25	-12.75	56.00	32.80	0.20	10.25	QP
3	0.70	31.67	-14.33	46.00	21.20	0.20	10.27	Average
4	0.70	42.67	-13.33	56.00	32.20	0.20	10.27	QP
5	0.78	31.45	-14.55	46.00	21.00	0.18	10.27	Average
6	0.78	43.05	-12.95	56.00	32.60	0.18	10.27	QP
7	0.82	33.44	-12.56	46.00	23.00	0.16	10.28	Average
8	0.82	43.74	-12.26	56.00	33.30	0.16	10.28	QP
9	0.86	43.31	-12.69	56.00	32.89	0.14	10.28	QP
10	0.86	32.81	-13.19	46.00	22.39	0.14	10.28	Average
11	0.90	33.80	-12.20	46.00	23.40	0.12	10.28	Average
12	0.90	43.50	-12.50	56.00	33.10	0.12	10.28	QP
13	0.93	32.29	-13.71	46.00	21.90	0.11	10.28	Average
14	0.93	43.69	-12.31	56.00	33.30	0.11	10.28	QP
15	0.98	33.58	-12.42	46.00	23.20	0.10	10.28	Average
16	0.98	44.58	-11.42	56.00	34.20	0.10	10.28	QP
17	1.07	44.68	-11.32	56.00	34.30	0.10	10.28	QP
18	1.07	33.08	-12.92	46.00	22.70	0.10	10.28	Average
19	1.14	32.48	-13.52	46.00	22.10	0.10	10.28	Average
20	1.14	42.48	-13.52	56.00	32.10	0.10	10.28	QP
21	1.23	32.18	-13.82	46.00	21.80	0.10	10.28	Average
22	1.23	42.38	-13.62	56.00	32.00	0.10	10.28	QP
23	1.31	29.39	-16.61	46.00	19.00	0.10	10.29	Average
24	1.31	40.09	-15.91	56.00	29.70	0.10	10.29	QP
25	1.73	41.30	-14.70	56.00	30.90	0.10	10.30	QP
26	1.73	31.80	-14.20	46.00	21.40	0.10	10.30	Average
27	1.97	42.50	-13.50	56.00	32.10	0.10	10.30	QP
28	1.97	33.50	-12.50	46.00	23.10	0.10	10.30	Average
29	2.07	42.40	-13.60	56.00	32.00	0.10	10.30	QP
30	2.07	32.40	-13.60	46.00	22.00	0.10	10.30	Average



Test Mode :	Mode 1	Temperature :	19~20°C
Test Engineer :	Tom Wang	Relative Humidity :	39~40%
Test Voltage :	120Vac / 60Hz	Phase :	Neutral
Function Type :	GSM850 Idle + Bluetooth Link + WLAN Link + USB Cable 1 (Charging from Adapter) + Battery + Earphone		

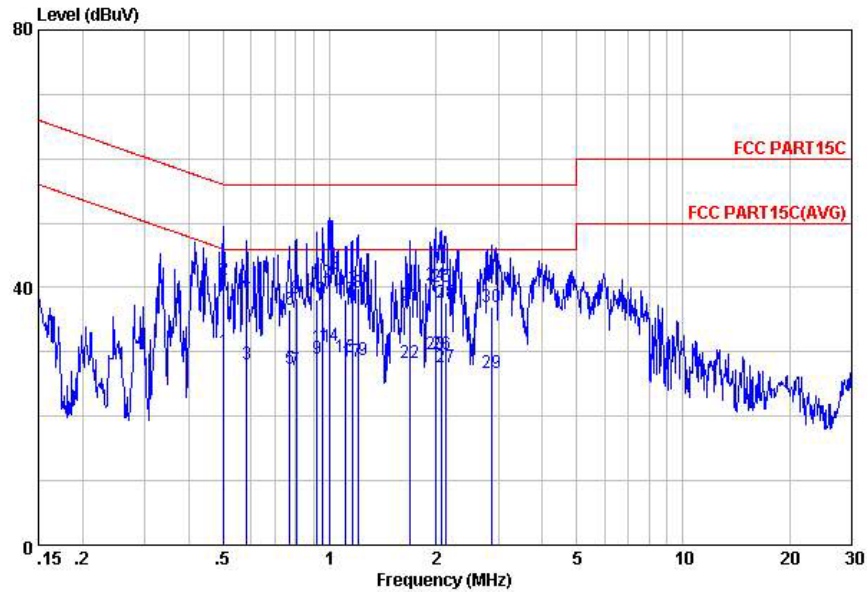

Site : C001-KS
 Condition: FCC PART15C LISN-N20130306 NEUTRAL

	Freq	Level	Over	Limit	Read	LISN	Cable	Remark
	MHz	dBuV	Limit	Line	Level	Factor	Loss	
			dB	dBuV	dBuV	dB	dB	
1	0.50	30.15	-15.85	46.00	19.60	0.30	10.25	Average
2	0.50	41.15	-14.85	56.00	30.60	0.30	10.25	QP
3	0.58	28.02	-17.98	46.00	17.50	0.26	10.26	Average
4	0.58	39.42	-16.58	56.00	28.90	0.26	10.26	QP
5	0.77	27.45	-18.55	46.00	17.00	0.18	10.27	Average
6	0.77	36.65	-19.35	56.00	26.20	0.18	10.27	QP
7	0.80	27.24	-18.76	46.00	16.79	0.17	10.28	Average
8	0.80	38.34	-17.66	56.00	27.89	0.17	10.28	QP
9	0.92	28.90	-17.10	46.00	18.50	0.12	10.28	Average
10	0.92	38.20	-17.80	56.00	27.80	0.12	10.28	QP
11	0.95	30.79	-15.21	46.00	20.40	0.11	10.28	Average
12	0.95	40.69	-15.31	56.00	30.30	0.11	10.28	QP
13	1.00	42.08	-13.92	56.00	31.70	0.10	10.28	QP
14	1.00	30.88	-15.12	46.00	20.50	0.10	10.28	Average
15	1.11	29.08	-16.92	46.00	18.70	0.10	10.28	Average
16	1.11	38.18	-17.82	56.00	27.80	0.10	10.28	QP
17	1.16	28.48	-17.52	46.00	18.10	0.10	10.28	Average
18	1.16	39.18	-16.82	56.00	28.80	0.10	10.28	QP
19	1.21	28.78	-17.22	46.00	18.40	0.10	10.28	Average
20	1.21	39.88	-16.12	56.00	29.50	0.10	10.28	QP
21	1.68	37.30	-18.70	56.00	26.90	0.10	10.30	QP
22	1.68	28.30	-17.70	46.00	17.90	0.10	10.30	Average
23	1.99	29.70	-16.30	46.00	19.30	0.10	10.30	Average
24	1.99	40.30	-15.70	56.00	29.90	0.10	10.30	QP
25	2.08	40.10	-15.90	56.00	29.70	0.10	10.30	QP
26	2.08	29.60	-16.40	46.00	19.20	0.10	10.30	Average
27	2.13	27.71	-18.29	46.00	17.31	0.10	10.30	Average
28	2.13	37.61	-18.39	56.00	27.21	0.10	10.30	QP
29	2.87	26.65	-19.35	46.00	16.20	0.13	10.32	Average
30	2.87	37.05	-18.95	56.00	26.60	0.13	10.32	QP



3.10 Antenna Requirements

3.10.1 Standard Applicable

If directional gain of transmitting antennas is greater than 6dBi, the power shall be reduced by the same level in dB comparing to gain minus 6dBi. The use of a permanently attached antenna or of an antenna that uses a unique coupling to the intentional radiator shall be considered sufficient to comply with the FCC rule.

3.10.2 Antenna Connected Construction

Non-standard connector used.

3.10.3 Antenna Gain

The antenna peak gain of EUT is less than 6 dBi. Therefore, it is not necessary to reduce maximum peak output power limit.



4 List of Measuring Equipment

Instrument	Manufacturer	Model No.	Serial No.	Characteristics	Calibration Date	Test Date	Due Date	Remark
Spectrum Analyzer	R&S	FSP40	100319	9kHz~40GHz	Dec. 29, 2012	Mar. 11, 2013~ Mar. 16, 2013	Dec. 28, 2013	Conducted (TH01-KS)
Power Meter	Agilent	E4416A	MY45101555	N/A	Aug. 22, 2012	Mar. 11, 2013~ Mar. 16, 2013	Aug. 21, 2013	Conducted (TH01-KS)
Power Sensor	Agilent	E9327A	MY44421198	N/A	Aug. 22, 2012	Mar. 11, 2013~ Mar. 16, 2013	Aug. 21, 2013	Conducted (TH01-KS)
Spectrum Analyzer	R&S	FSP30	101352	9kHz~30GHz	Nov. 07, 2012	Mar. 16, 2013~ Mar. 17, 2013	Nov. 06, 2013	Radiation (03CH06-HY)
EMI Test Receiver	R&S	ESVS10	834468/0003	20MHz~1000M Hz	May 04, 2012	Mar. 16, 2013~ Mar. 17, 2013	May 03, 2013	Radiation (03CH06-HY)
Bilog Antenna	SCHAFFNER	CBL6112B	2885	30MHz~2GHz	Oct. 06, 2012	Mar. 16, 2013~ Mar. 17, 2013	Oct. 05, 2013	Radiation (03CH06-HY)
Double Ridge Horn Antenna	COM-POWER	AH-118	071025	1GHz~18GHz	Aug. 09, 2012	Mar. 16, 2013~ Mar. 17, 2013	Aug. 08, 2013	Radiation (03CH06-HY)
SHF-EHF Horn Antenna	SCHWARZBEC K	BBHA 9170	BBHA9170251	15GHz ~ 40GHz	Sep. 28, 2012	Mar. 16, 2013~ Mar. 17, 2013	Sep. 27, 2013	Radiation (03CH06-HY)
Preamplifier	Agilent	8449B	3008A01917	1GHz~26.5GHz	Apr. 13, 2012	Mar. 16, 2013~ Mar. 17, 2013	Apr. 12, 2013	Radiation (03CH06-HY)
Amplifier	Agilent	310N	186713	9kHz~1GHz	Apr. 11, 2012	Mar. 16, 2013~ Mar. 17, 2013	Apr. 10, 2013	Radiation (03CH06-HY)
Pre Amplifier	MITEQ	AMF-7D-0010 1800-30-10P	159087	1GHz~18GHz	Feb. 26, 2013	Mar. 16, 2013~ Mar. 17, 2013	Feb. 25, 2014	Radiation (03CH06-HY)
Loop Antenna	R&S	HFH2-Z2	860004/001	9kHz~30MHz	Jul. 03, 2012	Mar. 16, 2013~ Mar. 17, 2013	Jul. 02, 2013	Radiation (03CH06-HY)
Turn Table	chaintek	T-200-S	420/650/00	0~360 degree	N/A	Mar. 16, 2013~ Mar. 17, 2013	N/A	Radiation (03CH06-HY)
Antenna Mast	chaintek	M-400-0	114/8000604/L	1 m~4 m	N/A	Mar. 16, 2013~ Mar. 17, 2013	N/A	Radiation (03CH06-HY)
EMI Receiver	R&S	ESC17	100768	9kHz~7GHz	Jun. 01, 2012	Mar. 15, 2013	May 31, 2013	Conduction (CO01-KS)
LISN (for auxiliary equipment)	MessTec	AN3016	60103	9kHz~30MHz	Dec. 29, 2012	Mar. 15, 2013	Dec. 28, 2013	Conduction (CO01-KS)
LISN	MessTec	AN3016	60105	9kHz~30MHz	Dec. 29, 2012	Mar. 15, 2013	Dec. 28, 2013	Conduction (CO01-KS)
AC Power Source	Chroma	61602	ABP000000811	N/A	Nov. 15, 2012	Mar. 15, 2013	Nov. 14, 2013	Conduction (CO01-KS)



5 Uncertainty of Evaluation

Uncertainty of Radiated Emission Measurement (30 MHz ~ 1000 MHz)

Measuring Uncertainty for a Level of Confidence of 95% ($U = 2Uc(y)$)	2.54
---	------

Uncertainty of Radiated Emission Measurement (1 GHz ~ 40 GHz)

Measuring Uncertainty for a Level of Confidence of 95% ($U = 2Uc(y)$)	4.72
---	------

Uncertainty of Conducted Emission Measurement (150 kHz ~ 30 MHz)

Measuring Uncertainty for a Level of Confidence of 95% ($U = 2Uc(y)$)	2.26
---	------



Appendix A. Photographs of EUT

Please refer to Sporton report number EP350204 as below.