



Variant FCC RF Test Report

APPLICANT : Lenovo (Shanghai) Electronics Technology Co., Ltd.
EQUIPMENT : Tablet PC IdeaTab A3000-F
BRAND NAME : lenovo
MODEL NAME : 60029, Z0A2
FCC ID : O57A3000F
STANDARD : FCC Part 15 Subpart C §15.247
CLASSIFICATION : (DSS) Spread Spectrum Transmitter

This is a variant report which is only valid together with the original test report. The product was received on May 13, 2013 and completely tested on May 19, 2013. We, SPORTON INTERNATIONAL (KUNSHAN) INC., would like to declare that the tested sample has been evaluated in accordance with the procedures and shown the compliance with the applicable technical standards.

The test results in this report apply exclusively to the tested model / sample. Without written approval of SPORTON INTERNATIONAL (KUNSHAN) INC., the test report shall not be reproduced except in full.

Reviewed by:

Jones Tsai / Manager



SPORTON INTERNATIONAL (KUNSHAN) INC.
No. 3-2, PingXiang Road, Kunshan, Jiangsu Province, P.R.C.



TABLE OF CONTENTS

REVISION HISTORY..... 3

SUMMARY OF TEST RESULT 4

1 GENERAL DESCRIPTION..... 5

 1.1 Applicant..... 5

 1.2 Manufacturer..... 5

 1.3 Feature of Equipment Under Test..... 5

 1.4 Product Specification of Equipment Under Test..... 5

 1.5 Testing Site..... 6

 1.6 Applied Standards 6

2 TEST CONFIGURATION OF EQUIPMENT UNDER TEST..... 7

 2.1 Descriptions of Test Mode..... 7

 2.2 Test Mode..... 8

 2.3 Connection Diagram of Test System..... 9

 2.4 Support Unit used in test configuration and system..... 9

 2.5 Description of RF Function Operation Test Setup..... 9

 2.6 Measurement Results Explanation Example..... 10

3 TEST RESULT 11

 3.1 Peak Output Power Measurement 11

 3.2 Radiated Band Edges and Spurious Emission Measurement 13

4 LIST OF MEASURING EQUIPMENT..... 22

5 UNCERTAINTY OF EVALUATION..... 23

APPENDIX A. PHOTOGRAPHS OF EUT

APPENDIX B. SETUP PHOTOGRAPHS

APPENDIX C. PRODUCT EQUALITY DECLARATION



SUMMARY OF TEST RESULT

Report Section	FCC Rule	Description	Limit	Result	Remark
3.1	15.247(b)(1)	Peak Output Power	≤ 1 W for 1Mbps ≤ 125 mW for 2, 3Mbps	Pass	-
3.2	15.247(d)	Radiated Band Edges and Radiated Spurious Emission	15.209(a) & 15.247(d)	Pass	Under limit 8.22 dB at 2483.500 MHz

1 General Description

1.1 Applicant

Lenovo (Shanghai) Electronics Technology Co., Ltd.

No. 68 Building, 199 Fenju Road, Wai Gao Qiao FTZ, Shanghai, China

1.2 Manufacturer

Lenovo PC HK Limited

23/F, Lincoln House, Taikoo Place 979 King's Road, Quarry Bay, Hong Kong

1.3 Feature of Equipment Under Test

Product Feature	
Equipment	Tablet PC IdeaTab A3000-F
Brand Name	lenovo
Model Name	60029, Z0A2
FCC ID	O57A3000F
EUT supports Radios application	WLAN 11bgn/Bluetooth EDR/Bluetooth 4.0 - LE
HW Version	LepadA3000-F
SW Version	A3000_130428
EUT Stage	Identical Prototype

Remark: The above EUT's information was declared by manufacturer. Please refer to the specifications or user's manual for more detailed description.

1.4 Product Specification of Equipment Under Test

Product Specification subjective to this standard	
Tx/Rx Frequency Range	2402 MHz ~ 2480 MHz
Number of Channels	79
Carrier Frequency of Each Channel	2402+n*1 MHz; n=0~78
Maximum Output Power to Antenna	Bluetooth BDR (1Mbps) : 6.35 dBm (0.0043 W) Bluetooth EDR (2Mbps) : 6.15 dBm (0.0041 W) Bluetooth EDR (3Mbps) : 6.46 dBm (0.0044 W)
Antenna Type	Fixed Internal Antenna with gain 3.10 dBi
Type of Modulation	Bluetooth BDR (1Mbps) : GFSK Bluetooth EDR (2Mbps) : $\pi/4$ -DQPSK Bluetooth EDR (3Mbps) : 8-DPSK



1.5 Testing Site

Test Site	SPORTON INTERNATIONAL (KUNSHAN) INC.		
Test Site Location	No. 3-2, PingXiang Road, Kunshan, Jiangsu Province, P.R.C. TEL: +86-0512-5790-0158 FAX: +86-0512-5790-0958		
Test Site No.	Sporton Site No.		FCC/IC Registration No.
	TH01-KS	03CH01-KS	149928/4086E-1

The test site complies with ANSI C63.4 2003 requirement.

1.6 Applied Standards

According to the specifications of the manufacturer, the EUT must comply with the requirements of the following standards:

- ♦ FCC Part 15 Subpart C §15.247
- ♦ FCC Public Notice DA 00-705
- ♦ ANSI C63.10-2009

Remark:

1. All test items were verified and recorded according to the standards and without any deviation during the test.
2. This EUT has also been tested and complied with the requirements of FCC Part 15, Subpart B, recorded in a separate test report.

2 Test Configuration of Equipment Under Test

2.1 Descriptions of Test Mode

Preliminary tests were performed in different data rate and recorded the RF output power in the following table:

Channel	Frequency	Bluetooth RF Output Power		
		Data Rate / Modulation		
		GFSK	$\pi/4$ -DQPSK	8-DPSK
		1Mbps	2Mbps	3Mbps
Ch00	2402MHz	5.12 dBm	4.78 dBm	5.13 dBm
Ch39	2441MHz	5.46 dBm	5.26 dBm	5.52 dBm
Ch78	2480MHz	6.35 dBm	6.15 dBm	6.46 dBm

Remark:

1. All the test data for each data rate were verified, but only the worst case was reported.
 2. The data rate was set in 3Mbps for all the test items due to the highest RF output power.
- a. The EUT has been associated with peripherals pursuant to ANSI C63.10-2009 and configuration operated in a manner tended to maximize its emission characteristics in a typical application. Frequency range investigated: conduction (150 KHz to 30 MHz), radiation (9 KHz to the 10th harmonic of the highest fundamental frequency or to 40 GHz, whichever is lower). Pre-scanned tests, X, Y, Z in three orthogonal panels, and different data rates were conducted to determine the final configuration (Z plane as worst plane) from all possible combinations, and the worst mode of radiated spurious emissions is Bluetooth 3Mbps mode, and recorded in this report.

2.2 Test Mode

The following summary table is showing all test modes to demonstrate in compliance with the standard.

Summary table of Test Cases			
Test Item	Data Rate / Modulation		
	Bluetooth BDR 1Mbps GFSK	Bluetooth EDR 2Mbps $\pi/4$ -DQPSK	Bluetooth EDR 3Mbps 8-DPSK
Conducted Test Cases	Mode 1: CH00_2402 MHz	Mode 4: CH00_2402 MHz	Mode 7: CH00_2402 MHz
	Mode 2: CH39_2441 MHz	Mode 5: CH39_2441 MHz	Mode 8: CH39_2441 MHz
	Mode 3: CH78_2480 MHz	Mode 6: CH78_2480 MHz	Mode 9: CH78_2480 MHz
Radiated Test Cases	Bluetooth EDR 3Mbps 8-DPSK		
	Mode 1: CH78_2480 MHz		
<p>Remark: For radiated test cases, the worst mode data rate 3Mbps was reported only, because this data rate has the highest RF output power at preliminary tests, and the conducted spurious emissions and conducted band edge measurement for each data rate are no worse than 3Mbps, and no other significantly frequencies found in conducted spurious emission.</p>			

2.3 Connection Diagram of Test System

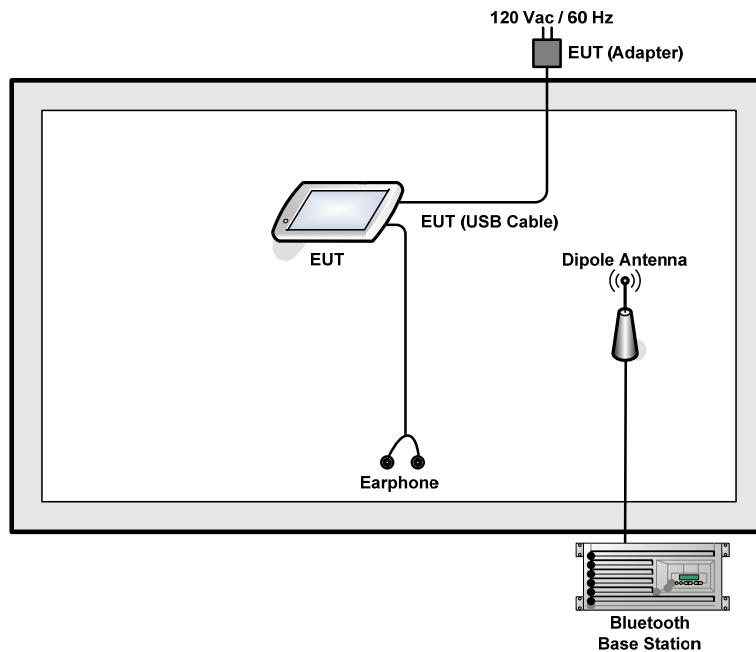

2.4 Support Unit used in test configuration and system

Item	Equipment	Trade Name	Model Name	FCC ID	Data Cable	Power Cord
1.	Bluetooth Base Station	R&S	CBT	FCC DoC	N/A	Unshielded, 1.8 m
2.	DC Power Supply	GWINSTEK	GPS-3030D	N/A	N/A	Unshielded, 1.8 m

2.5 Description of RF Function Operation Test Setup

For Bluetooth function, key in “* # * # 3646633 # * # *” on the EUT directly. Then, the EUT will get into the engineering modes to contact with Bluetooth base station for continuous transmitting and receiving signals.



2.6 Measurement Results Explanation Example

For conducted test items:

The offset level is set in the spectrum analyzer to compensate the RF cable loss and 10dB attenuator between EUT conducted output port and spectrum analyzer. With the offset compensation, the spectrum analyzer reading level is exactly the EUT RF output level.

The spectrum analyzer offset is derived from RF cable loss and 10dB attenuator factor.

$$\text{Offset} = \text{RF cable loss} + \text{attenuator factor}.$$

Following table shows an offset computation example with cable loss 5.6 dB.

Example :

$$\begin{aligned} \text{Offset(dB)} &= \text{RF cable loss(dB)} + \text{attenuator factor(dB)}. \\ &= 5.6 + 10 = 15.6 \text{ (dB)} \end{aligned}$$

For radiated band edges and spurious emission test :

Per part 15.35(c), the EUT Bluetooth average emission level could be determined by the peak emission level applying duty cycle correction factor, to represent averaging over the whole pulse train.

The average level is derived from the peak level corrected with "Duty cycle correction factor".

$$\text{Average Emission Level(dBuV/m)} = \text{Peak Emission Level(dBuV/m)} + \text{Duty cycle correction factor(dB)}$$

$$\text{Duty cycle correction factor(dB)} = 20 * \log(\text{Duty cycle}).$$

Duty cycle = On time / 100 milliseconds

On time = dwell time * hopping number in 100 ms

For example : bluetooth with dwell time 2.9ms and 2 hops in 100 ms, then

$$\text{Duty cycle correction factor(dB)} = 20 * \log((2.9 * 2) / 100) = -24.73 \text{ dB}$$

Following shows an average computation example with duty cycle correction factor = -24.73dB, and the peak emission level is 45.61 dBuV/m.

Example :

$$\begin{aligned} \text{Average Emission Level(dBuV/m)} &= \text{Peak Emission Level(dBuV/m)} + \text{duty cycle correction factor(dB)} \\ &= 45.61 + (-24.73) = 20.88 \text{ (dBuV/m)} \end{aligned}$$

3 Test Result

3.1 Peak Output Power Measurement

3.1.1 Limit of Peak Output Power

Section 15.247 (b) The maximum peak conducted output power of the intentional radiator shall not exceed the following: (1) For frequency hopping systems operating in the 2400-2483.5 MHz band employing at least 75 non-overlapping hopping channels, and all frequency hopping systems in the 5725-5850 MHz band: 1 watt. For all other frequency hopping systems in the 2400-2483.5 MHz band 0.125 watts. The power limit for 1Mbps is 1watt, and for 2Mbps, and 3Mbps are 0.125 watts.

3.1.2 Measuring Instruments

See list of measuring instruments of this test report.

3.1.3 Test Procedures

1. The testing follows FCC Public Notice DA 00-705 Measurement Guidelines.
2. The RF output of EUT was connected to the power meter by RF cable and attenuator. The path loss was compensated to the results for each measurement.
3. Set to the maximum power setting and enable the EUT transmit continuously.
4. Measure the conducted output power with cable loss and record the results in the test report.
5. Measure and record the results in the test report.

3.1.4 Test Setup

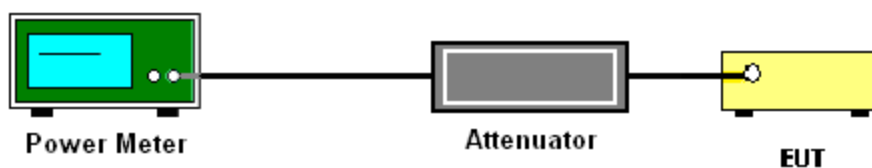



3.1.5 Test Result of Peak Output Power

Test Mode :	3Mbps	Temperature :	23~24°C
Test Engineer :	Lizy Li	Relative Humidity :	47~48%

Channel	Frequency (MHz)	RF Power (dBm)		
		8-DPSK	Max. Limits (dBm)	Pass/Fail
		3 Mbps		
00	2402	6.61	20.97	Pass
39	2441	6.01	20.97	Pass
78	2480	6.18	20.97	Pass



3.2 Radiated Band Edges and Spurious Emission Measurement

3.2.1 Limit of Radiated Band Edges and Spurious Emission

In any 100 KHz bandwidth outside the intentional radiator frequency band, all harmonics/spurious must be at least 20 dB below the highest emission level within the authorized band. In addition, radiated emissions which fall in the restricted bands must also comply with the FCC section 15.209 limits as below.

Frequency (MHz)	Field Strength (microvolts/meter)	Measurement Distance (meters)
0.009 – 0.490	2400/F(KHz)	300
0.490 – 1.705	24000/F(KHz)	30
1.705 – 30.0	30	30
30 – 88	100	3
88 – 216	150	3
216 - 960	200	3
Above 960	500	3

3.2.2 Measuring Instruments

See list of measuring instruments of this test report.



3.2.3 Test Procedures

1. The testing follows the guidelines in Spurious Radiated Emissions of FCC Public Notice DA 00-705 Measurement Guidelines and fulfills ANSI C63.4-2003 and the guidelines in ANSI C63.10-2009 test site requirement.
2. The EUT was placed on a turntable with 0.8 meter above ground.
3. The EUT was set 3 meters from the interference receiving antenna, which was mounted on the top of a variable height antenna tower.
4. For each suspected emission, the EUT was arranged to its worst case and then tune the Antenna tower (from 1 m to 4 m) and turntable (from 0 degree to 360 degrees) to find the maximum reading. A pre-amp and a high pass filter are used for the test in order to get better signal level to comply with the guidelines.
5. Set to the maximum power setting and enable the EUT transmit continuously.
6. For measurement below 1GHz, If the emission level of the EUT measured by the peak detector is 3 dB lower than the applicable limit, the peak emission level will be reported. Otherwise, the emission measurement will be repeated using the quasi-peak detector and reported
7. Use the following spectrum analyzer settings:
 - (1) Span shall wide enough to fully capture the emission being measured;
 - (2) Set RBW=100 KHz for $f < 1$ GHz, RBW=1MHz for $f > 1$ GHz ; VBW \geq RBW; Sweep = auto; Detector function = peak; Trace = max hold for peak
 - (3) For average measurement: use duty cycle correction factor method per 15.35(c).
Duty cycle = On time/100 milliseconds
On time = $N_1 * L_1 + N_2 * L_2 + \dots + N_{n-1} * L_{n-1} + N_n * L_n$
Where N_1 is number of type 1 pulses, L_1 is length of type 1 pulses, etc.
Average Level = Peak Level + $20 * \log(\text{Duty cycle})$
8. Corrected Reading: Antenna Factor + Cable Loss + Read Level - Preamp Factor = Level

Note: The average levels were calculated from the peak level corrected with duty cycle correction factor (24.79dB) derived from $20 \log(\text{dwell time}/100\text{ms})$.



Marker-Delta method in DA 00-705 :

- (1) Fundamental Peak Level : Set RBW = 1 MHz , VBW = 1 MHz , peak detector ;
Average Level = Peak Level + 20*log(Duty cycle)
- (2) Set span = 10MHz, that encompasses both the peak of the fundamental emission and the band-edge emission under investigation. Set RBW = 100KHz, 1% of the total span . Set VBW = 100KHz >= RBW.
- (3) Subtract the delta measured in step (2) from the field strengths measured in step (1).
The resultant field strengths (peak/average) are then used to determine band-edge compliance as required by Section 15.205.

3.2.4 Test Setup

For radiated emissions below 30MHz

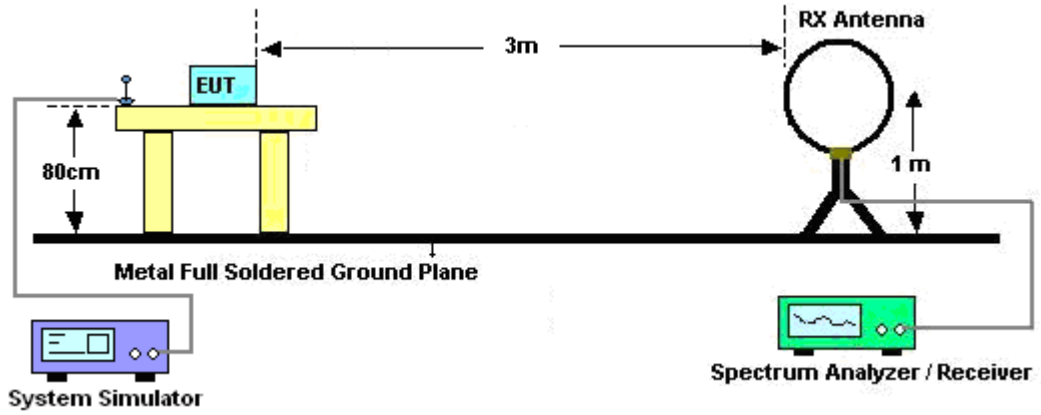

For radiated emissions from 30MHz to 1GHz

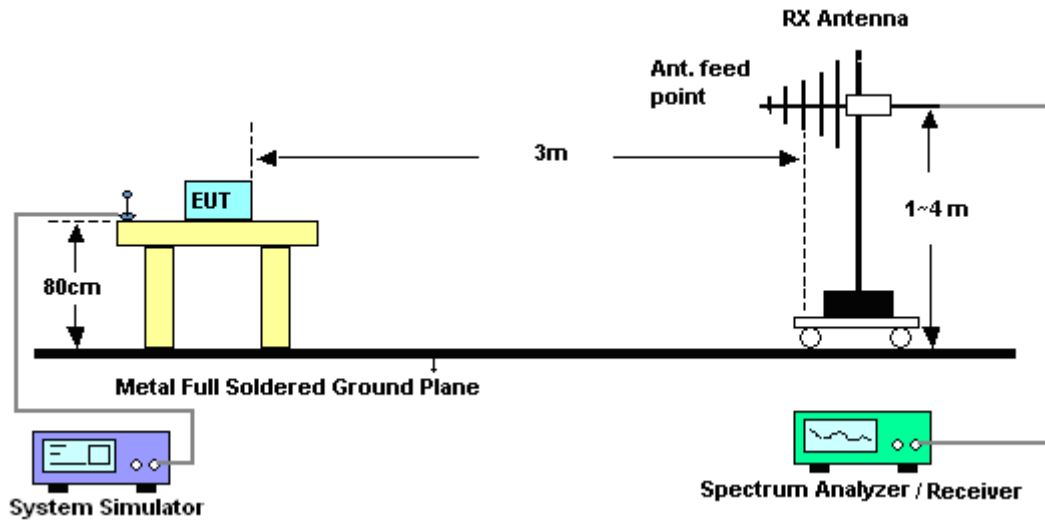

For radiated emissions above 1GHz

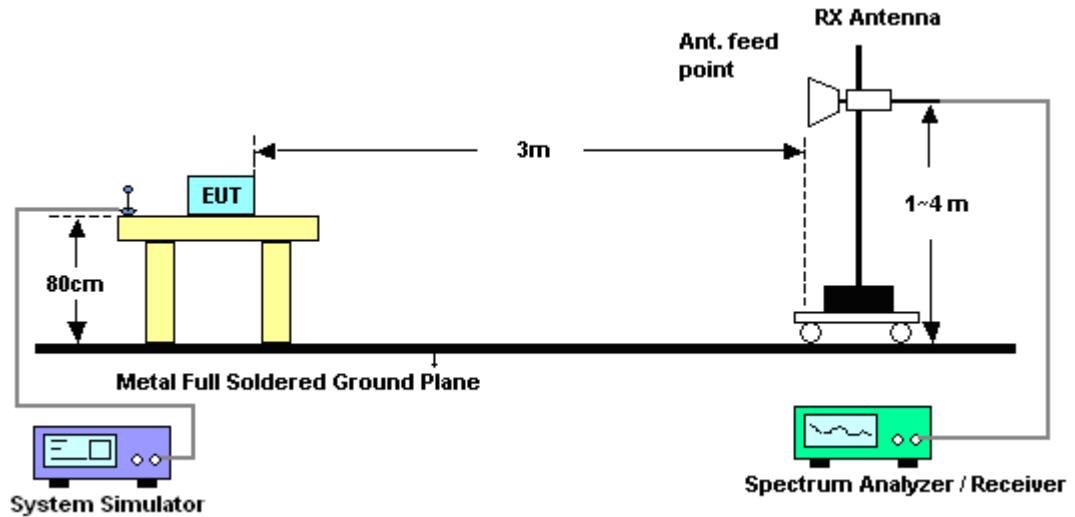

3.2.5 Test Results of Radiated Spurious Emission (9 KHz ~ 30 MHz)

The low frequency, which started from 9 KHz to 30MHz, was pre-scanned and the result which was 20dB lower than the limit line per 15.31(o) was not reported.

3.2.6 Duty cycle correction factor for average measurement

3DH5 on time/100ms (One Pulse) Plot on Channel 39

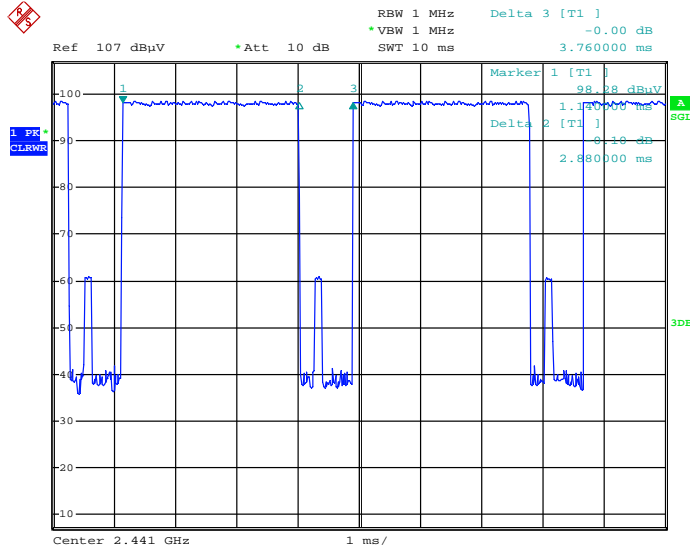

Date: 19.MAY.2013 02:23:51

3DH5 on time/100ms (Count Pulses) Plot on Channel 39

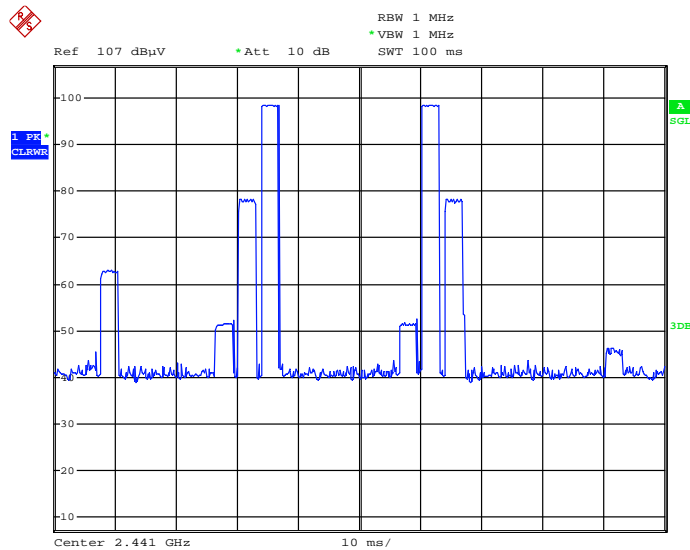

Date: 19.MAY.2013 02:26:57

Note:

1. Duty cycle = on time/100 milliseconds = 2 * 2.88 / 100 = 5.76 %
2. Duty cycle correction factor = 20*log(Duty cycle) = -24.79 dB
3. 3DH5 has the highest duty cycle and is reported.



3.2.7 Test Result of Radiated Band Edges

Test Mode :	3Mbps	Temperature :	22~23°C
Test Channel :	78	Relative Humidity :	41~42%
		Test Engineer :	Steven Hao

ANTENNA POLARITY : HORIZONTAL										
Frequency (MHz)	Level (dBμV/m)	Over Limit (dB)	Limit Line (dBμV/m)	Read Level (dBμV)	Antenna Factor (dB)	Cable Loss (dB)	Preamp Factor (dB)	Ant Pos (cm)	Table Pos (deg)	Remark
2483.5	65.78	-8.22	74	61.32	33.01	2.96	31.51	145	131	Peak
2483.5	40.99	-13.01	54	-	-	-	-	-	-	Average

ANTENNA POLARITY : VERTICAL										
Frequency (MHz)	Level (dBμV/m)	Over Limit (dB)	Limit Line (dBμV/m)	Read Level (dBμV)	Antenna Factor (dB)	Cable Loss (dB)	Preamp Factor (dB)	Ant Pos (cm)	Table Pos (deg)	Remark
2483.5	63.2	-10.8	74	58.74	33.01	2.96	31.51	147	106	Peak
2483.5	38.41	-15.59	54	-	-	-	-	-	-	Average

Note: The average levels were calculated from the peak level corrected with duty cycle correction factor (24.79dB) derived from 20log (dwell time/100ms).

For example: Average level = 65.78dBuV/m – 24.79 (dB) = 40.99dBuV/m.



3.2.8 Test Result of Radiated Spurious Emission (30 MHz ~ 10th Harmonic)

Note: Below 1GHz for radiated emission measurement, pre-scanned all test modes and only choose the worst case mode was recorded in the report.

Test Mode :	3Mbps	Temperature :	22~23°C
Test Channel :	78	Relative Humidity :	41~42%
Test Engineer :	Steven Hao	Polarization :	Horizontal
Remark :	1. 2480 MHz is fundamental signal which can be ignored. 2. Average measurement was not performed if peak level went lower than the average limit.		

Frequency (MHz)	Level (dBμV/m)	Over Limit (dB)	Limit Line (dBμV/m)	Read Level (dBμV)	Antenna Factor (dB)	Cable Loss (dB)	Preamp Factor (dB)	Ant Pos (cm)	Table Pos (deg)	Remark
30	19.85	-20.15	40	35.08	18	0.34	33.57	-	-	Peak
101.78	26.29	-17.21	43.5	48.58	10.74	0.58	33.61	-	-	Peak
166.77	29.7	-13.8	43.5	53.21	9.31	0.75	33.57	100	126	Peak
251.16	29.75	-16.25	46	50.26	12.01	0.92	33.44	-	-	Peak
359.8	31.4	-14.6	46	48.92	14.72	1.11	33.35	-	-	Peak
561.56	27.25	-18.75	46	40.39	18.52	1.34	33	-	-	Peak
2480	105.42	-	-	100.96	33.01	2.96	31.51	145	131	Peak
2480	80.63	-	-	-	-	-	-	-	-	Average
4960	49.15	-24.85	74	41.17	35.2	4.29	31.51	100	126	Peak
7440	52.38	-21.62	74	41.46	36.27	5.57	30.92	112	167	Peak
7440	27.59	-26.41	54	-	-	-	-	-	-	Average

Note: Other harmonics are lower than background noise.



Test Mode :	3Mbps	Temperature :	22~23°C
Test Channel :	78	Relative Humidity :	41~42%
Test Engineer :	Steven Hao	Polarization :	Vertical
Remark :	1. 2480 MHz is fundamental signal which can be ignored. 2. Average measurement was not performed if peak level went lower than the average limit.		

Frequency (MHz)	Level (dBμV/m)	Over Limit (dB)	Limit Line (dBμV/m)	Read Level (dBμV)	Antenna Factor (dB)	Cable Loss (dB)	Preamp Factor (dB)	Ant Pos (cm)	Table Pos (deg)	Remark
30	20.33	-19.67	40	35.56	18	0.34	33.57	-	-	Peak
101.78	21.42	-22.08	43.5	43.71	10.74	0.58	33.61	-	-	Peak
225.94	23.52	-22.48	46	45.56	10.59	0.87	33.5	-	-	Peak
250.19	26.62	-19.38	46	47.14	12	0.92	33.44	-	-	Peak
357.86	23.88	-22.12	46	41.45	14.67	1.11	33.35	-	-	Peak
561.56	26.68	-19.32	46	39.82	18.52	1.34	33	100	19	Peak
2480	102.31	-	-	97.85	33.01	2.96	31.51	147	105	Peak
2480	77.52	-	-	-	-	-	-	-	-	Average
4960	47.41	-26.59	74	39.43	35.2	4.29	31.51	120	236	Peak
7440	52.53	-21.47	74	41.61	36.27	5.57	30.92	120	65	Peak
7440	27.74	-26.26	54	-	-	-	-	-	-	Average

Note: Other harmonics are lower than background noise.



4 List of Measuring Equipment

Instrument	Manufacturer	Model No.	Serial No.	Characteristics	Calibration Date	Test Date	Due Date	Remark
Spectrum Analyzer	R&S	FSP40	100319	9kHz~40GHz	Dec. 29, 2012	May 16, 2013	Dec. 28, 2013	Conducted (TH01-KS)
Power Meter	Agilent	E4416A	MY45101555	N/A	Aug. 22, 2012	May 16, 2013	Aug. 21, 2013	Conducted (TH01-KS)
Power Sensor	Agilent	E9327A	MY44421198	N/A	Aug. 22, 2012	May 16, 2013	Aug. 21, 2013	Conducted (TH01-KS)
DC Power Supply	GWINSTEK	GPS-3030D	E1884515	N/A	Aug. 22, 2012	May 16, 2013	Aug. 21, 2013	Conducted (TH01-KS)
Thermal Chamber	Ten Billion	TTC-B3S	TBN-960502	N/A	Dec. 29, 2012	May 16, 2013	Dec. 28, 2013	Conducted (TH01-KS)
Bluetooth Base Station	R&S	CBT	100783	N/A	Aug. 17, 2012	May 16, 2013	Aug. 16, 2013	Conducted (TH01-KS)
EMI Test Receiver	R&S	ESCI	100534	9kHz~3GHz	Nov. 08, 2012	May 19, 2013	Nov. 07, 2013	Radiation (03CH01-KS)
Spectrum Analyzer	R&S	FSP30	100400	9kHz~30GHz	Jun. 01, 2012	May 19, 2013	May 31, 2013	Radiation (03CH01-KS)
Bilog Antenna	SCHAFFNER	CBL6112D	23182	25MHz~2GHz	Dec. 07, 2012	May 19, 2013	Dec. 06, 2013	Radiation (03CH01-KS)
HFH2-Z2 Loop Antenna	R&S	HFH2-Z2	100321	9KHZ-30MHZ	Oct. 22, 2012	May 19, 2013	Oct. 21, 2013	Radiation (03CH01-KS)
Double Ridge Horn Antenna	ETS-Lindgren	1908/7/13	00075957	1GHz~18GHz	Dec. 07, 2012	May 19, 2013	Dec. 06, 2013	Radiation (03CH01-KS)
Amplifier	com-power	PA-103A	161069	1MHz~1GHz	Jun. 01, 2012	May 19, 2013	May 31, 2013	Radiation (03CH01-KS)
Amplifier	Agilent	8449B	3008A02370	1GHz~26.5GHz	Dec. 29, 2012	May 19, 2013	Dec. 28, 2013	Radiation (03CH01-KS)
Active Horn Antenna	com-power	AHA-118	701023	1GHz~18GHz	Nov. 07, 2012	May 19, 2013	Nov. 06, 2013	Radiation (03CH01-KS)
SHF-EHF Horn	Schwarzbeck	BBHA 9170	9170249	15GHz~40GHz	Nov. 23, 2012	May 19, 2013	Nov. 22, 2013	Radiation (03CH01-KS)
Bluetooth Base Station	R&S	CBT	100783	N/A	Aug. 17, 2012	May 19, 2013	Aug. 16, 2013	Radiation (03CH01-KS)



5 Uncertainty of Evaluation

Uncertainty of Radiated Emission Measurement (30 MHz ~ 1000 MHz)

Measuring Uncertainty for a Level of Confidence of 95% ($U = 2Uc(y)$)	2.54
---	------

Uncertainty of Radiated Emission Measurement (1 GHz ~ 40 GHz)

Measuring Uncertainty for a Level of Confidence of 95% ($U = 2Uc(y)$)	4.72
---	------



Appendix A. Photographs of EUT

Please refer to Sporton report number EP322704-05 as below.



Appendix C. Product Equality Declaration