

#01 GSM850_GPRS12_Bottom Face_0cm_sensor on_Ch251

DUT: 262503

Communication System: GPRS/EDGE 12; Frequency: 848.8 MHz; Duty Cycle: 1:2

Medium: MSL_835_120716 Medium parameters used: $f = 849$ MHz; $\sigma = 0.981$ mho/m; $\epsilon_r = 55.275$;

$\rho = 1000$ kg/m³

Ambient Temperature : 23.1 °C ; Liquid Temperature : 21.2 °C

DASY5 Configuration:

- Probe: EX3DV4 - SN3697; ConvF(8.67, 8.67, 8.67); Calibrated: 2011-9-2
- Sensor-Surface: 4mm (Mechanical Surface Detection)
- Electronics: DAE4 Sn1210; Calibrated: 2011-11-18
- Phantom: SAM3; Type: SAM; Serial: TP-1079
- Measurement SW: DASY52, Version 52.8 (0); SEMCAD X Version 14.4.5 (3634)

Ch251/Area Scan (101x151x1): Measurement grid: dx=15mm, dy=15mm

Maximum value of SAR (interpolated) = 1.115 mW/g

Ch251/Zoom Scan (5x5x7)/Cube 0: Measurement grid: dx=8mm, dy=8mm, dz=5mm

Reference Value = 9.661 V/m; Power Drift = 0.01 dB

Peak SAR (extrapolated) = 2.096 W/kg

SAR(1 g) = 1.07 mW/g; SAR(10 g) = 0.598 mW/g

Maximum value of SAR (measured) = 1.195 mW/g

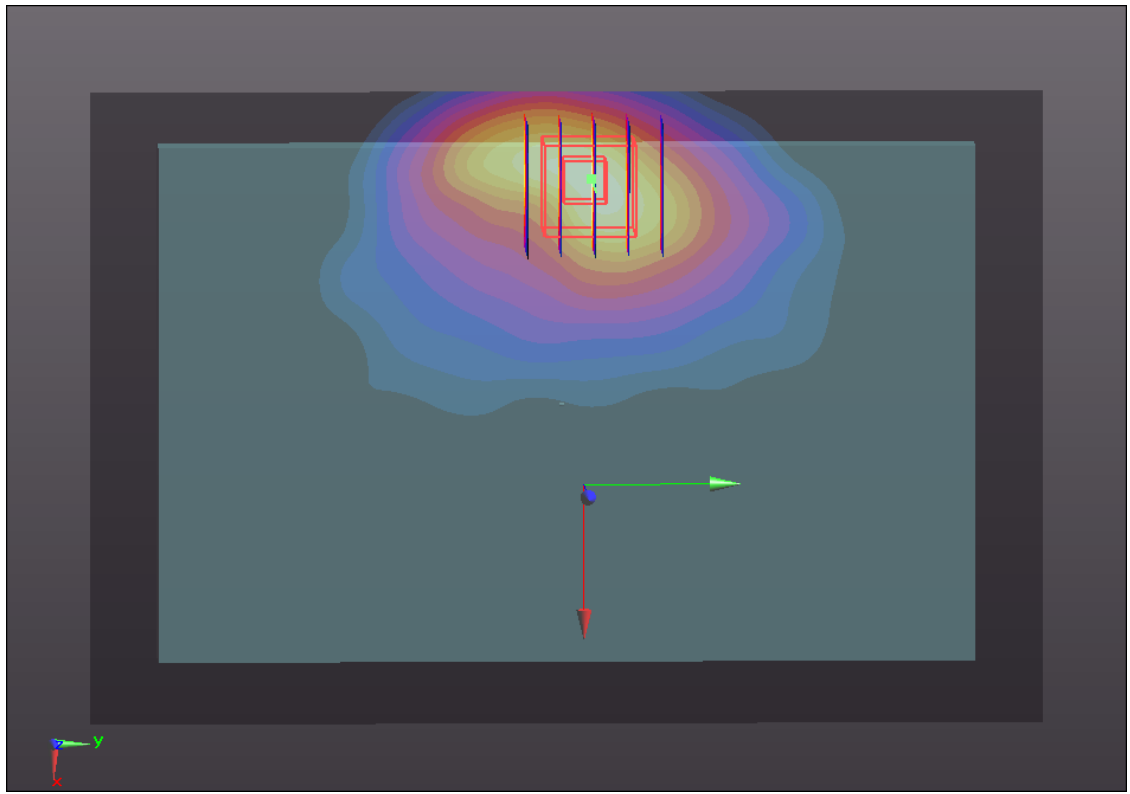
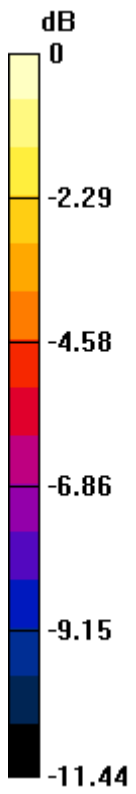

0 dB = 1.200mW/g

#01 GSM850_GPRS12_Bottom Face_0cm_sensor on_Ch251_2D

DUT: 262503

Communication System: GPRS/EDGE 12; Frequency: 848.8 MHz; Duty Cycle: 1:2

Medium: MSL_835_120716 Medium parameters used: $f = 849$ MHz; $\sigma = 0.981$ mho/m; $\epsilon_r = 55.275$;

$\rho = 1000$ kg/m³

Ambient Temperature : 23.1 °C; Liquid Temperature : 21.2 °C

DASY5 Configuration:

- Probe: EX3DV4 - SN3697; ConvF(8.67, 8.67, 8.67); Calibrated: 2011-9-2
- Sensor-Surface: 4mm (Mechanical Surface Detection)
- Electronics: DAE4 Sn1210; Calibrated: 2011-11-18
- Phantom: SAM3; Type: SAM; Serial: TP-1079
- Measurement SW: DASY52, Version 52.8 (0); SEMCAD X Version 14.4.5 (3634)

Ch251/Area Scan (101x151x1): Measurement grid: dx=15mm, dy=15mm

Maximum value of SAR (interpolated) = 1.115 mW/g

Ch251/Zoom Scan (5x5x7)/Cube 0: Measurement grid: dx=8mm, dy=8mm, dz=5mm

Reference Value = 9.661 V/m; Power Drift = 0.01 dB

Peak SAR (extrapolated) = 2.096 W/kg

SAR(1 g) = 1.07 mW/g; SAR(10 g) = 0.598 mW/g

Maximum value of SAR (measured) = 1.195 mW/g

1g/10g Averaged SAR

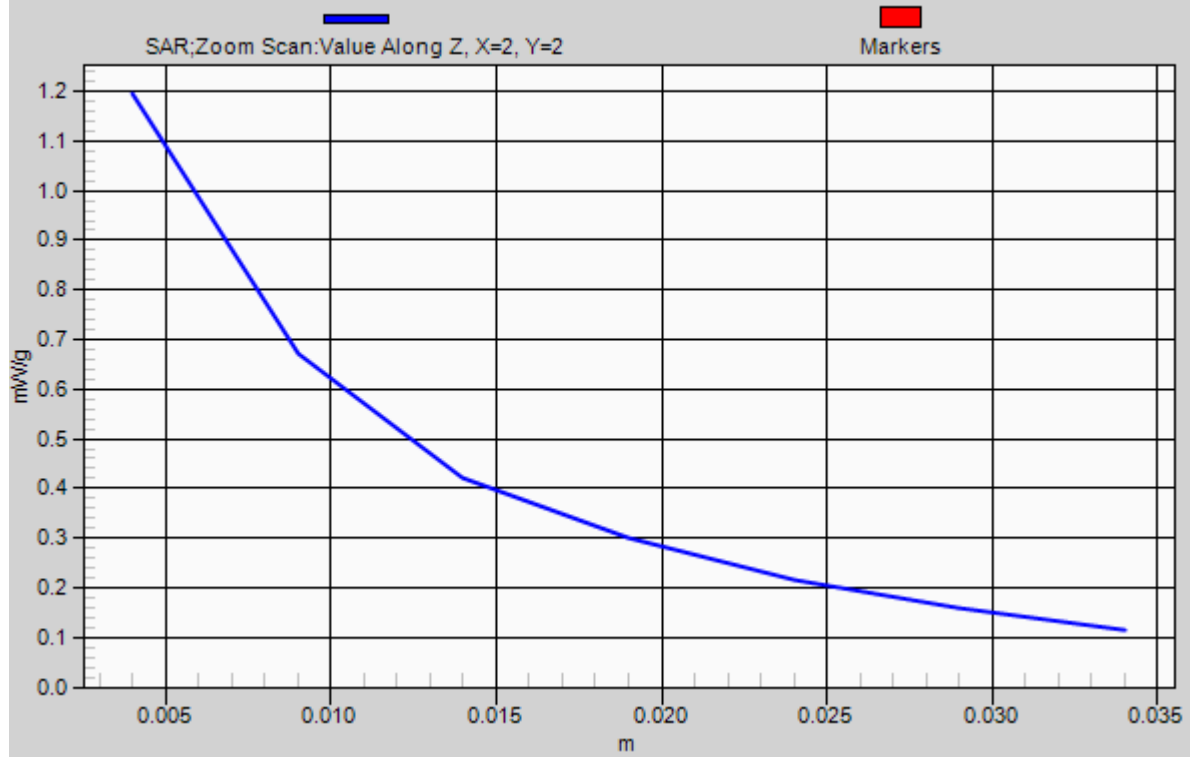

#06 GSM850_GPRS12_Bottom Face_0cm_sensor on_Ch128

DUT: 262503

Communication System: GPRS/EDGE 12; Frequency: 824.2 MHz; Duty Cycle: 1:2

Medium: MSL_835_120716 Medium parameters used: $f = 824.2$ MHz; $\sigma = 0.956$ mho/m; $\epsilon_r =$

55.497 ; $\rho = 1000$ kg/m³

Ambient Temperature : 23.1 °C ; Liquid Temperature : 21.2 °C

DASY5 Configuration:

- Probe: EX3DV4 - SN3697; ConvF(8.67, 8.67, 8.67); Calibrated: 2011-9-2
- Sensor-Surface: 4mm (Mechanical Surface Detection)
- Electronics: DAE4 Sn1210; Calibrated: 2011-11-18
- Phantom: SAM3; Type: SAM; Serial: TP-1079
- Measurement SW: DASY52, Version 52.8 (0); SEMCAD X Version 14.4.5 (3634)

Ch128/Area Scan (101x151x1): Measurement grid: dx=15mm, dy=15mm

Maximum value of SAR (interpolated) = 1.073 mW/g

Ch128/Zoom Scan (5x5x7)/Cube 0: Measurement grid: dx=8mm, dy=8mm, dz=5mm

Reference Value = 10.307 V/m; Power Drift = 0.11 dB

Peak SAR (extrapolated) = 1.767 W/kg

SAR(1 g) = 1.01 mW/g; SAR(10 g) = 0.576 mW/g

Maximum value of SAR (measured) = 1.198 mW/g

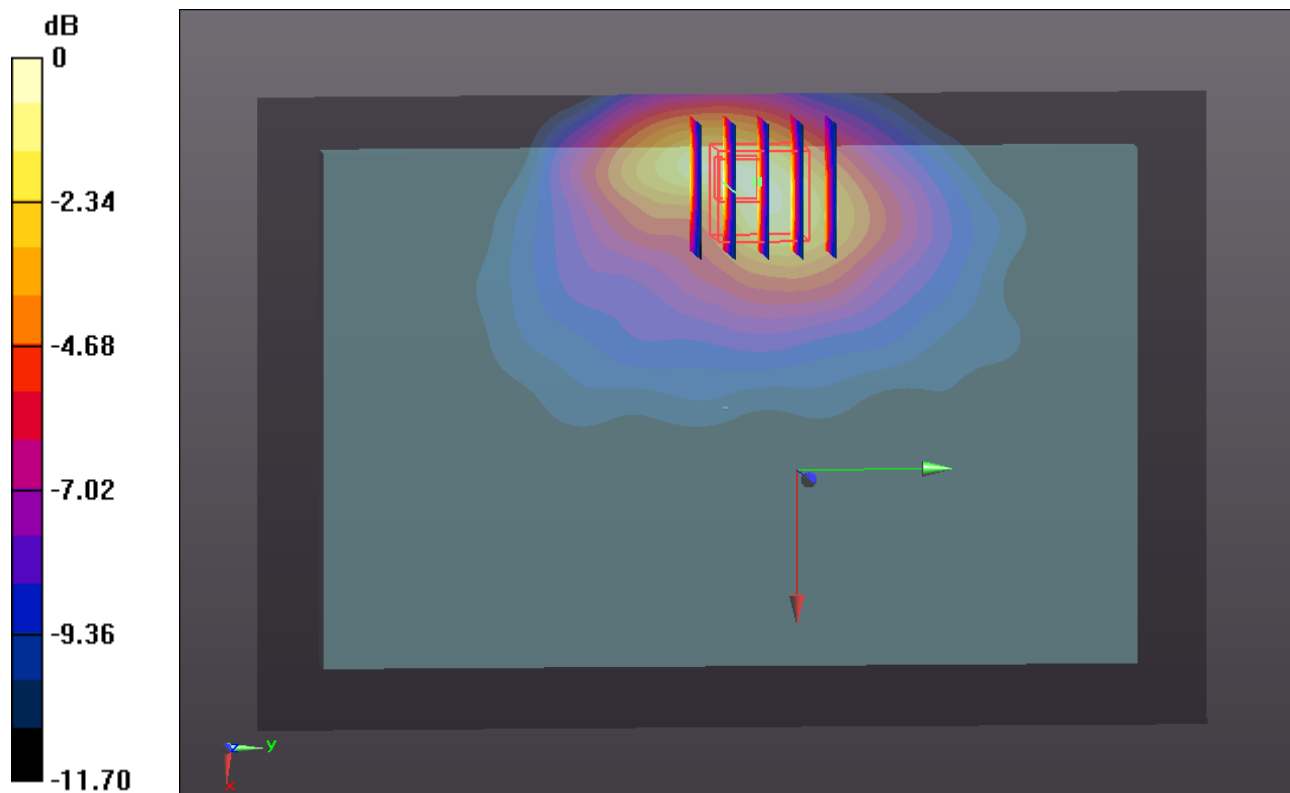

0 dB = 1.200mW/g

#07 GSM850_GPRS12_Bottom Face_0cm_sensor on_Ch189

DUT: 262503

Communication System: GPRS/EDGE 12; Frequency: 836.4 MHz; Duty Cycle: 1:2

Medium: MSL_835_120716 Medium parameters used: $f = 836.4$ MHz; $\sigma = 0.968$ mho/m; $\epsilon_r =$

55.391 ; $\rho = 1000$ kg/m³

Ambient Temperature : 23.1 °C ; Liquid Temperature : 21.2 °C

DASY5 Configuration:

- Probe: EX3DV4 - SN3697; ConvF(8.67, 8.67, 8.67); Calibrated: 2011-9-2
- Sensor-Surface: 4mm (Mechanical Surface Detection)
- Electronics: DAE4 Sn1210; Calibrated: 2011-11-18
- Phantom: SAM3; Type: SAM; Serial: TP-1079
- Measurement SW: DASY52, Version 52.8 (0); SEMCAD X Version 14.4.5 (3634)

Ch189/Area Scan (101x151x1): Measurement grid: dx=15mm, dy=15mm

Maximum value of SAR (interpolated) = 1.111 mW/g

Ch189/Zoom Scan (5x5x7)/Cube 0: Measurement grid: dx=8mm, dy=8mm, dz=5mm

Reference Value = 10.121 V/m; Power Drift = 0.10 dB

Peak SAR (extrapolated) = 2.021 W/kg

SAR(1 g) = 1.06 mW/g; SAR(10 g) = 0.603 mW/g

Maximum value of SAR (measured) = 1.197 mW/g

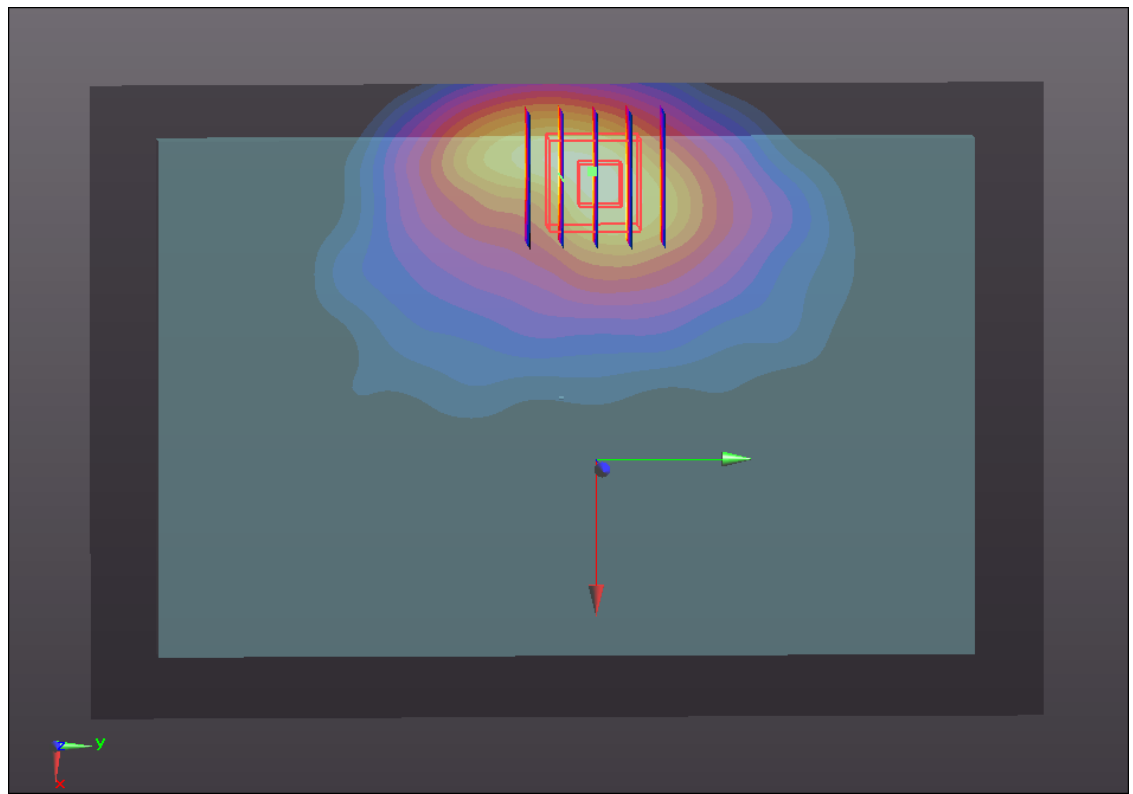
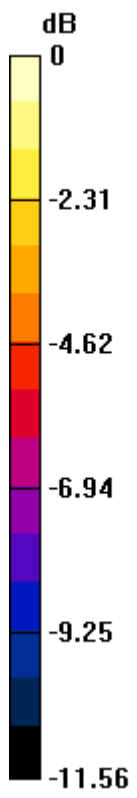

0 dB = 1.200mW/g

#02 GSM850_GPRS12_Primary Portrait_0cm_sensor on_Ch251

DUT: 262503

Communication System: GPRS/EDGE 12; Frequency: 848.8 MHz; Duty Cycle: 1:2

Medium: MSL_835_120716 Medium parameters used: $f = 849$ MHz; $\sigma = 0.981$ mho/m; $\epsilon_r = 55.275$;

$\rho = 1000$ kg/m³

Ambient Temperature : 23.1 °C ; Liquid Temperature : 21.2 °C

DASY5 Configuration:

- Probe: EX3DV4 - SN3697; ConvF(8.67, 8.67, 8.67); Calibrated: 2011-9-2
- Sensor-Surface: 4mm (Mechanical Surface Detection)
- Electronics: DAE4 Sn1210; Calibrated: 2011-11-18
- Phantom: SAM3; Type: SAM; Serial: TP-1079
- Measurement SW: DASY52, Version 52.8 (0); SEMCAD X Version 14.4.5 (3634)

Ch251/Area Scan (31x151x1): Measurement grid: dx=15mm, dy=15mm

Maximum value of SAR (interpolated) = 0.695 mW/g

Ch251/Zoom Scan (5x5x7)/Cube 0: Measurement grid: dx=8mm, dy=8mm, dz=5mm

Reference Value = 23.880 V/m; Power Drift = -0.05 dB

Peak SAR (extrapolated) = 1.112 W/kg

SAR(1 g) = 0.601 mW/g; SAR(10 g) = 0.344 mW/g

Maximum value of SAR (measured) = 0.691 mW/g

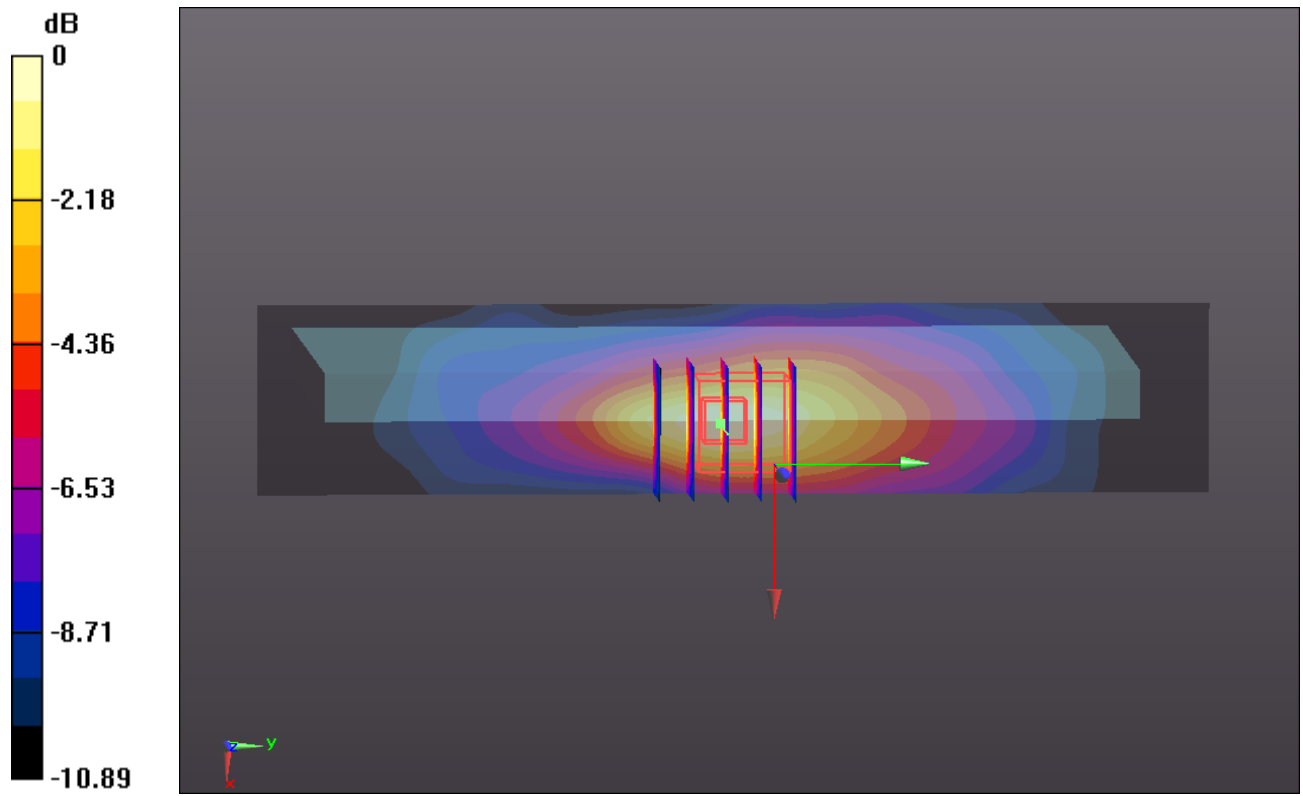

0 dB = 0.690mW/g

#03 GSM850_GPRS12_Bottom Face_0.9cm_sensor off_Ch251

DUT: 262503

Communication System: GPRS/EDGE 12; Frequency: 848.8 MHz; Duty Cycle: 1:2

Medium: MSL_835_120716 Medium parameters used: $f = 849$ MHz; $\sigma = 0.981$ mho/m; $\epsilon_r = 55.275$;

$\rho = 1000$ kg/m³

Ambient Temperature : 23.1 °C ; Liquid Temperature : 21.2 °C

DASY5 Configuration:

- Probe: EX3DV4 - SN3697; ConvF(8.67, 8.67, 8.67); Calibrated: 2011-9-2
- Sensor-Surface: 4mm (Mechanical Surface Detection)
- Electronics: DAE4 Sn1210; Calibrated: 2011-11-18
- Phantom: SAM3; Type: SAM; Serial: TP-1079
- Measurement SW: DASY52, Version 52.8 (0); SEMCAD X Version 14.4.5 (3634)

Ch251/Area Scan (101x151x1): Measurement grid: dx=15mm, dy=15mm

Maximum value of SAR (interpolated) = 1.099 mW/g

Ch251/Zoom Scan (5x5x7)/Cube 0: Measurement grid: dx=8mm, dy=8mm, dz=5mm

Reference Value = 14.743 V/m; Power Drift = -0.07 dB

Peak SAR (extrapolated) = 1.593 W/kg

SAR(1 g) = 1.01 mW/g; SAR(10 g) = 0.629 mW/g

Maximum value of SAR (measured) = 1.075 mW/g

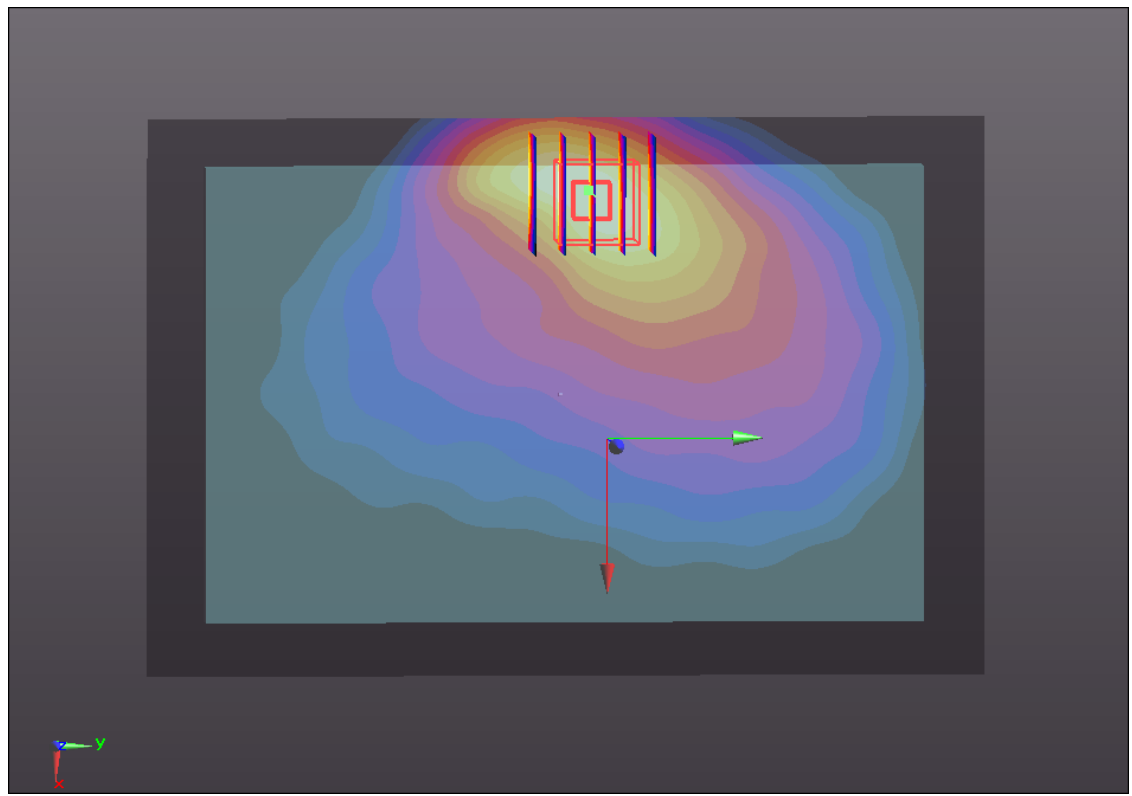
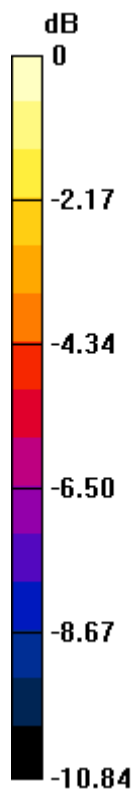

0 dB = 1.080mW/g

#08 GSM850_GPRS12_Bottom Face_0.9cm_sensor off_Ch128

DUT: 262503

Communication System: GPRS/EDGE 12; Frequency: 824.2 MHz; Duty Cycle: 1:2
Medium: MSL_835_120716 Medium parameters used: $f = 824.2$ MHz; $\sigma = 0.956$ mho/m; $\epsilon_r = 55.497$; $\rho = 1000$ kg/m³
Ambient Temperature : 23.1 °C ; Liquid Temperature : 21.2 °C

DASY5 Configuration:

- Probe: EX3DV4 - SN3697; ConvF(8.67, 8.67, 8.67); Calibrated: 2011-9-2
- Sensor-Surface: 4mm (Mechanical Surface Detection)
- Electronics: DAE4 Sn1210; Calibrated: 2011-11-18
- Phantom: SAM3; Type: SAM; Serial: TP-1079
- Measurement SW: DASY52, Version 52.8 (0); SEMCAD X Version 14.4.5 (3634)

Ch128/Area Scan (101x151x1): Measurement grid: dx=15mm, dy=15mm
Maximum value of SAR (interpolated) = 0.866 mW/g

Ch128/Zoom Scan (5x5x7)/Cube 0: Measurement grid: dx=8mm, dy=8mm, dz=5mm
Reference Value = 13.741 V/m; Power Drift = -0.05 dB
Peak SAR (extrapolated) = 1.227 W/kg
SAR(1 g) = 0.793 mW/g; SAR(10 g) = 0.503 mW/g
Maximum value of SAR (measured) = 0.852 mW/g

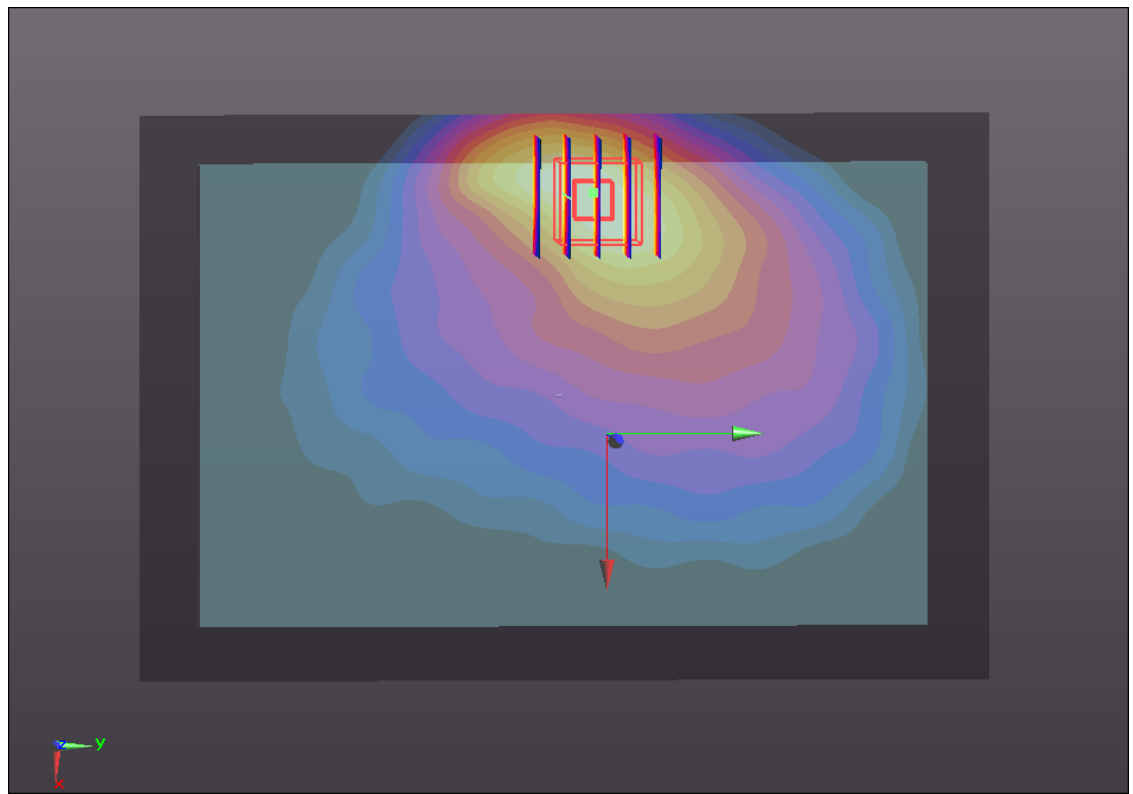
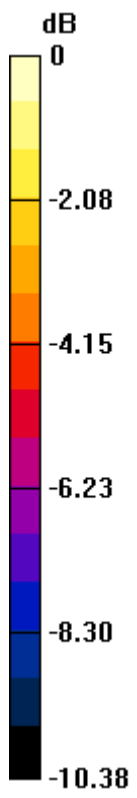

0 dB = 0.850mW/g

#09 GSM850_GPRS12_Bottom Face_0.9cm_sensor off_Ch189

DUT: 262503

Communication System: GPRS/EDGE 12; Frequency: 836.4 MHz; Duty Cycle: 1:2

Medium: MSL_835_120716 Medium parameters used: $f = 836.4$ MHz; $\sigma = 0.968$ mho/m; $\epsilon_r =$

55.391 ; $\rho = 1000$ kg/m³

Ambient Temperature : 23.1 °C ; Liquid Temperature : 21.2 °C

DASY5 Configuration:

- Probe: EX3DV4 - SN3697; ConvF(8.67, 8.67, 8.67); Calibrated: 2011-9-2
- Sensor-Surface: 4mm (Mechanical Surface Detection)
- Electronics: DAE4 Sn1210; Calibrated: 2011-11-18
- Phantom: SAM3; Type: SAM; Serial: TP-1079
- Measurement SW: DASY52, Version 52.8 (0); SEMCAD X Version 14.4.5 (3634)

Ch189/Area Scan (101x151x1): Measurement grid: dx=15mm, dy=15mm

Maximum value of SAR (interpolated) = 1.006 mW/g

Ch189/Zoom Scan (5x5x7)/Cube 0: Measurement grid: dx=8mm, dy=8mm, dz=5mm

Reference Value = 14.440 V/m; Power Drift = -0.05 dB

Peak SAR (extrapolated) = 1.464 W/kg

SAR(1 g) = 0.933 mW/g; SAR(10 g) = 0.584 mW/g

Maximum value of SAR (measured) = 1.002 mW/g

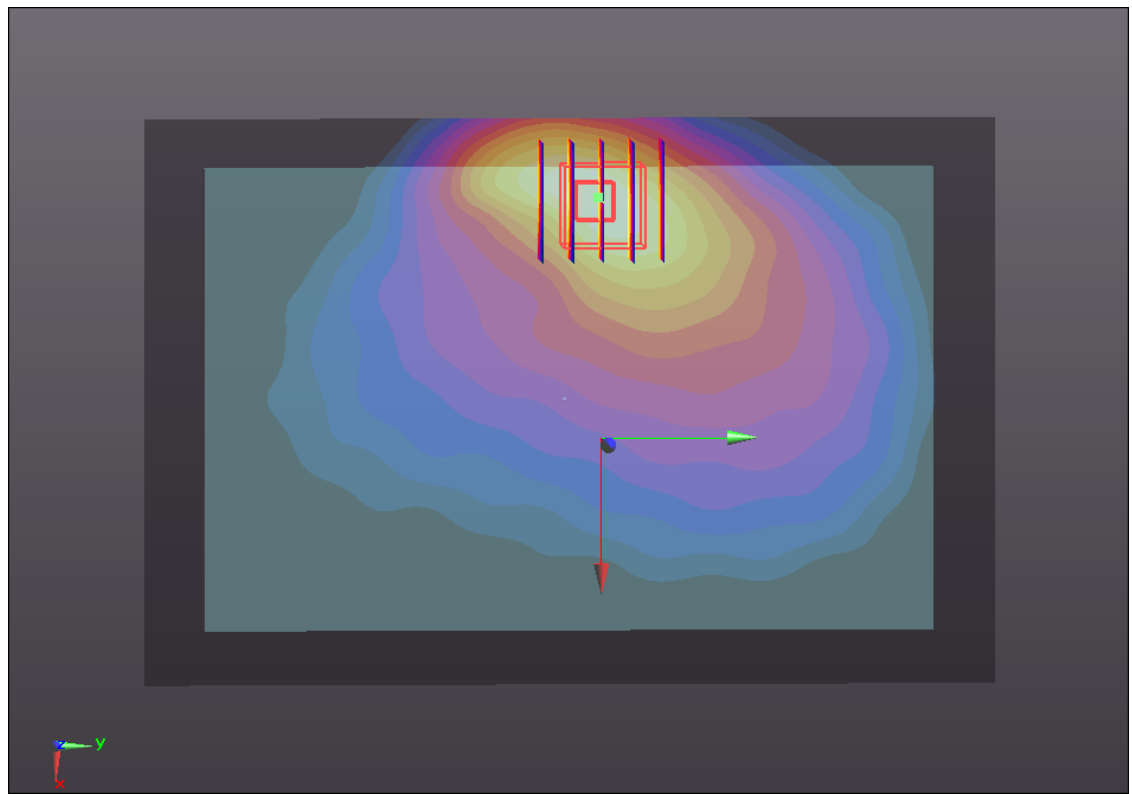
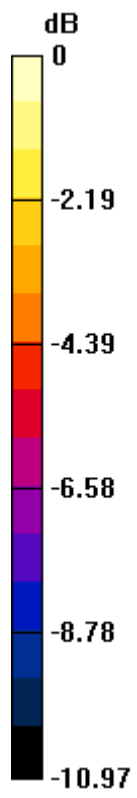

0 dB = 1.000mW/g

#04 GSM850_GPRS12_Primary Portrait_0.7cm_sensor off_Ch251

DUT: 262503

Communication System: GPRS/EDGE 12; Frequency: 848.8 MHz; Duty Cycle: 1:2

Medium: MSL_835_120716 Medium parameters used: $f = 849$ MHz; $\sigma = 0.981$ mho/m; $\epsilon_r = 55.275$;

$\rho = 1000$ kg/m³

Ambient Temperature : 23.1 °C ; Liquid Temperature : 21.2 °C

DASY5 Configuration:

- Probe: EX3DV4 - SN3697; ConvF(8.67, 8.67, 8.67); Calibrated: 2011-9-2
- Sensor-Surface: 4mm (Mechanical Surface Detection)
- Electronics: DAE4 Sn1210; Calibrated: 2011-11-18
- Phantom: SAM3; Type: SAM; Serial: TP-1079
- Measurement SW: DASY52, Version 52.8 (0); SEMCAD X Version 14.4.5 (3634)

Ch251/Area Scan (31x151x1): Measurement grid: dx=15mm, dy=15mm

Maximum value of SAR (interpolated) = 0.892 mW/g

Ch251/Zoom Scan (5x5x7)/Cube 0: Measurement grid: dx=8mm, dy=8mm, dz=5mm

Reference Value = 28.186 V/m; Power Drift = -0.07 dB

Peak SAR (extrapolated) = 1.286 W/kg

SAR(1 g) = 0.835 mW/g; SAR(10 g) = 0.517 mW/g

Maximum value of SAR (measured) = 0.920 mW/g

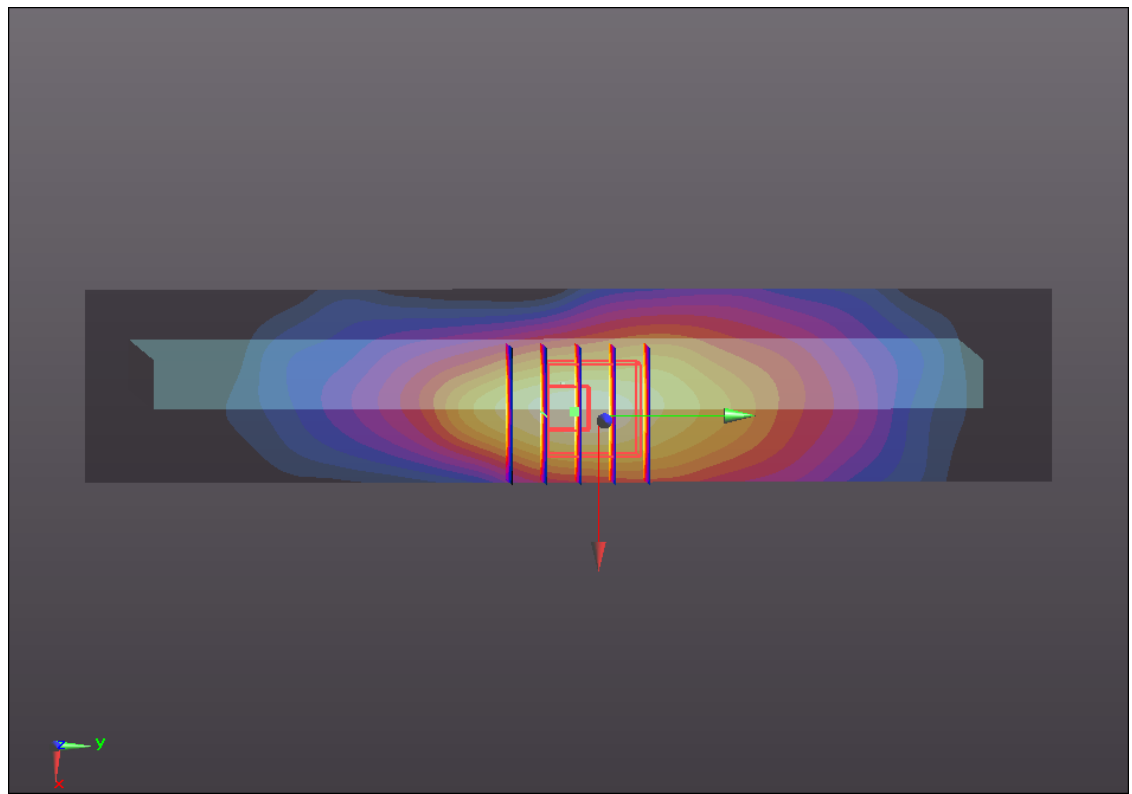
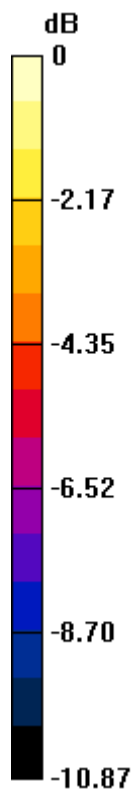

0 dB = 0.920mW/g

#39 GSM850_GPRS12_Primary Portrait_0.7cm_sensor off_Ch128

DUT: 262503

Communication System: GPRS/EDGE 12; Frequency: 824.2 MHz; Duty Cycle: 1:2
Medium: MSL_835_120716 Medium parameters used: $f = 824.2$ MHz; $\sigma = 0.956$ mho/m; $\epsilon_r = 55.497$; $\rho = 1000$ kg/m³
Ambient Temperature : 23.1 °C ; Liquid Temperature : 21.2 °C

DASY5 Configuration:

- Probe: EX3DV4 - SN3697; ConvF(8.67, 8.67, 8.67); Calibrated: 2011-9-2
- Sensor-Surface: 4mm (Mechanical Surface Detection)
- Electronics: DAE4 Sn1210; Calibrated: 2011-11-18
- Phantom: SAM3; Type: SAM; Serial: TP-1079
- Measurement SW: DASY52, Version 52.8 (0); SEMCAD X Version 14.4.5 (3634)

Ch128/Area Scan (31x151x1): Measurement grid: dx=15mm, dy=15mm
Maximum value of SAR (interpolated) = 0.765 mW/g

Ch128/Zoom Scan (5x5x7)/Cube 0: Measurement grid: dx=8mm, dy=8mm, dz=5mm
Reference Value = 25.582 V/m; Power Drift = -0.05 dB
Peak SAR (extrapolated) = 1.025 W/kg
SAR(1 g) = 0.674 mW/g; SAR(10 g) = 0.432 mW/g
Maximum value of SAR (measured) = 0.759 mW/g

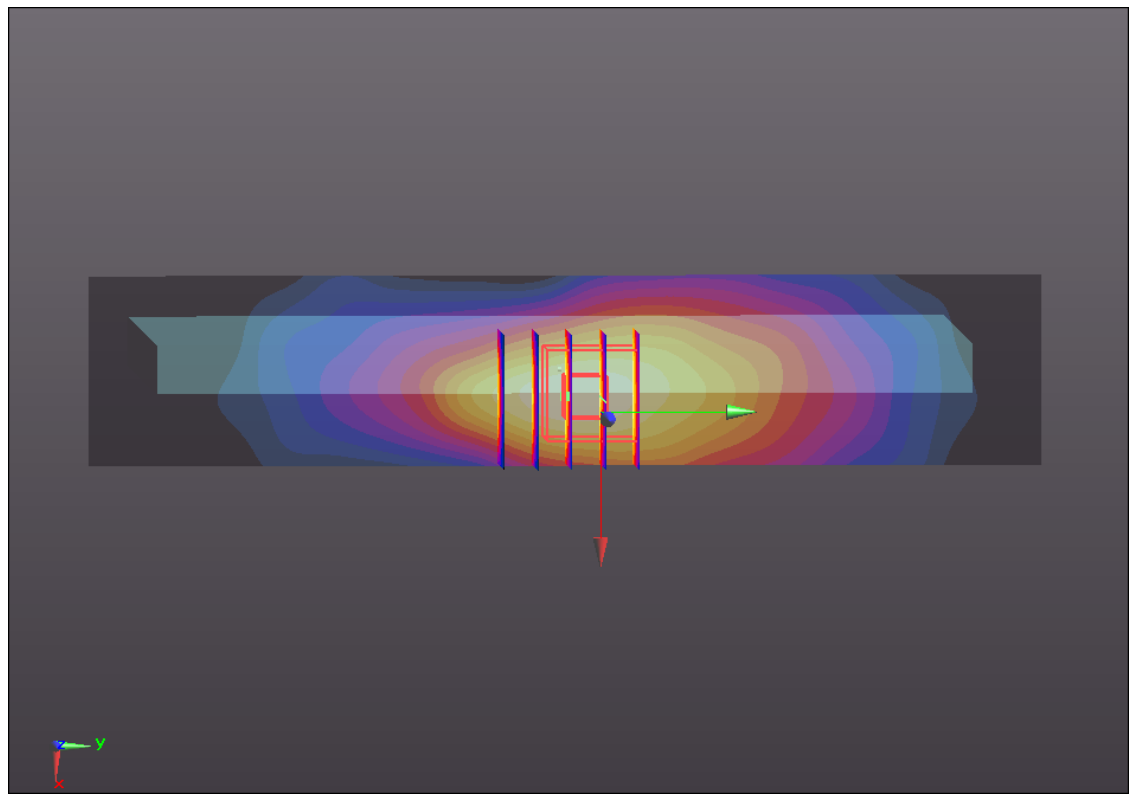
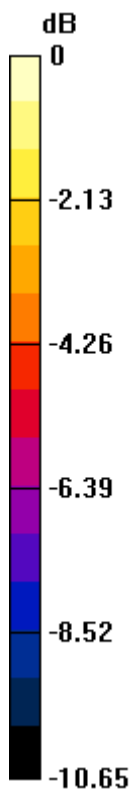

0 dB = 0.760mW/g

#40 GSM850_GPRS12_Primary Portrait_0.7cm_sensor off_Ch189

DUT: 262503

Communication System: GPRS/EDGE 12; Frequency: 836.4 MHz; Duty Cycle: 1:2

Medium: MSL_835_120716 Medium parameters used: $f = 836.4$ MHz; $\sigma = 0.968$ mho/m; $\epsilon_r =$

55.391 ; $\rho = 1000$ kg/m³

Ambient Temperature : 23.1 °C ; Liquid Temperature : 21.2 °C

DASY5 Configuration:

- Probe: EX3DV4 - SN3697; ConvF(8.67, 8.67, 8.67); Calibrated: 2011-9-2
- Sensor-Surface: 4mm (Mechanical Surface Detection)
- Electronics: DAE4 Sn1210; Calibrated: 2011-11-18
- Phantom: SAM3; Type: SAM; Serial: TP-1079
- Measurement SW: DASY52, Version 52.8 (0); SEMCAD X Version 14.4.5 (3634)

Ch189/Area Scan (31x151x1): Measurement grid: dx=15mm, dy=15mm

Maximum value of SAR (interpolated) = 0.874 mW/g

Ch189/Zoom Scan (5x5x7)/Cube 0: Measurement grid: dx=8mm, dy=8mm, dz=5mm

Reference Value = 26.953 V/m; Power Drift = -0.06 dB

Peak SAR (extrapolated) = 1.290 W/kg

SAR(1 g) = 0.803 mW/g; SAR(10 g) = 0.499 mW/g

Maximum value of SAR (measured) = 0.904 mW/g

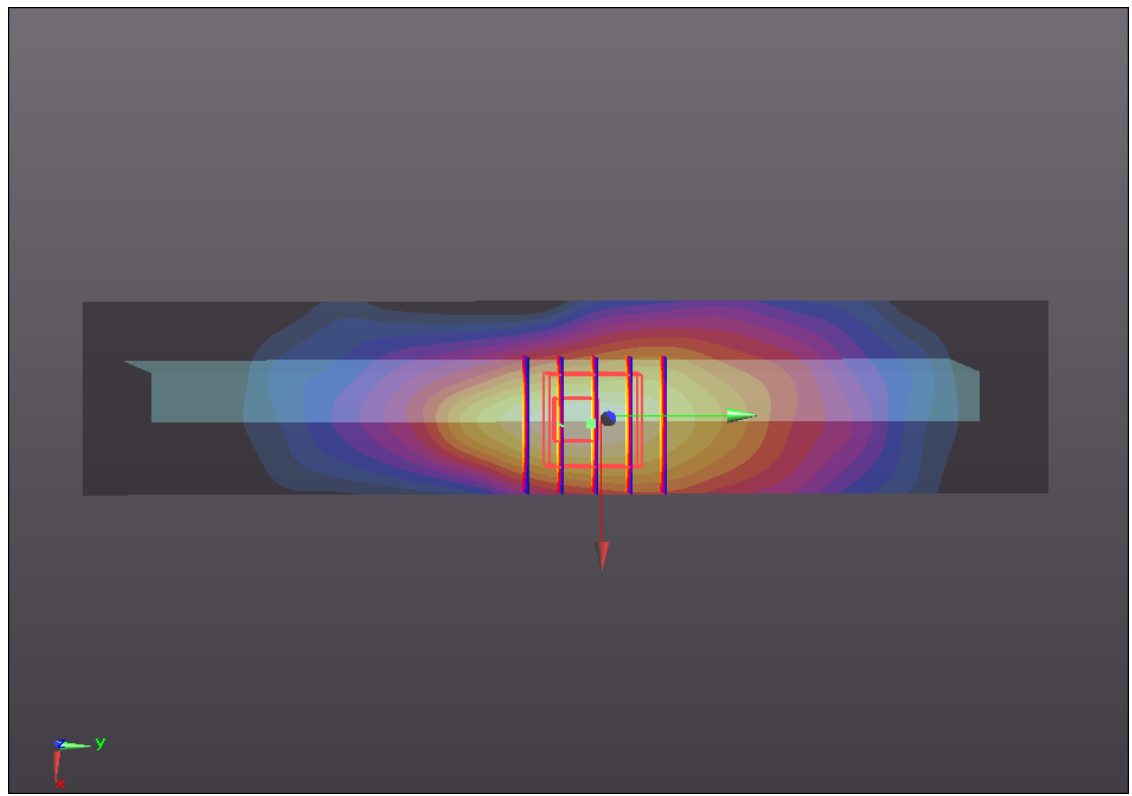
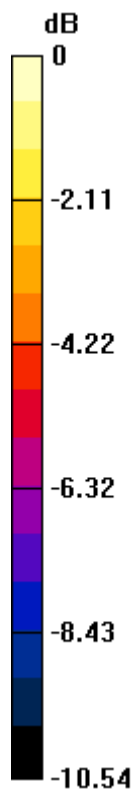

0 dB = 0.900mW/g

#05 GSM850_GPRS12_Primary Portrait_Right Corner at 6 degree_sensor off_Ch251

DUT: 262503

Communication System: GPRS/EDGE 12; Frequency: 848.8 MHz; Duty Cycle: 1:2

Medium: MSL_835_120716 Medium parameters used: $f = 849$ MHz; $\sigma = 0.981$ mho/m; $\epsilon_r = 55.275$;

$\rho = 1000$ kg/m³

Ambient Temperature : 23.1 °C; Liquid Temperature : 21.2 °C

DASY5 Configuration:

- Probe: EX3DV4 - SN3697; ConvF(8.67, 8.67, 8.67); Calibrated: 2011-9-2
- Sensor-Surface: 4mm (Mechanical Surface Detection)
- Electronics: DAE4 Sn1210; Calibrated: 2011-11-18
- Phantom: SAM3; Type: SAM; Serial: TP-1079
- Measurement SW: DASY52, Version 52.8 (0); SEMCAD X Version 14.4.5 (3634)

Ch251/Area Scan (31x151x1): Measurement grid: dx=15mm, dy=15mm

Maximum value of SAR (interpolated) = 0.649 mW/g

Ch251/Zoom Scan (5x5x7)/Cube 0: Measurement grid: dx=8mm, dy=8mm, dz=5mm

Reference Value = 22.917 V/m; Power Drift = -0.06 dB

Peak SAR (extrapolated) = 0.847 W/kg

SAR(1 g) = 0.576 mW/g; SAR(10 g) = 0.376 mW/g

Maximum value of SAR (measured) = 0.622 mW/g

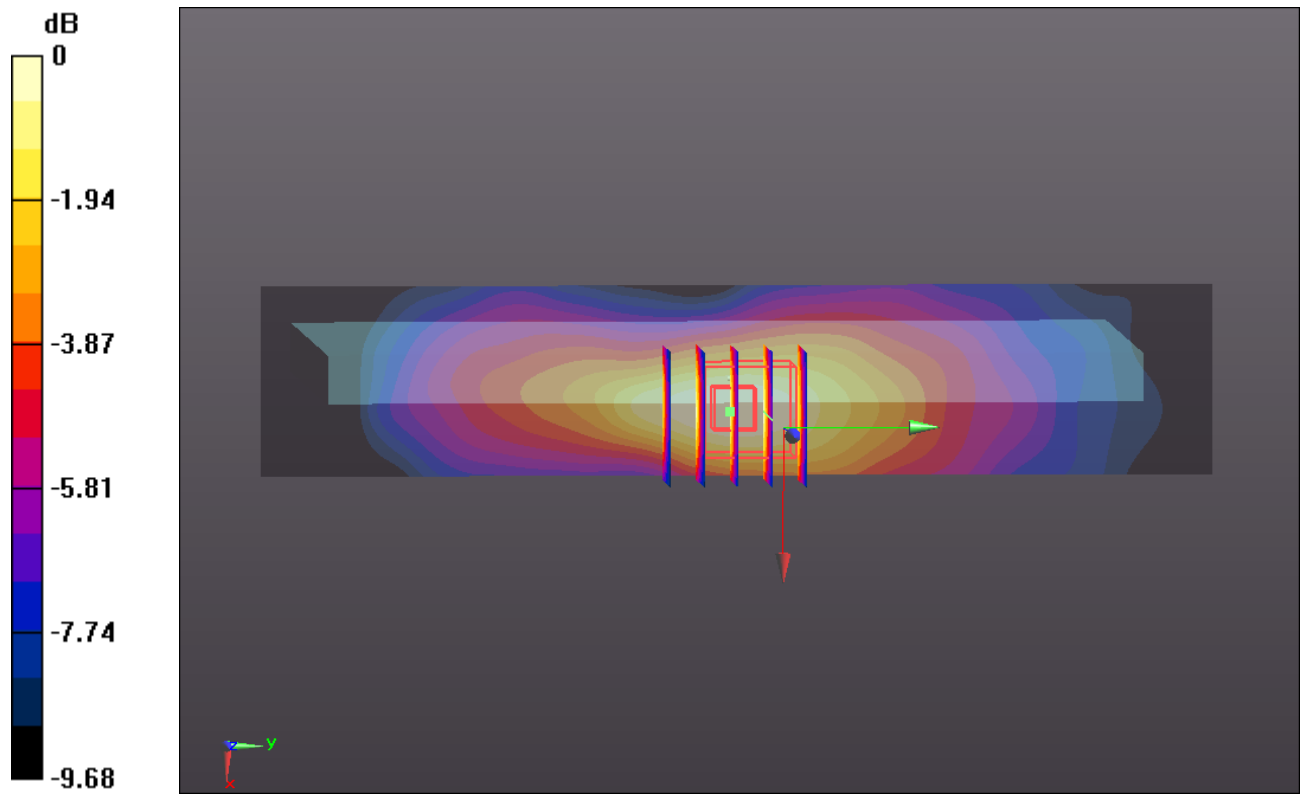

0 dB = 0.620mW/g

#45 GSM850_GPRS12_Primary Portrait_Left Corner at 32 degree_sensor off_Ch251

DUT: 262503

Communication System: GPRS/EDGE 12; Frequency: 848.8 MHz; Duty Cycle: 1:2

Medium: MSL_835_120730 Medium parameters used: $f = 849$ MHz; $\sigma = 0.989$ mho/m; $\epsilon_r = 54.273$;

$\rho = 1000$ kg/m³

Ambient Temperature : 23.2 °C; Liquid Temperature : 21.3 °C

DASY5 Configuration:

- Probe: EX3DV4 - SN3857; ConvF(8.98, 8.98, 8.98); Calibrated: 2012-6-20
- Sensor-Surface: 4mm (Mechanical Surface Detection)
- Electronics: DAE4 Sn1210; Calibrated: 2011-11-18
- Phantom: SAM3; Type: SAM; Serial: TP-1079
- Measurement SW: DASY52, Version 52.8 (0); SEMCAD X Version 14.4.5 (3634)

Ch251/Area Scan (31x171x1): Measurement grid: dx=15mm, dy=15mm

Maximum value of SAR (interpolated) = 0.098 mW/g

Ch251/Zoom Scan (5x5x7)/Cube 0: Measurement grid: dx=8mm, dy=8mm, dz=5mm

Reference Value = 9.882 V/m; Power Drift = 0.02 dB

Peak SAR (extrapolated) = 0.126 W/kg

SAR(1 g) = 0.089 mW/g; SAR(10 g) = 0.062 mW/g

Maximum value of SAR (measured) = 0.094 mW/g

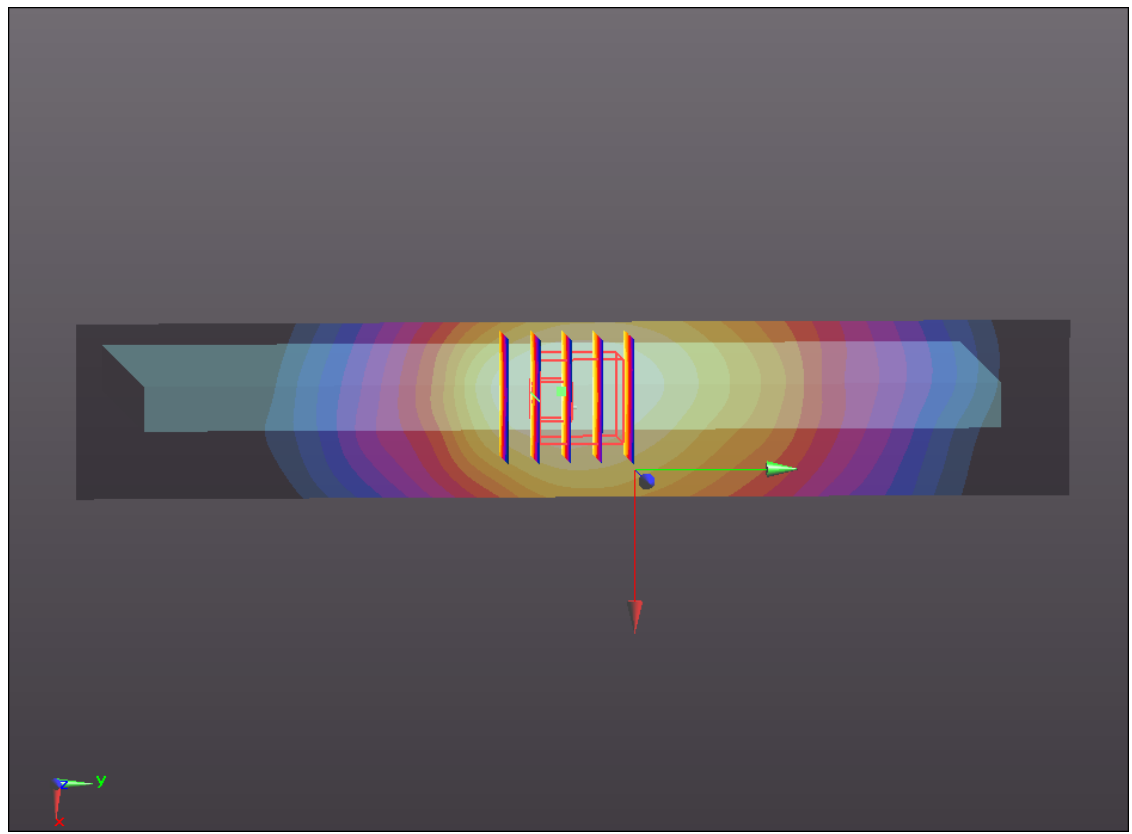
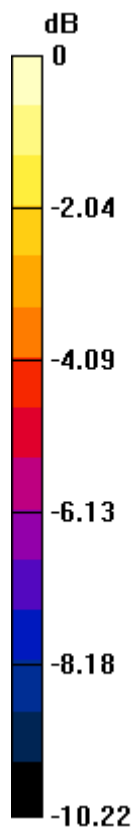

0 dB = 0.090mW/g

#10 GSM1900_GPRS10_Bottom Face_0cm_sensor on_Ch512

DUT: 262503

Communication System: GPRS/EDGE 10; Frequency: 1850.2 MHz; Duty Cycle: 1:4

Medium: MSL_1900_120811 Medium parameters used: $f = 1850.2$ MHz; $\sigma = 1.472$ mho/m; $\epsilon_r =$

54.669 ; $\rho = 1000$ kg/m³

Ambient Temperature : 23.2 °C ; Liquid Temperature : 21.2 °C

DASY5 Configuration:

- Probe: EX3DV4 - SN3857; ConvF(7.35, 7.35, 7.35); Calibrated: 2012-6-20
- Sensor-Surface: 4mm (Mechanical Surface Detection)
- Electronics: DAE4 Sn1210; Calibrated: 2011-11-18
- Phantom: SAM3; Type: SAM; Serial: TP-1079
- Measurement SW: DASY52, Version 52.8 (0); SEMCAD X Version 14.4.5 (3634)

Ch512/Area Scan (101x151x1): Measurement grid: dx=15mm, dy=15mm

Maximum value of SAR (interpolated) = 0.779 mW/g

Ch512/Zoom Scan (5x5x7)/Cube 0: Measurement grid: dx=8mm, dy=8mm, dz=5mm

Reference Value = 5.062 V/m; Power Drift = 0.04 dB

Peak SAR (extrapolated) = 1.582 W/kg

SAR(1 g) = 0.739 mW/g; SAR(10 g) = 0.371 mW/g

Maximum value of SAR (measured) = 0.819 mW/g

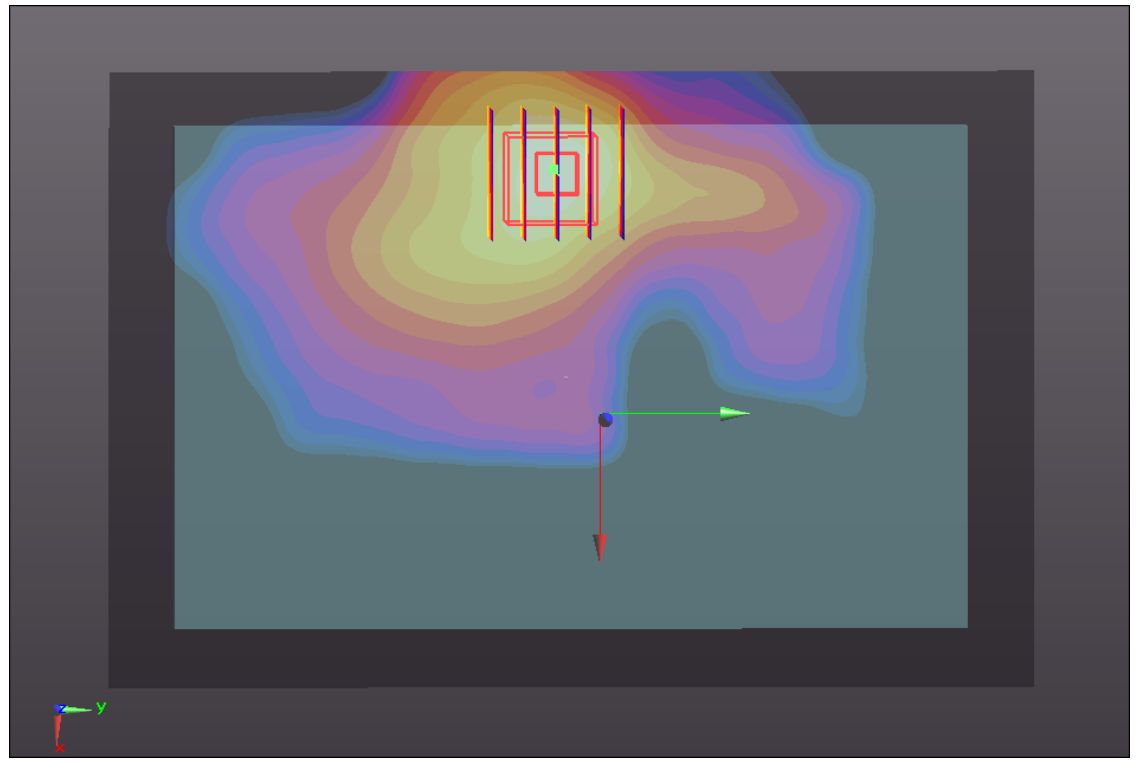
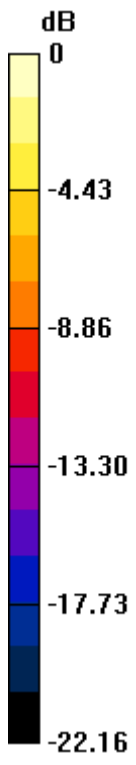

0 dB = 0.820mW/g

#11 GSM1900_GPRS10_Primary Portrait_0cm_sensor on_Ch512

DUT: 262503

Communication System: GPRS/EDGE 10; Frequency: 1850.2 MHz; Duty Cycle: 1:4
Medium: MSL_1900_120811 Medium parameters used: $f = 1850.2$ MHz; $\sigma = 1.472$ mho/m; $\epsilon_r = 54.669$; $\rho = 1000$ kg/m³
Ambient Temperature : 23.2 °C ; Liquid Temperature : 21.2 °C

DASY5 Configuration:

- Probe: EX3DV4 - SN3857; ConvF(7.35, 7.35, 7.35); Calibrated: 2012-6-20
- Sensor-Surface: 4mm (Mechanical Surface Detection)
- Electronics: DAE4 Sn1210; Calibrated: 2011-11-18
- Phantom: SAM3; Type: SAM; Serial: TP-1079
- Measurement SW: DASY52, Version 52.8 (0); SEMCAD X Version 14.4.5 (3634)

Ch512/Area Scan (31x151x1): Measurement grid: dx=15mm, dy=15mm
Maximum value of SAR (interpolated) = 0.684 mW/g

Ch512/Zoom Scan (5x5x7)/Cube 0: Measurement grid: dx=8mm, dy=8mm, dz=5mm
Reference Value = 17.309 V/m; Power Drift = -0.12 dB
Peak SAR (extrapolated) = 1.259 W/kg
SAR(1 g) = 0.608 mW/g; SAR(10 g) = 0.282 mW/g
Maximum value of SAR (measured) = 0.692 mW/g

Ch512/Zoom Scan (5x5x7)/Cube 1: Measurement grid: dx=8mm, dy=8mm, dz=5mm
Reference Value = 17.309 V/m; Power Drift = -0.12 dB
Peak SAR (extrapolated) = 0.975 W/kg
SAR(1 g) = 0.544 mW/g; SAR(10 g) = 0.284 mW/g
Maximum value of SAR (measured) = 0.576 mW/g

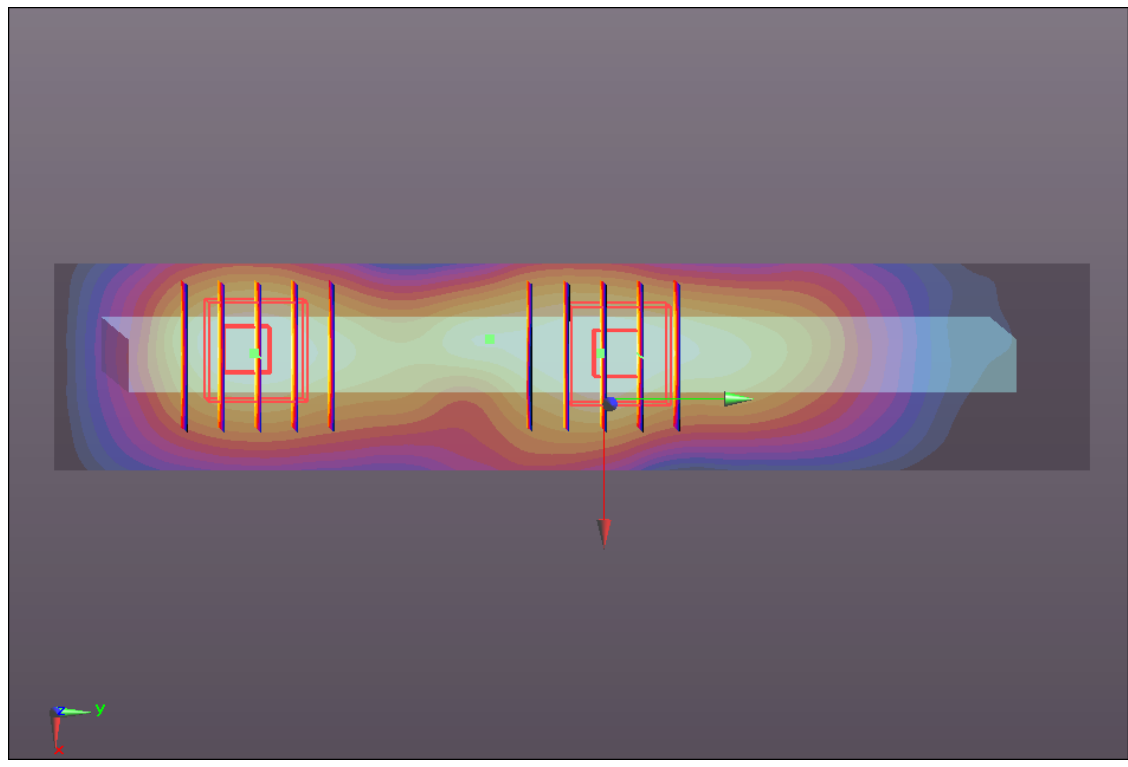
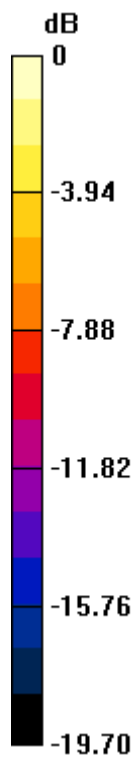

0 dB = 0.580mW/g

#12 GSM1900_GPRS12_Bottom Face_0.9cm_sensor off_Ch512

DUT: 262503

Communication System: GPRS/EDGE 12; Frequency: 1850.2 MHz; Duty Cycle: 1:2

Medium: MSL_1900_120811 Medium parameters used: $f = 1850.2$ MHz; $\sigma = 1.472$ mho/m; $\epsilon_r =$

54.669 ; $\rho = 1000$ kg/m³

Ambient Temperature : 23.2 °C ; Liquid Temperature : 21.2 °C

DASY5 Configuration:

- Probe: EX3DV4 - SN3857; ConvF(7.35, 7.35, 7.35); Calibrated: 2012-6-20
- Sensor-Surface: 4mm (Mechanical Surface Detection)
- Electronics: DAE4 Sn1210; Calibrated: 2011-11-18
- Phantom: SAM3; Type: SAM; Serial: TP-1079
- Measurement SW: DASY52, Version 52.8 (0); SEMCAD X Version 14.4.5 (3634)

Ch512/Area Scan (111x151x1): Measurement grid: dx=15mm, dy=15mm

Maximum value of SAR (interpolated) = 0.369 mW/g

Ch512/Zoom Scan (5x5x7)/Cube 0: Measurement grid: dx=8mm, dy=8mm, dz=5mm

Reference Value = 7.597 V/m; Power Drift = 0.18 dB

Peak SAR (extrapolated) = 0.591 W/kg

SAR(1 g) = 0.337 mW/g; SAR(10 g) = 0.187 mW/g

Maximum value of SAR (measured) = 0.373 mW/g

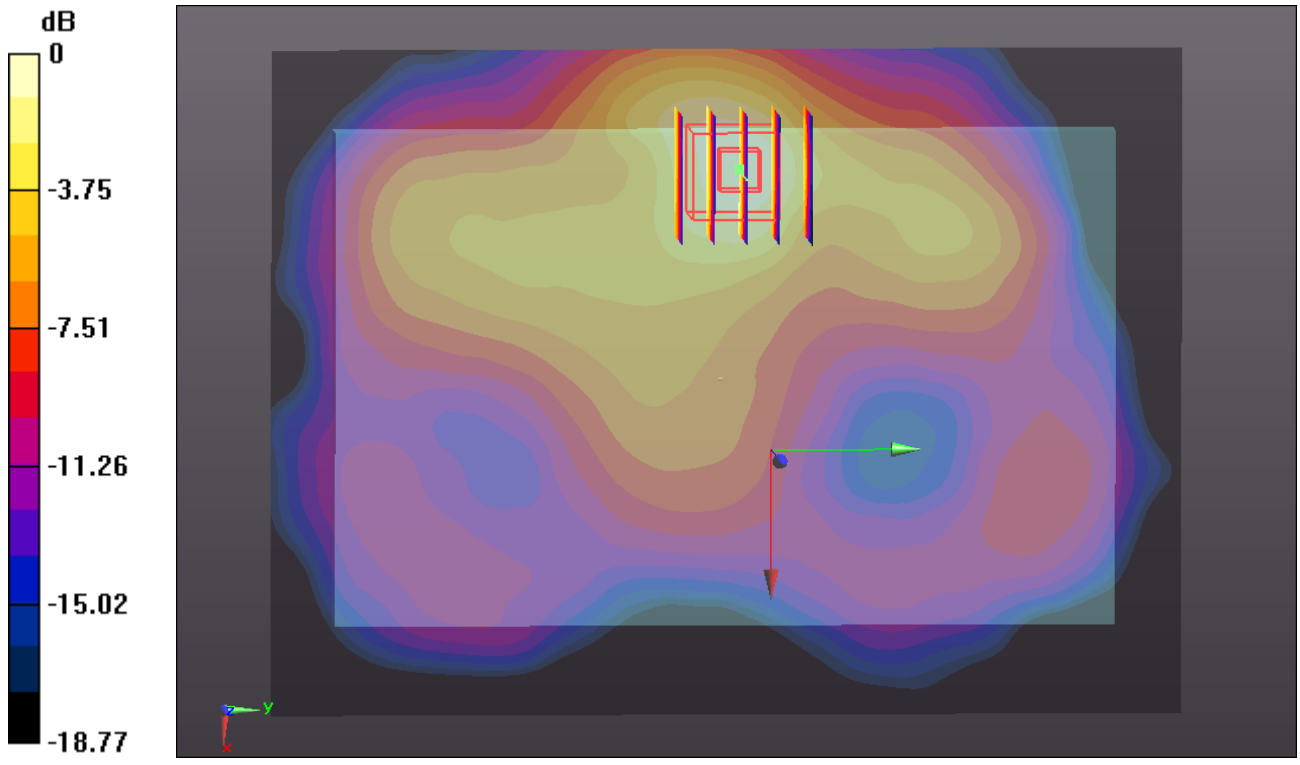

0 dB = 0.370mW/g

#13 GSM1900_GPRS12_Primary Portrait_0.7cm_sensor off_Ch512

DUT: 262503

Communication System: GPRS/EDGE 12; Frequency: 1850.2 MHz; Duty Cycle: 1:2

Medium: MSL_1900_120811 Medium parameters used: $f = 1850.2$ MHz; $\sigma = 1.472$ mho/m; $\epsilon_r =$

54.669 ; $\rho = 1000$ kg/m³

Ambient Temperature : 23.2 °C ; Liquid Temperature : 21.2 °C

DASY5 Configuration:

- Probe: EX3DV4 - SN3857; ConvF(7.35, 7.35, 7.35); Calibrated: 2012-6-20
- Sensor-Surface: 4mm (Mechanical Surface Detection)
- Electronics: DAE4 Sn1210; Calibrated: 2011-11-18
- Phantom: SAM3; Type: SAM; Serial: TP-1079
- Measurement SW: DASY52, Version 52.8 (0); SEMCAD X Version 14.4.5 (3634)

Ch512/Area Scan (31x151x1): Measurement grid: dx=15mm, dy=15mm

Maximum value of SAR (interpolated) = 0.462 mW/g

Ch512/Zoom Scan (5x5x7)/Cube 0: Measurement grid: dx=8mm, dy=8mm, dz=5mm

Reference Value = 16.087 V/m; Power Drift = 0.09 dB

Peak SAR (extrapolated) = 0.786 W/kg

SAR(1 g) = 0.425 mW/g; SAR(10 g) = 0.212 mW/g

Maximum value of SAR (measured) = 0.476 mW/g

Ch512/Zoom Scan (5x5x7)/Cube 1: Measurement grid: dx=8mm, dy=8mm, dz=5mm

Reference Value = 16.087 V/m; Power Drift = 0.09 dB

Peak SAR (extrapolated) = 0.538 W/kg

SAR(1 g) = 0.336 mW/g; SAR(10 g) = 0.195 mW/g

Maximum value of SAR (measured) = 0.363 mW/g

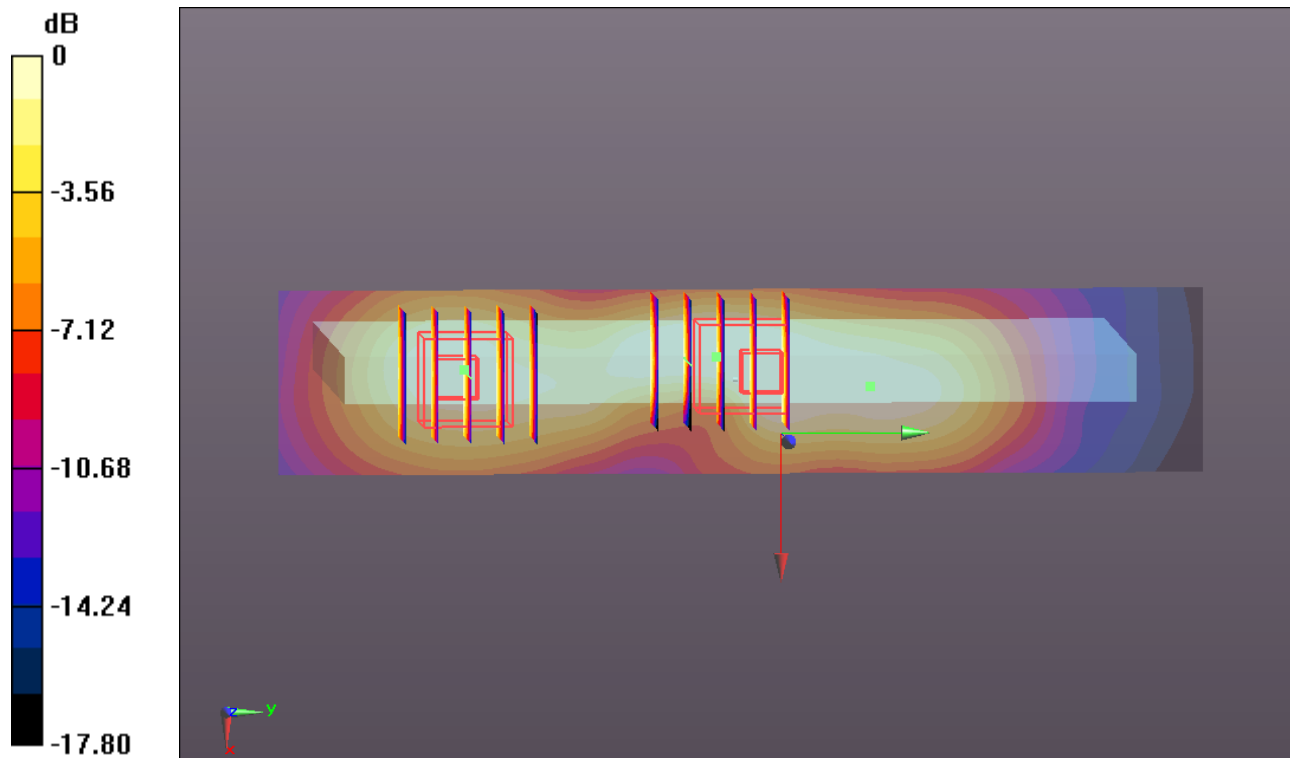

0 dB = 0.360mW/g

#14 GSM1900_GPRS12_Primary Portrait_Right Corner at 6 degree_sensor off_Ch512

DUT: 262503

Communication System: GPRS/EDGE 12; Frequency: 1850.2 MHz; Duty Cycle: 1:2

Medium: MSL_1900_120811 Medium parameters used: $f = 1850.2$ MHz; $\sigma = 1.472$ mho/m; $\epsilon_r =$

54.669 ; $\rho = 1000$ kg/m³

Ambient Temperature : 23.2 °C ; Liquid Temperature : 21.2 °C

DASY5 Configuration:

- Probe: EX3DV4 - SN3857; ConvF(7.35, 7.35, 7.35); Calibrated: 2012-6-20
- Sensor-Surface: 4mm (Mechanical Surface Detection)
- Electronics: DAE4 Sn1210; Calibrated: 2011-11-18
- Phantom: SAM3; Type: SAM; Serial: TP-1079
- Measurement SW: DASY52, Version 52.8 (0); SEMCAD X Version 14.4.5 (3634)

Ch512/Area Scan (31x151x1): Measurement grid: dx=15mm, dy=15mm

Maximum value of SAR (interpolated) = 1.035 mW/g

Ch512/Zoom Scan (5x5x7)/Cube 0: Measurement grid: dx=8mm, dy=8mm, dz=5mm

Reference Value = 11.283 V/m; Power Drift = -0.02 dB

Peak SAR (extrapolated) = 1.517 W/kg

SAR(1 g) = 0.849 mW/g; SAR(10 g) = 0.438 mW/g

Maximum value of SAR (measured) = 0.956 mW/g

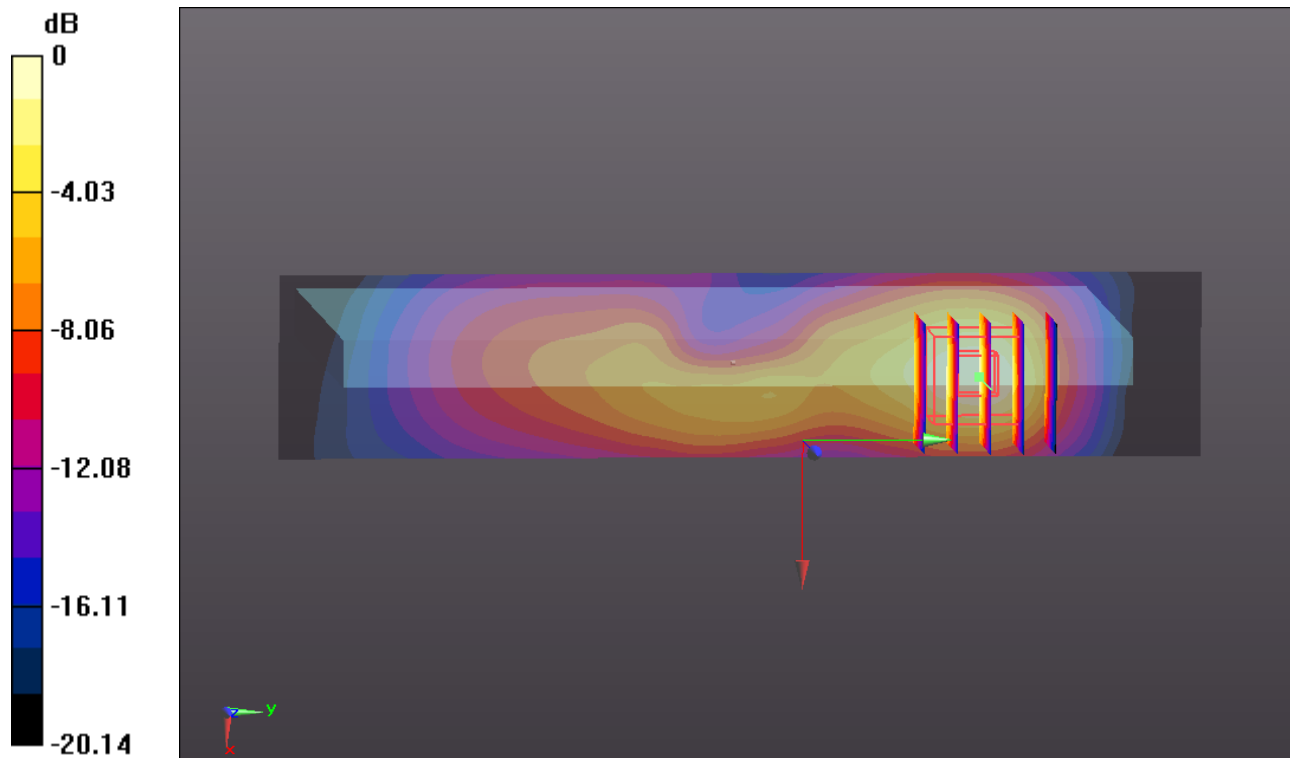

0 dB = 0.960mW/g

#15 GSM1900_GPRS12_Primary Portrait_Right Corner at 6 degree_sensor off_Ch661

DUT: 262503

Communication System: GPRS/EDGE 12; Frequency: 1880 MHz; Duty Cycle: 1:2

Medium: MSL_1900_120811 Medium parameters used: $f = 1880$ MHz; $\sigma = 1.513$ mho/m; $\epsilon_r =$

54.594; $\rho = 1000$ kg/m³

Ambient Temperature : 23.2 °C ; Liquid Temperature : 21.2 °C

DASY5 Configuration:

- Probe: EX3DV4 - SN3857; ConvF(7.35, 7.35, 7.35); Calibrated: 2012-6-20

- Sensor-Surface: 4mm (Mechanical Surface Detection)

- Electronics: DAE4 Sn1210; Calibrated: 2011-11-18

- Phantom: SAM3; Type: SAM; Serial: TP-1079

- Measurement SW: DASY52, Version 52.8 (0); SEMCAD X Version 14.4.5 (3634)

Ch661/Area Scan (31x151x1): Measurement grid: dx=15mm, dy=15mm

Maximum value of SAR (interpolated) = 1.240 mW/g

Ch661/Zoom Scan (5x5x7)/Cube 0: Measurement grid: dx=8mm, dy=8mm, dz=5mm

Reference Value = 14.663 V/m; Power Drift = -0.04 dB

Peak SAR (extrapolated) = 1.765 W/kg

SAR(1 g) = 1.01 mW/g; SAR(10 g) = 0.506 mW/g

Maximum value of SAR (measured) = 1.169 mW/g

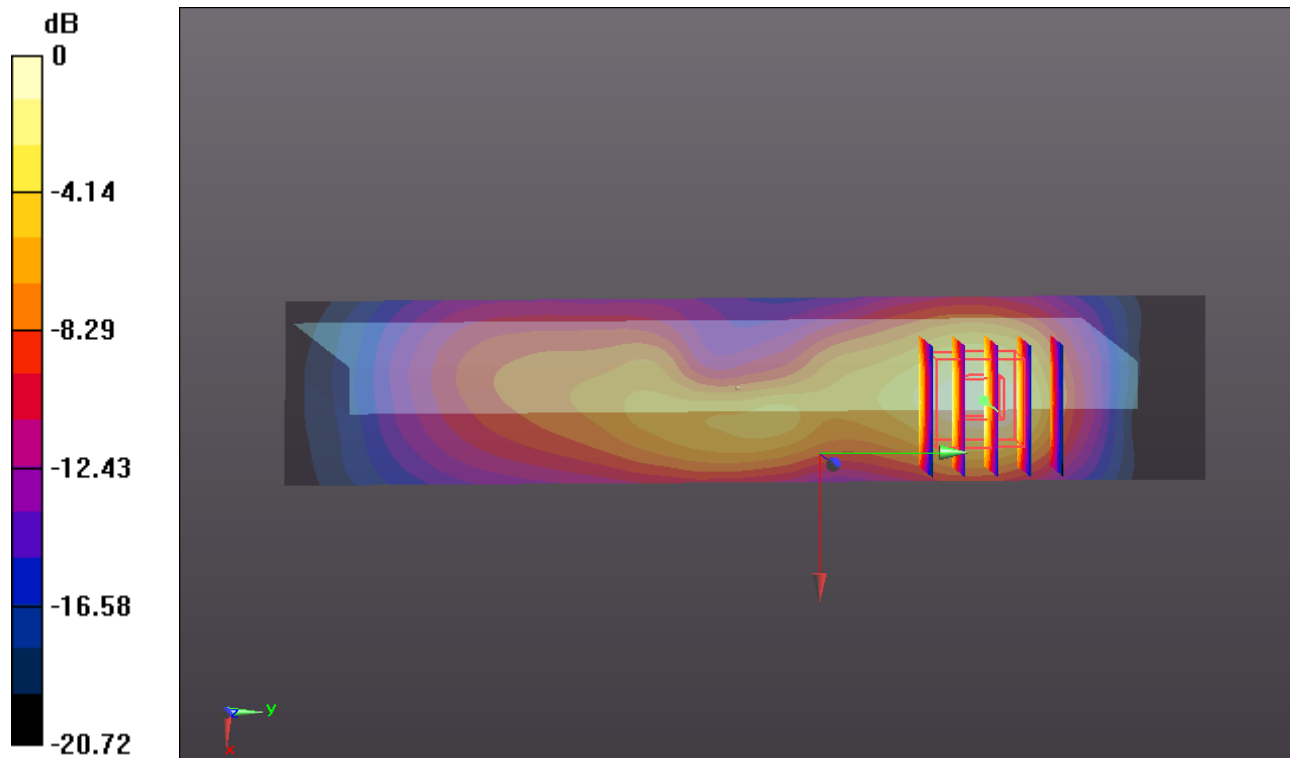

0 dB = 1.170mW/g

#15 GSM1900_GPRS12_Primary Portrait_Right Corner at 6 degree_sensor off_Ch661_2D

DUT: 262503

Communication System: GPRS/EDGE 12; Frequency: 1880 MHz; Duty Cycle: 1:2

Medium: MSL_1900_120811 Medium parameters used: $f = 1880$ MHz; $\sigma = 1.513$ mho/m; $\epsilon_r =$

54.594; $\rho = 1000$ kg/m³

Ambient Temperature : 23.2 °C ; Liquid Temperature : 21.2 °C

DASY5 Configuration:

- Probe: EX3DV4 - SN3857; ConvF(7.35, 7.35, 7.35); Calibrated: 2012-6-20
- Sensor-Surface: 4mm (Mechanical Surface Detection)
- Electronics: DAE4 Sn1210; Calibrated: 2011-11-18
- Phantom: SAM3; Type: SAM; Serial: TP-1079
- Measurement SW: DASY52, Version 52.8 (0); SEMCAD X Version 14.4.5 (3634)

Ch661/Area Scan (31x151x1): Measurement grid: dx=15mm, dy=15mm

Maximum value of SAR (interpolated) = 1.240 mW/g

Ch661/Zoom Scan (5x5x7)/Cube 0: Measurement grid: dx=8mm, dy=8mm, dz=5mm

Reference Value = 14.663 V/m; Power Drift = -0.04 dB

Peak SAR (extrapolated) = 1.765 W/kg

SAR(1 g) = 1.01 mW/g; SAR(10 g) = 0.506 mW/g

Maximum value of SAR (measured) = 1.169 mW/g

1g/10g Averaged SAR

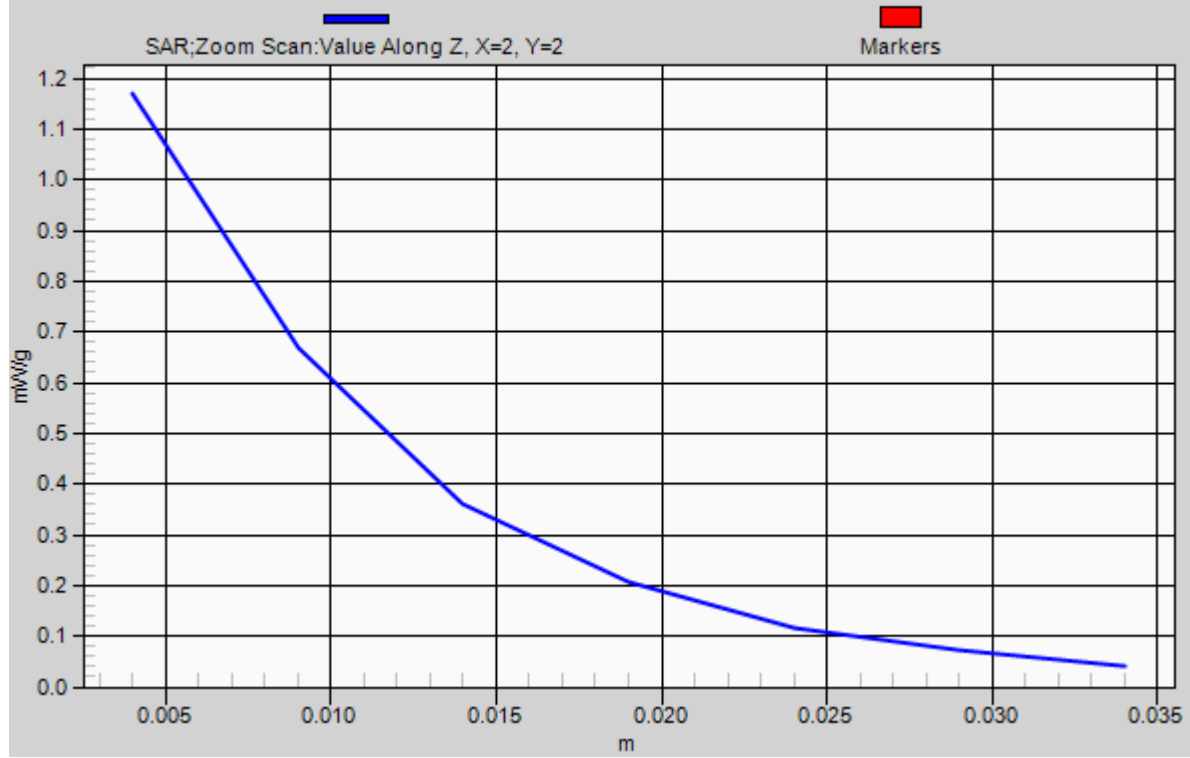

#16 GSM1900_GPRS12_Primary Portrait_Right Corner at 6 degree_sensor off_Ch810

DUT: 262503

Communication System: GPRS/EDGE 12; Frequency: 1909.8 MHz; Duty Cycle: 1:2
Medium: MSL_1900_120811 Medium parameters used: $f = 1910$ MHz; $\sigma = 1.544$ mho/m; $\epsilon_r = 54.546$; $\rho = 1000$ kg/m³
Ambient Temperature : 23.2 °C; Liquid Temperature : 21.2 °C

DASY5 Configuration:

- Probe: EX3DV4 - SN3857; ConvF(7.35, 7.35, 7.35); Calibrated: 2012-6-20
- Sensor-Surface: 4mm (Mechanical Surface Detection)
- Electronics: DAE4 Sn1210; Calibrated: 2011-11-18
- Phantom: SAM3; Type: SAM; Serial: TP-1079
- Measurement SW: DASY52, Version 52.8 (0); SEMCAD X Version 14.4.5 (3634)

Ch810/Area Scan (31x151x1): Measurement grid: dx=15mm, dy=15mm

Maximum value of SAR (interpolated) = 1.230 mW/g

Ch810/Zoom Scan (5x5x7)/Cube 0: Measurement grid: dx=8mm, dy=8mm, dz=5mm

Reference Value = 17.029 V/m; Power Drift = -0.08 dB

Peak SAR (extrapolated) = 1.806 W/kg

SAR(1 g) = 0.997 mW/g; SAR(10 g) = 0.505 mW/g

Maximum value of SAR (measured) = 1.127 mW/g

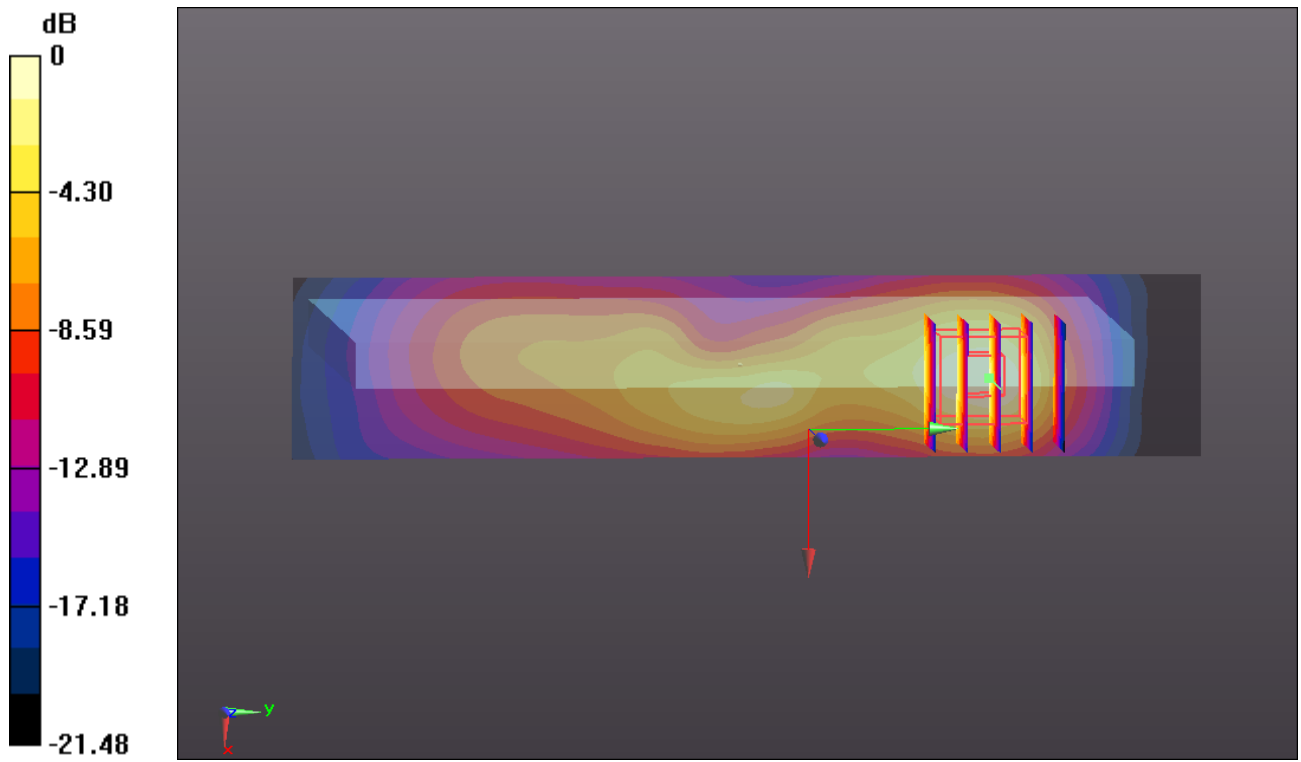

0 dB = 1.130mW/g

#46 GSM1900_GPRS12_Primary Portrait_Left Corner at 32 degree _sensor off_Ch512

DUT: 262503

Communication System: GPRS/EDGE 12; Frequency: 1850.2 MHz; Duty Cycle: 1:2

Medium: MSL_1900_120811 Medium parameters used: $f = 1850.2$ MHz; $\sigma = 1.472$ mho/m; $\epsilon_r =$

54.669 ; $\rho = 1000$ kg/m³

Ambient Temperature : 23.2 °C; Liquid Temperature : 21.2 °C

DASY5 Configuration:

- Probe: EX3DV4 - SN3857; ConvF(7.35, 7.35, 7.35); Calibrated: 2012-6-20
- Sensor-Surface: 4mm (Mechanical Surface Detection)
- Electronics: DAE4 Sn1210; Calibrated: 2011-11-18
- Phantom: SAM3; Type: SAM; Serial: TP-1079
- Measurement SW: DASY52, Version 52.8 (0); SEMCAD X Version 14.4.5 (3634)

Ch512/Area Scan (31x151x1): Measurement grid: dx=15mm, dy=15mm

Maximum value of SAR (interpolated) = 0.093 mW/g

Ch512/Zoom Scan (5x5x7)/Cube 0: Measurement grid: dx=8mm, dy=8mm, dz=5mm

Reference Value = 7.781 V/m; Power Drift = -0.14 dB

Peak SAR (extrapolated) = 0.140 W/kg

SAR(1 g) = 0.088 mW/g; SAR(10 g) = 0.053 mW/g

Maximum value of SAR (measured) = 0.094 mW/g

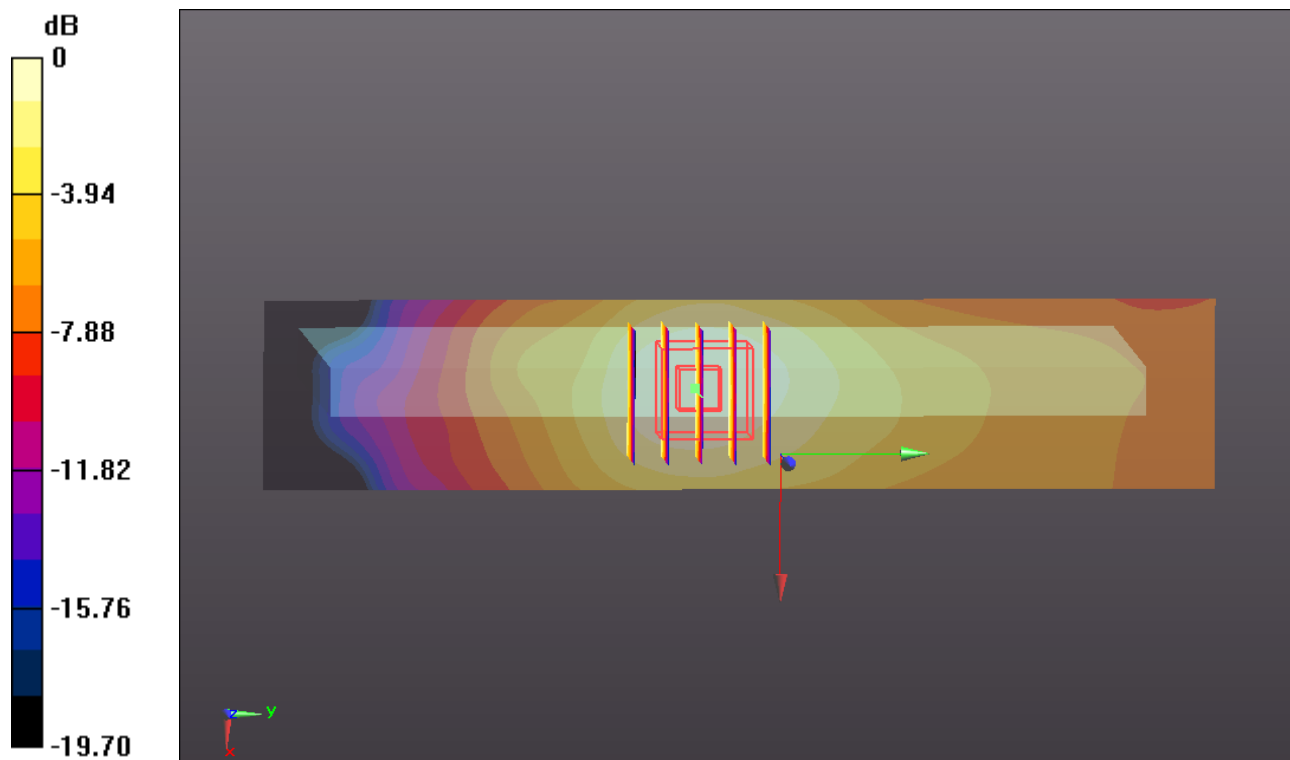

#19 WCDMA V_RMC12.2K_Bottom Face_0cm_sensor on_Ch4132

DUT: 262503

Communication System: UMTS; Frequency: 826.4 MHz; Duty Cycle: 1:1

Medium: MSL_835_120716 Medium parameters used: $f = 826.4$ MHz; $\sigma = 0.959$ mho/m; $\epsilon_r =$

55.476 ; $\rho = 1000$ kg/m³

Ambient Temperature : 23.1 °C ; Liquid Temperature : 21.2 °C

DASY5 Configuration:

- Probe: EX3DV4 - SN3697; ConvF(8.67, 8.67, 8.67); Calibrated: 2011-9-2
- Sensor-Surface: 4mm (Mechanical Surface Detection)
- Electronics: DAE4 Sn1210; Calibrated: 2011-11-18
- Phantom: SAM3; Type: SAM; Serial: TP-1079
- Measurement SW: DASY52, Version 52.8 (0); SEMCAD X Version 14.4.5 (3634)

Ch4132/Area Scan (101x151x1): Measurement grid: dx=15mm, dy=15mm

Maximum value of SAR (interpolated) = 1.102 mW/g

Ch4132/Zoom Scan (5x5x7)/Cube 0: Measurement grid: dx=8mm, dy=8mm, dz=5mm

Reference Value = 10.297 V/m; Power Drift = 0.15 dB

Peak SAR (extrapolated) = 2.032 W/kg

SAR(1 g) = 1.08 mW/g; SAR(10 g) = 0.603 mW/g

Maximum value of SAR (measured) = 1.202 mW/g

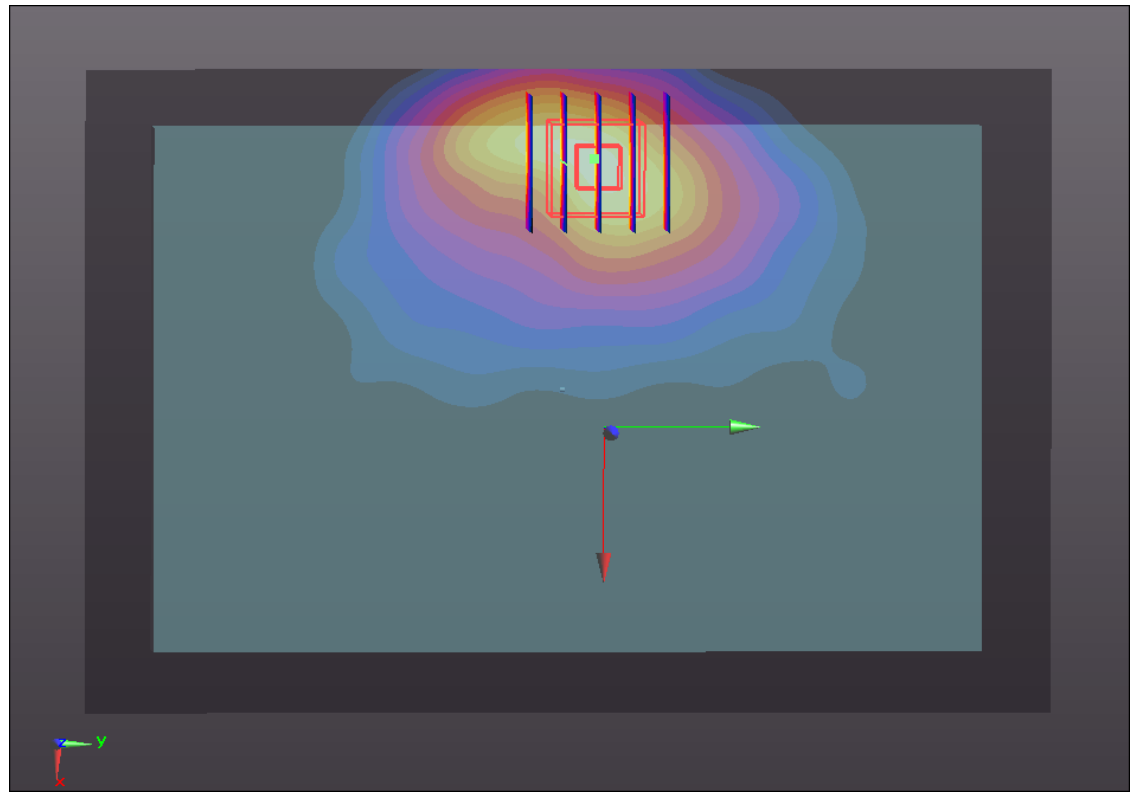
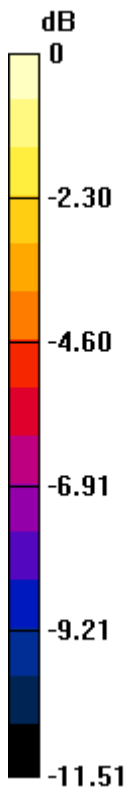

0 dB = 1.200mW/g

#19 WCDMA V_RMC12.2K_Bottom Face_0cm_sensor on_Ch4132_2D

DUT: 262503

Communication System: UMTS; Frequency: 826.4 MHz; Duty Cycle: 1:1

Medium: MSL_835_120716 Medium parameters used: $f = 826.4$ MHz; $\sigma = 0.959$ mho/m; $\epsilon_r =$

55.476 ; $\rho = 1000$ kg/m³

Ambient Temperature : 23.1 °C ; Liquid Temperature : 21.2 °C

DASY5 Configuration:

- Probe: EX3DV4 - SN3697; ConvF(8.67, 8.67, 8.67); Calibrated: 2011-9-2
- Sensor-Surface: 4mm (Mechanical Surface Detection)
- Electronics: DAE4 Sn1210; Calibrated: 2011-11-18
- Phantom: SAM3; Type: SAM; Serial: TP-1079
- Measurement SW: DASY52, Version 52.8 (0); SEMCAD X Version 14.4.5 (3634)

Ch4132/Area Scan (101x151x1): Measurement grid: dx=15mm, dy=15mm

Maximum value of SAR (interpolated) = 1.102 mW/g

Ch4132/Zoom Scan (5x5x7)/Cube 0: Measurement grid: dx=8mm, dy=8mm, dz=5mm

Reference Value = 10.297 V/m; Power Drift = 0.15 dB

Peak SAR (extrapolated) = 2.032 W/kg

SAR(1 g) = 1.08 mW/g; SAR(10 g) = 0.603 mW/g

Maximum value of SAR (measured) = 1.202 mW/g

1g/10g Averaged SAR

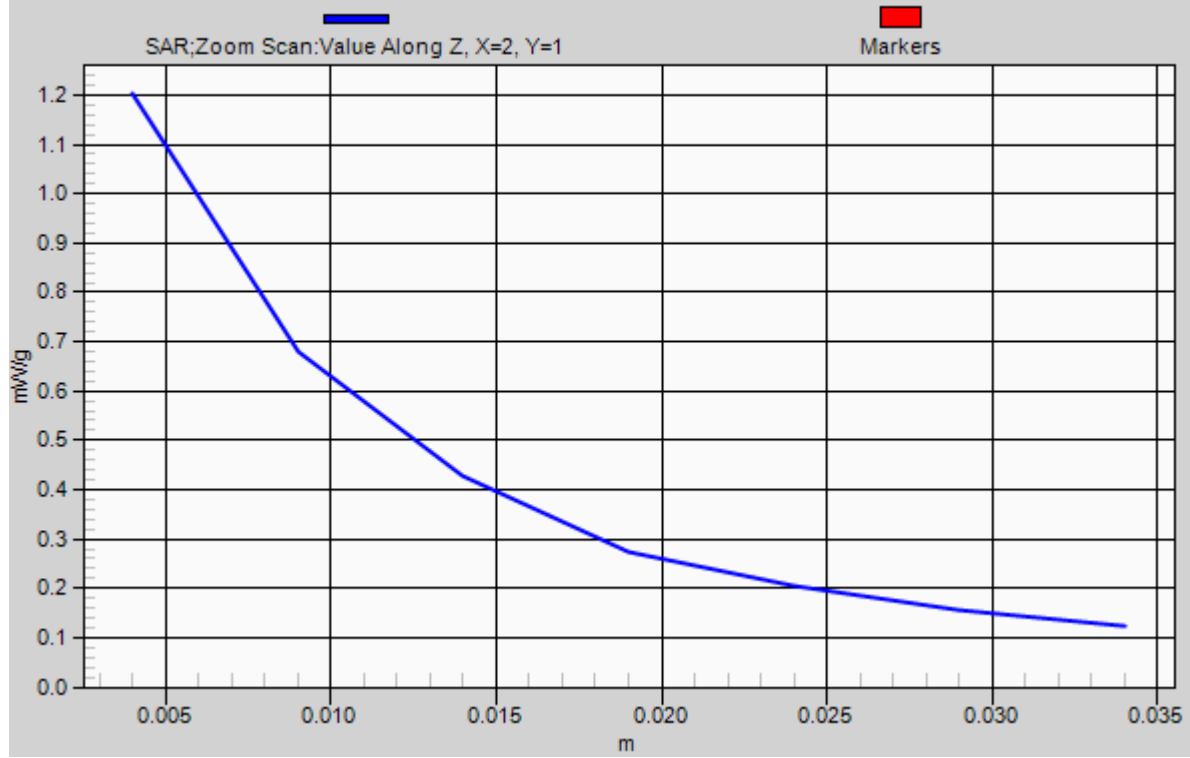

#24 WCDMA V_RMC12.2K_Bottom Face_0cm_sensor on_Ch4182

DUT: 262503

Communication System: UMTS; Frequency: 836.4 MHz; Duty Cycle: 1:1

Medium: MSL_835_120716 Medium parameters used: $f = 836.4$ MHz; $\sigma = 0.968$ mho/m; $\epsilon_r =$

55.391 ; $\rho = 1000$ kg/m³

Ambient Temperature : 23.1 °C; Liquid Temperature : 21.2 °C

DASY5 Configuration:

- Probe: EX3DV4 - SN3697; ConvF(8.67, 8.67, 8.67); Calibrated: 2011-9-2
- Sensor-Surface: 4mm (Mechanical Surface Detection)
- Electronics: DAE4 Sn1210; Calibrated: 2011-11-18
- Phantom: SAM3; Type: SAM; Serial: TP-1079
- Measurement SW: DASY52, Version 52.8 (0); SEMCAD X Version 14.4.5 (3634)

Ch4182/Area Scan (101x151x1): Measurement grid: dx=15mm, dy=15mm

Maximum value of SAR (interpolated) = 1.110 mW/g

Ch4182/Zoom Scan (5x5x7)/Cube 0: Measurement grid: dx=8mm, dy=8mm, dz=5mm

Reference Value = 10.159 V/m; Power Drift = 0.12 dB

Peak SAR (extrapolated) = 1.984 W/kg

SAR(1 g) = 1.06 mW/g; SAR(10 g) = 0.595 mW/g

Maximum value of SAR (measured) = 1.194 mW/g

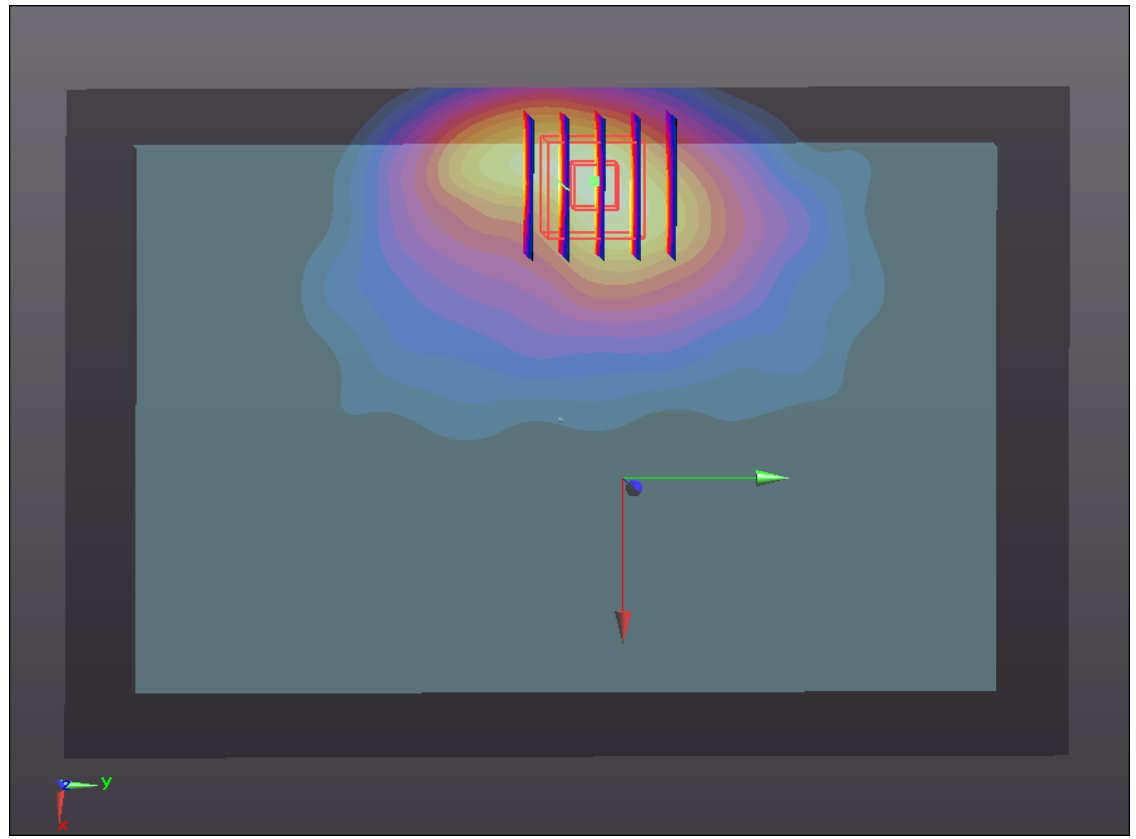
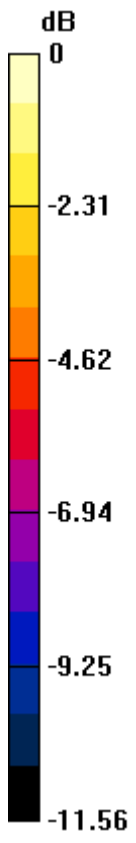

0 dB = 1.190mW/g

#25 WCDMA V_RMC12.2K_Bottom Face_0cm_sensor on_Ch4233

DUT: 262503

Communication System: UMTS; Frequency: 846.6 MHz; Duty Cycle: 1:1

Medium: MSL_835_120716 Medium parameters used: $f = 847$ MHz; $\sigma = 0.979$ mho/m; $\epsilon_r = 55.296$;

$\rho = 1000$ kg/m³

Ambient Temperature : 23.1 °C; Liquid Temperature : 21.2 °C

DASY5 Configuration:

- Probe: EX3DV4 - SN3697; ConvF(8.67, 8.67, 8.67); Calibrated: 2011-9-2
- Sensor-Surface: 4mm (Mechanical Surface Detection)
- Electronics: DAE4 Sn1210; Calibrated: 2011-11-18
- Phantom: SAM3; Type: SAM; Serial: TP-1079
- Measurement SW: DASY52, Version 52.8 (0); SEMCAD X Version 14.4.5 (3634)

Ch4233/Area Scan (101x151x1): Measurement grid: dx=15mm, dy=15mm

Maximum value of SAR (interpolated) = 1.061 mW/g

Ch4233/Zoom Scan (5x5x7)/Cube 0: Measurement grid: dx=8mm, dy=8mm, dz=5mm

Reference Value = 9.912 V/m; Power Drift = 0.03 dB

Peak SAR (extrapolated) = 1.900 W/kg

SAR(1 g) = 1.02 mW/g; SAR(10 g) = 0.572 mW/g

Maximum value of SAR (measured) = 1.148 mW/g

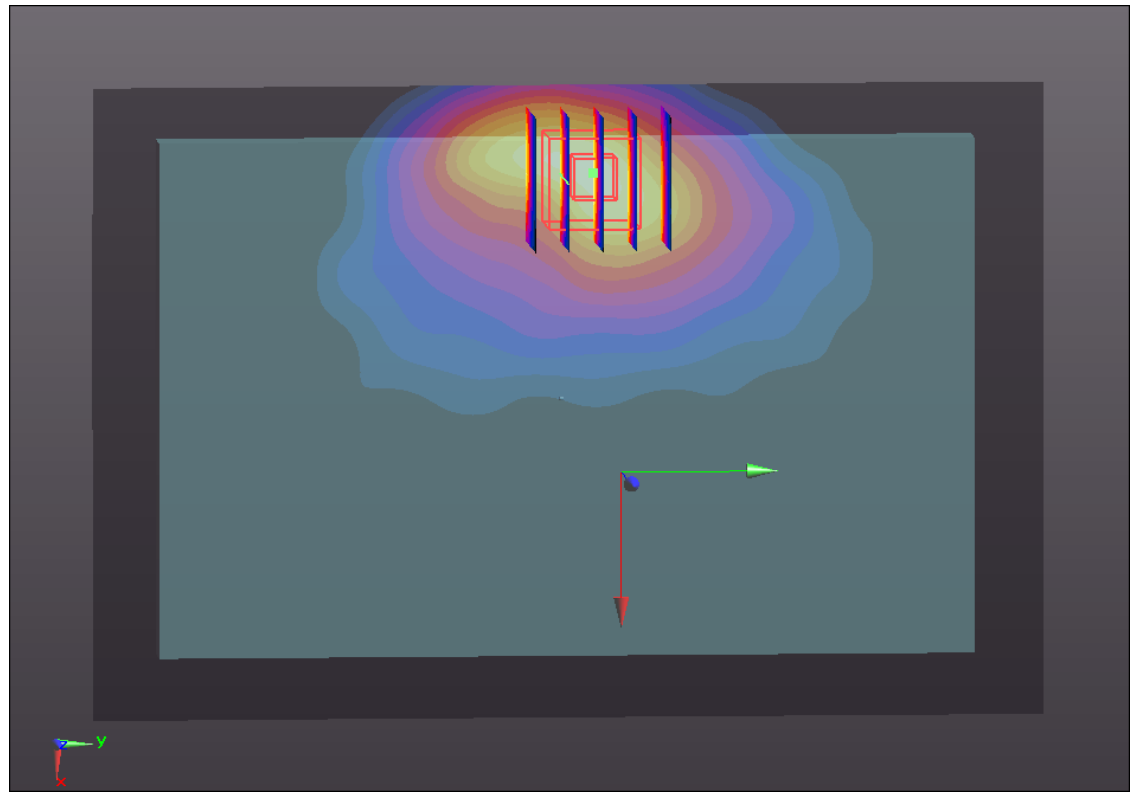
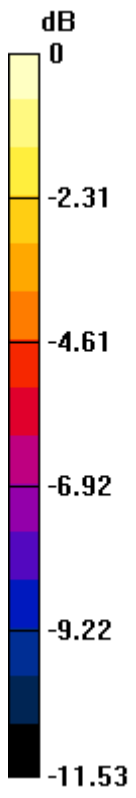

0 dB = 1.150mW/g

#20 WCDMA V_RMC12.2K_RMC12.2K_Primary Portrait_0cm_sensor on_Ch4132

DUT: 262503

Communication System: UMTS; Frequency: 826.4 MHz; Duty Cycle: 1:1

Medium: MSL_835_120716 Medium parameters used: $f = 826.4$ MHz; $\sigma = 0.959$ mho/m; $\epsilon_r =$

55.476 ; $\rho = 1000$ kg/m³

Ambient Temperature : 23.1 °C; Liquid Temperature : 21.2 °C

DASY5 Configuration:

- Probe: EX3DV4 - SN3697; ConvF(8.67, 8.67, 8.67); Calibrated: 2011-9-2
- Sensor-Surface: 4mm (Mechanical Surface Detection)
- Electronics: DAE4 Sn1210; Calibrated: 2011-11-18
- Phantom: SAM3; Type: SAM; Serial: TP-1079
- Measurement SW: DASY52, Version 52.8 (0); SEMCAD X Version 14.4.5 (3634)

Ch4132/Area Scan (31x151x1): Measurement grid: dx=15mm, dy=15mm

Maximum value of SAR (interpolated) = 0.824 mW/g

Ch4132/Zoom Scan (5x5x7)/Cube 0: Measurement grid: dx=8mm, dy=8mm, dz=5mm

Reference Value = 27.880 V/m; Power Drift = -0.01 dB

Peak SAR (extrapolated) = 1.376 W/kg

SAR(1 g) = 0.753 mW/g; SAR(10 g) = 0.430 mW/g

Maximum value of SAR (measured) = 0.831 mW/g

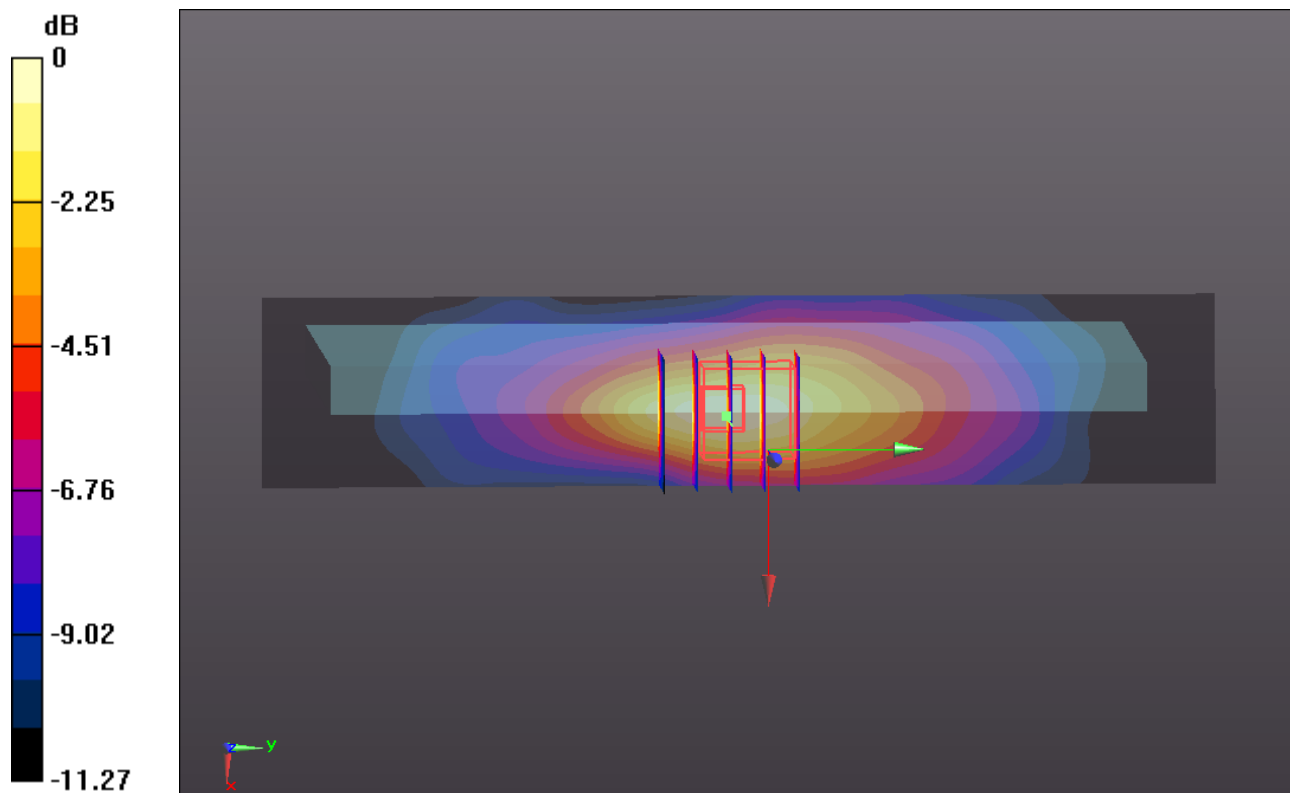

0 dB = 0.830mW/g

#21 WCDMA V_RMC12.2K_Bottom Face_0.9cm_sensor off_Ch4132

DUT: 262503

Communication System: UMTS; Frequency: 826.4 MHz; Duty Cycle: 1:1

Medium: MSL_835_120716 Medium parameters used: $f = 826.4$ MHz; $\sigma = 0.959$ mho/m; $\epsilon_r =$

55.476 ; $\rho = 1000$ kg/m³

Ambient Temperature : 23.1 °C; Liquid Temperature : 21.2 °C

DASY5 Configuration:

- Probe: EX3DV4 - SN3697; ConvF(8.67, 8.67, 8.67); Calibrated: 2011-9-2
- Sensor-Surface: 4mm (Mechanical Surface Detection)
- Electronics: DAE4 Sn1210; Calibrated: 2011-11-18
- Phantom: SAM3; Type: SAM; Serial: TP-1079
- Measurement SW: DASY52, Version 52.8 (0); SEMCAD X Version 14.4.5 (3634)

Ch4132/Area Scan (101x151x1): Measurement grid: dx=15mm, dy=15mm

Maximum value of SAR (interpolated) = 0.962 mW/g

Ch4132/Zoom Scan (5x5x7)/Cube 0: Measurement grid: dx=8mm, dy=8mm, dz=5mm

Reference Value = 14.292 V/m; Power Drift = -0.02 dB

Peak SAR (extrapolated) = 1.408 W/kg

SAR(1 g) = 0.893 mW/g; SAR(10 g) = 0.562 mW/g

Maximum value of SAR (measured) = 0.953 mW/g

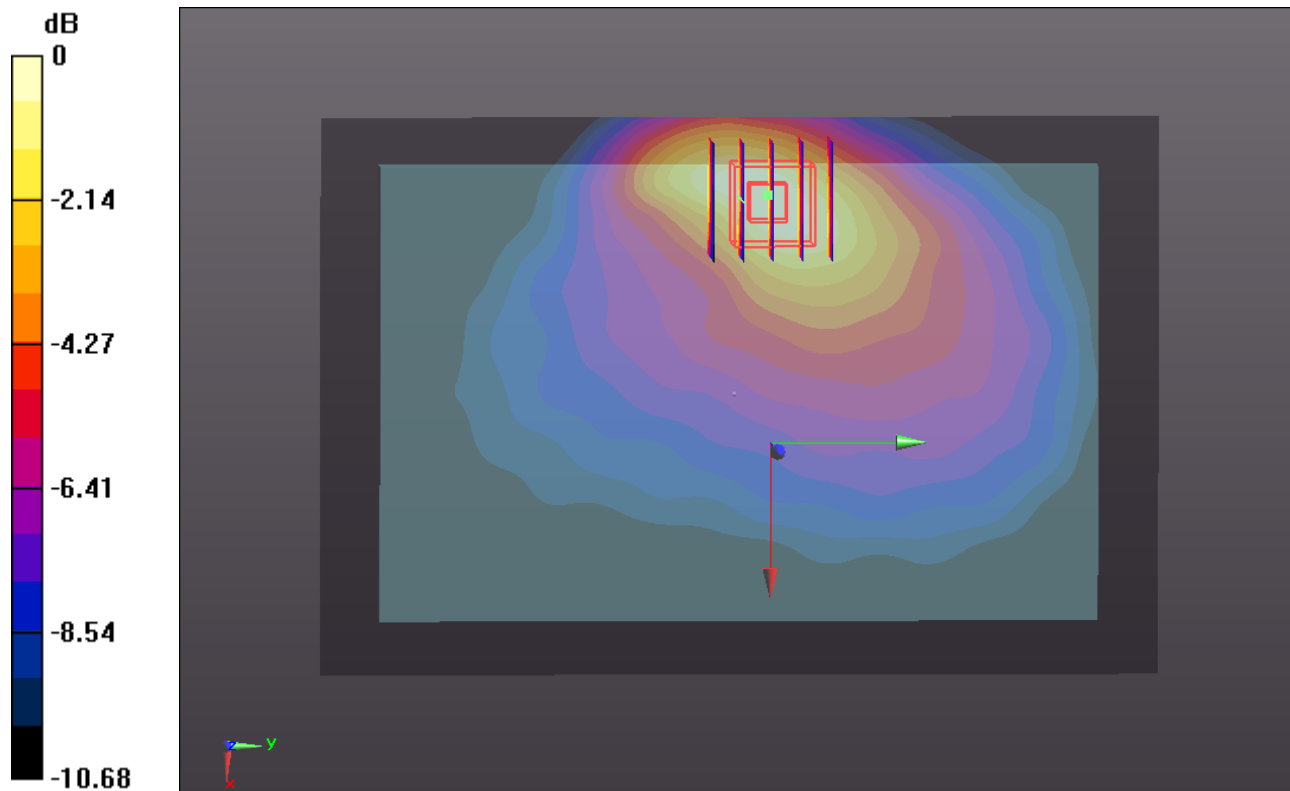

0 dB = 0.950mW/g

#26 WCDMA V_RMC12.2K_Bottom Face_0.9cm_sensor off_Ch4182

DUT: 262503

Communication System: UMTS; Frequency: 836.4 MHz; Duty Cycle: 1:1

Medium: MSL_835_120716 Medium parameters used: $f = 836.4$ MHz; $\sigma = 0.968$ mho/m; $\epsilon_r =$

55.391 ; $\rho = 1000$ kg/m³

Ambient Temperature : 23.1 °C; Liquid Temperature : 21.2 °C

DASY5 Configuration:

- Probe: EX3DV4 - SN3697; ConvF(8.67, 8.67, 8.67); Calibrated: 2011-9-2
- Sensor-Surface: 4mm (Mechanical Surface Detection)
- Electronics: DAE4 Sn1210; Calibrated: 2011-11-18
- Phantom: SAM3; Type: SAM; Serial: TP-1079
- Measurement SW: DASY52, Version 52.8 (0); SEMCAD X Version 14.4.5 (3634)

Ch4182/Area Scan (101x151x1): Measurement grid: dx=15mm, dy=15mm

Maximum value of SAR (interpolated) = 1.106 mW/g

Ch4182/Zoom Scan (5x5x7)/Cube 0: Measurement grid: dx=8mm, dy=8mm, dz=5mm

Reference Value = 15.003 V/m; Power Drift = -0.03 dB

Peak SAR (extrapolated) = 1.621 W/kg

SAR(1 g) = 1.02 mW/g; SAR(10 g) = 0.640 mW/g

Maximum value of SAR (measured) = 1.096 mW/g

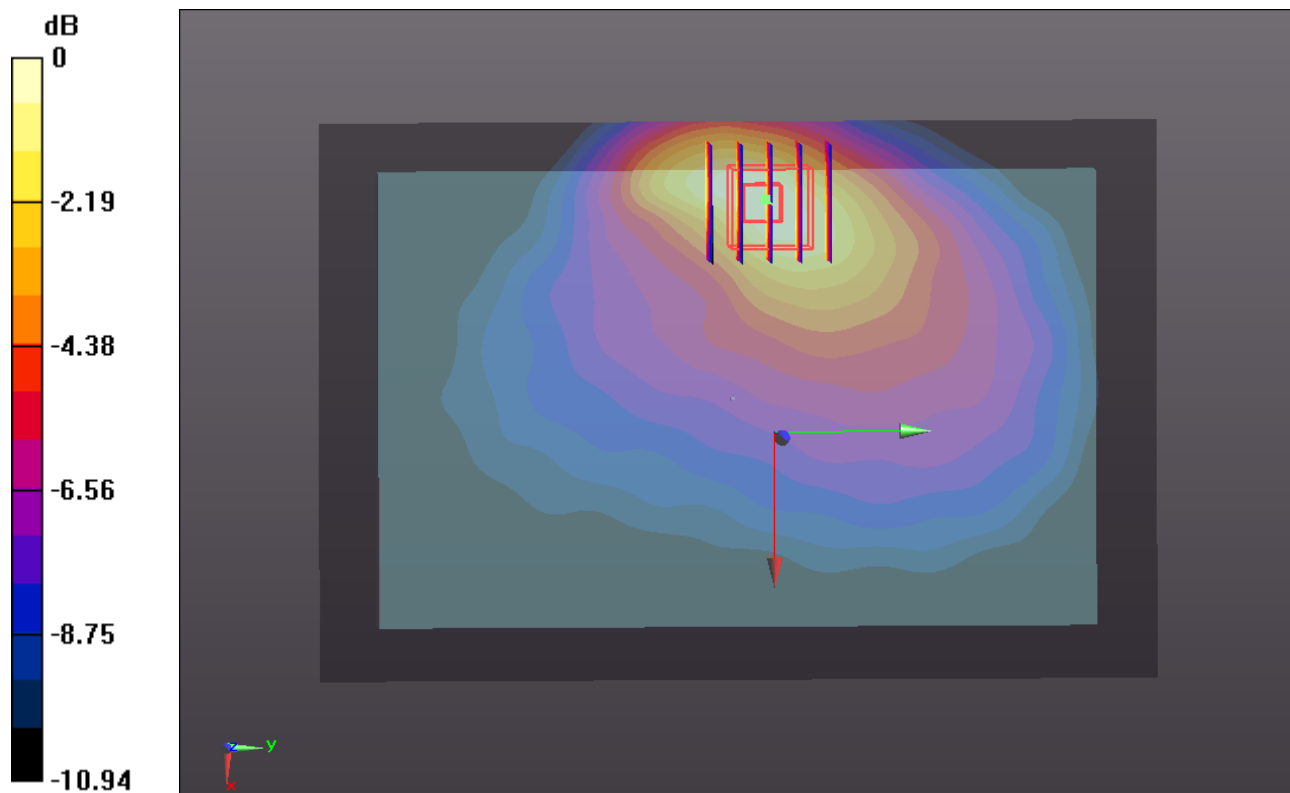

0 dB = 1.100mW/g

#27 WCDMA V_RMC12.2K_Bottom Face_0.9cm_sensor off_Ch4233

DUT: 262503

Communication System: UMTS; Frequency: 846.6 MHz; Duty Cycle: 1:1

Medium: MSL_835_120716 Medium parameters used: $f = 847$ MHz; $\sigma = 0.979$ mho/m; $\epsilon_r = 55.296$;

$\rho = 1000$ kg/m³

Ambient Temperature : 23.1 °C; Liquid Temperature : 21.2 °C

DASY5 Configuration:

- Probe: EX3DV4 - SN3697; ConvF(8.67, 8.67, 8.67); Calibrated: 2011-9-2
- Sensor-Surface: 4mm (Mechanical Surface Detection)
- Electronics: DAE4 Sn1210; Calibrated: 2011-11-18
- Phantom: SAM3; Type: SAM; Serial: TP-1079
- Measurement SW: DASY52, Version 52.8 (0); SEMCAD X Version 14.4.5 (3634)

Ch4233/Area Scan (101x151x1): Measurement grid: dx=15mm, dy=15mm

Maximum value of SAR (interpolated) = 1.102 mW/g

Ch4233/Zoom Scan (5x5x7)/Cube 0: Measurement grid: dx=8mm, dy=8mm, dz=5mm

Reference Value = 14.778 V/m; Power Drift = -0.04 dB

Peak SAR (extrapolated) = 1.612 W/kg

SAR(1 g) = 1.02 mW/g; SAR(10 g) = 0.638 mW/g

Maximum value of SAR (measured) = 1.094 mW/g

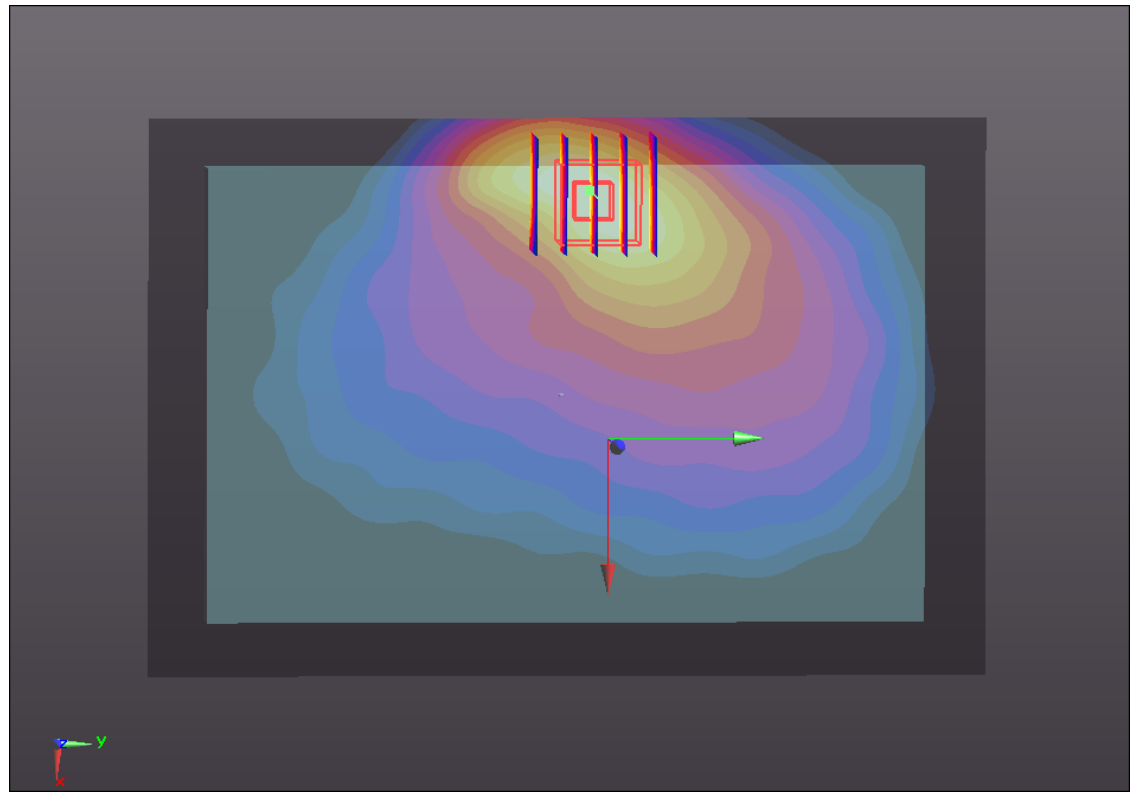
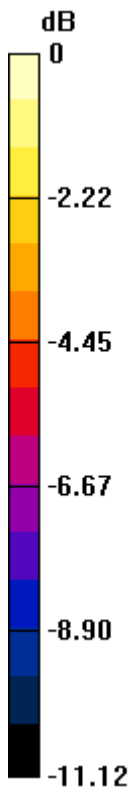

0 dB = 1.090mW/g

#22 WCDMA V_RMC12.2K_Primary Portrait_0.7cm_sensor off_Ch4132

DUT: 262503

Communication System: UMTS; Frequency: 826.4 MHz; Duty Cycle: 1:1

Medium: MSL_835_120716 Medium parameters used: $f = 826.4$ MHz; $\sigma = 0.959$ mho/m; $\epsilon_r =$

55.476 ; $\rho = 1000$ kg/m³

Ambient Temperature : 23.1 °C ; Liquid Temperature : 21.2 °C

DASY5 Configuration:

- Probe: EX3DV4 - SN3697; ConvF(8.67, 8.67, 8.67); Calibrated: 2011-9-2
- Sensor-Surface: 4mm (Mechanical Surface Detection)
- Electronics: DAE4 Sn1210; Calibrated: 2011-11-18
- Phantom: SAM3; Type: SAM; Serial: TP-1079
- Measurement SW: DASY52, Version 52.8 (0); SEMCAD X Version 14.4.5 (3634)

Ch4132/Area Scan (31x151x1): Measurement grid: dx=15mm, dy=15mm

Maximum value of SAR (interpolated) = 0.970 mW/g

Ch4132/Zoom Scan (5x5x7)/Cube 0: Measurement grid: dx=8mm, dy=8mm, dz=5mm

Reference Value = 28.917 V/m; Power Drift = -0.05 dB

Peak SAR (extrapolated) = 1.342 W/kg

SAR(1 g) = 0.857 mW/g; SAR(10 g) = 0.539 mW/g

Maximum value of SAR (measured) = 0.935 mW/g

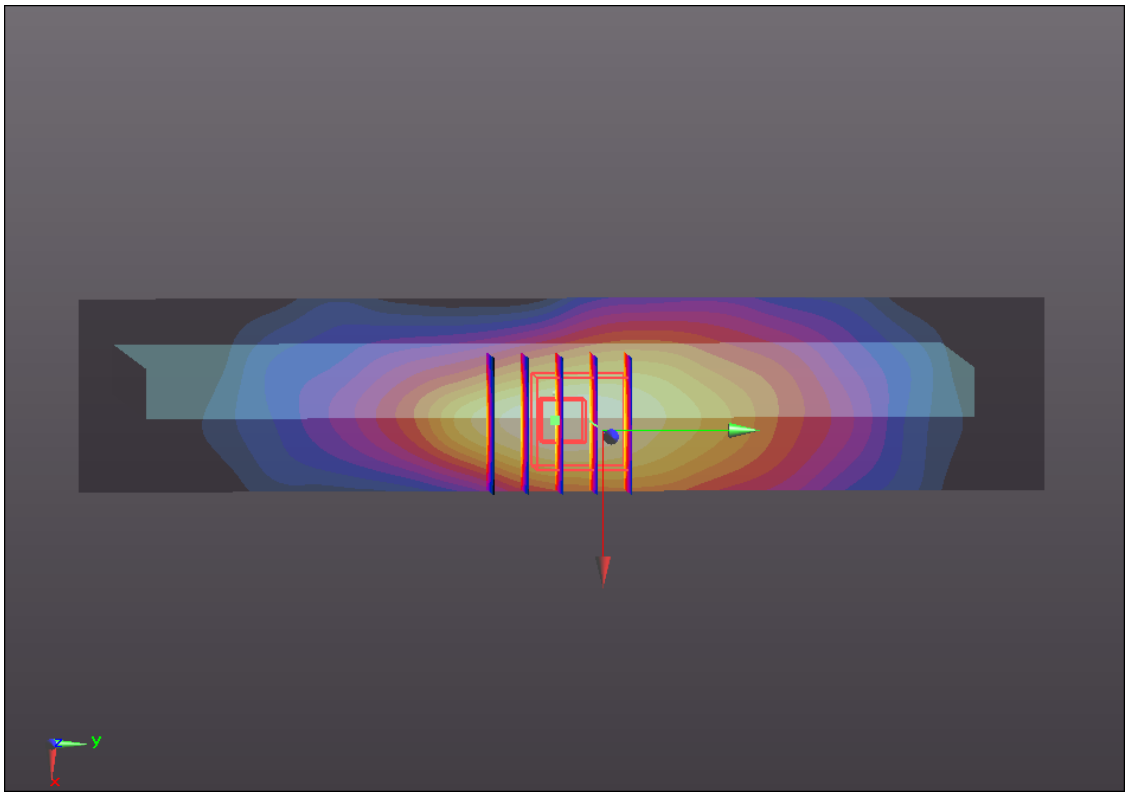
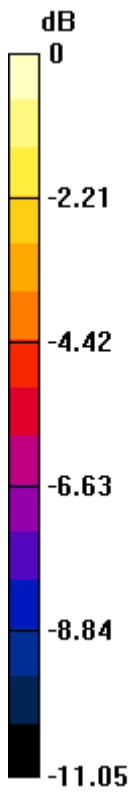

0 dB = 0.930mW/g

#28 WCDMA V_RMC12.2K_Primary Portrait_0.7cm_sensor off_Ch4182

DUT: 262503

Communication System: UMTS; Frequency: 836.4 MHz; Duty Cycle: 1:1

Medium: MSL_835_120716 Medium parameters used: $f = 836.4$ MHz; $\sigma = 0.968$ mho/m; $\epsilon_r =$

55.391 ; $\rho = 1000$ kg/m³

Ambient Temperature : 23.1 °C; Liquid Temperature : 21.2 °C

DASY5 Configuration:

- Probe: EX3DV4 - SN3697; ConvF(8.67, 8.67, 8.67); Calibrated: 2011-9-2
- Sensor-Surface: 4mm (Mechanical Surface Detection)
- Electronics: DAE4 Sn1210; Calibrated: 2011-11-18
- Phantom: SAM3; Type: SAM; Serial: TP-1079
- Measurement SW: DASY52, Version 52.8 (0); SEMCAD X Version 14.4.5 (3634)

Ch4182/Area Scan (31x151x1): Measurement grid: dx=15mm, dy=15mm

Maximum value of SAR (interpolated) = 1.060 mW/g

Ch4182/Zoom Scan (5x5x7)/Cube 0: Measurement grid: dx=8mm, dy=8mm, dz=5mm

Reference Value = 29.972 V/m; Power Drift = -0.04 dB

Peak SAR (extrapolated) = 1.482 W/kg

SAR(1 g) = 0.942 mW/g; SAR(10 g) = 0.588 mW/g

Maximum value of SAR (measured) = 1.024 mW/g

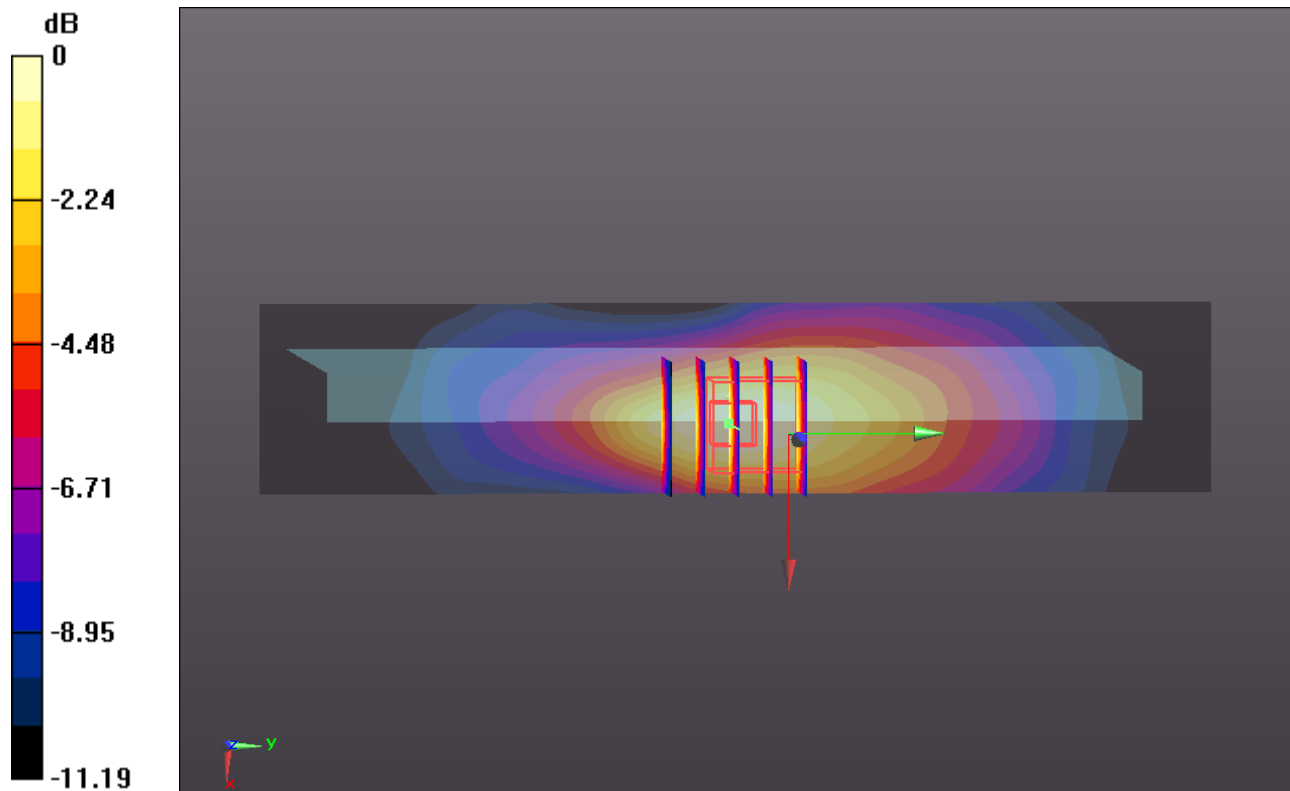

0 dB = 1.020mW/g

#29 WCDMA V_RMC12.2K_Primary Portrait_0.7cm_sensor off_Ch4233

DUT: 262503

Communication System: UMTS; Frequency: 846.6 MHz; Duty Cycle: 1:1

Medium: MSL_835_120716 Medium parameters used: $f = 847$ MHz; $\sigma = 0.979$ mho/m; $\epsilon_r = 55.296$;

$\rho = 1000$ kg/m³

Ambient Temperature : 23.1 °C ; Liquid Temperature : 21.2 °C

DASY5 Configuration:

- Probe: EX3DV4 - SN3697; ConvF(8.67, 8.67, 8.67); Calibrated: 2011-9-2
- Sensor-Surface: 4mm (Mechanical Surface Detection)
- Electronics: DAE4 Sn1210; Calibrated: 2011-11-18
- Phantom: SAM3; Type: SAM; Serial: TP-1079
- Measurement SW: DASY52, Version 52.8 (0); SEMCAD X Version 14.4.5 (3634)

Ch4233/Area Scan (31x151x1): Measurement grid: dx=15mm, dy=15mm

Maximum value of SAR (interpolated) = 1.071 mW/g

Ch4233/Zoom Scan (5x5x7)/Cube 0: Measurement grid: dx=8mm, dy=8mm, dz=5mm

Reference Value = 29.930 V/m; Power Drift = -0.04 dB

Peak SAR (extrapolated) = 1.491 W/kg

SAR(1 g) = 0.945 mW/g; SAR(10 g) = 0.588 mW/g

Maximum value of SAR (measured) = 1.028 mW/g

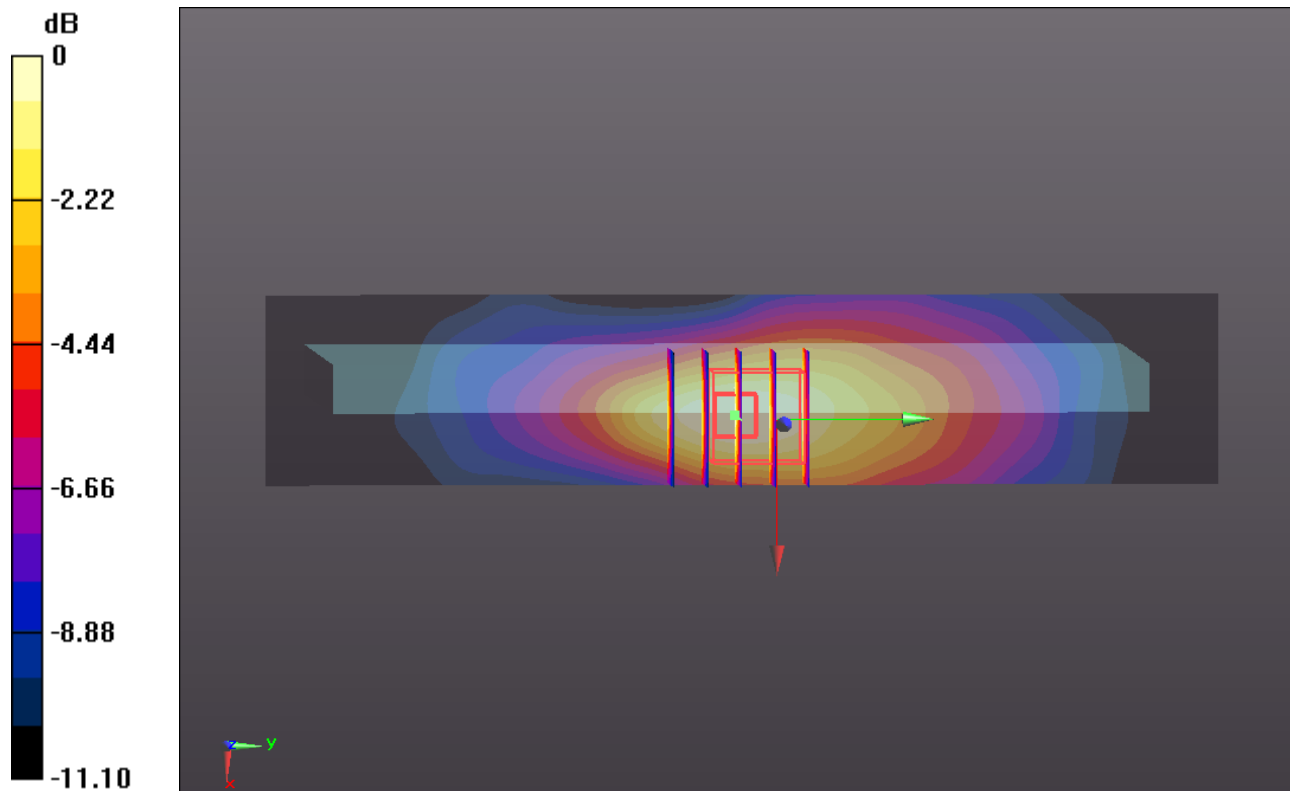

#23 WCDMA V_RMC12.2K_Primary Portrait_Right Corner at 6 degree_sensor off_Ch4132

DUT: 262503

Communication System: UMTS; Frequency: 826.4 MHz; Duty Cycle: 1:1

Medium: MSL_835_120716 Medium parameters used: $f = 826.4$ MHz; $\sigma = 0.959$ mho/m; $\epsilon_r =$

55.476 ; $\rho = 1000$ kg/m³

Ambient Temperature : 23.1 °C; Liquid Temperature : 21.2 °C

DASY5 Configuration:

- Probe: EX3DV4 - SN3697; ConvF(8.67, 8.67, 8.67); Calibrated: 2011-9-2
- Sensor-Surface: 4mm (Mechanical Surface Detection)
- Electronics: DAE4 Sn1210; Calibrated: 2011-11-18
- Phantom: SAM3; Type: SAM; Serial: TP-1079
- Measurement SW: DASY52, Version 52.8 (0); SEMCAD X Version 14.4.5 (3634)

Ch4132/Area Scan (31x151x1): Measurement grid: dx=15mm, dy=15mm

Maximum value of SAR (interpolated) = 0.703 mW/g

Ch4132/Zoom Scan (5x5x7)/Cube 0: Measurement grid: dx=8mm, dy=8mm, dz=5mm

Reference Value = 24.012 V/m; Power Drift = -0.04 dB

Peak SAR (extrapolated) = 0.930 W/kg

SAR(1 g) = 0.633 mW/g; SAR(10 g) = 0.411 mW/g

Maximum value of SAR (measured) = 0.679 mW/g

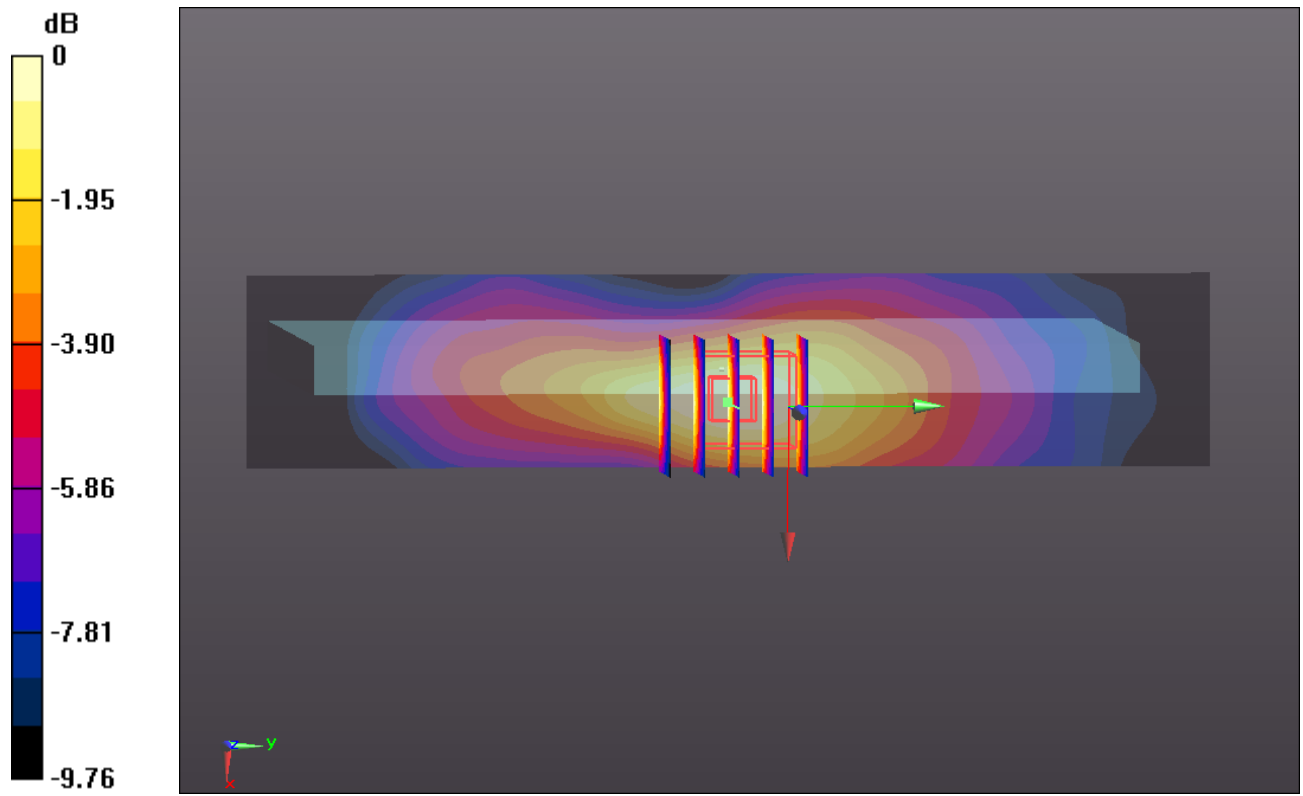

0 dB = 0.680mW/g

#47 WCDMA V_RMC12.2K_Primary Portrait_Left Corner at 32 degree_sensor off_Ch4132

DUT: 262503

Communication System: UMTS; Frequency: 826.4 MHz; Duty Cycle: 1:1

Medium: MSL_835_120730 Medium parameters used: $f = 826.4$ MHz; $\sigma = 0.968$ mho/m; $\epsilon_r =$

54.448 ; $\rho = 1000$ kg/m³

Ambient Temperature : 23.2 °C; Liquid Temperature : 21.3 °C

DASY5 Configuration:

- Probe: EX3DV4 - SN3857; ConvF(8.98, 8.98, 8.98); Calibrated: 2012-6-20
- Sensor-Surface: 4mm (Mechanical Surface Detection)
- Electronics: DAE4 Sn1210; Calibrated: 2011-11-18
- Phantom: SAM3; Type: SAM; Serial: TP-1079
- Measurement SW: DASY52, Version 52.8 (0); SEMCAD X Version 14.4.5 (3634)

Ch4132/Area Scan (31x171x1): Measurement grid: dx=15mm, dy=15mm

Maximum value of SAR (interpolated) = 0.065 mW/g

Ch4132/Zoom Scan (5x5x7)/Cube 0: Measurement grid: dx=8mm, dy=8mm, dz=5mm

Reference Value = 8.116 V/m; Power Drift = 0.0045 dB

Peak SAR (extrapolated) = 0.090 W/kg

SAR(1 g) = 0.062 mW/g; SAR(10 g) = 0.042 mW/g

Maximum value of SAR (measured) = 0.069 mW/g

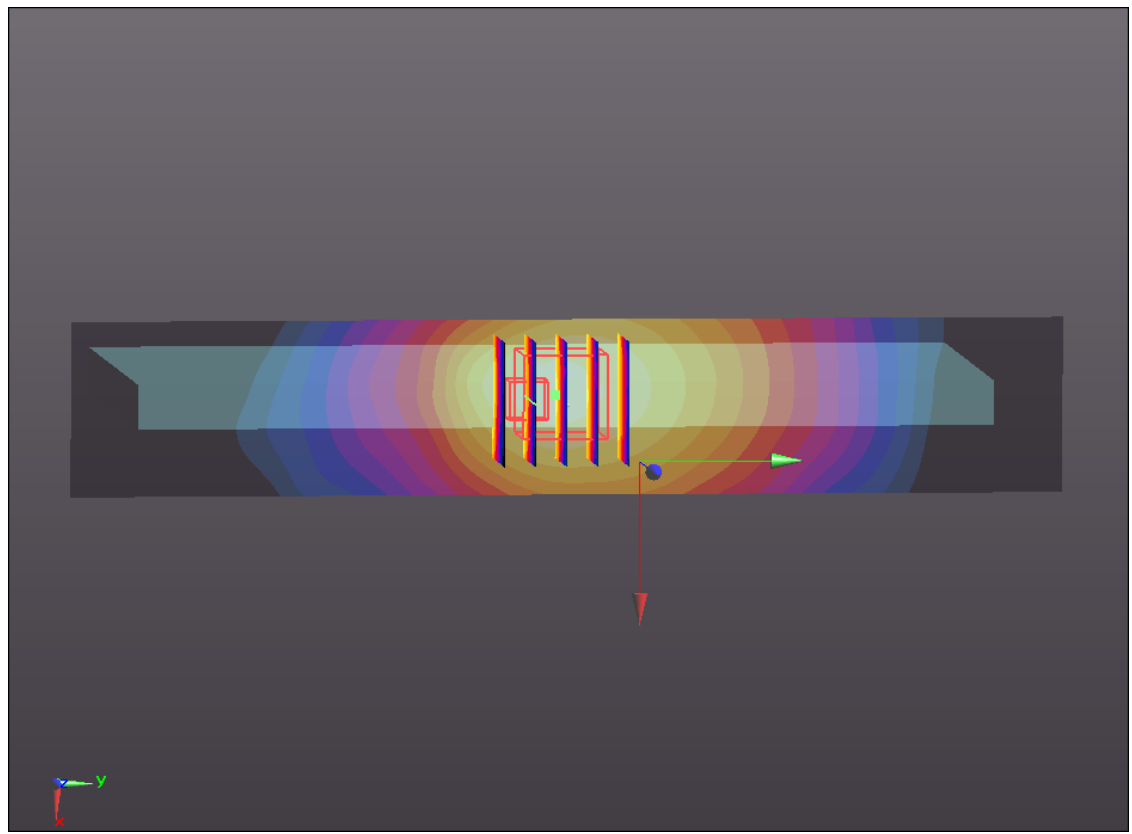
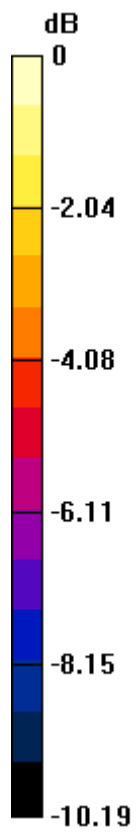

0 dB = 0.070mW/g

#30 WCDMA II_RMC12.2K_Bottom Face_0cm_sensor on_Ch9538

DUT: 262503

Communication System: UMTS; Frequency: 1907.6 MHz; Duty Cycle: 1:1

Medium: MSL_1900_120717 Medium parameters used: $f = 1908$ MHz; $\sigma = 1.555$ mho/m; $\epsilon_r =$

53.787 ; $\rho = 1000$ kg/m³

Ambient Temperature : 23.2 °C ; Liquid Temperature : 21.4 °C

DASY5 Configuration:

- Probe: EX3DV4 - SN3697; ConvF(6.96, 6.96, 6.96); Calibrated: 2011-9-2
- Sensor-Surface: 4mm (Mechanical Surface Detection)
- Electronics: DAE4 Sn1210; Calibrated: 2011-11-18
- Phantom: SAM3; Type: SAM; Serial: TP-1079
- Measurement SW: DASY52, Version 52.8 (0); SEMCAD X Version 14.4.5 (3634)

Ch9538/Area Scan (101x151x1): Measurement grid: dx=15mm, dy=15mm

Maximum value of SAR (interpolated) = 1.046 mW/g

Ch9538/Zoom Scan (5x5x7)/Cube 0: Measurement grid: dx=8mm, dy=8mm, dz=5mm

Reference Value = 8.273 V/m; Power Drift = 0.01 dB

Peak SAR (extrapolated) = 2.107 W/kg

SAR(1 g) = 0.943 mW/g; SAR(10 g) = 0.506 mW/g

Maximum value of SAR (measured) = 0.980 mW/g

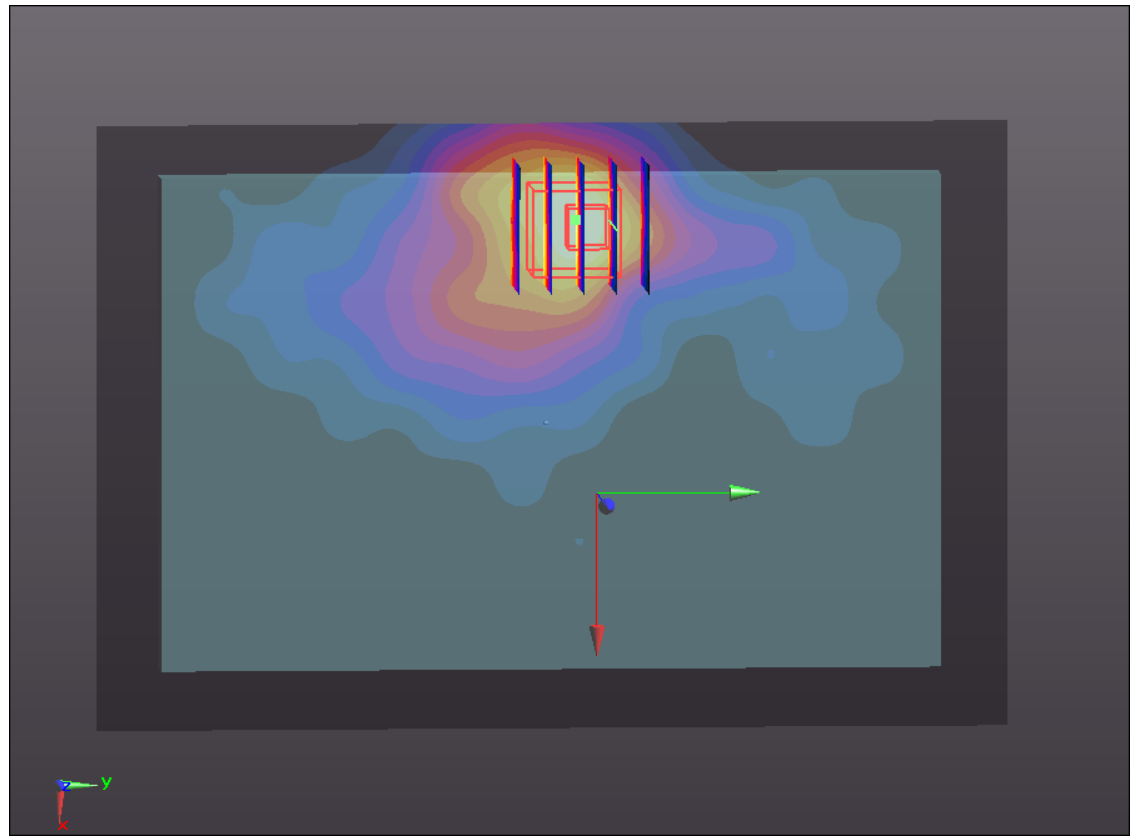
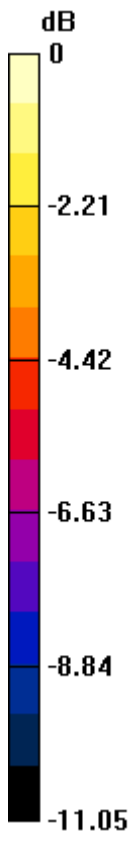

0 dB = 0.980mW/g

#35 WCDMA II_RMC12.2K_Bottom Face_0cm_sensor on_Ch9262

DUT: 262503

Communication System: UMTS; Frequency: 1852.4 MHz; Duty Cycle: 1:1

Medium: MSL_1900_120717 Medium parameters used: $f = 1852.4$ MHz; $\sigma = 1.492$ mho/m; $\epsilon_r =$

53.874 ; $\rho = 1000$ kg/m³

Ambient Temperature : 23.2 °C ; Liquid Temperature : 21.4 °C

DASY5 Configuration:

- Probe: EX3DV4 - SN3697; ConvF(6.96, 6.96, 6.96); Calibrated: 2011-9-2
- Sensor-Surface: 4mm (Mechanical Surface Detection)
- Electronics: DAE4 Sn1210; Calibrated: 2011-11-18
- Phantom: SAM3; Type: SAM; Serial: TP-1079
- Measurement SW: DASY52, Version 52.8 (0); SEMCAD X Version 14.4.5 (3634)

Ch9262/Area Scan (101x151x1): Measurement grid: dx=15mm, dy=15mm

Maximum value of SAR (interpolated) = 1.045 mW/g

Ch9262/Zoom Scan (5x5x7)/Cube 0: Measurement grid: dx=8mm, dy=8mm, dz=5mm

Reference Value = 8.128 V/m; Power Drift = 0.14 dB

Peak SAR (extrapolated) = 2.481 W/kg

SAR(1 g) = 1.04 mW/g; SAR(10 g) = 0.534 mW/g

Maximum value of SAR (measured) = 1.085 mW/g

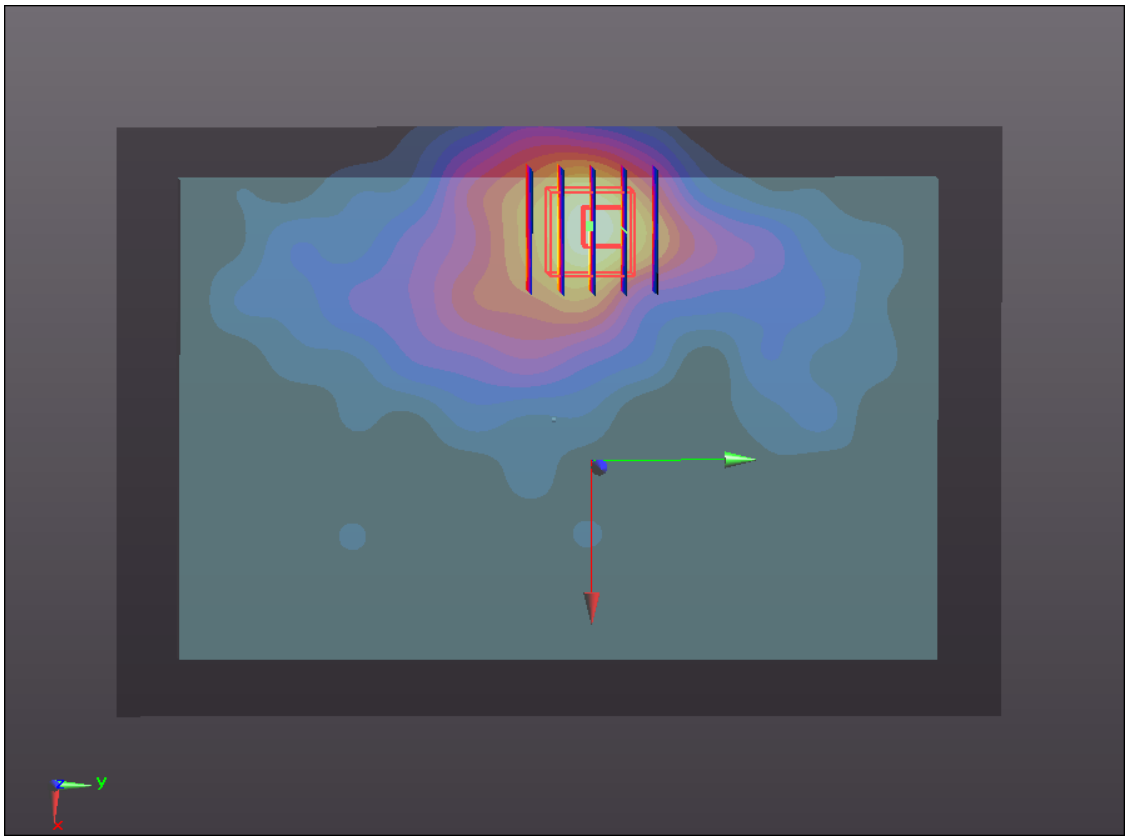
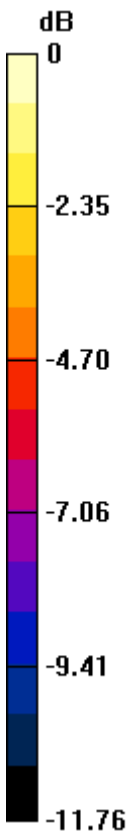

0 dB = 1.090mW/g

#36 WCDMA II_RMC12.2K_Bottom Face_0cm_sensor on_Ch9400

DUT: 262503

Communication System: UMTS; Frequency: 1880 MHz; Duty Cycle: 1:1

Medium: MSL_1900_120717 Medium parameters used: $f = 1880$ MHz; $\sigma = 1.525$ mho/m; $\epsilon_r =$

53.834; $\rho = 1000$ kg/m³

Ambient Temperature : 23.2 °C; Liquid Temperature : 21.4 °C

DASY5 Configuration:

- Probe: EX3DV4 - SN3697; ConvF(6.96, 6.96, 6.96); Calibrated: 2011-9-2
- Sensor-Surface: 4mm (Mechanical Surface Detection)
- Electronics: DAE4 Sn1210; Calibrated: 2011-11-18
- Phantom: SAM3; Type: SAM; Serial: TP-1079
- Measurement SW: DASY52, Version 52.8 (0); SEMCAD X Version 14.4.5 (3634)

Ch9400/Area Scan (101x151x1): Measurement grid: dx=15mm, dy=15mm

Maximum value of SAR (interpolated) = 1.123 mW/g

Ch9400/Zoom Scan (5x5x7)/Cube 0: Measurement grid: dx=8mm, dy=8mm, dz=5mm

Reference Value = 8.297 V/m; Power Drift = 0.14 dB

Peak SAR (extrapolated) = 2.428 W/kg

SAR(1 g) = 1.06 mW/g; SAR(10 g) = 0.552 mW/g

Maximum value of SAR (measured) = 1.169 mW/g

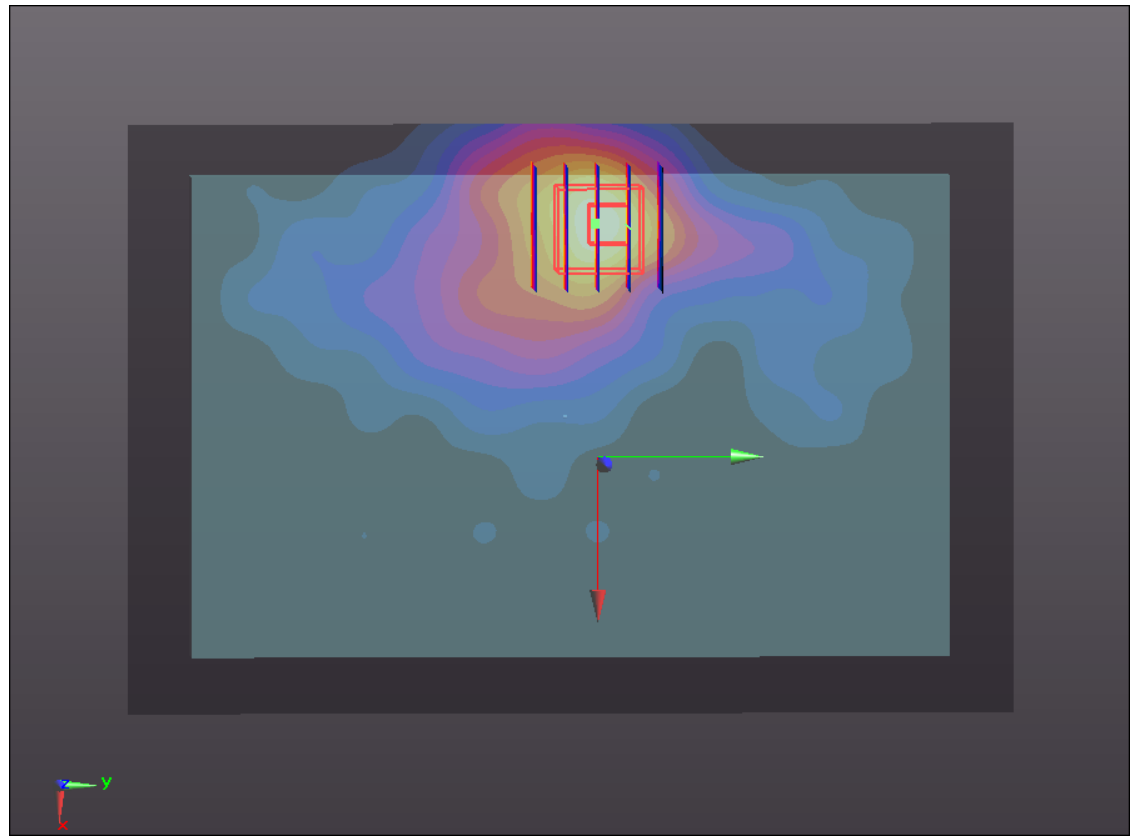
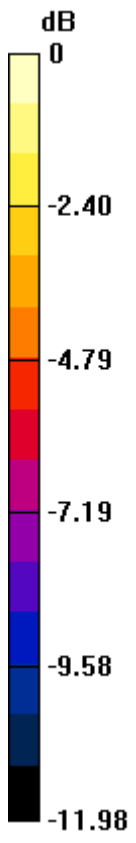

0 dB = 1.170mW/g

#31 WCDMA II_RMC12.2K_Primary Portrait_0cm_sensor on_Ch9538

DUT: 262503

Communication System: UMTS; Frequency: 1907.6 MHz; Duty Cycle: 1:1

Medium: MSL_1900_120717 Medium parameters used: $f = 1908$ MHz; $\sigma = 1.555$ mho/m; $\epsilon_r =$

53.787 ; $\rho = 1000$ kg/m³

Ambient Temperature : 23.2 °C; Liquid Temperature : 21.4 °C

DASY5 Configuration:

- Probe: EX3DV4 - SN3697; ConvF(6.96, 6.96, 6.96); Calibrated: 2011-9-2
- Sensor-Surface: 4mm (Mechanical Surface Detection)
- Electronics: DAE4 Sn1210; Calibrated: 2011-11-18
- Phantom: SAM3; Type: SAM; Serial: TP-1079
- Measurement SW: DASY52, Version 52.8 (0); SEMCAD X Version 14.4.5 (3634)

Ch9538/Area Scan (31x151x1): Measurement grid: dx=15mm, dy=15mm

Maximum value of SAR (interpolated) = 0.820 mW/g

Ch9538/Zoom Scan (5x5x7)/Cube 0: Measurement grid: dx=8mm, dy=8mm, dz=5mm

Reference Value = 19.822 V/m; Power Drift = -0.06 dB

Peak SAR (extrapolated) = 1.103 W/kg

SAR(1 g) = 0.675 mW/g; SAR(10 g) = 0.392 mW/g

Maximum value of SAR (measured) = 0.727 mW/g

Ch9538/Zoom Scan (5x5x7)/Cube 1: Measurement grid: dx=8mm, dy=8mm, dz=5mm

Reference Value = 19.822 V/m; Power Drift = -0.06 dB

Peak SAR (extrapolated) = 1.579 W/kg

SAR(1 g) = 0.736 mW/g; SAR(10 g) = 0.390 mW/g

Maximum value of SAR (measured) = 0.817 mW/g

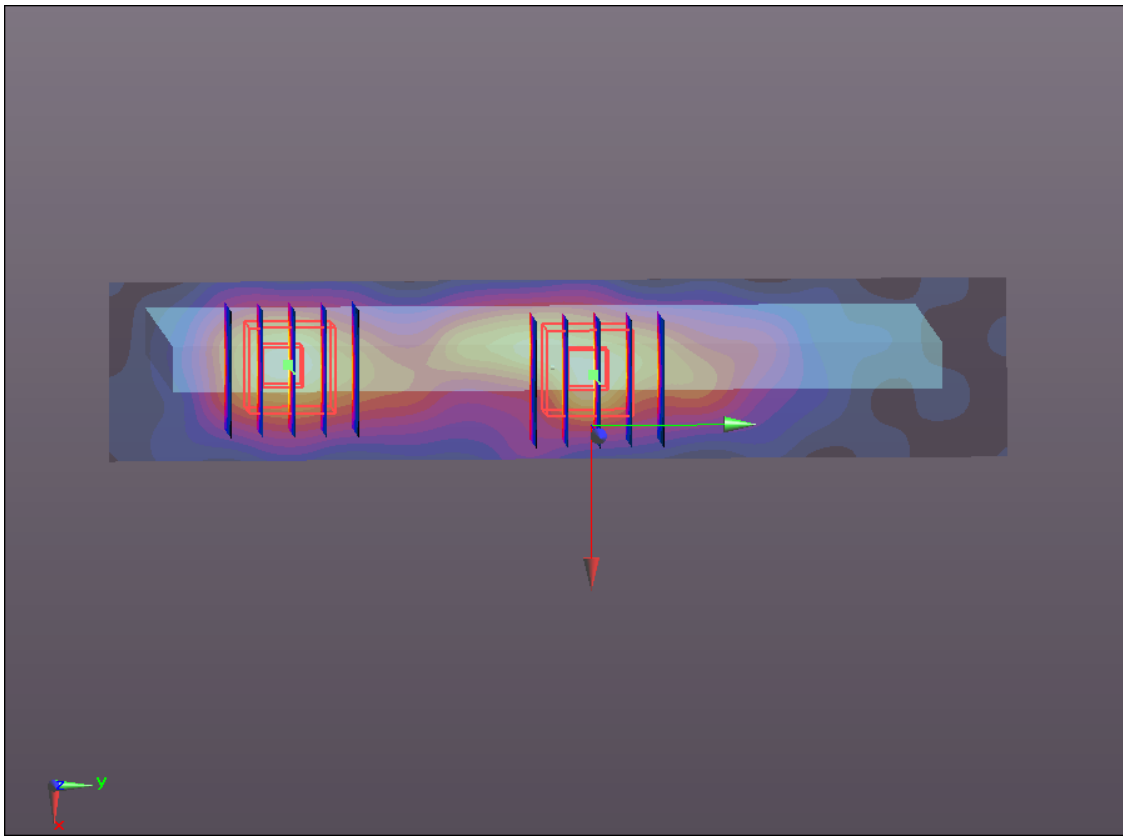
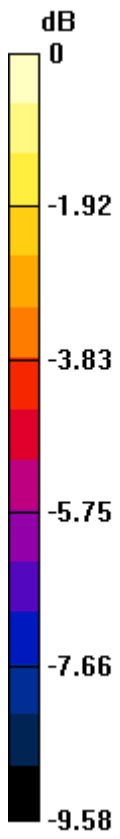

0 dB = 0.820mW/g

#32 WCDMA II_RMC12.2K_Bottom Face_0.9cm_sensor off_Ch9538

DUT: 262503

Communication System: UMTS; Frequency: 1907.6 MHz; Duty Cycle: 1:1

Medium: MSL_1900_120717 Medium parameters used: $f = 1908$ MHz; $\sigma = 1.555$ mho/m; $\epsilon_r =$

53.787 ; $\rho = 1000$ kg/m³

Ambient Temperature : 23.2 °C ; Liquid Temperature : 21.4 °C

DASY5 Configuration:

- Probe: EX3DV4 - SN3697; ConvF(6.96, 6.96, 6.96); Calibrated: 2011-9-2
- Sensor-Surface: 4mm (Mechanical Surface Detection)
- Electronics: DAE4 Sn1210; Calibrated: 2011-11-18
- Phantom: SAM3; Type: SAM; Serial: TP-1079
- Measurement SW: DASY52, Version 52.8 (0); SEMCAD X Version 14.4.5 (3634)

Ch9538/Area Scan (101x151x1): Measurement grid: dx=15mm, dy=15mm

Maximum value of SAR (interpolated) = 0.642 mW/g

Ch9538/Zoom Scan (5x5x7)/Cube 0: Measurement grid: dx=8mm, dy=8mm, dz=5mm

Reference Value = 11.555 V/m; Power Drift = -0.03 dB

Peak SAR (extrapolated) = 1.014 W/kg

SAR(1 g) = 0.573 mW/g; SAR(10 g) = 0.374 mW/g

Maximum value of SAR (measured) = 0.596 mW/g

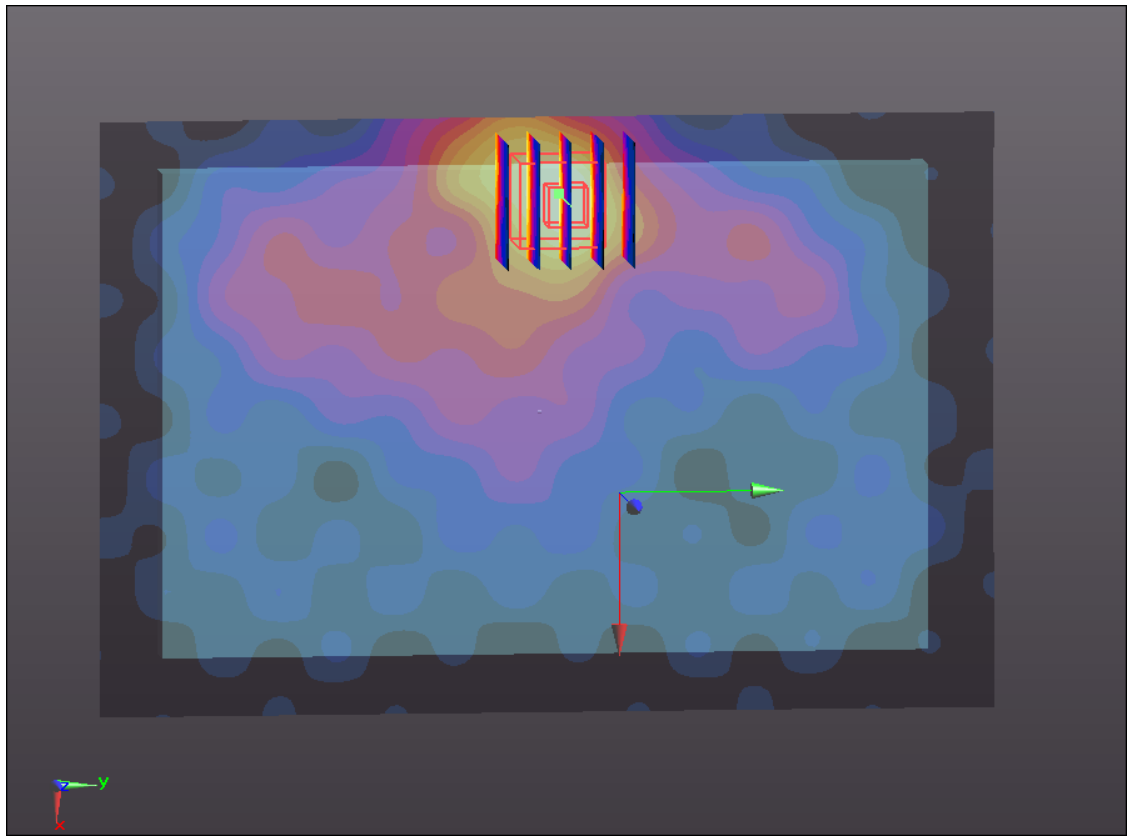

0 dB = 0.600mW/g

#33 WCDMA II_RMC12.2K_Primary Portrait_0.7cm_sensor off_Ch9538

DUT: 262503

Communication System: UMTS; Frequency: 1907.6 MHz; Duty Cycle: 1:1

Medium: MSL_1900_120717 Medium parameters used: $f = 1908$ MHz; $\sigma = 1.555$ mho/m; $\epsilon_r =$

53.787 ; $\rho = 1000$ kg/m³

Ambient Temperature : 23.2 °C; Liquid Temperature : 21.4 °C

DASY5 Configuration:

- Probe: EX3DV4 - SN3697; ConvF(6.96, 6.96, 6.96); Calibrated: 2011-9-2
- Sensor-Surface: 4mm (Mechanical Surface Detection)
- Electronics: DAE4 Sn1210; Calibrated: 2011-11-18
- Phantom: SAM3; Type: SAM; Serial: TP-1079
- Measurement SW: DASY52, Version 52.8 (0); SEMCAD X Version 14.4.5 (3634)

Ch9538/Area Scan (31x151x1): Measurement grid: dx=15mm, dy=15mm

Maximum value of SAR (interpolated) = 0.732 mW/g

Ch9538/Zoom Scan (5x5x7)/Cube 0: Measurement grid: dx=8mm, dy=8mm, dz=5mm

Reference Value = 20.353 V/m; Power Drift = -0.02 dB

Peak SAR (extrapolated) = 1.260 W/kg

SAR(1 g) = 0.712 mW/g; SAR(10 g) = 0.403 mW/g

Maximum value of SAR (measured) = 0.756 mW/g

Ch9538/Zoom Scan (5x5x7)/Cube 1: Measurement grid: dx=8mm, dy=8mm, dz=5mm

Reference Value = 20.353 V/m; Power Drift = -0.02 dB

Peak SAR (extrapolated) = 0.763 W/kg

SAR(1 g) = 0.520 mW/g; SAR(10 g) = 0.345 mW/g

Maximum value of SAR (measured) = 0.582 mW/g

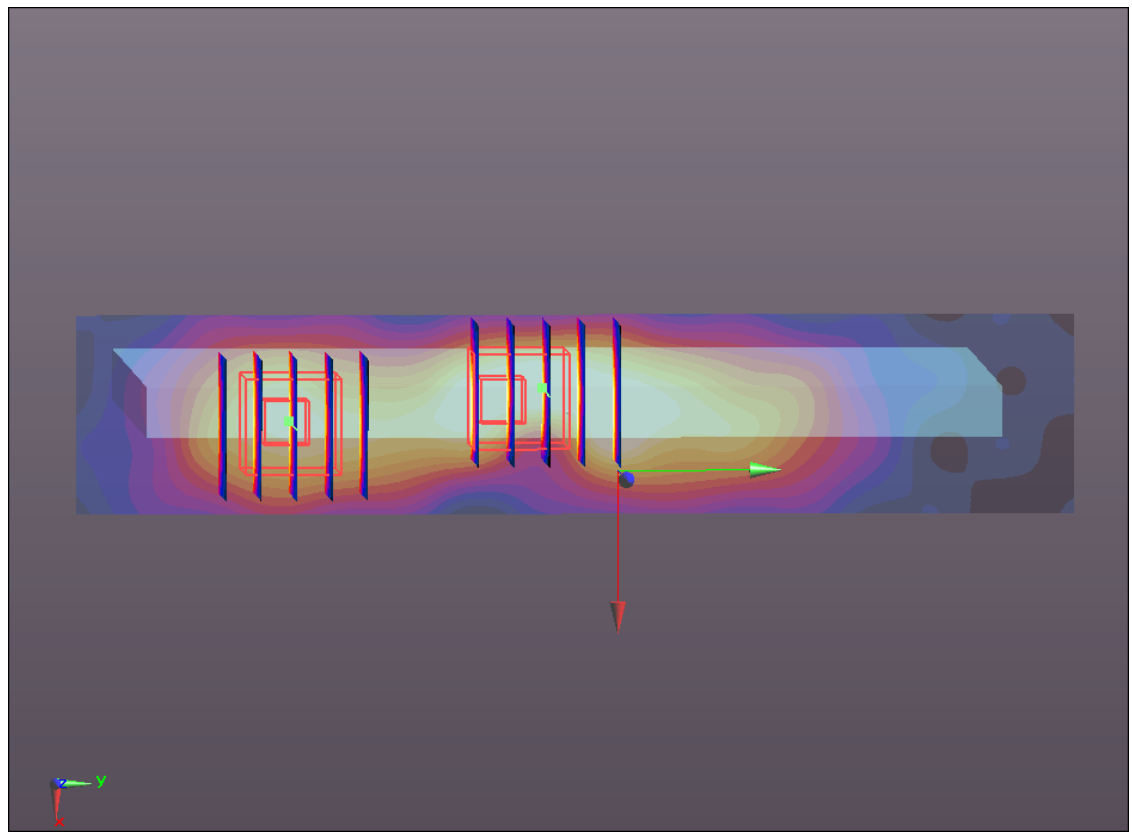
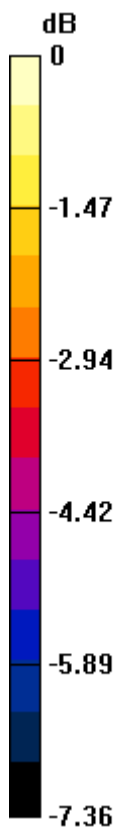

0 dB = 0.580mW/g

#34 WCDMA II_RMC12.2K_Primary Portrait_Right Corner at 6 degree_sensor off_Ch9538

DUT: 262503

Communication System: UMTS; Frequency: 1907.6 MHz; Duty Cycle: 1:1

Medium: MSL_1900_120717 Medium parameters used: $f = 1908$ MHz; $\sigma = 1.555$ mho/m; $\epsilon_r =$

53.787 ; $\rho = 1000$ kg/m³

Ambient Temperature : 23.2 °C; Liquid Temperature : 21.4 °C

DASY5 Configuration:

- Probe: EX3DV4 - SN3697; ConvF(6.96, 6.96, 6.96); Calibrated: 2011-9-2
- Sensor-Surface: 4mm (Mechanical Surface Detection)
- Electronics: DAE4 Sn1210; Calibrated: 2011-11-18
- Phantom: SAM3; Type: SAM; Serial: TP-1079
- Measurement SW: DASY52, Version 52.8 (0); SEMCAD X Version 14.4.5 (3634)

Ch9538/Area Scan (31x151x1): Measurement grid: dx=15mm, dy=15mm

Maximum value of SAR (interpolated) = 1.473 mW/g

Ch9538/Zoom Scan (5x5x7)/Cube 0: Measurement grid: dx=8mm, dy=8mm, dz=5mm

Reference Value = 19.504 V/m; Power Drift = -0.02 dB

Peak SAR (extrapolated) = 2.079 W/kg

SAR(1 g) = 1.22 mW/g; SAR(10 g) = 0.685 mW/g

Maximum value of SAR (measured) = 1.338 mW/g

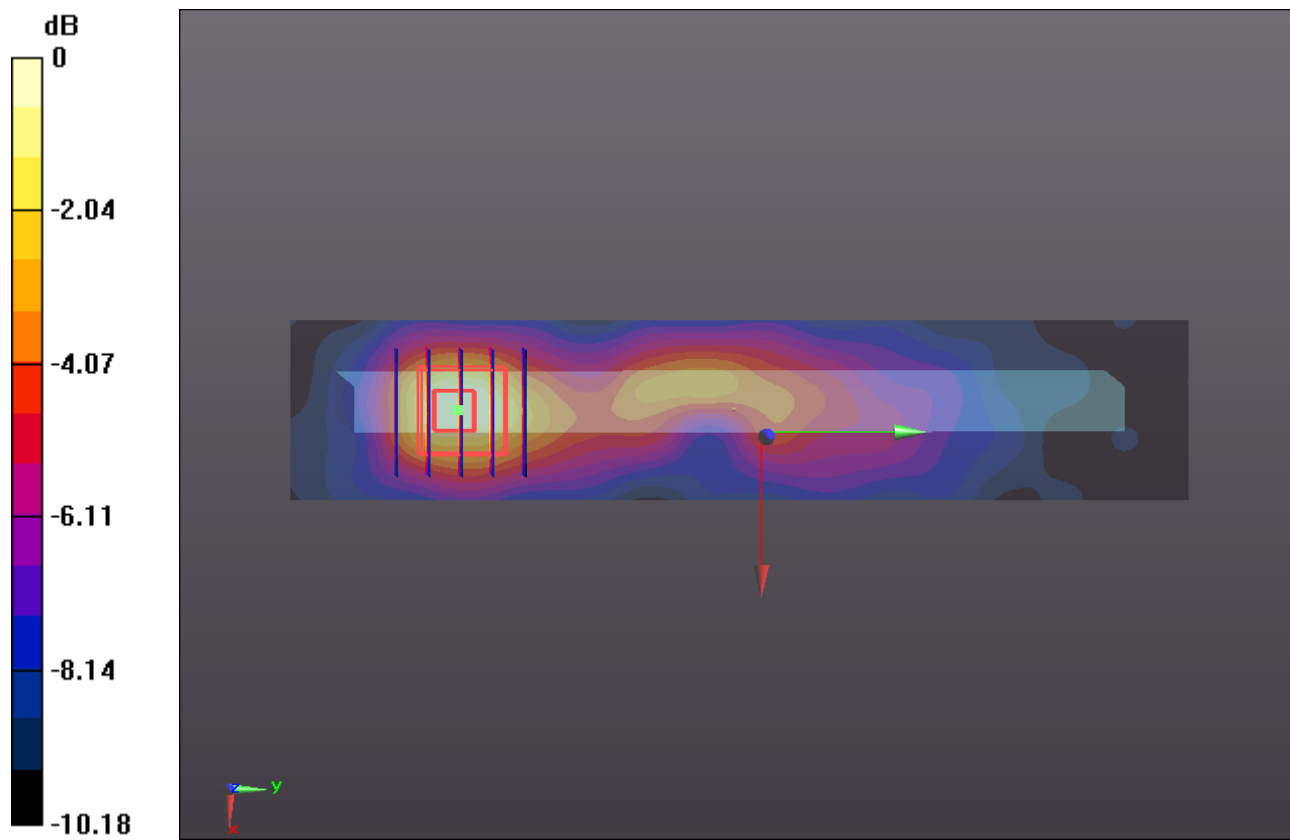

0 dB = 1.340mW/g

#37 WCDMA II_RMC12.2K_Primary Portrait_Right Corner at 6 degree_sensor off_Ch9262

DUT: 262503

Communication System: UMTS; Frequency: 1852.4 MHz; Duty Cycle: 1:1

Medium: MSL_1900_120717 Medium parameters used: $f = 1852.4$ MHz; $\sigma = 1.492$ mho/m; $\epsilon_r =$

53.874 ; $\rho = 1000$ kg/m³

Ambient Temperature : 23.2 °C; Liquid Temperature : 21.4 °C

DASY5 Configuration:

- Probe: EX3DV4 - SN3697; ConvF(6.96, 6.96, 6.96); Calibrated: 2011-9-2
- Sensor-Surface: 4mm (Mechanical Surface Detection)
- Electronics: DAE4 Sn1210; Calibrated: 2011-11-18
- Phantom: SAM3; Type: SAM; Serial: TP-1079
- Measurement SW: DASY52, Version 52.8 (0); SEMCAD X Version 14.4.5 (3634)

Ch9262/Area Scan (31x151x1): Measurement grid: dx=15mm, dy=15mm

Maximum value of SAR (interpolated) = 1.570 mW/g

Ch9262/Zoom Scan (5x5x7)/Cube 0: Measurement grid: dx=8mm, dy=8mm, dz=5mm

Reference Value = 16.835 V/m; Power Drift = -0.03 dB

Peak SAR (extrapolated) = 2.156 W/kg

SAR(1 g) = 1.29 mW/g; SAR(10 g) = 0.734 mW/g

Maximum value of SAR (measured) = 1.415 mW/g

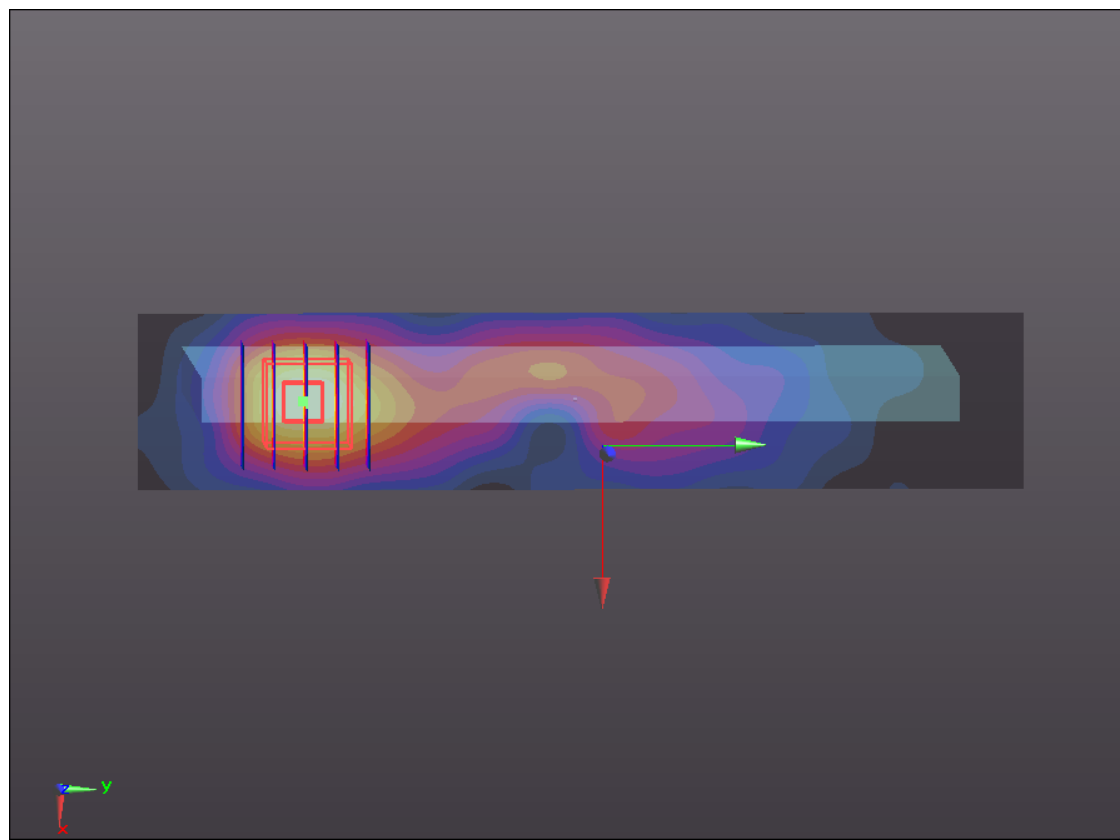
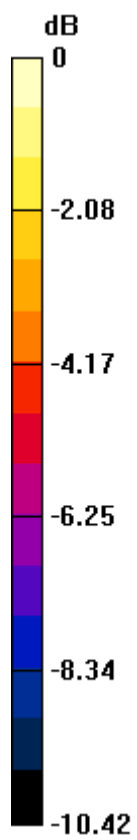

0 dB = 1.420mW/g

#38 WCDMA II_RMC12.2K_Primary Portrait_Right Corner at 6 degree_sensor off_Ch9400

DUT: 262503

Communication System: UMTS; Frequency: 1880 MHz; Duty Cycle: 1:1

Medium: MSL_1900_120717 Medium parameters used: $f = 1880$ MHz; $\sigma = 1.525$ mho/m; $\epsilon_r =$

53.834; $\rho = 1000$ kg/m³

Ambient Temperature : 23.2 °C; Liquid Temperature : 21.4 °C

DASY5 Configuration:

- Probe: EX3DV4 - SN3697; ConvF(6.96, 6.96, 6.96); Calibrated: 2011-9-2
- Sensor-Surface: 4mm (Mechanical Surface Detection)
- Electronics: DAE4 Sn1210; Calibrated: 2011-11-18
- Phantom: SAM3; Type: SAM; Serial: TP-1079
- Measurement SW: DASY52, Version 52.8 (0); SEMCAD X Version 14.4.5 (3634)

Ch9400/Area Scan (31x151x1): Measurement grid: dx=15mm, dy=15mm

Maximum value of SAR (interpolated) = 1.633 mW/g

Ch9400/Zoom Scan (5x5x7)/Cube 0: Measurement grid: dx=8mm, dy=8mm, dz=5mm

Reference Value = 18.679 V/m; Power Drift = -0.07 dB

Peak SAR (extrapolated) = 2.225 W/kg

SAR(1 g) = 1.34 mW/g; SAR(10 g) = 0.757 mW/g

Maximum value of SAR (measured) = 1.469 mW/g

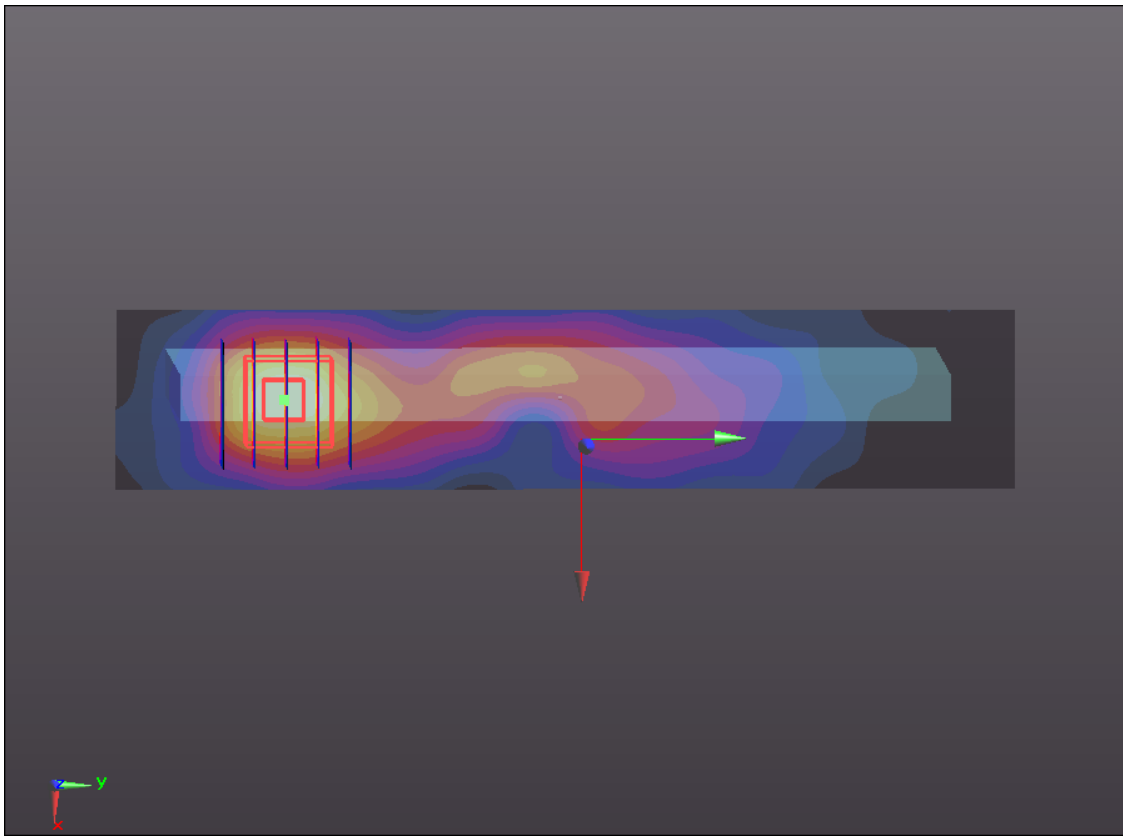
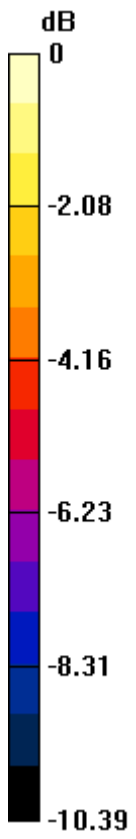

0 dB = 1.470mW/g

#38 WCDMA II_RMC12.2K_Primary Portrait_Right Corner at 6 degree_sensor off_Ch9400_2D

DUT: 262503

Communication System: UMTS; Frequency: 1880 MHz; Duty Cycle: 1:1

Medium: MSL_1900_120717 Medium parameters used: $f = 1880$ MHz; $\sigma = 1.525$ mho/m; $\epsilon_r =$

53.834 ; $\rho = 1000$ kg/m³

Ambient Temperature : 23.2 °C ; Liquid Temperature : 21.4 °C

DASY5 Configuration:

- Probe: EX3DV4 - SN3697; ConvF(6.96, 6.96, 6.96); Calibrated: 2011-9-2
- Sensor-Surface: 4mm (Mechanical Surface Detection)
- Electronics: DAE4 Sn1210; Calibrated: 2011-11-18
- Phantom: SAM3; Type: SAM; Serial: TP-1079
- Measurement SW: DASY52, Version 52.8 (0); SEMCAD X Version 14.4.5 (3634)

Ch9400/Area Scan (31x151x1): Measurement grid: dx=15mm, dy=15mm

Maximum value of SAR (interpolated) = 1.633 mW/g

Ch9400/Zoom Scan (5x5x7)/Cube 0: Measurement grid: dx=8mm, dy=8mm, dz=5mm

Reference Value = 18.679 V/m; Power Drift = -0.07 dB

Peak SAR (extrapolated) = 2.225 W/kg

SAR(1 g) = 1.34 mW/g; SAR(10 g) = 0.757 mW/g

Maximum value of SAR (measured) = 1.469 mW/g

1g/10g Averaged SAR

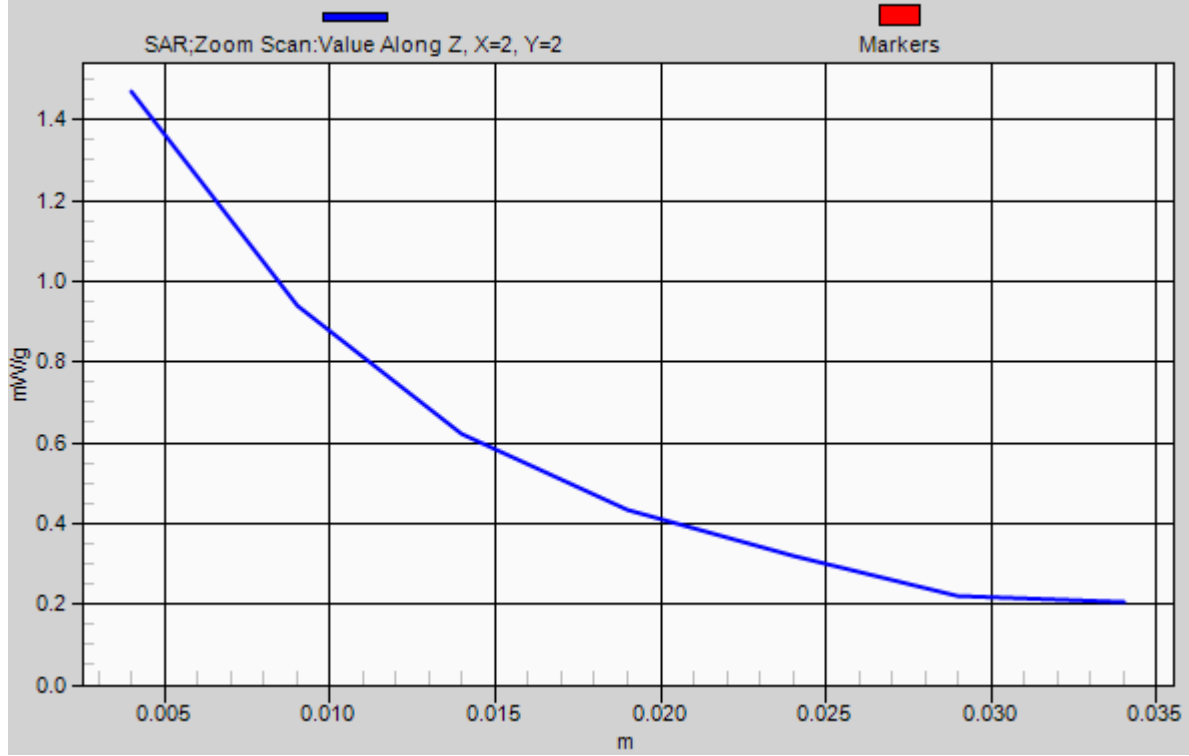

#48 WCDMA II_RMC12.2K_Primary Portrait_Left Corner at 32 degree_sensor off_Ch9538

DUT: 262503

Communication System: UMTS; Frequency: 1907.6 MHz; Duty Cycle: 1:1

Medium: MSL_1900_120730 Medium parameters used: $f = 1908$ MHz; $\sigma = 1.542$ mho/m; $\epsilon_r =$

54.552 ; $\rho = 1000$ kg/m³

Ambient Temperature : 23.3 °C ; Liquid Temperature : 21.5 °C

DASY5 Configuration:

- Probe: EX3DV4 - SN3857; ConvF(7.35, 7.35, 7.35); Calibrated: 2012-6-20
- Sensor-Surface: 4mm (Mechanical Surface Detection)
- Electronics: DAE4 Sn1210; Calibrated: 2011-11-18
- Phantom: SAM3; Type: SAM; Serial: TP-1079
- Measurement SW: DASY52, Version 52.8 (0); SEMCAD X Version 14.4.5 (3634)

Ch9538/Area Scan (31x171x1): Measurement grid: dx=15mm, dy=15mm

Maximum value of SAR (interpolated) = 0.048 mW/g

Ch9538/Zoom Scan (5x5x7)/Cube 0: Measurement grid: dx=8mm, dy=8mm, dz=5mm

Reference Value = 5.005 V/m; Power Drift = -0.09 dB

Peak SAR (extrapolated) = 0.069 W/kg

SAR(1 g) = 0.043 mW/g; SAR(10 g) = 0.027 mW/g

Maximum value of SAR (measured) = 0.047 mW/g

Ch9538/Zoom Scan (5x5x7)/Cube 1: Measurement grid: dx=8mm, dy=8mm, dz=5mm

Reference Value = 5.005 V/m; Power Drift = -0.09 dB

Peak SAR (extrapolated) = 0.062 W/kg

SAR(1 g) = 0.040 mW/g; SAR(10 g) = 0.024 mW/g

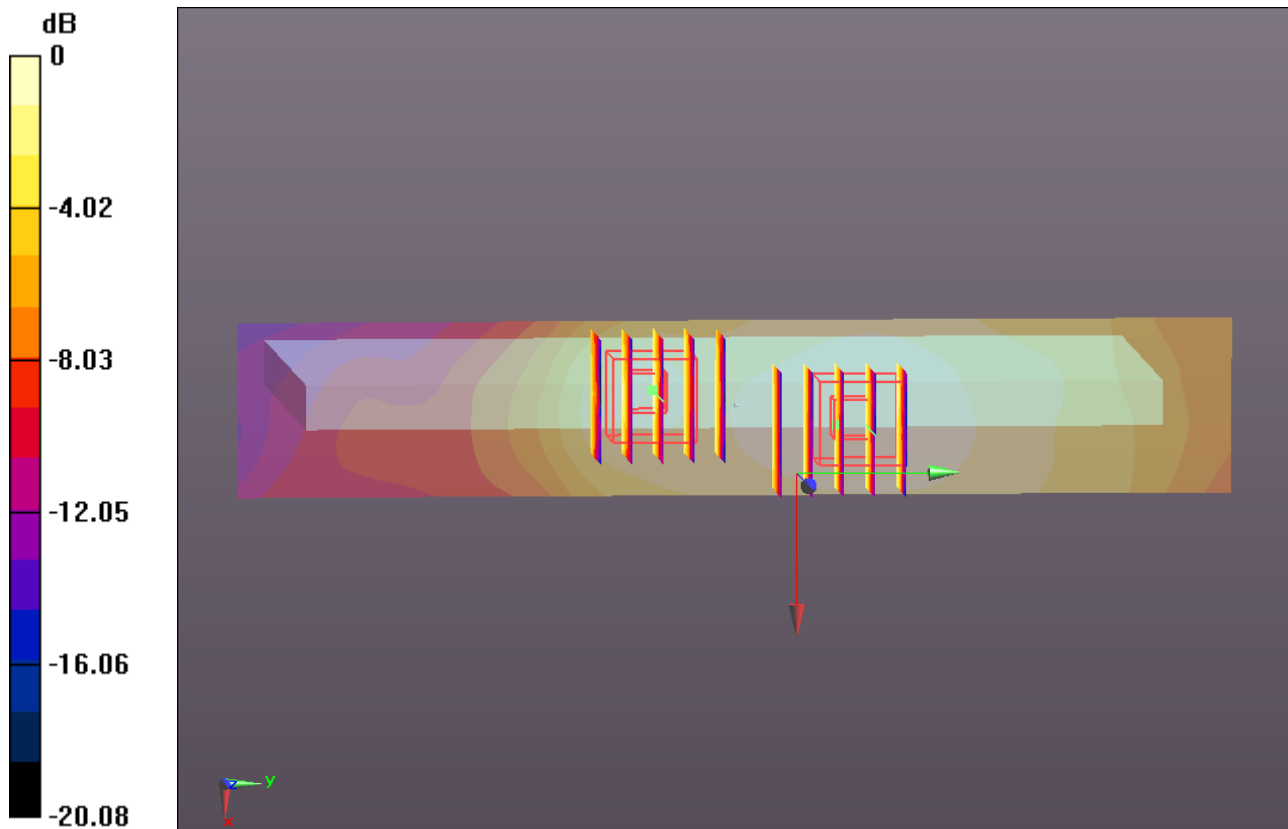

0 dB = 0.050mW/g

#41 802.11b_Bottom Face_0cm_1M_Ch6

DUT: 262503

Communication System: WIFI; Frequency: 2437 MHz; Duty Cycle: 1:1

Medium: MSL_2450_120730 Medium parameters used: $f = 2437$ MHz; $\sigma = 1.912$ mho/m; $\epsilon_r =$

54.01; $\rho = 1000$ kg/m³

Ambient Temperature : 23.5 °C ; Liquid Temperature : 21.4 °C

DASY5 Configuration:

- Probe: EX3DV4 - SN3857; ConvF(6.94, 6.94, 6.94); Calibrated: 2012-6-20
- Sensor-Surface: 4mm (Mechanical Surface Detection)
- Electronics: DAE4 Sn1210; Calibrated: 2011-11-18
- Phantom: SAM3; Type: SAM; Serial: TP-1079
- Measurement SW: DASY52, Version 52.8 (0); SEMCAD X Version 14.4.5 (3634)

Ch6/Area Scan (101x151x1): Measurement grid: dx=15mm, dy=15mm

Maximum value of SAR (interpolated) = 0.551 mW/g

Ch6/Zoom Scan (5x5x7)/Cube 0: Measurement grid: dx=8mm, dy=8mm, dz=5mm

Reference Value = 0 V/m; Power Drift = 0 dB

Peak SAR (extrapolated) = 1.352 W/kg

SAR(1 g) = 0.508 mW/g; SAR(10 g) = 0.189 mW/g

Maximum value of SAR (measured) = 0.579 mW/g

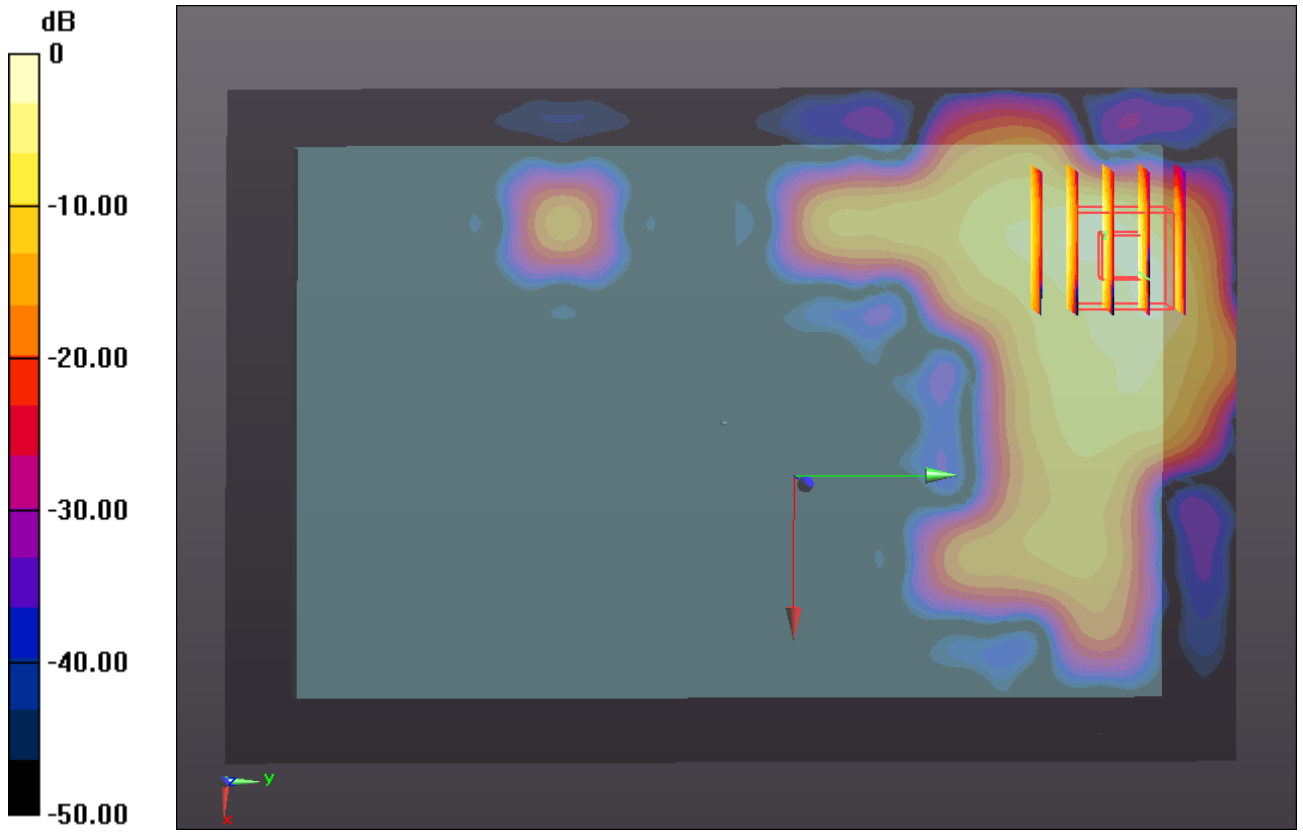

0 dB = 0.580mW/g

#41 802.11b_Bottom Face_0cm_1M_Ch6_2D

DUT: 262503

Communication System: WIFI; Frequency: 2437 MHz; Duty Cycle: 1:1

Medium: MSL_2450_120730 Medium parameters used: $f = 2437$ MHz; $\sigma = 1.912$ mho/m; $\epsilon_r = 54.01$; $\rho = 1000$ kg/m³

Ambient Temperature : 23.5 °C ; Liquid Temperature : 21.4 °C

DASY5 Configuration:

- Probe: EX3DV4 - SN3857; ConvF(6.94, 6.94, 6.94); Calibrated: 2012-6-20
- Sensor-Surface: 4mm (Mechanical Surface Detection)
- Electronics: DAE4 Sn1210; Calibrated: 2011-11-18
- Phantom: SAM3; Type: SAM; Serial: TP-1079
- Measurement SW: DASY52, Version 52.8 (0); SEMCAD X Version 14.4.5 (3634)

Ch6/Area Scan (101x151x1): Measurement grid: dx=15mm, dy=15mm

Maximum value of SAR (interpolated) = 0.551 mW/g

Ch6/Zoom Scan (5x5x7)/Cube 0: Measurement grid: dx=8mm, dy=8mm, dz=5mm

Reference Value = 0 V/m; Power Drift = 0 dB

Peak SAR (extrapolated) = 1.352 W/kg

SAR(1 g) = 0.508 mW/g; SAR(10 g) = 0.189 mW/g

Maximum value of SAR (measured) = 0.579 mW/g

1g/10g Averaged SAR

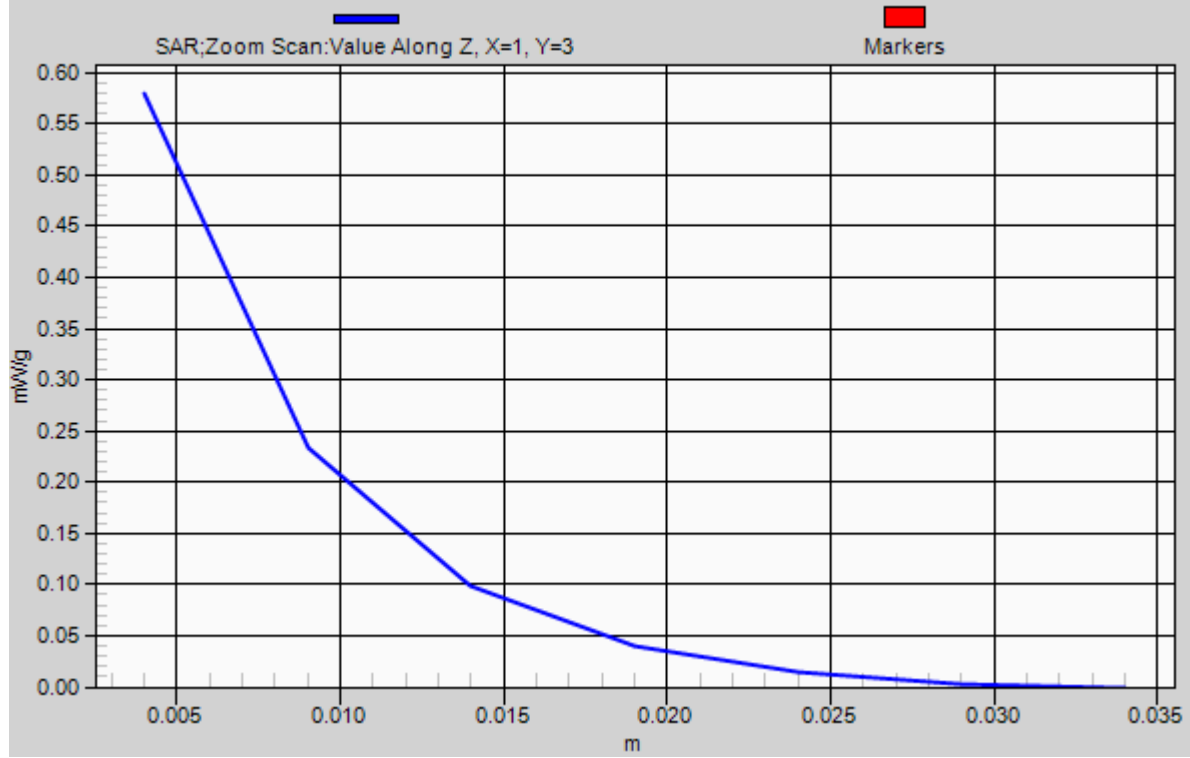

#42 802.11b_Primary Portrait_0cm_1M_Ch6

DUT: 262503

Communication System: WIFI; Frequency: 2437 MHz; Duty Cycle: 1:1

Medium: MSL_2450_120730 Medium parameters used: $f = 2437$ MHz; $\sigma = 1.912$ mho/m; $\epsilon_r =$

54.01 ; $\rho = 1000$ kg/m³

Ambient Temperature : 23.5 °C ; Liquid Temperature : 21.4 °C

DASY5 Configuration:

- Probe: EX3DV4 - SN3857; ConvF(6.94, 6.94, 6.94); Calibrated: 2012-6-20
- Sensor-Surface: 4mm (Mechanical Surface Detection)
- Electronics: DAE4 Sn1210; Calibrated: 2011-11-18
- Phantom: SAM3; Type: SAM; Serial: TP-1079
- Measurement SW: DASY52, Version 52.8 (0); SEMCAD X Version 14.4.5 (3634)

Ch6/Area Scan (31x151x1): Measurement grid: dx=15mm, dy=15mm

Maximum value of SAR (interpolated) = 0.088 mW/g

Ch6/Zoom Scan (5x5x7)/Cube 0: Measurement grid: dx=8mm, dy=8mm, dz=5mm

Reference Value = 2.686 V/m; Power Drift = 0.06 dB

Peak SAR (extrapolated) = 0.090 W/kg

SAR(1 g) = 0.045 mW/g; SAR(10 g) = 0.020 mW/g

Maximum value of SAR (measured) = 0.058 mW/g

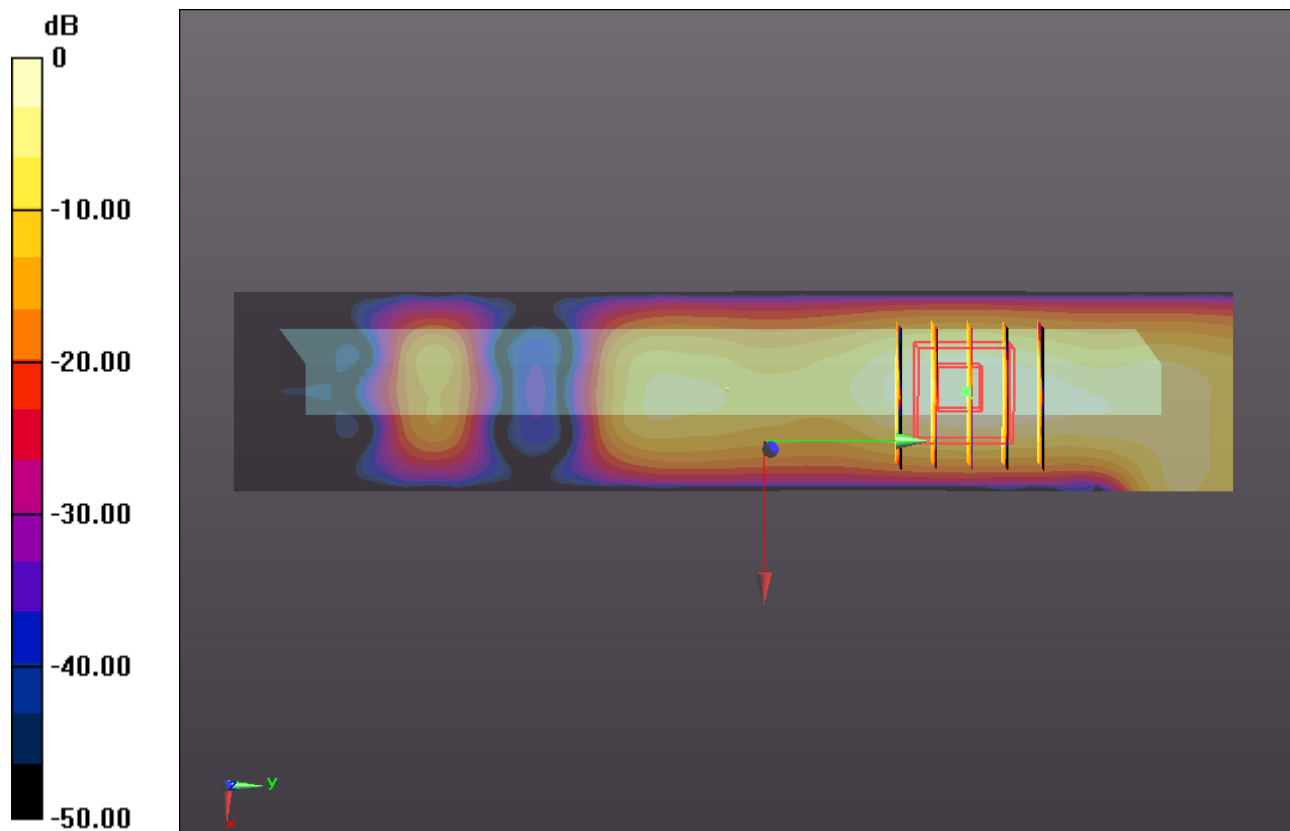

0 dB = 0.060mW/g

#43 802.11b_Secondary Landscape_0cm_1M_Ch6

DUT: 262503

Communication System: WIFI; Frequency: 2437 MHz; Duty Cycle: 1:1

Medium: MSL_2450_1200730 Medium parameters used: $f = 2437$ MHz; $\sigma = 1.912$ mho/m; $\epsilon_r =$

54.01; $\rho = 1000$ kg/m³

Ambient Temperature : 23.5 °C ; Liquid Temperature : 21.4 °C

DASY5 Configuration:

- Probe: EX3DV4 - SN3857; ConvF(6.94, 6.94, 6.94); Calibrated: 2012-6-20
- Sensor-Surface: 4mm (Mechanical Surface Detection)
- Electronics: DAE4 Sn1210; Calibrated: 2011-11-18
- Phantom: SAM3; Type: SAM; Serial: TP-1079
- Measurement SW: DASY52, Version 52.8 (0); SEMCAD X Version 14.4.5 (3634)

Ch6/Area Scan (31x101x1): Measurement grid: dx=15mm, dy=15mm

Maximum value of SAR (interpolated) = 0.348 mW/g

Ch6/Zoom Scan (5x5x7)/Cube 0: Measurement grid: dx=8mm, dy=8mm, dz=5mm

Reference Value = 9.921 V/m; Power Drift = -0.02 dB

Peak SAR (extrapolated) = 0.672 W/kg

SAR(1 g) = 0.286 mW/g; SAR(10 g) = 0.115 mW/g

Maximum value of SAR (measured) = 0.367 mW/g

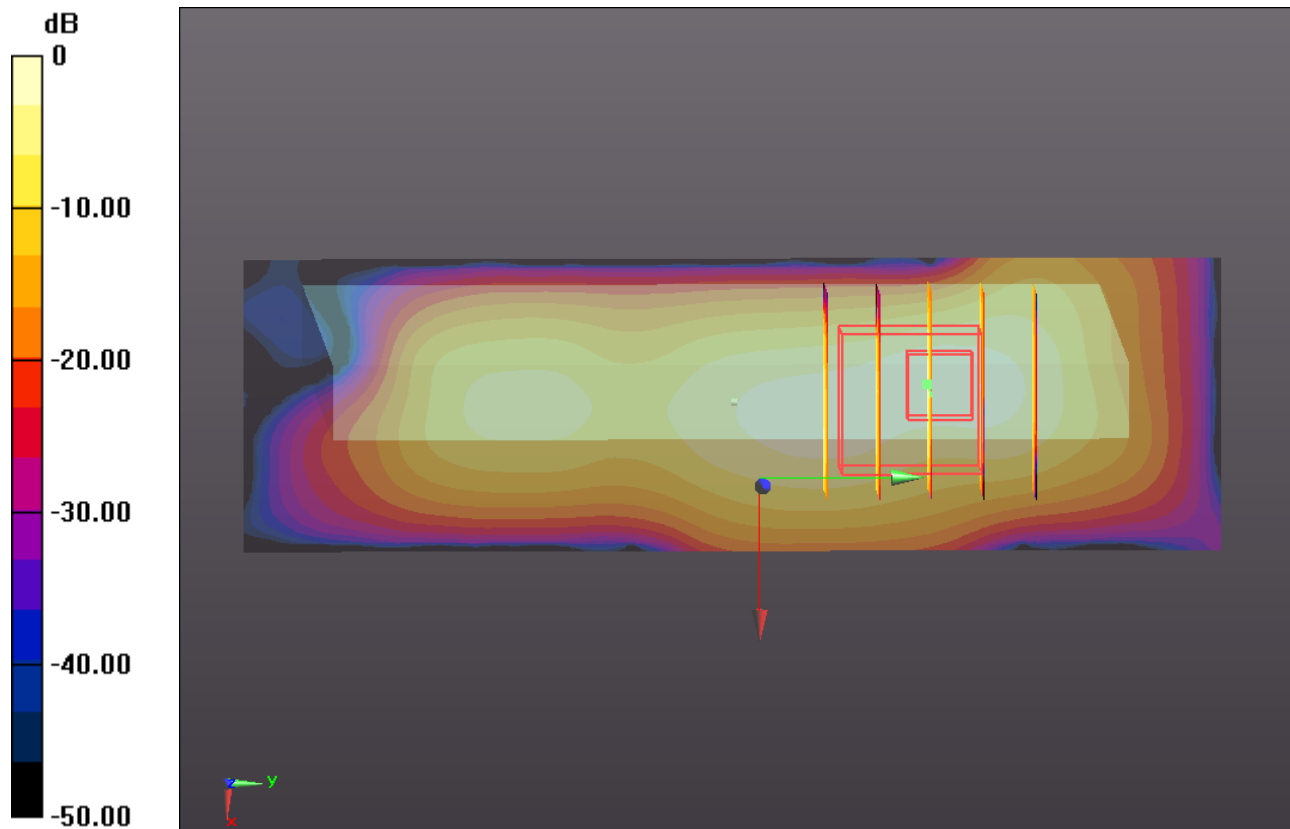

0 dB = 0.370mW/g

#44 802.11b_Primary Portrait_Right Corner at 6 degree_1M_Ch6

DUT: 262503

Communication System: WIFI; Frequency: 2437 MHz; Duty Cycle: 1:1

Medium: MSL_2450_120807 Medium parameters used: $f = 2437$ MHz; $\sigma = 1.912$ mho/m; $\epsilon_r =$

54.01; $\rho = 1000$ kg/m³

Ambient Temperature : 23.5 °C ; Liquid Temperature : 21.4 °C

DASY5 Configuration:

- Probe: EX3DV4 - SN3857; ConvF(6.94, 6.94, 6.94); Calibrated: 2012-6-20
- Sensor-Surface: 4mm (Mechanical Surface Detection)
- Electronics: DAE4 Sn1210; Calibrated: 2011-11-18
- Phantom: SAM3; Type: SAM; Serial: TP-1079
- Measurement SW: DASY52, Version 52.8 (0); SEMCAD X Version 14.4.5 (3634)

Ch6/Area Scan (31x151x1): Measurement grid: dx=15mm, dy=15mm

Maximum value of SAR (interpolated) = 0.017 mW/g

Ch6/Zoom Scan (5x5x7)/Cube 0: Measurement grid: dx=8mm, dy=8mm, dz=5mm

Reference Value = 1.171 V/m; Power Drift = 0.01 dB

Peak SAR (extrapolated) = 0.035 W/kg

SAR(1 g) = 0.016 mW/g; SAR(10 g) = 0.0045 mW/g

Maximum value of SAR (measured) = 0.020 mW/g

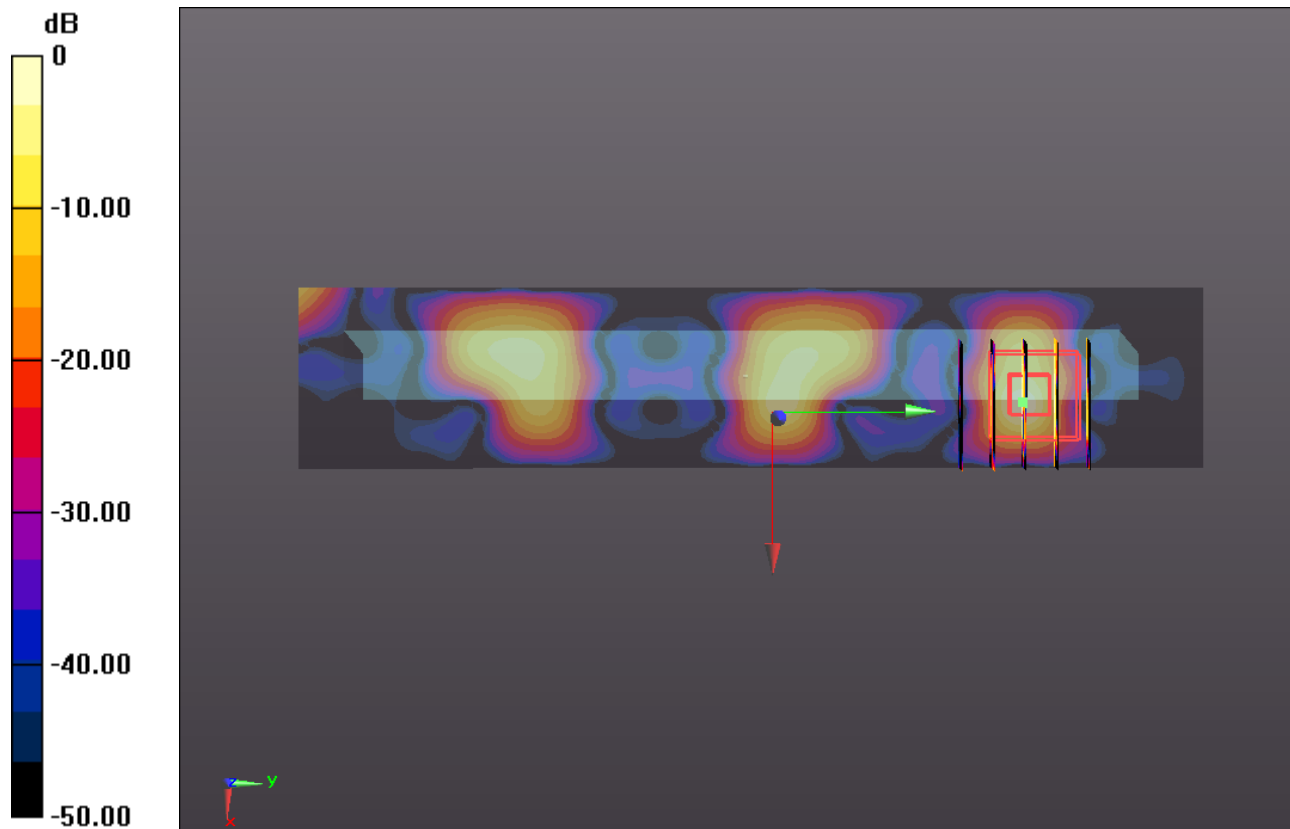

0 dB = 0.020mW/g

#49 802.11b_Secondary Landscape_Left Corner at 32 degree_1M_Ch6

DUT: 262503

Communication System: WIFI; Frequency: 2437 MHz; Duty Cycle: 1:1

Medium: MSL_2450_120730 Medium parameters used: $f = 2437$ MHz; $\sigma = 1.912$ mho/m; $\epsilon_r =$

54.01; $\rho = 1000$ kg/m³

Ambient Temperature : 23.5 °C ; Liquid Temperature : 21.4 °C

DASY5 Configuration:

- Probe: EX3DV4 - SN3857; ConvF(6.94, 6.94, 6.94); Calibrated: 2012-6-20
- Sensor-Surface: 4mm (Mechanical Surface Detection)
- Electronics: DAE4 Sn1210; Calibrated: 2011-11-18
- Phantom: SAM3; Type: SAM; Serial: TP-1079
- Measurement SW: DASY52, Version 52.8 (0); SEMCAD X Version 14.4.5 (3634)

Ch6/Area Scan (31x151x1): Measurement grid: dx=15mm, dy=15mm

Maximum value of SAR (interpolated) = 0.055 mW/g

Ch6/Zoom Scan (5x5x7)/Cube 0: Measurement grid: dx=8mm, dy=8mm, dz=5mm

Reference Value = 0.745 V/m; Power Drift = -0.08 dB

Peak SAR (extrapolated) = 0.077 W/kg

SAR(1 g) = 0.043 mW/g; SAR(10 g) = 0.022 mW/g

Maximum value of SAR (measured) = 0.047 mW/g

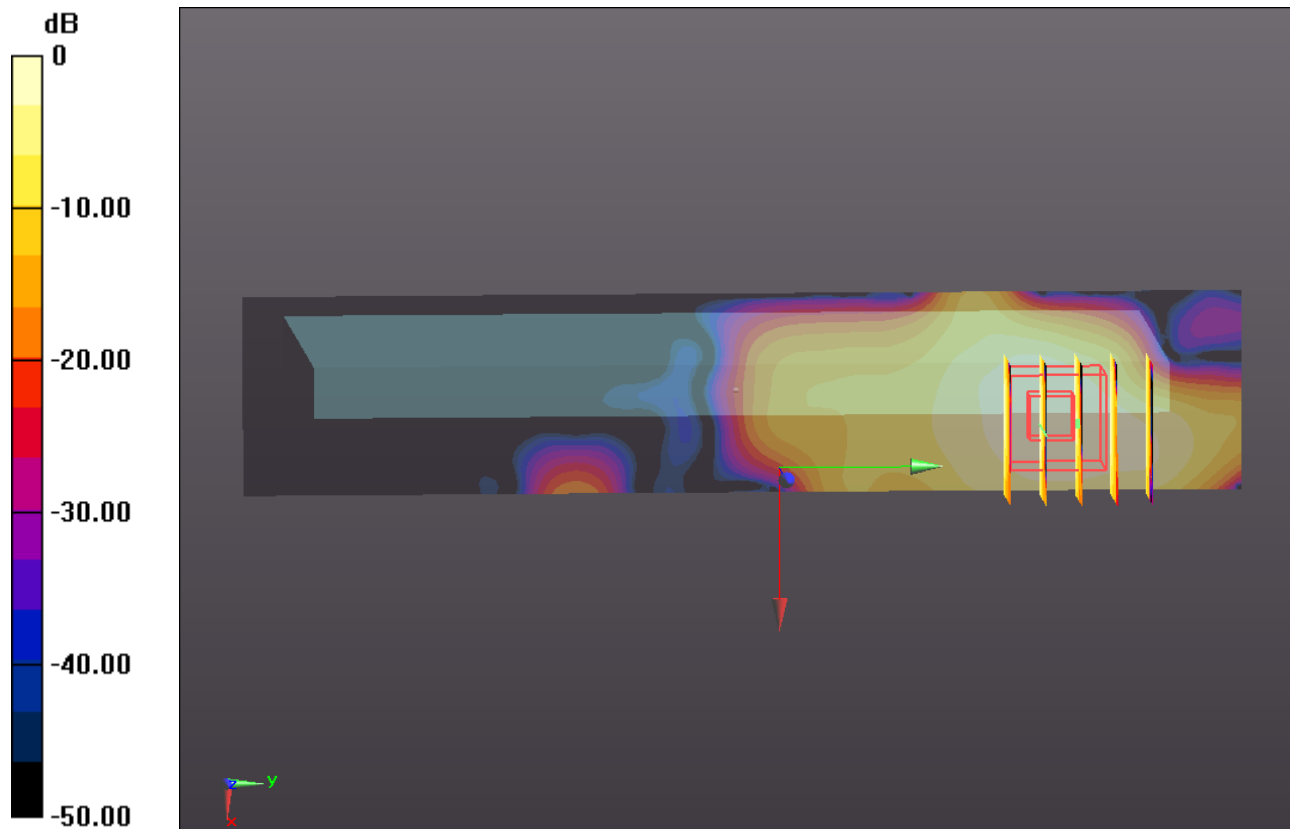

0 dB = 0.050mW/g

#50 802.11b_Bottom Face_0cm_11M_Ch6

DUT: 262503

Communication System: WIFI; Frequency: 2437 MHz; Duty Cycle: 1:1

Medium: MSL_2450_120730 Medium parameters used: $f = 2437$ MHz; $\sigma = 1.912$ mho/m; $\epsilon_r =$

54.01 ; $\rho = 1000$ kg/m³

Ambient Temperature : 23.5 °C; Liquid Temperature : 21.4 °C

DASY5 Configuration:

- Probe: EX3DV4 - SN3857; ConvF(6.94, 6.94, 6.94); Calibrated: 2012-6-20
- Sensor-Surface: 4mm (Mechanical Surface Detection)
- Electronics: DAE4 Sn1210; Calibrated: 2011-11-18
- Phantom: SAM3; Type: SAM; Serial: TP-1079
- Measurement SW: DASY52, Version 52.8 (0); SEMCAD X Version 14.4.5 (3634)

Ch6/Area Scan (101x151x1): Measurement grid: dx=15mm, dy=15mm

Maximum value of SAR (interpolated) = 0.520 mW/g

Ch6/Zoom Scan (5x5x7)/Cube 0: Measurement grid: dx=8mm, dy=8mm, dz=5mm

Reference Value = 0 V/m; Power Drift = 0.009 dB

Peak SAR (extrapolated) = 1.202 W/kg

SAR(1 g) = 0.468 mW/g; SAR(10 g) = 0.178 mW/g

Maximum value of SAR (measured) = 0.519 mW/g

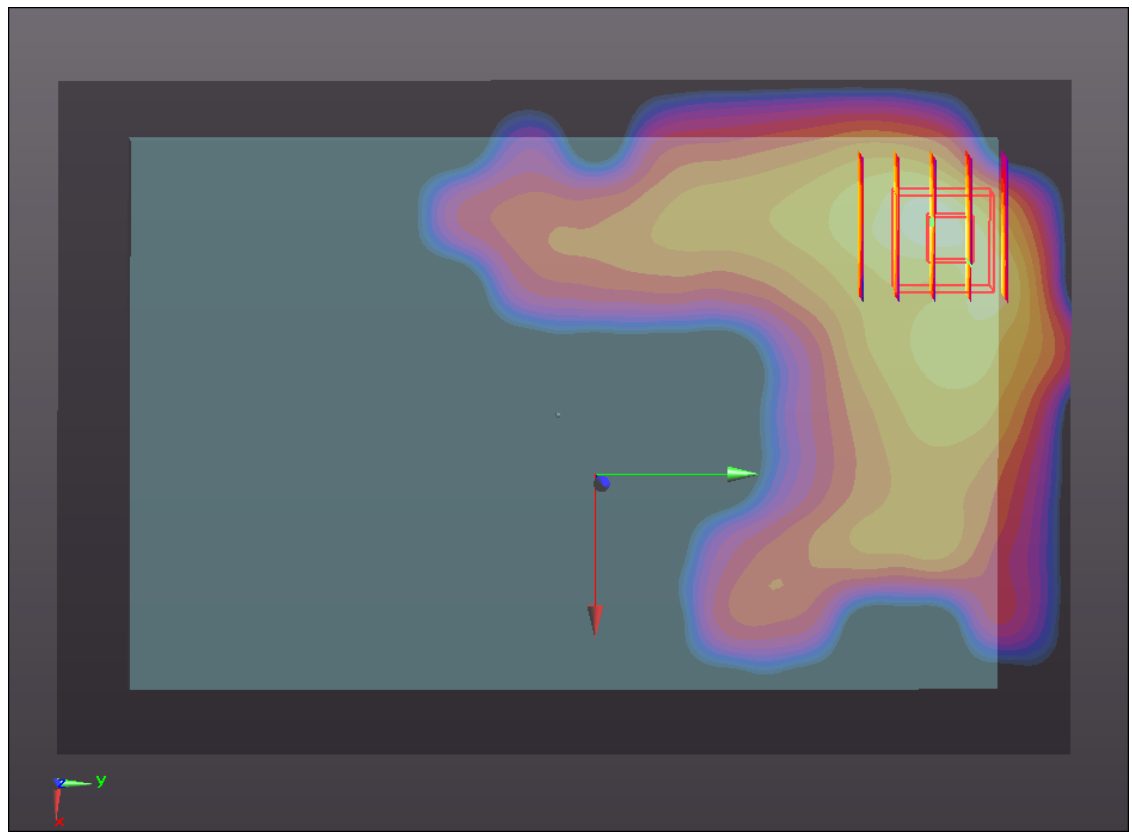
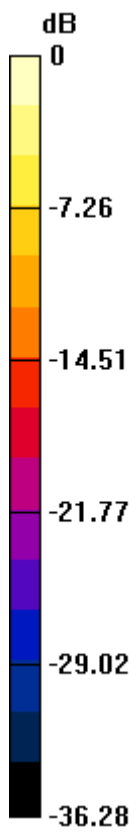

0 dB = 0.520mW/g