



**FCC 47 CFR PART 15 SUBPART C &
INDUSTRY CANADA RSS-210**

TEST REPORT

For

Tablet PC (WIFI)

**Model:
60015, 2298**

Trade Name: lenovo

Issued to

**Lenovo (Shanghai) Electronics Technology Co., Ltd.
No. 68 Building, 199 Fenju Road, Wai Gao Qiao FTZ , Shanghai , China**

Issued by

**Compliance Certification Services Inc.
No.11, Wu-Gong 6th Rd., Wugu Industrial Park,
New Taipei City 248, Taiwan (R.O.C.)
<http://www.ccsrf.com>
service@ccsrf.com
Issued Date: August 3, 2012**



Note: This report shall not be reproduced except in full, without the written approval of Compliance Certification Services Inc. This document may be altered or revised by Compliance Certification Services Inc. personnel only, and shall be noted in the revision section of the document.



Revision History

Rev.	Issue Date	Revisions	Effect Page	Revised By
00	August 3, 2012	Initial Issue	ALL	Angel Cheng



TABLE OF CONTENTS

1. TEST RESULT CERTIFICATION.....	4
2. EUT DESCRIPTION	5
3. TEST METHODOLOGY	6
3.1 EUT CONFIGURATION	6
3.2 EUT EXERCISE.....	6
3.3 GENERAL TEST PROCEDURES.....	6
3.4 FCC PART 15.205 RESTRICTED BANDS OF OPERATIONS.....	7
3.5 DESCRIPTION OF TEST MODES	8
4. INSTRUMENT CALIBRATION.....	9
4.1 MEASURING INSTRUMENT CALIBRATION	9
4.2 MEASUREMENT EQUIPMENT USED	9
4.3 MEASUREMENT UNCERTAINTY	10
5. FACILITIES AND ACCREDITATIONS	11
5.1 FACILITIES	11
5.2 EQUIPMENT.....	11
5.3 LABORATORY ACCREDITATIONS AND LISTING.....	11
5.4 TABLE OF ACCREDITATIONS AND LISTINGS.....	12
6. SETUP OF EQUIPMENT UNDER TEST	13
6.1 SETUP CONFIGURATION OF EUT.....	13
6.2 SUPPORT EQUIPMENT	13
7. APPLICABLE RULES FOR INDUSTRY CANADA RSS-210	14
8. FCC PART 15.247 REQUIREMENTS & RSS-210 REQUIREMENTS.....	23
8.1 ON TIME, DUTY CYCLE.....	23
8.2 99% BANDWIDTH	26
8.3 6DB BANDWIDTH.....	34
8.4 PEAK POWER.....	42
8.5 BAND EDGES MEASUREMENT	52
8.6 PEAK POWER SPECTRAL DENSITY.....	69
8.7 SPURIOUS EMISSIONS.....	77
8.8 RADIATED EMISSIONS	84
8.9 POWERLINE CONDUCTED EMISSIONS.....	101
APPENDIX I RADIO FREQUENCY EXPOSURE.....	104
APPENDIX II PHOTOGRAPHS OF TEST SETUP.....	105
APPENDIX 1 - PHOTOGRAPHS OF EUT	



1. TEST RESULT CERTIFICATION

Applicant: Lenovo (Shanghai) Electronics Technology Co., Ltd.
 No. 68 Building, 199 Fenju Road,
 Wai Gao Qiao FTZ , Shanghai , China

Equipment Under Test: Tablet PC (WIFI)

Trade Name: lenovo

Model: 60015, 2298

Date of Test: June 2 ~ August 1, 2012

APPLICABLE STANDARDS	
STANDARD	TEST RESULT
FCC 47 CFR Part 15 Subpart C & Industry Canada RSS-210 Issue 8 December, 2010	No non-compliance noted

We hereby certify that:

The above equipment was tested by Compliance Certification Services Inc. The test data, data evaluation, test procedures, and equipment configurations shown in this report were made in accordance with the procedures given in ANSI C63.4: 2003 and the energy emitted by the sample EUT tested as described in this report is in compliance with the requirements of FCC Rules Part 15.207, 15.209, 15.247 and Industry Canada RSS-210.

The test results of this report relate only to the tested sample EUT identified in this report.

Approved by:

Reviewed by:

Jason Lin
 Section Manager
 Compliance Certification Services Inc.

Gina Lo
 Section Manager
 Compliance Certification Services Inc.



2. EUT DESCRIPTION

Product	Tablet PC (WIFI)
Trade Name	lenovo
Model Number	60015, 2298
Model Discrepancy	All the specification and layout are identical except they come with different model numbers for marketing purposes.
Received Date	June 6, 2012
Power Rating	<p>1. VDC from Power adapter</p> <p>1) HuntKey / Model: HKA00905015-3C I/P: 100~240Vac 50/60Hz, 0.25A O/P: 5.0Vdc 1.5A</p> <p>2) HuntKey / Model: HKA00905015-LC I/P:100~240Vac 50/60Hz, 0.25A O/P:5.0Vdc 1.5A</p> <p>2. VDC from Battery Lenovo / L12T1P31 Rating: NOM: 3.7V, 13.7Wh, 3700mAh MIN: 3.7V, 13.7Wh, 3550mAh</p> <p>3. Powered from host device via USB cable</p>
Frequency Range	2412 ~ 2462 MHz
Transmit Power	<p>IEEE 802.11b mode: 19.82 dBm</p> <p>IEEE 802.11g mode: 21.90 dBm</p> <p>IEEE 802.11n HT 20 MHz mode: 21.90 dBm</p> <p>IEEE 802.11n HT 40 MHz mode: 22.63 dBm</p>
Modulation Technique	<p>IEEE 802.11b mode: DSSS (1, 2, 5.5 and 11 Mbps)</p> <p>IEEE 802.11g mode: OFDM (6, 9, 12, 18, 24, 36, 48 and 54 Mbps)</p> <p>IEEE 802.11n HT 20 MHz mode: OFDM (6.5, 13, 19.5, 26, 39, 52, 58.5, 65.0Mbps)</p> <p>IEEE 802.11n HT 40 MHz mode: OFDM (13.5, 27, 40.5, 54, 81, 108, 121.5, 135Mbps)</p>
Number of Channels	<p>IEEE 802.11b/g mode: 11 Channels</p> <p>IEEE 802.11n HT 20 MHz mode: 11 Channels</p> <p>IEEE 802.11n HT 40 MHz mode: 7 Channels</p>
Antenna Specification	PIFA Antenna / Gain: 4.0 dBi

Remark:

1. The sample selected for test was engineering sample that approximated to production product and was provided by manufacturer.
2. This submittal(s) (test report) is intended for FCC/IC ID: **O57A2107AF / 10407A-A2107AF** filing to comply with Section 15.207, 15.209 and 15.247 of the FCC Part 15, Subpart C and RSS-GEN & RSS-210Rules
3. For IC model number is 2298 only.



3. TEST METHODOLOGY

The tests documented in this report were performed in accordance with ANSI C63.4 and FCC CFR 47 2.1046, 2.1047, 2.1049, 2.1051, 2.1053, 2.1055, 2.1057, 15.207, 15.209 and 15.247.

The tests documented in this report were performed in accordance with IC RSS-210, IC RSS-Gen, IC RSS-102, IC RSS-212, and ANSI C63.4.

This submittal(s) (test report) is intended for IC Certification with Industry Canada RSS-210.

3.1 EUT CONFIGURATION

The EUT configuration for testing is installed on RF field strength measurement to meet the Commissions requirement and operating in a manner that intends to maximize its emission characteristics in a continuous normal application.

3.2 EUT EXERCISE

The EUT was operated in the engineering mode to fix the TX frequency that was for the purpose of the measurements.

According to its specifications, the EUT must comply with the requirements of the Section 15.207, 15.209 and 15.247 under the FCC Rules Part 15 Subpart C.

The tests documented in this report were performed in accordance with IC RSS-210, IC RSS-Gen, IC RSS-102, and ANSI C63.4.

3.3 GENERAL TEST PROCEDURES

Conducted Emissions

The EUT is placed on the turntable, which is 0.8 m above ground plane. According to the requirements in Section 13.1.4.1 of ANSI C63.4 Conducted emissions from the EUT measured in the frequency range between 0.15 MHz and 30MHz using CISPR Quasi-peak and average detector modes.

Radiated Emissions

The EUT is placed on a turn table, which is 0.8 m above ground plane. The turntable shall rotate 360 degrees to determine the position of maximum emission level. EUT is set 3m away from the receiving antenna, which varied from 1m to 4m to find out the highest emission. And also, each emission was to be maximized by changing the polarization of receiving antenna both horizontal and vertical. In order to find out the maximum emissions, exploratory radiated emission measurements were made according to the requirements in Section 13.1.4.1 of ANSI C63.4.



3.4 FCC PART 15.205 RESTRICTED BANDS OF OPERATIONS

(a) Except as shown in paragraph (d) of this section, only spurious emissions are permitted in any of the frequency bands listed below:

MHz	MHz	MHz	GHz
0.090 - 0.110	16.42 - 16.423	399.9 - 410	4.5 - 5.15
¹ 0.495 - 0.505	16.69475 - 16.69525	608 - 614	5.35 - 5.46
2.1735 - 2.1905	16.80425 - 16.80475	960 - 1240	7.25 - 7.75
4.125 - 4.128	25.5 - 25.67	1300 - 1427	8.025 - 8.5
4.17725 - 4.17775	37.5 - 38.25	1435 - 1626.5	9.0 - 9.2
4.20725 - 4.20775	73 - 74.6	1645.5 - 1646.5	9.3 - 9.5
6.215 - 6.218	74.8 - 75.2	1660 - 1710	10.6 - 12.7
6.26775 - 6.26825	108 - 121.94	1718.8 - 1722.2	13.25 - 13.4
6.31175 - 6.31225	123 - 138	2200 - 2300	14.47 - 14.5
8.291 - 8.294	149.9 - 150.05	2310 - 2390	15.35 - 16.2
8.362 - 8.366	156.52475 -	2483.5 - 2500	17.7 - 21.4
8.37625 - 8.38675	156.52525	2655 - 2900	22.01 - 23.12
8.41425 - 8.41475	156.7 - 156.9	3260 - 3267	23.6 - 24.0
12.29 - 12.293	162.0125 - 167.17	3332 - 3339	31.2 - 31.8
12.51975 - 12.52025	167.72 - 173.2	3345.8 - 3358	36.43 - 36.5
12.57675 - 12.57725	240 - 285	3600 - 4400	(²)
13.36 - 13.41	322 - 335.4		

¹ Until February 1, 1999, this restricted band shall be 0.490-0.510 MHz.

² Above 38.6

(b) Except as provided in paragraphs (d) and (e), the field strength of emissions appearing within these frequency bands shall not exceed the limits shown in Section 15.209. At frequencies equal to or less than 1000 MHz, compliance with the limits in Section 15.209 shall be demonstrated using measurement instrumentation employing a CISPR quasi-peak detector. Above 1000 MHz, compliance with the emission limits in Section 15.209 shall be demonstrated based on the average value of the measured emissions. The provisions in Section 15.35 apply to these measurements.



3.5 DESCRIPTION OF TEST MODES

The EUT (model: 60015) had been tested under operating condition.

Software used to control the EUT for staying in continuous transmitting mode was programmed.

After verification, all tests were carried out with the worst case test modes as shown below except radiated spurious emission below 1GHz and power line conducted emissions below 30MHz, which worst case was in normal link mode only.

IEEE 802.11b mode:

Channel Low (2412MHz), Channel Mid (2442MHz) and Channel High (2462MHz) with 1Mbps data rate were chosen for full testing.

IEEE 802.11g mode:

Channel Low (2412MHz), Channel Mid (2442MHz) and Channel High (2462MHz) with 6Mbps data rate were chosen for full testing.

IEEE 802.11n HT 20 MHz mode:

Channel Low (2412MHz), Channel Mid (2442MHz) and Channel High (2462MHz) with 6.5Mbps data rate were chosen for full testing.

IEEE 802.11n HT 40 MHz mode:

Channel Low (2422MHz), Channel Mid (2442MHz) and Channel High (2452MHz) with 13.5Mbps data rate were chosen for full testing.

The field strength of spurious emission was measured in the following position: EUT stand-up position (Z axis), lie-down position (X, Y axis). The worst emission was found in lie-down position (Y axis) and the worst case was recorded.



4. INSTRUMENT CALIBRATION

4.1 MEASURING INSTRUMENT CALIBRATION

The measuring equipment, which was utilized in performing the tests documented herein, has been calibrated in accordance with the manufacturer's recommendations for utilizing calibration equipment, which is traceable to recognized national standards.

4.2 MEASUREMENT EQUIPMENT USED

Equipment Used for Emissions Measurement

Remark: Each piece of equipment is scheduled for calibration once a year and Loop Antenna is scheduled for calibration once three years.

Conducted Emissions Test Site				
Name of Equipment	Manufacturer	Model	Serial Number	Calibration Due
Spectrum Analyzer	Agilent	E4446A	MY43360131	03/16/2013
Power Meter	Anritsu	ML2495A	1012009	04/26/2013
Power Sensor	Anritsu	MA2411B	0917072	04/26/2013

Wugu 966 Chamber A				
Name of Equipment	Manufacturer	Model	Serial Number	Calibration Due
Spectrum Analyzer	Agilent	E4446A	US42510252	11/02/2012
EMI Test Receiver	R&S	ESCI	100064	02/16/2013
Pre-Amplifier	Mini-Circuits	ZFL-1000LN	SF350700823	01/12/2013
Pre-Amplifier	MITEQ	AFS44-00102650-42-10P-44	1415367	11/19/2012
Bilog Antenna	Sunol Sciences	JB3	A030105	10/03/2012
Horn Antenna	EMCO	3117	00055165	01/11/2013
Horn Antenna	EMCO	3116	00026370	10/12/2012
Loop Antenna	EMCO	6502	8905/2356	06/10/2013
Turn Table	CCS	CC-T-1F	N/A	N.C.R
Antenna Tower	CCS	CC-A-1F	N/A	N.C.R
Controller	CCS	CC-C-1F	N/A	N.C.R
Site NSA	CCS	N/A	N/A	12/25/2012
Test S/W	EZ-EMC (CCS-3A1RE)			

Conducted Emission room # B				
Name of Equipment	Manufacturer	Model	Serial Number	Calibration Due
EMI Test Receiver	R&S	ESCI	101073	07/28/2012
LISN	R&S	ENV216	101054	06/06/2013
LISN	SCHWARZBECK	NSLK 8127	8127-541	12/14/2012
Coaxial Cable	Commate	CFD300-NL	NA	05/27/2013
Capacitive Voltage Probe	FCC	F-CVP-1	100185	02/15/2013
Test S/W	CCS-3A1-CE			



4.3 MEASUREMENT UNCERTAINTY

PARAMETER	UNCERTAINTY
Powerline Conducted Emission	+/- 1.2575
3M Semi Anechoic Chamber / 30M~200M	+/- 4.0138
3M Semi Anechoic Chamber / 200M~1000M	+/- 3.9483
3M Semi Anechoic Chamber / 1G~8G	+/- 2.5975
3M Semi Anechoic Chamber / 8G~18G	+/- 2.6112
3M Semi Anechoic Chamber / 18G~26G	+/- 2.7389
3M Semi Anechoic Chamber / 26G~40G	+/- 2.9683

Remark: This uncertainty represents an expanded uncertainty expressed at approximately the 95% confidence level using a coverage factor of $k=2$.



5. FACILITIES AND ACCREDITATIONS

5.1 FACILITIES

All measurement facilities used to collect the measurement data are located at

No.199, Chunghsen Road, Hsintien City, Taipei Hsien, Taiwan, R.O.C.
Tel: 886-2-2217-0894 / Fax: 886-2-2217-1029

No.11, Wu-Gong 6th Rd., Wugu Industrial Park, New Taipei City 248, Taiwan (R.O.C.)
Tel: 886-2-2299-9720 / Fax: 886-2-2298-4045

No.81-1, Lane 210, Bade 2nd Rd., Lujhu Township, Taoyuan County 33841, TAIWAN,
R.O.C.
Tel: 886-3-324-0332 / Fax: 886-3-324-5235

The sites are constructed in conformance with the requirements of ANSI C63.7, ANSI C63.4 and CISPR Publication 22.

5.2 EQUIPMENT

Radiated emissions are measured with one or more of the following types of linearly polarized antennas: tuned dipole, biconical, log periodic, bi-log, and/or ridged waveguide, horn. Spectrum analyzers with pre-selectors and quasi-peak detectors are used to perform radiated measurements.

Conducted emissions are measured with Line Impedance Stabilization Networks and EMI Test Receivers.

Calibrated wideband preamplifiers, coaxial cables, and coaxial attenuators are also used for making measurements.



All receiving equipment conforms to CISPR Publication 16-1, "Radio Interference Measuring Apparatus and Measurement Methods."

5.3 LABORATORY ACCREDITATIONS AND LISTING

The test facilities used to perform radiated and conducted emissions tests are accredited by American Association for Laboratory Accreditation Program for the specific scope accreditation under Lab Code: 0824-01 to perform Electromagnetic Interference tests according to FCC Part 15 and CISPR 22 requirements. In addition, the test facilities are listed with Industry Canada, Certification and Engineering Bureau, IC 2324G-1 for 3M Semi Anechoic Chamber A, 2324G-2 for 3M Semi Anechoic Chamber B.



5.4 TABLE OF ACCREDITATIONS AND LISTINGS

Country	Agency	Scope of Accreditation	Logo
USA	FCC	3M Semi Anechoic Chamber (FCC MRA: TW1039) to perform FCC Part 15 measurements	 FCC MRA: TW1039
Taiwan	TAF	LP0002, RTTE01, FCC Method-47 CFR Part 15 Subpart C, D, E, RSS-210, RSS-310 IDA TS SRD, AS/NZS 4268, AS/NZS 4771, TS 12.1 & 12.2, ETSI EN 300 440-1, ETSI EN 300 440-2, ETSI EN 300 328, ETSI EN 300 220-1, ETSI EN 300 220-2, ETSI EN 301 893, ETSI EN 301 489-1/3/7/17 FCC OET Bulletin 65 + Supplement C, EN 50360, EN 50361, EN 50371, RSS 102, EN 50383, EN 50385, EN 50392, IEC 62209, CNS 14958-1, CNS 14959 FCC Method -47 CFR Part 15 Subpart B IEC / EN 61000-3-2, IEC / EN 61000-3-3, IEC / EN 61000-4-2/3/4/5/6/8/11	
Canada	Industry Canada	3M Semi Anechoic Chamber (IC 2324G-1 / IC 2324G-2) to perform	 IC 2324G-1 IC 2324G-2

* No part of this report may be used to claim or imply product endorsement by A2LA or any agency of the US Government.



6. SETUP OF EQUIPMENT UNDER TEST

6.1 SETUP CONFIGURATION OF EUT

See test photographs attached in Appendix II for the actual connections between EUT and support equipment.

6.2 SUPPORT EQUIPMENT

No	Device Type	Brand	Model	Series No.	FCC ID	Data Cable	Power Cord
1.	Headset	N/A	N/A	N/A	N/A	Unshielded, 1.1m	N/A
2.	Micro SD Card	SANDISK	N/A	N/A	N/A	N/A	N/A
3.	Wireless Router (Remote)	ASUS	WL-500g	471GA12838	MSQWL500G	N/A	Unshielded, 1.8m
4.	Bluetooth Headset (Remote)	COREGA	CG-BTHS01-10	10T90020500124	N/A	N/A	N/A

Remark:

1. All the equipment/cables were placed in the worst-case configuration to maximize the emission during the test.
2. Grounding was established in accordance with the manufacturer's requirements and conditions for the intended use.



7. APPLICABLE RULES FOR INDUSTRY CANADA RSS-210

RSS-210 §2 General Certification Requirements and Specifications

RSS-210 §2.1 RSS-Gen Compliance

In addition to RSS-210, the requirements in RSS-Gen, *General Requirements and Information for the Certification of Radio Apparatus*, must be met.

RSS-210 §2.2 Emissions Falling Within Restricted Frequency Bands

Category I licence-exempt equipment is required to comply with the provisions in RSS-Gen with respect to emissions falling within restricted frequency bands. These restricted frequency bands are listed in RSS-Gen.

RSS-210 §2.3 Receivers

Category I equipment receivers for use with transmitters subject to RSS-210 must comply with the applicable requirements set out in RSS-Gen and be certified under RSS-210. Category II equipment receivers for use with transmitters subject to RSS-210 are exempt from certification, but are subject to compliance with RSS-Gen and RSS-310.

RSS-210 §2.5 General Field Strength Limits

RSS-Gen includes the general field strength limits of unwanted emissions, where applicable, for transmitters and receivers operating in accordance with the provisions specified in this standard. Unwanted emissions of transmitters and receivers are permitted to fall within the restricted bands listed in RSS-Gen, and including the TV bands, but fundamental emissions are prohibited in the restricted bands.

RSS-210 §2.5.1 Transmitters with Wanted Emissions that are Within the General Field Strength Limits

Whether or not their operation is addressed by published RSS standards, transmitters whose wanted and unwanted emissions are within the general field strength limits shown in RSS-Gen, they may operate in any of the frequency bands, other than the restricted bands listed in RSS-Gen and including the TV bands, and shall be certified under RSS-210. Under no conditions may the level of any unwanted emissions exceed the level of the fundamental emission.

Note: Devices operating below 490 kHz in which all emissions are at least 40 dB below the limit listed in RSS-Gen (*General Field Strength Limits for Transmitters at Frequencies below 30 MHz*) are Category II devices and are subject to RSS-310.



RSS-210 §2.7 Tables

RSS-210 §Annex 8: Frequency Hopping and Digital Modulation Systems Operating in the 902-928 MHz, 2400-2483.5 MHz, and 5725-5850 MHz Bands

This section applies to systems that employ frequency hopping (FH) and digital modulation technology in the 902-928 MHz, 2400-2483.5 MHz and 5725-5850 MHz bands. Systems in these bands may employ frequency hopping, digital modulation and or a combination (hybrid) of both techniques.

A frequency hopping system that synchronizes with another or several other systems (to avoid frequency collision among them) via off-air sensing or via connecting cables is not hopping randomly and therefore is not in compliance with RSS-210.

RSS-210 §A8.1 Frequency Hopping Systems

Frequency hopping systems are spread spectrum systems in which the carrier is modulated with coded information in a conventional manner causing a conventional spreading of the RF energy about the carrier frequency. The frequency of the carrier is not fixed but changes at fixed intervals under the direction of a coded sequence.

Frequency hopping systems are not required to employ all available hopping frequencies during each transmission. However, the system, consisting of both the transmitter and the receiver, must be designed to comply with all of the regulations in this section should the transmitter be presented with a continuous data (or information) stream.

Incorporation of intelligence into a frequency hopping system that enables it to recognize other users of the band and to avoid occupied frequencies is permitted, provided that the frequency hopping system does it individually, and independently chooses or adapts its hopset. The coordination of frequency hopping systems in any other manner for the express purpose of avoiding the simultaneous occupancy of individual hopping frequencies by multiple transmitters is not permitted.

The following applies to frequency hopping systems in each of the three bands.

(a) The bandwidth of a frequency hopping channel is the 20 dB emission bandwidth, measured with the hopping stopped. The system RF bandwidth is equal to the channel bandwidth multiplied by the number of channels in the hopset. The hopset shall be such that the near term distribution of frequencies appears random, with sequential hops randomly distributed in both direction and magnitude of change in the hopset while the long term distribution appears evenly distributed.



(b) Frequency hopping systems shall have hopping channel carrier frequencies separated by a minimum of 25 kHz or the 20 dB bandwidth of the hopping channel, whichever is greater. Alternatively, frequency hopping systems operating in the 2400-2483.5 MHz band may have hopping channel carrier frequencies that are separated by 25 kHz or two-thirds of the 20 dB bandwidth of the hopping channel, whichever is greater, provided the systems operate with an output power no greater than 0.125 W. The system receivers shall have input bandwidths that match the hopping channel bandwidths of their corresponding transmitters and shall shift frequencies in synchronization with the transmitted signals.

(d) Frequency hopping systems operating in the 2400-2483.5 MHz band shall use at least 15 hopping channels. The average time of occupancy on any channel shall not be greater than 0.4 seconds within a period of 0.4 seconds multiplied by the number of hopping channels employed. Transmissions on particular hopping frequencies may be avoided or suppressed provided that a minimum of 15 hopping channels are used.

RSS-210 §A8.2 Digital Modulation Systems

These include systems employing digital modulation techniques resulting in spectral characteristics similar to direct sequence systems. The following applies to all three bands.

RSS-210 §A8.4 Transmitter Output Power and e.i.r.p. Requirements

(4) For systems employing digital modulation techniques operating in the 902-928 MHz, 2400-2483.5 MHz and 5725-5850 MHz bands, the maximum peak conducted power shall not exceed 1 W. Except as provided in Section A8.4(5), the e.i.r.p. shall not exceed 4 W.

As an alternative to a peak power measurement, compliance can be based on a measurement of the maximum conducted output power (see RSS-Gen)

(5) Point-to-point systems in the bands 2400-2483.5 MHz and 5725-5850 MHz are permitted to have an e.i.r.p. higher than 4 W, provided that the higher e.i.r.p. is achieved by employing higher gain directional antennas and not higher transmitter output powers. Point-to-multipoint systems, omni-directional applications and multiple co-located transmitters transmitting the same information are prohibited from exceeding 4 W e.i.r.p. However, remote stations of point-to-multipoint systems shall be allowed to operate at greater than 4 W e.i.r.p. under the same conditions as for point-to-point systems.

Note: "Fixed, point-to-point operation", excludes point-to-multipoint systems, omnidirectional applications and multiple co-located transmitters transmitting the same information.



RSS-210 §A8.5 Out-of-band Emissions

In any 100 kHz bandwidth outside the frequency band in which the spread spectrum or digitally modulated device is operating, the radio frequency power that is produced shall be at least 20 dB below that in the 100 kHz bandwidth within the band that contains the highest level of the desired power, based on either an RF conducted or a radiated measurement, provided the transmitter demonstrates compliance with the peak conducted power limits. If the transmitter complies with the conducted power limits based on the use of RMS averaging over a time interval, as permitted under section A8.4(4), the attenuation required shall be 30 dB instead of 20 dB. Attenuation below the general limits specified in Tables 2 and 3 is not required.

RSS-Gen §2 General Information

RSS-Gen §2.1.2 Category II Equipment

Category II equipment comprises radio devices where a standard has been prescribed but for which a TAC is not required, that is, equipment certification by Industry Canada or a Certification Body (CB) is not required (certification exempt), pursuant to subsection 4(3) of the Radiocommunication Act. The manufacturer or importer shall nevertheless ensure that the standards are complied with. A test report shall be available on request and the device shall be properly labelled.

RSS-Gen §2.2 Receivers

Receivers that are used for radiocommunication other than broadcasting are defined as Category I equipment or Category II equipment, subject to compliance with applicable Industry Canada standards.

Receivers shall be capable of operation only with transmitters for which RSSs are published. Receivers are classified as described in sections 2.2.1 and 2.2.2.

RSS-Gen §2.2.1 Category I Equipment Receivers

A receiver is classified as Category I equipment if it meets one of the following conditions:

- (a) a stand-alone receiver (see Note 1, below), which operates on any frequency in the band 30-960 MHz, and is used for the reception of signals in that frequency band from a transmitter classified as Category I equipment;
- (b) a Citizen's Band (CB) receiver (26.96-27.410 MHz);
- (c) a scanner receiver.

Note 1: A *stand-alone receiver* is defined as any receiver that is not permanently combined together with a transmitter in a single case (transceiver), in which it functions as the receiver component of the transceiver.

Receivers classified as Category I equipment shall comply with the limits for receiver spurious emissions set out in RSS-Gen; however, equipment certification is granted under the applicable RSS standard along with the associated transmitter classified as Category I equipment. Scanner receivers are covered under their own specific RSS.

RSS-Gen §2.2.2 Category II Equipment Receivers

A receiver is classified as Category II equipment if it does not meet any of the conditions of Section 2.2.1.

Category II receivers shall comply with the applicable testing, labelling and user manual requirements in RSS-310.



RSS-Gen §5.6 Exposure of Humans to RF Fields

Category I and Category II equipment shall comply with the applicable requirements of RSS-102.

RSS-Gen §6 Receiver Spurious Emission Standard

Receivers shall comply with the limits of spurious emissions set out in this section, measured over the frequency range determined in accordance with Section 4.10.

RSS-Gen §6.1 Radiated Limits

Radiated spurious emission measurements shall be performed with the receiver antenna connected to the receiver antenna terminals.

Spurious emissions from receivers shall not exceed the radiated limits shown in the table below:

RSS-Gen Table 2 - Spurious Emission Limits for Receivers

Frequency (MHz)	Field Strength microvolts/m at 3 metres
30-88	100
88-216	150
216-960	200
Above 960	500

*Measurements for compliance with limits in the above table may be performed at distances other than 3 metres, in accordance with Section 7.2.7.

**RSS- Gen Table 3: Restricted Frequency Bands** ^(Note)

MHz	MHz	MHz	MHz	GHz
0.090-0.110	8.37625-8.38675	--	1718.8-1722.2	9.0-9.2
--	8.41425-8.41475	156.52475-156.52525	2200-2300	9.3-9.5
2.1735-2.1905	12.29-12.293	156.7-156.9	2310-2390	10.6-12.7
3.020-3.026	12.51975-12.52025	--	--	13.25-13.4
4.125-4.128	12.57675-12.57725	--	2655-2900	14.47-14.5
4.17725-4.17775	13.36-13.41	240-285	3260-3267	15.35-16.2
4.20725-4.20775	16.42-16.423	322-335.4	3332-3339	17.7-21.4
5.677-5.683	16.69475-16.69525	399.9-410	3345.8-3358	22.01-23.12
6.215-6.218	16.80425-16.80475	608-614	3500-4400	23.6-24.0
6.26775-6.26825	25.5-25.67	960-1427	4500-5150	31.2-31.8
6.31175-6.31225	37.5-38.25	1435-1626.5	5350-5460	36.43-36.5
8.291-8.294	73-74.6; 74.8-75.2	1645.5-1646.5	7250-7750	Above 38.6
8.362-8.366	108-138	1660-1710	8025-8500	

Note: Certain frequency bands listed in Table 2 and above 38.6 GHz are designated for low-power licence-exempt applications. These frequency bands and the requirements that apply to the devices are set out in this Standard as well as RSS-310.

RSS- Gen Table 5: General Field Strength Limits for Transmitters at Frequencies Above 30 MHz

Frequency (MHz)	Field Strength (microvolt/m at 3 metres)
30-88	100
88-216	150
216-960	200
Above 960	500

Note: Transmitting devices are not permitted in Table 1 bands or, unless stated otherwise, in TV bands (54-72 MHz, 76-88 MHz, 174-216 MHz, 470-608 MHz and 614-806 MHz).



RSS- Gen Table 6: General Field Strength Limits for Transmitters at Frequencies Below 30 MHz (Transmit)

Frequency (fundamental or spurious)	Field Strength (microvolts/m)	Magnetic H-Field (microamperes/m)	Measurement Distance (metres)
9-490 kHz	2,400/F (F in kHz)	2,400/377F (F in Hz)	300
490-1.705 kHz	24,000/F (F in kHz)	24,000/377F (F in kHz)	30
1.705-30 MHz	30	N/A	30

Note: The emission limits for the bands 9-90 kHz and 110-490 kHz are based on measurements employing an average detector.



RSS-Gen §7.1.2 Transmitter Antenna

A transmitter can only be sold or operated with antennas with which it was approved. Transmitter may be approved with multiple antenna types. An antenna type comprises antennas having similar in-band and out-of-band radiation patterns. Testing shall be performed using the highest gain antenna of each combination of transmitter and antenna type for which approval is being sought, with the transmitter output power set at the maximum level. Any antenna of the same type having equal or lesser gain as an antenna that had been successfully tested with the transmitter, will also be considered approved with the transmitter, and may be used and marketed with the transmitter. For Category I transmitters, the manufacturer shall include with the application for certification a list of acceptable antenna types to be used with the transmitter.

When a measurement at the antenna connector is used to determine RF output power, the effective gain of the device's antenna shall be stated, based on measurement or on data from the antenna manufacturer.

For transmitters of RF output power of 10 milliwatts or less, only the portion of the antenna gain that is in excess of 6 dBi (6 dB above isotropic gain) shall be added to the measured RF output power to demonstrate compliance with the radiated power limits specified in the applicable standard. For transmitters of output power greater than 10 milliwatts, the total antenna gain shall be added to the measured RF output power to demonstrate compliance to the specified radiated power limits. User manuals for transmitters shall display the following notice in a conspicuous location:

Under Industry Canada regulations, this radio transmitter may only operate using an antenna of a type and maximum (or lesser) gain approved for the transmitter by Industry Canada. To reduce potential radio interference to other users, the antenna type and its gain should be so chosen that the equivalent isotropically radiated power (e.i.r.p.) is not more than that necessary for successful communication.

The above notice may be affixed to the device instead of displayed in the user manual.

User manuals for transmitters equipped with detachable antennas shall also contain the following notice in a conspicuous location:

This radio transmitter (identify the device by certification number, or model number if Category II) has been approved by Industry Canada to operate with the antenna types listed below with the maximum permissible gain and required antenna impedance for each antenna type indicated. Antenna types not included in this list, having a gain greater than the maximum gain indicated for that type, are strictly prohibited for use with this device.

Immediately following the above notice, the manufacturer shall provide a list of all antenna types approved for use with the transmitter, indicating the maximum permissible antenna gain (in dBi) and required impedance for each.



RSS-Gen §7.2.4 Transmitter and Receiver AC Power Lines Conducted Emission Limits

Except when the requirements applicable to a given device state otherwise, for any radio apparatus equipped to operate from the public utility AC power supply, either directly or indirectly (such as with a battery charger), the radio frequency voltage of emissions conducted back onto the AC power lines in the frequency range of 0.15 MHz to 30 MHz shall not exceed the limits shown in the table below. The more stringent limit applies at the frequency range boundaries.

The conducted emissions shall be measured with a 50 ohm/50 microhenry line impedance stabilization network (LISN).

RSS-Gen Table 4 – AC Power Line Conducted Emission Limits

Frequency Range (MHz)	Conducted limit (dBµV)	
	Quasi-peak	Average
0.15 to 0.5	66 to 56*	56 to 46*
0.5 to 5	56	46
5 to 30	60	50

**Decreases with the logarithm of the frequency.*



8. FCC PART 15.247 REQUIREMENTS & RSS-210 REQUIREMENTS

8.1 ON TIME, DUTY CYCLE

LIMIT

KDB 558074 D01 DTS Meas Guidance v01

TEST PROCEDURE

The transmitter output is connected to a spectrum analyzer or radiated field strength. The RBW is set to 1 MHz and the VBW is set to 1 MHz. The sweep time is coupled and the span is set to 0 Hz.

TEST RESULTS

Mode	ON Time (msec)	Period (msec)	Duty Cycle (%)
IEEE 802.11b mode	8.346	8.461	99
IEEE 802.11g mode	1.373	1.496	92
IEEE 802.11n HT 20 MHz mode	1.285	1.399	92
IEEE 802.11n HT 40 MHz mode	0.6368	0.7504	85



Duty Cycle Plots

IEEE 802.11b mode

Agilent 12:38:01 Jun 2, 2012

R T

Mkr2 8.461 ms
-71.47 dB

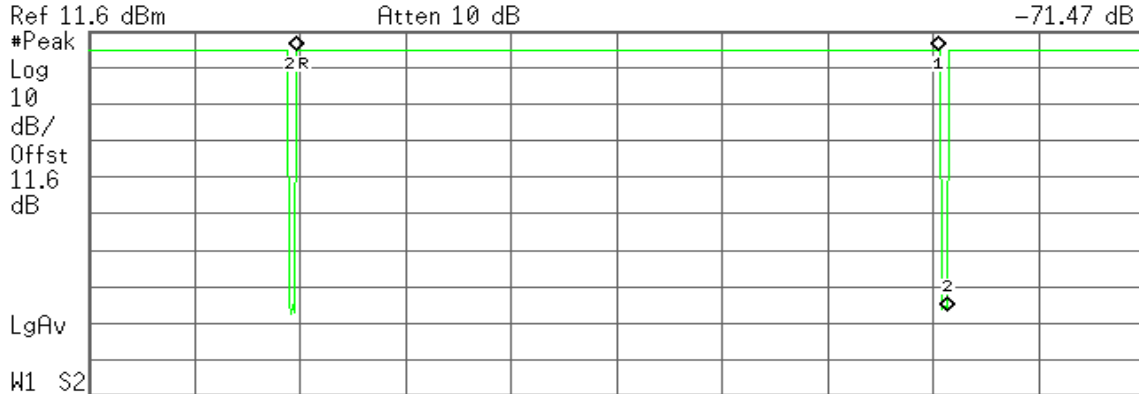

Ref 11.6 dBm Atten 10 dB

Center 2.412 000 GHz Span 0 Hz

Res BW 1 MHz VBW 1 MHz Sweep 13.72 ms (601 pts)

Marker	Trace	Type	X Axis	Amplitude
1R	(1)	Time	2.698 ms	6.35 dBm
1Δ	(1)	Time	8.346 ms	-0.02 dB
2R	(1)	Time	2.698 ms	6.35 dBm
2Δ	(1)	Time	8.461 ms	-71.47 dB

IEEE 802.11g mode

Agilent 12:39:30 Jun 2, 2012

R T

Mkr2 1.496 ms
-16.01 dB



Ref 11.6 dBm Atten 10 dB

Center 2.412 000 GHz Span 0 Hz

Res BW 1 MHz VBW 1 MHz Sweep 1.76 ms (601 pts)

Marker	Trace	Type	X Axis	Amplitude
1R	(1)	Time	123.2 μs	-0.36 dBm
1Δ	(1)	Time	1.373 ms	1.43 dB
2R	(1)	Time	123.2 μs	-0.36 dBm
2Δ	(1)	Time	1.496 ms	-16.01 dB



IEEE 802.11n HT 20 MHz mode

Agilent 12:41:19 Jun 2, 2012

R T

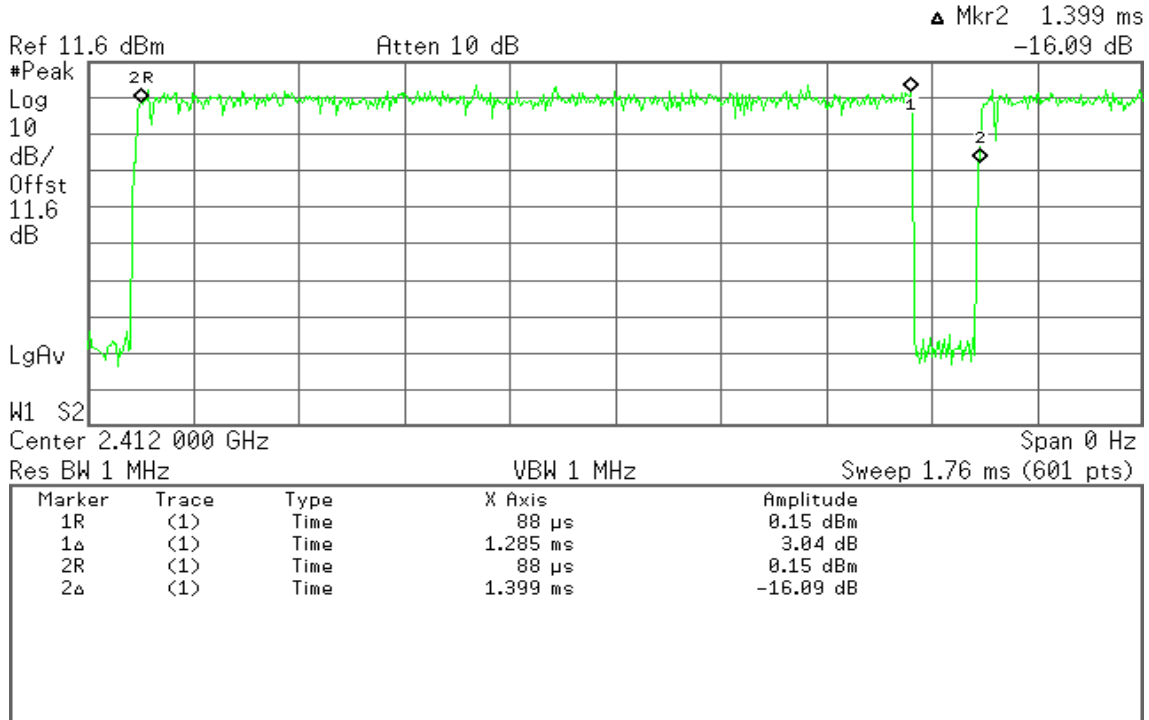

IEEE 802.11n HT 40 MHz mode

Agilent 12:42:42 Jun 2, 2012

R T

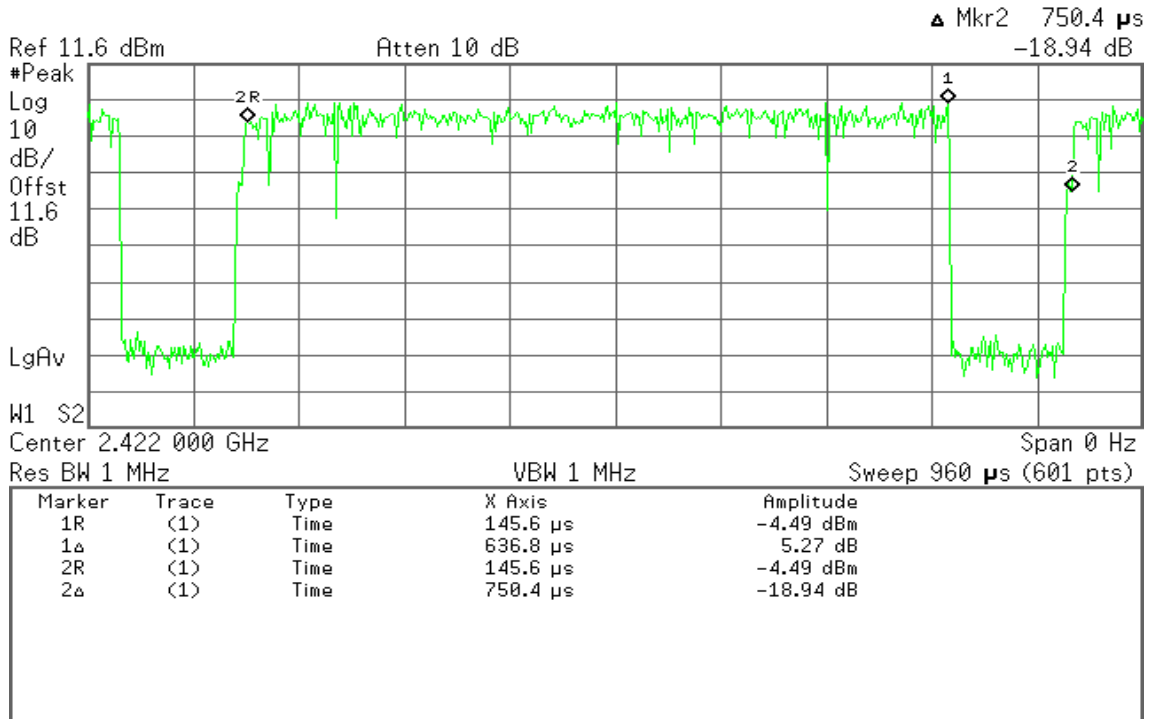



8.299% BANDWIDTH

Test Configuration

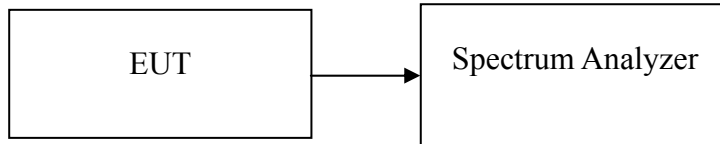

TEST PROCEDURE

The resolution bandwidth shall be set to as close to 1% of the selected span as is possible without being below 1%. The video bandwidth shall be set to 3 times the resolution bandwidth. Video averaging is not permitted. Where practical, a sampling detector shall be used since a peak or, peak hold.



Test Data

Test mode: IEEE 802.11b mode

Channel	Frequency (MHz)	99% Bandwidth (MHz)
Low	2412	11.7636
Mid	2442	11.5785
High	2462	11.8070

Test mode: IEEE 802.11g mode

Channel	Frequency (MHz)	99% Bandwidth (MHz)
Low	2412	16.7137
Mid	2442	16.7003
High	2462	16.7335

Test mode: IEEE 802.11n HT 20 MHz mode Channel mode

Channel	Frequency (MHz)	99% Bandwidth (MHz)
Low	2412	17.7557
Mid	2442	17.7691
High	2462	17.7501

Test mode: draft 802.11n Standard-40 MHz Channel mode

Channel	Frequency (MHz)	99% Bandwidth (MHz)
Low	2422	36.0756
Mid	2442	36.0994
High	2452	35.9971



Test Plot

IEEE 802.11b mode

99% Bandwidth (CH Low)

Agilent 18:48:20 Aug 1, 2012

R T

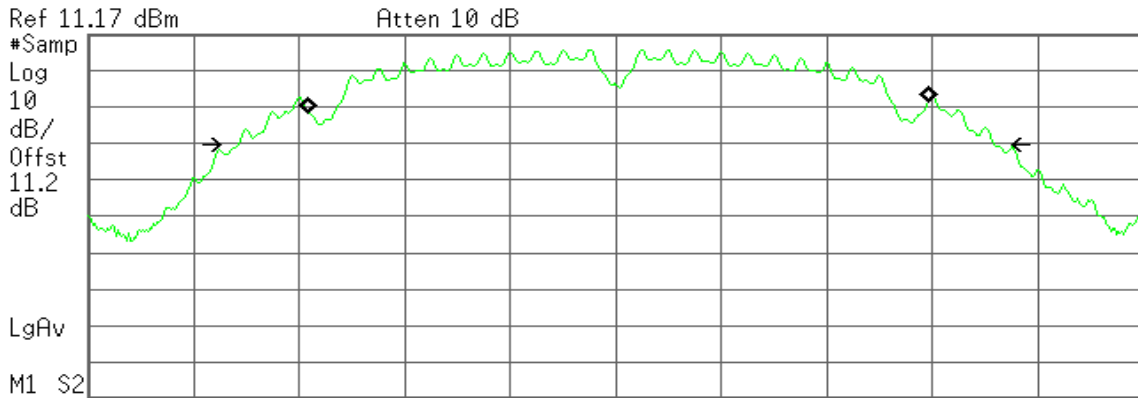

Center 2.412 00 GHz Span 20 MHz
 #Res BW 200 kHz #VBW 620 kHz Sweep 1.52 ms (601 pts)

Occupied Bandwidth
11.7636 MHz

Occ BW % Pwr 99.00 %
x dB -26.00 dB

Transmit Freq Error 48.200 kHz
x dB Bandwidth 14.302 MHz*

99% Bandwidth (CH Mid)

Agilent 18:48:49 Aug 1, 2012

R T

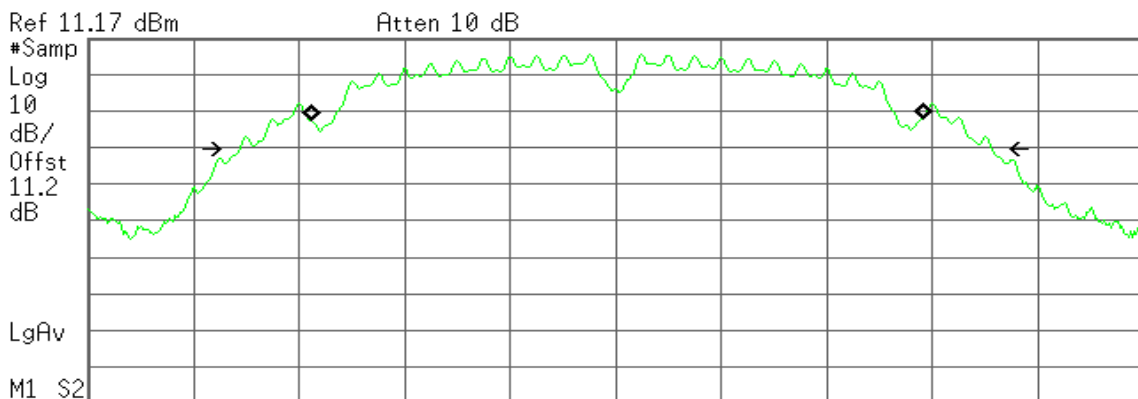

Center 2.442 00 GHz Span 20 MHz
 #Res BW 200 kHz #VBW 620 kHz Sweep 1.52 ms (601 pts)

Occupied Bandwidth
11.5785 MHz

Occ BW % Pwr 99.00 %
x dB -26.00 dB

Transmit Freq Error 28.484 kHz
x dB Bandwidth 14.240 MHz*



99% Bandwidth (CH High)

Agilent 18:49:29 Aug 1, 2012

R T

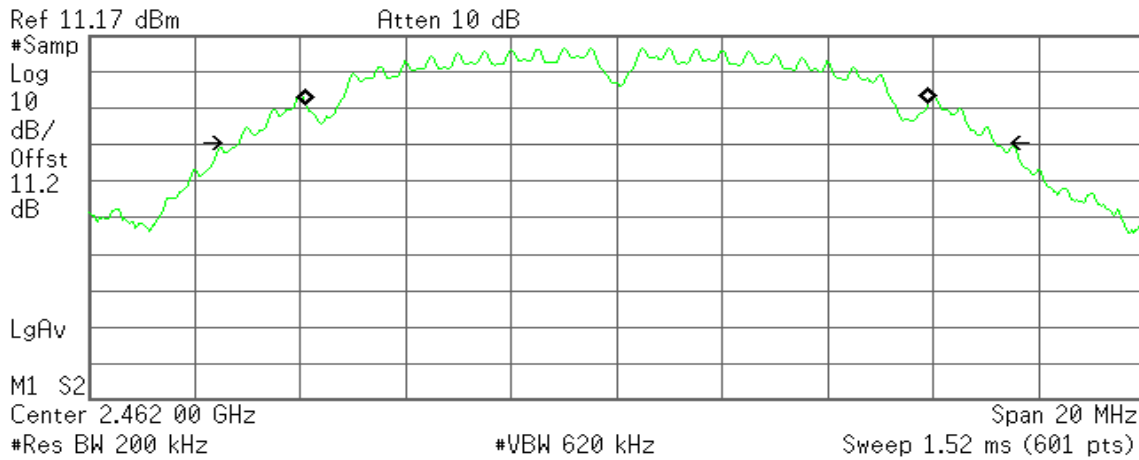

Occupied Bandwidth
11.8070 MHz

Occ BW % Pwr 99.00 %
x dB -26.00 dB

Transmit Freq Error 8.025 kHz
x dB Bandwidth 14.297 MHz*

IEEE 802.11g mode

99% Bandwidth (CH Low)

Agilent 18:50:52 Aug 1, 2012

R T

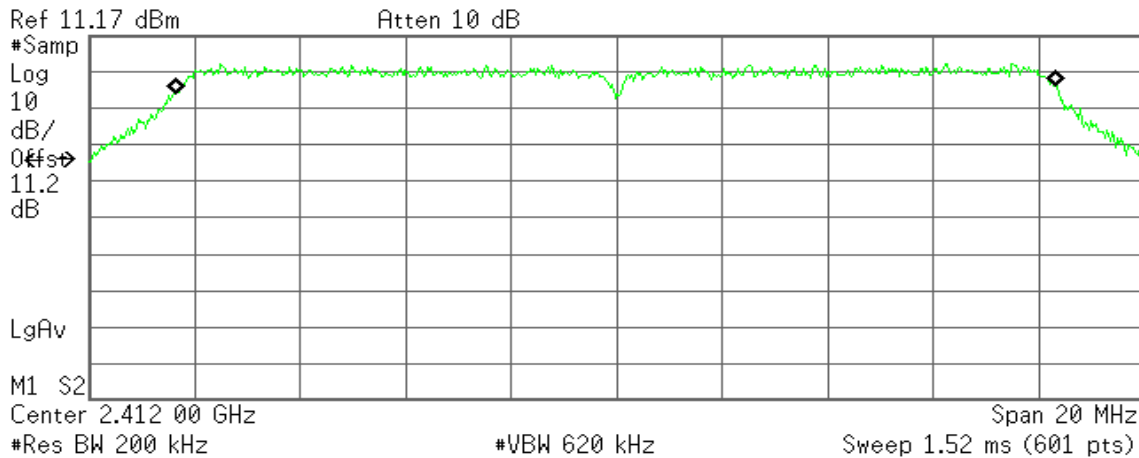

Occupied Bandwidth
16.7137 MHz

Occ BW % Pwr 99.00 %
x dB -26.00 dB

Transmit Freq Error -10.682 kHz
x dB Bandwidth 19.929 MHz*



99% Bandwidth (CH Mid)

Agilent 18:50:36 Aug 1, 2012

R T

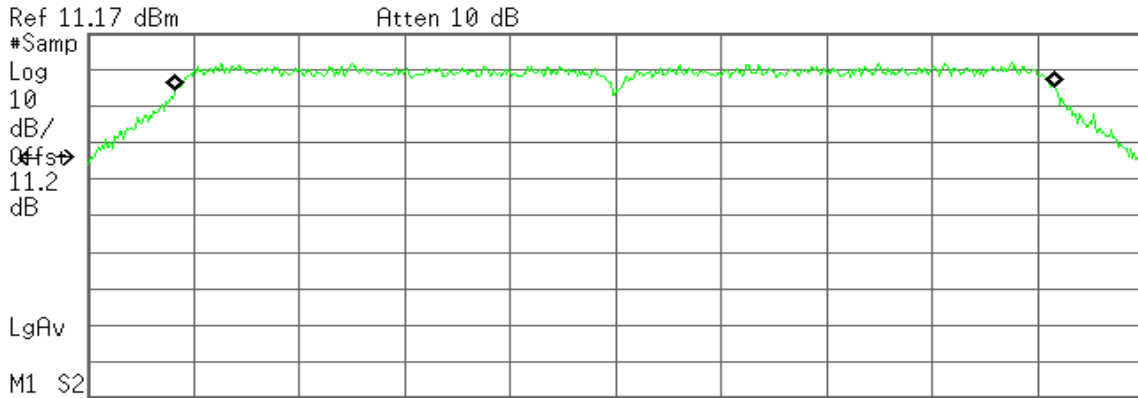

Ref 11.17 dBm Atten 10 dB

Center 2.442 00 GHz Span 20 MHz

#Res BW 200 kHz #VBW 620 kHz Sweep 1.52 ms (601 pts)

Occupied Bandwidth
16.7003 MHz

Occ BW % Pwr 99.00 %
x dB -26.00 dB

Transmit Freq Error -10.393 kHz
x dB Bandwidth 19.791 MHz*

99% Bandwidth (CH High)

Agilent 18:50:02 Aug 1, 2012

R T

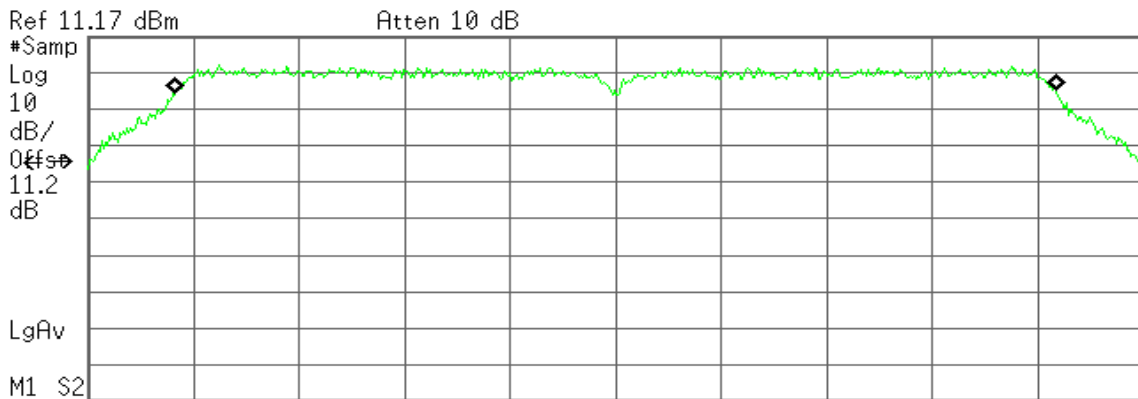

Ref 11.17 dBm Atten 10 dB

Center 2.462 00 GHz Span 20 MHz

#Res BW 200 kHz #VBW 620 kHz Sweep 1.52 ms (601 pts)

Occupied Bandwidth
16.7335 MHz

Occ BW % Pwr 99.00 %
x dB -26.00 dB

Transmit Freq Error -10.845 kHz
x dB Bandwidth 19.944 MHz*



IEEE 802.11n HT 20 MHz mode Channel mode

99% Bandwidth (CH Low)

Agilent 18:51:11 Aug 1, 2012

R T

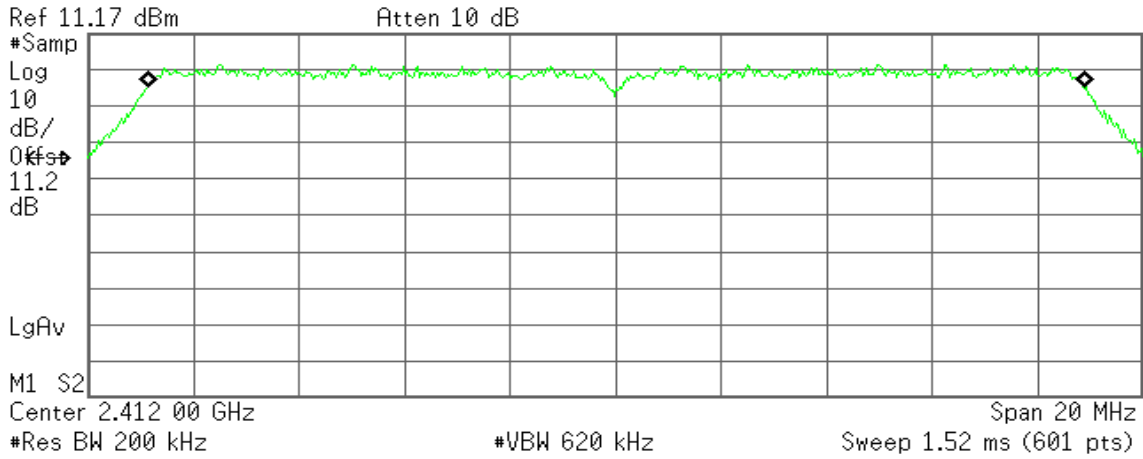

Occupied Bandwidth
17.7557 MHz

Occ BW % Pwr 99.00 %
x dB -26.00 dB

Transmit Freq Error 9.284 kHz
x dB Bandwidth 20.000 MHz*

99% Bandwidth (CH Mid)

Agilent 18:51:27 Aug 1, 2012

R T

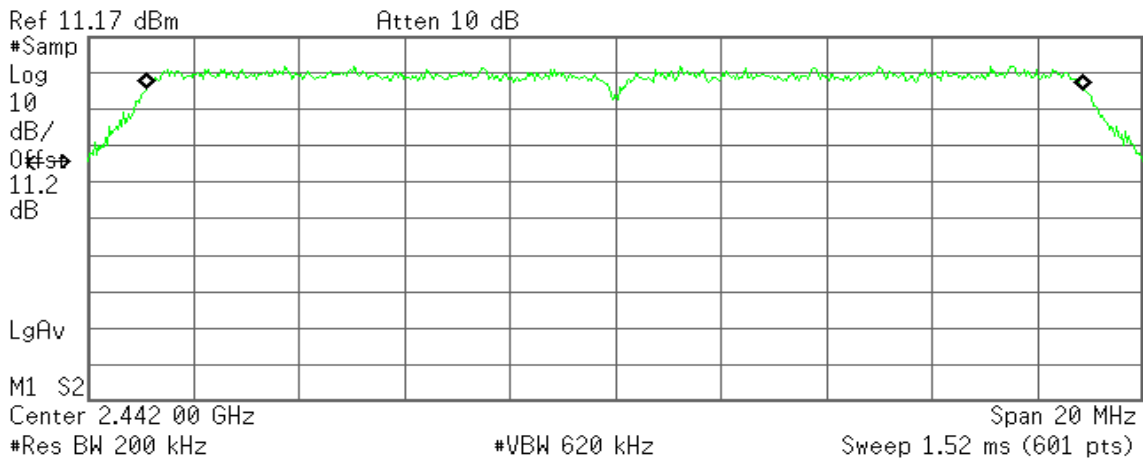

Occupied Bandwidth
17.7691 MHz

Occ BW % Pwr 99.00 %
x dB -26.00 dB

Transmit Freq Error -6.181 kHz
x dB Bandwidth 19.993 MHz*



99% Bandwidth (CH High)

Agilent 18:51:46 Aug 1, 2012

R T

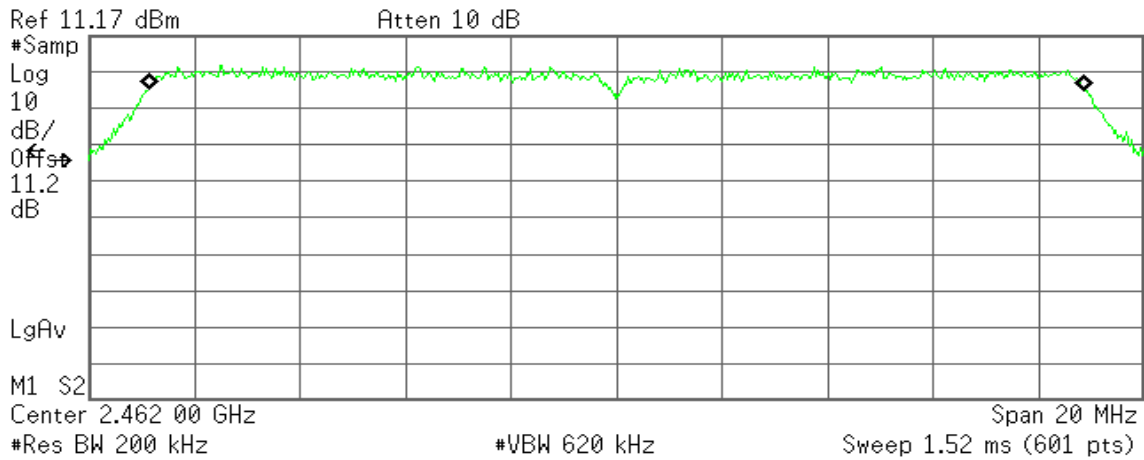

Occupied Bandwidth
17.7501 MHz

Occ BW % Pwr 99.00 %
x dB -26.00 dB

Transmit Freq Error -6.424 kHz
x dB Bandwidth 20.000 MHz*

IEEE 802.11n HT 40 MHz mode Channel mode

99% Bandwidth (CH Low)

Agilent 18:47:16 Aug 1, 2012

R T

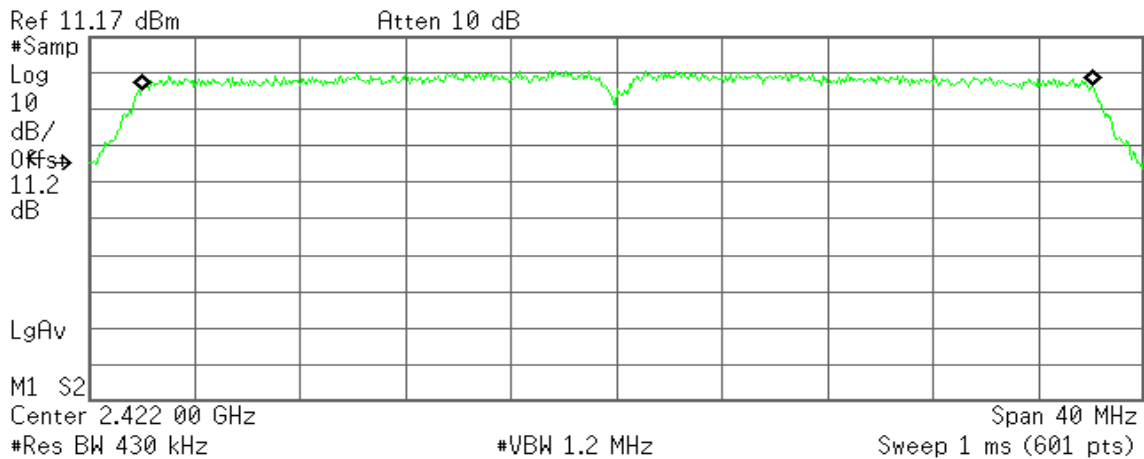

Occupied Bandwidth
36.0756 MHz

Occ BW % Pwr 99.00 %
x dB -26.00 dB

Transmit Freq Error 7.859 kHz
x dB Bandwidth 40.000 MHz*



99% Bandwidth (CH Mid)

Agilent 18:46:57 Aug 1, 2012

R T

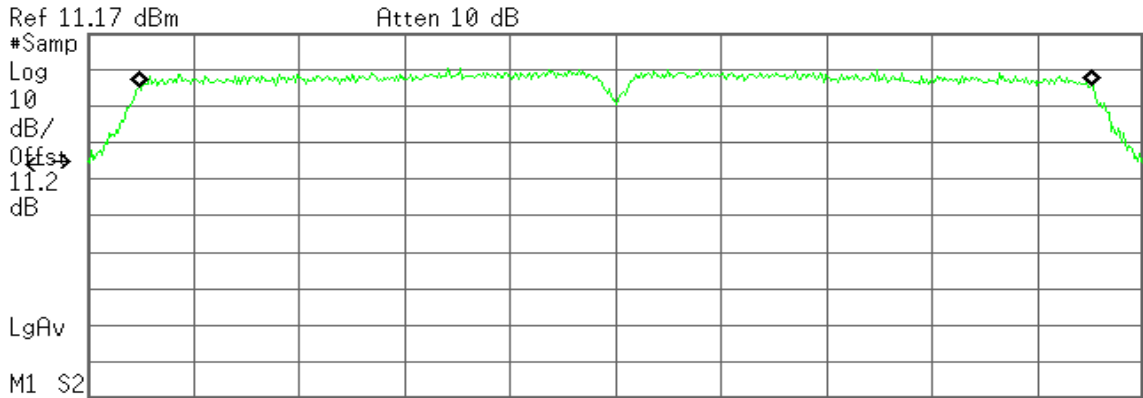

Ref 11.17 dBm Atten 10 dB
Center 2.442 00 GHz Span 40 MHz
#Res BW 430 kHz #VBW 1.2 MHz Sweep 1 ms (601 pts)

Occupied Bandwidth **Occ BW % Pwr** 99.00 %
36.0994 MHz **x dB** -26.00 dB

Transmit Freq Error 6.518 kHz
x dB Bandwidth 40.000 MHz*

99% Bandwidth (CH High)

Agilent 18:46:27 Aug 1, 2012

R T

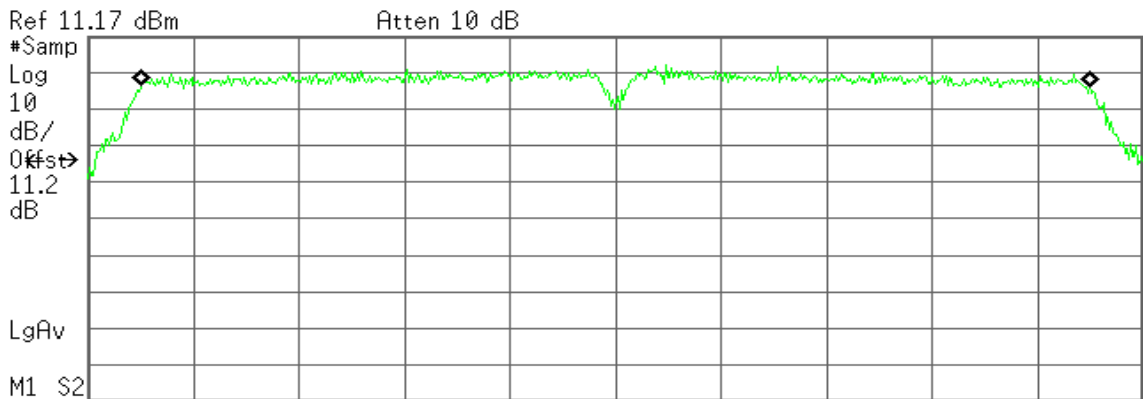

Ref 11.17 dBm Atten 10 dB
Center 2.452 00 GHz Span 40 MHz
#Res BW 430 kHz #VBW 1.2 MHz Sweep 1 ms (601 pts)

Occupied Bandwidth **Occ BW % Pwr** 99.00 %
35.9971 MHz **x dB** -26.00 dB

Transmit Freq Error -4.262 kHz
x dB Bandwidth 39.682 MHz*



8.3 6DB BANDWIDTH

LIMIT

According to §15.247(a)(2) & RSS-210 §A8.2(a), systems using digital modulation techniques may operate in the 902 - 928 MHz, 2400 - 2483.5 MHz, and 5725 - 5850 MHz bands. The minimum 6dB bandwidth shall be at least 500 kHz.

Test Configuration

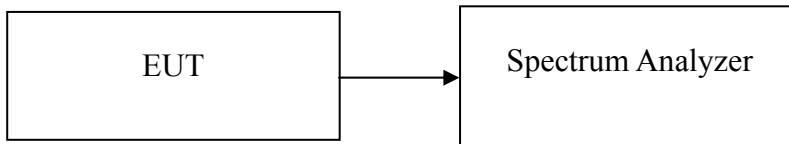

TEST PROCEDURE

The transmitter output is connected to the spectrum analyzer. Set the RBW = 1%-5% of the emission bandwidth, VBW $\geq 3 \times$ RBW, Detector = Peak, Trace mode = max hold, Sweep = auto couple. Measure the maximum width of the emission that is constrained by the frequencies associated with the two amplitude points (upper and lower) that are attenuated by 6dB relative to the maximum level measured in the fundamental emission.

TEST RESULTS

No non-compliance noted



Test Data

Test mode: IEEE 802.11b mode

Channel	Frequency (MHz)	6dB Bandwidth (kHz)	Limit (kHz)	Result
Low	2412	9170	>500	PASS
Mid	2442	9170		PASS
High	2462	9170		PASS

Test mode: IEEE 802.11g mode

Channel	Frequency (MHz)	6dB Bandwidth (kHz)	Limit (kHz)	Result
Low	2412	16700	>500	PASS
Mid	2442	16670		PASS
High	2462	16600		PASS

Test mode: IEEE 802.11n HT 20 MHz mode

Channel	Frequency (MHz)	6dB Bandwidth (kHz)	Limit (kHz)	Result
Low	2412	17830	>500	PASS
Mid	2442	17900		PASS
High	2462	17870		PASS

Test mode: IEEE 802.11n HT 40 MHz mode

Channel	Frequency (MHz)	6dB Bandwidth (kHz)	Limit (kHz)	Result
Low	2422	36470	>500	PASS
Mid	2442	36530		PASS
High	2452	36470		PASS



Test Plot

IEEE 802.11b mode

6dB Bandwidth (CH Low)

Agilent 21:44:12 Jul 31, 2012

R T

Mkr2 9.17 MHz
-1.02 dB

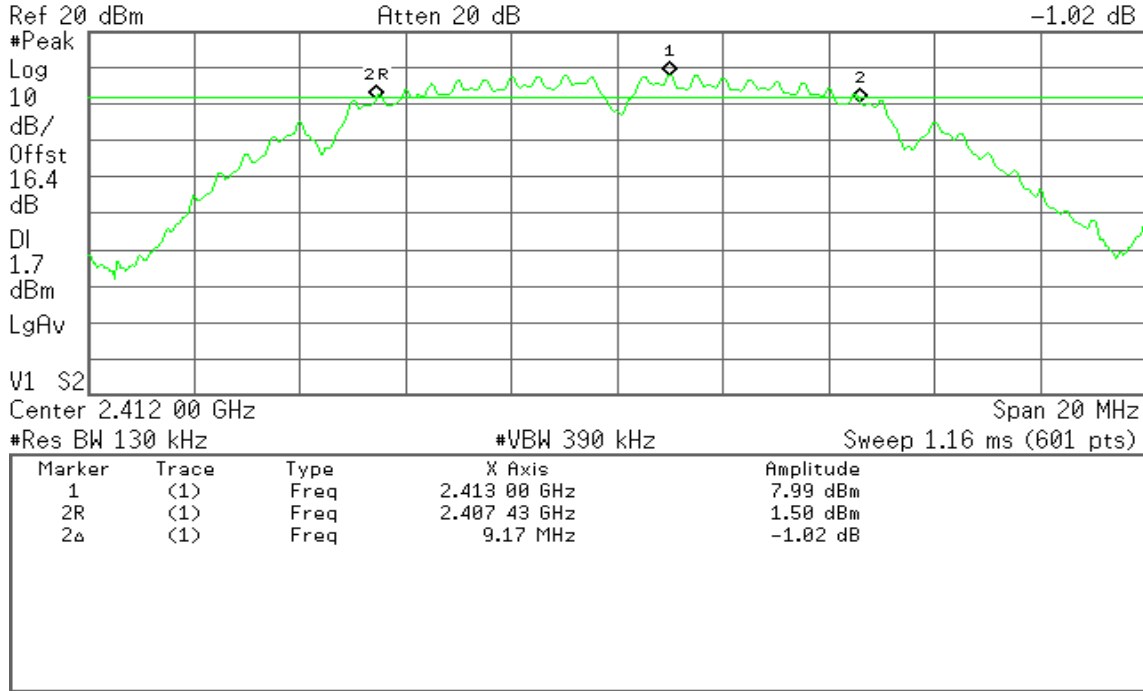

6dB Bandwidth (CH Mid)

Agilent 21:45:10 Jul 31, 2012

R T

Mkr2 9.17 MHz
-1.18 dB

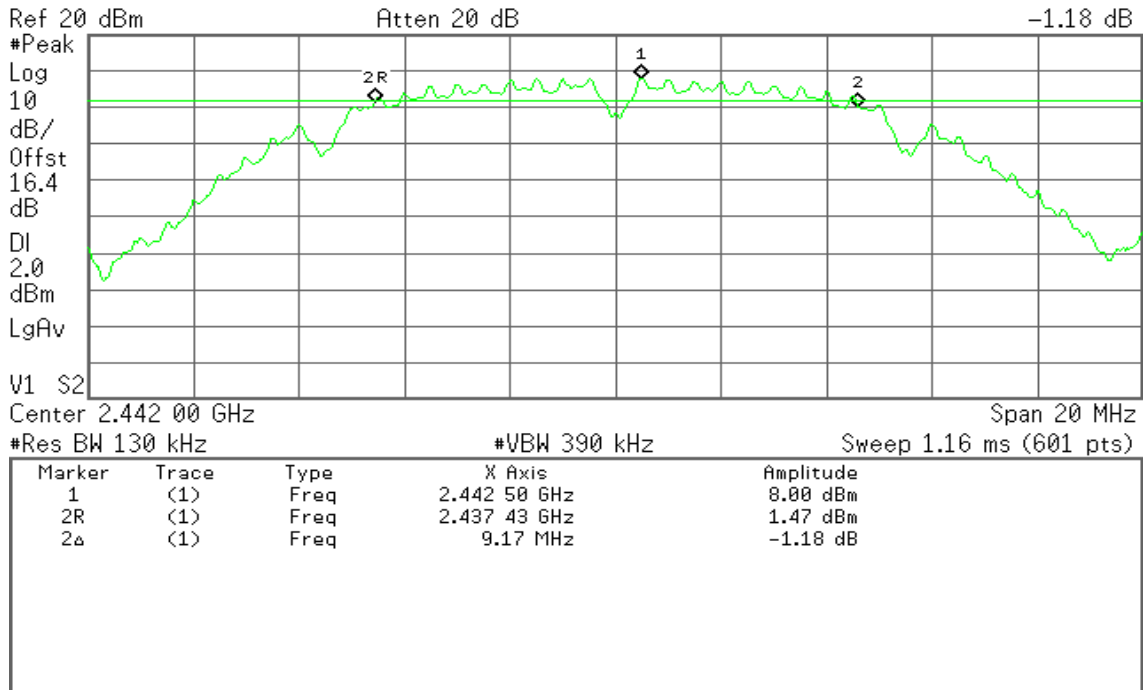



6dB Bandwidth (CH High)

Agilent 21:46:26 Jul 31, 2012

R T

Mkr2 9.17 MHz
-0.78 dB

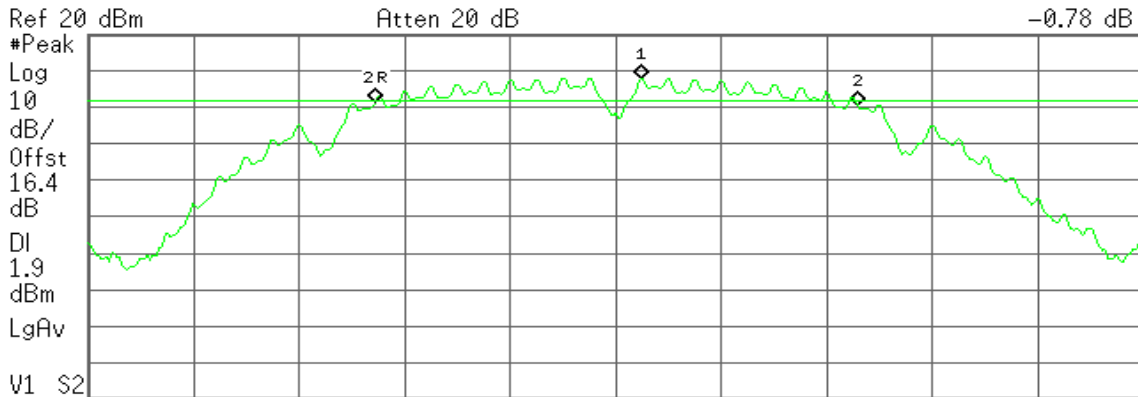

Center 2.462 00 GHz Span 20 MHz
#Res BW 130 kHz #VBW 390 kHz Sweep 1.16 ms (601 pts)

Marker	Trace	Type	X Axis	Amplitude
1	(1)	Freq	2.462 50 GHz	7.89 dBm
2R	(1)	Freq	2.457 43 GHz	1.47 dBm
2Δ	(1)	Freq	9.17 MHz	-0.78 dB

IEEE 802.11g mode

6dB Bandwidth (CH Low)

Agilent 21:51:19 Jul 31, 2012

R T

Mkr2 16.70 MHz
0.09 dB

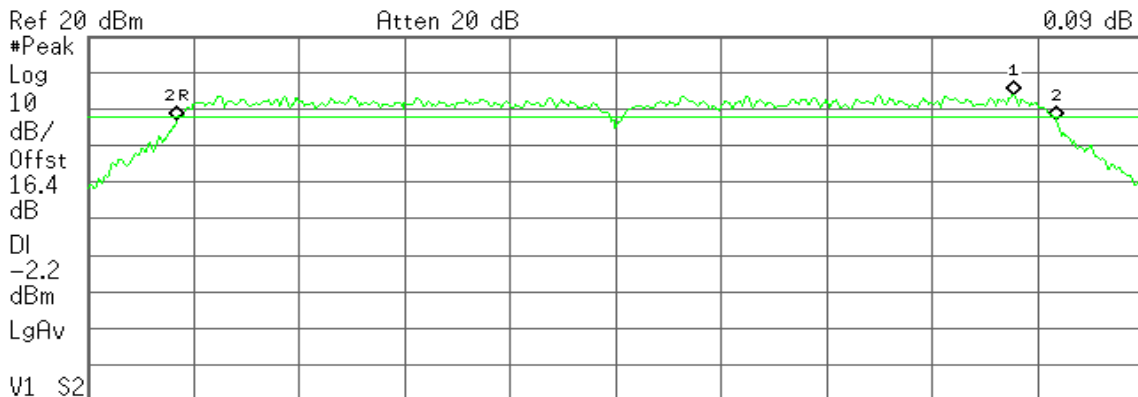

Center 2.412 00 GHz Span 20 MHz
#Res BW 180 kHz #VBW 560 kHz Sweep 1 ms (601 pts)

Marker	Trace	Type	X Axis	Amplitude
1	(1)	Freq	2.419 53 GHz	3.83 dBm
2R	(1)	Freq	2.403 67 GHz	-2.96 dBm
2Δ	(1)	Freq	16.70 MHz	0.09 dB



6dB Bandwidth (CH Mid)

Agilent 21:52:24 Jul 31, 2012

R T

Mkr2 16.67 MHz
-0.41 dB

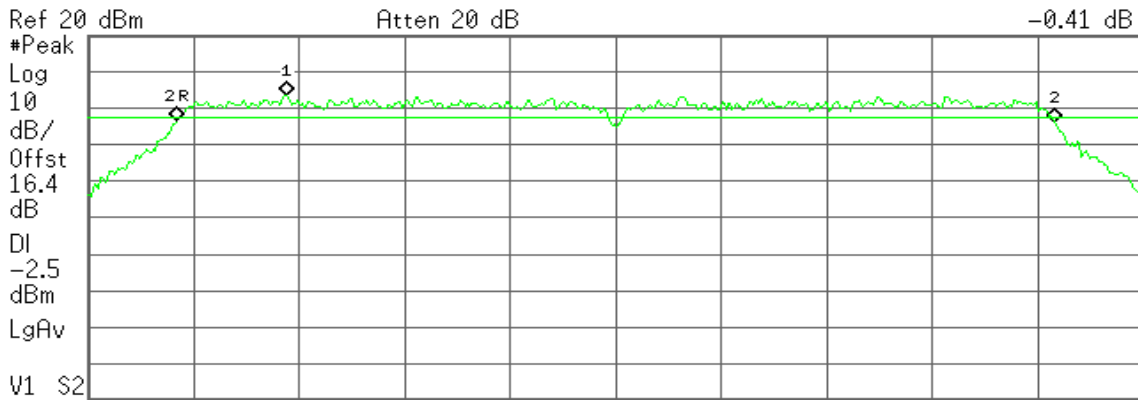

Center 2.442 00 GHz Span 20 MHz
#Res BW 180 kHz #VBW 560 kHz Sweep 1 ms (601 pts)

Marker	Trace	Type	X Axis	Amplitude
1	(1)	Freq	2.435 77 GHz	3.47 dBm
2R	(1)	Freq	2.433 67 GHz	-3.53 dBm
2Δ	(1)	Freq	16.67 MHz	-0.41 dB

6dB Bandwidth (CH High)

Agilent 21:53:27 Jul 31, 2012

R T

Mkr2 16.60 MHz
0.00 dB

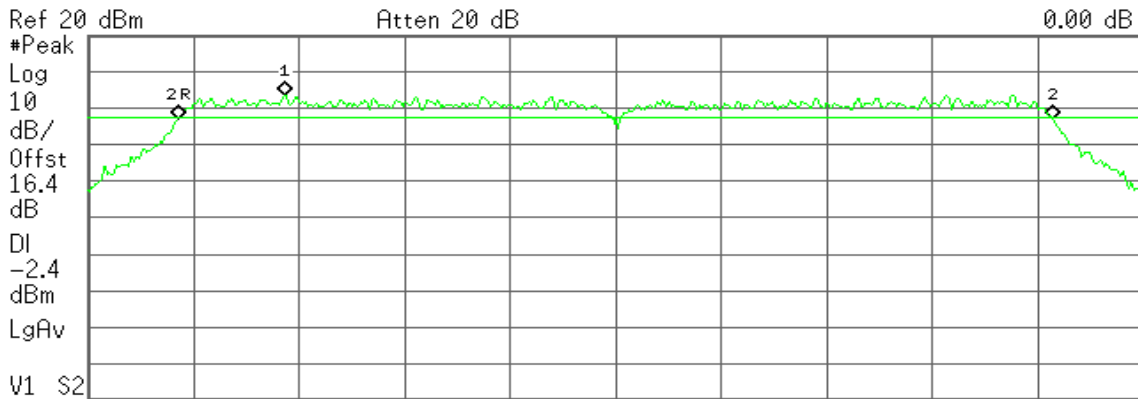

Center 2.462 00 GHz Span 20 MHz
#Res BW 180 kHz #VBW 560 kHz Sweep 1 ms (601 pts)

Marker	Trace	Type	X Axis	Amplitude
1	(1)	Freq	2.455 73 GHz	3.63 dBm
2R	(1)	Freq	2.453 70 GHz	-2.96 dBm
2Δ	(1)	Freq	16.60 MHz	0.00 dB



IEEE 802.11n HT 20 MHz mode

6dB Bandwidth (CH Low)

Agilent 21:56:55 Jul 31, 2012

R T

Mkr2 17.83 MHz
-0.30 dB

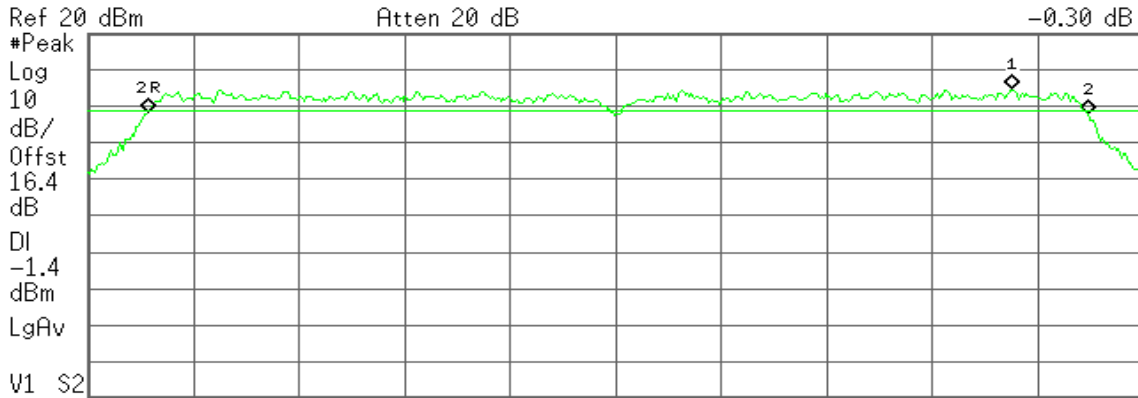

Marker	Trace	Type	X Axis	Amplitude
1	(1)	Freq	2.419 50 GHz	4.64 dBm
2R	(1)	Freq	2.403 13 GHz	-1.62 dBm
2Δ	(1)	Freq	17.83 MHz	-0.30 dB

6dB Bandwidth (CH Mid)

Agilent 21:55:44 Jul 31, 2012

R T

Mkr2 17.90 MHz
-0.04 dB

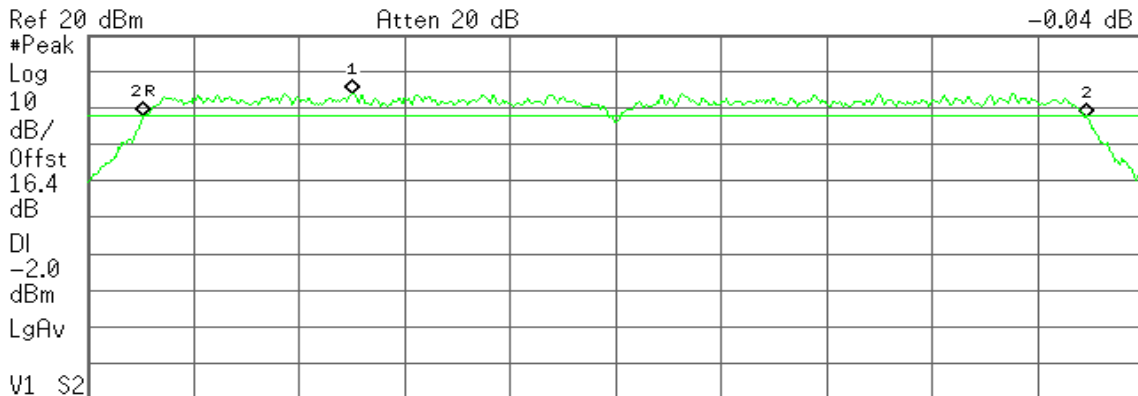

Marker	Trace	Type	X Axis	Amplitude
1	(1)	Freq	2.437 00 GHz	4.00 dBm
2R	(1)	Freq	2.433 03 GHz	-2.29 dBm
2Δ	(1)	Freq	17.90 MHz	-0.04 dB



6dB Bandwidth (CH High)

Agilent 21:54:46 Jul 31, 2012

R T

Mkr2 17.87 MHz
-0.28 dB

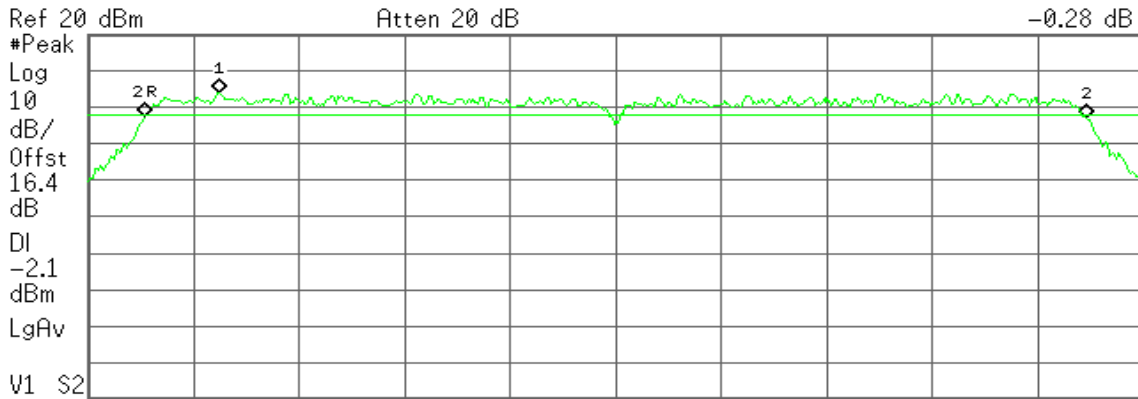

Center 2.462 00 GHz Span 20 MHz
#Res BW 200 kHz #VBW 560 kHz Sweep 1 ms (601 pts)

Marker	Trace	Type	X Axis	Amplitude
1	(1)	Freq	2.454 50 GHz	3.91 dBm
2R	(1)	Freq	2.453 07 GHz	-2.67 dBm
2Δ	(1)	Freq	17.87 MHz	-0.28 dB

IEEE 802.11n HT 40 MHz mode

6dB Bandwidth (CH Low)

Agilent 21:58:30 Jul 31, 2012

R T

Mkr2 36.47 MHz
-2.19 dB

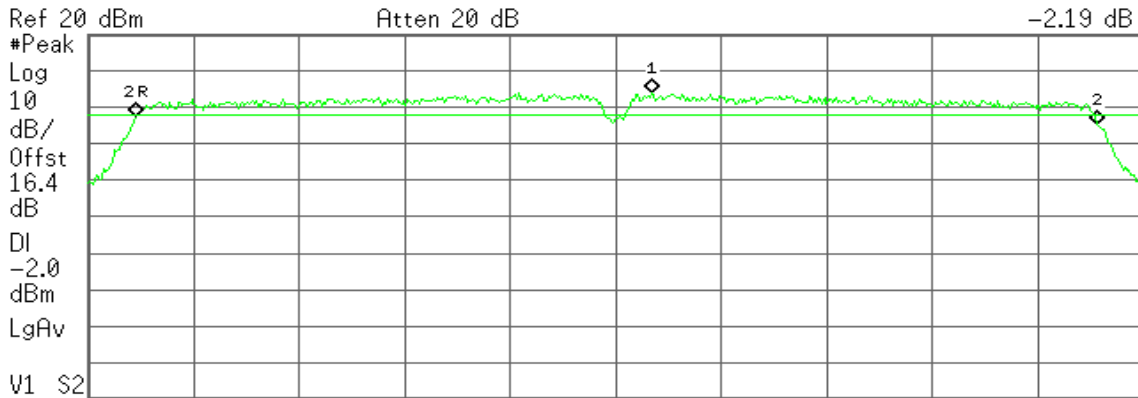

Center 2.422 00 GHz Span 40 MHz
#Res BW 390 kHz #VBW 1.2 MHz Sweep 1 ms (601 pts)

Marker	Trace	Type	X Axis	Amplitude
1	(1)	Freq	2.423 40 GHz	4.02 dBm
2R	(1)	Freq	2.403 80 GHz	-2.63 dBm
2Δ	(1)	Freq	36.47 MHz	-2.19 dB



6dB Bandwidth (CH Mid)

Agilent 21:59:38 Jul 31, 2012

R T

Mkr2 36.53 MHz
-1.14 dB

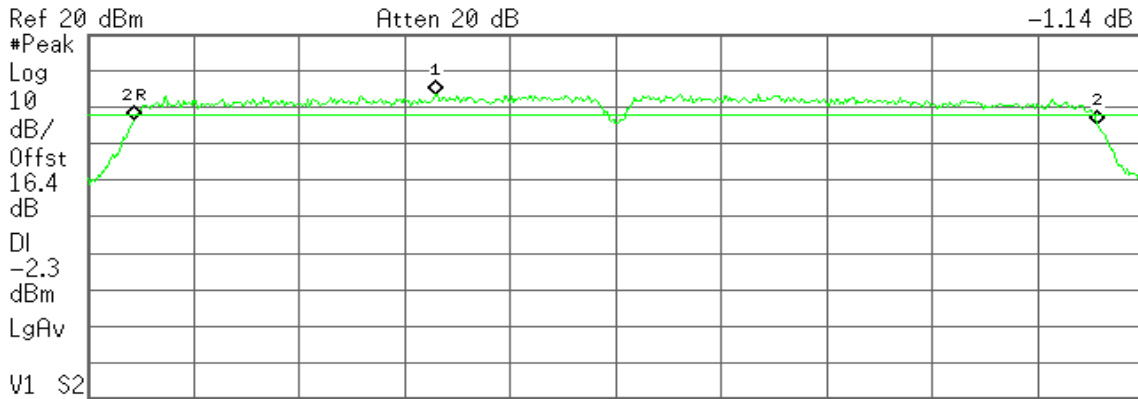

Center 2.442 00 GHz Span 40 MHz
#Res BW 390 kHz #VBW 1.2 MHz Sweep 1 ms (601 pts)

Marker	Trace	Type	X Axis	Amplitude
1	(1)	Freq	2.435 20 GHz	3.72 dBm
2R	(1)	Freq	2.423 73 GHz	-3.46 dBm
2Δ	(1)	Freq	36.53 MHz	-1.14 dB

6dB Bandwidth (CH High)

Agilent 22:00:38 Jul 31, 2012

R T

Mkr2 36.47 MHz
-1.25 dB

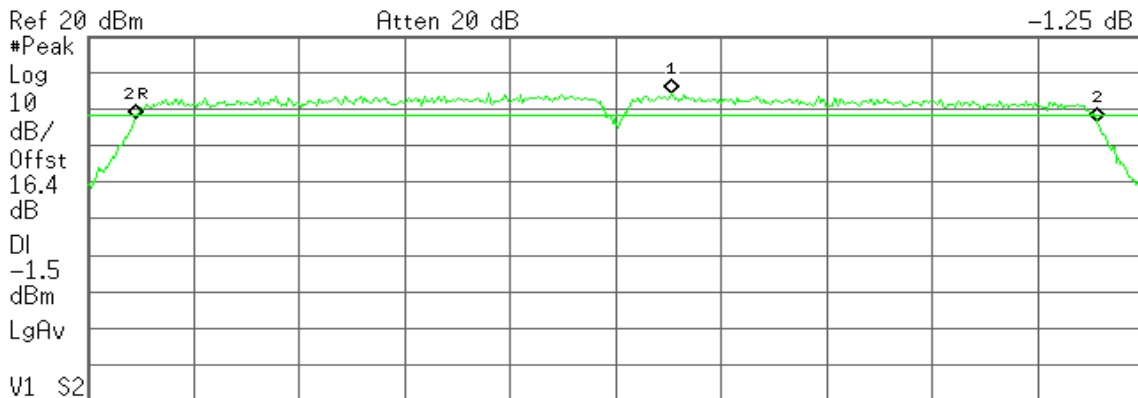

Center 2.452 00 GHz Span 40 MHz
#Res BW 390 kHz #VBW 1.2 MHz Sweep 1 ms (601 pts)

Marker	Trace	Type	X Axis	Amplitude
1	(1)	Freq	2.454 13 GHz	4.48 dBm
2R	(1)	Freq	2.433 80 GHz	-2.30 dBm
2Δ	(1)	Freq	36.47 MHz	-1.25 dB



8.4 PEAK POWER

LIMIT

The maximum peak output power of the intentional radiator shall not exceed the following:

1. According to §15.247(b)(3), for systems using digital modulation in the bands of 902-928 MHz, 2400-2483.5 MHz, and 5725-5850 MHz: 1 Watt.
2. According to §15.247(b)(4), the conducted output power limit specified in paragraph (b) of this section is based on the use of antennas with directional gains that do not exceed 6 dBi. Except as shown in paragraph (c) of this section, if transmitting antennas of directional gain greater than 6 dBi are used, the conducted output power from the intentional radiator shall be reduced below the stated values in paragraphs (b)(1), (b)(2), and (b)(3) of this section, as appropriate, by the amount in dB that the directional gain of the antenna exceeds 6 dBi.
3. According to RSS-210 §A8.4(4), for systems employing digital modulation techniques operating in the bands 902-928 MHz, 2400-2483.5 MHz and 5725-5850 MHz, the maximum peak conducted output power shall not exceed 1 W.

Test Configuration

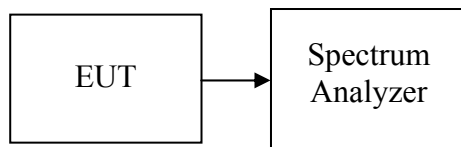

TEST PROCEDURE

The transmitter output is connected to the spectrum analyzer. Set the RBW = 1MHz, VBW = 3MHz, Detector = Peak, Trace mode = max hold, Sweep = auto couple. Record the max reading. Repeat the above procedure until the measurements for all frequencies are completed.

TEST RESULTS

No non-compliance noted



Test Data

Test mode: IEEE 802.11b mode

Channel	Frequency (MHz)	Output Power (dBm)	Output Power (W)	Limit (W)	Result
Low	2412	19.30	0.0851	1.00	PASS
Mid	2442	19.82	0.0959		PASS
High	2462	19.16	0.0824		PASS

Test mode: IEEE 802.11g mode

Channel	Frequency (MHz)	Output Power (dBm)	Output Power (W)	Limit (W)	Result
Low	2412	21.37	0.1371	1.00	PASS
Mid	2442	21.90	0.1549		PASS
High	2462	21.57	0.1435		PASS

Test mode: IEEE 802.11n HT 20 MHz mode

Channel	Frequency (MHz)	Output Power (dBm)	Output Power (W)	Limit (W)	Result
Low	2412	21.90	0.1549	1.00	PASS
Mid	2442	21.52	0.1419		PASS
High	2462	21.59	0.1442		PASS

Test mode: IEEE 802.11n HT 40 MHz mode

Channel	Frequency (MHz)	Output Power (dBm)	Output Power (W)	Limit (W)	Result
Low	2422	22.63	0.1832	1.00	PASS
Mid	2442	21.72	0.1486		PASS
High	2452	21.98	0.1578		PASS



Test Plot

IEEE 802.11b mode

Peak Power (CH Low)

Agilent 21:08:51 Jul 31, 2012

R T

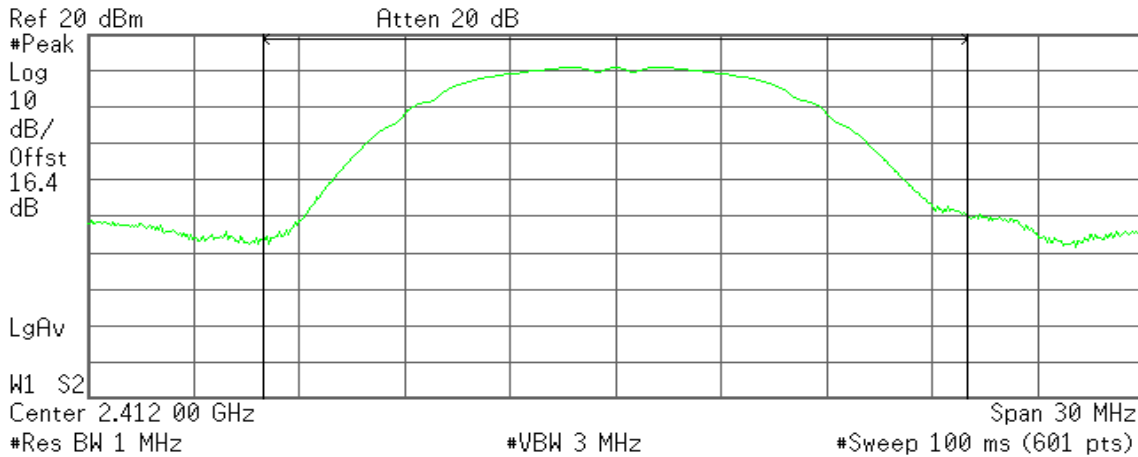

Channel Power

19.30 dBm /20.0000 MHz

Power Spectral Density

-53.71 dBm/Hz

Peak Power (CH Mid)

Agilent 21:11:26 Jul 31, 2012

R T

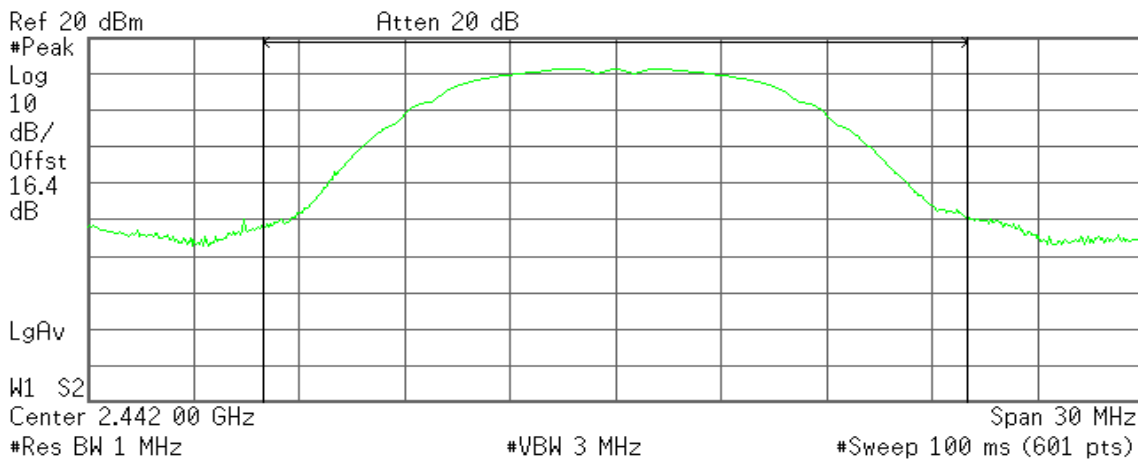

Channel Power

19.82 dBm /20.0000 MHz

Power Spectral Density

-53.19 dBm/Hz



Peak Power (CH High)

Agilent 21:13:56 Jul 31, 2012

R T

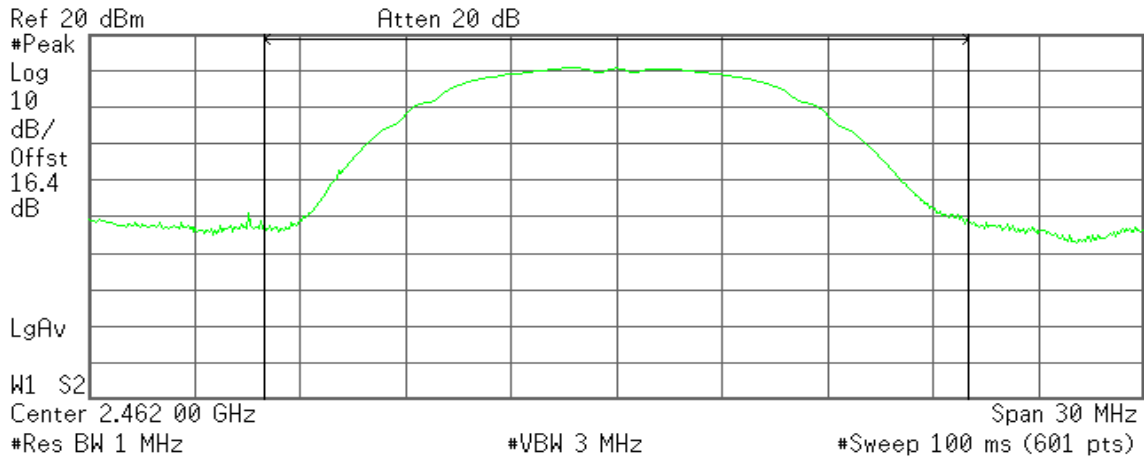

Channel Power

19.16 dBm /20.0000 MHz

Power Spectral Density

-53.85 dBm/Hz



IEEE 802.11g mode

Peak Power (CH Low)

Agilent 21:16:33 Jul 31, 2012

R T

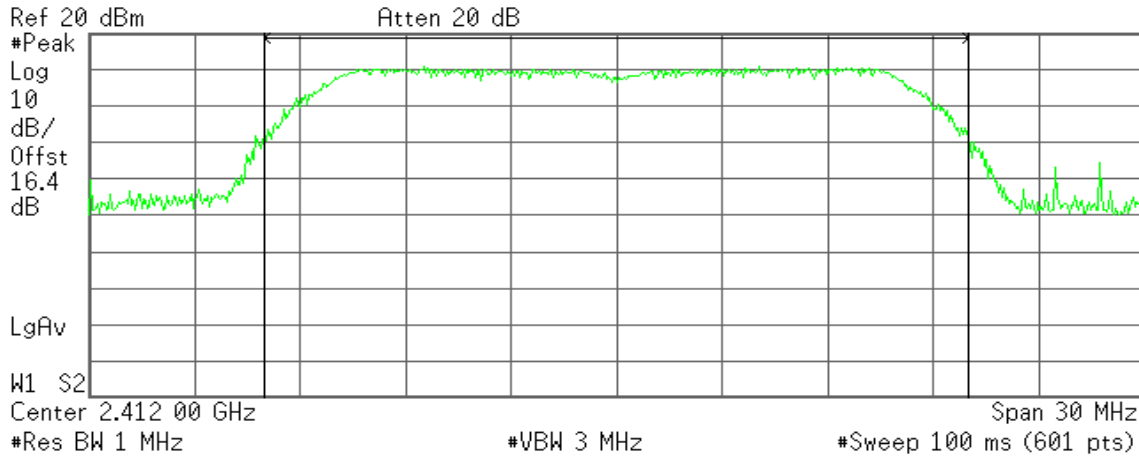

Channel Power

21.37 dBm /20.0000 MHz

Power Spectral Density

-51.64 dBm/Hz

Peak Power (CH Mid)

Agilent 21:19:12 Jul 31, 2012

R T

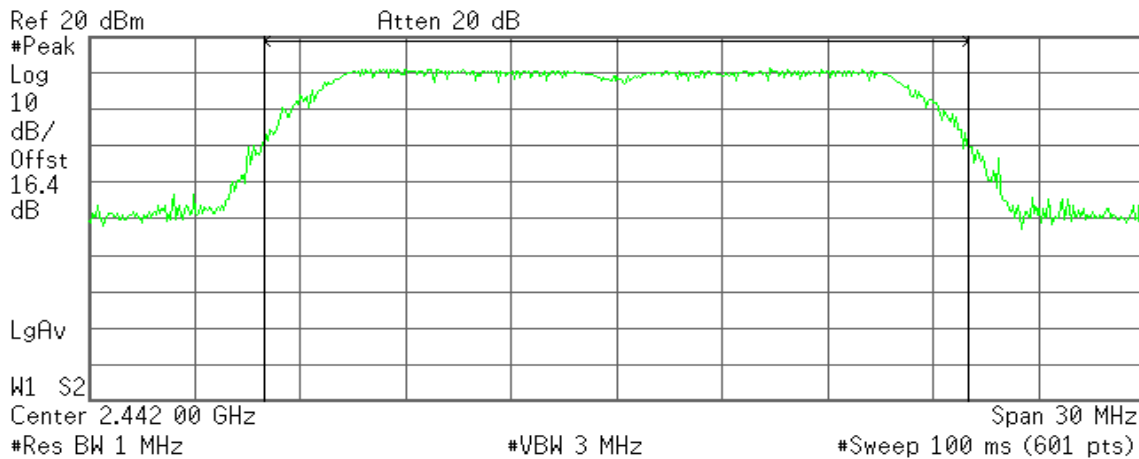

Channel Power

21.90 dBm /20.0000 MHz

Power Spectral Density

-51.11 dBm/Hz



Peak Power (CH High)

Agilent 21:21:41 Jul 31, 2012

R T

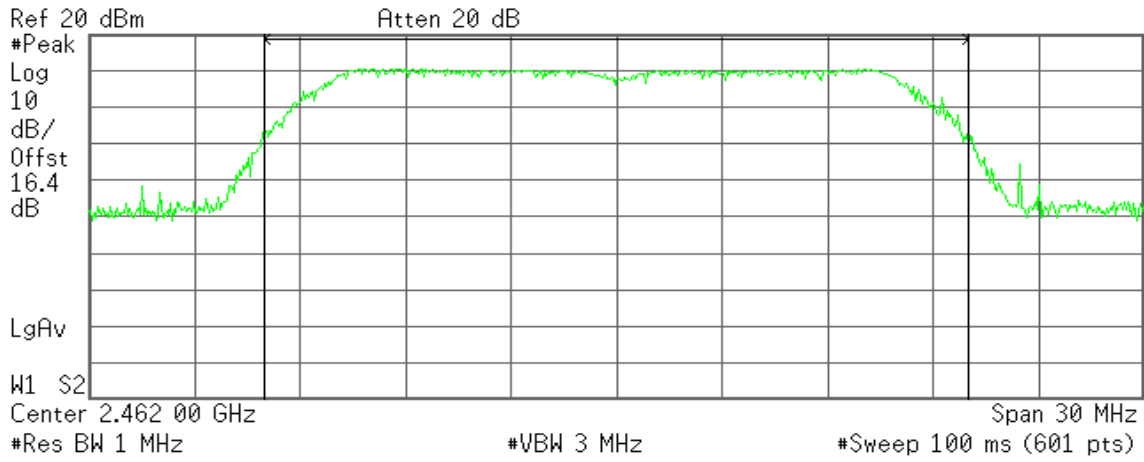

Channel Power

21.57 dBm /20.0000 MHz

Power Spectral Density

-51.44 dBm/Hz



IEEE 802.11n HT 20 MHz mode

Peak Power (CH Low)

Agilent 21:25:09 Jul 31, 2012

R T

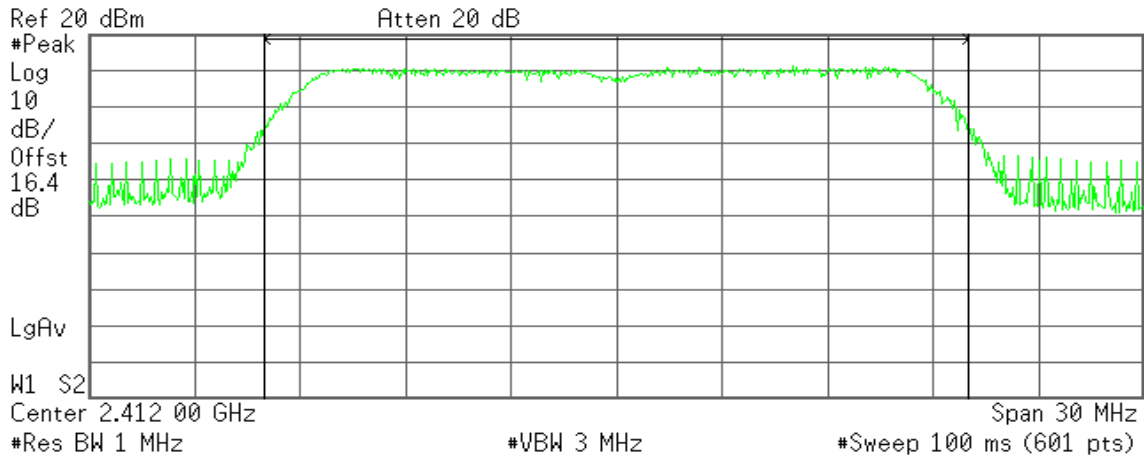

Channel Power

21.90 dBm /20.0000 MHz

Power Spectral Density

-51.11 dBm/Hz

Peak Power (CH Mid)

Agilent 21:27:29 Jul 31, 2012

R T

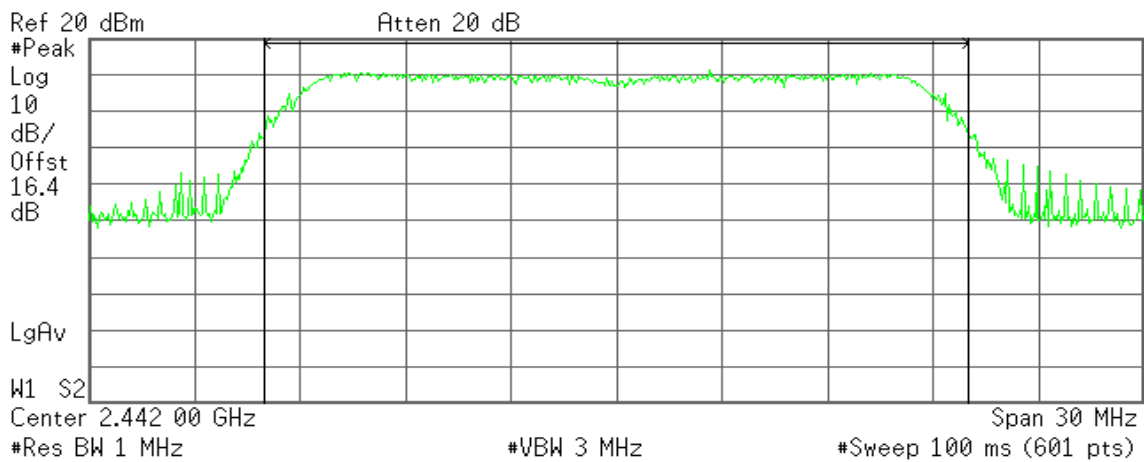

Channel Power

21.52 dBm /20.0000 MHz

Power Spectral Density

-51.49 dBm/Hz



Peak Power (CH High)

Agilent 21:30:04 Jul 31, 2012

R T

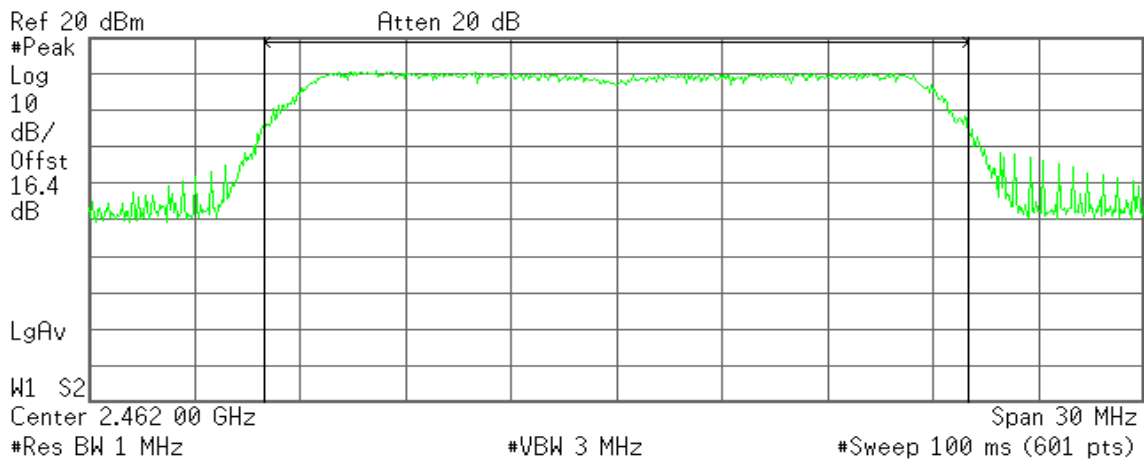

Channel Power

21.59 dBm /20.0000 MHz

Power Spectral Density

-51.42 dBm/Hz



IEEE 802.11n HT 40 MHz mode

Peak Power (CH Low)

Agilent 21:32:42 Jul 31, 2012

R T

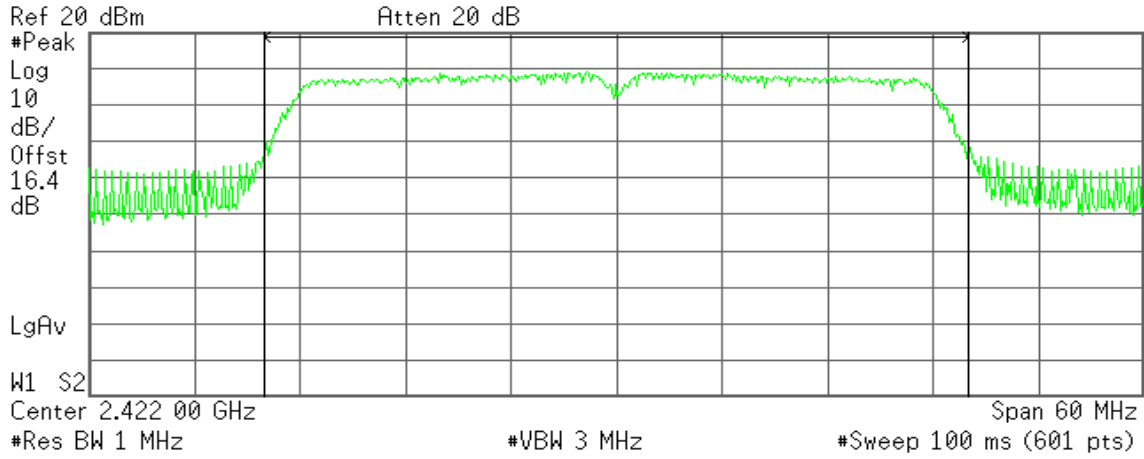

Channel Power

22.63 dBm /40.0000 MHz

Power Spectral Density

-53.39 dBm/Hz

Peak Power (CH Mid)

Agilent 21:35:35 Jul 31, 2012

R T

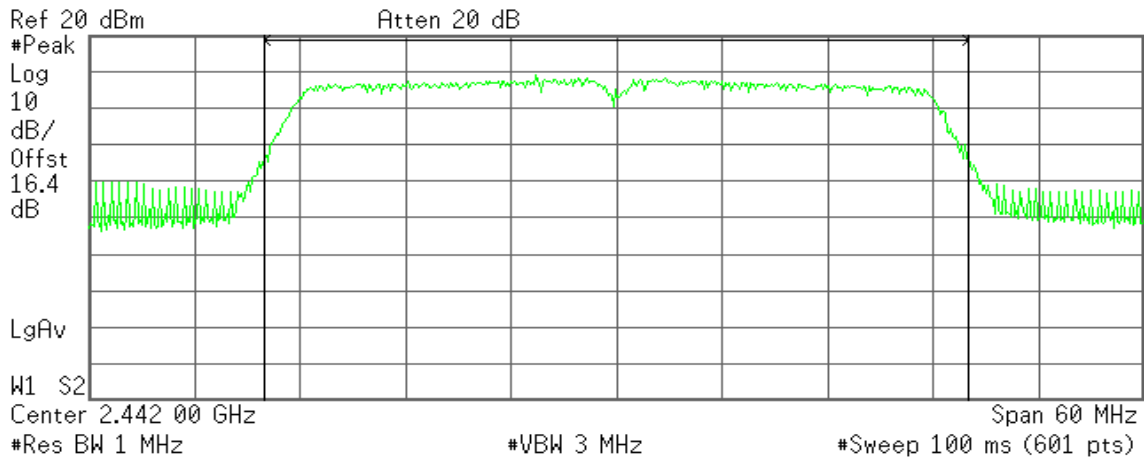

Channel Power

21.72 dBm /40.0000 MHz

Power Spectral Density

-54.30 dBm/Hz



Peak Power (CH High)

Agilent 21:38:29 Jul 31, 2012

R T

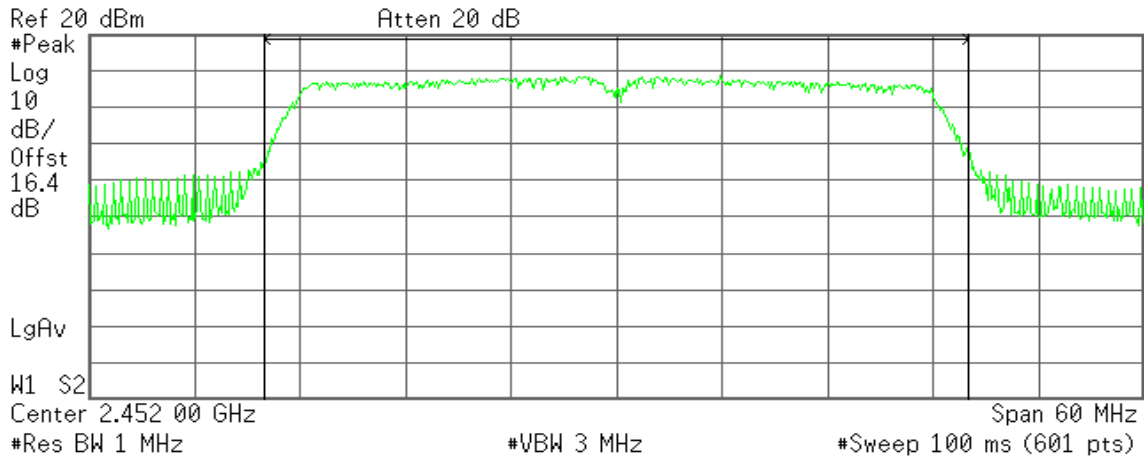

Channel Power

21.98 dBm /40.0000 MHz

Power Spectral Density

-54.04 dBm/Hz



8.5 BAND EDGES MEASUREMENT

LIMIT

According to §15.247(d) & RSS-210 §A8.5, in any 100 kHz bandwidth outside the frequency bands in which the spread spectrum intentional radiator is operating, the radio frequency power that is produced by the intentional radiator shall be at least 20 dB below that in the 100 kHz bandwidth within the band that contains the highest level of the desired power, based on either an RF conducted or a radiated measurement, provided the transmitter demonstrates compliance with the peak conducted power limits. In addition, radiated emissions which fall in the restricted bands, as defined in §15.205(a), must also comply with the radiated emission limits specified in 15.209(a) (see Section 15.205(c)).

Test Configuration

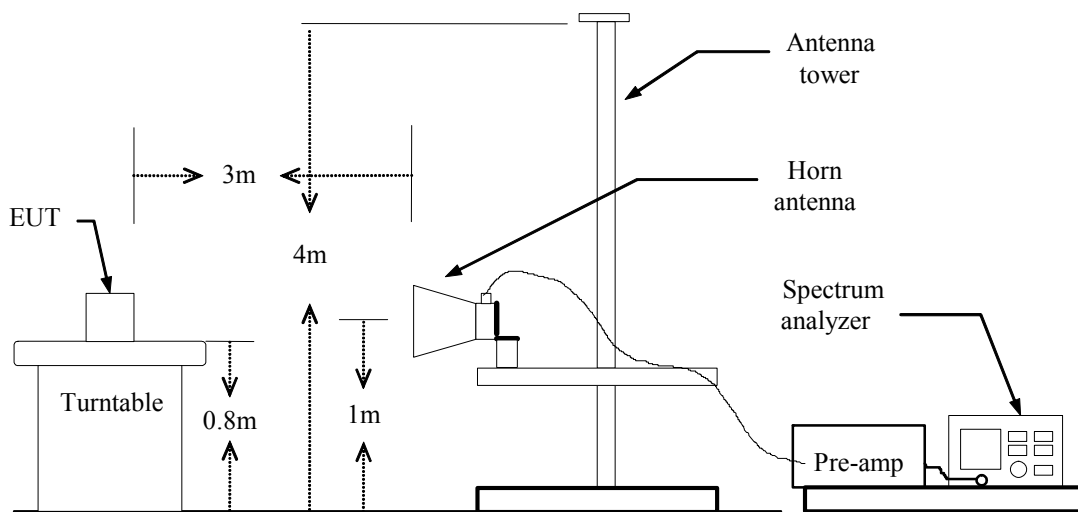

TEST PROCEDURE

1. The EUT is placed on a turntable, which is 0.8m above the ground plane.
2. The turntable shall be rotated for 360 degrees to determine the position of maximum emission level.
3. EUT is set 3m away from the receiving antenna, which is varied from 1m to 4m to find out the highest emission.
4. Set the spectrum analyzer in the following setting in order to capture the lower and upper band-edges of the emission:
 - (a) PEAK: RBW=1MHz / VBW=3MHz or 1/T / Sweep=AUTO
 - (b) AVERAGE: RBW=1MHz / VBW=10Hz / Sweep=AUTO
5. Repeat the procedures until all the PEAK and AVERAGE versus POLARIZATION are measured.

TEST RESULTS

Refer to attach spectrum analyzer data chart.



Band Edges (IEEE 802.11b mode / CH Low)

Detector mode: Peak

Polarity: Vertical

Agilent

R T

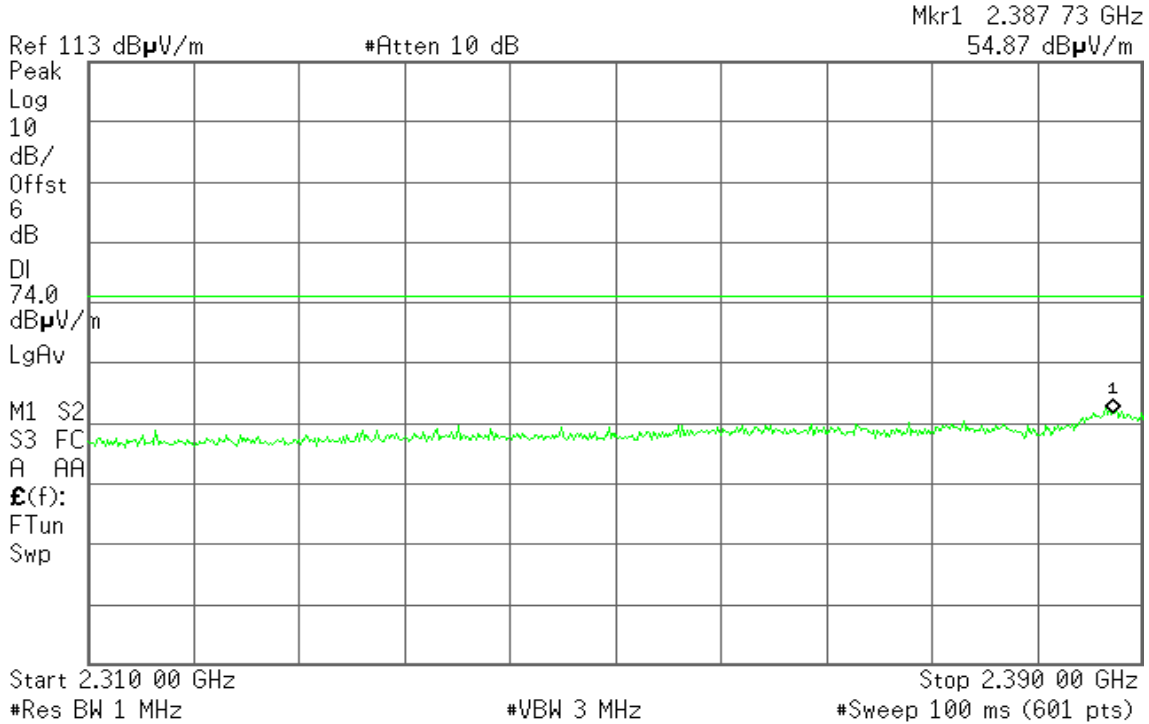

Detector mode: Average

Polarity: Vertical

Agilent

R T

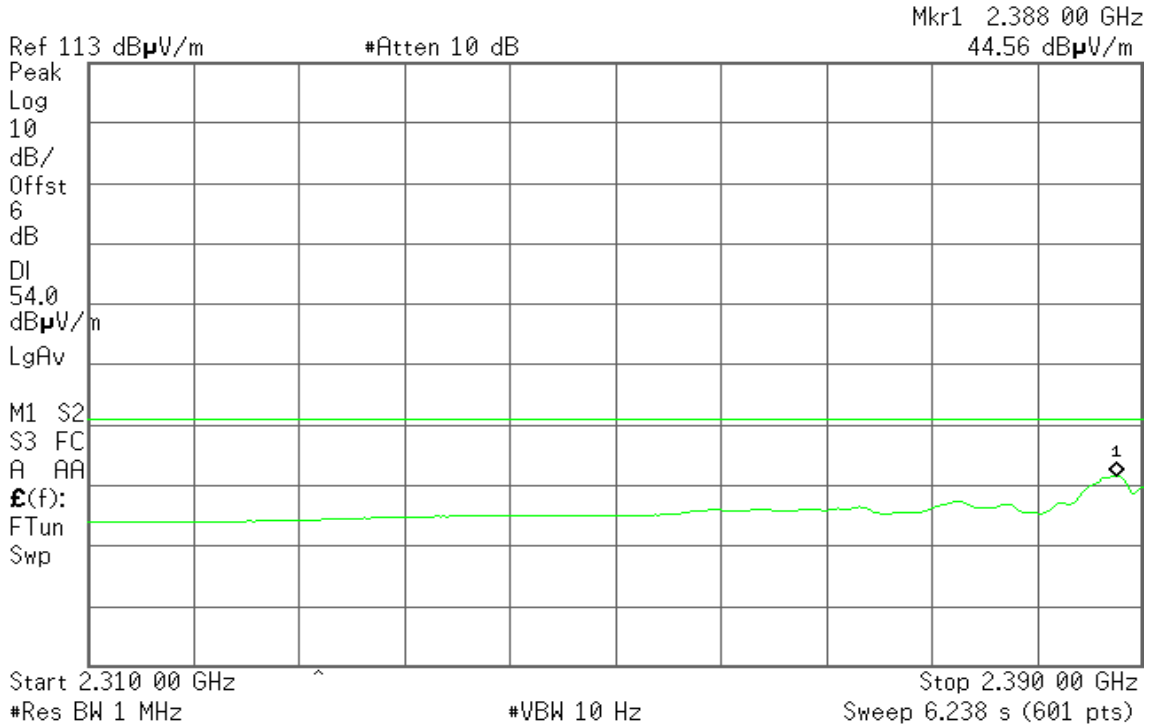



Detector mode: Peak

Polarity: Horizontal

Agilent

R T

Mkr1 2.387 33 GHz
54.54 dB μ V/m

Ref 113 dB μ V/m

#Atten 10 dB

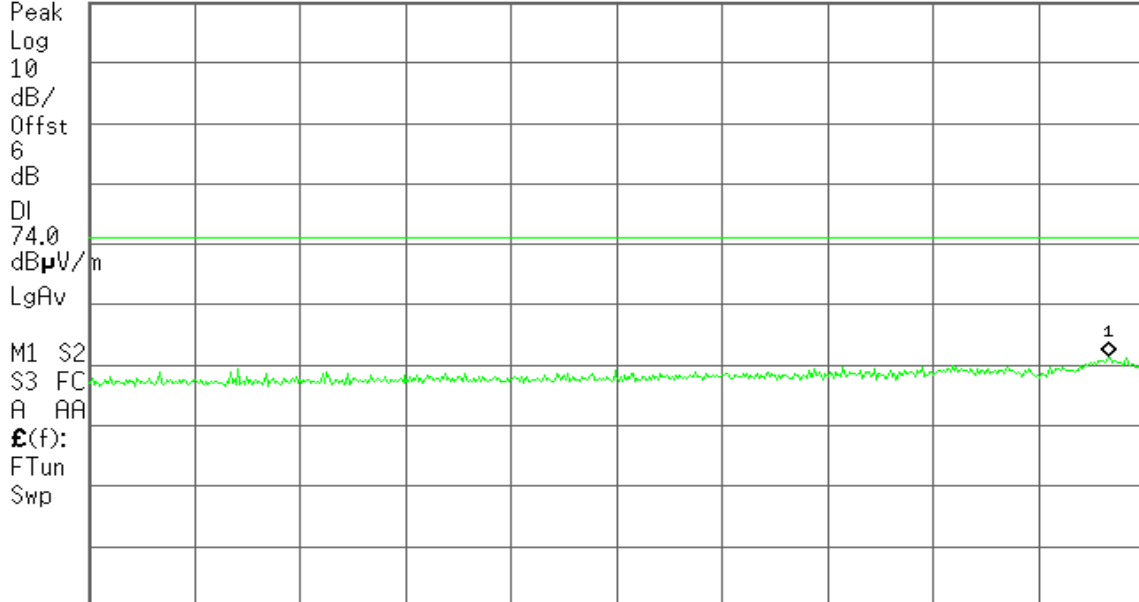

Start 2.310 00 GHz

Stop 2.390 00 GHz

#Res BW 1 MHz

#VBW 3 MHz

#Sweep 100 ms (601 pts)

Detector mode: Average

Polarity: Horizontal

Agilent

R T

Mkr1 2.388 00 GHz
42.40 dB μ V/m

Ref 113 dB μ V/m

#Atten 10 dB

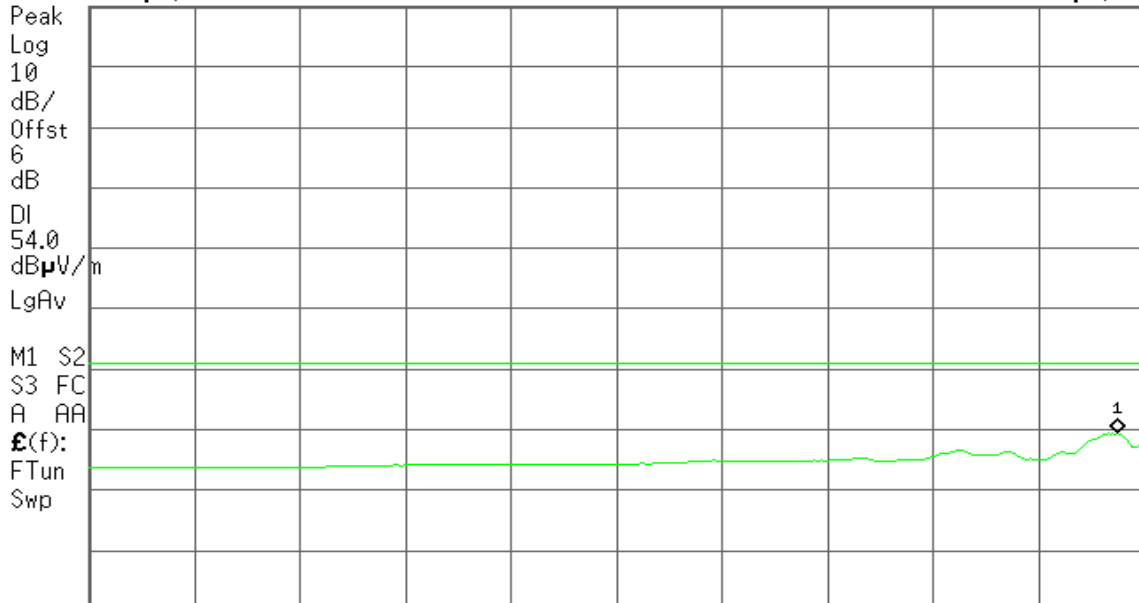

Start 2.310 00 GHz

Stop 2.390 00 GHz

#Res BW 1 MHz

#VBW 10 Hz

Sweep 6.238 s (601 pts)



Band Edges (IEEE 802.11b mode / CH High)

Detector mode: Peak

Polarity: Vertical

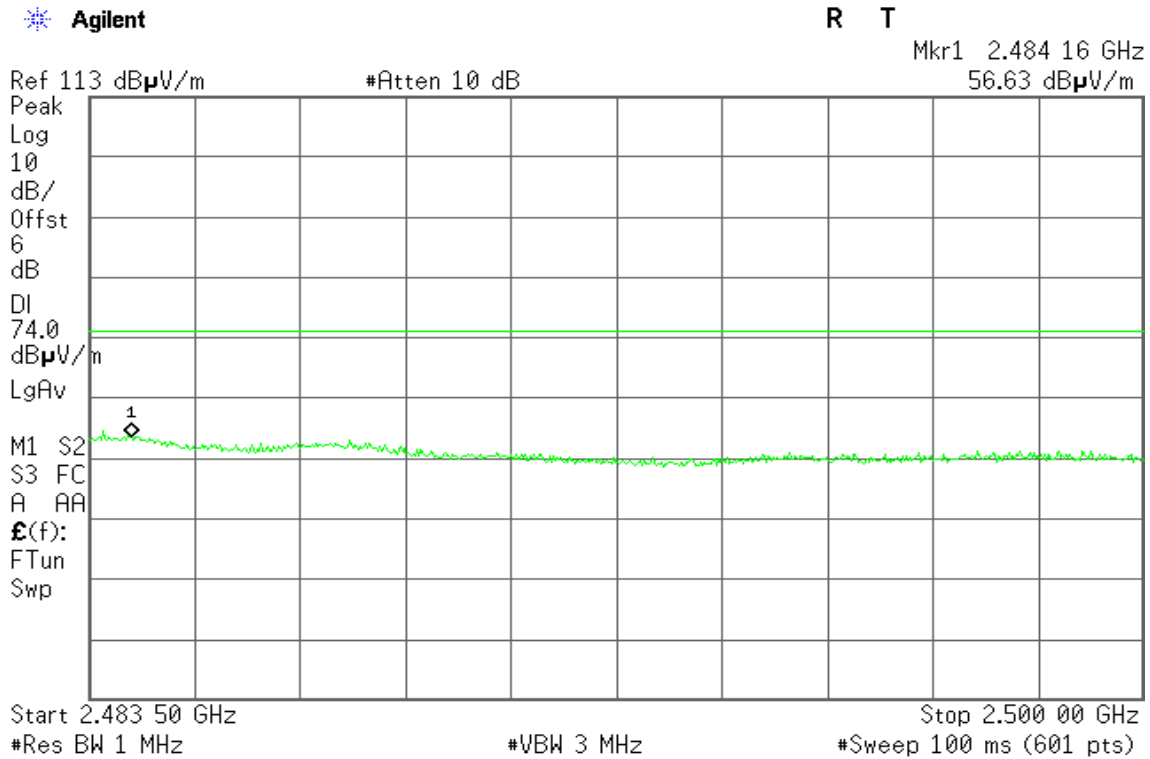

Detector mode: Average

Polarity: Vertical

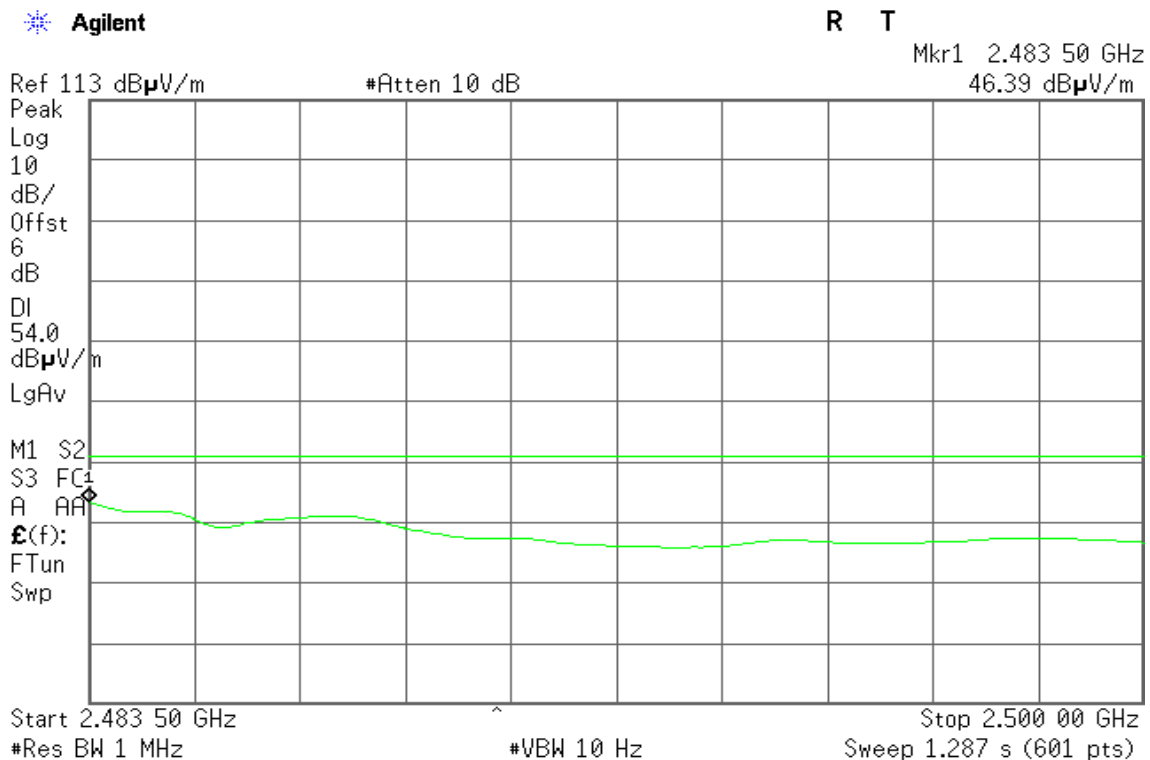



Detector mode: Peak

Polarity: Horizontal

Agilent

T

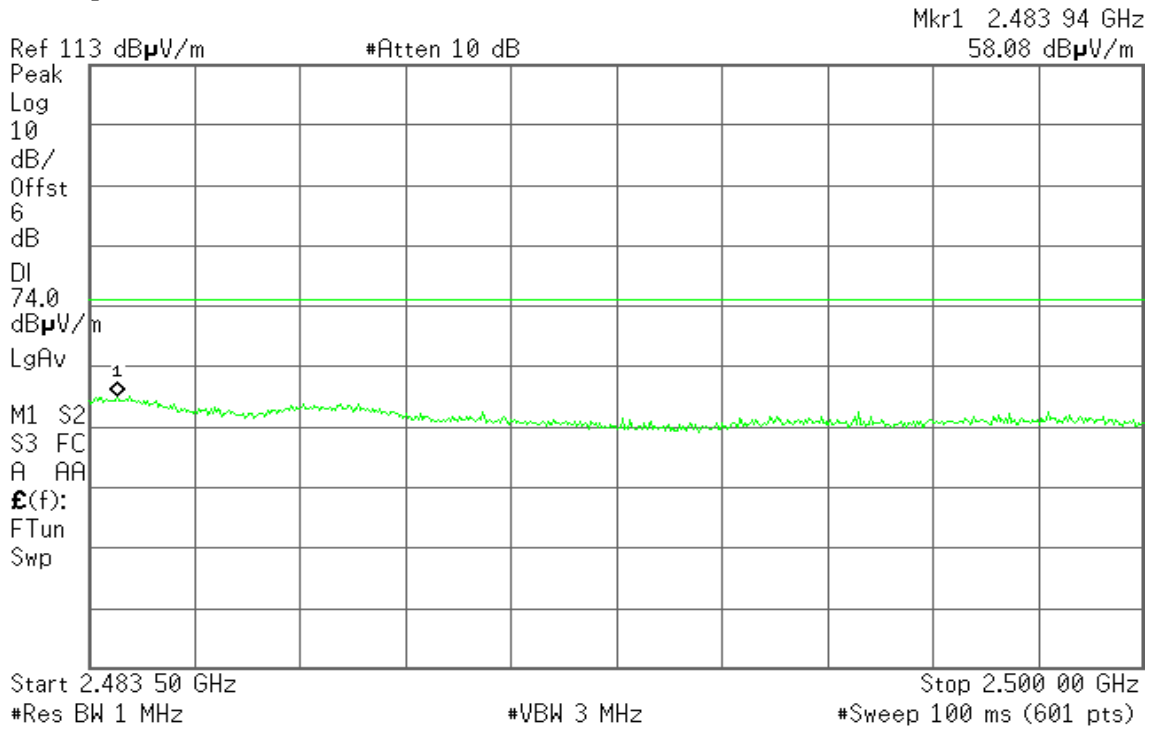

Detector mode: Average

Polarity: Horizontal

Agilent

T

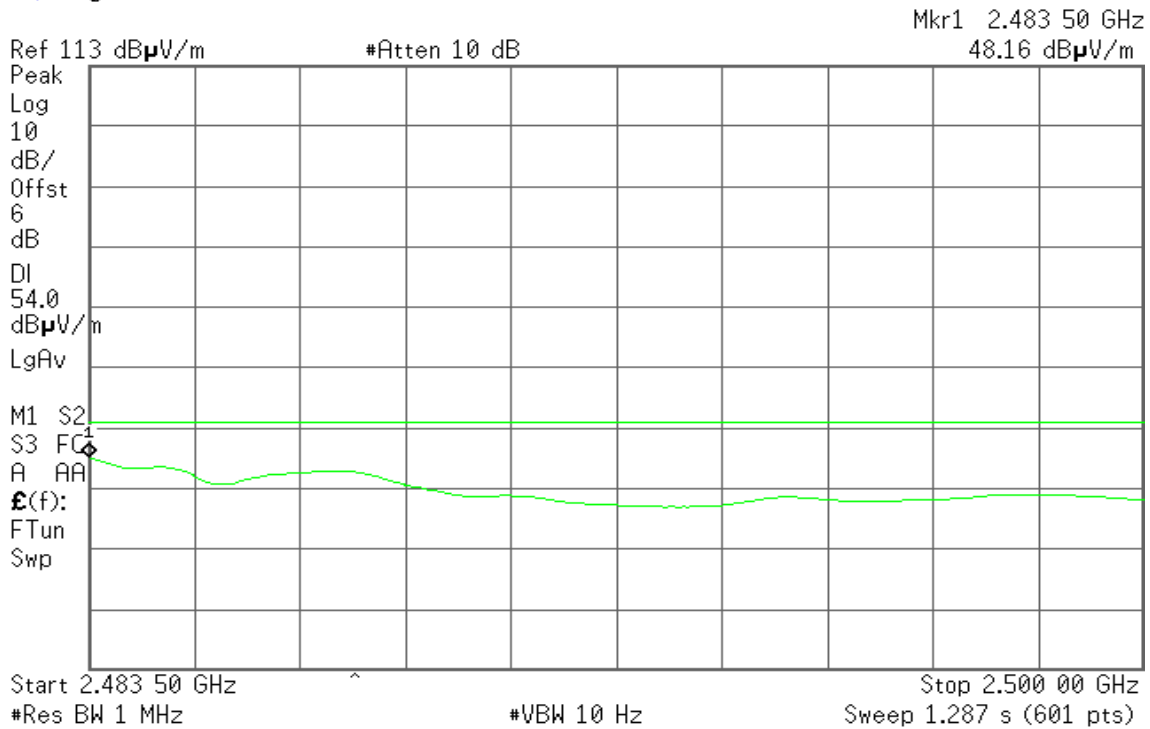



Band Edges (IEEE 802.11g mode / CH Low)

Detector mode: Peak

Polarity: Vertical

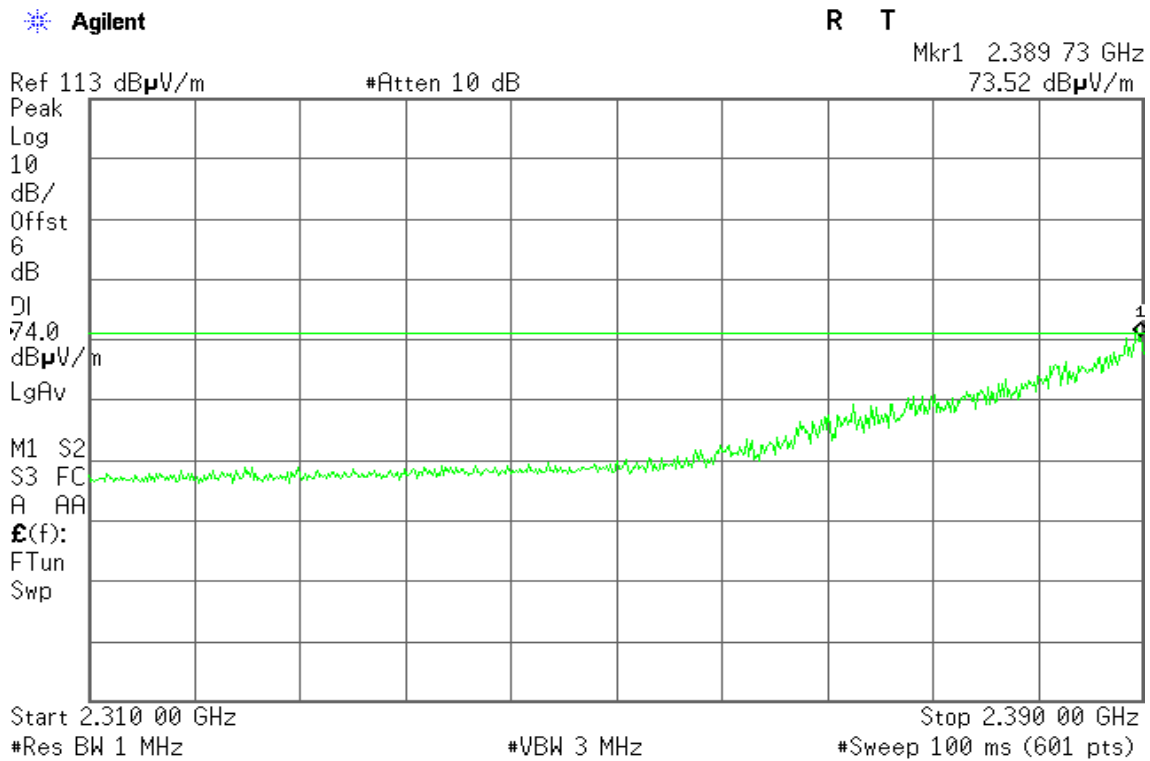

Detector mode: Average

Polarity: Vertical

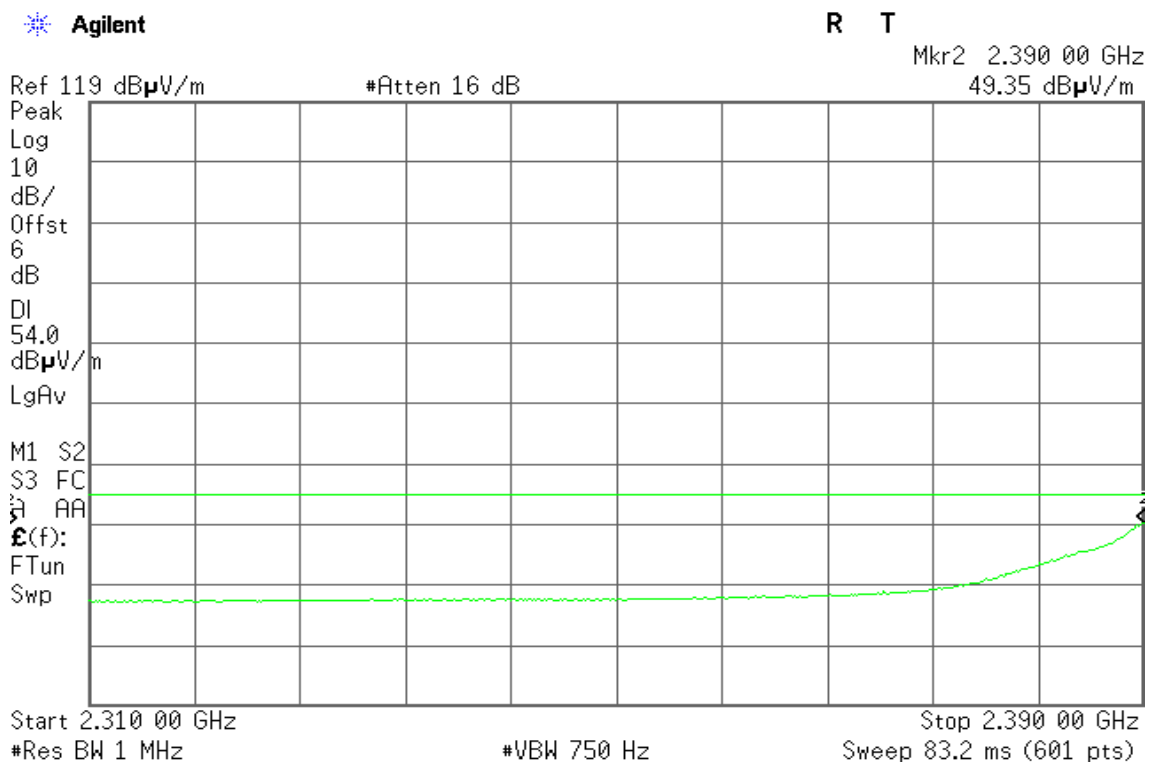



Detector mode: Peak

Polarity: Horizontal

Agilent

R T

Mkr1 2.389 73 GHz
71.86 dBμV/m

Ref 113 dBμV/m

#Atten 10 dB

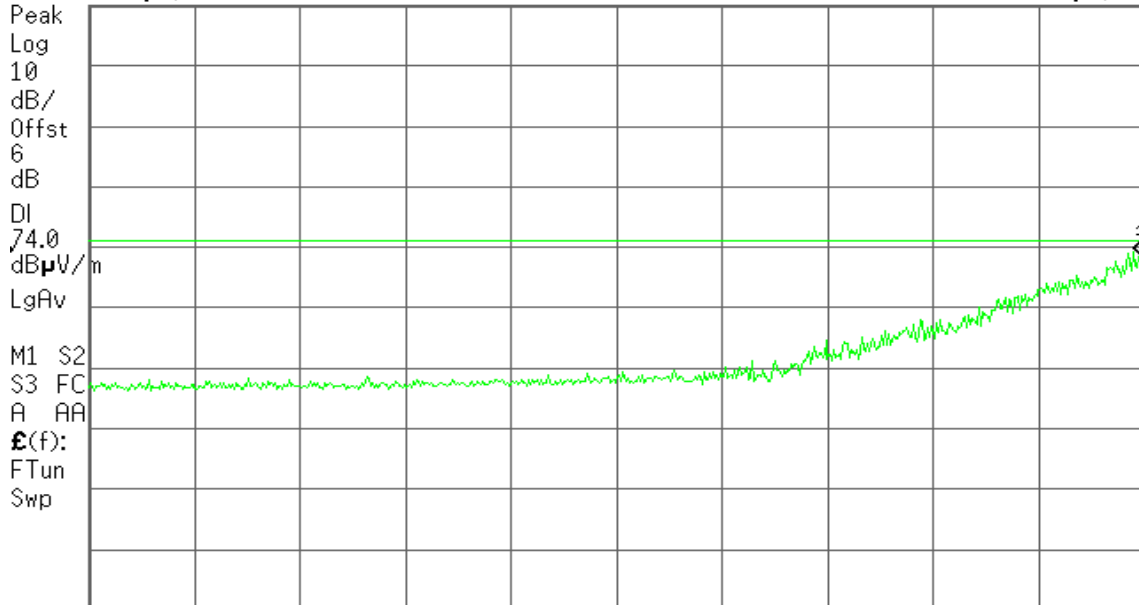

Start 2.310 00 GHz

Stop 2.390 00 GHz

#Res BW 1 MHz

#VBW 3 MHz

#Sweep 100 ms (601 pts)

Detector mode: Average

Polarity: Horizontal

Agilent

R T

Mkr2 2.390 00 GHz
51.00 dBμV/m

Ref 119 dBμV/m

#Atten 16 dB

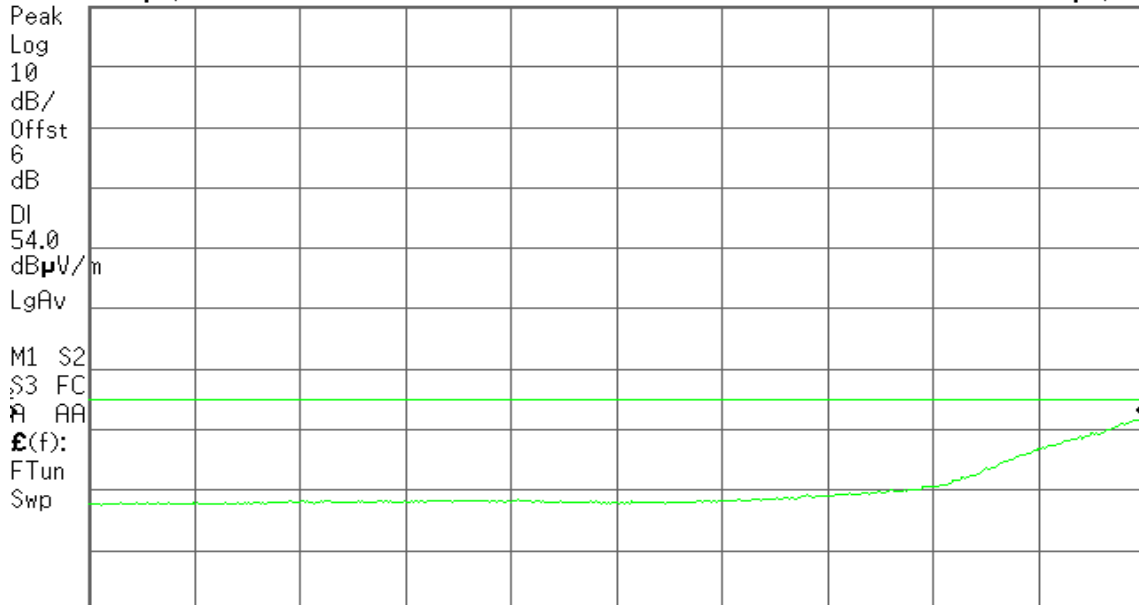

Start 2.310 00 GHz

Stop 2.390 00 GHz

#Res BW 1 MHz

#VBW 750 Hz

#Sweep 83.2 ms (601 pts)



Band Edges (IEEE 802.11g mode / CH High)

Detector mode: Peak

Polarity: Vertical

Agilent

R T

Mkr1 2.483 53 GHz
72.48 dB μ V/m

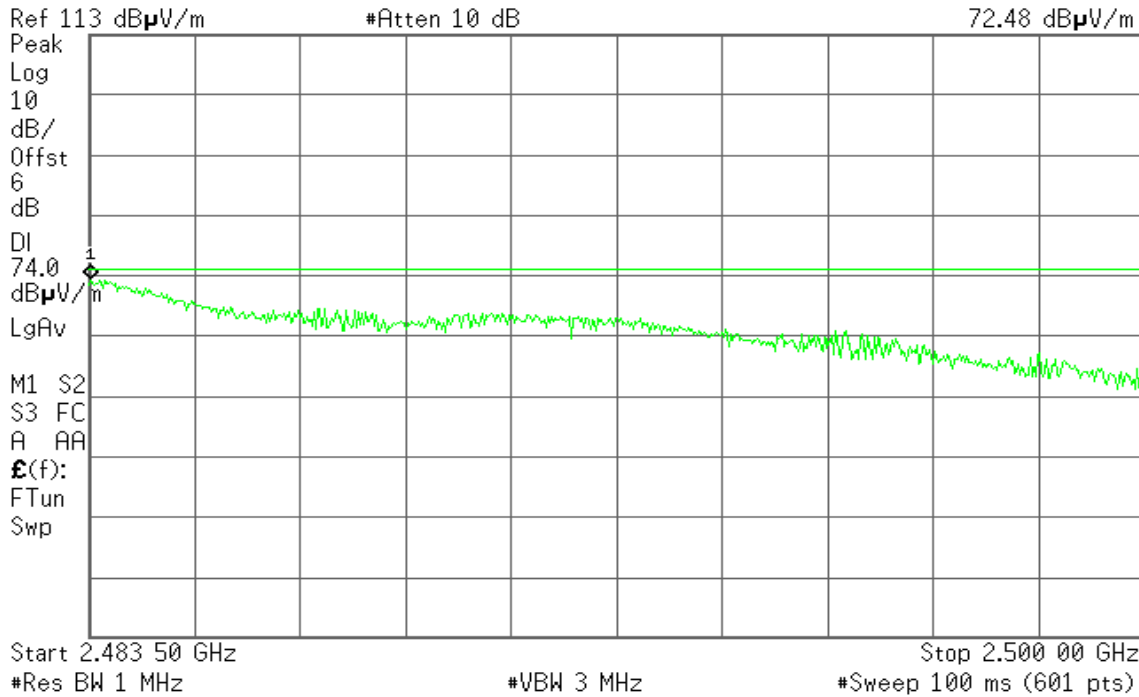

Detector mode: Average

Polarity: Vertical

Agilent

R T

Mkr2 2.483 61 GHz
51.73 dB μ V/m

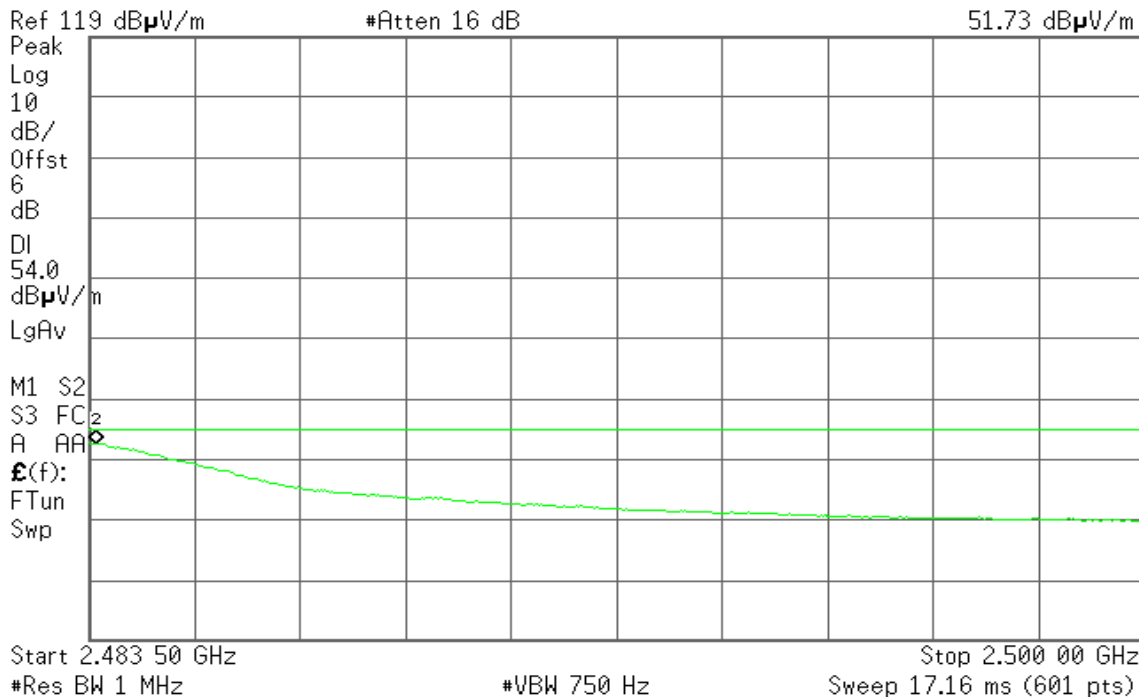



Detector mode: Peak

Polarity: Horizontal

Agilent

R T

Mkr1 2.483 86 GHz
70.45 dBµV/m

Ref 113 dBµV/m

#Atten 10 dB

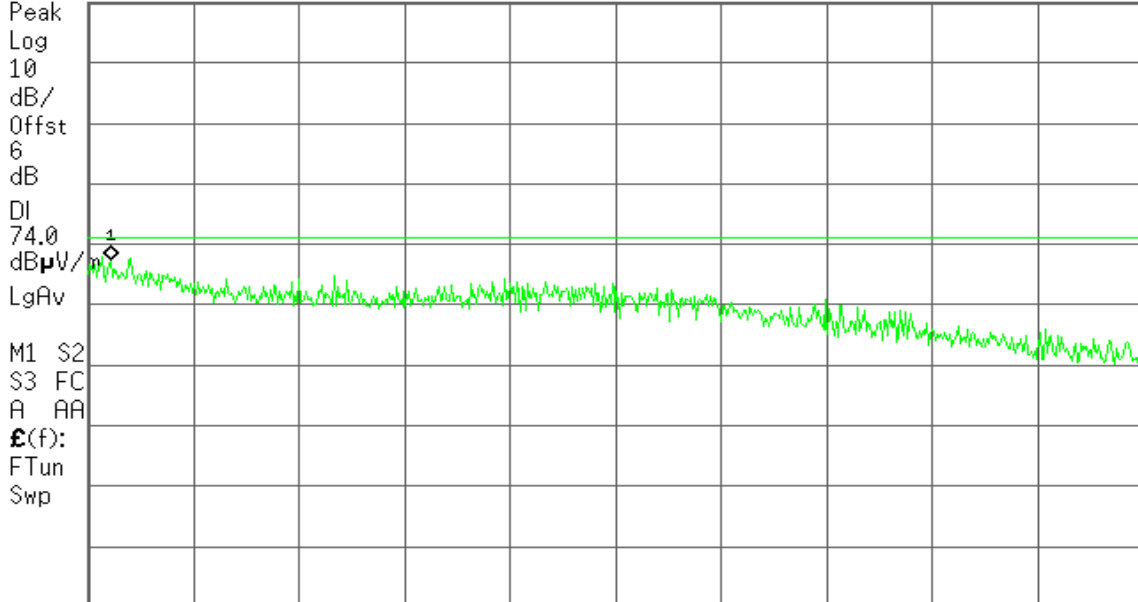

Start 2.483 50 GHz

Stop 2.500 00 GHz

#Res BW 1 MHz

#VBW 3 MHz

#Sweep 100 ms (601 pts)

Detector mode: Average

Polarity: Horizontal

Agilent

R T

Mkr2 2.483 53 GHz
51.54 dBµV/m

Ref 119 dBµV/m

#Atten 16 dB

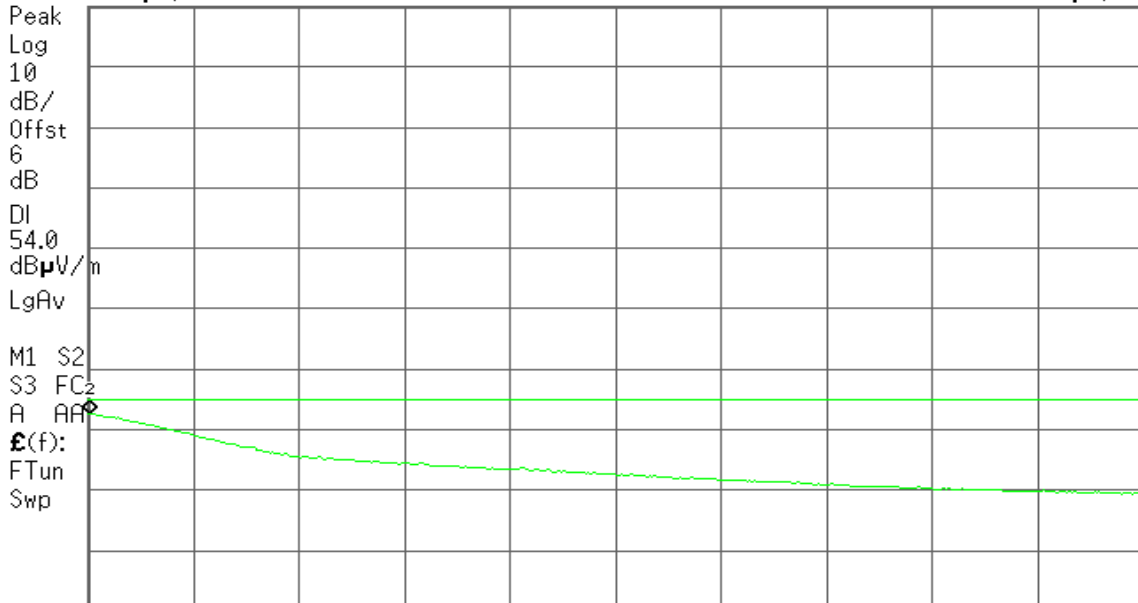

Start 2.483 50 GHz

Stop 2.500 00 GHz

#Res BW 1 MHz

#VBW 750 Hz

Sweep 17.16 ms (601 pts)



Band Edges (IEEE 802.11n HT 20 MHz mode / CH Low)

Detector mode: Peak

Polarity: Vertical

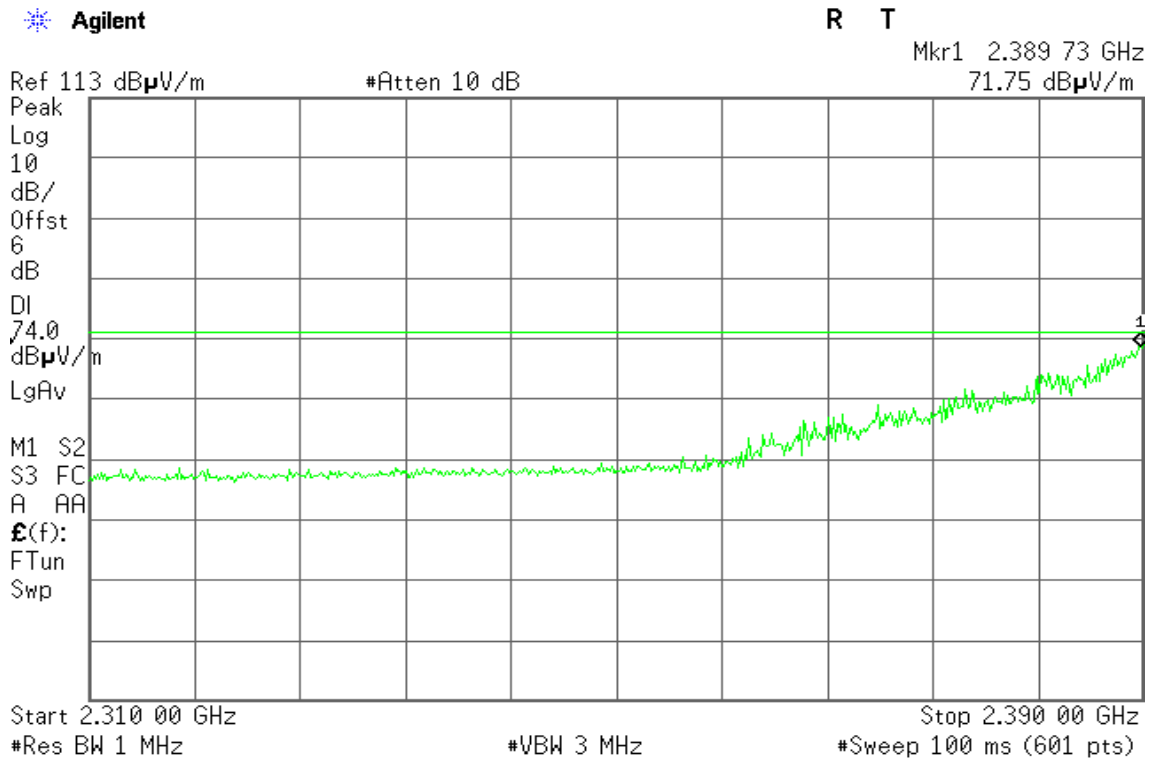

Detector mode: Average

Polarity: Vertical

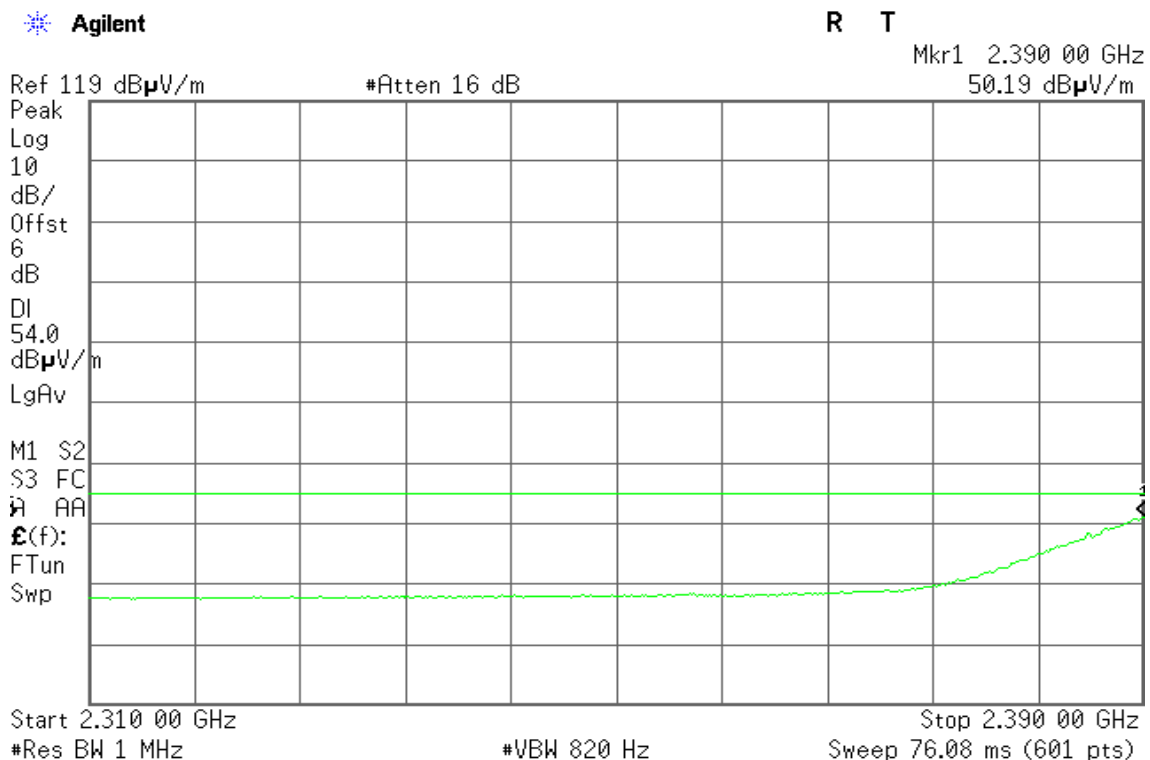



Detector mode: Peak

Polarity: Horizontal

Agilent

R T

Mkr1 2.388 67 GHz
68.37 dB μ V/m

Ref 113 dB μ V/m

#Atten 10 dB

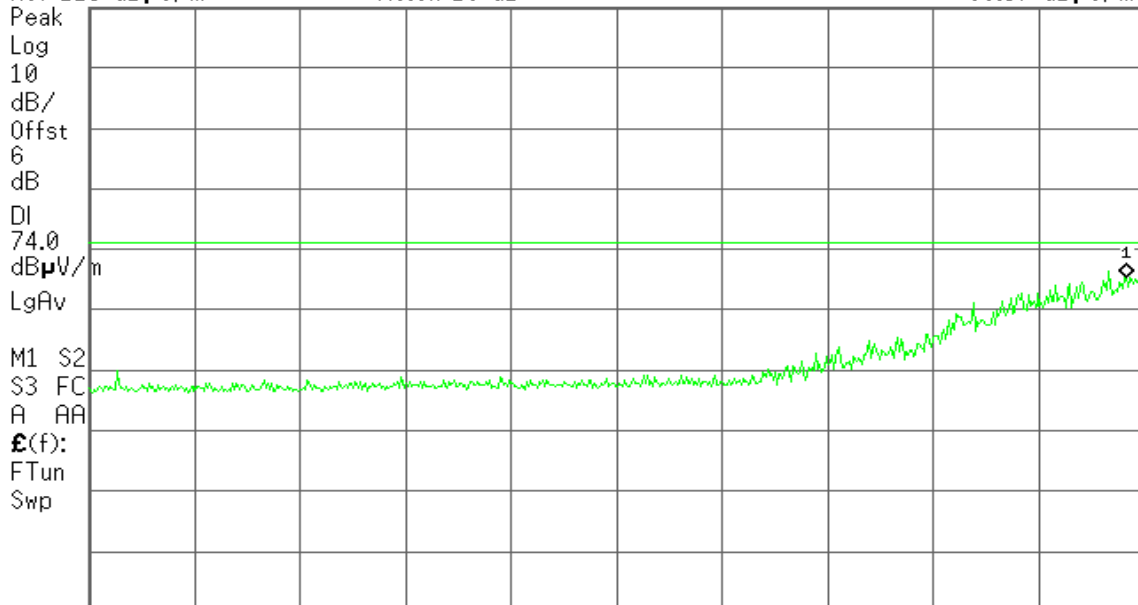

Start 2.310 00 GHz

Stop 2.390 00 GHz

#Res BW 1 MHz

#VBW 3 MHz

#Sweep 100 ms (601 pts)

Detector mode: Average

Polarity: Horizontal

Agilent

R T

Mkr1 2.390 00 GHz
51.21 dB μ V/m

Ref 119 dB μ V/m

#Atten 16 dB

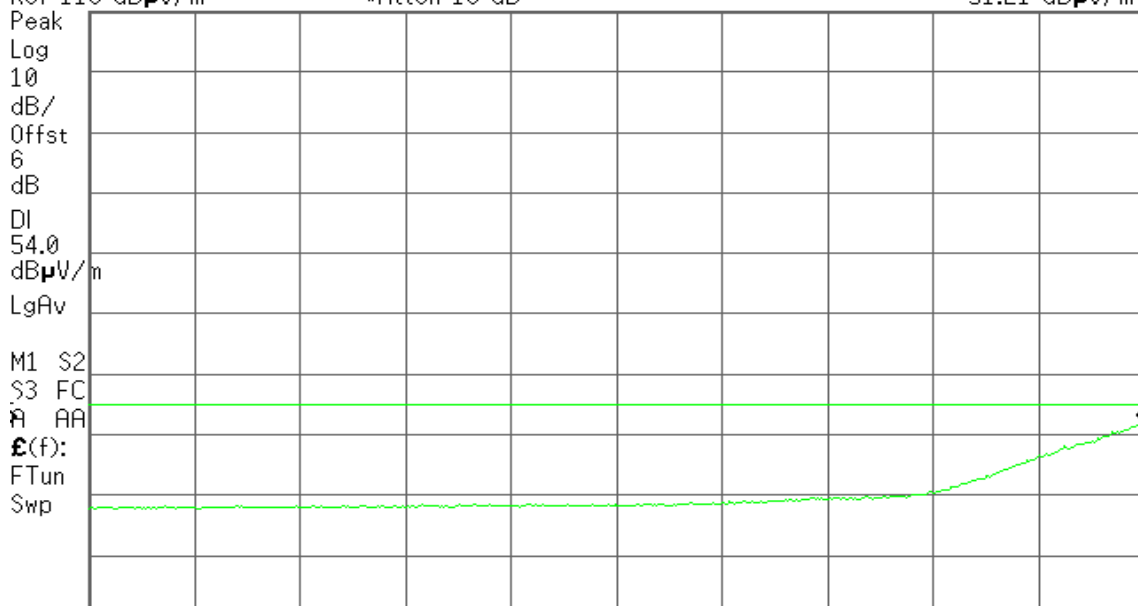

Start 2.310 00 GHz

Stop 2.390 00 GHz

#Res BW 1 MHz

#VBW 820 Hz

Sweep 76.08 ms (601 pts)



Band Edges (IEEE 802.11n HT 20 MHz mode / CH High)

Detector mode: Peak

Polarity: Vertical

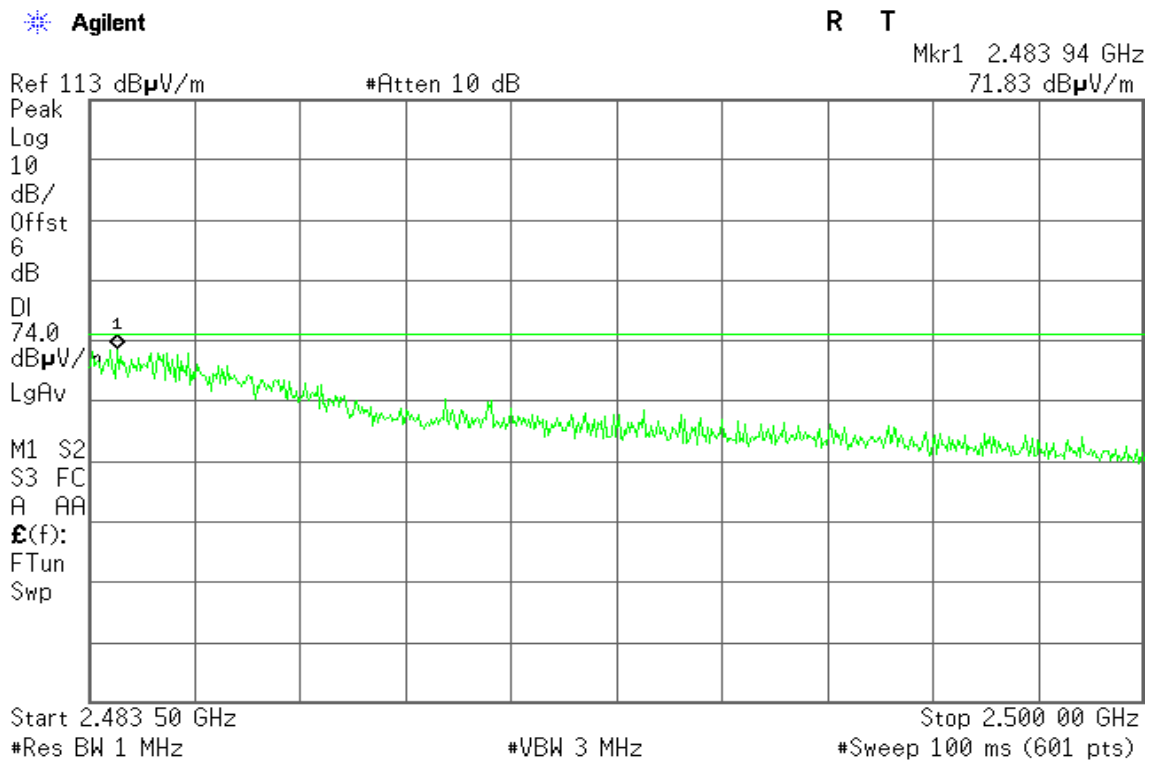

Detector mode: Average

Polarity: Vertical

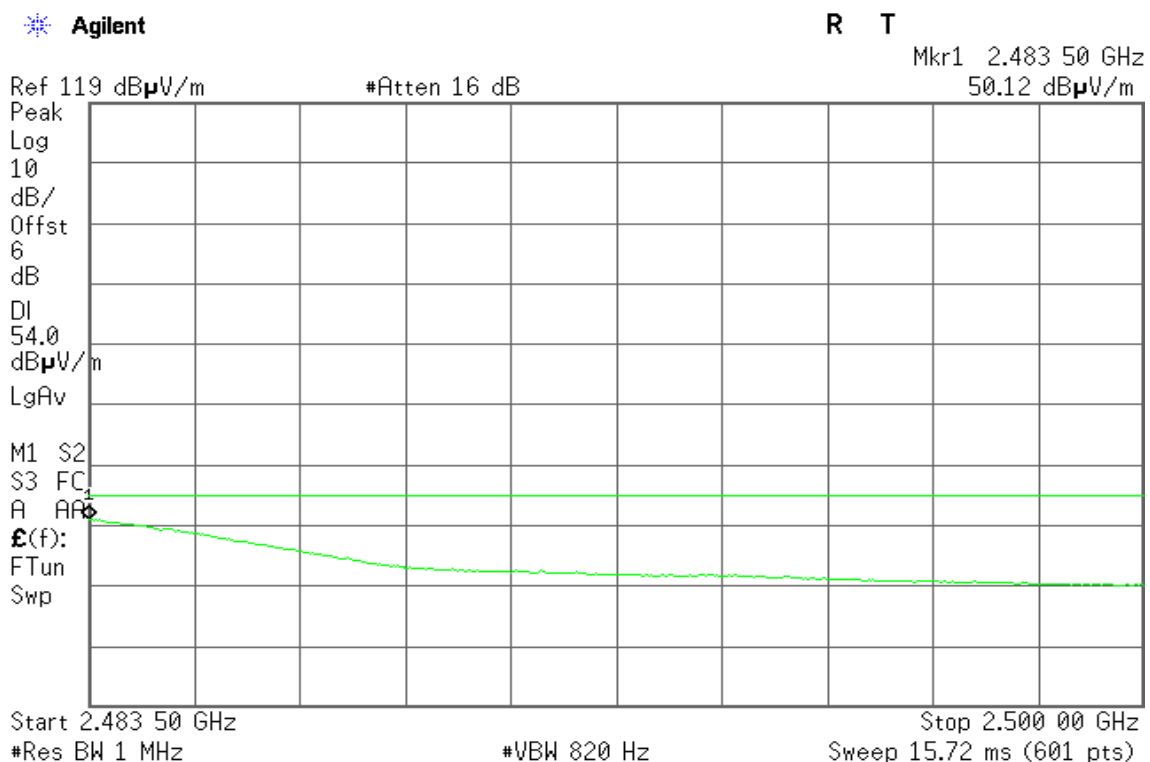



Detector mode: Peak

Polarity: Horizontal

Agilent

R T

Mkr1 2.483 80 GHz
71.68 dB μ V/m

Ref 113 dB μ V/m

#Atten 10 dB

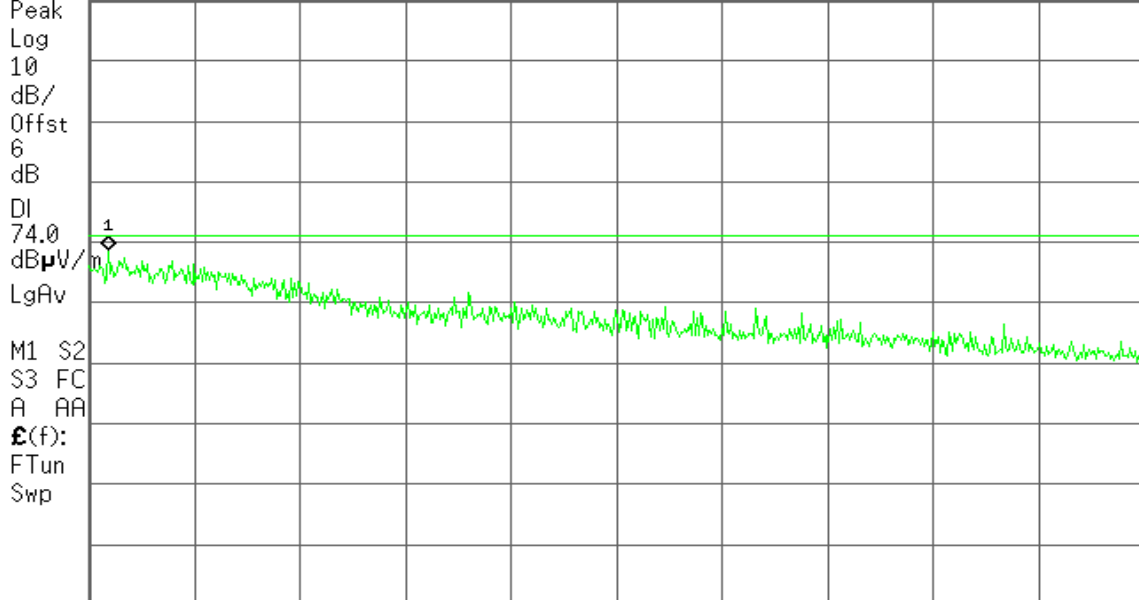

Start 2.483 50 GHz

Stop 2.500 00 GHz

#Res BW 1 MHz

#VBW 3 MHz

#Sweep 100 ms (601 pts)

Detector mode: Average

Polarity: Horizontal

Agilent

R T

Mkr1 2.483 58 GHz
51.98 dB μ V/m

Ref 119 dB μ V/m

#Atten 16 dB

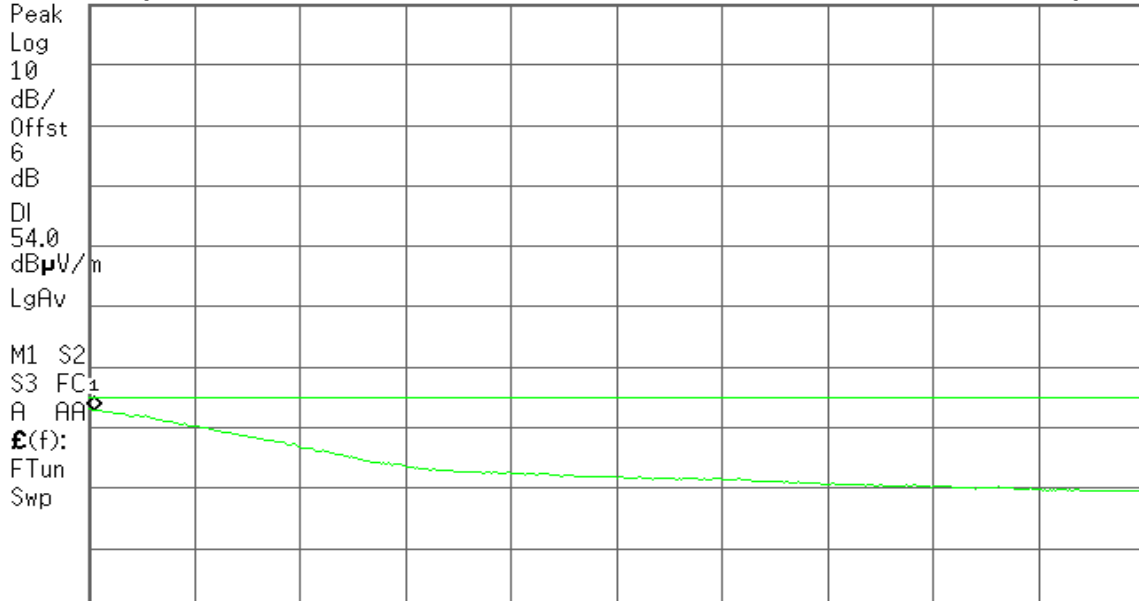

Start 2.483 50 GHz

Stop 2.500 00 GHz

#Res BW 1 MHz

#VBW 820 Hz

Sweep 15.72 ms (601 pts)



Band Edges (IEEE 802.11n HT 40 MHz mode / CH Low)

Detector mode: Peak

Polarity: Vertical

Agilent

R T

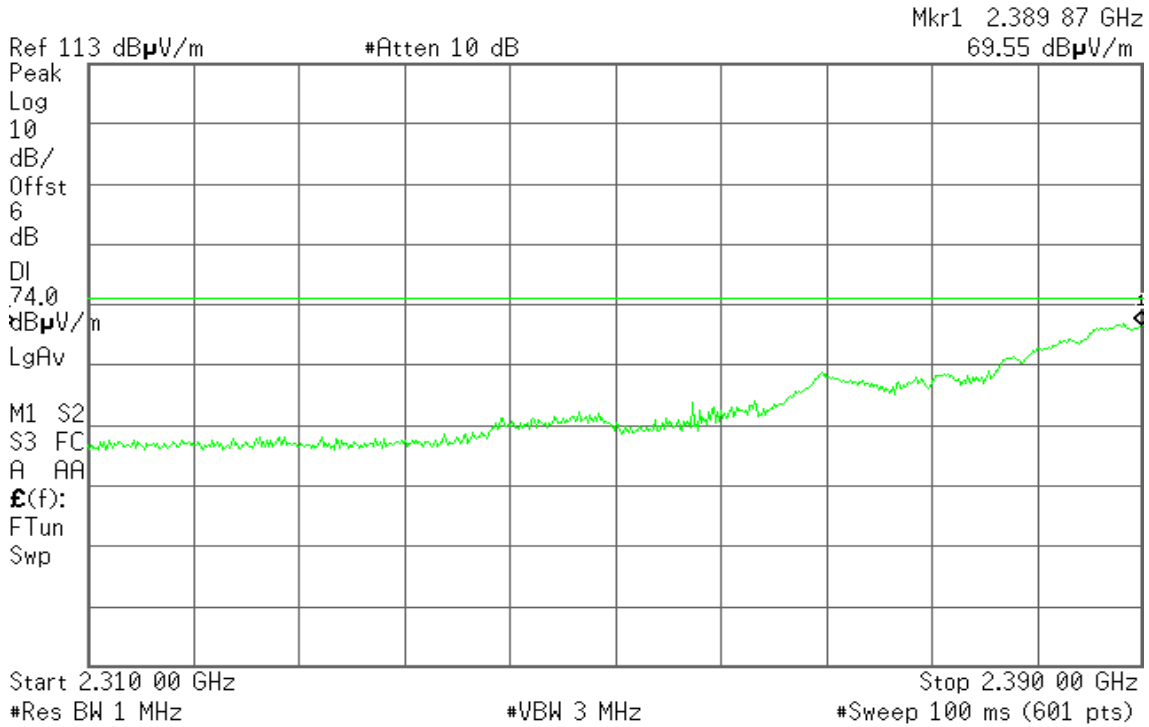

Detector mode: Average

Polarity: Vertical

Agilent

R T

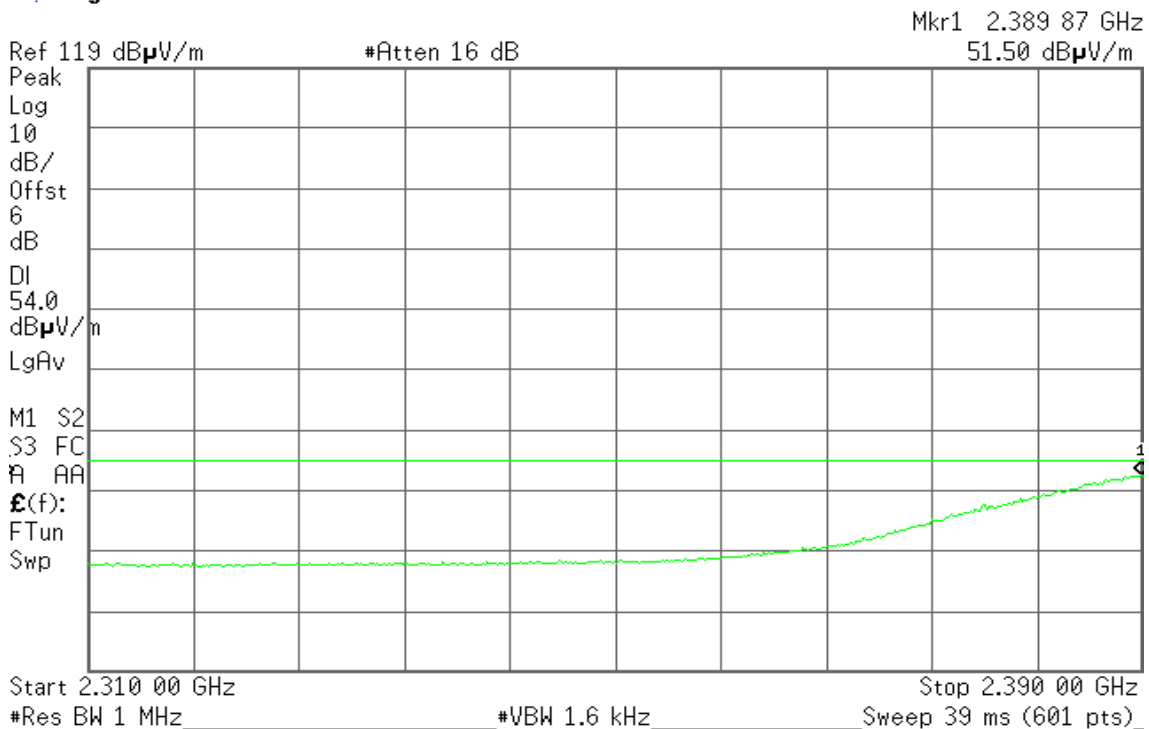



Detector mode: Peak

Polarity: Horizontal

Agilent

R T

Mkr1 2.387 60 GHz
66.06 dBµV/m

Ref 113 dBµV/m

#Atten 10 dB

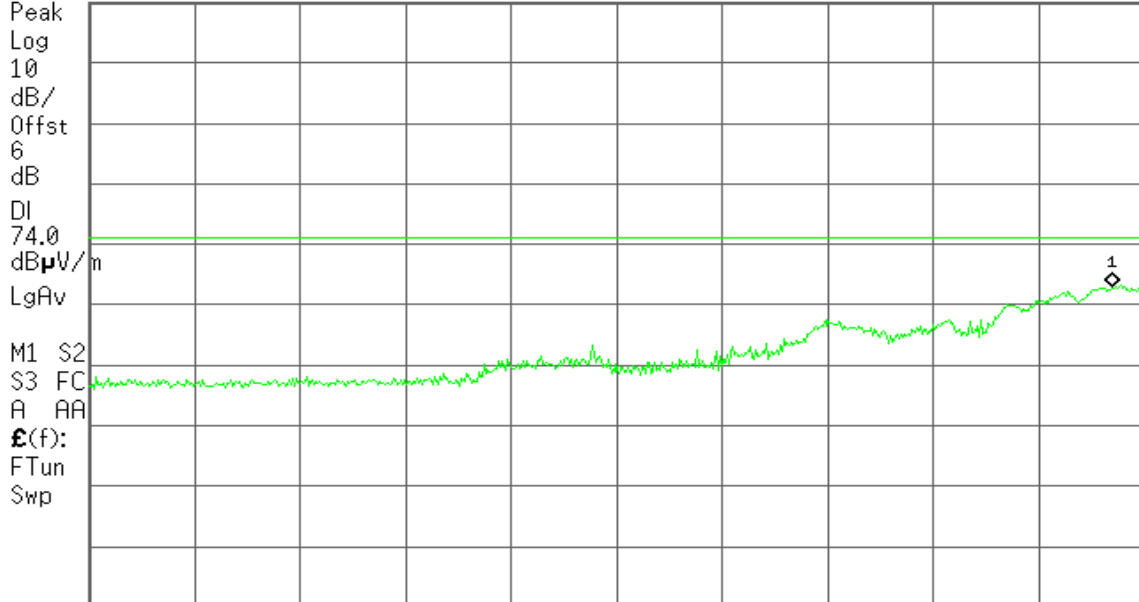

Start 2.310 00 GHz

Stop 2.390 00 GHz

#Res BW 1 MHz

#VBW 3 MHz

#Sweep 100 ms (601 pts)

Detector mode: Average

Polarity: Horizontal

Agilent

R T

Mkr1 2.390 00 GHz
50.34 dBµV/m

Ref 119 dBµV/m

#Atten 16 dB

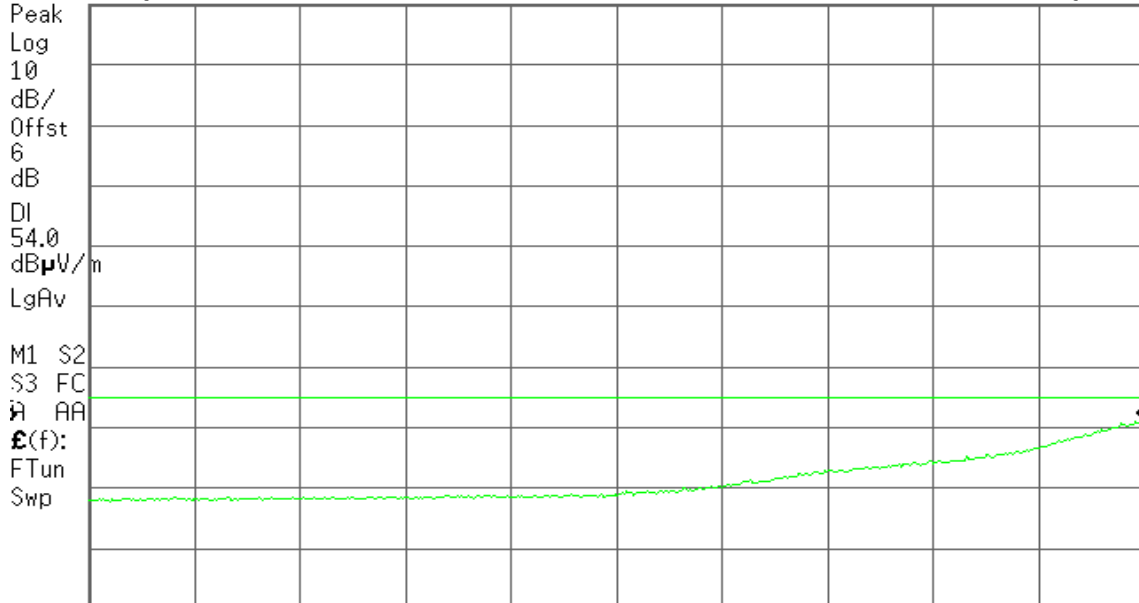

Start 2.310 00 GHz

Stop 2.390 00 GHz

#Res BW 1 MHz

#VBW 1.6 kHz

Sweep 39 ms (601 pts)



Band Edges (IEEE 802.11n HT 40 MHz mode / CH High)

Detector mode: Peak

Polarity: Vertical

Agilent

R T

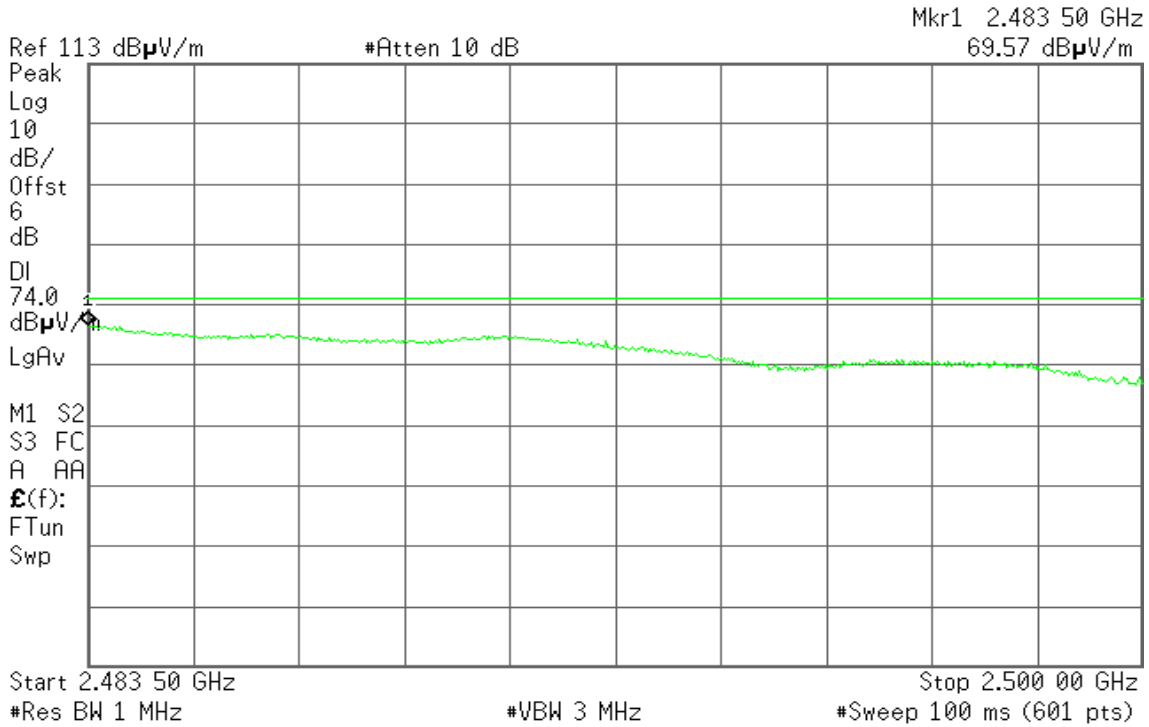

Detector mode: Average

Polarity: Vertical

Agilent

R T

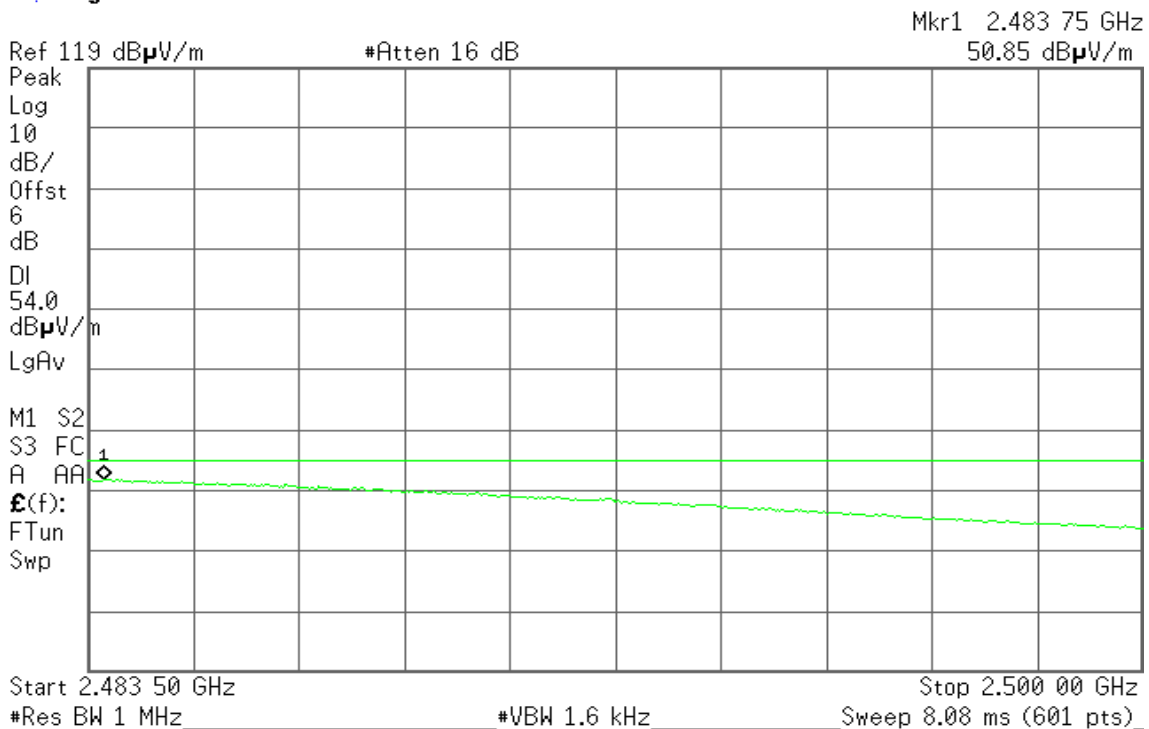



Detector mode: Peak

Polarity: Horizontal

Agilent

R T

Mkr1 2.483 53 GHz
68.75 dB μ V/m

Ref 113 dB μ V/m

#Atten 10 dB

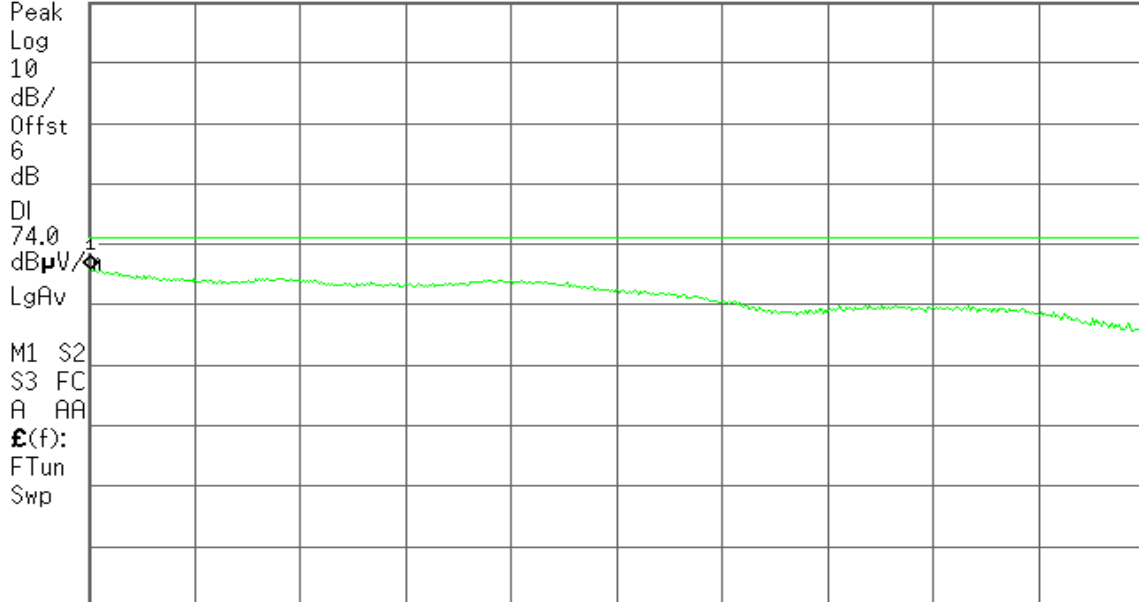

Start 2.483 50 GHz

Stop 2.500 00 GHz

#Res BW 1 MHz

#VBW 3 MHz

#Sweep 100 ms (601 pts)

Detector mode: Average

Polarity: Horizontal

Agilent

R T

Mkr1 2.483 58 GHz
49.87 dB μ V/m

Ref 119 dB μ V/m

#Atten 16 dB

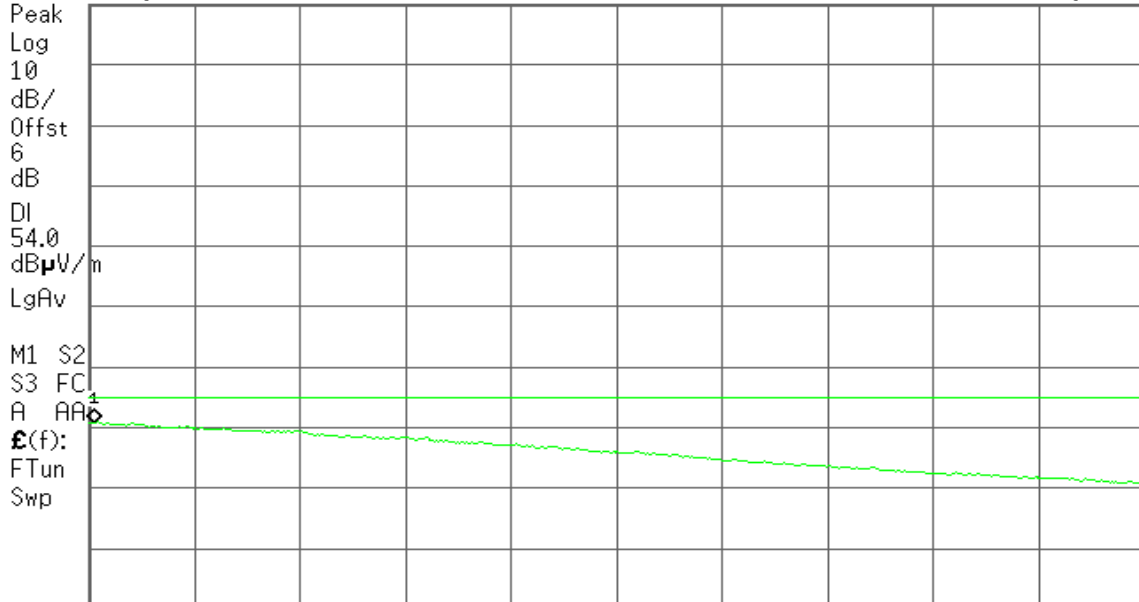

Start 2.483 50 GHz

Stop 2.500 00 GHz

#Res BW 1 MHz

#VBW 1.6 kHz

Sweep 8.08 ms (601 pts)



8.6 PEAK POWER SPECTRAL DENSITY

LIMIT

1. According to §15.247(e) & RSS-210 §A8.2, for digitally modulated systems, the power spectral density conducted from the intentional radiator to the antenna shall not be greater than 8 dBm in any 3 kHz band during any time interval of continuous transmission.
2. According to §15.247(f) & RSS-210 §A8.3, the digital modulation operation of the hybrid system, with the frequency hopping turned off, shall comply with the power density requirements of paragraph (d) of this section.

Test Configuration

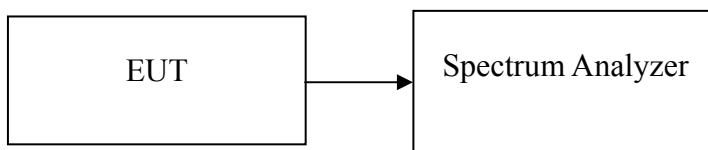

TEST PROCEDURE

The transmitter output is connected to a spectrum analyzer. Set the RBW = 100 kHz, VBW \geq 300 kHz, span 5-30% greater than EBW, Detector = peak, Trace mode = max hold, Sweep = auto couple. Scale the observed power level to an equivalent value in 3 kHz by adjusting (reducing) the measured power by a bandwidth correction factor (BWCF) where $BWCF = 10 \log(3 \text{ kHz}/100 \text{ kHz} = -15.2 \text{ dB})$. Record the maximum reading. Repeat the above procedure until the measurements for all frequencies are completed.

TEST RESULTS

No non-compliance noted

**Test Data****Test Data****Test mode: IEEE 802.11b mode**

Channel	Frequency (MHz)	100kHz PPSD (dBm)	3kHz PPSD (dBm)	Limit (dBm)	Result
Low	2412	7.72	-7.48	8	PASS
Mid	2442	8.22	-6.98		PASS
High	2462	8.03	-7.17		PASS

Test mode: IEEE 802.11g mode

Channel	Frequency (MHz)	100kHz PPSD (dBm)	3kHz PPSD (dBm)	Limit (dBm)	Result
Low	2412	3.15	-12.05	8	PASS
Mid	2442	3.15	-12.05		PASS
High	2462	3.58	-11.62		PASS

Test mode: IEEE 802.11n HT 20 MHz mode

Channel	Frequency (MHz)	100kHz PPSD (dBm)	3kHz PPSD (dBm)	Limit (dBm)	Result
Low	2412	2.67	-12.53	8	PASS
Mid	2442	3.08	-12.12		PASS
High	2462	2.7	-12.50		PASS

Test mode: IEEE 802.11n HT 40 MHz mode

Channel	Frequency (MHz)	100kHz PPSD (dBm)	3kHz PPSD (dBm)	Limit (dBm)	Result
Low	2422	1.55	-13.65	8	PASS
Mid	2442	0.92	-14.28		PASS
High	2452	1.35	-13.85		PASS



Test Plot

IEEE 802.11b mode

PPSD (CH Low)

Agilent 20:59:08 Jul 31, 2012

R T

Mkr1 2.412 53 GHz
7.72 dBm

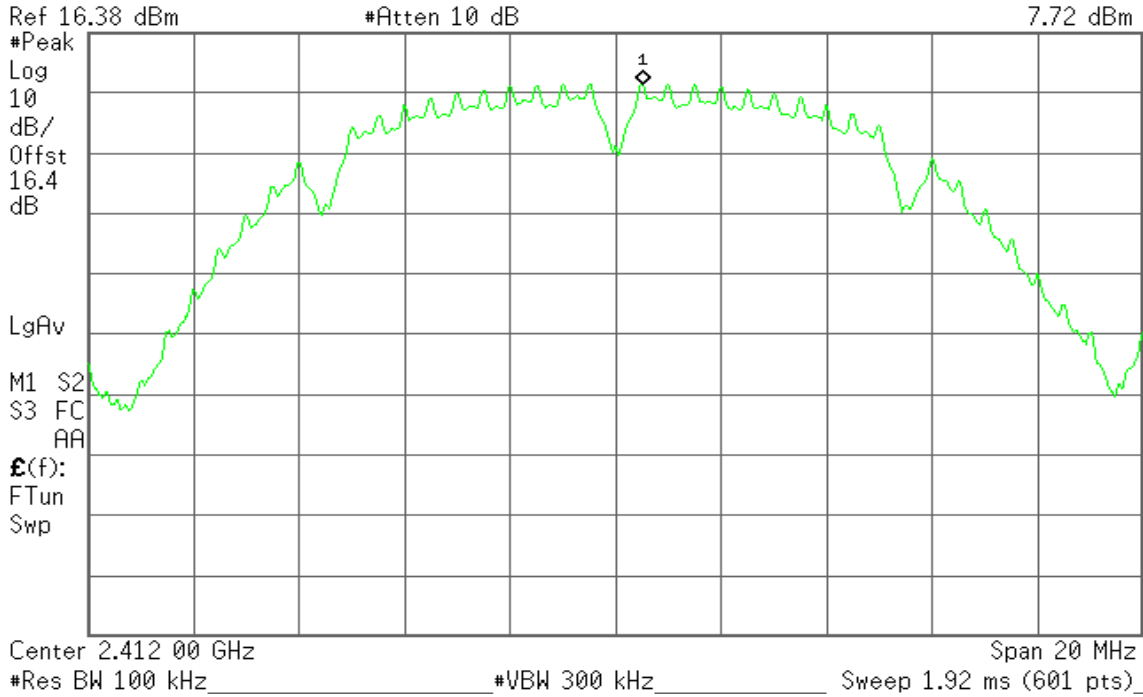

PPSD (CH Mid)

Agilent 20:59:53 Jul 31, 2012

R T

Mkr1 2.441 00 GHz
8.22 dBm

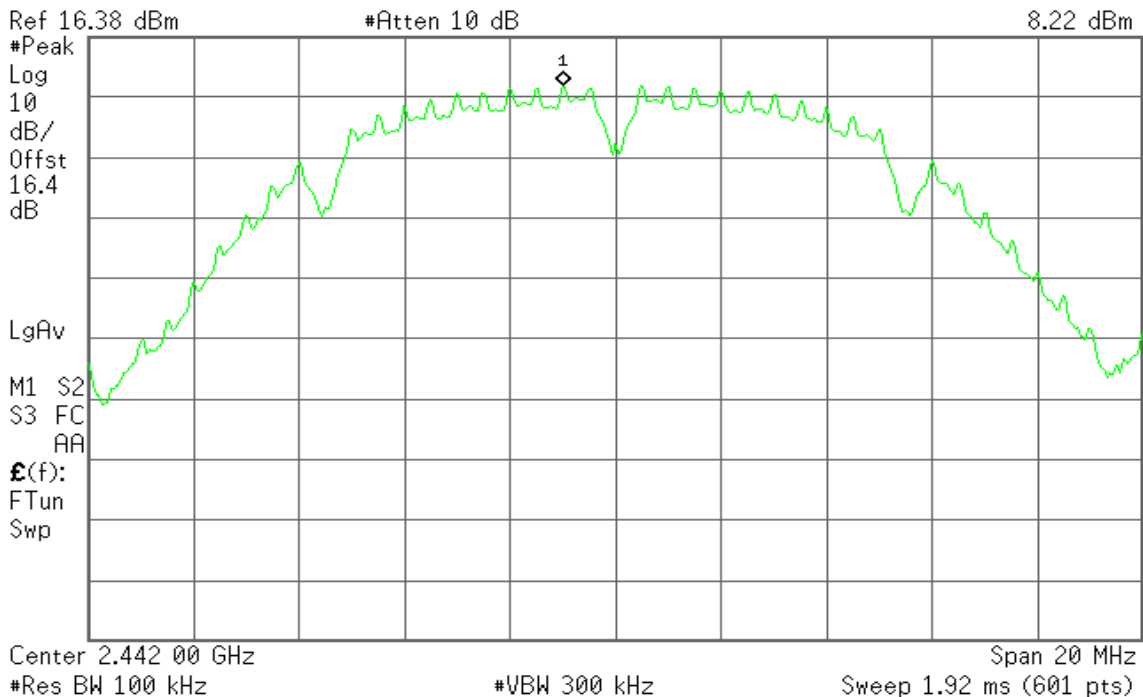



PPSD (CH High)

Agilent 21:00:29 Jul 31, 2012

R T

Mkr1 2.461 50 GHz
8.03 dBm

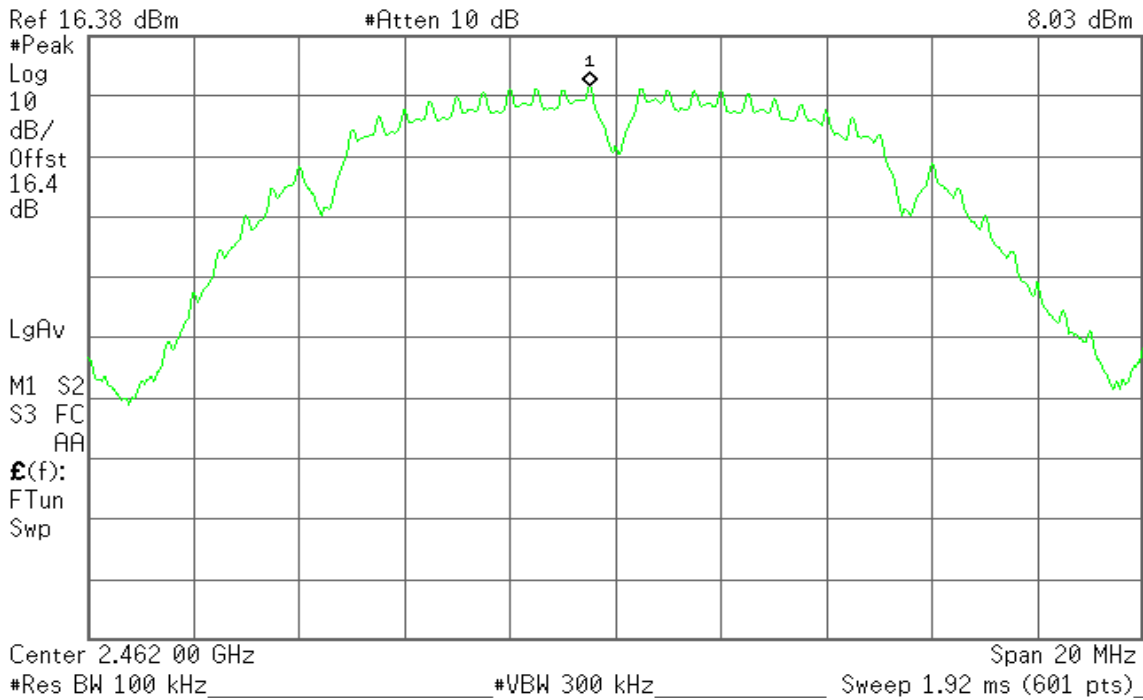

IEEE 802.11g mode

PPSD (CH Low)

Agilent 21:02:42 Jul 31, 2012

R T

Mkr1 2.419 50 GHz
3.15 dBm

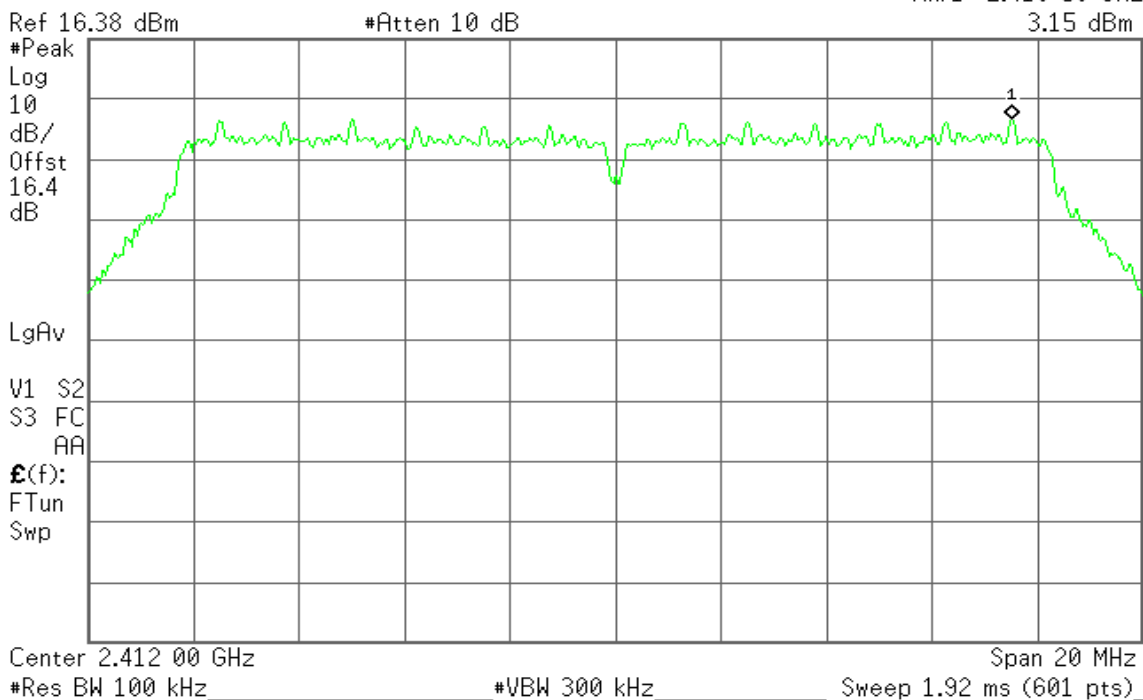



PPSD (CH Mid)

Agilent 21:01:57 Jul 31, 2012

R T

Mkr1 2.434 50 GHz
3.15 dBm

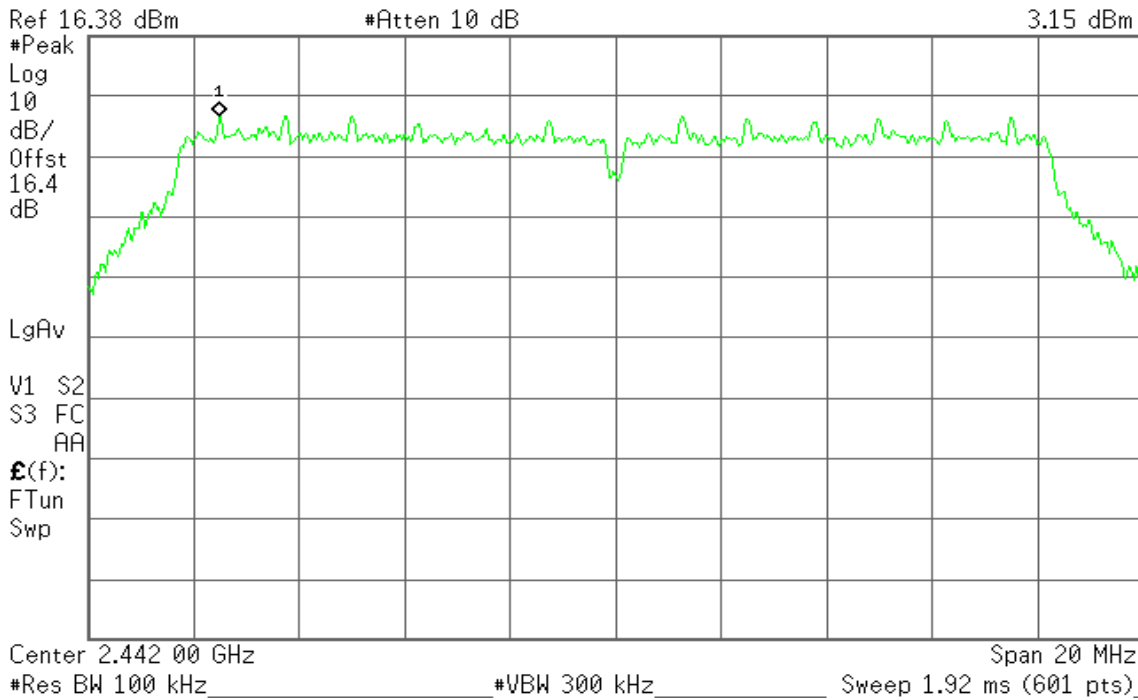

PPSD (CH High)

Agilent 21:01:19 Jul 31, 2012

R T

Mkr1 2.454 53 GHz
3.58 dBm

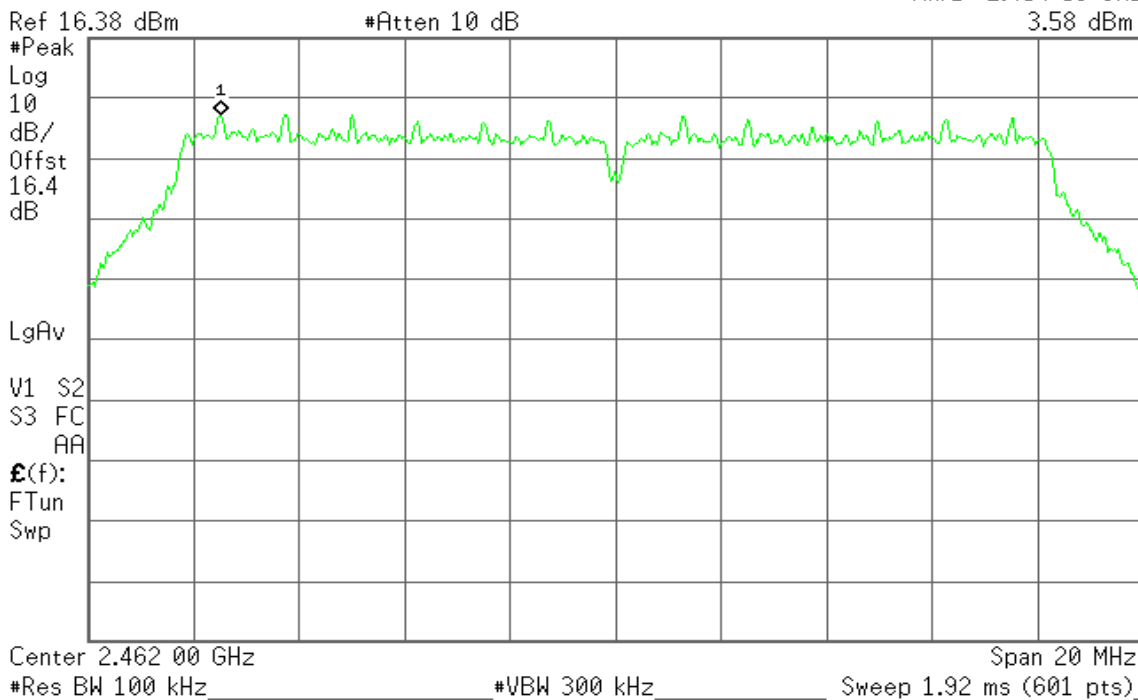



IEEE 802.11n HT 20 MHz mode

PPSD (CH Low)

Agilent 21:03:26 Jul 31, 2012

R T

Mkr1 2.417 00 GHz
2.67 dBm

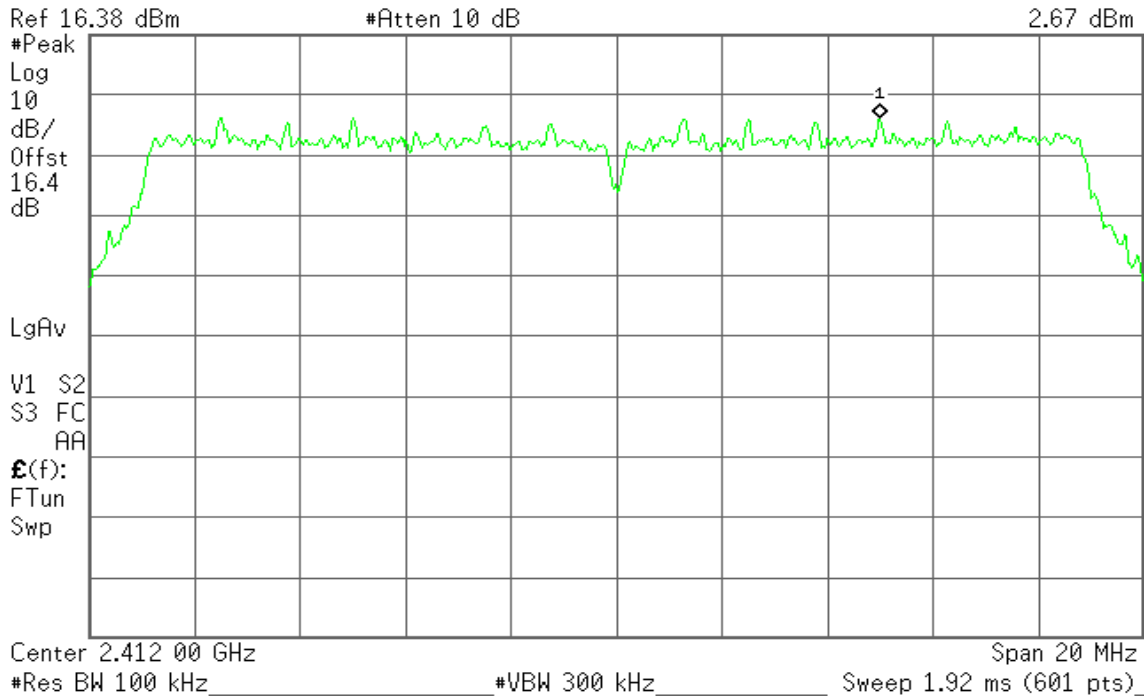

PPSD (CH Mid)

Agilent 21:04:02 Jul 31, 2012

R T

Mkr1 2.435 73 GHz
3.08 dBm

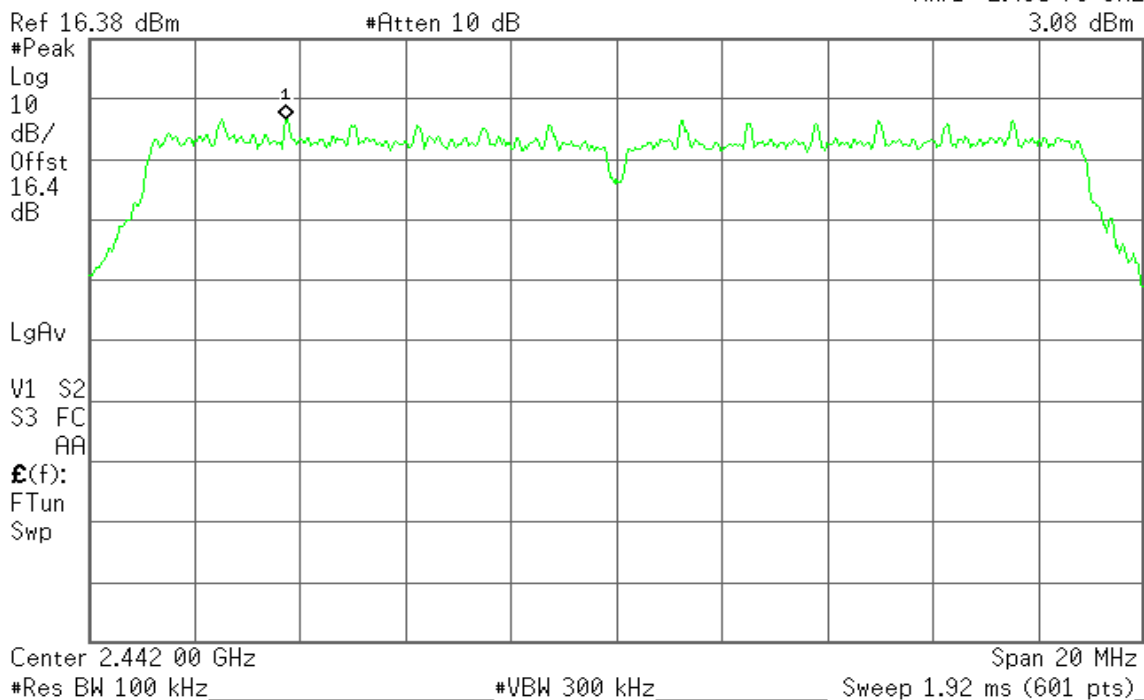



PPSD (CH High)

Agilent 21:04:33 Jul 31, 2012

R T

Mkr1 2.463 27 GHz
2.70 dBm

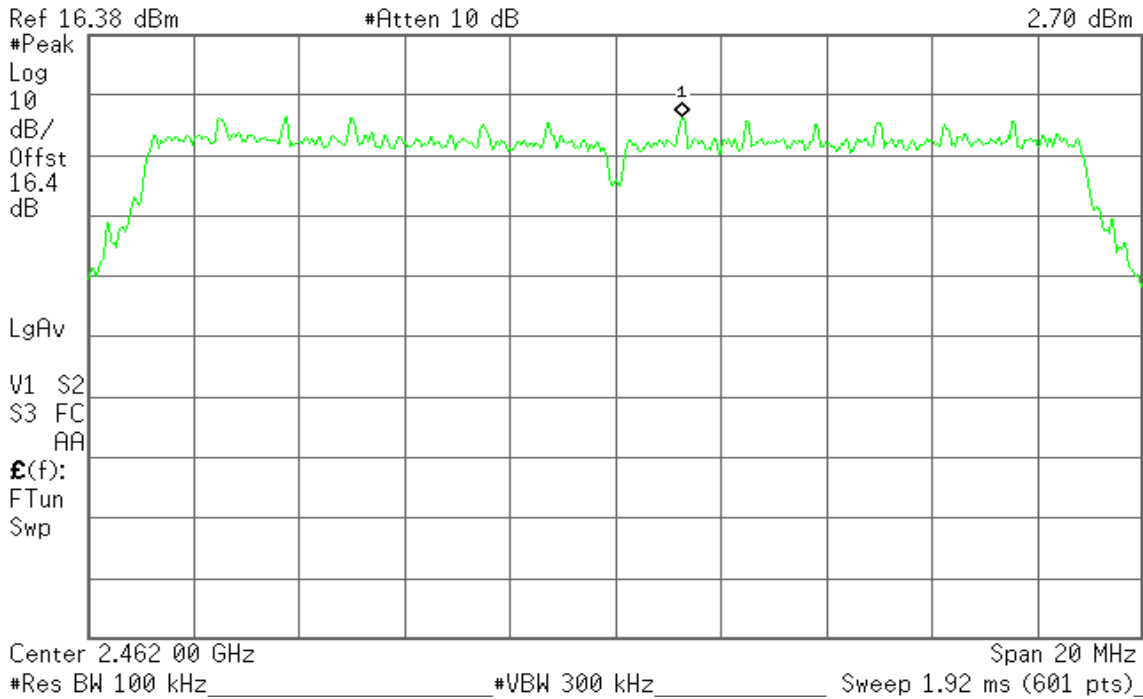

IEEE 802.11n HT 40 MHz mode

PPSD (CH Low)

Agilent 21:05:15 Jul 31, 2012

R T

Mkr1 2.419 47 GHz
1.55 dBm

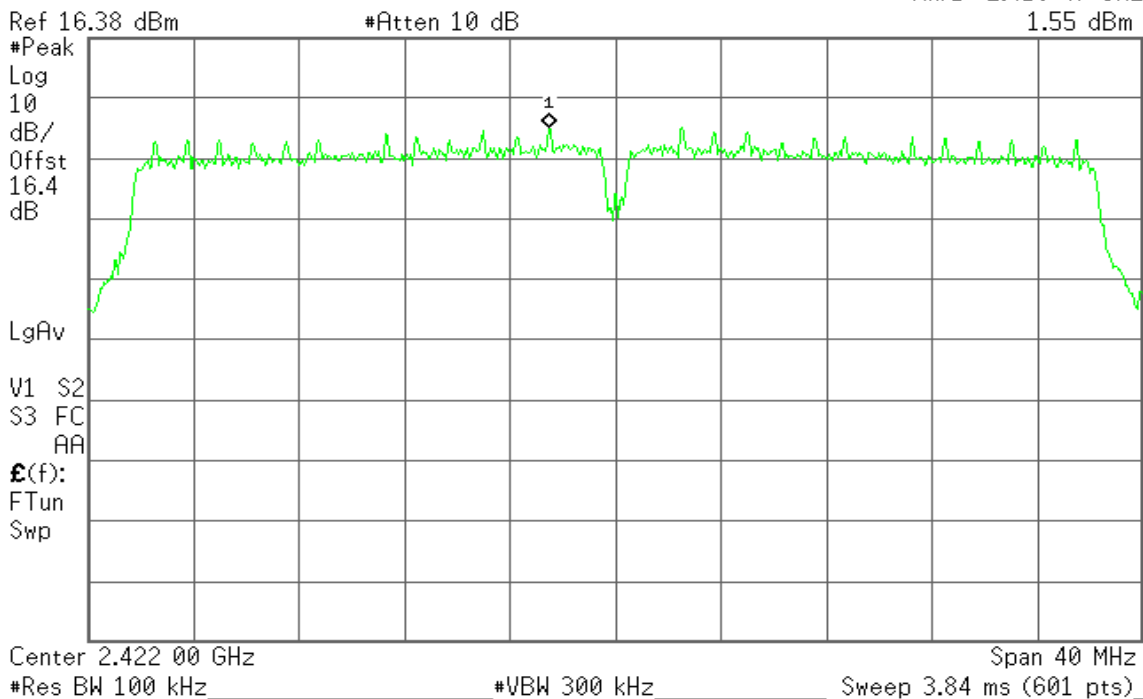



PPSD (CH Mid)

Agilent 21:05:49 Jul 31, 2012

R T

Mkr1 2.439 47 GHz
0.92 dBm

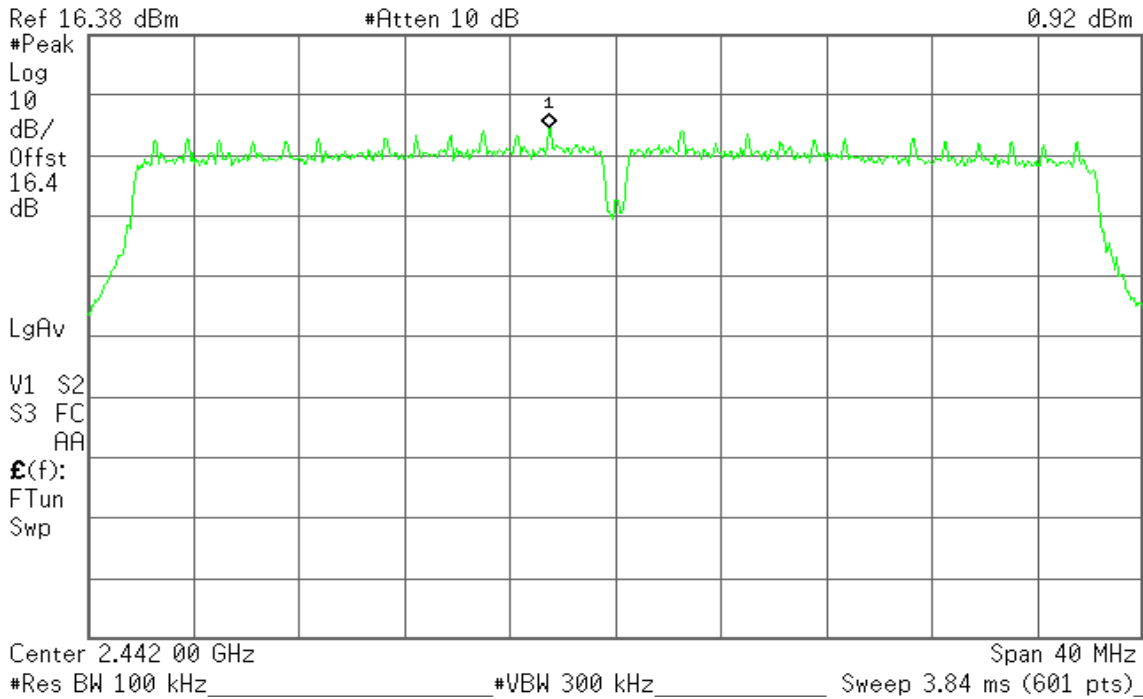

PPSD (CH High)

Agilent 21:06:19 Jul 31, 2012

R T

Mkr1 2.449 47 GHz
1.35 dBm

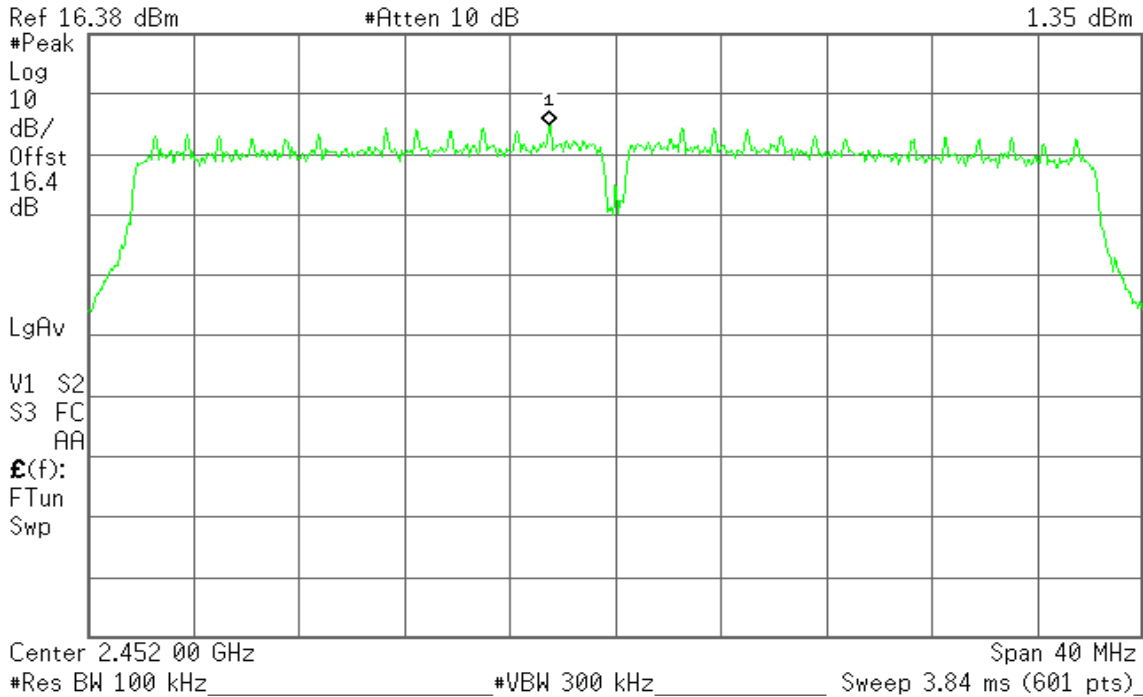



8.7 SPURIOUS EMISSIONS

8.7.1 Conducted Measurement

LIMIT

According to §15.247(d) & RSS-210 §A8.5, in any 100 kHz bandwidth outside the frequency bands in which the spread spectrum intentional radiator is operating, the radio frequency power that is produced by the intentional radiator shall be at least 20 dB below that in the 100 kHz bandwidth within the band that contains the highest level of the desired power, based on either an RF conducted or a radiated measurement, provided the transmitter demonstrates compliance with the peak conducted power limits. In addition, radiated emissions which fall in the restricted bands, as defined in §15.205(a), must also comply with the radiated emission limits specified in 15.209(a) (see Section 15.205(c)).

Test Configuration

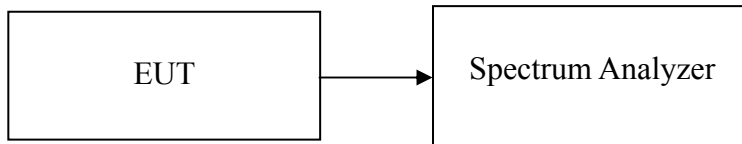

TEST PROCEDURE

Conducted RF measurements of the transmitter output were made to confirm that the EUT antenna port conducted emissions meet the specified limit and to identify any spurious signals that require further investigation or measurements on the radiated emissions site.

The transmitter output is connected to the spectrum analyzer. The resolution bandwidth is set to 100 kHz. The video bandwidth is set to 100 kHz.

Measurements are made over the 30MHz to 26GHz range with the transmitter set to the lowest, middle, and highest channels.

TEST RESULTS

No non-compliance noted



Test Plot

IEEE 802.11b mode

CH Low

Agilent 21:10:43 Jul 31, 2012

R T

Mkr2 4.83 GHz
-33.91 dBm

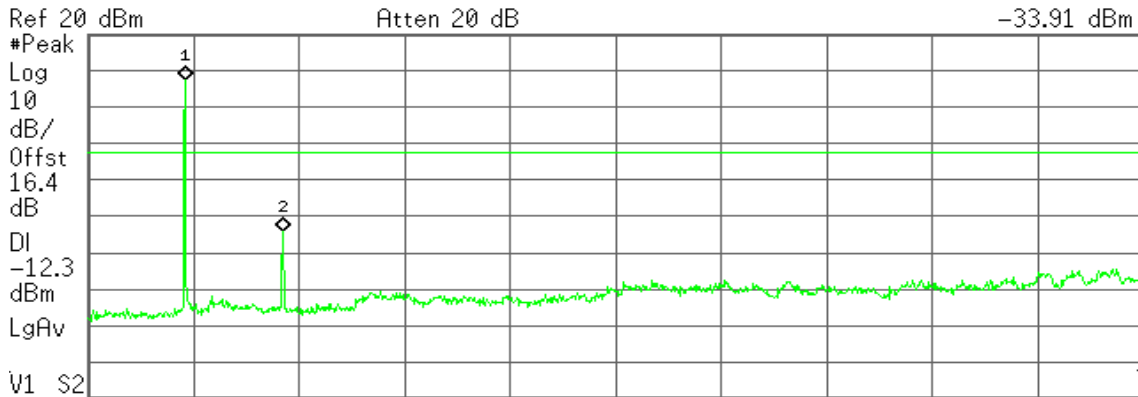

Marker	Trace	Type	X Axis	Amplitude
1	(1)	Freq	2.42 GHz	7.52 dBm
2	(1)	Freq	4.83 GHz	-33.91 dBm

CH Mid

Agilent 21:13:19 Jul 31, 2012

R T

Mkr2 4.89 GHz
-33.41 dBm

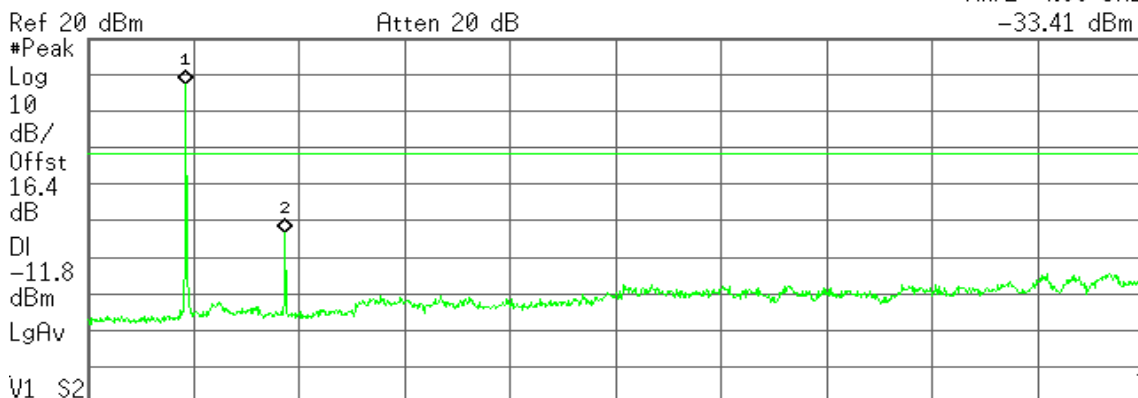

Marker	Trace	Type	X Axis	Amplitude
1	(1)	Freq	2.45 GHz	7.30 dBm
2	(1)	Freq	4.89 GHz	-33.41 dBm



CH High

Agilent 21:15:42 Jul 31, 2012

R T

Mkr2 4.91 GHz
-33.14 dBm

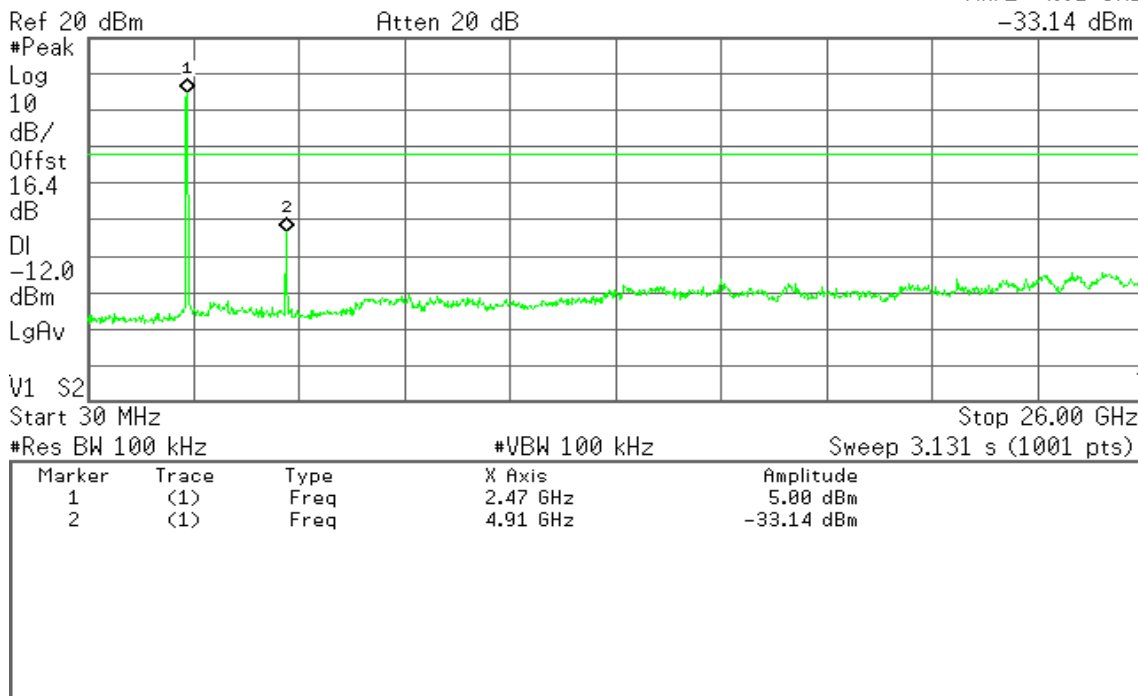

IEEE 802.11g mode

CH Low

Agilent 21:18:18 Jul 31, 2012

R T

Mkr2 4.83 GHz
-45.10 dBm

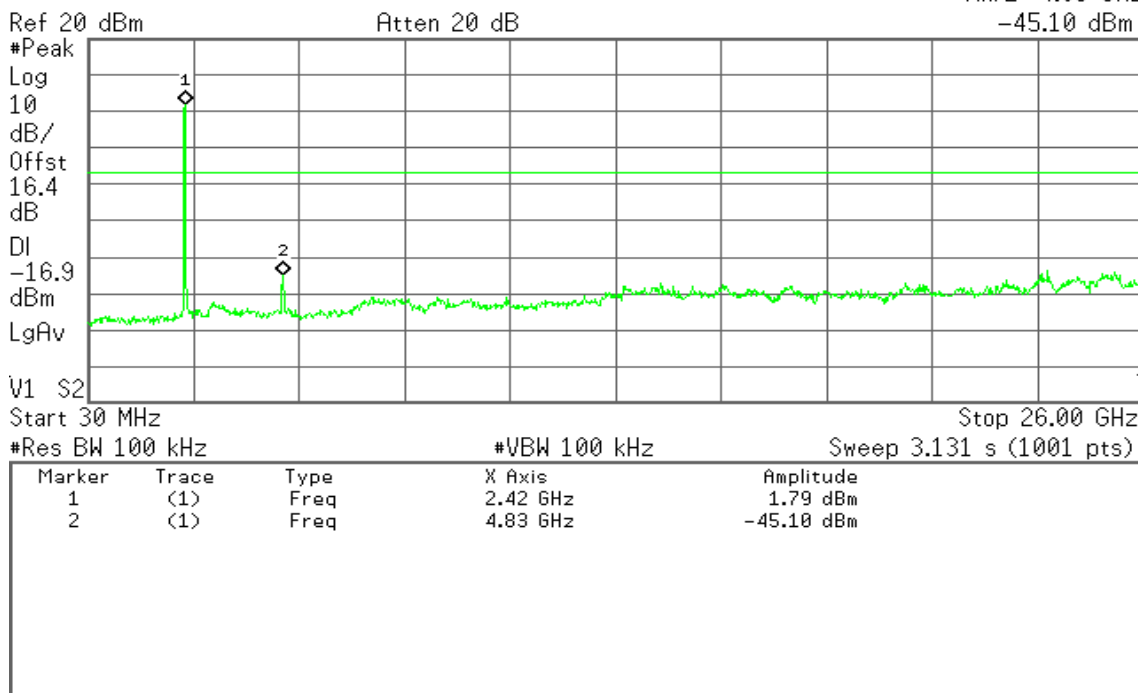



CH Mid

Agilent 21:20:56 Jul 31, 2012

R T

Mkr2 4.89 GHz
-47.21 dBm

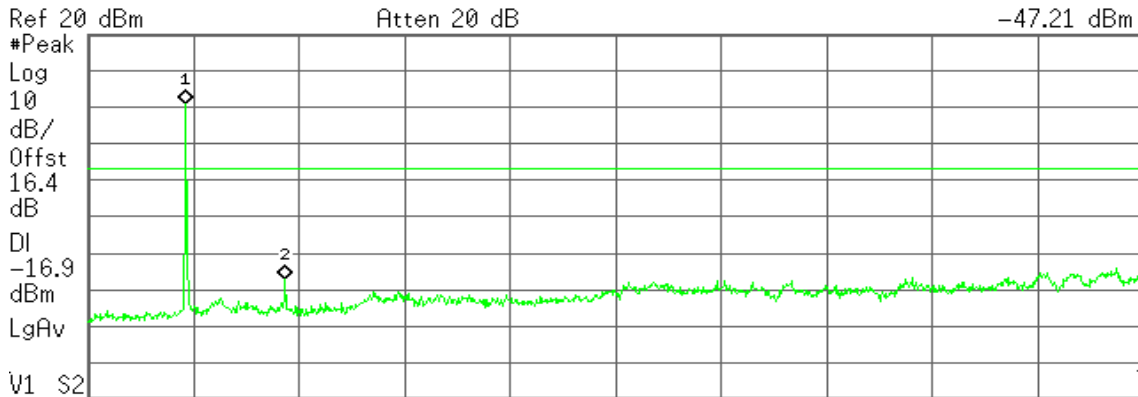

Start 30 MHz Stop 26.00 GHz
#Res BW 100 kHz #VBW 100 kHz Sweep 3.131 s (1001 pts)

Marker	Trace	Type	X Axis	Amplitude
1	(1)	Freq	2.45 GHz	1.11 dBm
2	(1)	Freq	4.89 GHz	-47.21 dBm

CH High

Agilent 21:23:52 Jul 31, 2012

R T

Mkr2 4.91 GHz
-46.82 dBm

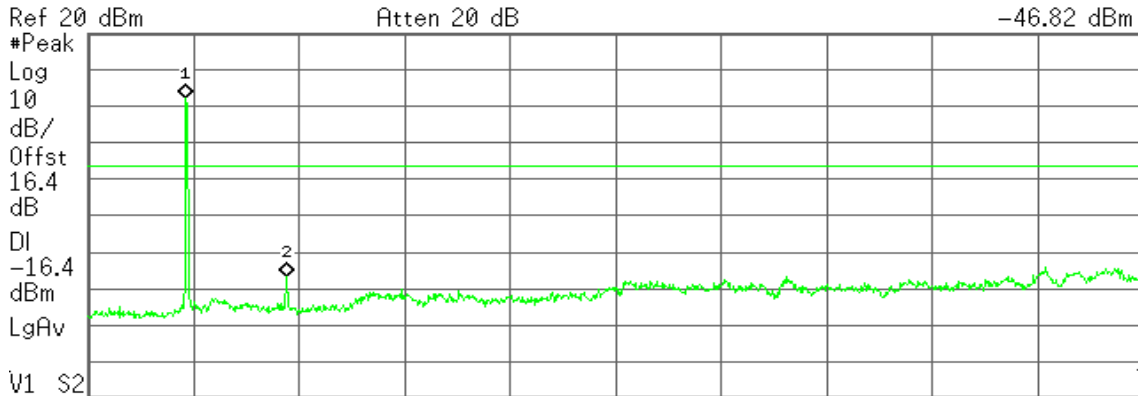

Start 30 MHz Stop 26.00 GHz
#Res BW 100 kHz #VBW 100 kHz Sweep 3.131 s (1001 pts)

Marker	Trace	Type	X Axis	Amplitude
1	(1)	Freq	2.45 GHz	2.31 dBm
2	(1)	Freq	4.91 GHz	-46.82 dBm



IEEE 802.11n HT 20 MHz mode

CH Low

Agilent 21:26:51 Jul 31, 2012

R T

Mkr2 4.83 GHz
-47.80 dBm

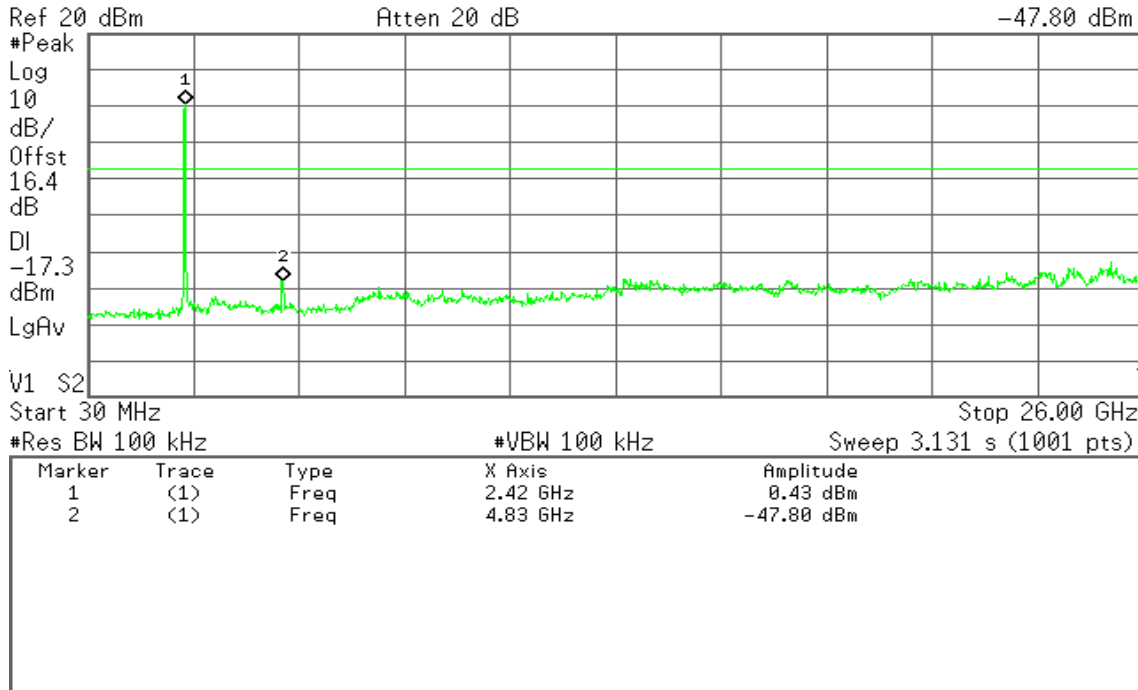

CH Mid

Agilent 21:29:16 Jul 31, 2012

R T

Mkr2 4.89 GHz
-46.99 dBm

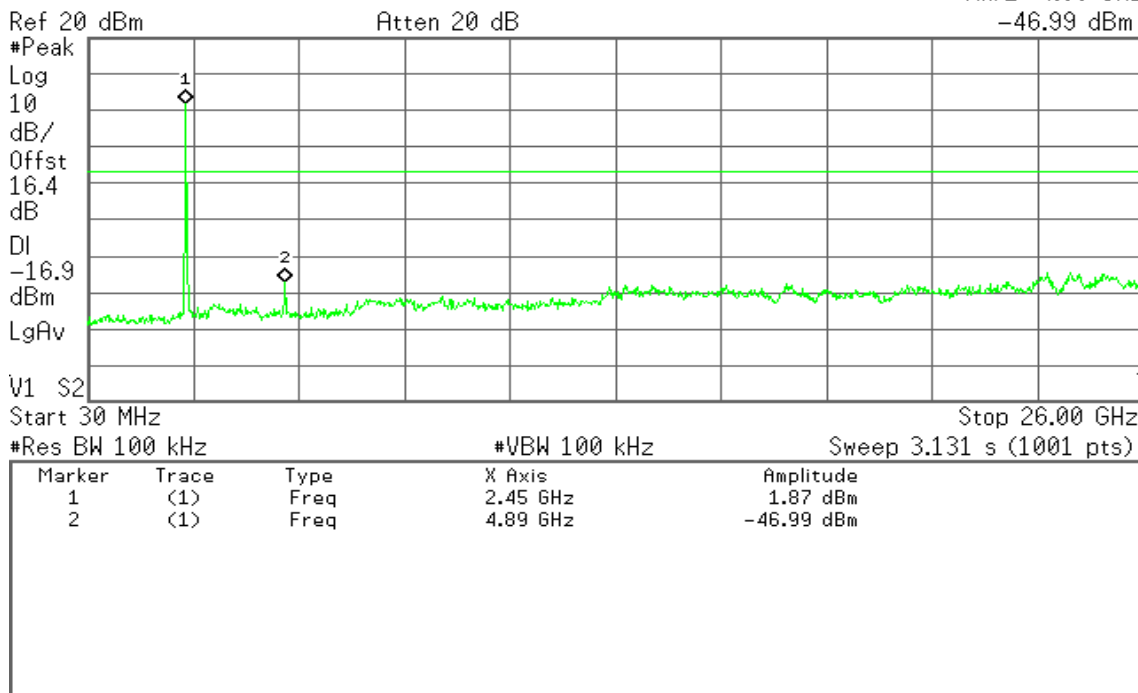



CH High

Agilent 21:31:49 Jul 31, 2012

R T

Mkr2 4.91 GHz
-46.51 dBm

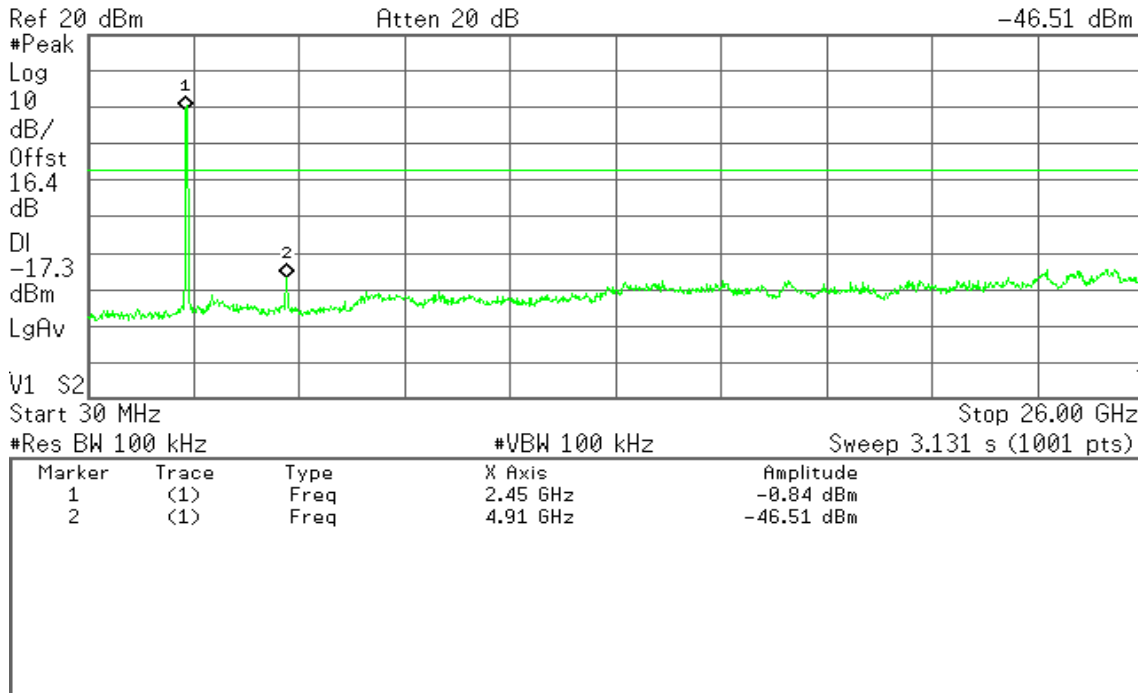

IEEE 802.11n HT 40 MHz mode

CH Low

Agilent 21:34:43 Jul 31, 2012

R T

Mkr2 4.83 GHz
-47.15 dBm

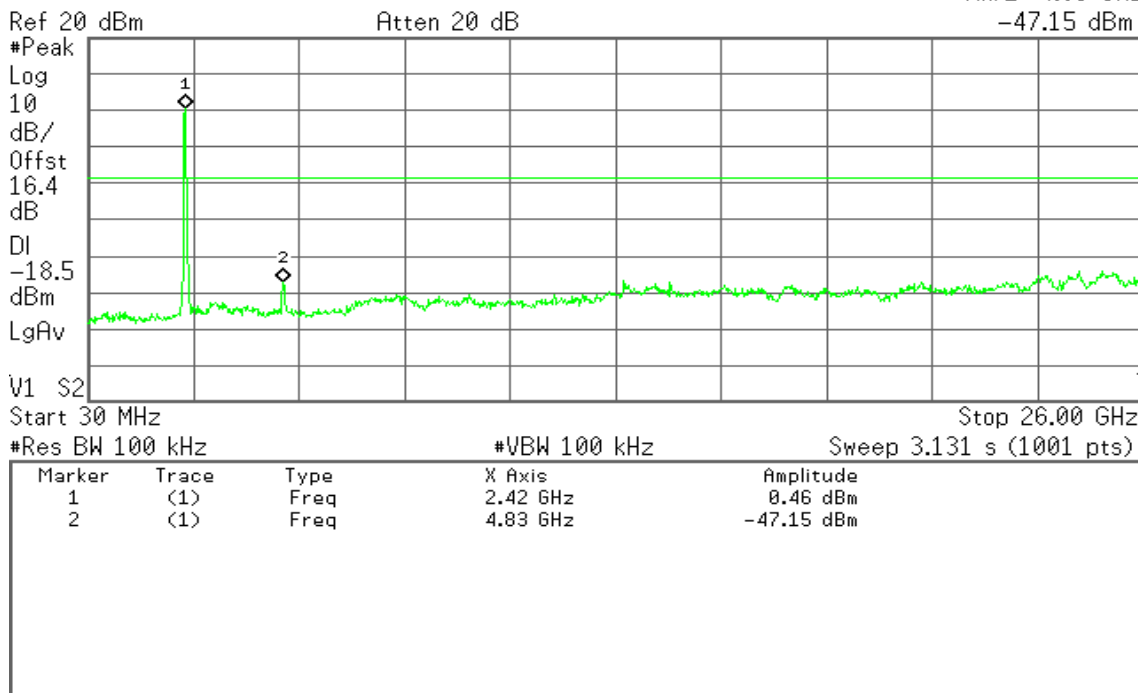



CH Mid

Agilent 21:37:41 Jul 31, 2012

R T

Mkr2 4.89 GHz
-47.80 dBm



Marker	Trace	Type	X Axis	Amplitude
1	(1)	Freq	2.45 GHz	-2.66 dBm
2	(1)	Freq	4.89 GHz	-47.80 dBm

#Res BW 100 kHz #VBW 100 kHz Sweep 3.131 s (1001 pts)

CH High

Agilent 21:40:20 Jul 31, 2012

R T

Mkr2 4.91 GHz
-48.56 dBm

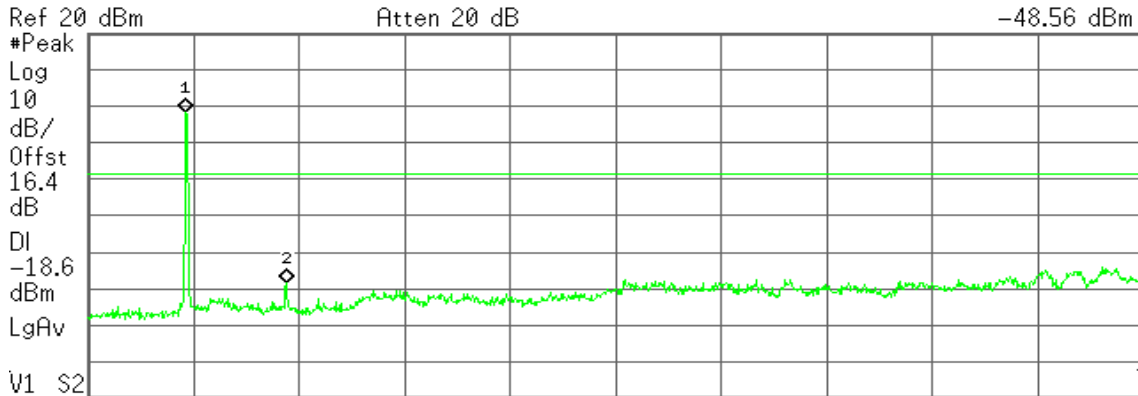

Marker	Trace	Type	X Axis	Amplitude
1	(1)	Freq	2.45 GHz	-1.60 dBm
2	(1)	Freq	4.91 GHz	-48.56 dBm

#Res BW 100 kHz #VBW 100 kHz Sweep 3.131 s (1001 pts)



8.8 RADIATED EMISSIONS

LIMIT

All spurious emissions shall comply with the limits of §15.209(a) and RSS-Gen Table 2 & Table 5.

RSS-Gen Table 2 & Table 5: General Field Strength Limits for Transmitters and Receivers at Frequencies Above 30 MHz ^(Note)

Frequency (MHz)	Field Strength microvolts/m at 3 metres (watts, e.i.r.p.)	
	Transmitters	Receivers
30-88	100 (3 nW)	100 (3 nW)
88-216	150 (6.8 nW)	150 (6.8 nW)
216-960	200 (12 nW)	200 (12 nW)
Above 960	500 (75 nW)	500 (75 nW)

Note: *Measurements for compliance with limits in the above table may be performed at distances other than 3 metres, in accordance with Section 7.2.7.

Transmitting devices are not permitted in Table 1 bands or, unless stated otherwise, in TV bands (54-72 MHz, 76-88 MHz, 174-216 MHz, 470-608 MHz and 614-806 MHz).

RSS-Gen Table 6: General Field Strength Limits for Transmitters at Frequencies Below 30 MHz (Transmit)

Frequency	Field Strength (microvolts/m)	Magnetic H-Field (microamperes/m)	Measurement Distance (metres)
9-490 kHz	2,400/F (F in kHz)	2,400/377F (F in kHz)	3000
490-1,705 kHz	24,000/F (F in kHz)	24,000/377F (F in kHz)	30
1.705-30 MHz	30	N/A	30

Note: The emission limits for the bands 9-90 kHz and 110-490 kHz are based on measurements employing an average detector.



Test Configuration

9kHz ~ 30MHz

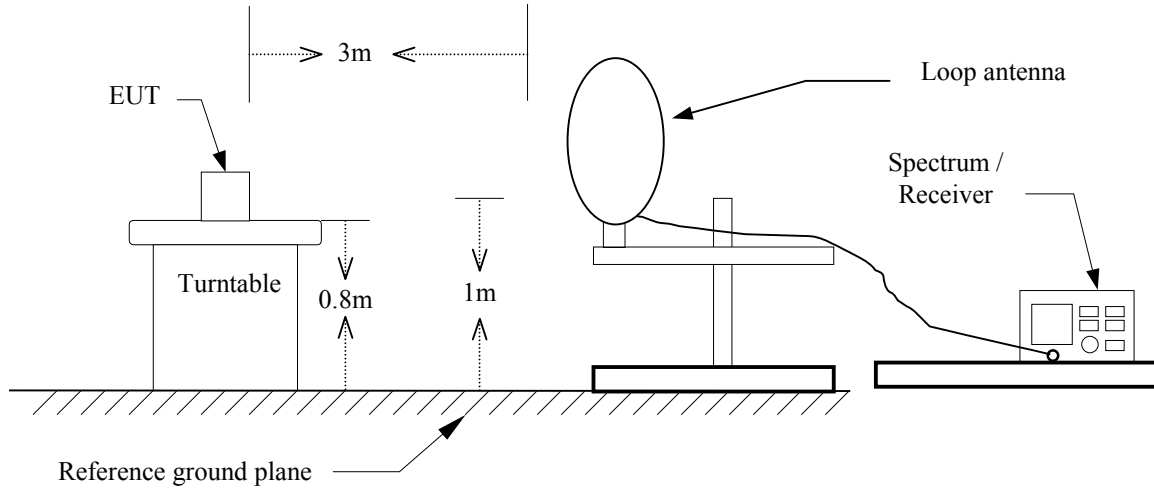

30MHz ~ 1GHz

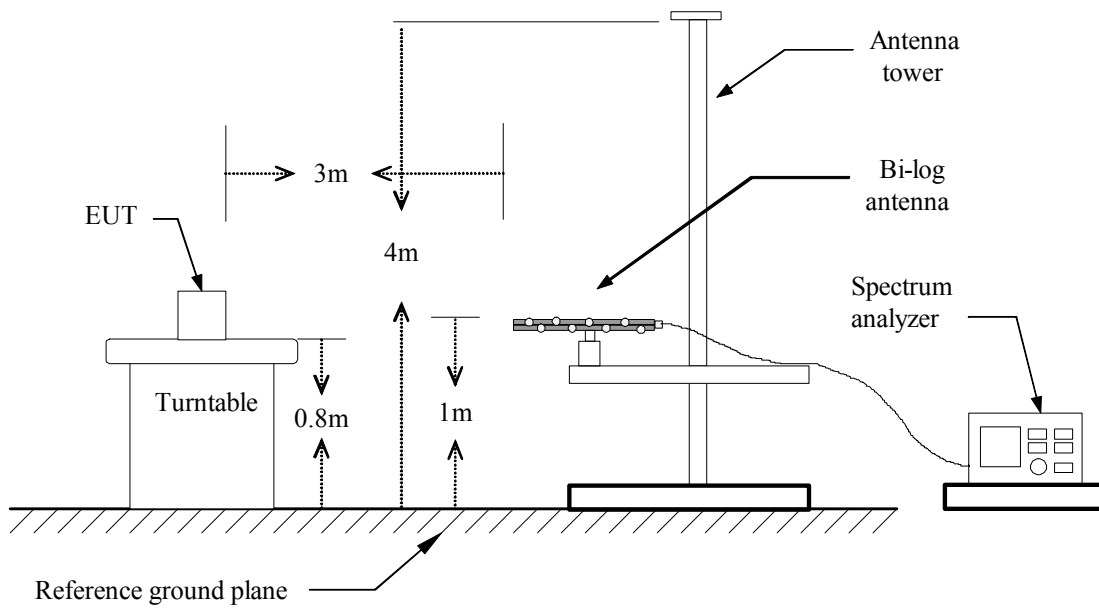



Above 1 GHz

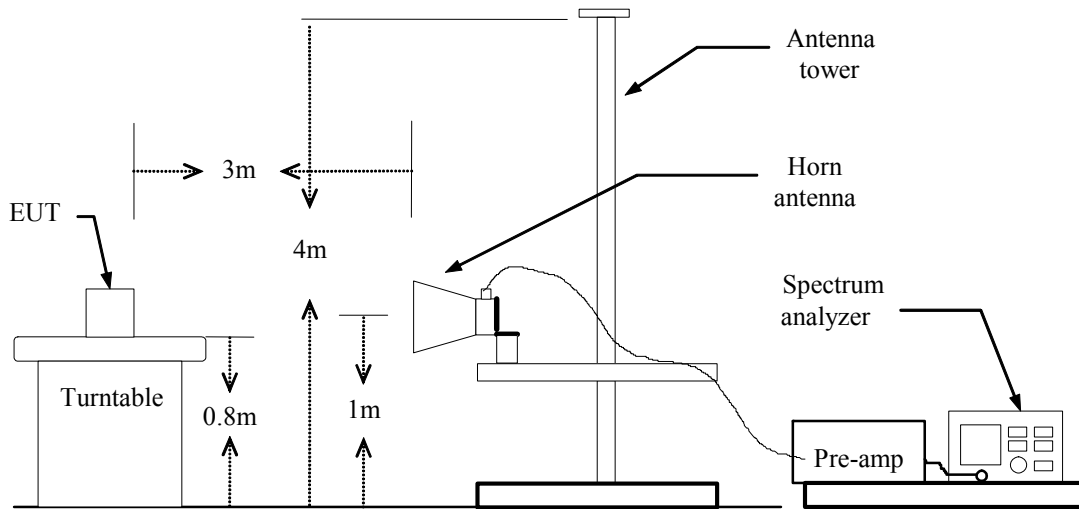



TEST PROCEDURE

1. The EUT is placed on a turntable, which is 0.8m above ground plane.
2. The turntable shall be rotated for 360 degrees to determine the position of maximum emission level.
3. EUT is set 3m away from the receiving antenna, which is varied from 1m to 4m to find out the highest emissions.
4. Maximum procedure was performed on the six highest emissions to ensure EUT compliance.
5. And also, each emission was to be maximized by changing the polarization of receiving antenna both horizontal and vertical.
6. Set the spectrum analyzer in the following setting as:
Below 1GHz:
RBW=100kHz / VBW=300kHz / Sweep=AUTO
Above 1GHz:
(a) PEAK: RBW=1MHz / VBW=3MHz or 1/T/ Sweep=AUTO
(b) AVERAGE: RBW=1MHz / VBW=10Hz / Sweep=AUTO
7. Repeat above procedures until the measurements for all frequencies are complete.

**TEST RESULTS****Below 1GHz****Operation Mode:** Normal Link**Test Date:** June 9, 2012**Temperature:** 26°C**Tested by:** Shawn Wu**Humidity:** 50% RH**Polarity:** Ver. / Hor.

Frequency (MHz)	Reading (dBuV)	Correction Factor (dB/m)	Result (dBuV/m)	Limit (dBuV/m)	Margin (dB)	Remark	Ant. Pol. (H/V)
30.00	46.11	-19.87	26.24	40.00	-13.76	Peak	V
169.03	55.17	-29.18	25.98	43.50	-17.52	Peak	V
190.05	55.20	-28.92	26.28	43.50	-17.22	Peak	V
448.72	46.21	-22.87	23.34	46.00	-22.66	Peak	V
519.85	45.07	-21.98	23.08	46.00	-22.92	Peak	V
780.13	44.25	-17.72	26.52	46.00	-19.48	Peak	V
30.00	42.55	-19.87	22.68	40.00	-17.32	Peak	H
138.32	42.14	-27.96	14.18	43.50	-29.32	Peak	H
451.95	41.79	-22.82	18.97	46.00	-27.03	Peak	H
628.17	41.66	-20.11	21.55	46.00	-24.45	Peak	H
686.37	41.40	-19.12	22.28	46.00	-23.72	Peak	H
780.13	48.44	-17.72	30.71	46.00	-15.29	Peak	H

Remark:

1. No emission found between lowest internal used/generated frequency to 30MHz (9kHz~30MHz)
2. Radiated emissions measured in frequency range from 30 MHz to 1000MHz were made with an instrument using peak/quasi-peak detector mode.
3. Quasi-peak test would be performed if the peak result were greater than the quasi-peak limit or as required by the applicant.
4. Measurements above show only up to 6 maximum emissions noted, or would be lesser, with " N/A " remark, if no specific emissions from the EUT are recorded (ie: margin>20dB from the applicable limit) and considered that's already beyond the background noise floor.
5. Margin (dB) = Result (dBuV/m) – Limit (dBuV/m).



Above 1 GHz

Operation Mode: TX / IEEE 802.11b / CH Low

Test Date: June 8, 2012

Temperature: 26°C

Tested by: Shawn Wu

Humidity: 50 % RH

Polarity: Ver. / Hor.

Frequency (MHz)	Reading (Peak) (dBuV)	Reading (Average) (dBuV)	Correction Factor (dB/m)	Result (Peak) (dBuV/m)	Result (Average) (dBuV/m)	Limit (Peak) (dBuV/m)	Limit (Average) (dBuV/m)	Margin (dB)	Remark	Ant. Pol. (H/V)
2006.67	55.15	---	-5.45	49.69	---	74.00	54.00	-4.31	Peak	V
4841.67	66.98	53.08	0.40	67.38	53.48	74.00	54.00	-0.52	AVG	V
N/A										
1916.67	55.73	---	-6.32	49.42	---	74.00	54.00	-4.58	Peak	H
4841.67	62.60	53.04	0.40	63.00	53.44	74.00	54.00	-0.56	AVG	H
N/A										

Remark:

1. Measuring frequencies from 1 GHz to the 10th harmonic of highest fundamental frequency.
2. Radiated emissions measured in frequency above 1000MHz were made with an instrument using peak/average detector mode.
3. Average test would be performed if the peak result were greater than the average limit or as required by the applicant.
4. Data of measurement within this frequency range shown “ --- ” in the table above means the reading of emissions are attenuated more than 20dB below the permissible limits or the field strength is too small to be measured.
5. Measurements above show only up to 6 maximum emissions noted, or would be lesser, with “ N/A ” remark, if no specific emissions from the EUT are recorded (ie: margin>20dB from the applicable limit) and considered that's already beyond the background noise floor.
6. Margin (dB) = Remark result (dBuV/m) – Average limit (dBuV/m).



Operation Mode: TX / IEEE 802.11b / CH Mid

Test Date: June 8, 2012

Temperature: 26°C

Tested by: Shawn Wu

Humidity: 50 % RH

Polarity: Ver. / Hor.

Frequency (MHz)	Reading (Peak) (dBuV)	Reading (Average) (dBuV)	Correction Factor (dB/m)	Result (Peak) (dBuV/m)	Result (Average) (dBuV/m)	Limit (Peak) (dBuV/m)	Limit (Average) (dBuV/m)	Margin (dB)	Remark	Ant. Pol. (H/V)
2146.67	55.07	---	-5.09	49.98	---	74.00	54.00	-4.02	Peak	V
4883.33	67.23	53.01	0.51	67.73	53.52	74.00	54.00	-0.48	AVG	V
N/A										
2173.33	54.58	---	-5.02	49.56	---	74.00	54.00	-4.44	Peak	H
4883.33	62.00	52.98	0.51	62.51	53.49	74.00	54.00	-0.51	AVG	H
N/A										

Remark:

1. Measuring frequencies from 1 GHz to the 10th harmonic of highest fundamental frequency.
2. Radiated emissions measured in frequency above 1000MHz were made with an instrument using peak/average detector mode.
3. Average test would be performed if the peak result were greater than the average limit or as required by the applicant.
4. Data of measurement within this frequency range shown " --- " in the table above means the reading of emissions are attenuated more than 20dB below the permissible limits or the field strength is too small to be measured.
5. Measurements above show only up to 6 maximum emissions noted, or would be lesser, with " N/A " remark, if no specific emissions from the EUT are recorded (ie: margin > 20dB from the applicable limit) and considered that's already beyond the background noise floor.
6. Margin (dB) = Remark result (dBuV/m) – Average limit (dBuV/m).



Operation Mode: TX / IEEE 802.11b / CH High

Test Date: June 8, 2012

Temperature: 26°C

Tested by: Shawn Wu

Humidity: 50 % RH

Polarity: Ver. / Hor.

Frequency (MHz)	Reading (Peak) (dBuV)	Reading (Average) (dBuV)	Correction Factor (dB/m)	Result (Peak) (dBuV/m)	Result (Average) (dBuV/m)	Limit (Peak) (dBuV/m)	Limit (Average) (dBuV/m)	Margin (dB)	Remark	Ant. Pol. (H/V)
2100.00	55.56	---	-5.21	50.35	---	74.00	54.00	-3.65	Peak	V
4925.00	65.91	52.88	0.61	66.52	53.49	74.00	54.00	-0.51	AVG	V
N/A										
2500.00	56.16	44.75	-3.87	52.29	40.88	74.00	54.00	-13.12	AVG	H
4925.00	62.70	52.85	0.61	63.31	53.46	74.00	54.00	-0.54	AVG	H
N/A										

Remark:

1. Measuring frequencies from 1 GHz to the 10th harmonic of highest fundamental frequency.
2. Radiated emissions measured in frequency above 1000MHz were made with an instrument using peak/average detector mode.
3. Average test would be performed if the peak result were greater than the average limit or as required by the applicant.
4. Data of measurement within this frequency range shown " --- " in the table above means the reading of emissions are attenuated more than 20dB below the permissible limits or the field strength is too small to be measured.
5. Measurements above show only up to 6 maximum emissions noted, or would be lesser, with " N/A " remark, if no specific emissions from the EUT are recorded (ie: margin > 20dB from the applicable limit) and considered that's already beyond the background noise floor.
6. Margin (dB) = Remark result (dBuV/m) – Average limit (dBuV/m).



Operation Mode: TX / IEEE 802.11g / CH Low

Test Date: June 8, 2012

Temperature: 26°C

Tested by: Shawn Wu

Humidity: 50 % RH

Polarity: Ver. / Hor.

Frequency (MHz)	Reading (Peak) (dBuV)	Reading (Average) (dBuV)	Correction Factor (dB/m)	Result (Peak) (dBuV/m)	Result (Average) (dBuV/m)	Limit (Peak) (dBuV/m)	Limit (Average) (dBuV/m)	Margin (dB)	Remark	Ant. Pol. (H/V)
2016.67	55.10	---	-5.43	49.68	---	74.00	54.00	-4.32	Peak	V
4825.00	64.80	50.76	0.36	65.16	51.12	74.00	54.00	-2.88	AVG	V
N/A										
1940.00	55.24	---	-6.08	49.16	---	74.00	54.00	-4.84	Peak	H
4825.00	58.31	46.56	0.36	58.67	46.92	74.00	54.00	-7.08	AVG	H
N/A										

Remark:

1. Measuring frequencies from 1 GHz to the 10th harmonic of highest fundamental frequency.
2. Radiated emissions measured in frequency above 1000MHz were made with an instrument using peak/average detector mode.
3. Average test would be performed if the peak result were greater than the average limit or as required by the applicant.
4. Data of measurement within this frequency range shown " --- " in the table above means the reading of emissions are attenuated more than 20dB below the permissible limits or the field strength is too small to be measured.
5. Measurements above show only up to 6 maximum emissions noted, or would be lesser, with " N/A " remark, if no specific emissions from the EUT are recorded (ie: margin > 20dB from the applicable limit) and considered that's already beyond the background noise floor.
6. Margin (dB) = Remark result (dBuV/m) – Average limit (dBuV/m).



Operation Mode: TX / IEEE 802.11g / CH Mid

Test Date: June 8, 2012

Temperature: 26°C

Tested by: Shawn Wu

Humidity: 50 % RH

Polarity: Ver. / Hor.

Frequency (MHz)	Reading (Peak) (dBuV)	Reading (Average) (dBuV)	Correction Factor (dB/m)	Result (Peak) (dBuV/m)	Result (Average) (dBuV/m)	Limit (Peak) (dBuV/m)	Limit (Average) (dBuV/m)	Margin (dB)	Remark	Ant. Pol. (H/V)
2150.00	54.90	---	-5.08	49.82	---	74.00	54.00	-4.18	Peak	V
4883.33	61.86	49.57	0.51	62.37	50.08	74.00	54.00	-3.92	AVG	V
N/A										
2123.33	54.86	---	-5.15	49.71	---	74.00	54.00	-4.29	Peak	H
4883.33	58.27	45.94	0.51	58.77	46.45	74.00	54.00	-7.55	AVG	H
N/A										

Remark:

1. Measuring frequencies from 1 GHz to the 10th harmonic of highest fundamental frequency.
2. Radiated emissions measured in frequency above 1000MHz were made with an instrument using peak/average detector mode.
3. Average test would be performed if the peak result were greater than the average limit or as required by the applicant.
4. Data of measurement within this frequency range shown " --- " in the table above means the reading of emissions are attenuated more than 20dB below the permissible limits or the field strength is too small to be measured.
5. Measurements above show only up to 6 maximum emissions noted, or would be lesser, with " N/A " remark, if no specific emissions from the EUT are recorded (ie: margin > 20dB from the applicable limit) and considered that's already beyond the background noise floor.
6. Margin (dB) = Remark result (dBuV/m) – Average limit (dBuV/m).



Operation Mode: TX / IEEE 802.11g / CH High

Test Date: June 8, 2012

Temperature: 26°C

Tested by: Shawn Wu

Humidity: 50 % RH

Polarity: Ver. / Hor.

Frequency (MHz)	Reading (Peak) (dBuV)	Reading (Average) (dBuV)	Correction Factor (dB/m)	Result (Peak) (dBuV/m)	Result (Average) (dBuV/m)	Limit (Peak) (dBuV/m)	Limit (Average) (dBuV/m)	Margin (dB)	Remark	Ant. Pol. (H/V)
1950.00	55.29	---	-5.98	49.31	---	74.00	54.00	-4.69	Peak	V
4925.00	60.22	46.87	0.61	60.83	47.48	74.00	54.00	-6.52	AVG	V
N/A										
2113.33	54.70	---	-5.18	49.53	---	74.00	54.00	-4.47	Peak	H
4916.67	57.64	45.45	0.59	58.23	46.04	74.00	54.00	-7.96	AVG	H
N/A										

Remark:

1. Measuring frequencies from 1 GHz to the 10th harmonic of highest fundamental frequency.
2. Radiated emissions measured in frequency above 1000MHz were made with an instrument using peak/average detector mode.
3. Average test would be performed if the peak result were greater than the average limit or as required by the applicant.
4. Data of measurement within this frequency range shown " --- " in the table above means the reading of emissions are attenuated more than 20dB below the permissible limits or the field strength is too small to be measured.
5. Measurements above show only up to 6 maximum emissions noted, or would be lesser, with " N/A " remark, if no specific emissions from the EUT are recorded (ie: margin > 20dB from the applicable limit) and considered that's already beyond the background noise floor.
6. Margin (dB) = Remark result (dBuV/m) – Average limit (dBuV/m).



Operation Mode: TX / IEEE 802.11n HT 20 MHz mode / CH Low Test Date: June 8, 2012

Temperature: 26°C Tested by: Shawn Wu

Humidity: 50 % RH Polarity: Ver. / Hor.

Frequency (MHz)	Reading (Peak) (dBuV)	Reading (Average) (dBuV)	Correction Factor (dB/m)	Result (Peak) (dBuV/m)	Result (Average) (dBuV/m)	Limit (Peak) (dBuV/m)	Limit (Average) (dBuV/m)	Margin (dB)	Remark	Ant. Pol. (H/V)
2143.33	53.88	---	-5.10	48.79	---	74.00	54.00	-5.21	Peak	V
4825.00	61.44	50.89	0.36	61.80	51.25	74.00	54.00	-2.75	AVG	V
N/A										
2256.67	53.93	---	-4.80	49.12	---	74.00	54.00	-4.88	Peak	H
4825.00	58.29	48.21	0.36	58.65	48.57	74.00	54.00	-5.43	AVG	H
N/A										

Remark:

1. Measuring frequencies from 1 GHz to the 10th harmonic of highest fundamental frequency.
2. Radiated emissions measured in frequency above 1000MHz were made with an instrument using peak/average detector mode.
3. Average test would be performed if the peak result were greater than the average limit or as required by the applicant.
4. Data of measurement within this frequency range shown " --- " in the table above means the reading of emissions are attenuated more than 20dB below the permissible limits or the field strength is too small to be measured.
5. Measurements above show only up to 6 maximum emissions noted, or would be lesser, with " N/A " remark, if no specific emissions from the EUT are recorded (ie: margin > 20dB from the applicable limit) and considered that's already beyond the background noise floor.
6. Margin (dB) = Remark result (dBuV/m) – Average limit (dBuV/m).



Operation Mode: TX / IEEE 802.11n HT 20 MHz mode / CH Mid Test Date: June 8, 2012

Temperature: 26°C Tested by: Shawn Wu

Humidity: 50 % RH Polarity: Ver. / Hor.

Frequency (MHz)	Reading (Peak) (dBuV)	Reading (Average) (dBuV)	Correction Factor (dB/m)	Result (Peak) (dBuV/m)	Result (Average) (dBuV/m)	Limit (Peak) (dBuV/m)	Limit (Average) (dBuV/m)	Margin (dB)	Remark	Ant. Pol. (H/V)
2230.00	55.22	---	-4.87	50.35	---	74.00	54.00	-3.65	Peak	V
4883.33	61.50	48.89	0.51	62.00	49.40	74.00	54.00	-4.60	AVG	V
N/A										
2023.33	54.90	---	-5.41	49.49	---	74.00	54.00	-4.51	Peak	H
4891.67	57.01	45.43	0.53	57.54	45.96	74.00	54.00	-8.04	AVG	H
N/A										

Remark:

1. Measuring frequencies from 1 GHz to the 10th harmonic of highest fundamental frequency.
2. Radiated emissions measured in frequency above 1000MHz were made with an instrument using peak/average detector mode.
3. Average test would be performed if the peak result were greater than the average limit or as required by the applicant.
4. Data of measurement within this frequency range shown " --- " in the table above means the reading of emissions are attenuated more than 20dB below the permissible limits or the field strength is too small to be measured.
5. Measurements above show only up to 6 maximum emissions noted, or would be lesser, with " N/A " remark, if no specific emissions from the EUT are recorded (ie: margin > 20dB from the applicable limit) and considered that's already beyond the background noise floor.
6. Margin (dB) = Remark result (dBuV/m) – Average limit (dBuV/m).



Operation Mode: TX / IEEE 802.11n HT 20 MHz mode / CH High Test Date: June 8, 2012

Temperature: 26°C

Tested by: Shawn Wu

Humidity: 50 % RH

Polarity: Ver. / Hor.

Frequency (MHz)	Reading (Peak) (dBuV)	Reading (Average) (dBuV)	Correction Factor (dB/m)	Result (Peak) (dBuV/m)	Result (Average) (dBuV/m)	Limit (Peak) (dBuV/m)	Limit (Average) (dBuV/m)	Margin (dB)	Remark	Ant. Pol. (H/V)
2550.00	55.46	---	-3.70	51.76	---	74.00	54.00	-2.24	Peak	V
4925.00	61.31	48.33	0.61	61.93	48.94	74.00	54.00	-5.06	AVG	V
N/A										
1943.33	55.15	---	-6.05	49.11	---	74.00	54.00	-4.89	Peak	H
4925.00	57.90	44.83	0.61	58.51	45.44	74.00	54.00	-8.56	AVG	H
N/A										

Remark:

1. Measuring frequencies from 1 GHz to the 10th harmonic of highest fundamental frequency.
2. Radiated emissions measured in frequency above 1000MHz were made with an instrument using peak/average detector mode.
3. Average test would be performed if the peak result were greater than the average limit or as required by the applicant.
4. Data of measurement within this frequency range shown " --- " in the table above means the reading of emissions are attenuated more than 20dB below the permissible limits or the field strength is too small to be measured.
5. Measurements above show only up to 6 maximum emissions noted, or would be lesser, with " N/A " remark, if no specific emissions from the EUT are recorded (ie: margin > 20dB from the applicable limit) and considered that's already beyond the background noise floor.
6. Margin (dB) = Remark result (dBuV/m) – Average limit (dBuV/m).



Operation Mode: TX / IEEE 802.11n HT 40 MHz mode
/ CH Low

Test Date: June 8, 2012

Temperature: 26°C

Tested by: Shawn Wu

Humidity: 50 % RH

Polarity: Ver. / Hor.

Frequency (MHz)	Reading (Peak) (dBuV)	Reading (Average) (dBuV)	Correction Factor (dB/m)	Result (Peak) (dBuV/m)	Result (Average) (dBuV/m)	Limit (Peak) (dBuV/m)	Limit (Average) (dBuV/m)	Margin (dB)	Remark	Ant. Pol. (H/V)
2073.33	54.48	---	-5.28	49.20	---	74.00	54.00	-4.80	Peak	V
4858.33	58.68	45.95	0.44	59.12	46.39	74.00	54.00	-7.61	AVG	V
N/A										
2146.67	54.62	---	-5.09	49.53	---	74.00	54.00	-4.47	Peak	H
4841.67	54.19	42.85	0.40	54.60	43.25	74.00	54.00	-10.75	AVG	H
N/A										

Remark:

1. Measuring frequencies from 1 GHz to the 10th harmonic of highest fundamental frequency.
2. Radiated emissions measured in frequency above 1000MHz were made with an instrument using peak/average detector mode.
3. Average test would be performed if the peak result were greater than the average limit or as required by the applicant.
4. Data of measurement within this frequency range shown " --- " in the table above means the reading of emissions are attenuated more than 20dB below the permissible limits or the field strength is too small to be measured.
5. Measurements above show only up to 6 maximum emissions noted, or would be lesser, with " N/A " remark, if no specific emissions from the EUT are recorded (ie: margin > 20dB from the applicable limit) and considered that's already beyond the background noise floor.
6. Margin (dB) = Remark result (dBuV/m) – Average limit (dBuV/m).



Operation Mode: TX / IEEE 802.11n HT 40 MHz mode
/ CH Mid

Test Date: June 8, 2012

Temperature: 26°C

Tested by: Shawn Wu

Humidity: 50 % RH

Polarity: Ver. / Hor.

Frequency (MHz)	Reading (Peak) (dBuV)	Reading (Average) (dBuV)	Correction Factor (dB/m)	Result (Peak) (dBuV/m)	Result (Average) (dBuV/m)	Limit (Peak) (dBuV/m)	Limit (Average) (dBuV/m)	Margin (dB)	Remark	Ant. Pol. (H/V)
2103.33	55.30	---	-5.20	50.10	---	74.00	54.00	-3.90	Peak	V
4883.33	59.84	45.70	0.51	60.35	46.21	74.00	54.00	-7.79	AVG	V
N/A										
2136.67	55.54	---	-5.11	50.43	---	74.00	54.00	-3.57	Peak	H
4875.00	54.81	43.53	0.49	55.30	44.02	74.00	54.00	-9.98	AVG	H
N/A										

Remark:

1. Measuring frequencies from 1 GHz to the 10th harmonic of highest fundamental frequency.
2. Radiated emissions measured in frequency above 1000MHz were made with an instrument using peak/average detector mode.
3. Average test would be performed if the peak result were greater than the average limit or as required by the applicant.
4. Data of measurement within this frequency range shown " --- " in the table above means the reading of emissions are attenuated more than 20dB below the permissible limits or the field strength is too small to be measured.
5. Measurements above show only up to 6 maximum emissions noted, or would be lesser, with " N/A " remark, if no specific emissions from the EUT are recorded (ie: margin > 20dB from the applicable limit) and considered that's already beyond the background noise floor.
6. Margin (dB) = Remark result (dBuV/m) – Average limit (dBuV/m).



Operation Mode: TX / IEEE 802.11n HT 40 MHz mode
/ CH High

Test Date: June 8, 2012

Temperature: 26°C

Tested by: Shawn Wu

Humidity: 50 % RH

Polarity: Ver. / Hor.

Frequency (MHz)	Reading (Peak) (dBuV)	Reading (Average) (dBuV)	Correction Factor (dB/m)	Result (Peak) (dBuV/m)	Result (Average) (dBuV/m)	Limit (Peak) (dBuV/m)	Limit (Average) (dBuV/m)	Margin (dB)	Remark	Ant. Pol. (H/V)
2066.67	55.15	---	-5.30	49.86	---	74.00	54.00	-4.14	Peak	V
4900.00	57.84	44.83	0.55	58.39	45.38	74.00	54.00	-8.62	AVG	V
N/A										
2133.33	54.66	---	-5.12	49.54	---	74.00	54.00	-4.46	Peak	H
4900.00	53.75	43.02	0.55	54.30	43.57	74.00	54.00	-10.43	AVG	H
N/A										

Remark:

1. Measuring frequencies from 1 GHz to the 10th harmonic of highest fundamental frequency.
2. Radiated emissions measured in frequency above 1000MHz were made with an instrument using peak/average detector mode.
3. Average test would be performed if the peak result were greater than the average limit or as required by the applicant.
4. Data of measurement within this frequency range shown " --- " in the table above means the reading of emissions are attenuated more than 20dB below the permissible limits or the field strength is too small to be measured.
5. Measurements above show only up to 6 maximum emissions noted, or would be lesser, with " N/A " remark, if no specific emissions from the EUT are recorded (ie: margin > 20dB from the applicable limit) and considered that's already beyond the background noise floor.
6. Margin (dB) = Remark result (dBuV/m) – Average limit (dBuV/m).



8.9 POWERLINE CONDUCTED EMISSIONS

LIMIT

According to §15.207(a) & RSS-Gen §7.2.4, except as shown in paragraphs (b) and (c) of this section, for an intentional radiator that is designed to be connected to the public utility (AC) power line, the radio frequency voltage that is conducted back onto the AC power line on any frequency or frequencies within the band 150 kHz to 30 MHz shall not exceed the limits in the following table, as measured using a 50 μ H/50 ohms line impedance stabilization network (LISN). Compliance with the provisions of this paragraph shall be based on the measurement of the radio frequency voltage between each power line and ground at the power terminal. The lower limit applies at the boundary between the frequency ranges.

Frequency Range (MHz)	Limits (dB μ V)	
	Quasi-peak	Average
0.15 to 0.50	66 to 56*	56 to 46*
0.50 to 5	56	46
5 to 30	60	50

* Decreases with the logarithm of the frequency.

Test Configuration

See test photographs attached in Appendix II for the actual connections between EUT and support equipment.

TEST PROCEDURE

1. The EUT was placed on a table, which is 0.8m above ground plane.
2. Maximum procedure was performed on the six highest emissions to ensure EUT compliance.
3. Repeat above procedures until all frequency measured were complete.



TEST RESULTS

The initial step in collecting conducted data is a spectrum analyzer peak scan of the measurement range. Significant peaks are then marked as shown on the following data page, and these signals are then quasi-peaked.

Test Data

Operation Mode: Normal Link **Test Date:** June 14, 2012
Temperature: 24°C **Tested by:** Stan Lin
Humidity: 50% RH

Freq. (MHz)	QP Reading (dBuV)	AV Reading (dBuV)	Corr. factor (dB/m)	QP Result (dBuV/m)	AV Result (dBuV/m)	QP Limit (dBuV)	AV Limit (dBuV)	QP Margin (dB)	AV Margin (dB)	Note
0.4735	25.62	14.08	9.66	35.28	23.74	56.45	46.45	-21.17	-22.71	L1
0.6122	33.13	19.90	9.67	42.80	29.57	56.00	46.00	-13.20	-16.43	L1
0.7205	32.55	19.06	9.68	42.23	28.74	56.00	46.00	-13.77	-17.26	L1
0.9643	28.23	9.26	9.69	37.92	18.95	56.00	46.00	-18.08	-27.05	L1
1.4730	29.33	11.54	9.70	39.03	21.24	56.00	46.00	-16.97	-24.76	L1
2.2729	25.96	8.90	9.74	35.70	18.64	56.00	46.00	-20.30	-27.36	L1
0.5754	32.92	19.18	9.68	42.60	28.86	56.00	46.00	-13.40	-17.14	L2
0.6126	33.26	20.22	9.68	42.94	29.90	56.00	46.00	-13.06	-16.10	L2
0.7238	32.25	19.77	9.69	41.94	29.46	56.00	46.00	-14.06	-16.54	L2
0.9770	32.81	19.64	9.70	42.51	29.34	56.00	46.00	-13.49	-16.66	L2
1.4364	29.59	11.33	9.71	39.30	21.04	56.00	46.00	-16.70	-24.96	L2
1.8366	30.52	14.40	9.73	40.25	24.13	56.00	46.00	-15.75	-21.87	L2

Remark:

1. Measuring frequencies from 0.15 MHz to 30MHz.
2. The emissions measured in frequency range from 0.15 MHz to 30MHz were made with an instrument using Quasi-peak detector and average detector.
3. The IF bandwidth of SPA between 0.15MHz and 30MHz was 10 kHz; the IF bandwidth of Test Receiver between 0.15MHz and 30MHz was 9 kHz;
4. L1 = Line One (Live Line) / L2 = Line Two (Neutral Line)



Test Plots

Conducted emissions (Line 1)

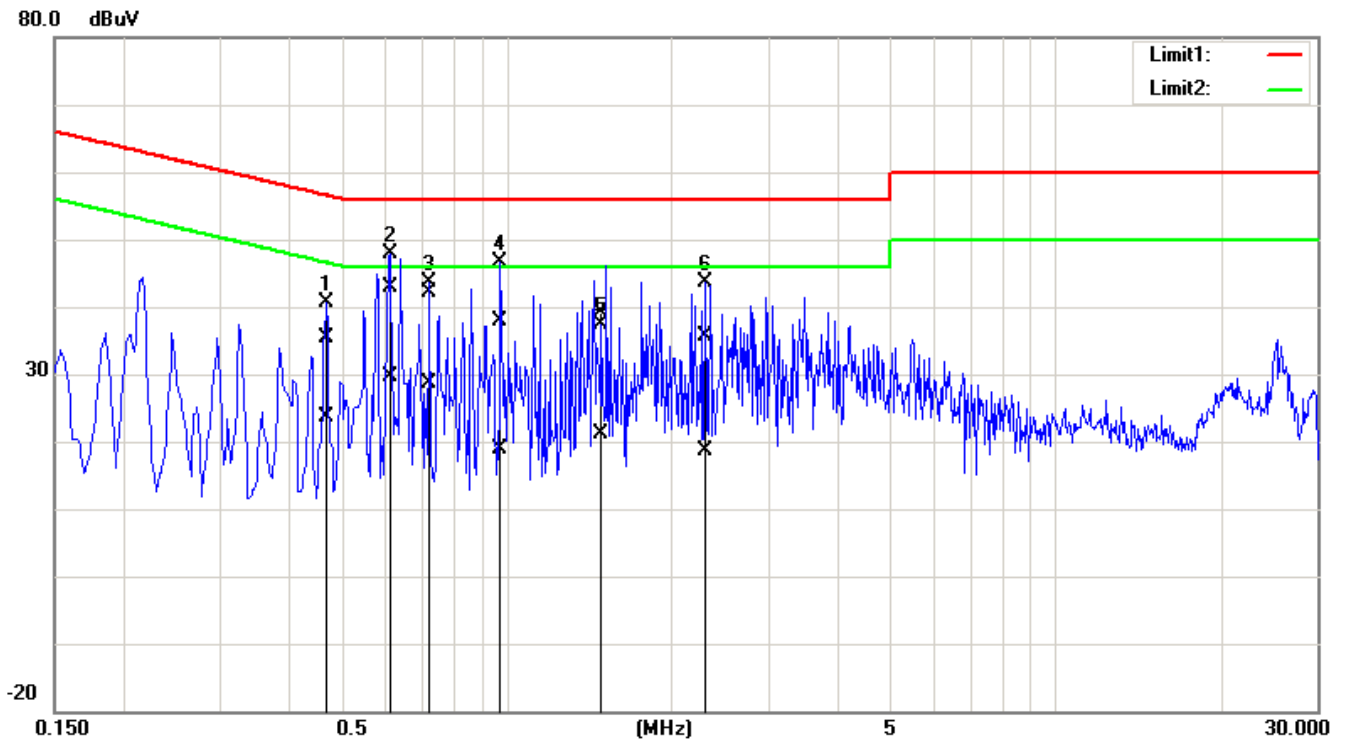

Conducted emissions (Line 2)

