

Variant FCC RF Test Report

APPLICANT : Lenovo (Shanghai) Electronics
Technology Co., Ltd.
EQUIPMENT : Tablet PC IdeaTab A1000-F
BRAND NAME : lenovo
MODEL NAME : 60027
MARKETING NAME : IdeaTab A1000-F
FCC ID : O57A1000F
STANDARD : FCC Part 15 Subpart C §15.247
CLASSIFICATION : (DSS) Spread Spectrum Transmitter

This is a variant report which is only valid together with the original test report. The product was received on May 03, 2013 and completely tested on May 29, 2013. We, SPORTON INTERNATIONAL (SHENZHEN) INC., would like to declare that the tested sample has been evaluated in accordance with the procedures and shown the compliance with the applicable technical standards.

The test results in this report apply exclusively to the tested model / sample. Without written approval of SPORTON INTERNATIONAL(SHENZHEN) INC., the test report shall not be reproduced except in full.



Reviewed by: Joseph Lin / Supervisor

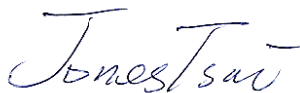

Approved by: Jones Tsai / Manager



SPORTON INTERNATIONAL (SHENZHEN) INC.

No. 3 Building, the third floor of south, Shahe River west, Fengzeyuan warehouse, Nanshan District,
Shenzhen, Guangdong, P.R.C.



TABLE OF CONTENTS

REVISION HISTORY	3
SUMMARY OF TEST RESULT	4
1 GENERAL DESCRIPTION	5
1.1 Applicant.....	5
1.2 Manufacturer.....	5
1.3 Feature of Equipment Under Test	5
1.4 Product Specification of Equipment Under Test.....	5
1.5 Modification of EUT	6
1.6 Testing Site.....	6
1.7 Applied Standards	6
2 TEST CONFIGURATION OF EQUIPMENT UNDER TEST	7
2.1 Descriptions of Test Mode.....	7
2.2 Test Mode.....	8
2.3 Connection Diagram of Test System.....	9
2.4 Support Unit used in test configuration and system	10
2.5 Description of RF Function Operation Test Setup.....	10
2.6 Measurement Results Explanation Example.....	11
3 TEST RESULT	12
3.1 Peak Output Power Measurement	12
3.2 Radiated Band Edges and Spurious Emission Measurement	19
3.3 Antenna Requirements.....	28
4 LIST OF MEASURING EQUIPMENT	29
5 UNCERTAINTY OF EVALUATION	30
APPENDIX A. PHOTOGRAPHS OF EUT	
APPENDIX B. SETUP PHOTOGRAPHS	
APPENDIX C. PRODUCT EQUALITY DECLARATION	



SUMMARY OF TEST RESULT

Report Section	FCC Rule	Description	Limit	Result	Remark
3.1	15.247(b)(1)	Peak Output Power	≤ 1 W for 1Mbps ≤ 125 mW for 2, 3Mbps	Pass	-
3.2	15.247(d)	Radiated Band Edges and Radiated Spurious Emission	15.209(a) & 15.247(d)	Pass	Under limit 6.07 dB at 2483.500 MHz
3.3	15.203 & 15.247(b)	Antenna Requirement	N/A	Pass	-

1 General Description

1.1 Applicant

Lenovo (Shanghai) Electronics Technology Co., Ltd.

No. 68 Building, 199 Fenju Road, Wai Gao Qiao FTZ, Shanghai, China

1.2 Manufacturer

Lenovo PC HK Limited

23/F, Lincoln House, Taikoo Place 979 King's Road, Quarry Bay, Hong Kong

1.3 Feature of Equipment Under Test

Product Feature	
Equipment	Tablet PC IdeaTab A1000-F
Brand Name	lenovo
Model Name	60027
Marketing Name	IdeaTab A1000-F
FCC ID	O57A1000F
EUT supports Radios application	WLAN 11bgn / Bluetooth 2.1/3.0/4.0
HW Version	A3000_MB_PCB_V3.0
SW Version	A1000T_A412_01_07_130118_CN
EUT Stage	Identical Prototype

Remark: The above EUT's information was declared by manufacturer. Please refer to the specifications or user's manual for more detailed description.

1.4 Product Specification of Equipment Under Test

Product Specification subjective to this standard	
Tx/Rx Frequency Range	2402 MHz ~ 2480 MHz
Number of Channels	79
Carrier Frequency of Each Channel	2402+n*1 MHz; n=0~78
Maximum Output Power to Antenna	Bluetooth BR(1Mbps) : 7.79 dBm (0.00601 W) Bluetooth EDR (2Mbps) : 7.40 dBm (0.00550 W) Bluetooth EDR (3Mbps) : 7.64 dBm (0.00581 W)
Antenna Type	PIFA Antenna type with gain 1 dBi
Type of Modulation	Bluetooth 2.1 BR (1Mbps) : GFSK Bluetooth 2.1 EDR (2Mbps) : $\pi/4$ -DQPSK Bluetooth 2.1 EDR (3Mbps) : 8-DPSK Bluetooth 3.0 BR (1Mbps) : GFSK Bluetooth 3.0 EDR (2Mbps) : $\pi/4$ -DQPSK Bluetooth 3.0 EDR (3Mbps) : 8-DPSK



1.5 Modification of EUT

No modifications are made to the EUT during all test items.

1.6 Testing Site

Test Site	SPORTON INTERNATIONAL (SHENZHEN) INC.		
Test Site Location	No. 3 Building, the third floor of south, Shahe River west, Fengzeyuan warehouse, Nanshan District, Shenzhen, Guangdong, P.R.C. TEL: +86-755- 3320-2398		
Test Site No.	Sporton Site No.		FCC/IC Registration No.
	TH01-SZ	03CH01-SZ	831040/4086F-1

Note: The test site complies with ANSI C63.4 2003 requirement.

1.7 Applied Standards

According to the specifications of the manufacturer, the EUT must comply with the requirements of the following standards:

- ♦ FCC Part 15 Subpart C §15.247
- ♦ FCC Public Notice DA 00-705
- ♦ ANSI C63.10-2009

Remark:

1. All test items were verified and recorded according to the standards and without any deviation during the test.
2. This EUT has also been tested and complied with the requirements of FCC Part 15, Subpart B, recorded in a separate test report.

2 Test Configuration of Equipment Under Test

2.1 Descriptions of Test Mode

Preliminary tests were performed in different data rates and recorded the RF output power in the following table:

Channel	Frequency	Bluetooth RF Output Power		
		Data Rate / Modulation		
		GFSK	$\pi/4$ -DQPSK	8-DPSK
		1Mbps	2Mbps	3Mbps
Ch00	2402MHz	7.47 dBm	7.22 dBm	7.37 dBm
Ch39	2441MHz	7.79 dBm	7.40 dBm	7.64 dBm
Ch78	2480MHz	6.38 dBm	6.01 dBm	6.26 dBm

Remark:

1. All the test data for each data rate were verified, but only the worst case was reported.
 2. The data rate was set in 1Mbps for all the test items due to the highest RF output power.
- a. The EUT has been associated with peripherals pursuant to ANSI C63.10-2009 and configuration operated in a manner tended to maximize its emission characteristics in a typical application. Frequency range investigated: radiation (9 KHz to the 10th harmonic of the highest fundamental frequency or to 40 GHz, whichever is lower). Pre-scanned tests, X, Y, Z in three orthogonal panels, and different data rates were conducted to determine the final configuration (X plane as worst plane) from all possible combinations, and the worst mode of radiated spurious emissions is Bluetooth 3Mbps mode, and recorded in this report.

2.2 Test Mode

The following summary table is showing all test modes to demonstrate in compliance with the standard.

Summary table of Test Cases			
Test Item	Data Rate / Modulation		
	Bluetooth BR 1Mbps GFSK	Bluetooth EDR 2Mbps $\pi/4$ -DQPSK	Bluetooth EDR 3Mbps 8-DPSK
Conducted Test Cases	Mode 1: CH00_2402 MHz	Mode 4: CH00_2402 MHz	Mode 7: CH00_2402 MHz
	Mode 2: CH39_2441 MHz	Mode 5: CH39_2441 MHz	Mode 8: CH39_2441 MHz
	Mode 3: CH78_2480 MHz	Mode 6: CH78_2480 MHz	Mode 9: CH78_2480 MHz
Radiated Test Cases	Bluetooth BR 1Mbps GFSK		
	Mode 1: CH78_2480 MHz		
Remark: 1. For radiated test cases, the worst mode data rate 1Mbps was reported only, because this data rate has the highest RF output power at preliminary tests, and the conducted spurious emissions and conducted band edge measurement for each data rate are no worse than 1Mbps, and no other significantly frequencies found in conducted spurious emission .			

2.3 Connection Diagram of Test System

<Bluetooth Tx Mode>

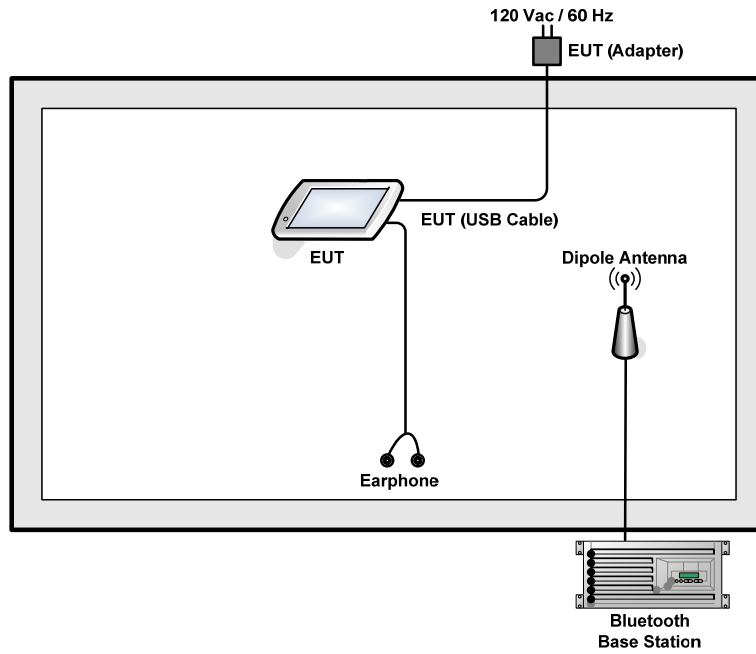



2.4 Support Unit used in test configuration and system

Item	Equipment	Trade Name	Model Name	FCC ID	Data Cable	Power Cord
1.	Bluetooth Base Station	ANRITSU	MT8852B	N/A	N/A	Unshielded, 1.8 m
2.	DC Power Supply	GWINSTEK	GPS-3030D	N/A	N/A	Unshielded, 1.8 m

2.5 Description of RF Function Operation Test Setup

For Bluetooth function, the engineering test program was provided and enabled to make EUT connect with Bluetooth base station to continuous transmit/receive.



2.6 Measurement Results Explanation Example

For all conducted test items:

The offset level is set in the spectrum analyzer to compensate the RF cable loss and attenuator factor between EUT conducted output port and spectrum analyzer. With the offset compensation, the spectrum analyzer reading level is exactly the EUT RF output level.

Example :

$$\begin{aligned} \text{Offset(dB)} &= \text{RF cable loss(dB)} + \text{attenuator factor(dB)}. \\ &= 4.2 + 10 = 14.2 \text{ (dB)} \end{aligned}$$

The spectrum analyzer offset is derived from RF cable loss and attenuator factor.

$$\text{Offset} = \text{RF cable loss} + \text{attenuator factor}.$$

Following shows an offset computation example with cable loss 4.2 dB and 10dB attenuator.

3 Test Result

3.1 Peak Output Power Measurement

3.1.1 Limit of Peak Output Power

Section 15.247 (b) The maximum peak conducted output power of the intentional radiator shall not exceed the following: (1) For frequency hopping systems operating in the 2400-2483.5 MHz band employing at least 75 non-overlapping hopping channels, and all frequency hopping systems in the 5725-5850 MHz band: 1 watt. For all other frequency hopping systems in the 2400-2483.5 MHz band 0.125 watts. The power limit for 1Mbps is 1watt, and for 2Mbps, 3Mbps and AFH are 0.125 watts.

3.1.2 Measuring Instruments

See list of measuring instruments of this test report.

3.1.3 Test Procedures

1. The testing follows FCC Public Notice DA 00-705 Measurement Guidelines.
1. The RF output of EUT was connected to the spectrum analyzer by RF cable and attenuator. The path loss was compensated to the results for each measurement.
2. Set to the maximum power setting and enable the EUT transmit continuously.
3. Measure the conducted output power with cable loss and record the results in the test report.
4. Measure and record the results in the test report.

3.1.4 Test Setup

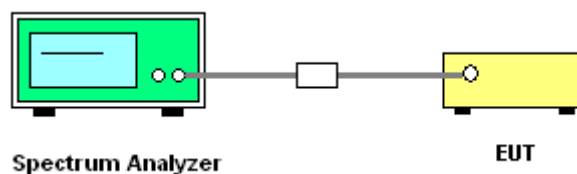



3.1.5 Test Result of Peak Output Power

Test Mode :	1Mbps	Temperature :	24~26°C
Test Engineer :	Fly Chen	Relative Humidity :	50~53%

Channel	Frequency (MHz)	RF Power (dBm)		
		GFSK	Max. Limits (dBm)	Pass/Fail
		1 Mbps		
00	2402	7.47	30.00	Pass
39	2441	7.79	30.00	Pass
78	2480	6.38	30.00	Pass

Peak Output Power Plot on Channel 00

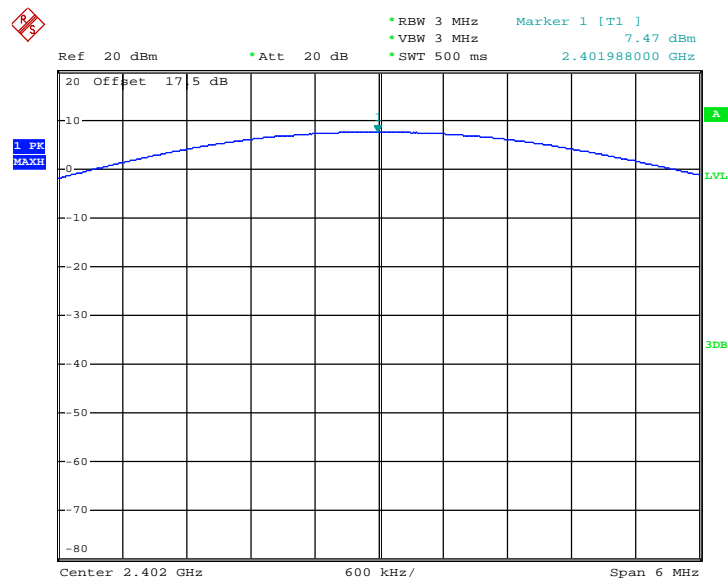

Date: 9.MAY.2013 21:29:25



Peak Output Power Plot on Channel 39

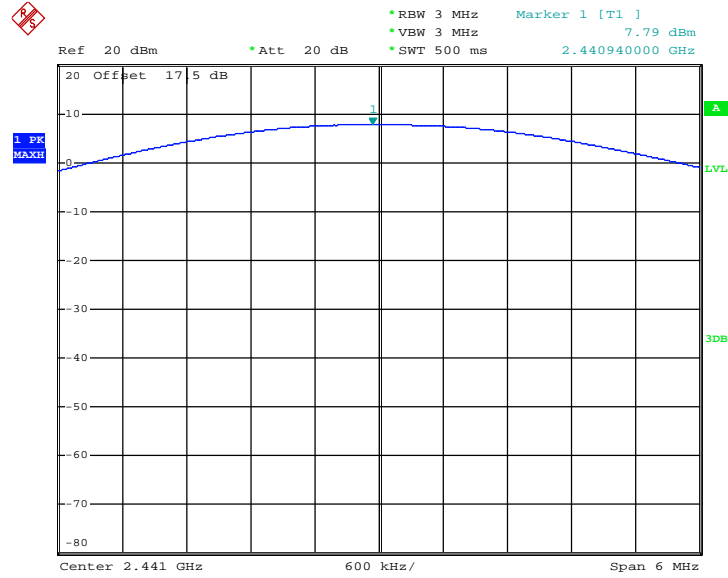

Date: 9.MAY.2013 21:26:55

Peak Output Power Plot on Channel 78

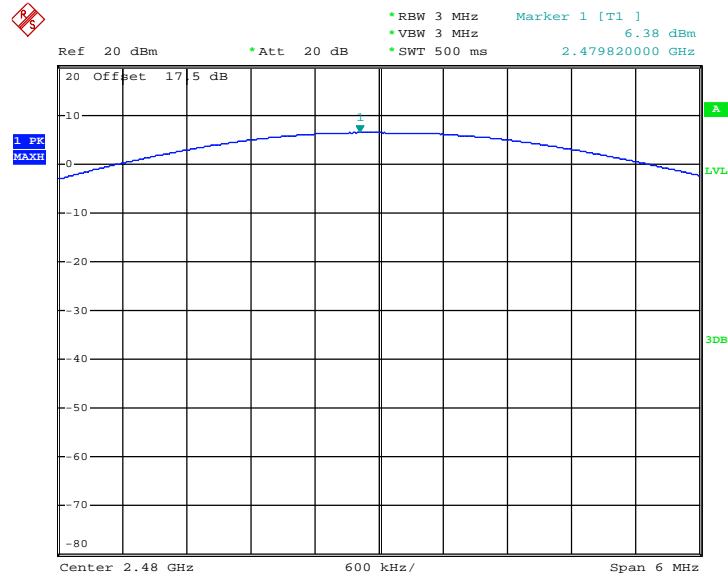

Date: 9.MAY.2013 21:32:46



Test Mode :	2Mbps	Temperature :	24~26°C
Test Engineer :	Fly Chen	Relative Humidity :	50~53%

Channel	Frequency (MHz)	RF Power (dBm)		
		$\pi/4$ -DQPSK	Max. Limits (dBm)	Pass/Fail
		2 Mbps		
00	2402	7.22	20.97	Pass
39	2441	7.40	20.97	Pass
78	2480	6.01	20.97	Pass

Peak Output Power Plot on Channel 00

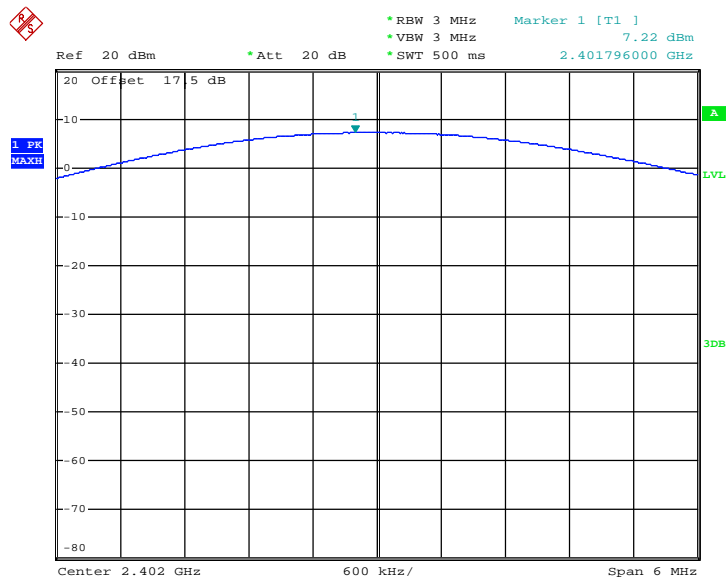

Date: 9.MAY.2013 21:36:01



Peak Output Power Plot on Channel 39

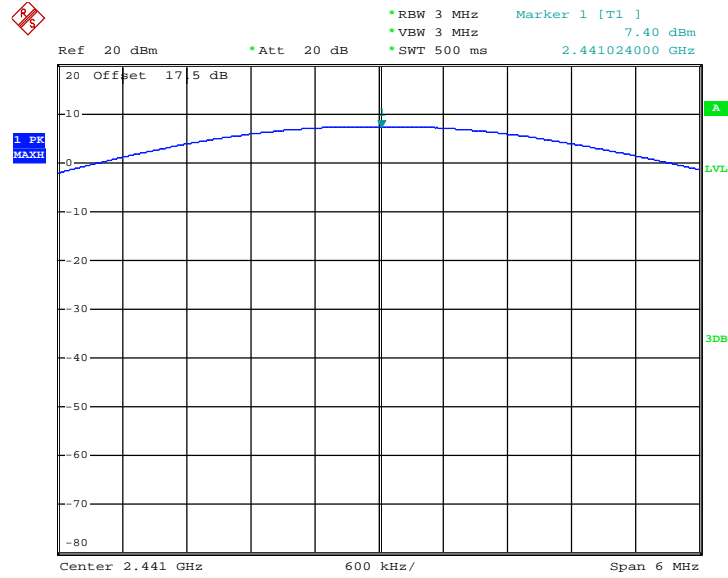

Date: 9.MAY.2013 21:43:51

Peak Output Power Plot on Channel 78

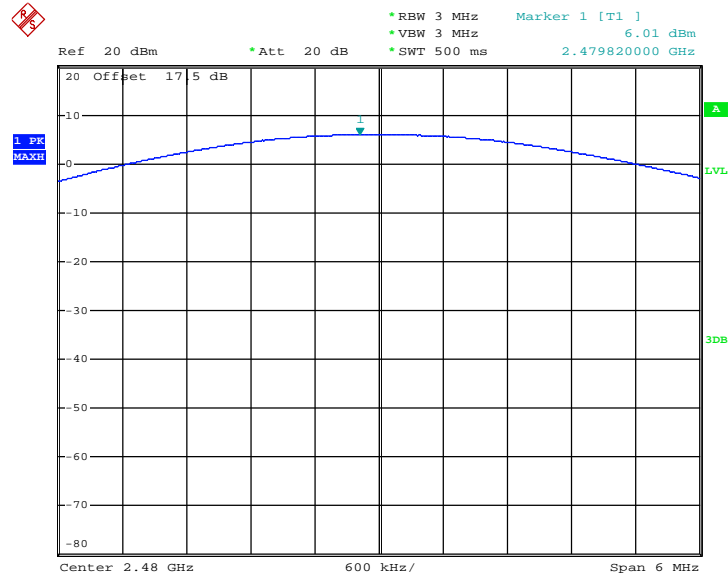

Date: 9.MAY.2013 21:45:13



Test Mode :	3Mbps	Temperature :	24~26°C
Test Engineer :	Fly Chen	Relative Humidity :	50~53%

Channel	Frequency (MHz)	RF Power (dBm)		
		8-DPSK	Max. Limits (dBm)	Pass/Fail
		3 Mbps		
00	2402	7.37	20.97	Pass
39	2441	7.64	20.97	Pass
78	2480	6.26	20.97	Pass

Peak Output Power Plot on Channel 00

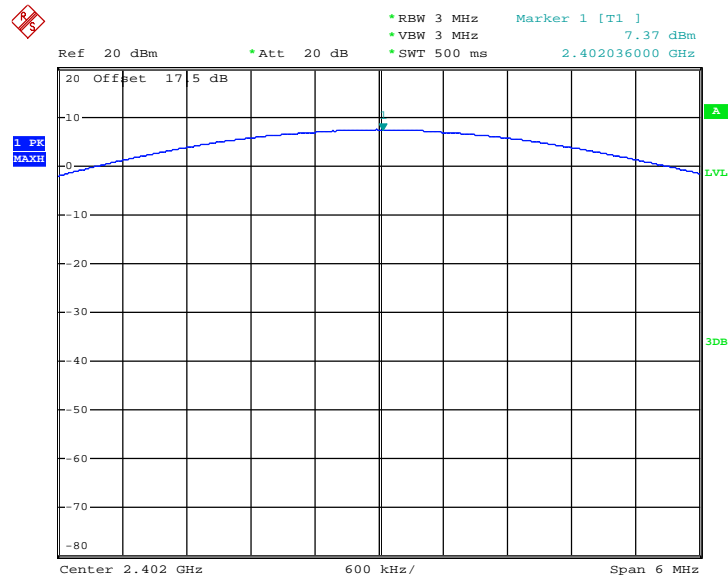

Date: 9.MAY.2013 21:38:13



Peak Output Power Plot on Channel 39

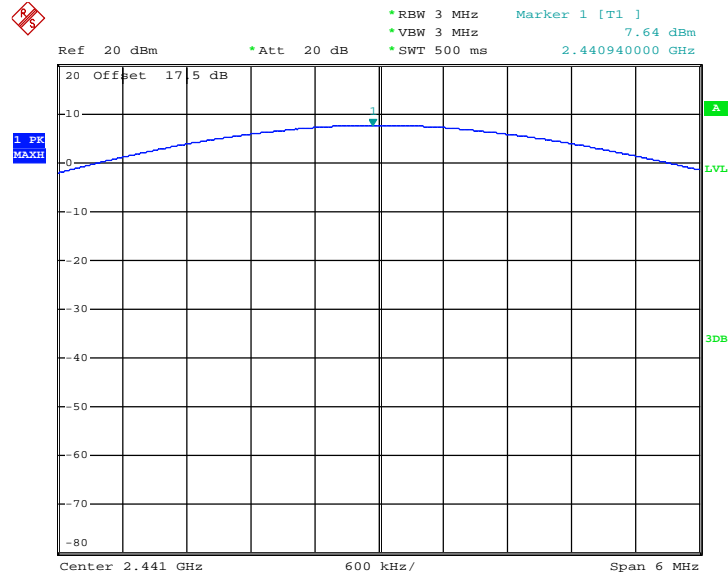

Date: 9.MAY.2013 21:58:24

Peak Output Power Plot on Channel 78

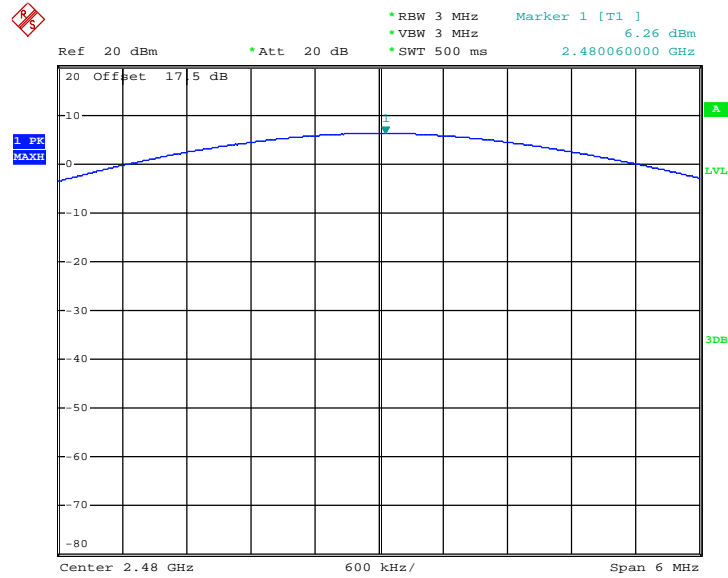

Date: 9.MAY.2013 21:47:59

3.2 Radiated Band Edges and Spurious Emission Measurement

3.2.1 Limit of Radiated Band Edges and Spurious Emission

In any 100 KHz bandwidth outside the intentional radiator frequency band, all harmonics/spurious must be at least 20 dB below the highest emission level within the authorized band. In addition, radiated emissions which fall in the restricted bands must also comply with the FCC section 15.209 limits as below.

Frequency (MHz)	Field Strength (microvolts/meter)	Measurement Distance (meters)
0.009 – 0.490	2400/F(KHz)	300
0.490 – 1.705	24000/F(KHz)	30
1.705 – 30.0	30	30
30 – 88	100	3
88 – 216	150	3
216 - 960	200	3
Above 960	500	3

3.2.2 Measuring Instruments

See list of measuring instruments of this test report.



3.2.3 Test Procedures

1. The testing follows the guidelines in Spurious Radiated Emissions of FCC Public Notice DA 00-705 Measurement Guidelines and the guidelines in ANSI C63.10-2009.
2. The EUT was placed on a turntable with 0.8 meter above ground.
3. The EUT was set 3 meters from the interference receiving antenna, which was mounted on the top of a variable height antenna tower.
4. For each suspected emission, the EUT was arranged to its worst case and then tune the Antenna tower (from 1 m to 4 m) and turntable (from 0 degree to 360 degrees) to find the maximum reading. A pre-amp and a high pass filter are used for the test in order to get better signal level to comply with the guidelines.
5. Set to the maximum power setting and enable the EUT transmit continuously.
6. Use the following spectrum analyzer settings:
 - (1) Span shall wide enough to fully capture the emission being measured;
 - (2) Set RBW=100 KHz for $f < 1$ GHz, RBW=1MHz for $f > 1$ GHz ; VBW \geq RBW; Sweep = auto; Detector function = peak; Trace = max hold for peak
 - (3) For average measurement: use duty cycle correction factor method per 15.35(c).
Duty cycle = On time/100 milliseconds
On time = $N_1 * L_1 + N_2 * L_2 + \dots + N_{n-1} * L_{n-1} + N_n * L_n$
Where N_1 is number of type 1 pulses, L_1 is length of type 1 pulses, etc.
Average Emission Level = Peak Emission Level + $20 * \log(\text{Duty cycle})$
7. Corrected Reading: Antenna Factor + Cable Loss + Read Level - Preamp Factor = Level

Note: The average levels were calculated from the peak level corrected with duty cycle correction factor (24.79dB) derived from $20 \log(\text{dwell time}/100\text{ms})$.

3.2.4 Test Setup

For radiated emissions below 30MHz

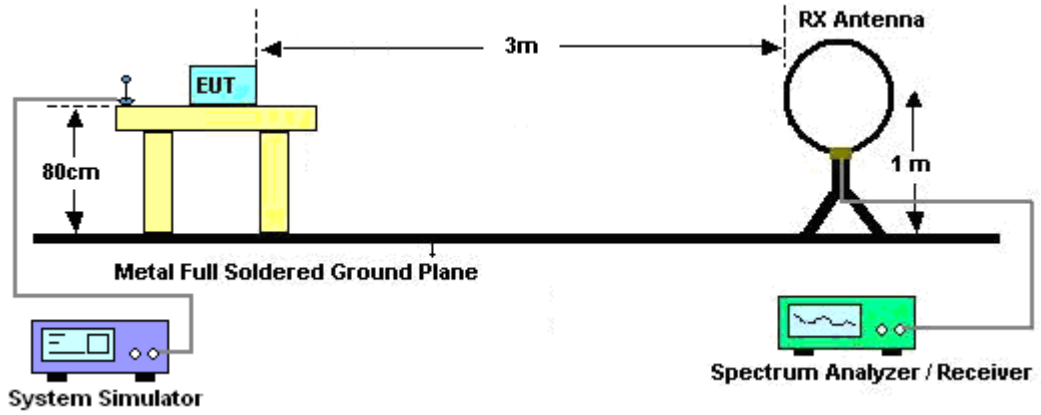

For radiated emissions from 30MHz to 1GHz

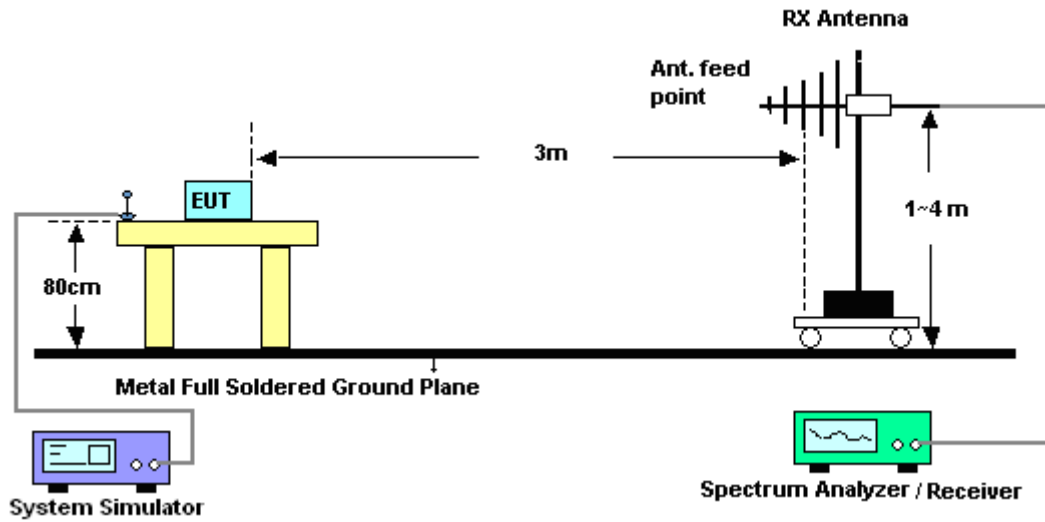

For radiated emissions above 1GHz

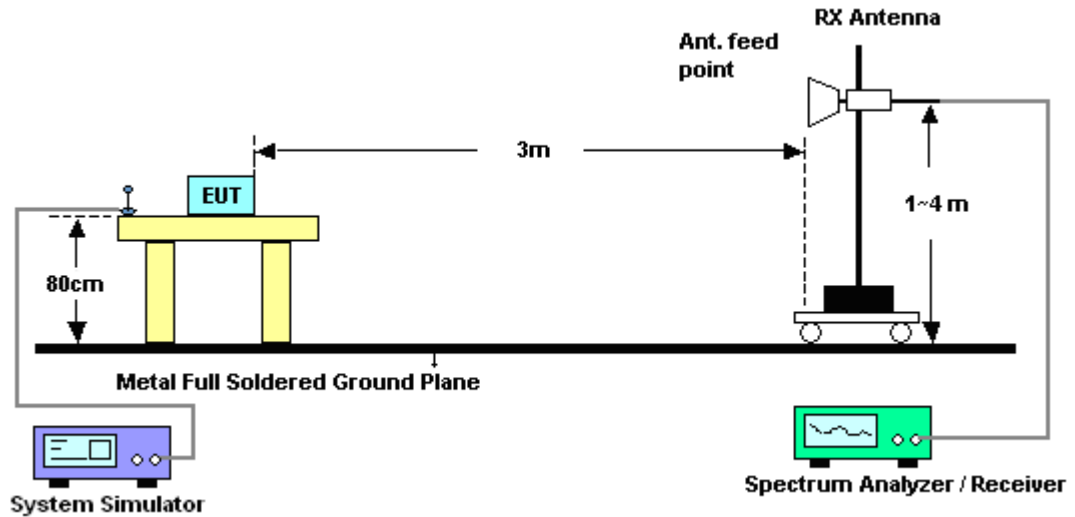

3.2.5 Test Results of Radiated Emissions (9 kHz ~ 30 MHz)

The low frequency, which started from 9 kHz to 30MHz, was pre-scanned and the result which was 20dB lower than the limit line per 15.31(o) was not reported.

3.2.6 Duty cycle correction factor for average measurement

DH5 on time (One Pulse) Plot on Channel 39

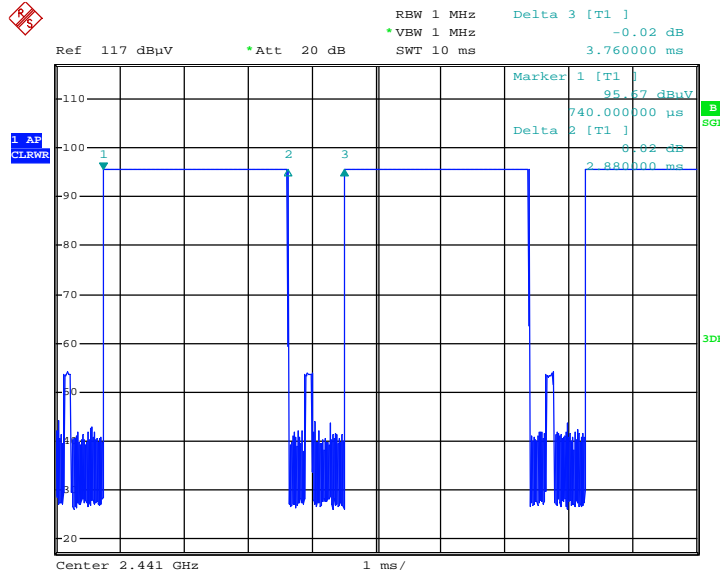

Date: 29.MAY.2013 09:00:35

DH5 on time (Count Pulses) Plot on Channel 39

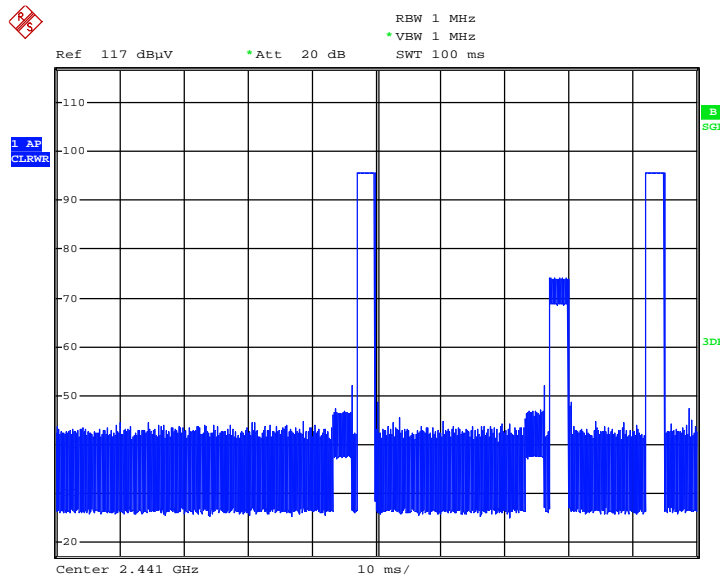

Date: 29.MAY.2013 09:07:46

Note:

1. Worst case Duty cycle = on time/100 milliseconds = $2 * 2.88 / 100 = 5.76 \%$
2. Worst case Duty cycle correction factor = $20 * \log(\text{Duty cycle}) = -24.79 \text{ dB}$
3. DH5 has the highest duty cycle worst case and is reported.



Duty Cycle Correction Factor Consideration for AFH mode:

Bluetooth normal hopping rate is 1600Hz and reduced to 800Hz in AFH mode; due to the reduced number of hopping frequencies, with the same packet configuration the dwell time in each channel frequency within 100msec period is longer in AFH mode than normal mode.

In AFH mode, the minimum hopping frequencies are 20, to get the longest dwell time DH5 packet is observed; the period to have DH5 packet completing one hopping sequence is

$$2.88 \text{ ms} \times 20 \text{ channels} = 57.6 \text{ ms}$$

There cannot be 2 complete hopping sequences within 100ms period, considering the random hopping behavior, maximum 2 hops can be possibly observed within the period. $[100\text{ms} / 57.6\text{ms}] = 2$ hops

Thus, the maximum possible ON time:

$$2.88 \text{ ms} \times 2 = 5.76 \text{ ms}$$

Worst case Duty Cycle Correction factor, which is derived from the maximum possible ON time,

$$20 \times \log(5.76 \text{ ms}/100\text{ms}) = -24.79 \text{ dB}$$



3.2.7 Test Result of Radiated Band Edges

Test Mode :	1Mbps	Temperature :	24~25°C
Test Channel :	78	Relative Humidity :	54~56%
		Test Engineer :	John Zheng

ANTENNA POLARITY : HORIZONTAL										
Frequency (MHz)	Level (dBμV/m)	Over Limit (dB)	Limit Line (dBμV/m)	Read Level (dBμV)	Antenna Factor (dB)	Cable Loss (dB)	Preamp Factor (dB)	Ant Pos (cm)	Table Pos (deg)	Remark
2483.5	67.93	-6.07	74	61.97	32.27	4.47	30.78	107	290	Peak
2483.5	43.14	-10.86	54	-	-	-	-	-	-	Average

ANTENNA POLARITY : VERTICAL										
Frequency (MHz)	Level (dBμV/m)	Over Limit (dB)	Limit Line (dBμV/m)	Read Level (dBμV)	Antenna Factor (dB)	Cable Loss (dB)	Preamp Factor (dB)	Ant Pos (cm)	Table Pos (deg)	Remark
2483.5	65.17	-8.83	74	59.21	32.27	4.47	30.78	171	186	Peak
2483.5	40.38	-13.62	54	-	-	-	-	-	-	Average



3.2.8 Test Result of Radiated Emission (30 MHz ~ 10th Harmonic)

Note: Below 1GHz for radiated emission measurement, pre-scanned all test modes and only choose the worst case mode was recorded in the report.

Test Mode :	1Mbps	Temperature :	24~25°C
Test Channel :	78	Relative Humidity :	54~56%
Test Engineer :	John Zheng	Polarization :	Horizontal
Remark :	1. 2480 MHz is fundamental signal which can be ignored. 2. Average measurement was not performed if peak level went lower than the average limit.		

Frequency (MHz)	Level (dBμV/m)	Over Limit (dB)	Limit Line (dBμV/m)	Read Level (dBμV)	Antenna Factor (dB)	Cable Loss (dB)	Preamp Factor (dB)	Ant Pos (cm)	Table Pos (deg)	Remark
97.9	21.9	-21.6	43.5	40.74	10.67	1.16	30.67	-	-	Peak
105.66	23.61	-19.89	43.5	41.28	11.8	1.18	30.65	136	191	Peak
165.8	19.19	-24.31	43.5	38.47	9.9	1.27	30.45	-	-	Peak
265.71	20.63	-25.37	46	36.03	13.03	1.68	30.11	-	-	Peak
279.29	19.12	-26.88	46	34.5	13	1.69	30.07	-	-	Peak
411.21	20.06	-25.94	46	30.9	16.86	1.93	29.63	-	-	Peak
2480	107.24	-	-	101.28	32.27	4.47	30.78	107	290	Peak
2480	82.45	-	-	-	-	-	-	107	290	Average
4960	46.56	-27.44	74	33.91	34.01	6.13	27.49	100	120	Peak
7440	49.78	-24.22	74	34.2	35.37	8.08	27.87	100	196	Peak

Note: Other harmonics are lower than background noise.



Test Mode :	1Mbps	Temperature :	24~25°C
Test Channel :	78	Relative Humidity :	54~56%
Test Engineer :	John Zheng	Polarization :	Vertical
Remark :	1. 2402 MHz is fundamental signal which can be ignored. 2. Average measurement was not performed if peak level went lower than the average limit.		

Frequency (MHz)	Level (dBμV/m)	Over Limit (dB)	Limit Line (dBμV/m)	Read Level (dBμV)	Antenna Factor (dB)	Cable Loss (dB)	Preamp Factor (dB)	Ant Pos (cm)	Table Pos (deg)	Remark
100.81	19.82	-23.68	43.5	38.12	11.2	1.16	30.66	-	-	Peak
113.42	20.15	-23.35	43.5	37.41	12.15	1.21	30.62	121	337	Peak
190.05	19.56	-23.94	43.5	38.66	9.9	1.37	30.37	-	-	Peak
293.84	15.21	-30.79	46	30.07	13.47	1.69	30.02	-	-	Peak
432.55	19.66	-26.34	46	30.52	16.74	1.96	29.56	-	-	Peak
508.21	21.35	-24.65	46	30.78	17.74	2.15	29.32	-	-	Peak
2480	104.18	-	-	98.22	32.27	4.47	30.78	171	186	Peak
2480	79.39	-	-	-	-	-	-	171	186	Average
4960	47.76	-26.24	74	35.11	34.01	6.13	27.49	100	219	Peak
7440	49.19	-24.81	74	33.61	35.37	8.08	27.87	100	223	Peak

Note: Other harmonics are lower than background noise.



3.3 Antenna Requirements

3.3.1 Standard Applicable

If directional gain of transmitting antennas is greater than 6dBi, the power shall be reduced by the same level in dB comparing to gain minus 6dBi. The use of a permanently attached antenna or of an antenna that uses a unique coupling to the intentional radiator shall be considered sufficient to comply with the FCC rule.

3.3.2 Antenna Connected Construction

Non-standard connector used.

3.3.3 Antenna Gain

The antenna peak gain of EUT is less than 6 dBi. Therefore, it is not necessary to reduce maximum peak output power limit.



4 List of Measuring Equipment

Instrument	Manufacturer	Model No.	Serial No.	Characteristics	Calibration Date	Test Date	Due Date	Remark
Spectrum Analyzer	R&S	FSP30	101400	9kHz~30GHz	Oct. 10, 2012	May 09, 2013	Oct. 09, 2013	Conducted (TH01-SZ)
Power meter	Anritsu	ML2495A	1218010	N/A	Mar. 28, 2013	May 09, 2013	Mar. 27, 2014	Conducted (TH01-SZ)
Power Senso	Anritsu	MA2411B	1207253	N/A	Mar. 28, 2013	May 09, 2013	Mar. 27, 2014	Conducted (TH01-SZ)
Thermal Chamber	Hongzhan	LP-150U	HD20120425	N/A	Jun. 11, 2012	May 09, 2013	Jun. 10, 2013	Conducted (TH01-SZ)
ESCI TEST Receiver	R&S	ESCI	100724	9K-3GHz	Mar. 28, 2013	May 29, 2013	Mar. 27, 2014	Radiation (03CH01-SZ)
Spectrum Analyzer	R&S	FSP30	101362	9kHz~30GHz	Oct. 11, 2012	May 29, 2013	Oct. 10, 2013	Radiation (03CH01-SZ)
Double Ridge Horn Antenna	ETS Lindgren	3117	00119436	1GHz~18GHz	Oct. 12, 2012	May 29, 2013	Oct. 11, 2013	Radiation (03CH01-SZ)
Bilog Antenna	SCHAFFNER	CBL6112B	2614	30Mhz~2Ghz	Nov. 03, 2012	May 29, 2013	Nov. 02, 2013	Radiation (03CH01-SZ)
Amplifier	ADVANTEST	BB525C	E9007003	9K-3000MHz GAIN 30db	Mar. 28, 2013	May 29, 2013	Mar. 27, 2014	Radiation (03CH01-SZ)
Amplifier	Yiai	AV3860B	04030	2GHz~26.5GHz	Mar. 28, 2013	May 29, 2013	Mar. 27, 2014	Radiation (03CH01-SZ)
SHF-EHF-Horn	Schwarzbeck	BBHA9170	BBHA9170249	14Ghz~40Ghz	Nov. 23, 2012	May 29, 2013	Nov. 22, 2013	Radiation (03CH01-SZ)
Loop Antenna	R&S	HFH2-Z2	100321	9KHZ-30MHZ	Oct. 22, 2012	May 29, 2013	Oct. 21, 2013	Radiation (03CH01-SZ)
Turn Table	EM Electronice	EM 1000	N/A	0 ~ 360 degree	N/A	May 29, 2013	N/A	Radiation (03CH01-SZ)
Antenna Mast	EM Electronice	EM 1000	N/A	1 m - 4 m	N/A	May 29, 2013	N/A	Radiation (03CH01-SZ)



5 Uncertainty of Evaluation

Uncertainty of Conducted Emission Measurement (150 KHz ~ 30 MHz)

Measuring Uncertainty for a Level of Confidence of 95% ($U = 2Uc(y)$)	2.26
---	------

Uncertainty of Radiated Emission Measurement (30 MHz ~ 1000 MHz)

Measuring Uncertainty for a Level of Confidence of 95% ($U = 2Uc(y)$)	2.54
---	------

Uncertainty of Radiated Emission Measurement (1 GHz ~ 40 GHz)

Measuring Uncertainty for a Level of Confidence of 95% ($U = 2Uc(y)$)	4.72
---	------



Appendix A. Photographs of EUT

Please refer to Sporton report number EP312802-01 as below.



Appendix C. Product Equality Declaration

Lenovo (Shanghai) Electronics Technology Co., Ltd.

No. 68 Building, 199 Fenju Road, Wai Gao Qiao FTZ , Shanghai , China

Tel: 86-21-50504500-8237



Date: July 19, 2013

Product Equality Declaration



We, Lenovo (Shanghai) Electronics Technology Co., Ltd., declare on our sole responsibility for the product of **lenovo 60027** below:

The differences between previous and current model of **lenovo 60027** are as below:

1. BT/ WIFI Antenna difference:

Original Antenna(BT/WIFI)	New Antenna(Change shape and add absorbing material) (BT/WIFI)
	

2. GPS Antenna difference :

Original Antenna (GPS)	New Antenna(Change shape) (GPS)
	

Except for the antenna shape changes listed above, and adding absorbing material beside BT/WIFI antenna, antenna type, material and the gain of antenna and matching are in all relevant parts identical to the original product.

Should you have any questions or comments regarding this matter, please have my best attention.



Declared by :

on behalf of Lenovo (Shanghai) Electronics Technology Co., Ltd.