

APPLICATION CERTIFICATION FCC Part 15C
On Behalf of
SWAGTEK

TV BOX
Model No.: IS-TV1200K

FCC ID: O55TVBOX1200K

Prepared for : SWAGTEK
Address : 8800 NW 23rd Street, Miami, FLORIDA, USA

Prepared by : ACCURATE TECHNOLOGY CO., LTD
Address : F1, Bldg. A, Changyuan New Material Port, Keyuan Rd.
Science & Industry Park, Nanshan, Shenzhen, Guangdong
P.R. China

Tel: (0755) 26503290
Fax: (0755) 26503396

Report Number : ATE20121277
Date of Test : June 13-July 4, 2012
Date of Report : July 5, 2012

TABLE OF CONTENTS

Description	Page
Test Report Certification	
1. GENERAL INFORMATION	5
1.1. Description of Device (EUT).....	5
1.2. Carrier Frequency of Channels.....	6
1.3. Test Procedure	6
1.4. Special Accessory and Auxiliary Equipment	6
1.5. Description of Test Facility	6
1.6. Measurement Uncertainty.....	7
2. MEASURING DEVICE AND TEST EQUIPMENT	8
3. OPERATION OF EUT DURING TESTING	9
3.1. Operating Mode.....	9
3.2. Configuration and peripherals	10
4. TEST PROCEDURES AND RESULTS	11
5. 6DB BANDWIDTH MEASUREMENT.....	12
5.1. Block Diagram of Test Setup.....	12
5.2. The Requirement For Section 15.247(a)(2).....	12
5.3. EUT Configuration on Measurement	12
5.4. Operating Condition of EUT	12
5.5. Test Procedure	13
5.6. Test Result	13
6. MAXIMUM PEAK OUTPUT POWER	27
6.1. Block Diagram of Test Setup.....	27
6.2. The Requirement For Section 15.247(b)(3).....	27
6.3. EUT Configuration on Measurement	27
6.4. Operating Condition of EUT	27
6.5. Test Procedure	28
6.6. Test Result	28
7. POWER SPECTRAL DENSITY MEASUREMENT.....	42
7.1. Block Diagram of Test Setup.....	42
7.2. The Requirement For Section 15.247(e).....	42
7.3. EUT Configuration on Measurement	42
7.4. Operating Condition of EUT	42
7.5. Test Procedure	43
7.6. Test Result	44
8. BAND EDGE COMPLIANCE TEST	58
8.1. Block Diagram of Test Setup.....	58
8.2. The Requirement For Section 15.247(d)	58
8.3. EUT Configuration on Measurement	58
8.4. Operating Condition of EUT	59
8.5. Test Procedure	59
8.6. Test Result	60
9. RADIATED SPURIOUS EMISSION TEST	93
9.1. Block Diagram of Test Setup.....	93
9.2. The Limit For Section 15.247(d)	94
9.3. Restricted bands of operation	94

- 9.4. Configuration of EUT on Measurement95
- 9.5. Operating Condition of EUT95
- 9.6. Test Procedure95
- 9.7. The Field Strength of Radiation Emission Measurement Results96
- 10. CONDUCTED SPURIOUS EMISSION COMPLIANCE TEST 180**
 - 10.1. Block Diagram of Test Setup..... 180
 - 10.2. The Requirement For Section 15.247(d) 180
 - 10.3. EUT Configuration on Measurement 180
 - 10.4. Operating Condition of EUT 181
 - 10.5. Test Procedure 181
 - 10.6. Test Result 181
- 11. AC POWER LINE CONDUCTED EMISSION FOR FCC PART 15 SECTION 15.207(A) 194**
 - 11.1. Block Diagram of Test Setup..... 194
 - 11.2. The Emission Limit 194
 - 11.3. Configuration of EUT on Measurement 195
 - 11.4. Operating Condition of EUT 195
 - 11.5. Test Procedure 195
 - 11.6. Power Line Conducted Emission Measurement Results 196
- 12. ANTENNA REQUIREMENT..... 199**
 - 12.1. The Requirement 199
 - 12.2. Antenna Construction 199

Test Report Certification

Applicant : SWAGTEK
Manufacturer : SWAGTEK
EUT Description : TV BOX
(A) MODEL NO.: IS-TV1200K
(B) SERIAL NO.: N/A
(C) POWER SUPPLY: DC 12V(Power by adapter)

Measurement Procedure Used:

**FCC Rules and Regulations Part 15 Subpart C Section 15.247
ANSI C63.4: 2003**

The EUT was tested according to DTS test procedure of January 18, 2012 KDB558074 for compliance to FCC 47CFR 15.247 requirements.

The device described above is tested by ACCURATE TECHNOLOGY CO. LTD to determine the maximum emission levels emanating from the device. The maximum emission levels are compared to the FCC Part 15 Subpart C Section 15.247 limits. The measurement results are contained in this test report and ACCURATE TECHNOLOGY CO. LTD is assumed full responsibility for the accuracy and completeness of these measurements. Also, this report shows that the Equipment Under Test (EUT) is to be technically compliant with the FCC requirements.

This report applies to above tested sample only. This report shall not be reproduced in part without written approval of ACCURATE TECHNOLOGY CO. LTD.

Date of Test : June 13-July 4, 2012

Prepared by : Apple Lv
(Engineer)

Approved & Authorized Signer : Gennd
(Manager)

1. GENERAL INFORMATION

1.1. Description of Device (EUT)

EUT	:	TV BOX
Model Number	:	IS-TV1200K
Frequency Range	:	802.11b/g/n(20MHz): 2412-2462MHz 802.11n(40MHz): 2422-2452MHz
Number of Channels	:	802.11b/g/n (20MHz):11 802.11n (40MHz): 7
Antenna Gain	:	0dBi
Power Supply	:	DC 12V(Power by adapter)
Adapter	:	Model number: JKY36-SP1202000 Input: AC 100-240V; 50/60Hz 1.0A Max. Output: DC 12V/2000mA
Data Rate	:	802.11b: 11, 5.5, 2, 1 Mbps 802.11g: 54, 48, 36, 24, 18, 12, 9, 6 Mbps 802.11n: up to 150Mbps
Applicant	:	SWAGTEK
Address	:	8800 NW 23 rd Street, Miami, FLORIDA, USA
Manufacturer	:	SWAGTEK
Address	:	8800 NW 23 rd Street, Miami, FLORIDA, USA
Manufacturer	:	Kintech Co., Ltd.
Address	:	Bldg. 22, Chen Tian Industrial Zone, Bao An District, Shenzhen, Guangdong, China
Date of sample received	:	June 13, 2012
Date of Test	:	June 13-July 4, 2012

1.2. Carrier Frequency of Channels

802.11b, 802.11g, 802.11n (20MHz)

Channel	Frequency(MHz)	Channel	Frequency(MHz)
01	2412	07	2442
02	2417	08	2447
03	2422	09	2452
04	2427	10	2457
05	2432	11	2462
06	2437	---	---

802.11n (40MHz)

Channel	Frequency(MHz)	Channel	Frequency(MHz)
---	---	07	2442
---	---	08	2447
03	2422	09	2452
04	2427	---	---
05	2432	---	---
06	2437	---	---

1.3. Test Procedure

The EUT was tested according to DTS test procedure of January 18, 2012 KDB558074 for compliance to FCC 47CFR 15.247 requirements.

1.4. Special Accessory and Auxiliary Equipment

N/A

1.5. Description of Test Facility

EMC Lab : Accredited by TUV Rheinland Shenzhen

Listed by FCC
The Registration Number is 752051

Listed by Industry Canada
The Registration Number is 5077A-2

Accredited by China National Accreditation Committee
for Laboratories
The Certificate Registration Number is L3193

Name of Firm : ACCURATE TECHNOLOGY CO. LTD

Site Location : F1, Bldg. A, Changyuan New Material Port, Keyuan Rd.
Science & Industry Park, Nanshan, Shenzhen, Guangdong
P.R. China

1.6.Measurement Uncertainty

Conducted Emission Expanded Uncertainty = 2.23dB, k=2

Radiated emission expanded uncertainty
(9kHz-30MHz) = 3.08dB, k=2

Radiated emission expanded uncertainty
(30MHz-1000MHz) = 4.42dB, k=2

Radiated emission expanded uncertainty
(Above 1GHz) = 4.06dB, k=2

2. MEASURING DEVICE AND TEST EQUIPMENT

Table 1: List of Test and Measurement Equipment

Kind of equipment	Manufacturer	Type	S/N	Calibrated dates	Calibrated until
EMI Test Receiver	Rohde&Schwarz	ESCS30	100307	Jan. 8, 2012	Jan. 7, 2013
EMI Test Receiver	Rohde&Schwarz	ESPI3	101526/003	Jan. 8, 2012	Jan. 7, 2013
Spectrum Analyzer	Agilent	E7405A	MY45115511	Jan. 8, 2012	Jan. 7, 2013
Pre-Amplifier	Rohde&Schwarz	CBLU118354 0-01	3791	Jan. 8, 2012	Jan. 7, 2013
Loop Antenna	Schwarzbeck	FMZB1516	1516131	Jan. 8, 2012	Jan. 7, 2013
Bilog Antenna	Schwarzbeck	VULB9163	9163-323	Jan. 8, 2012	Jan. 7, 2013
Horn Antenna	Schwarzbeck	BBHA9120D	9120D-655	Jan. 8, 2012	Jan. 7, 2013
Horn Antenna	Schwarzbeck	BBHA9170	9170-359	Jan. 8, 2012	Jan. 7, 2013
LISN	Rohde&Schwarz	ESH3-Z5	100305	Jan. 8, 2012	Jan. 7, 2013
LISN	Schwarzbeck	NSLK8126	8126431	Jan. 8, 2012	Jan. 7, 2013

3. OPERATION OF EUT DURING TESTING

3.1.Operating Mode

The mode is used: **1.802.11b Transmitting mode**

Low Channel: 2412MHz

Middle Channel: 2437MHz

High Channel: 2462MHz

2.802.11g Transmitting mode

Low Channel: 2412MHz

Middle Channel: 2437MHz

High Channel: 2462MHz

3.802.11n (20MHz) Transmitting mode

Low Channel: 2412MHz

Middle Channel: 2437MHz

High Channel: 2462MHz

4.802.11n (40MHz) Transmitting mode

Low Channel: 2422MHz

Middle Channel: 2437MHz

High Channel: 2452MHz

3.2. Configuration and peripherals

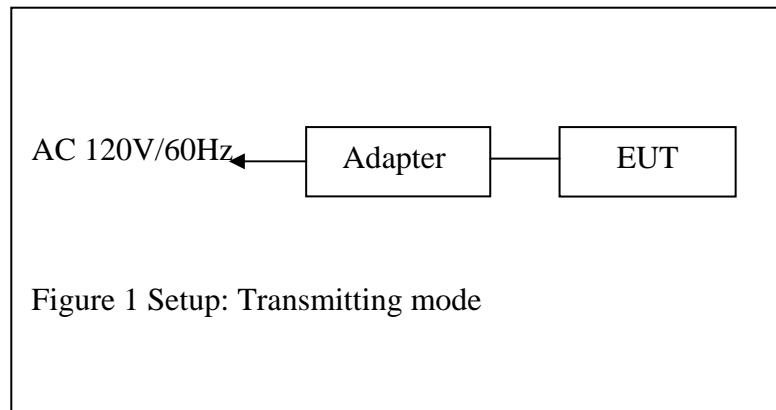

4. TEST PROCEDURES AND RESULTS

FCC Rules	Description of Test	Result
Section 15.247(a)(2)	6dB Bandwidth Test	Compliant
Section 15.247(e)	Power Spectral Density Test	Compliant
Section 15.247(b)(3)	Maximum Peak Output Power Test	Compliant
Section 15.247(d)	Band Edge Compliance Test	Compliant
Section 15.247(d) Section 15.209	Radiated Spurious Emission Test	Compliant
Section 15.247(d)	Conducted Spurious Emission Test	Compliant
Section 15.207	AC Power Line Conducted Emission Test	Compliant
Section 15.203	Antenna Requirement	Compliant

5. 6DB BANDWIDTH MEASUREMENT

5.1. Block Diagram of Test Setup

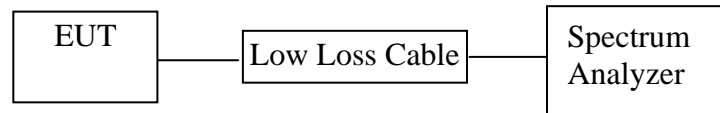

(EUT: TV BOX)

5.2. The Requirement For Section 15.247(a)(2)

Section 15.247(a)(2): Systems using digital modulation techniques may operate in the 902-928MHz, 2400-2483.5MHz, and 5725-5850MHz bands. The minimum 6 dB bandwidth shall be at least 500 kHz.

5.3. EUT Configuration on Measurement

The following equipment are installed on the emission measurement to meet the commission requirements and operating regulations in a manner which tends to maximize its emission characteristics in normal application.

5.3.1. TV BOX (EUT)

Model Number : IS-TV1200K
 Serial Number : N/A
 Manufacturer : SWAGTEK

5.4. Operating Condition of EUT

5.4.1. Setup the EUT and simulator as shown as Section 5.1.

5.4.2. Turn on the power of all equipment.

5.4.3. Let the EUT work in TX modes measure it. The transmit frequency are 2412-2462 and 2422-2452MHz. We select 2412MHz, 2437MHz, 2462MHz and 2422MHz, 2437MHz, 2452MHz TX frequency to transmit.

5.5. Test Procedure

5.5.1. The transmitter output was connected to the spectrum analyzer through a low loss cable.

5.5.2. Set RBW of spectrum analyzer to 300kHz and VBW to 1MHz(b, g, n(20M)).

Set RBW of spectrum analyzer to 1MHz and VBW to 3MHz(n(40M)).

5.5.3. The 6dB bandwidth is defined as the total spectrum the power of which is higher than peak power minus 6dB.

5.6. Test Result

PASS.

Date of Test:	June 19, 2012	Temperature:	25°C
EUT:	TV BOX	Humidity:	50%
Model No.:	IS-TV1200K	Power Supply:	AC 120V/60HZ
Test Mode:	TX	Test Engineer:	Pei

The test was performed with 802.11b

Channel	Frequency (MHz)	6dB Bandwidth (MHz)	Limit (MHz)
Low	2412	10.20	> 0.5MHz
Middle	2437	10.28	> 0.5MHz
High	2462	10.36	> 0.5MHz

The test was performed with 802.11g

Channel	Frequency (MHz)	6dB Bandwidth (MHz)	Limit (MHz)
Low	2412	16.56	> 0.5MHz
Middle	2437	16.64	> 0.5MHz
High	2462	16.64	> 0.5MHz

The test was performed with 802.11n (Bandwidth: 20 MHz)			
Channel	Frequency (MHz)	6dB Bandwidth (MHz)	Limit (MHz)
Low	2412	17.76	> 0.5MHz
Middle	2437	17.76	> 0.5MHz
High	2462	17.76	> 0.5MHz

The test was performed with 802.11n (Bandwidth: 40 MHz)			
Channel	Frequency (MHz)	6dB Bandwidth (MHz)	Limit (MHz)
Low	2422	36.40	> 0.5MHz
Middle	2437	36.48	> 0.5MHz
High	2452	36.64	> 0.5MHz

The spectrum analyzer plots are attached as below.

802.11b Channel Low 2412MHz



*RBW 300 kHz Delta 2 [T1]
VBW 1 MHz -0.20 dB
SWT 2.5 ms 10.200000000 MHz

Ref 20 dBm

Att 50 dB

1 PK
MAXH

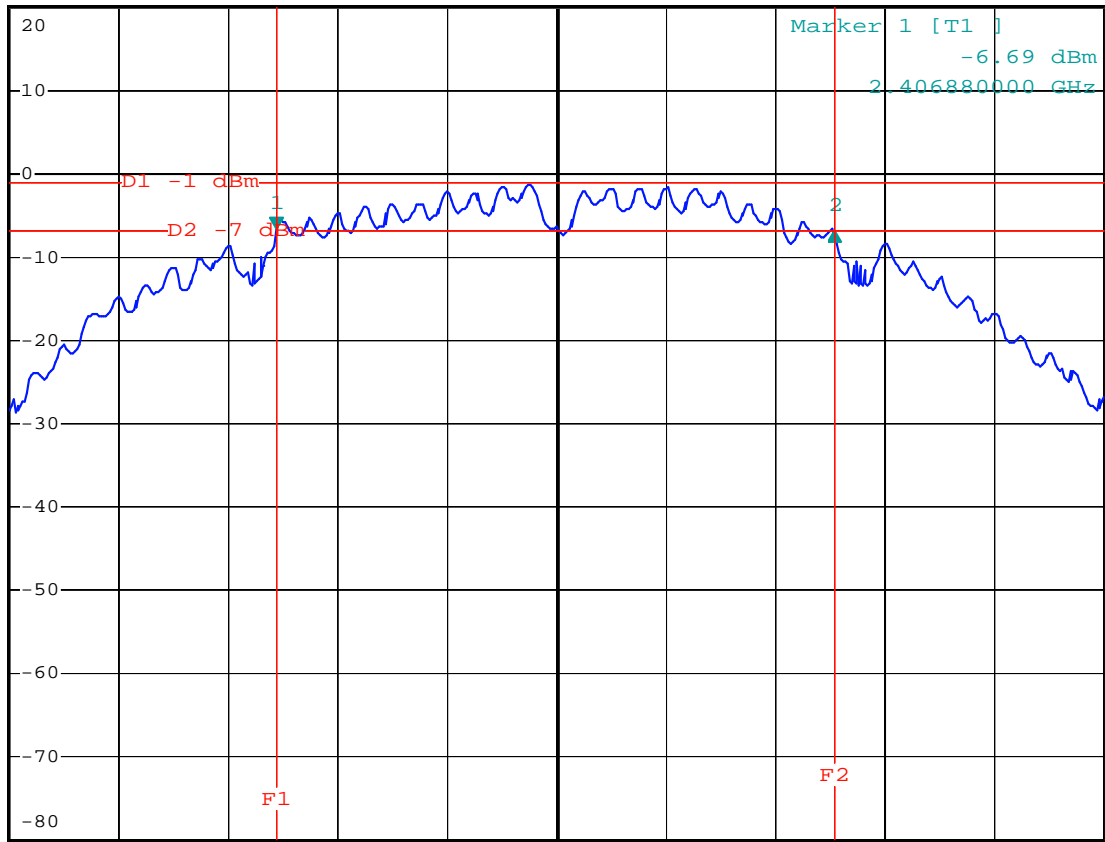

Center 2.412 GHz

2 MHz/

Span 20 MHz

Date: 19.JUN.2012 17:54:54

802.11b Channel Middle 2437MHz

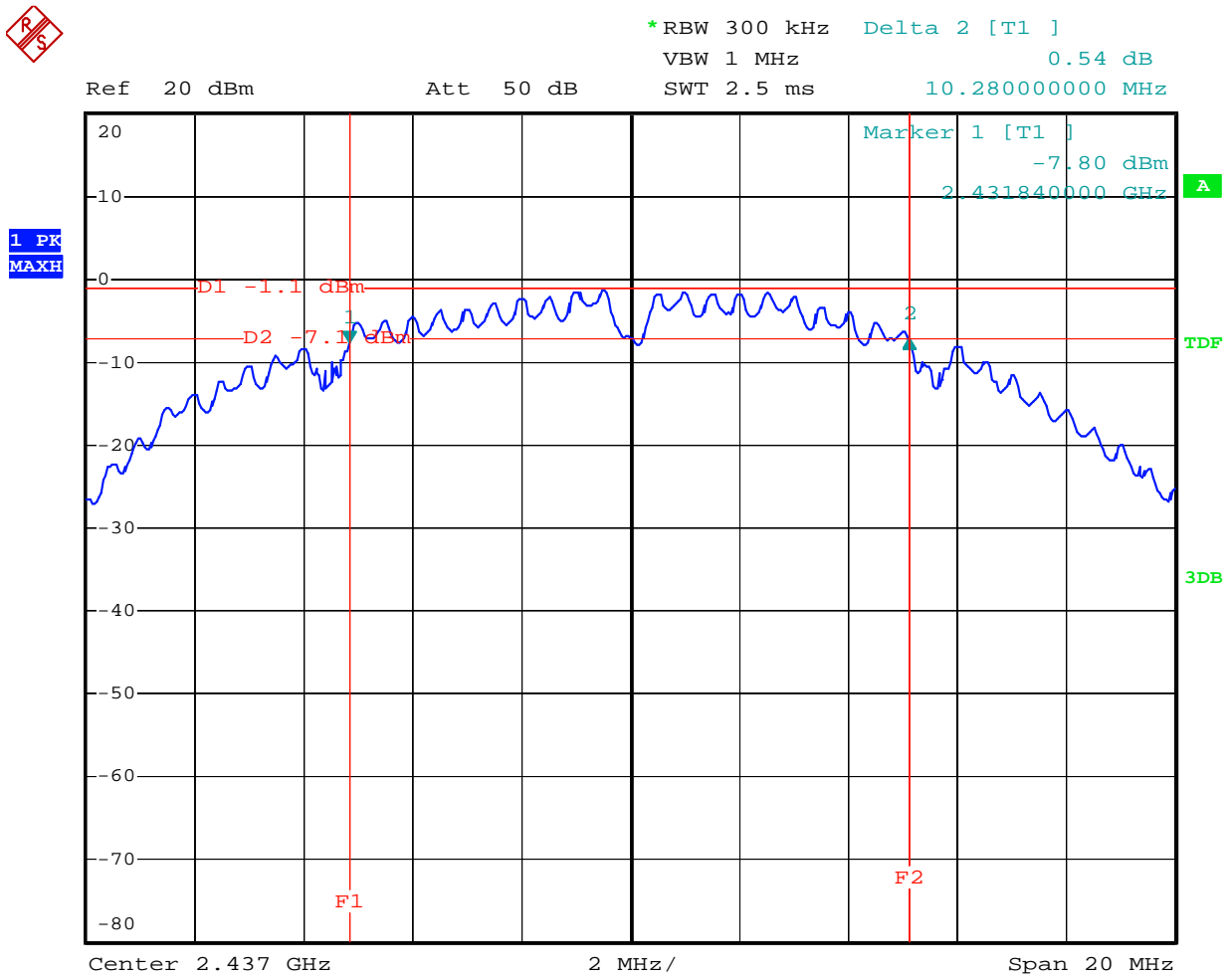

Date: 19.JUN.2012 17:58:52

802.11b Channel High 2462MHz



*RBW 300 kHz Delta 2 [T1]
VEW 1 MHz 0.32 dB
SWT 2.5 ms 10.360000000 MHz

Ref 20 dBm

Att 50 dB

10.360000000 MHz

1 PK
MAXH

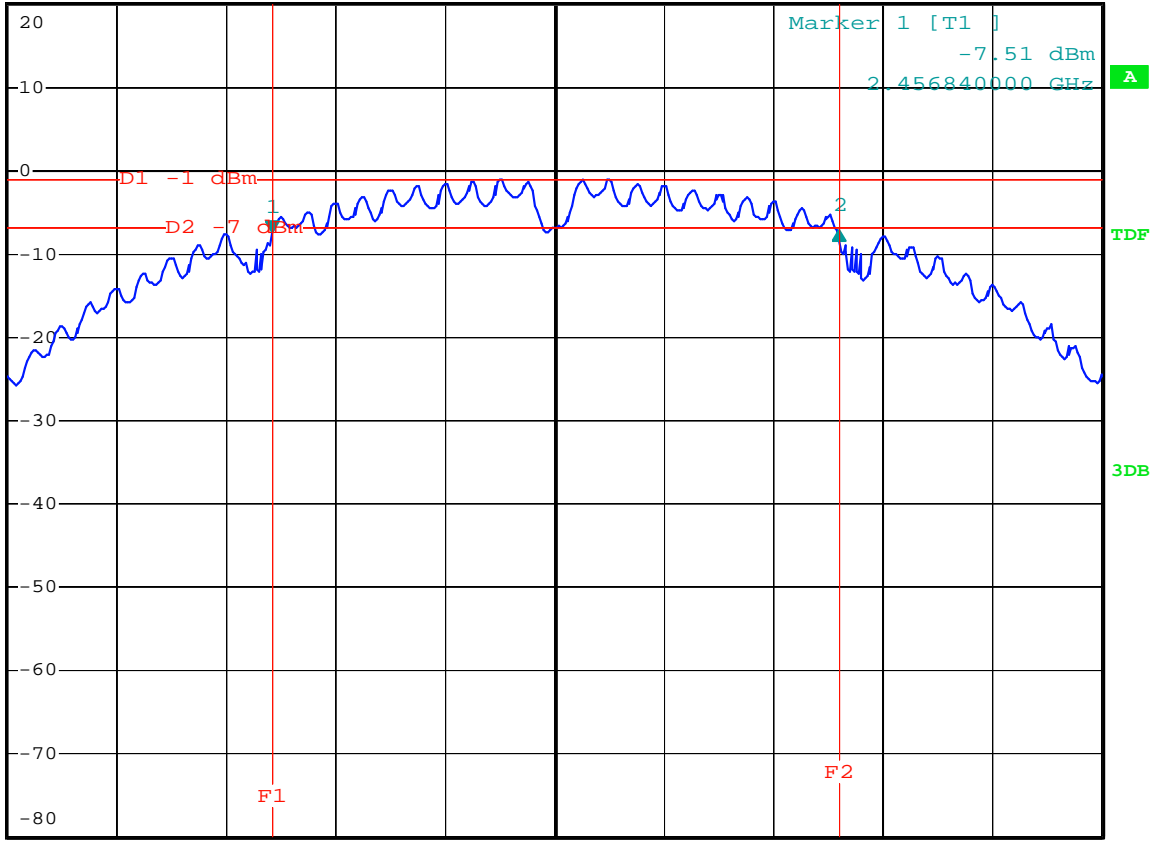

Center 2.462 GHz

2 MHz/

Span 20 MHz

Date: 19.JUN.2012 18:01:45

802.11g Channel Low 2412MHz



*RBW 300 kHz Delta 2 [T1]
VEW 1 MHz -0.63 dB
SWT 2.5 ms 16.56000000 MHz

Ref 20 dBm

Att 50 dB

1 PK
MAXH

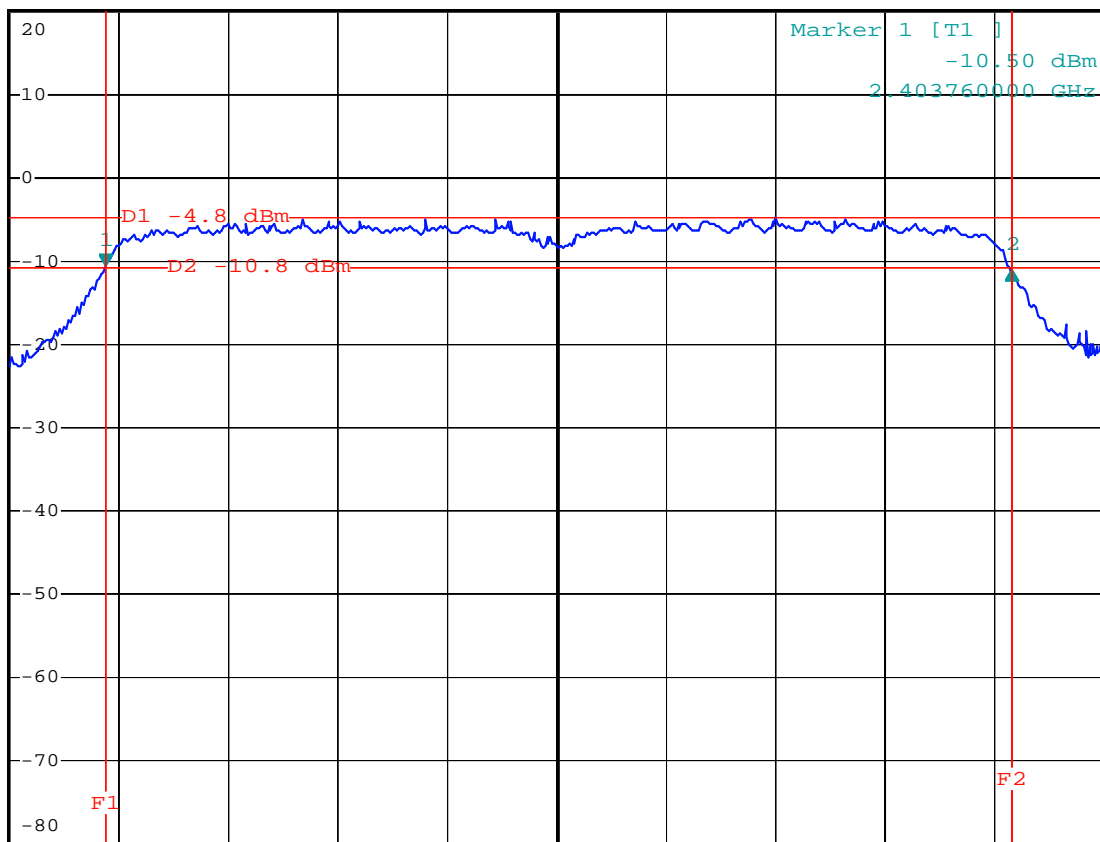

Center 2.412 GHz

2 MHz/

Span 20 MHz

Date: 19.JUN.2012 18:06:05

802.11g Channel Middle 2437MHz



*RBW 300 kHz Delta 2 [T1]
VEW 1 MHz 0.04 dB
SWT 2.5 ms 16.640000000 MHz

Ref 20 dBm

Att 50 dB

1 PK
MAXH

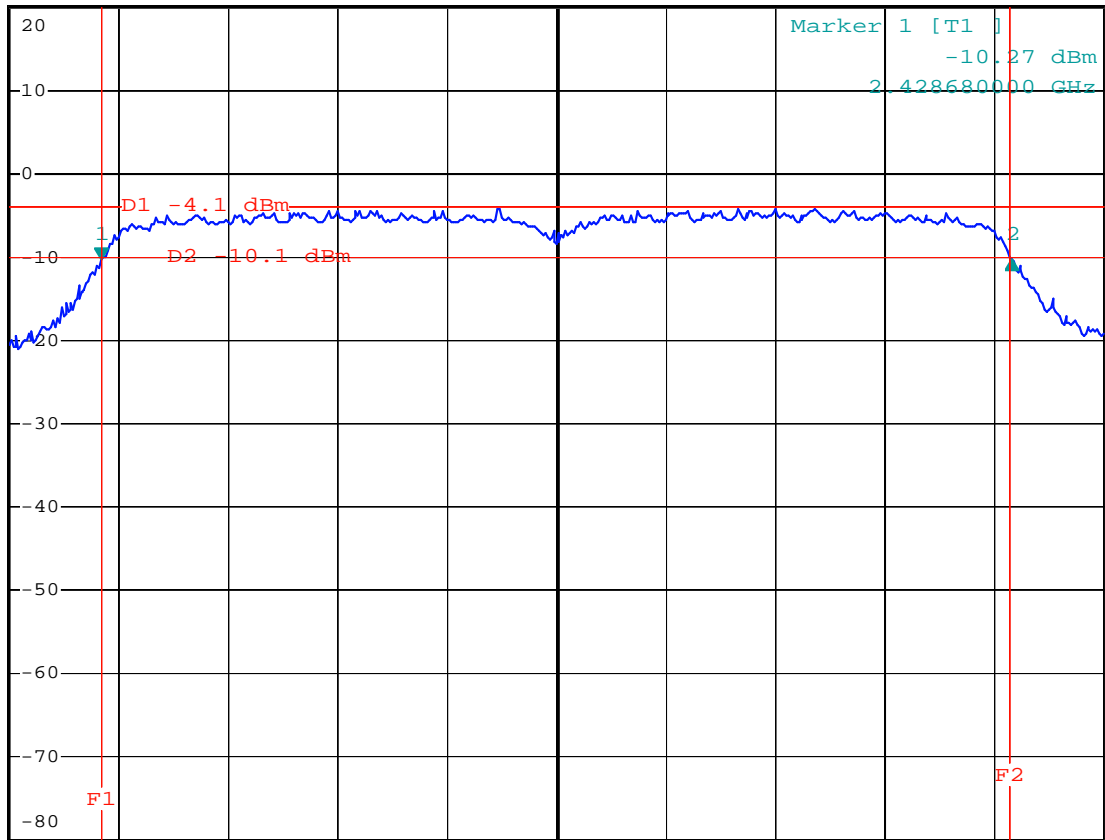

Center 2.437 GHz

2 MHz/

Span 20 MHz

Date: 19.JUN.2012 18:09:39

802.11g Channel High 2462MHz



*RBW 300 kHz Delta 2 [T1]
VEW 1 MHz 1.21 dB
SWT 2.5 ms 16.640000000 MHz

Ref 20 dBm

Att 50 dB

1 PK
MAXH

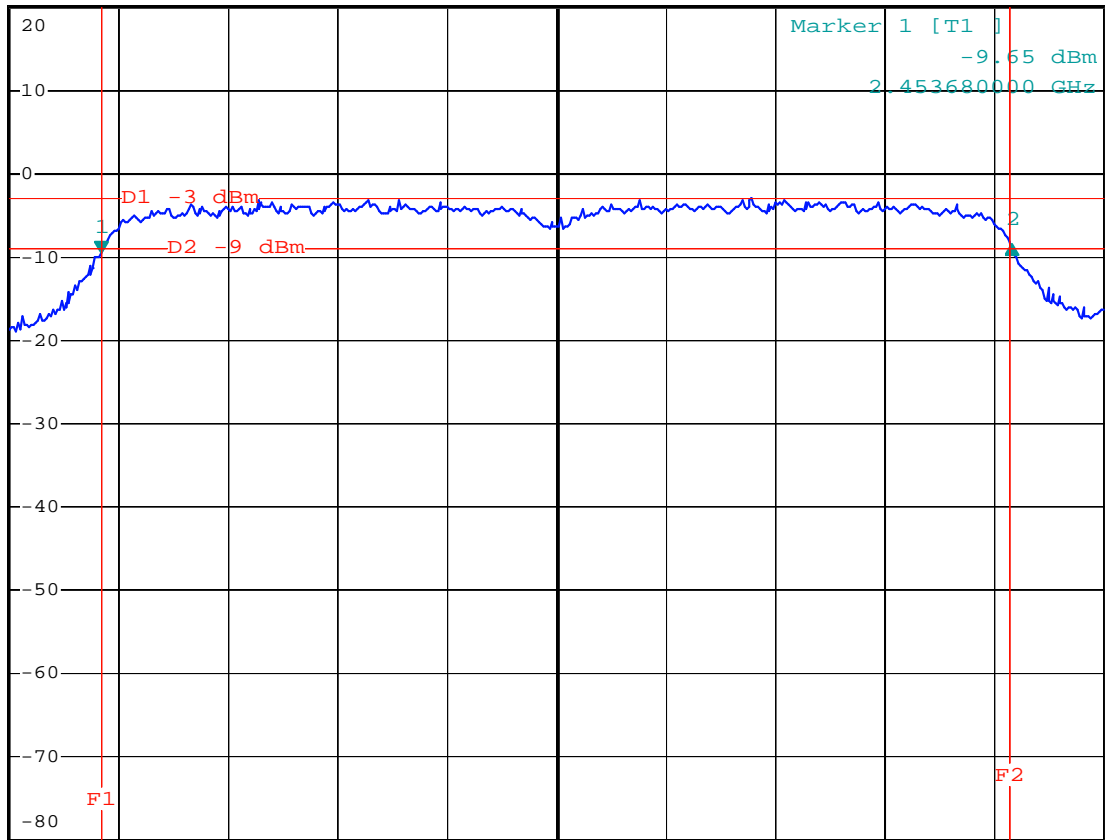

Center 2.462 GHz

2 MHz/

Span 20 MHz

Date: 19.JUN.2012 18:14:24

802.11n Channel Low 2412MHz (20MHz)



*RBW 300 kHz Delta 2 [T1]
 VBW 1 MHz -0.13 dB
 SWT 2.5 ms 17.760000000 MHz

Ref 20 dBm

Att 50 dB

1 PK
 MAXH

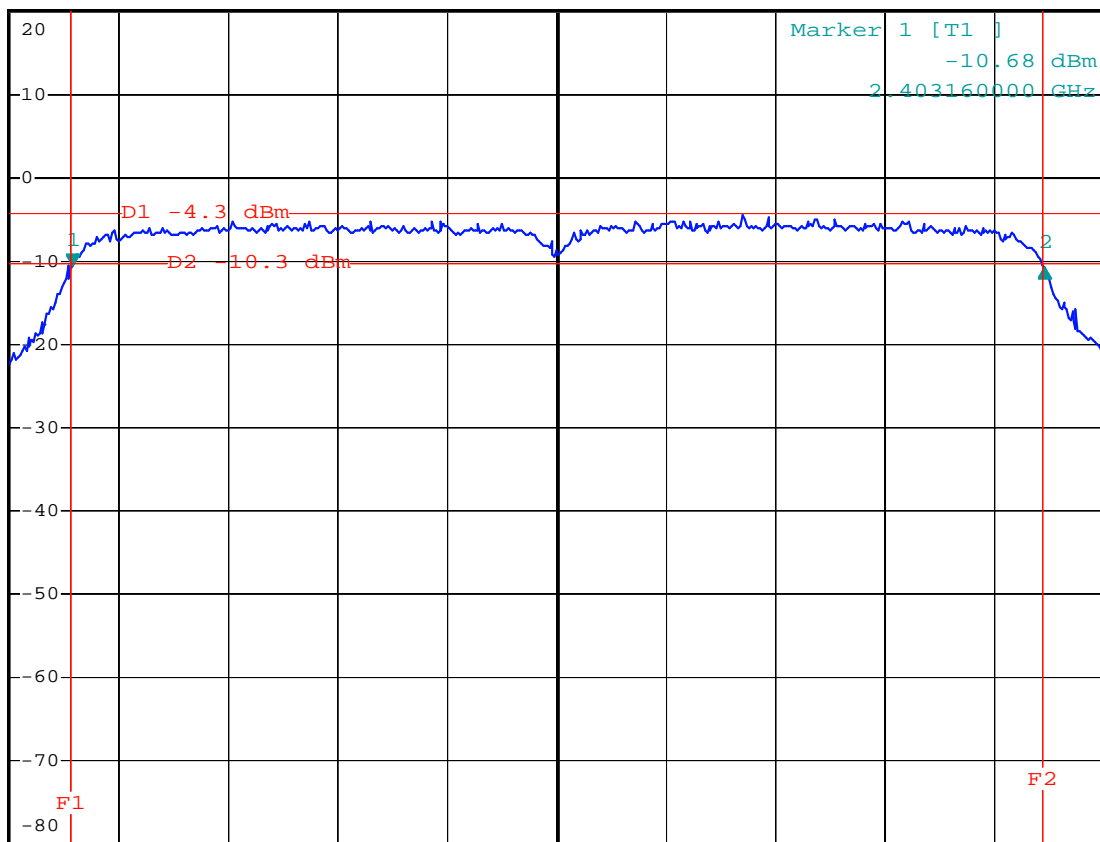

Center 2.412 GHz

2 MHz/

Span 20 MHz

Date: 19.JUN.2012 18:19:55

802.11n Channel Middle 2437MHz(20MHz)



*RBW 300 kHz Delta 2 [T1]
VEW 1 MHz -0.17 dB
SWT 2.5 ms 17.760000000 MHz

Ref 20 dBm

Att 50 dB

1 PK
MAXH

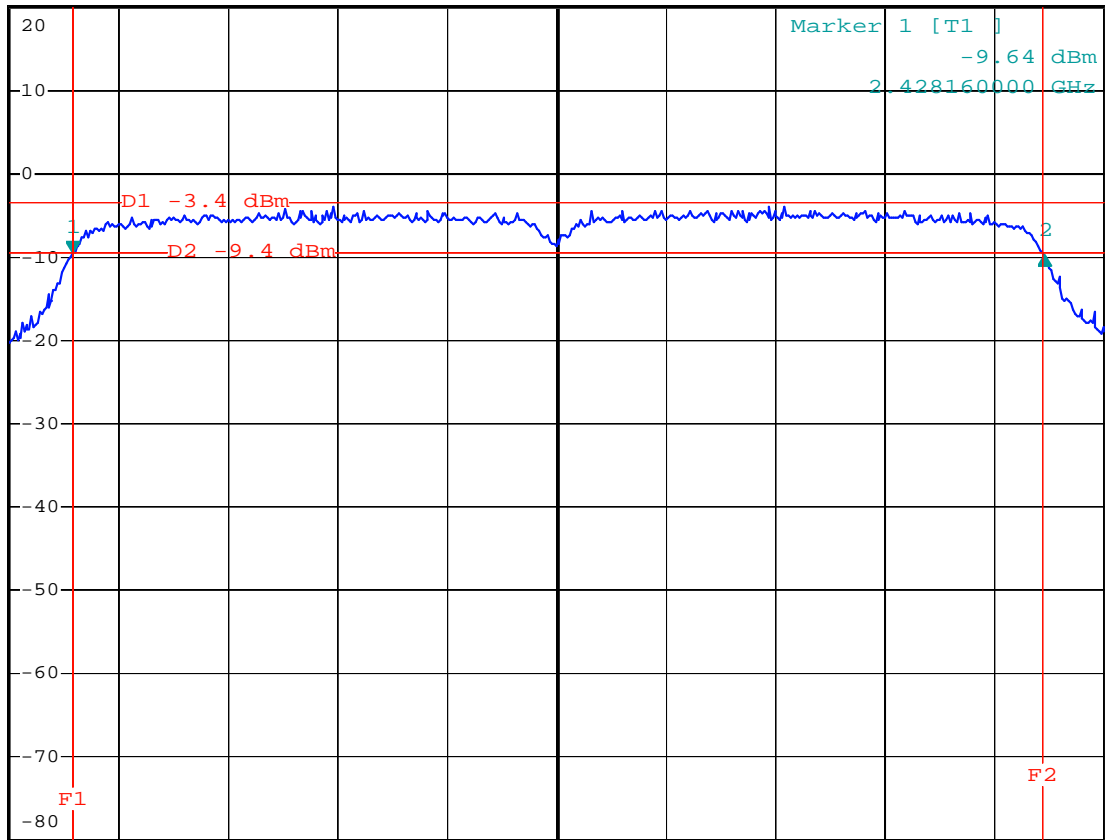

Center 2.437 GHz

2 MHz/

Span 20 MHz

Date: 19.JUN.2012 18:23:26

802.11n Channel High 2462MHz(20MHz)



*RBW 300 kHz Delta 2 [T1]
VEW 1 MHz -0.19 dB
SWT 2.5 ms 17.760000000 MHz

Ref 20 dBm

Att 50 dB

1 PK
MAXH

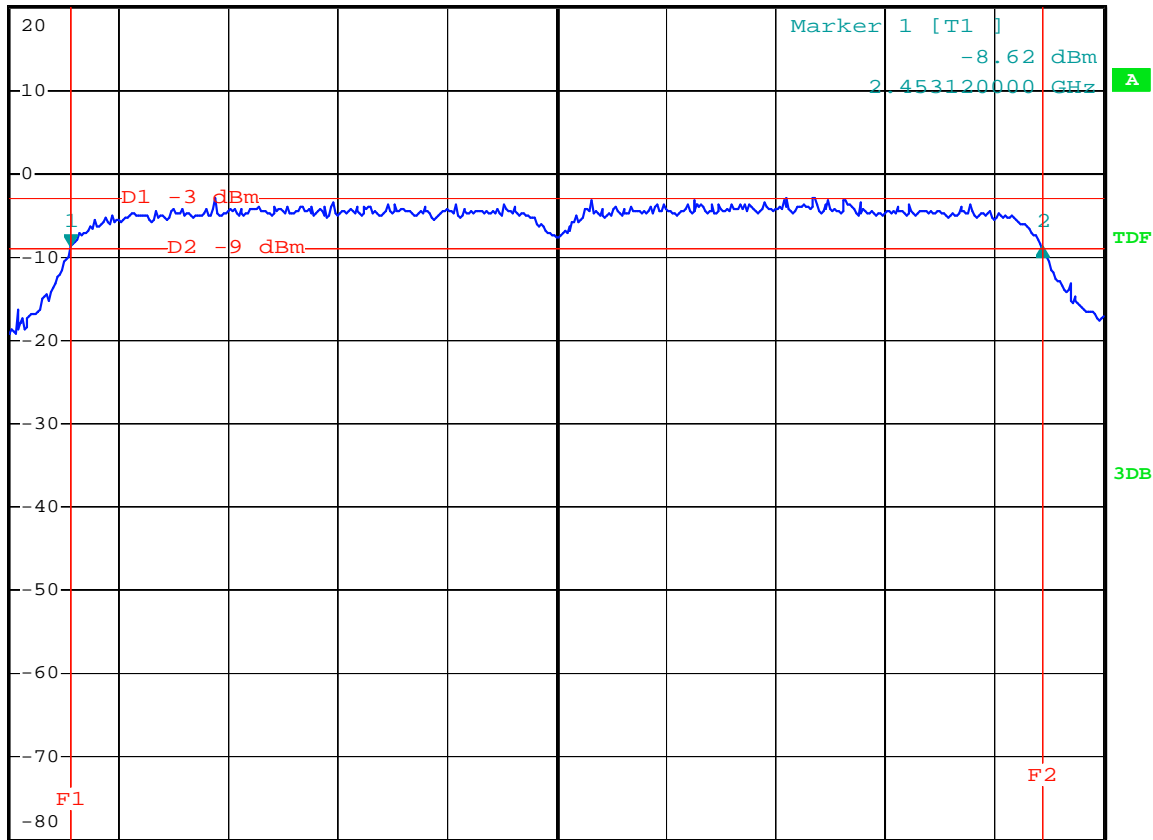

Center 2.462 GHz

2 MHz/

Span 20 MHz

Date: 19.JUN.2012 18:27:07

802.11n Channel Low 2422MHz (40MHz)



*RBW 1 MHz Delta 2 [T1]
VEW 3 MHz -0.43 dB
SWT 2.5 ms 36.400000000 MHz

Ref 20 dBm

Att 50 dB

1 PK
MAXH

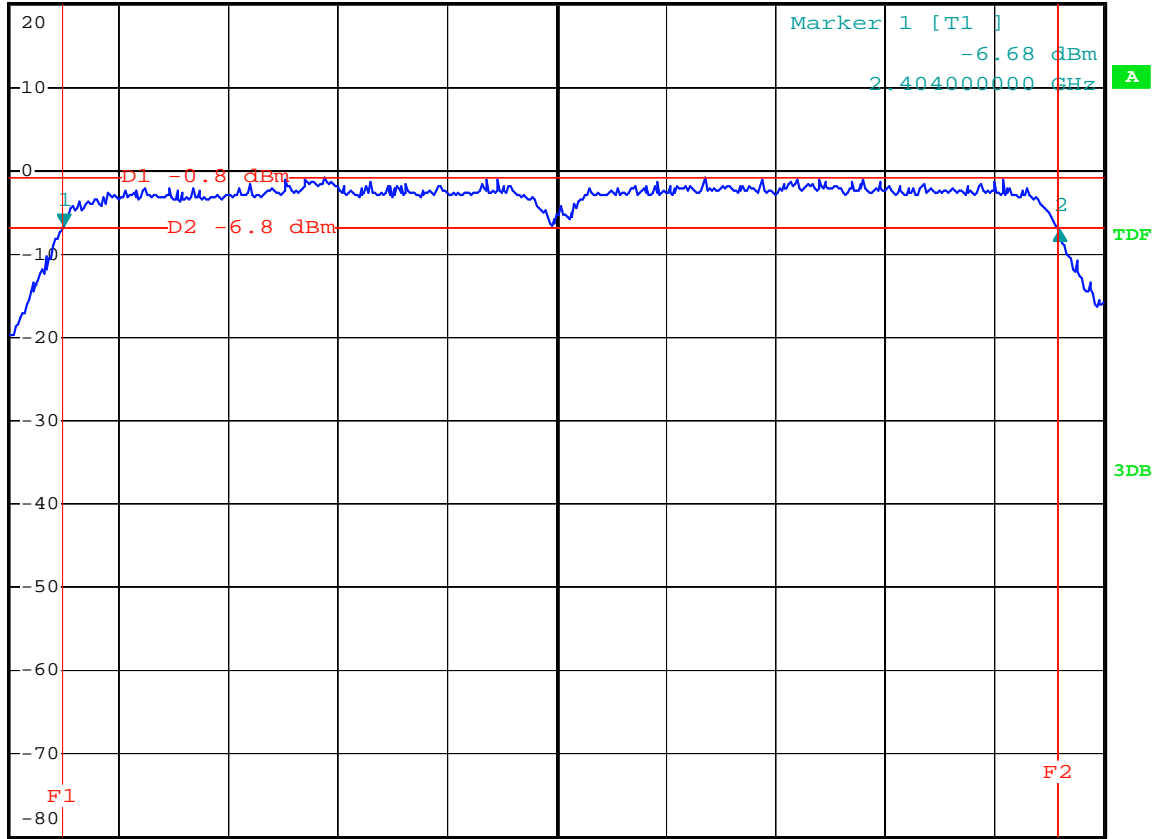

Center 2.422 GHz

4 MHz/

Span 40 MHz

Date: 19.JUN.2012 18:30:15

802.11n Channel Middle 2437MHz(40MHz)



*RBW 1 MHz Delta 2 [T1]
VEW 3 MHz -0.54 dB
SWT 2.5 ms 36.480000000 MHz

Ref 20 dBm

Att 50 dB

1 PK
MAXH

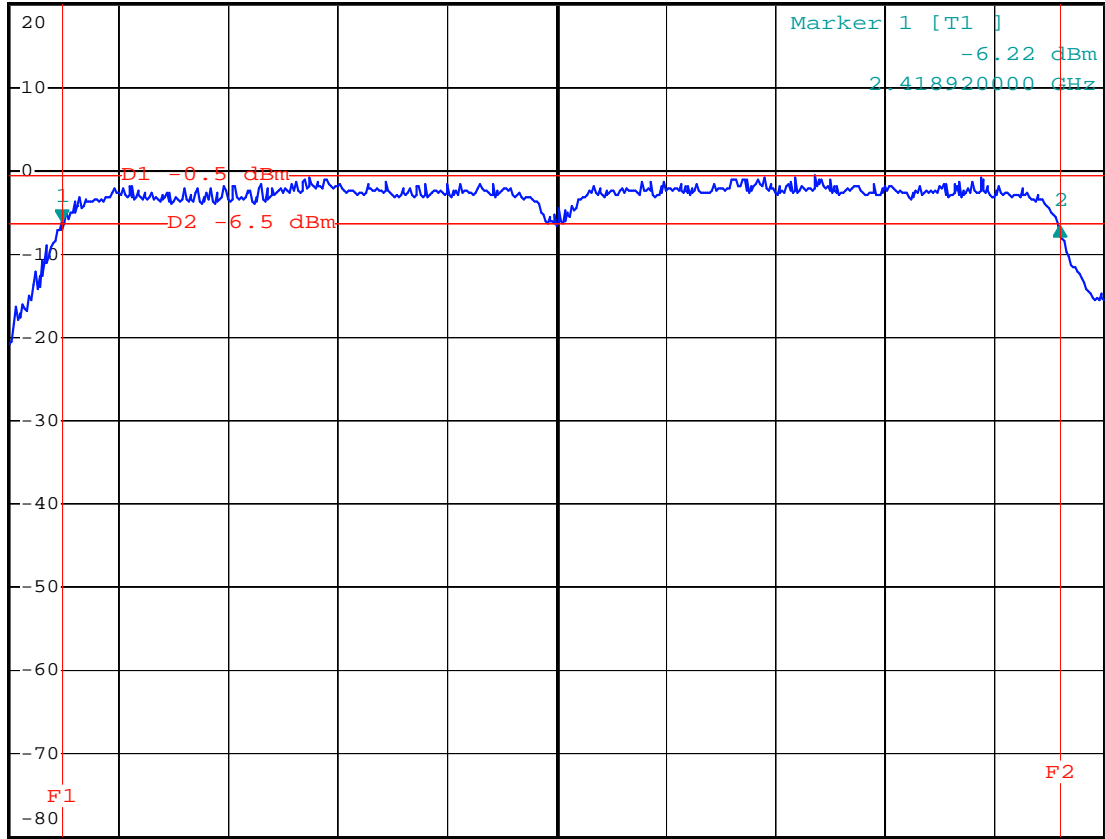

Center 2.437 GHz

4 MHz/

Span 40 MHz

Date: 19.JUN.2012 18:34:16

802.11n Channel High 2452MHz(40MHz)



*RBW 1 MHz Delta 2 [T1]
VEW 3 MHz 0.67 dB
SWT 2.5 ms 36.640000000 MHz

Ref 20 dBm

Att 50 dB

1 PK
MAXH

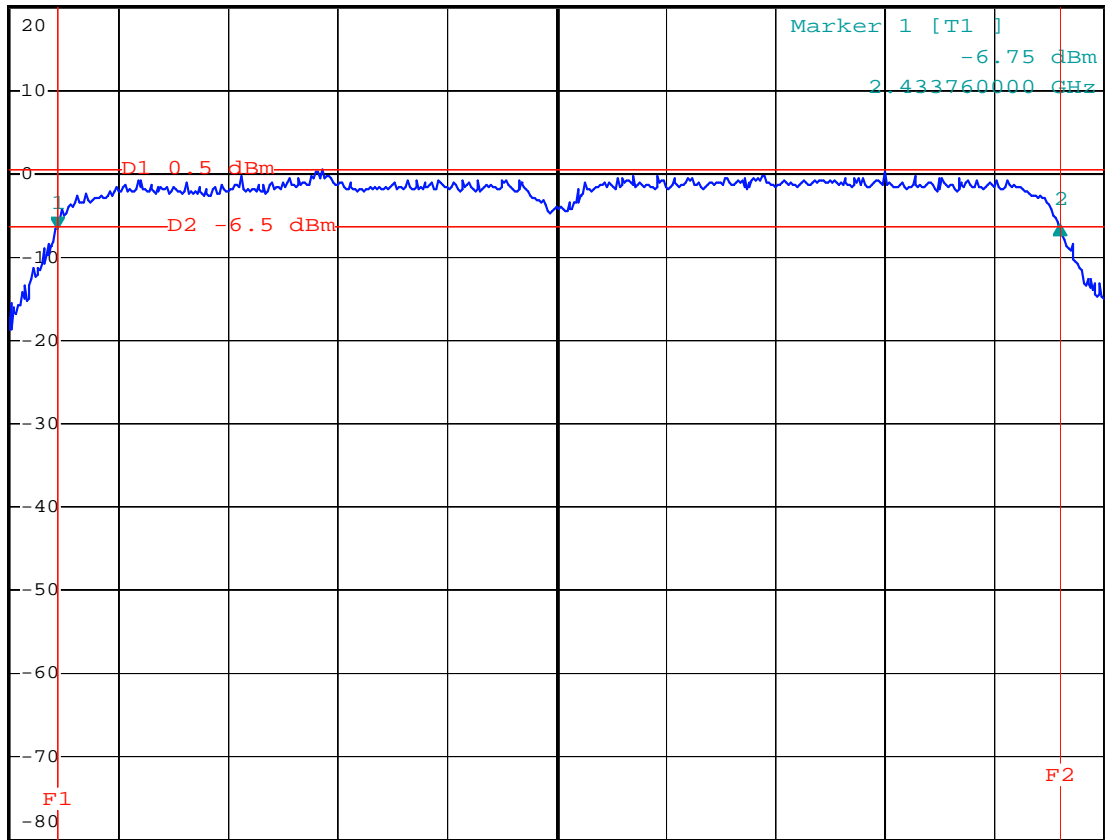

Center 2.452 GHz

4 MHz/

Span 40 MHz

Date: 19.JUN.2012 18:36:53

6. MAXIMUM PEAK OUTPUT POWER

6.1. Block Diagram of Test Setup

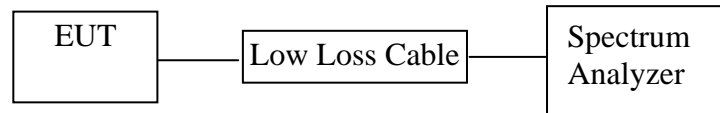

(EUT: TV BOX)

6.2. The Requirement For Section 15.247(b)(3)

Section 15.247(b)(3): For systems using digital modulation in the 902-928MHz, 2400-2483.5MHz, and 5725-5850MHz bands: 1 Watt.

6.3. EUT Configuration on Measurement

The following equipment are installed on the emission Measurement to meet the commission requirements and operating regulations in a manner which tends to maximize its emission characteristics in normal application.

6.3.1. TV BOX (EUT)

Model Number : IS-TV1200K
 Serial Number : N/A
 Manufacturer : SWAGTEK

6.4. Operating Condition of EUT

6.4.1. Setup the EUT and simulator as shown as Section 6.1.

6.4.2. Turn on the power of all equipment.

6.4.3. Let the EUT work in TX modes measure it. The transmit frequency are 2412-2462 and 2422-2452MHz. We select 2412MHz, 2437MHz, 2462MHz and 2422MHz, 2437MHz, 2452MHz TX frequency to transmit.

6.5. Test Procedure

6.5.1. The EUT was tested according to DTS test procedure of January 18, 2012 KDB558074 for compliance to FCC 47CFR 15.247 requirements.

6.5.2. The transmitter output was connected to the spectrum analyzer through a low loss cable.

6.5.3. Set RBW of spectrum analyzer to 1MHz and VBW to 3MHz.

6.5.4. Measurement the maximum peak output power.

6.6. Test Result

PASS.

Date of Test:	<u>June 20, 2012</u>	Temperature:	<u>25°C</u>
EUT:	<u>TV BOX</u>	Humidity:	<u>50%</u>
Model No.:	<u>IS-TV1200K</u>	Power Supply:	<u>AC 120V/60HZ</u>
Test Mode:	<u>TX</u>	Test Engineer:	<u>Pei</u>

The test was performed with 802.11b				
Channel	Frequency (MHz)	Peak Output Power (dBm)	Peak Output Power (mW)	Limits dBm / W
Low	2412	10.69	11.72	30 dBm / 1 W
Middle	2437	10.23	10.54	30 dBm / 1 W
High	2462	9.72	9.38	30 dBm / 1 W

The test was performed with 802.11g				
Channel	Frequency (MHz)	Peak Output Power (dBm)	Peak Output Power (mW)	Limits dBm / W
Low	2412	11.24	13.30	30 dBm / 1 W
Middle	2437	11.44	13.80	30 dBm / 1 W
High	2462	11.61	14.49	30 dBm / 1 W

The test was performed with 802.11n (20MHz)				
Channel	Frequency (MHz)	Peak Output Power (dBm)	Peak Output Power (mW)	Limits dBm / W
Low	2412	11.34	13.61	30 dBm / 1 W
Middle	2437	11.38	13.74	30 dBm / 1 W
High	2462	11.61	14.48	30 dBm / 1 W

The test was performed with 802.11n (40MHz)				
Channel	Frequency (MHz)	Peak Output Power (dBm)	Peak Output Power (mW)	Limits dBm / W
Low	2422	12.60	18.19	30 dBm / 1 W
Middle	2437	12.12	16.29	30 dBm / 1 W
High	2452	12.56	18.03	30 dBm / 1 W

The spectrum analyzer plots are attached as below.

802.11b Channel Low 2412MHz

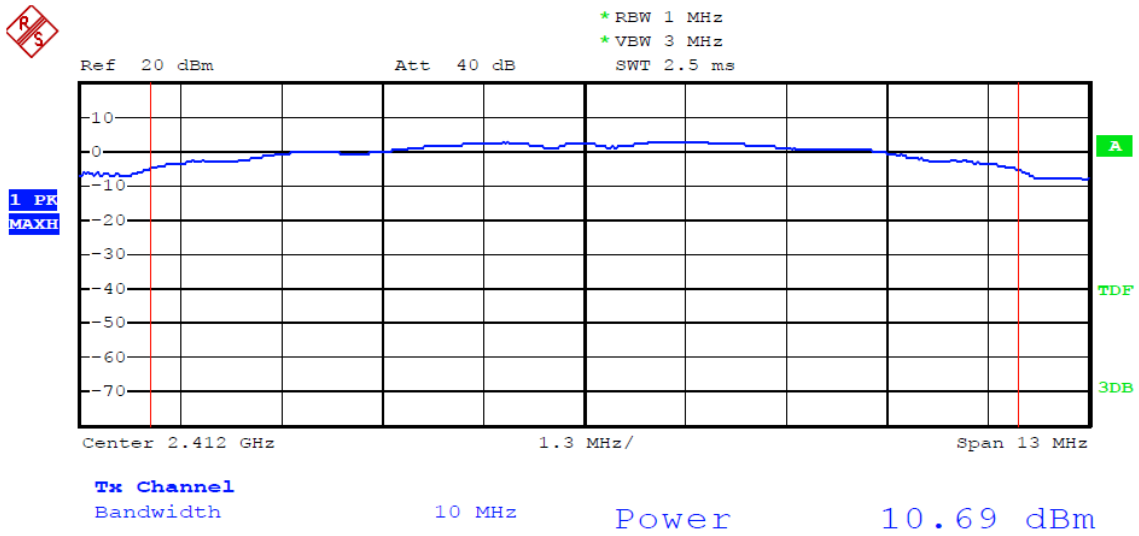

Date: 20.JUN.2012 13:38:36

802.11b Channel Middle 2437MHz

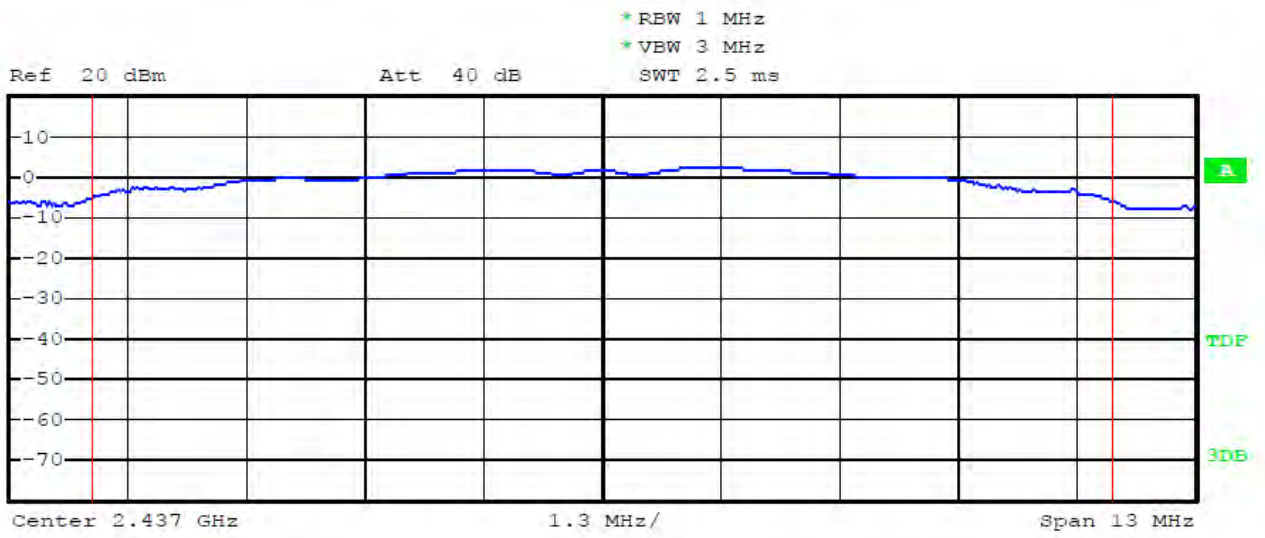

Tx Channel
Bandwidth 10 MHz Power 10.23 dBm

Date: 20.JUN.2012 13:37:57

802.11b Channel High 2462MHz

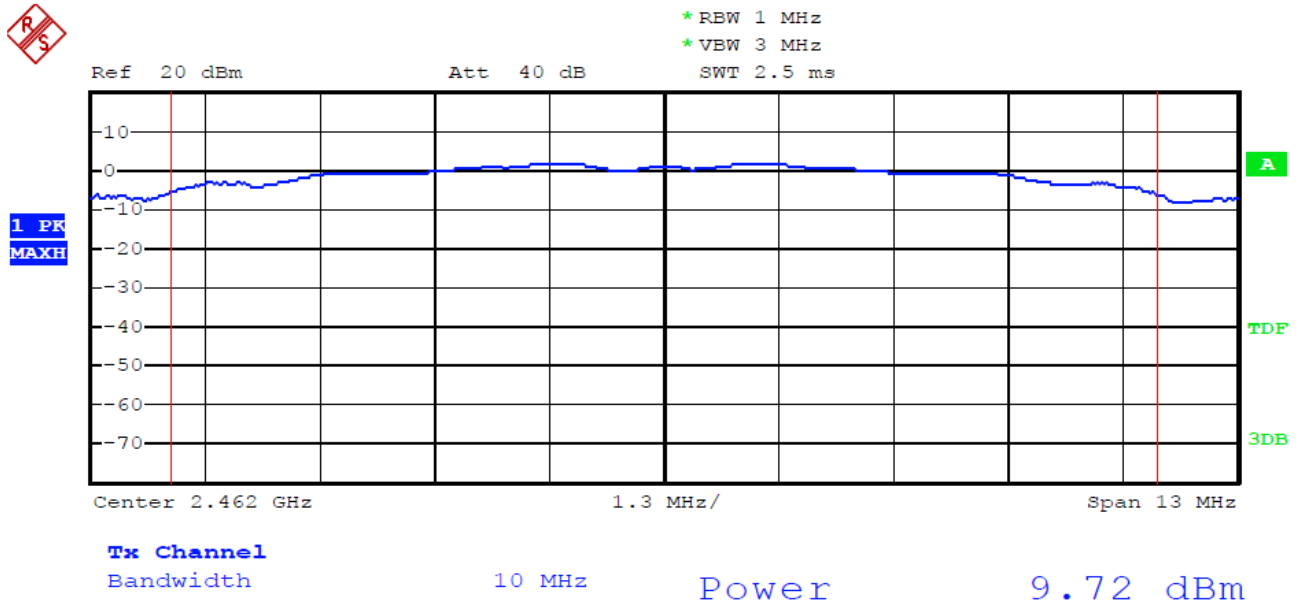

Date: 20.JUN.2012 13:37:13

802.11g Channel Low 2412MHz



* RBW 1 MHz
* VBW 3 MHz
* SWT 2.5 ms

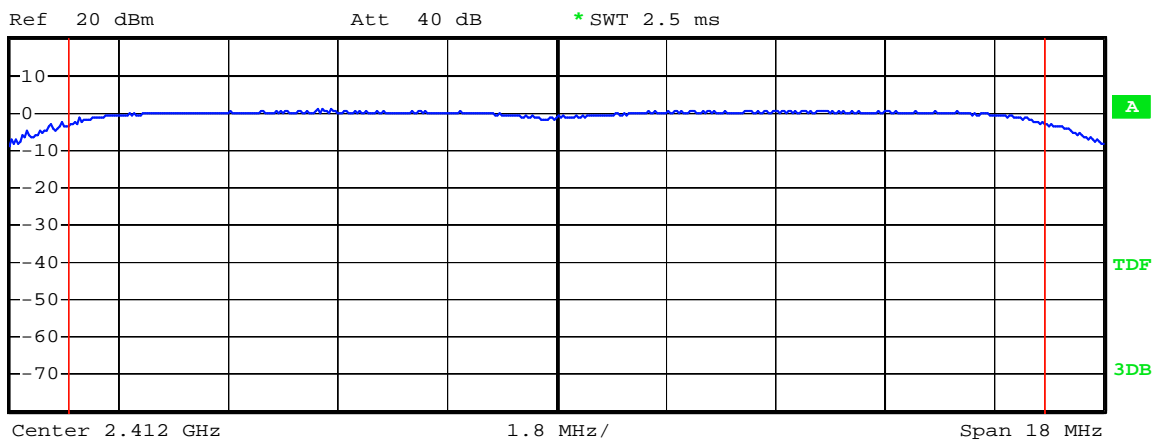

Tx Channel
Bandwidth 16 MHz Power 11.24 dBm

Date: 20.JUN.2012 18:18:02

802.11g Channel Middle 2437MHz



* RBW 1 MHz
* VBW 3 MHz
* SWT 2.5 ms

Ref 20 dBm

Att 40 dB

1 PK
MAXH

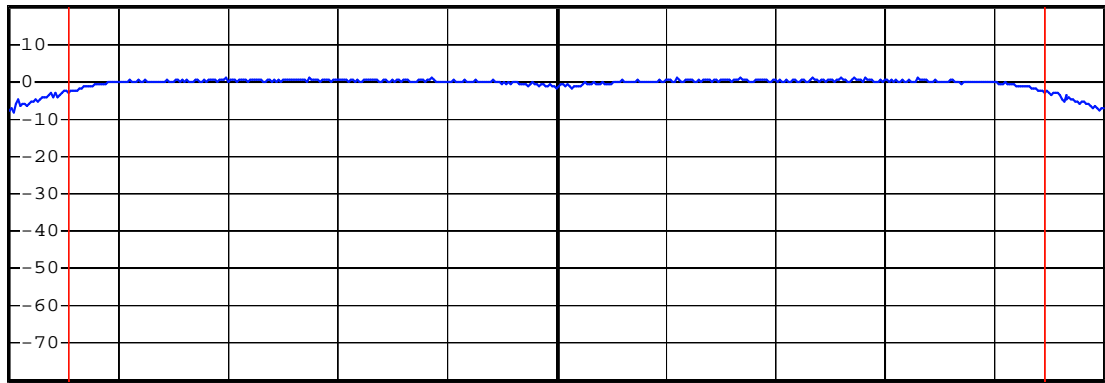

Center 2.437 GHz

1.8 MHz/

Span 18 MHz

Tx Channel

Bandwidth

16 MHz

Power

11.44 dBm

Date: 20.JUN.2012 18:17:20

802.11g Channel High 2462MHz



* RBW 1 MHz
* VBW 3 MHz
* SWT 2.5 ms

Ref 20 dBm

Att 40 dB

1 PK
MAXH

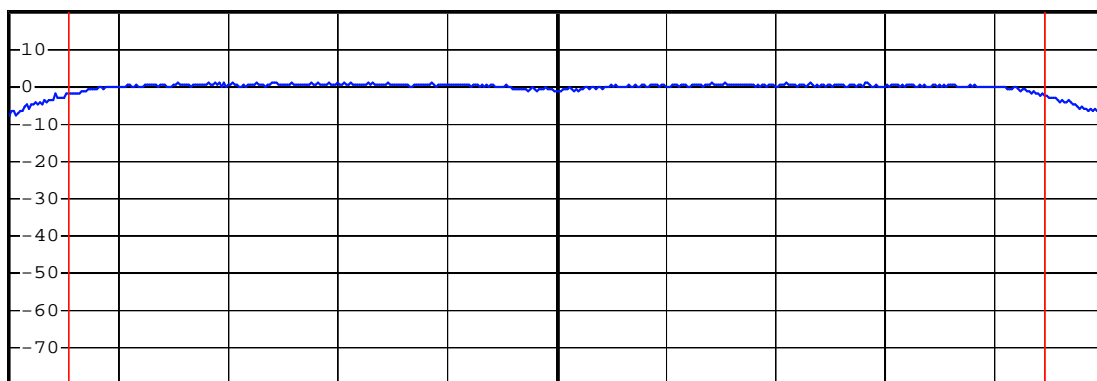

Center 2.462 GHz

1.8 MHz/

Span 18 MHz

Tx Channel

Bandwidth

16 MHz

Power

11.61 dBm

Date: 20.JUN.2012 18:16:27

802.11n Channel Low 2412MHz (20MHz)

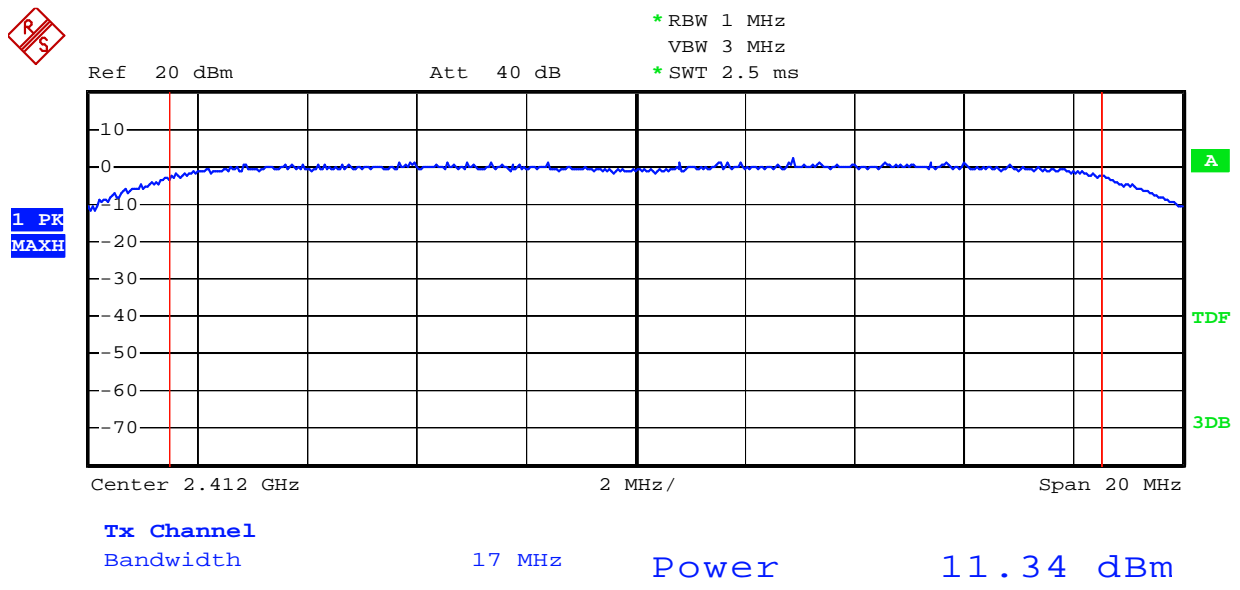

Date: 20.JUN.2012 18:41:58

802.11n Channel Middle 2437MHz (20MHz)



* RBW 1 MHz
* VBW 3 MHz
* SWT 2.5 ms

Ref 20 dBm

Att 40 dB

1 PK
MAXH

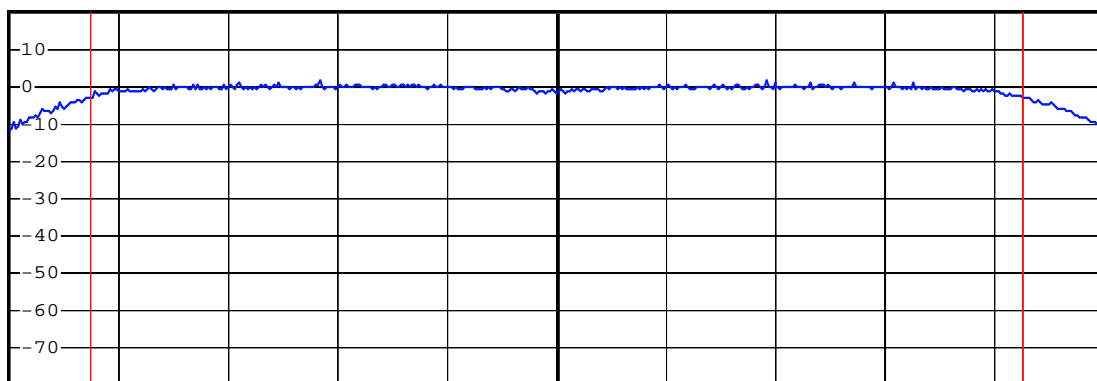

Center 2.437 GHz

2 MHz/

Span 20 MHz

Tx Channel

Bandwidth

17 MHz

Power

11.38 dBm

Date: 20.JUN.2012 18:40:48

802.11n Channel High 2462MHz (20MHz)

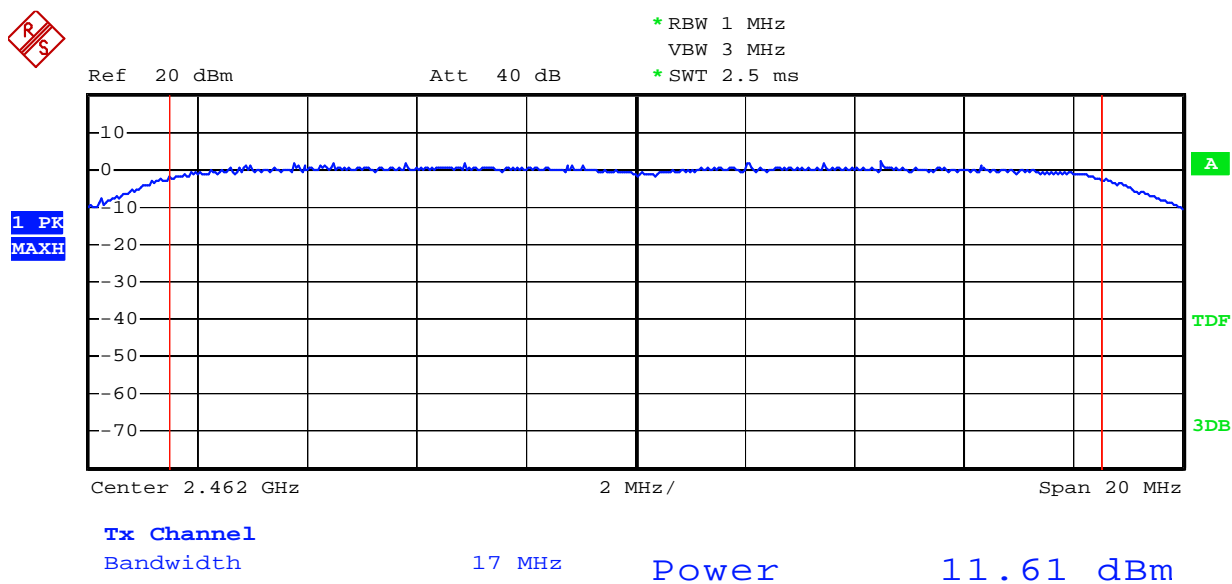

Date: 20.JUN.2012 18:39:52

802.11n Channel Low 2422MHz (40MHz)

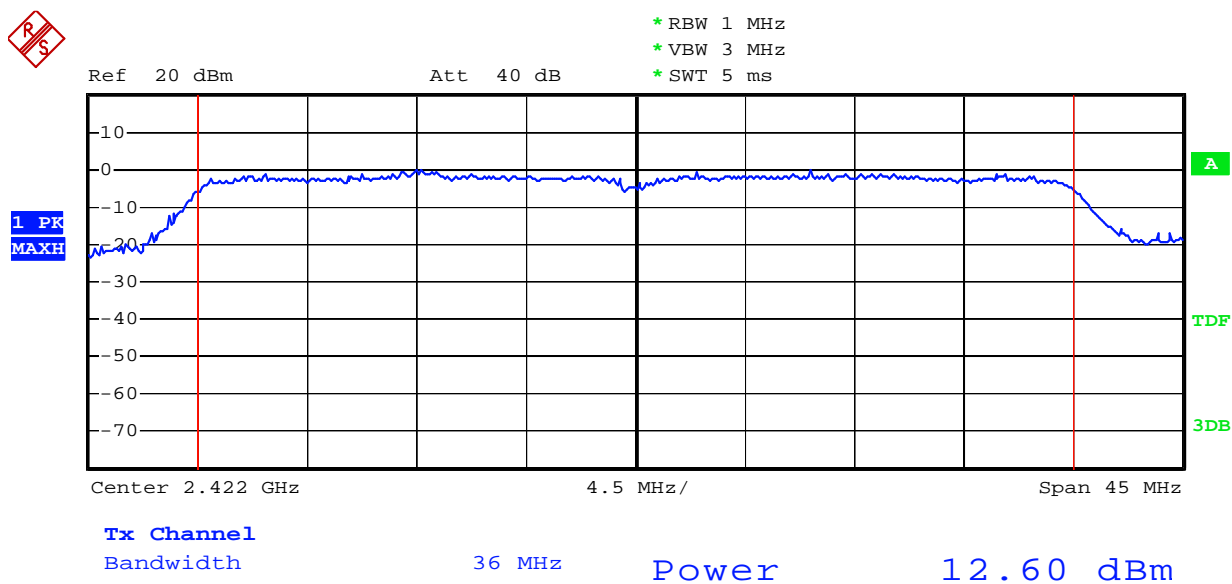

Date: 20.JUN.2012 19:13:03

802.11n Channel Middle 2437MHz (40MHz)

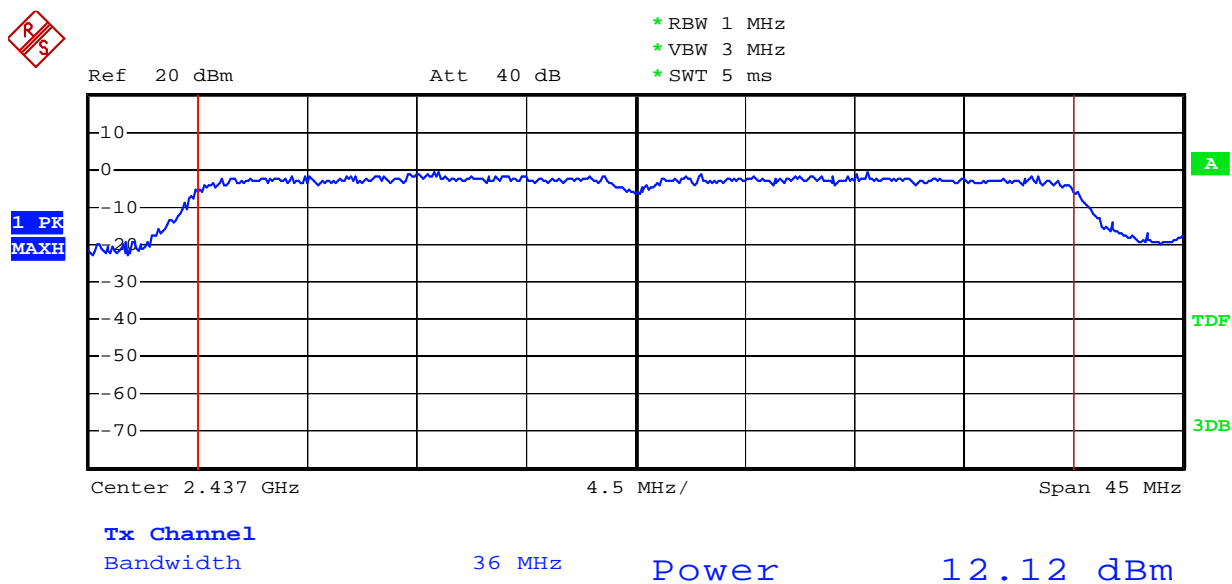

Date: 20.JUN.2012 19:12:03

802.11n Channel High 2452MHz (40MHz)

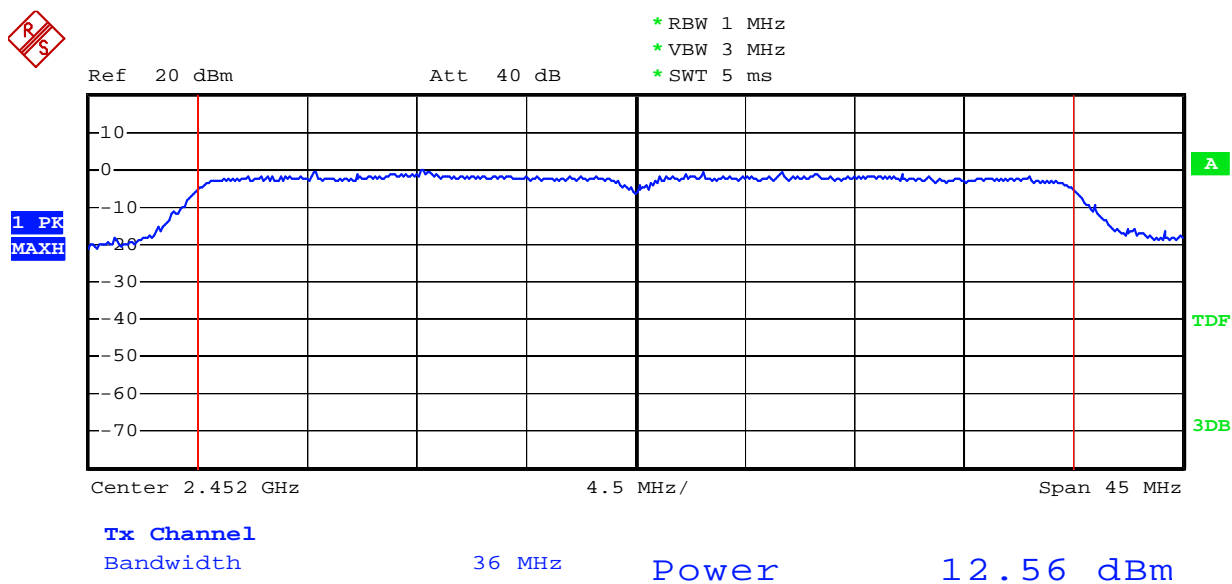

Date: 20.JUN.2012 19:10:20

7. POWER SPECTRAL DENSITY MEASUREMENT

7.1. Block Diagram of Test Setup



(EUT: TV BOX)

7.2. The Requirement For Section 15.247(e)

Section 15.247(e): For digitally modulated systems, the power spectral density conducted from the intentional radiator to the antenna shall not be greater than 8 dBm in any 3 kHz band during any time interval of continuous transmission.

7.3. EUT Configuration on Measurement

The following equipment are installed on the emission Measurement to meet the commission requirements and operating regulations in a manner which tends to maximize its emission characteristics in normal application.

7.3.1. TV BOX (EUT)

Model Number : IS-TV1200K
 Serial Number : N/A
 Manufacturer : SWAGTEK

7.4. Operating Condition of EUT

7.4.1. Setup the EUT and simulator as shown as Section 7.1.

7.4.2. Turn on the power of all equipment.

7.4.3. Let the EUT work in TX modes measure it. The transmit frequency are 2412-2462 and 2422-2452MHz. We select 2412MHz, 2437MHz, 2462MHz and 2422MHz, 2437MHz, 2452MHz TX frequency to transmit.

7.5. Test Procedure

- 7.5.1. The EUT was tested according to DTS test procedure of January 18, 2012 KDB558074 for compliance to FCC 47CFR 15.247 requirements.
- 7.5.2. The transmitter output was connected to the spectrum analyzer through a low loss cable.
- 7.5.3. Measurement Procedure PKPSD:
1. Use this procedure when the maximum peak conducted output power in the fundamental emission is used to demonstrate compliance.
 2. Set the RBW = 100 kHz.
 3. Set the VBW \geq 300 kHz.
 4. Set the span to 5-30 % greater than the EBW.
 5. Detector = peak.
 6. Sweep time = auto couple.
 7. Trace mode = max hold.
 8. Allow trace to fully stabilize.
 9. Use the peak marker function to determine the maximum power level in any 100 kHz band segment within the fundamental EBW.
 10. Scale the observed power level to an equivalent value in 3 kHz by adjusting (reducing) the measured power by a bandwidth correction factor (BWCF) where $BWCF = 10\log(3 \text{ kHz}/100 \text{ kHz}) = -15.2 \text{ dB}$.
 11. The resulting peak PSD level must be \leq 8 dBm
- 7.5.4. Measurement the maximum power spectral density.

7.6. Test Result

PASS.

Date of Test:	June 20, 2012	Temperature:	25°C
EUT:	TV BOX	Humidity:	50%
Model No.:	IS-TV1200K	Power Supply:	AC 120V/60HZ
Test Mode:	TX	Test Engineer:	Pei

The test was performed with 802.11b

Channel	Frequency (MHz)	Power Spectral Density(dBm/100 kHz)	BWCF factor (100kHz to 3kHz)	Power Spectral Density(dBm/3 kHz)	Limits (dBm)
Low	2412	-1.38	-15.2	-13.82	8 dBm
Middle	2437	-1.42	-15.2	-16.62	8 dBm
High	2462	-2.32	-15.2	-17.52	8 dBm

The test was performed with 802.11g

Channel	Frequency (MHz)	Power Spectral Density(dBm/100 kHz)	BWCF factor (100kHz to 3kHz)	Power Spectral Density(dBm/3 kHz)	Limits (dBm)
Low	2412	-7.93	-15.2	-23.13	8 dBm
Middle	2437	-7.54	-15.2	-22.74	8 dBm
High	2462	-7.19	-15.2	-22.39	8 dBm

The test was performed with 802.11n (20MHz)

Channel	Frequency (MHz)	Power Spectral Density(dBm/100 kHz)	BWCF factor (100kHz to 3kHz)	Power Spectral Density(dBm/3 kHz)	Limits (dBm)
Low	2412	-7.90	-15.2	-23.10	8 dBm
Middle	2437	-7.47	-15.2	-22.67	8 dBm
High	2462	-7.20	-15.2	-22.40	8 dBm

The test was performed with 802.11n (40MHz)

Channel	Frequency (MHz)	Power Spectral Density(dBm/100 kHz)	BWCF factor (100kHz to 3kHz)	Power Spectral Density(dBm/3 kHz)	Limits (dBm)
Low	2412	-9.47	-15.2	-24.67	8 dBm
Middle	2437	-9.08	-15.2	-24.28	8 dBm
High	2462	-9.34	-15.2	-24.54	8 dBm

The spectrum analyzer plots are attached as below.

802.11b Channel Low 2412MHz

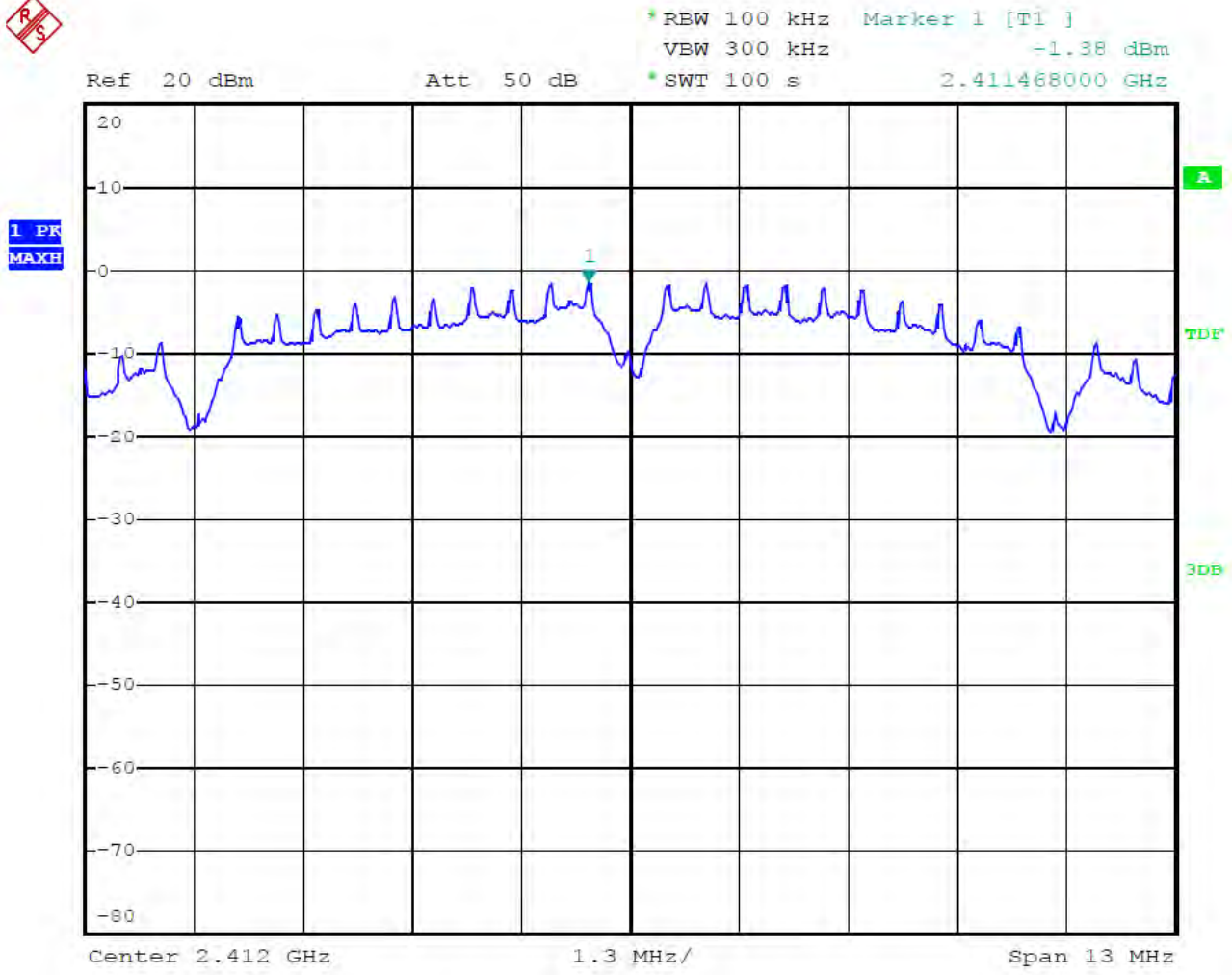

802.11b Channel Middle 2437MHz

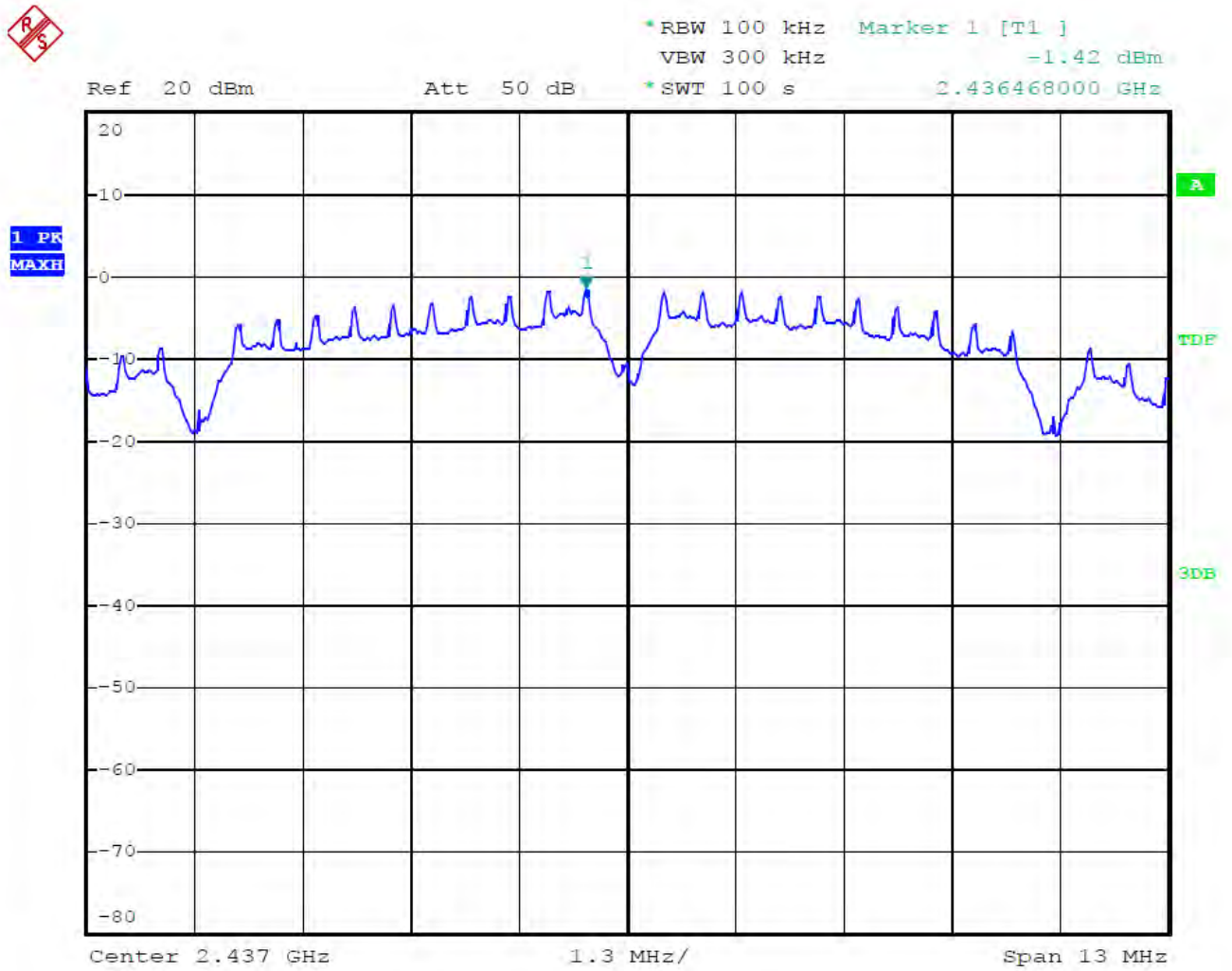

Date: 20.JUN.2012 18:04:54

802.11b Channel High 2462MHz

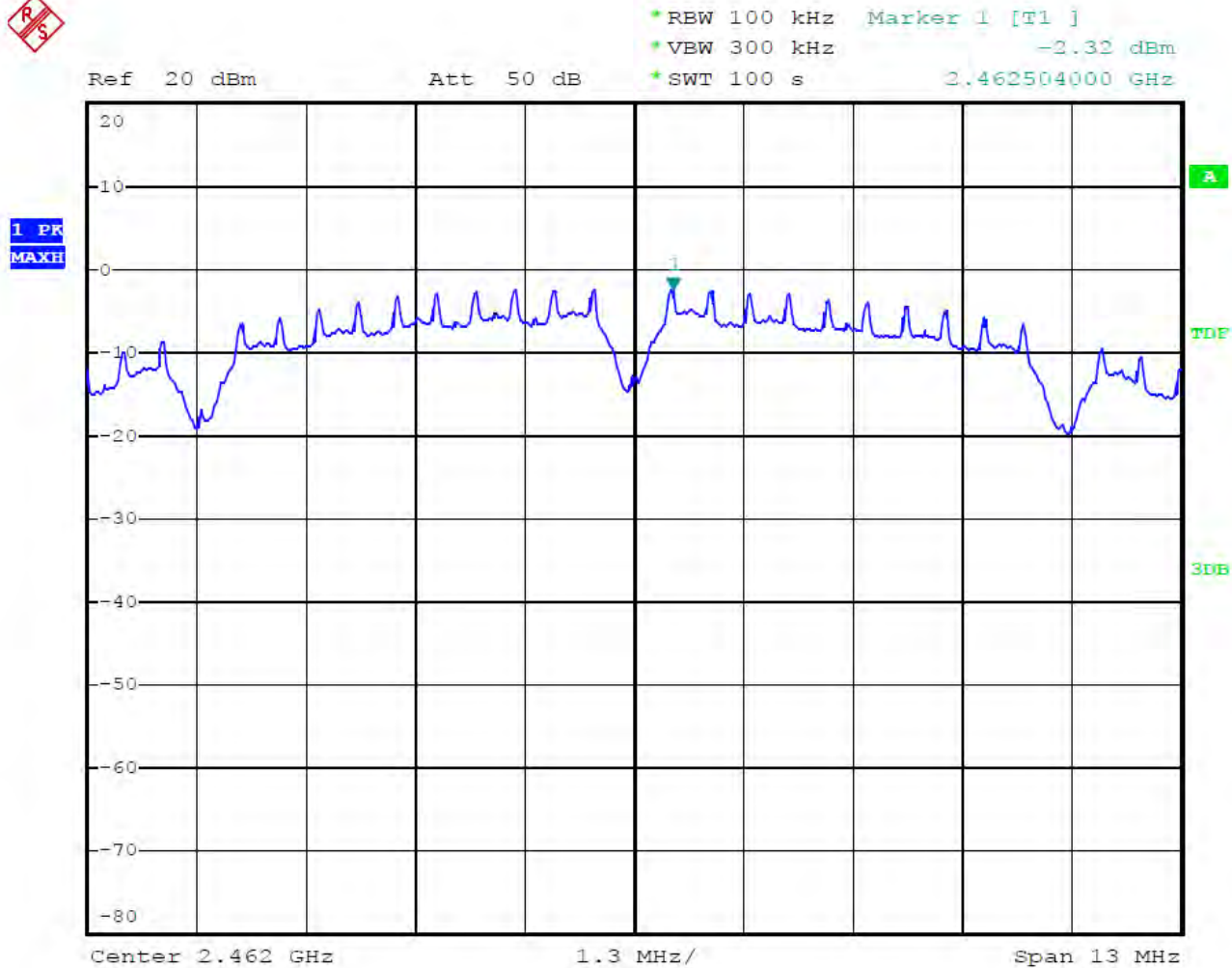

Date: 20.JUN.2012 13:49:24

802.11g Channel Low 2412MHz



*RBW 100 kHz Marker 1 [T1]
VEW 300 kHz -7.93 dBm
*SWT 100 s 2.416968000 GHz

Ref 20 dBm

Att 50 dB

1 PK
MAXH

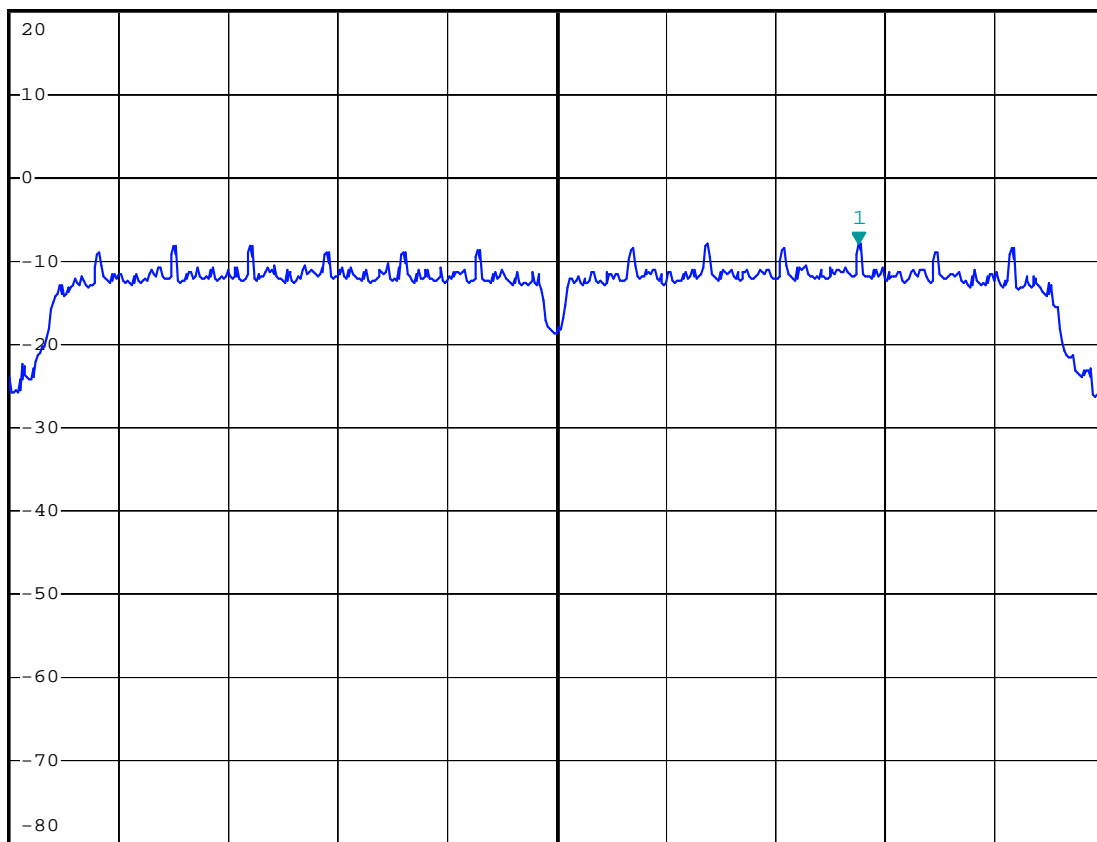

Center 2.412 GHz

1.8 MHz/

Span 18 MHz

Date: 20.JUN.2012 18:32:27

802.11g Channel Middle 2437MHz



*RBW 100 kHz Marker 1 [T1]
VEW 300 kHz -7.54 dBm
*SWT 100 s 2.439484000 GHz

Ref 20 dBm

Att 50 dB

1 PK
MAXH

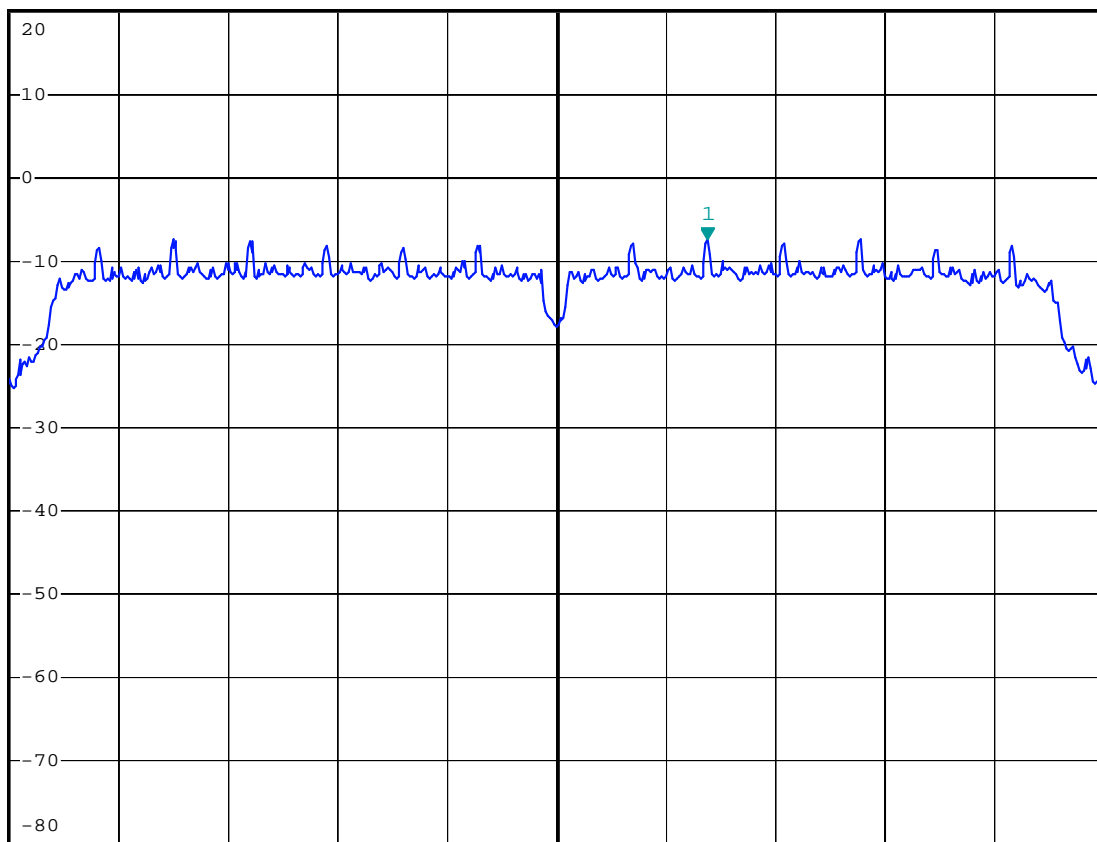

Center 2.437 GHz

1.8 MHz/

Span 18 MHz

Date: 20.JUN.2012 18:28:39

802.11g Channel High 2462MHz



*RBW 100 kHz Marker 1 [T1]
VEW 300 kHz -7.19 dBm
*SWT 100 s 2.466968000 GHz

Ref 20 dBm

Att 50 dB

1 PK
MAXH

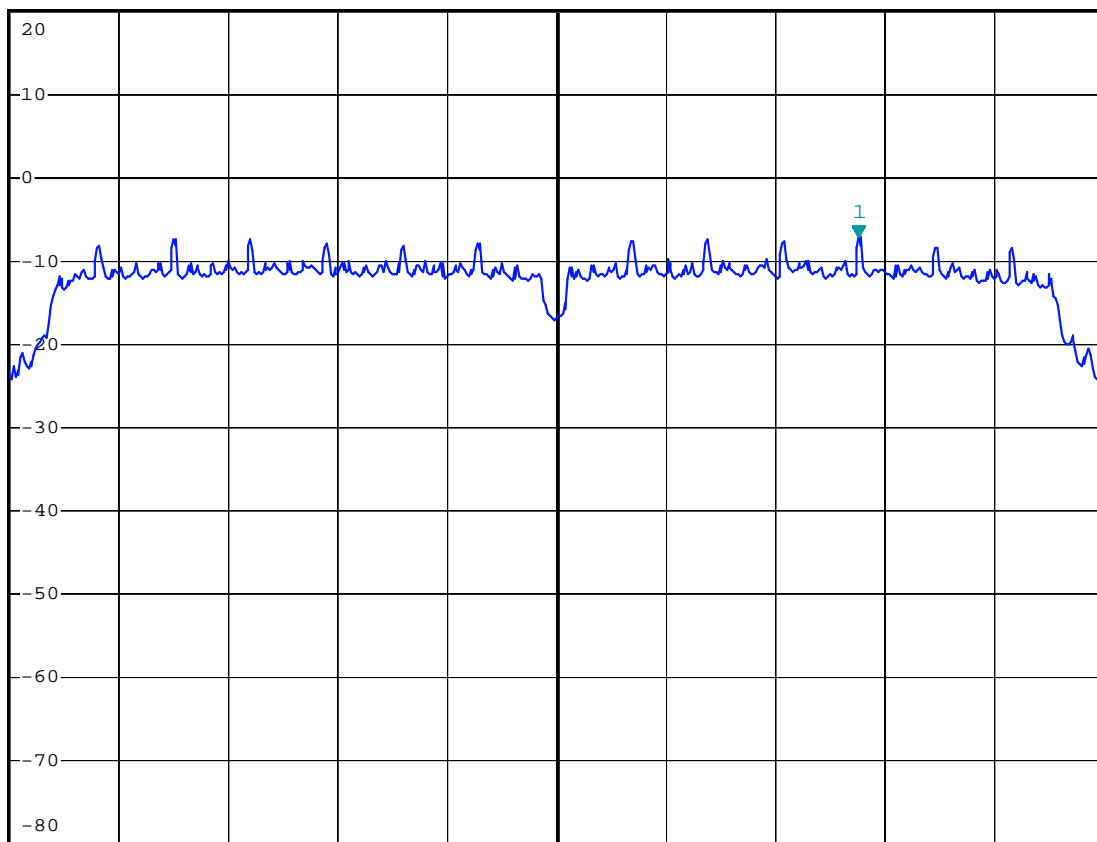

Center 2.462 GHz

1.8 MHz/

Span 18 MHz

Date: 20.JUN.2012 18:24:51

802.11n Channel Low 2412MHz (20MHz)



*RBW 100 kHz Marker 1 [T1]
VEW 300 kHz -7.90 dBm
*SWT 100 s 2.416960000 GHz

Ref 20 dBm

Att 50 dB

1 PK
MAXH

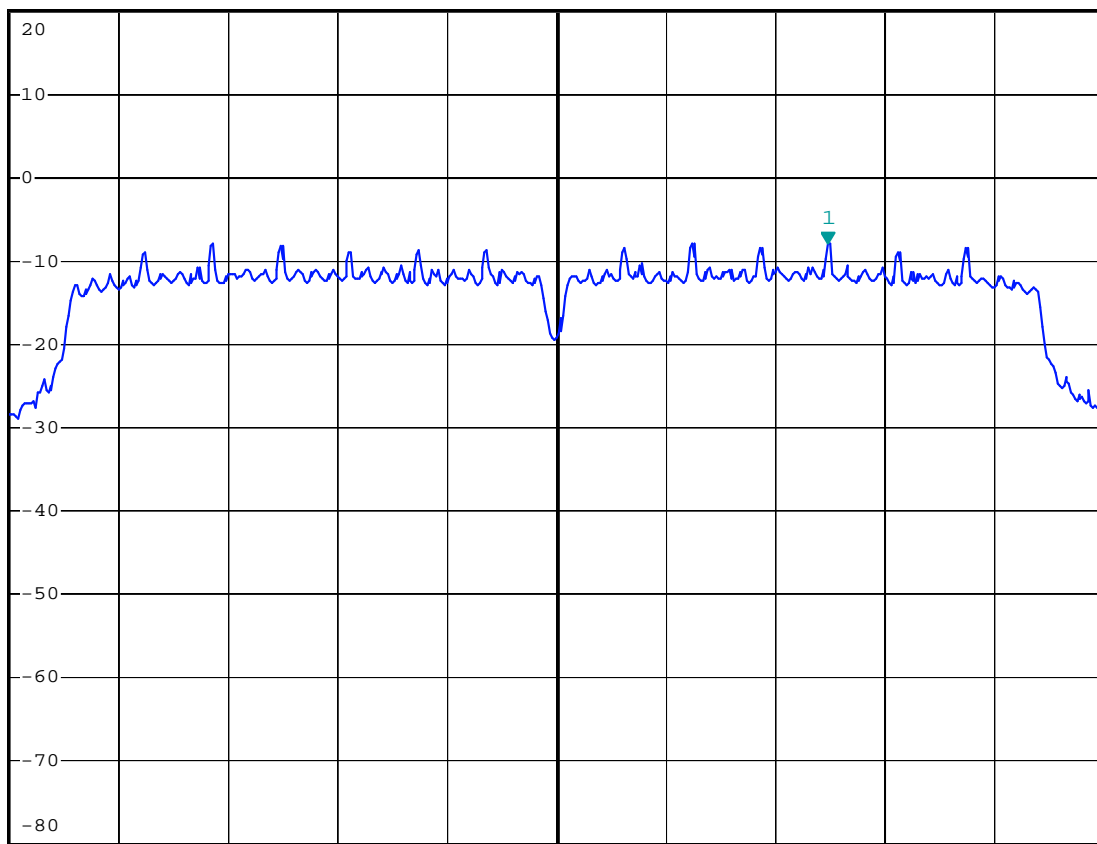

Center 2.412 GHz

2 MHz/

Span 20 MHz

Date: 20.JUN.2012 18:55:54

802.11n Channel Middle 2437MHz (20MHz)



*RBW 100 kHz Marker 1 [T1]
VEW 300 kHz -7.47 dBm
*SWT 100 s 2.439480000 GHz

Ref 20 dBm

Att 50 dB

1 PK
MAXH

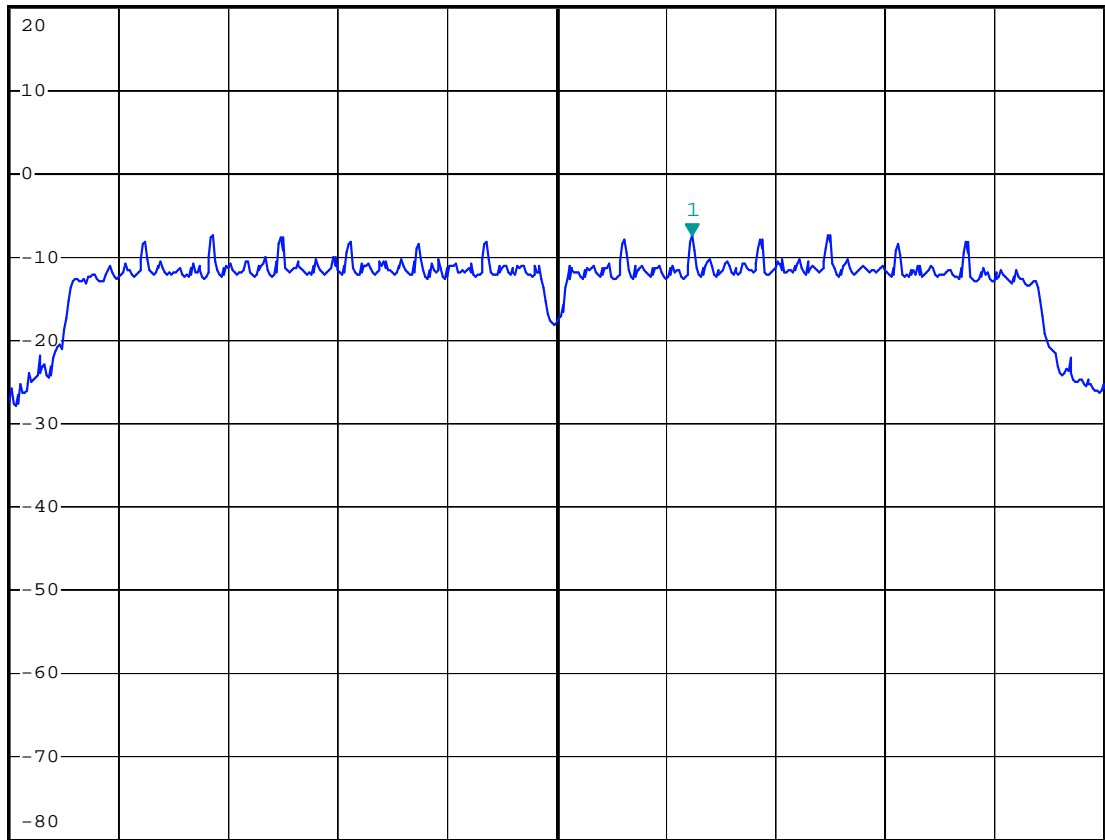

Center 2.437 GHz

2 MHz/

Span 20 MHz

Date: 20.JUN.2012 18:52:07

802.11n Channel High 2462MHz(20MHz)



*RBW 100 kHz Marker 1 [T1]
VEW 300 kHz -7.20 dBm
*SWT 100 s 2.467000000 GHz

Ref 20 dBm

Att 50 dB

1 PK
MAXH

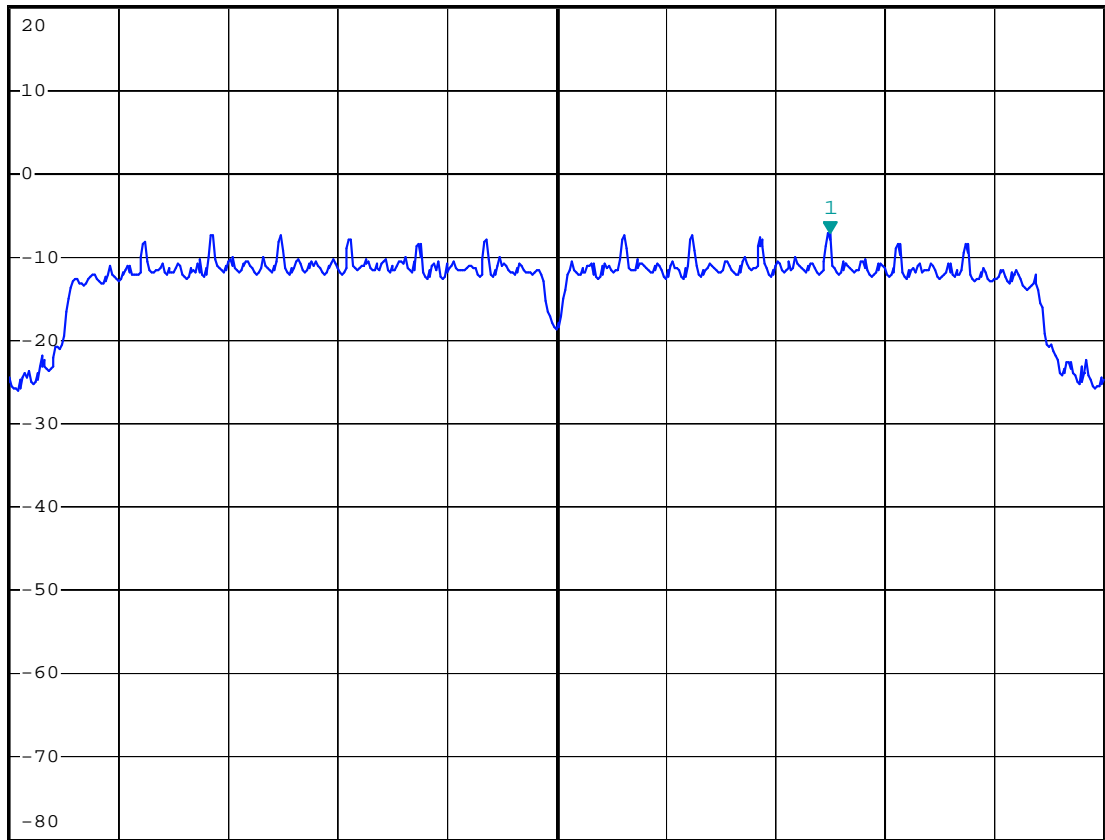

Center 2.462 GHz

2 MHz/

Span 20 MHz

Date: 20.JUN.2012 18:48:08

802.11n Channel Low 2422MHz (40MHz)



*RBW 100 kHz Marker 1 [T1]
*VEW 300 kHz -9.47 dBm
*SWT 100 s 2.426950000 GHz

Ref 20 dBm

Att 50 dB

1 PK
MAXH

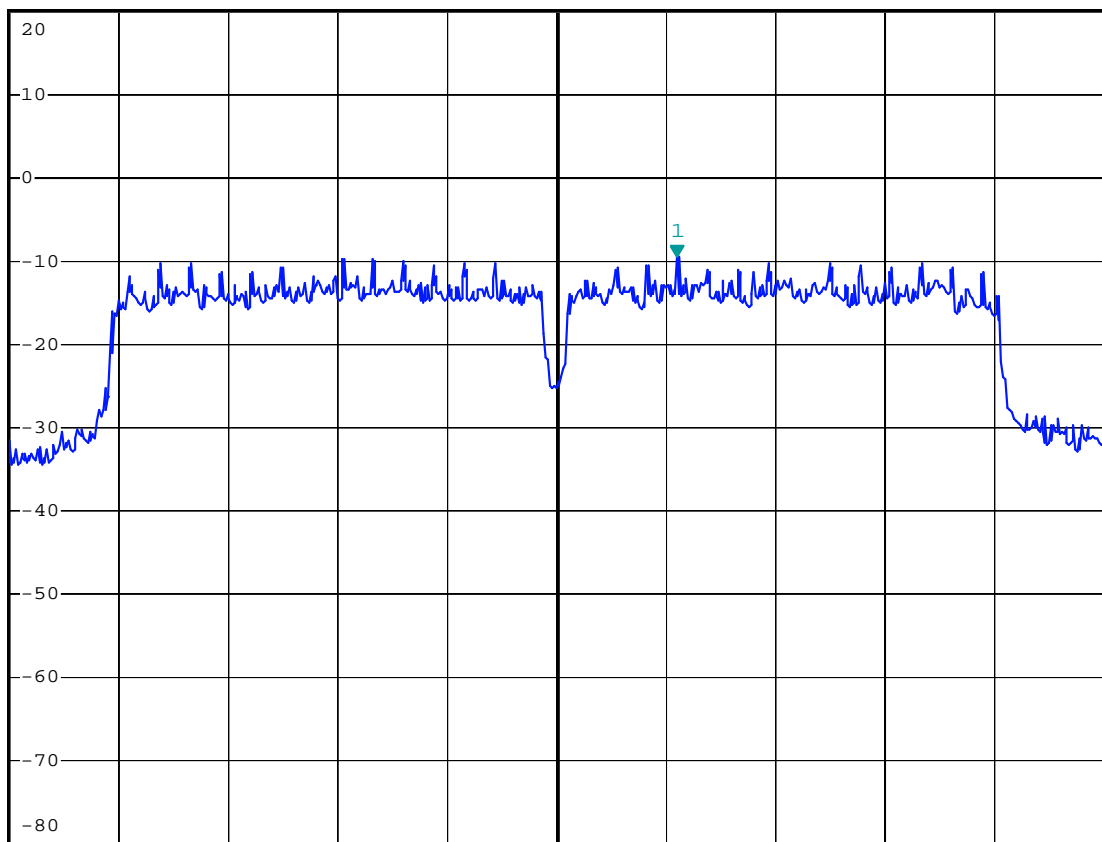

Center 2.422 GHz

4.5 MHz/

Span 45 MHz

Date: 20.JUN.2012 19:29:48

802.11n Channel Middle 2437MHz(40MHz)



*RBW 100 kHz Marker 1 [T1]
*VBW 300 kHz -9.08 dBm
*SWT 100 s 2.441950000 GHz

Ref 20 dBm

Att 50 dB

1 PK
MAXH

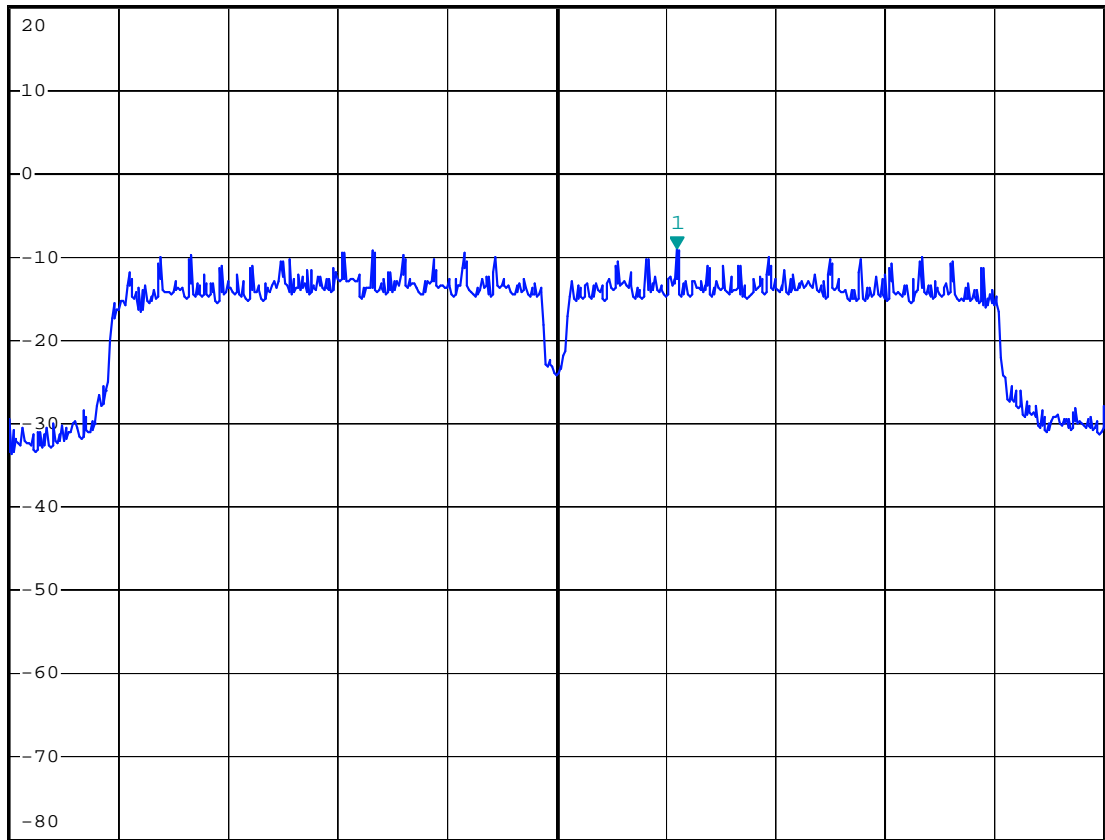

Center 2.437 GHz

4.5 MHz/

Span 45 MHz

Date: 20.JUN.2012 19:25:59

802.11n Channel High 2452MHz(40MHz)



*RBW 100 kHz Marker 1 [T1]
*VBW 300 kHz -9.34 dBm
*SWT 100 s 2.456950000 GHz

Ref 20 dBm

Att 50 dB

1 PK
MAXH

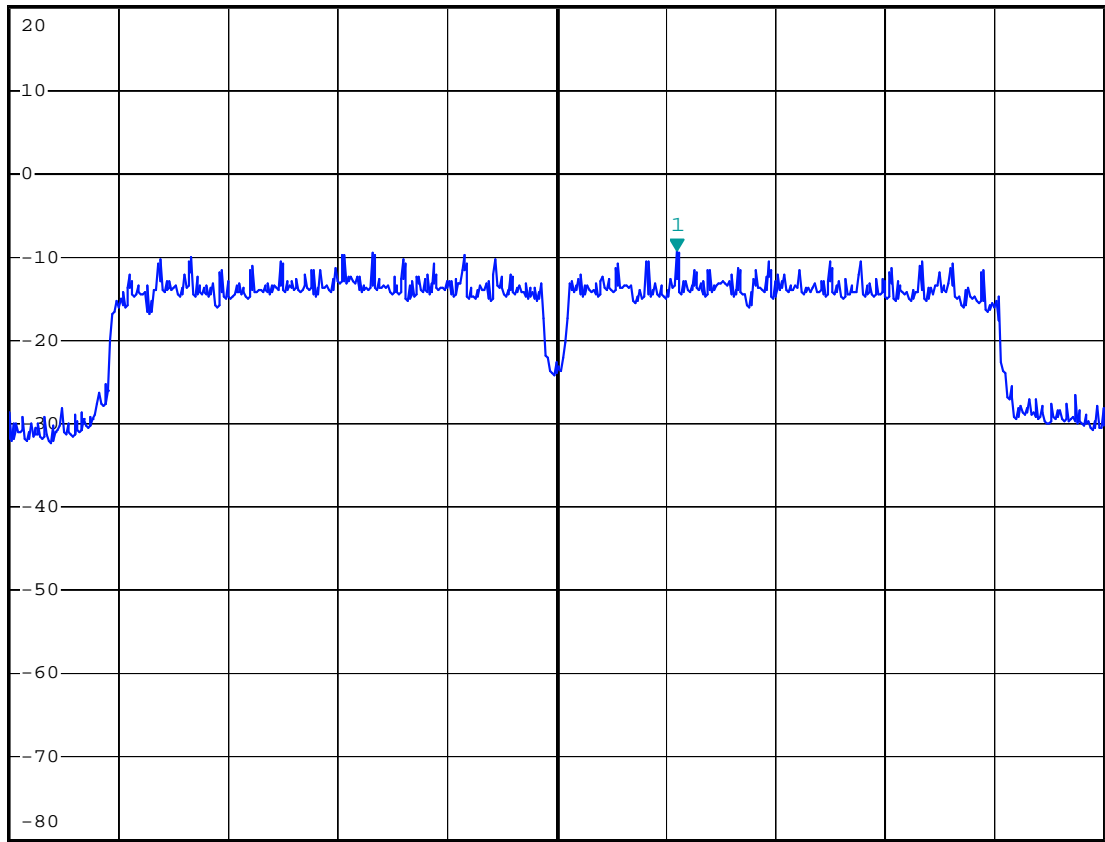

Center 2.452 GHz

4.5 MHz/

Span 45 MHz

Date: 20.JUN.2012 19:22:09

8. BAND EDGE COMPLIANCE TEST

8.1. Block Diagram of Test Setup



(EUT: TV BOX)

8.2. The Requirement For Section 15.247(d)

Section 15.247(d): In any 100 kHz bandwidth outside the frequency band in which the spread spectrum or digitally modulated intentional radiator is operating, the radio frequency power that is produced by the intentional radiator shall be at least 20 dB below that in the 100 kHz bandwidth within the band that contains the highest level of the desired power, based on either an RF conducted or a radiated measurement, provided the transmitter demonstrates compliance with the peak conducted power limits. If the transmitter complies with the conducted power limits based on the use of RMS averaging over a time interval, as permitted under paragraph (b)(3) of this section, the attenuation required under this paragraph shall be 30 dB instead of 20 dB. Attenuation below the general limits specified in Section 15.209(a) is not required. In addition, radiated emissions which fall in the restricted bands, as defined in Section 15.205(a), must also comply with the radiated emission limits specified in Section 15.209(a).

8.3. EUT Configuration on Measurement

The following equipment are installed on the emission Measurement to meet the commission requirements and operating regulations in a manner which tends to maximize its emission characteristics in normal application.

8.3.1. TV BOX (EUT)

Model Number	:	IS-TV1200K
Serial Number	:	N/A
Manufacturer	:	SWAGTEK

8.4. Operating Condition of EUT

8.4.1. Setup the EUT and simulator as shown as Section 8.1.

8.4.2. Turn on the power of all equipment.

8.4.3. Let the EUT work in TX modes measure it. The transmit frequency are 2412-2462 and 2422-2452MHz MHz. We select 2412MHz, 2462MHz and 2422MHz, 2452MHz TX frequency to transmit.

8.5. Test Procedure

Conducted Band Edge:

8.5.1. The transmitter output was connected to the spectrum analyzer via a low loss cable.

8.5.2. Set RBW of spectrum analyzer to 100kHz and VBW to 300kHz.

Radiate Band Edge:

8.5.3. The EUT is placed on a turntable, which is 0.8m above the ground plane and worked at highest radiated power.

8.5.4. The turntable was rotated for 360 degrees to determine the position of maximum emission level.

8.5.5. EUT is set 3m away from the receiving antenna, which is varied from 1m to 4m to find out the highest emission.

8.5.6. Set the spectrum analyzer in the following setting in order to capture the lower and upper band-edges of the emission:

RBW=1MHz, VBW=1MHz

8.5.7. The band edges was measured and recorded.

8.6. Test Result

Pass**Conducted test**

Date of Test:	June 20, 2012	Temperature:	25°C
EUT:	TV BOX	Humidity:	50%
Model No.:	IS-TV1200K	Power Supply:	AC 120V/60HZ
Test Mode:	TX	Test Engineer:	Pei

The test was performed with 802.11b

Frequency (MHz)	Result of Band Edge (dBc)	Limit of Band Edge (dBc)
2412	27.57	> 20dBc
2462	32.70	> 20dBc

The test was performed with 802.11g

Frequency (MHz)	Result of Band Edge (dBc)	Limit of Band Edge (dBc)
2412	24.82	> 20dBc
2462	27.80	> 20dBc

The test was performed with 802.11n (20MHz)

Frequency (MHz)	Result of Band Edge (dBc)	Limit of Band Edge (dBc)
2412	24.96	> 20dBc
2462	27.80	> 20dBc

The test was performed with 802.11n (40MHz)

Frequency (MHz)	Result of Band Edge (dBc)	Limit of Band Edge (dBc)
2422	22.30	> 20dBc
2452	21.35	> 20dBc

802.11b Channel Low 2412MHz



*RBW 100 kHz Delta 2 [T1]
*VBW 300 kHz -27.57 dB
SWT 10 ms -13.440000000 MHz

Ref 20 dBm

Att 50 dB

SWT 10 ms

-13.440000000 MHz

1 PK
MAXH

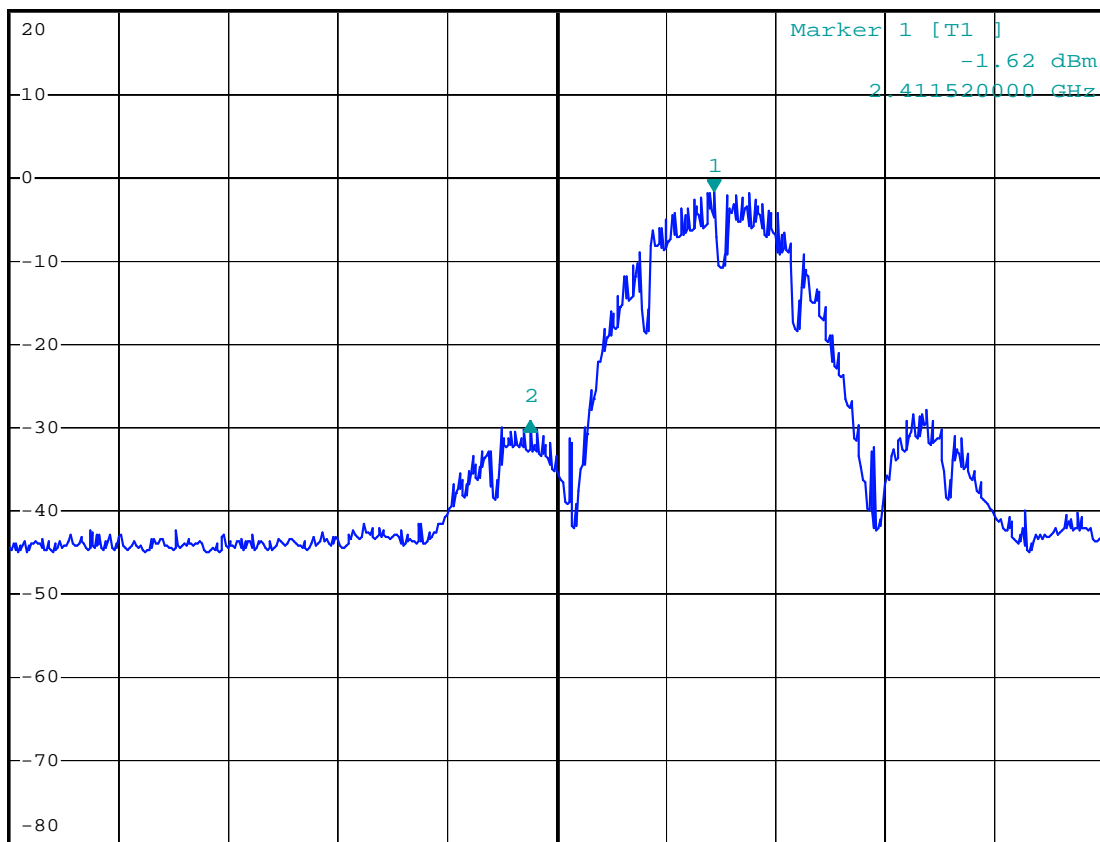

Center 2.4 GHz

8 MHz/

Span 80 MHz

Date: 20.JUN.2012 13:40:31

802.11b Channel High 2462MHz



*RBW 100 kHz Delta 2 [T1]
*VBW 300 kHz -32.70 dB
SWT 10 ms 26.560000000 MHz

Ref 20 dBm

Att 50 dB

26.560000000 MHz

1 PK
MAXH

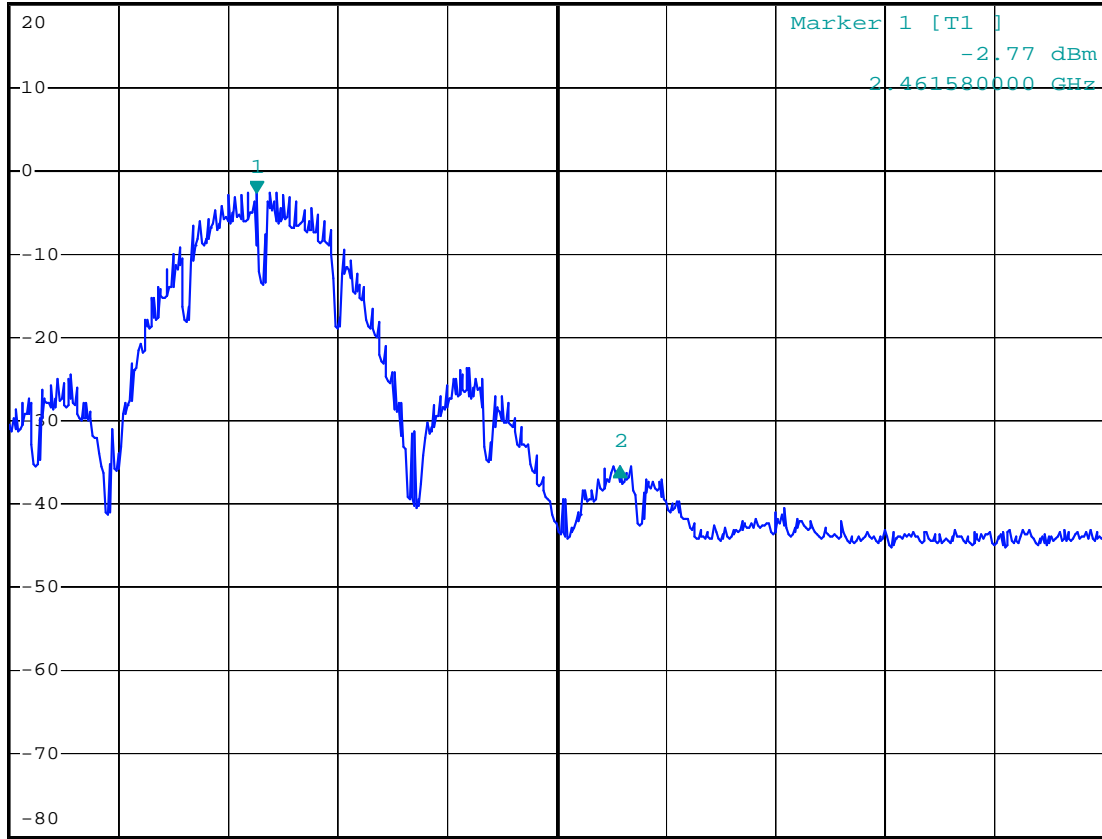

Center 2.4835 GHz

8 MHz/

Span 80 MHz

Date: 20.JUN.2012 13:41:50

802.11g Channel Low 2412MHz



*RBW 100 kHz Delta 2 [T1]
VBW 300 kHz -24.82 dB
*SWT 10 ms -15.680000000 MHz

Ref 20 dBm

Att 50 dB

1 PK
MAXH

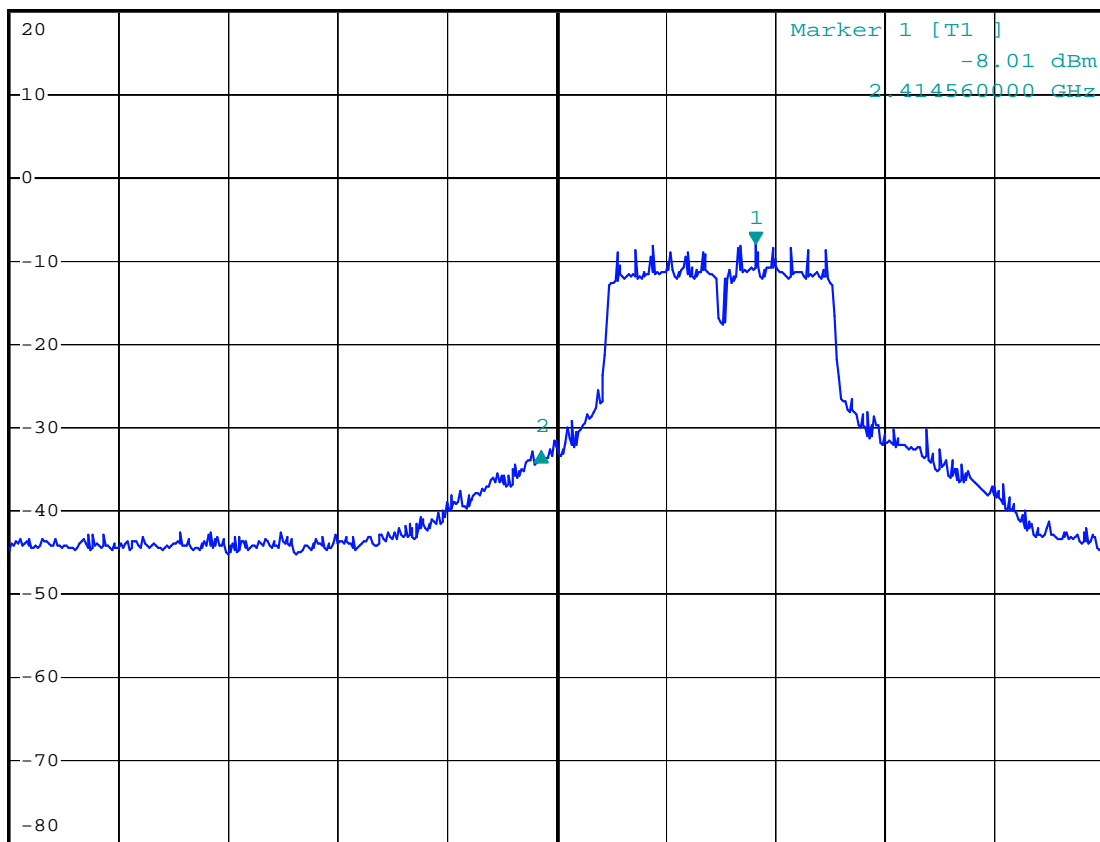

Center 2.4 GHz

8 MHz/

Span 80 MHz

Date: 20.JUN.2012 18:19:14

802.11g Channel High 2462MHz



*RBW 100 kHz Delta 2 [T1]
VEW 300 kHz -27.80 dB
*SWT 10 ms 21.760000000 MHz

Ref 20 dBm

Att 50 dB

1 PK
MAXH

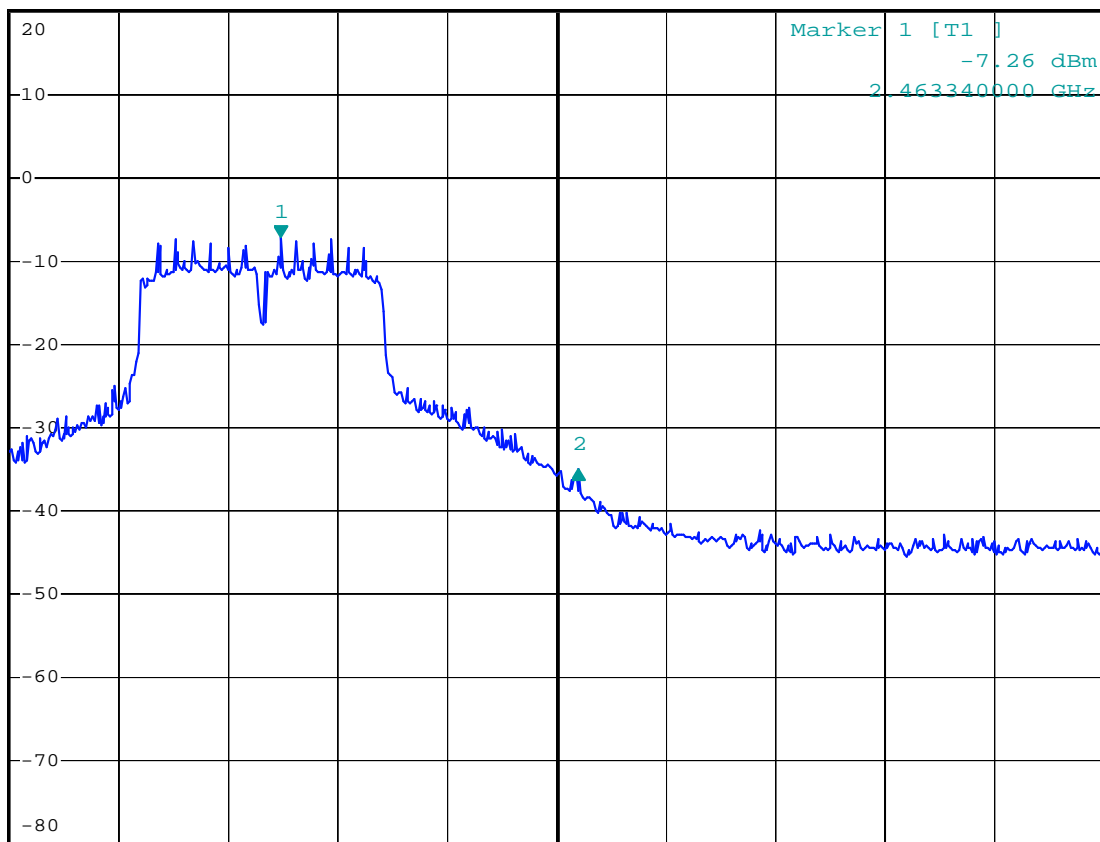

Center 2.4835 GHz

8 MHz/

Span 80 MHz

Date: 20.JUN.2012 18:44:01

802.11n Channel Low 2412MHz (20MHz)



*RBW 100 kHz Delta 2 [T1]
VBW 300 kHz -24.96 dB
*SWT 10 ms -14.240000000 MHz

Ref 20 dBm

Att 50 dB

1 PK
MAXH

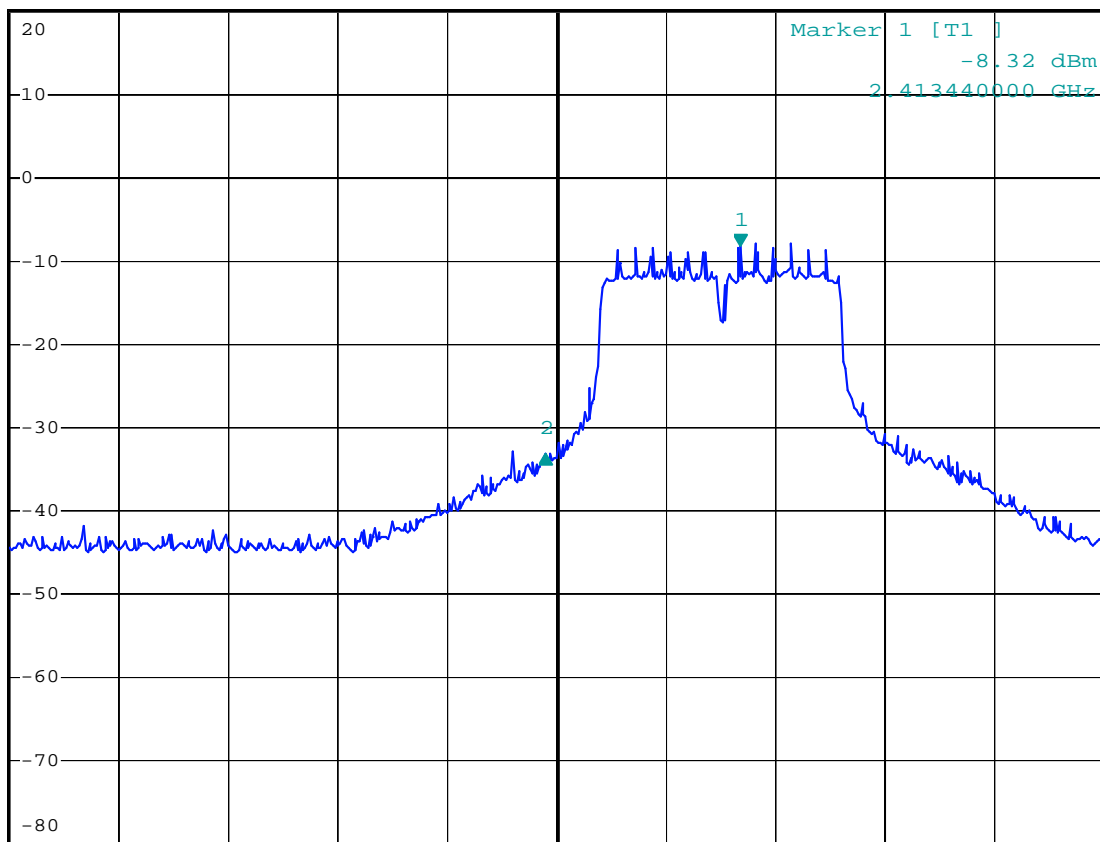

Date: 20.JUN.2012 18:43:11

802.11n Channel High 2462MHz (20MHz)



*RBW 100 kHz Delta 2 [T1]
VEW 300 kHz -27.80 dB
*SWT 10 ms 21.760000000 MHz

Ref 20 dBm

Att 50 dB

1 PK
MAXH

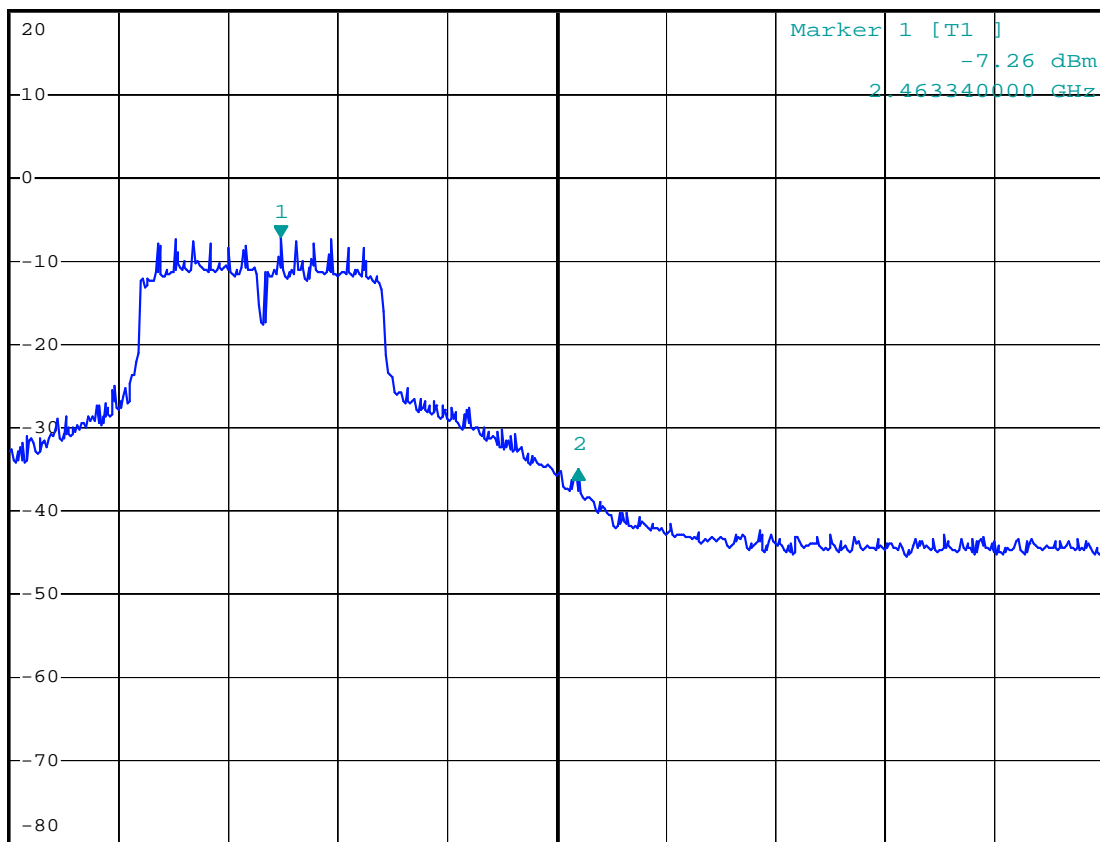

Center 2.4835 GHz

8 MHz/

Span 80 MHz

Date: 20.JUN.2012 18:44:01

802.11n Channel Low 2422MHz (40MHz)



*RBW 100 kHz Delta 2 [T1]
*VBW 300 kHz -22.30 dB
*SWT 10 ms -29.000000000 MHz

Ref 20 dBm

Att 50 dB

1 PK
MAXH

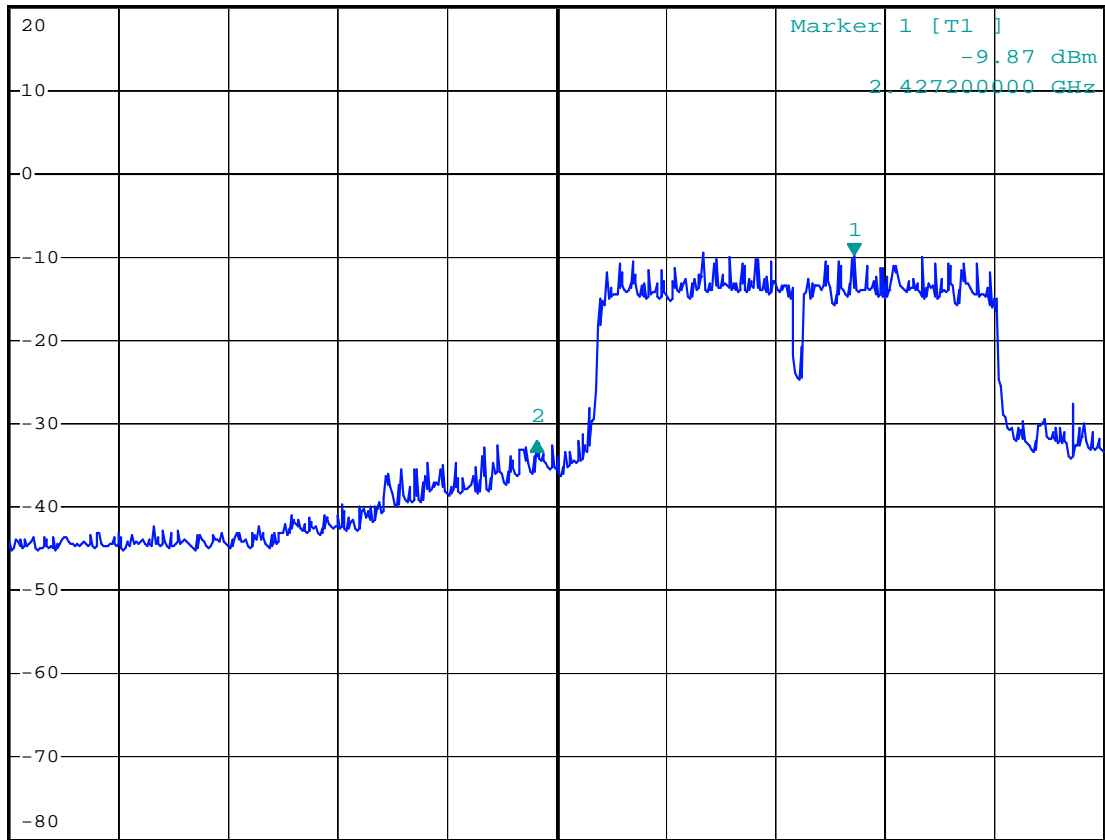

Center 2.4 GHz

10 MHz/

Span 100 MHz

Date: 20.JUN.2012 19:14:40

802.11n Channel High 2452MHz (40MHz)

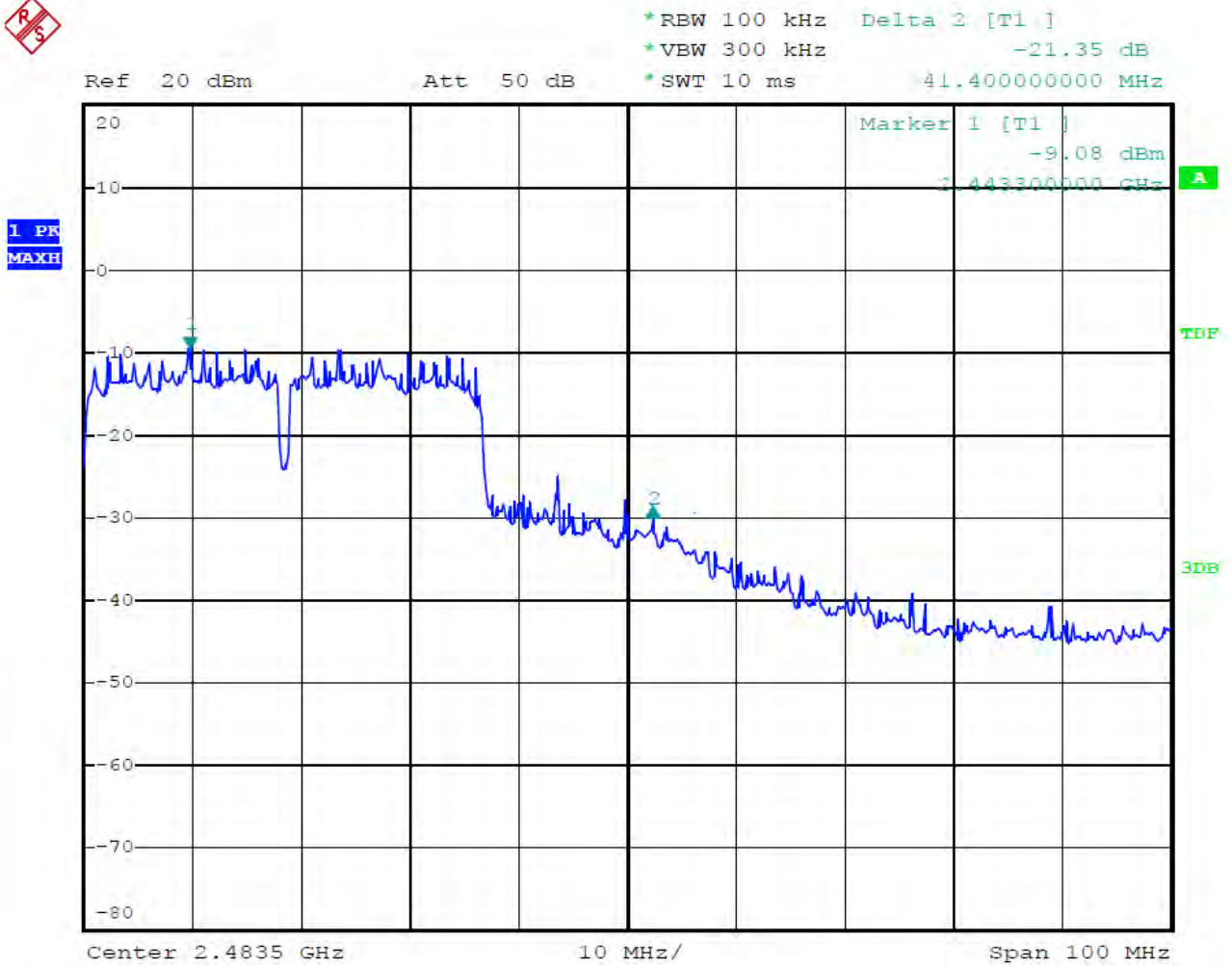

Date: 20.JUN.2012 19:17:59

Radiated Band Edge Result

Date of Test:	<u>June 27, 2012</u>	Temperature:	<u>25°C</u>
EUT:	<u>MID</u>	Humidity:	<u>50%</u>
Model No.:	<u>IS-TV1200K</u>	Power Supply:	<u>AC 120V/60HZ</u>
Test Mode:	<u>802.11b Channel Low 2412MHz</u>	Test Engineer:	<u>Pei</u>

Frequency (MHz)	Reading(dBμV/m)		Factor(dB) Corr.	Result(dBμV/m)		Limit(dBμV/m)		Margin(dB)		Polarization
	AV	PEAK		AV	PEAK	AV	PEAK	AV	PEAK	
2310.000	44.69	49.50	-7.81	36.88	41.69	54	74	-17.12	-32.31	Vertical
2332.150	45.58	50.40	-7.81	37.77	42.59	54	74	-16.23	-31.41	Vertical
2390.000	45.67	50.51	-7.53	38.14	42.98	54	74	-15.86	-31.02	Vertical
2310.000	43.95	48.17	-7.81	36.14	40.36	54	74	-17.86	-33.64	Horizontal
2332.150	42.25	47.65	-7.81	34.44	39.84	54	74	-19.56	-34.16	Horizontal
2390.000	42.18	47.70	-7.53	34.65	40.17	54	74	-19.35	-33.83	Horizontal

Note:

1. Emissions attenuated more than 20 dB below the permissible value are not reported.
2. The field strength is calculated by adding the antenna factor, high pass filter loss(if used) and cable loss, and subtracting the amplifier gain(if any)from the measured reading. The basic equation calculation is as follows:

$$\text{Result} = \text{Reading} + \text{Corrected Factor}$$
3. Display the measurement of peak values.

Date of Test:	<u>June 27, 2012</u>	Temperature:	<u>25°C</u>
EUT:	<u>TV BOX</u>	Humidity:	<u>50%</u>
Model No.:	<u>IS-TV1200K</u>	Power Supply:	<u>AC 120V/60HZ</u>
Test Mode:	<u>802.11b Channel High 2462MHz</u>	Test Engineer:	<u>Pei</u>

Frequency (MHz)	Reading(dBμV/m)		Factor(dB) Corr.	Result(dBμV/m)		Limit(dBμV/m)		Margin(dB)		Polarization
	AV	PEAK		AV	PEAK	AV	PEAK	AV	PEAK	
2483.500	45.96	50.85	-7.37	38.59	43.48	54	74	-15.41	-30.52	Vertical
2487.190	43.57	48.22	-7.38	36.19	40.84	54	74	-17.81	-33.16	Vertical
2500.000	41.21	46.76	-7.40	33.81	39.36	54	74	-20.19	-34.64	Vertical
2483.869	46.57	51.58	-7.38	19.19	44.20	54	74	-14.81	-29.80	Horizontal
2487.982	45.96	51.32	-7.38	38.58	43.94	54	74	-15.42	-30.06	Horizontal
2500.000	42.47	47.73	-7.40	35.07	40.33	54	74	-18.93	-33.67	Horizontal

Note:

1. Emissions attenuated more than 20 dB below the permissible value are not reported.
2. The field strength is calculated by adding the antenna factor, high pass filter loss(if used) and cable loss, and subtracting the amplifier gain(if any)from the measured reading. The basic equation calculation is as follows:
Result = Reading + Corrected Factor
3. Display the measurement of peak values.

Date of Test:	June 27, 2012	Temperature:	25°C
EUT:	TV BOX	Humidity:	50%
Model No.:	IS-TV1200K	Power Supply:	AC 120V/60HZ
Test Mode:	802.11g Channel Low 2412MHz	Test Engineer:	Pei

Frequency (MHz)	Reading(dBμV/m)		Factor(dB) Corr.	Result(dBμV/m)		Limit(dBμV/m)		Margin(dB)		Polarization
	AV	PEAK		AV	PEAK	AV	PEAK	AV	PEAK	
2310.000	46.59	51.24	-7.81	38.78	43.43	54	74	-15.22	-30.57	Vertical
2332.000	46.86	51.41	-7.81	39.05	43.60	54	74	-14.95	-30.40	Vertical
2390.000	52.47	57.48	-7.53	44.94	49.95	54	74	-9.06	-24.05	Vertical
2310.000	42.58	48.14	-7.81	34.77	40.33	54	74	-19.23	-33.67	Horizontal
2332.000	43.25	48.94	-7.81	35.44	41.13	54	74	-18.56	-32.87	Horizontal
2390.000	52.17	57.28	-7.53	44.64	49.75	54	74	-9.36	-24.25	Horizontal

Note:

1. Emissions attenuated more than 20 dB below the permissible value are not reported.
2. The field strength is calculated by adding the antenna factor, high pass filter loss(if used) and cable loss, and subtracting the amplifier gain(if any)from the measured reading. The basic equation calculation is as follows:

$$\text{Result} = \text{Reading} + \text{Corrected Factor}$$
3. Display the measurement of peak values.

Date of Test:	<u>June 27, 2012</u>	Temperature:	<u>25°C</u>
EUT:	<u>TV BOX</u>	Humidity:	<u>50%</u>
Model No.:	<u>IS-TV1200K</u>	Power Supply:	<u>AC 120V/60HZ</u>
Test Mode:	<u>802.11g Channel High 2462MHz</u>	Test Engineer:	<u>Pei</u>

Frequency (MHz)	Reading(dBμV/m)		Factor(dB) Corr.	Result(dBμV/m)		Limit(dBμV/m)		Margin(dB)		Polarization
	AV	PEAK		AV	PEAK	AV	PEAK	AV	PEAK	
2483.500	51.17	55.69	-7.37	43.80	48.32	54	74	-10.20	-25.68	Vertical
2487.000	48.29	52.69	-7.38	40.91	45.31	54	74	-13.09	-28.69	Vertical
2500.000	41.69	46.63	-7.40	34.29	39.23	54	74	-19.71	-34.77	Vertical
2483.500	53.85	57.59	-7.37	46.48	50.22	54	74	-7.52	-23.78	Horizontal
2487.000	52.96	56.53	-7.38	45.58	49.15	54	74	-8.42	-24.85	Horizontal
2500.000	41.28	46.95	-7.40	33.88	39.55	54	74	-20.12	-34.45	Horizontal

Note:

1. Emissions attenuated more than 20 dB below the permissible value are not reported.
2. The field strength is calculated by adding the antenna factor, high pass filter loss(if used) and cable loss, and subtracting the amplifier gain(if any)from the measured reading. The basic equation calculation is as follows:
Result = Reading + Corrected Factor
3. Display the measurement of peak values.

Date of Test:	<u>June 27, 2012</u>	Temperature:	<u>25°C</u>
EUT:	<u>TV BOX</u>	Humidity:	<u>50%</u>
Model No.:	<u>IS-TV1200K</u>	Power Supply:	<u>AC 120V/60HZ</u>
	<u>802.11n Channel Low 2412MHz</u>		
Test Mode:	<u>(20MHz)</u>	Test Engineer:	<u>Pei</u>

Frequency (MHz)	Reading(dBμV/m)		Factor(dB) Corr.	Result(dBμV/m)		Limit(dBμV/m)		Margin(dB)		Polarization
	AV	PEAK		AV	PEAK	AV	PEAK	AV	PEAK	
2310.000	46.68	51.99	-7.81	38.87	44.18	54	74	-15.13	-29.82	Vertical
2332.916	46.66	51.85	-7.79	38.87	44.06	54	74	-15.13	-29.94	Vertical
2390.000	53.26	57.59	-7.53	45.73	50.06	54	74	-8.27	-23.94	Vertical
2310.783	45.18	50.56	-7.81	37.37	42.75	54	74	-16.63	-31.25	Horizontal
2332.000	44.22	49.45	-7.81	36.41	41.64	54	74	-17.59	-32.36	Horizontal
2390.806	52.78	57.38	-7.52	45.26	49.86	54	74	-8.74	-24.14	Horizontal

Note:

1. Emissions attenuated more than 20 dB below the permissible value are not reported.
2. The field strength is calculated by adding the antenna factor, high pass filter loss(if used) and cable loss, and subtracting the amplifier gain(if any)from the measured reading. The basic equation calculation is as follows:

$$\text{Result} = \text{Reading} + \text{Corrected Factor}$$
3. Display the measurement of peak values.

Date of Test:	June 27, 2012	Temperature:	25°C
EUT:	TV BOX	Humidity:	50%
Model No.:	IS-TV1200K	Power Supply:	AC 120V/60HZ
Test Mode:	802.11n Channel High 2462MHz (20MHz)	Test Engineer:	Pei

Frequency (MHz)	Reading(dBμV/m)		Factor(dB) Corr.	Result(dBμV/m)		Limit(dBμV/m)		Margin(dB)		Polarization
	AV	PEAK		AV	PEAK	AV	PEAK	AV	PEAK	
2483.500	53.48	58.58	-7.37	46.11	51.21	54	74	-7.89	-22.79	Vertical
2487.000	48.69	54.36	-7.38	41.31	46.98	54	74	-12.69	-27.02	Vertical
2500.000	43.69	48.91	-7.40	36.29	41.51	54	74	-17.71	-32.49	Vertical
2483.500	54.58	59.25	-7.37	47.21	51.88	54	74	-6.79	-22.12	Horizontal
2487.000	48.85	53.25	-7.38	41.47	45.87	54	74	-12.53	-28.13	Horizontal
2500.000	41.45	46.95	-7.40	34.05	39.55	54	74	-19.95	-34.45	Horizontal

Note:

1. Emissions attenuated more than 20 dB below the permissible value are not reported.
2. The field strength is calculated by adding the antenna factor, high pass filter loss(if used) and cable loss, and subtracting the amplifier gain(if any)from the measured reading. The basic equation calculation is as follows:
Result = Reading + Corrected Factor
3. Display the measurement of peak values.

Date of Test:	<u>June 27, 2012</u>	Temperature:	<u>25°C</u>
EUT:	<u>TV BOX</u>	Humidity:	<u>50%</u>
Model No.:	<u>IS-TV1200K</u>	Power Supply:	<u>AC 120V/60HZ</u>
	<u>802.11n Channel Low 2422MHz</u>		
Test Mode:	<u>(40MHz)</u>	Test Engineer:	<u>Pei</u>

Frequency (MHz)	Reading(dBμV/m)		Factor(dB) Corr.	Result(dBμV/m)		Limit(dBμV/m)		Margin(dB)		Polarization
	AV	PEAK		AV	PEAK	AV	PEAK	AV	PEAK	
2310.920	48.81	52.60	-7.81	41.00	44.79	54	74	-13.00	-29.21	Vertical
2332.000	47.96	52.42	-7.81	40.15	44.61	54	74	-13.85	-29.39	Vertical
2390.000	53.64	59.69	-7.53	46.11	52.16	54	74	-7.89	-21.84	Vertical
2310.000	42.90	47.00	-7.81	35.09	39.19	54	74	-18.91	-34.81	Horizontal
2332.000	41.15	46.38	-7.81	33.34	38.57	54	74	-20.66	-35.43	Horizontal
2390.000	49.69	54.96	-7.53	42.16	47.43	54	74	-11.84	-26.57	Horizontal

Note:

1. Emissions attenuated more than 20 dB below the permissible value are not reported.
2. The field strength is calculated by adding the antenna factor, high pass filter loss(if used) and cable loss, and subtracting the amplifier gain(if any)from the measured reading. The basic equation calculation is as follows:
Result = Reading + Corrected Factor
3. Display the measurement of peak values.

Date of Test:	June 27, 2012	Temperature:	25°C
EUT:	TV BOX	Humidity:	50%
Model No.:	IS-TV1200K	Power Supply:	AC 120V/60HZ
Test Mode:	802.11n Channel High 2452MHz (40MHz)	Test Engineer:	Pei

Frequency (MHz)	Reading(dBμV/m)		Factor(dB) Corr.	Result(dBμV/m)		Limit(dBμV/m)		Margin(dB)		Polarization
	AV	PEAK		AV	PEAK	AV	PEAK	AV	PEAK	
2483.500	52.85	57.99	-7.37	45.48	50.62	54	74	-8.52	-23.38	Vertical
2487.507	52.16	57.17	-7.38	44.78	49.79	54	74	-9.22	-24.21	Vertical
2500.000	48.59	53.64	-7.40	41.19	46.24	54	74	-12.81	-27.76	Vertical
2483.500	51.44	59.96	-7.37	44.07	49.59	54	74	-9.93	-24.41	Horizontal
2487.000	51.77	56.27	-7.38	44.39	48.89	54	74	-9.61	-25.11	Horizontal
2500.000	46.47	51.33	-7.40	39.07	43.93	54	74	-14.93	-30.07	Horizontal

Note:

1. Emissions attenuated more than 20 dB below the permissible value are not reported.
2. The field strength is calculated by adding the antenna factor, high pass filter loss(if used) and cable loss, and subtracting the amplifier gain(if any)from the measured reading. The basic equation calculation is as follows:
Result = Reading + Corrected Factor
3. Display the measurement of peak values.



ACCURATE TECHNOLOGY CO., LTD.

F1,Bldg,A,Changyuan New Material Port Keyuan Rd,
Science & Industry Park,Nanshan Shenzhen,P.R.China

Site: 966 chamber
Tel:+86-0755-26503290
Fax:+86-0755-26503396

Job No.: Bob #2551	Polarization: Horizontal
Standard: FCC 15C PK	Power Source: AC 120V/60Hz
Test item: Radiation Test	Date: 12/06/27/
Temp.(C)/Hum.(%) 24 C / 48 %	Time: 0/39/31
EUT: TV BOX	Engineer Signature:
Mode: TX Channel 1(802.11b)	Distance: 3m
Model: IS-TV1200K	
Manufacturer: SWAGTEK	

Note: Report NO.:ATE20121277

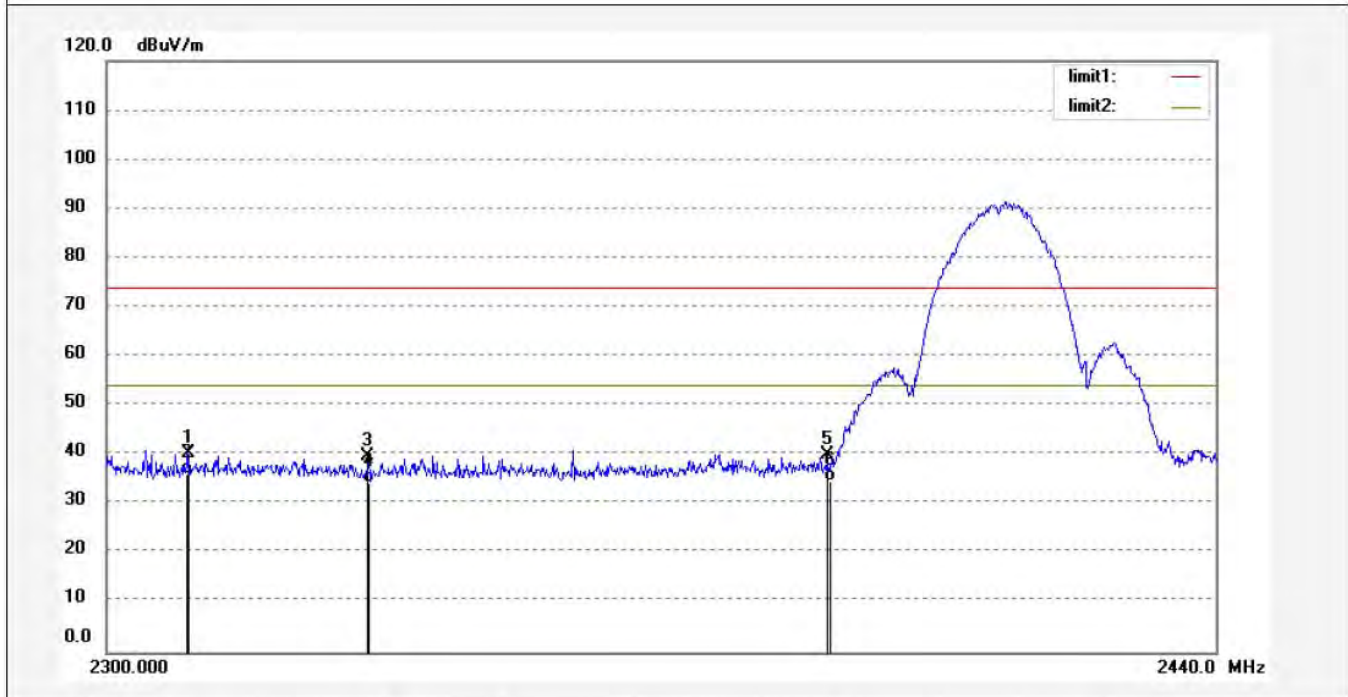

No.	Freq. (MHz)	Reading (dBuV/m)	Factor (dB)	Result (dBuV/m)	Limit (dBuV/m)	Margin (dB)	Detector	Height (cm)	Degree (deg.)	Remark
1	2310.000	48.17	-7.81	40.36	74.00	-33.64	peak			
2	2310.000	43.95	-7.81	36.14	54.00	-17.86	AVG			
3	2332.150	47.65	-7.81	39.84	74.00	-34.16	peak			
4	2332.150	42.25	-7.81	34.44	54.00	-19.56	AVG			
5	2390.000	47.70	-7.53	40.17	74.00	-33.83	peak			
6	2390.000	42.18	-7.53	34.65	54.00	-19.35	AVG			



ACCURATE TECHNOLOGY CO., LTD.

F1,Bldg.A,Changyuan New Material Port Keyuan Rd,
Science & Industry Park,Nanshan Shenzhen,P.R.China

Site: 966 chamber
Tel:+86-0755-26503290
Fax:+86-0755-26503396

Job No.: Bob #2552
Standard: FCC 15C PK
Test item: Radiation Test
Temp.(C)/Hum.(%) 24 C / 48 %
EUT: TV BOX
Mode: TX Channel 1(802.11b)
Model: IS-TV1200K
Manufacturer: SWAGTEK

Polarization: Vertical
Power Source: AC 120V/60Hz
Date: 12/06/27/
Time: 0/41/26
Engineer Signature:
Distance: 3m

Note: Report NO.:ATE20121277

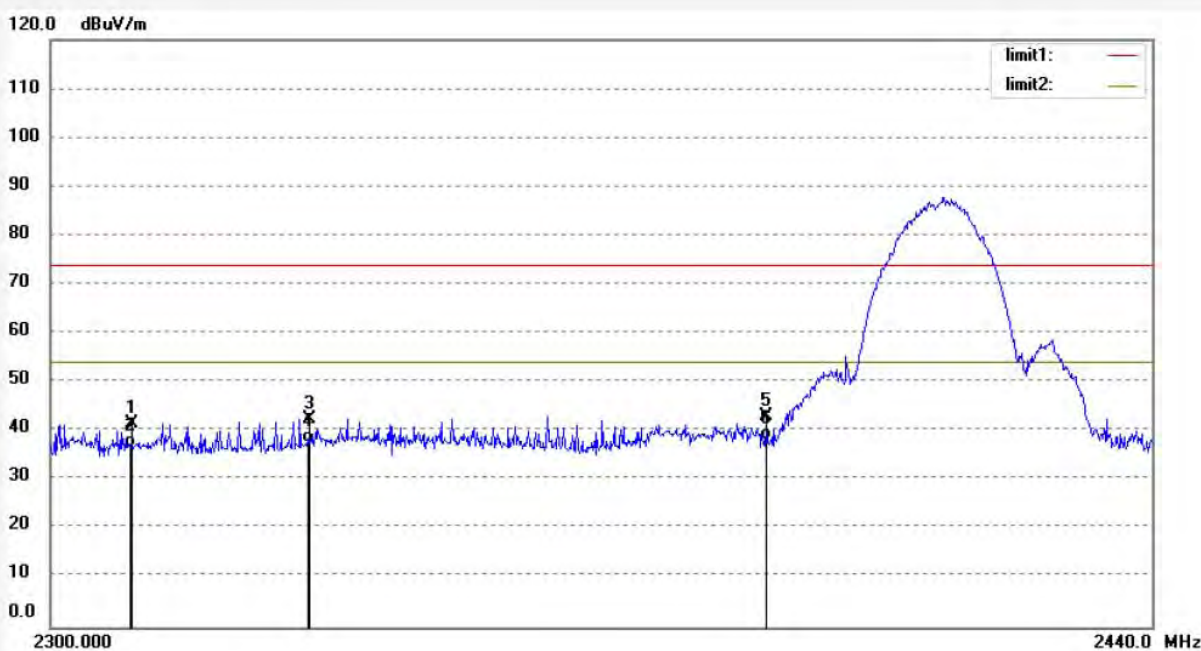

No.	Freq. (MHz)	Reading (dBuV/m)	Factor (dB)	Result (dBuV/m)	Limit (dBuV/m)	Margin (dB)	Detector	Height (cm)	Degree (deg.)	Remark
1	2310.000	49.50	-7.81	41.69	74.00	-32.31	peak			
2	2310.000	44.69	-7.81	36.88	54.00	-17.12	AVG			
3	2332.150	50.40	-7.81	42.59	74.00	-31.41	peak			
4	2332.150	45.58	-7.81	37.77	54.00	-16.23	AVG			
5	2390.000	50.51	-7.53	42.98	74.00	-31.02	peak			
6	2390.000	45.67	-7.53	38.14	54.00	-15.86	AVG			



ACCURATE TECHNOLOGY CO., LTD.

F1,Bldg,A,Changyuan New Material Port Keyuan Rd,
Science & Industry Park,Nanshan Shenzhen,P.R.China

Site: 966 chamber
Tel:+86-0755-26503290
Fax:+86-0755-26503396

Job No.: Bob #2554	Polarization: Horizontal
Standard: FCC 15C PK	Power Source: AC 120V/60Hz
Test item: Radiation Test	Date: 12/06/27/
Temp.(C)/Hum.(%) 24 C / 48 %	Time: 0/47/42
EUT: TV BOX	Engineer Signature:
Mode: TX Channel 11(802.11b)	Distance: 3m
Model: IS-TV1200K	
Manufacturer: SWAGTEK	

Note: Report NO.:ATE20121277

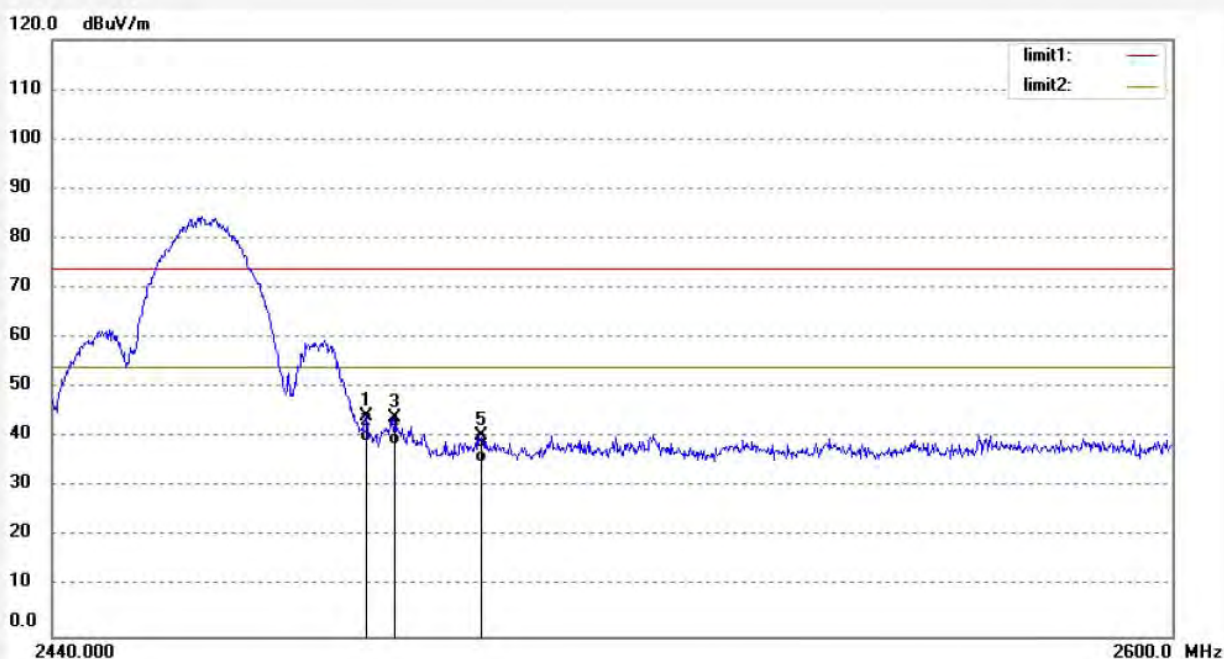

No.	Freq. (MHz)	Reading (dBuV/m)	Factor (dB)	Result (dBuV/m)	Limit (dBuV/m)	Margin (dB)	Detector	Height (cm)	Degree (deg.)	Remark
1	2483.869	51.58	-7.38	44.20	74.00	-29.80	peak			
2	2483.869	46.57	-7.38	39.19	54.00	-14.81	AVG			
3	2487.982	51.32	-7.38	43.94	74.00	-30.06	peak			
4	2487.982	45.96	-7.38	38.58	54.00	-15.42	AVG			
5	2500.000	47.73	-7.40	40.33	74.00	-33.67	peak			
6	2500.000	42.47	-7.40	35.07	54.00	-18.93	AVG			



ACCURATE TECHNOLOGY CO., LTD.

F1,Bldg,A,Changyuan New Material Port Keyuan Rd,
Science & Industry Park,Nanshan Shenzhen,P.R.China

Site: 966 chamber
Tel:+86-0755-26503290
Fax:+86-0755-26503396

Job No.: Bob #2553
Standard: FCC 15C PK
Test item: Radiation Test
Temp.(C)/Hum.(%) 24 C / 48 %
EUT: TV BOX
Mode: TX Channel 11(802.11b)
Model: IS-TV1200K
Manufacturer: SWAGTEK

Polarization: Vertical
Power Source: AC 120V/60Hz
Date: 12/06/27/
Time: 0/44/37
Engineer Signature:
Distance: 3m

Note: Report NO.:ATE20121277

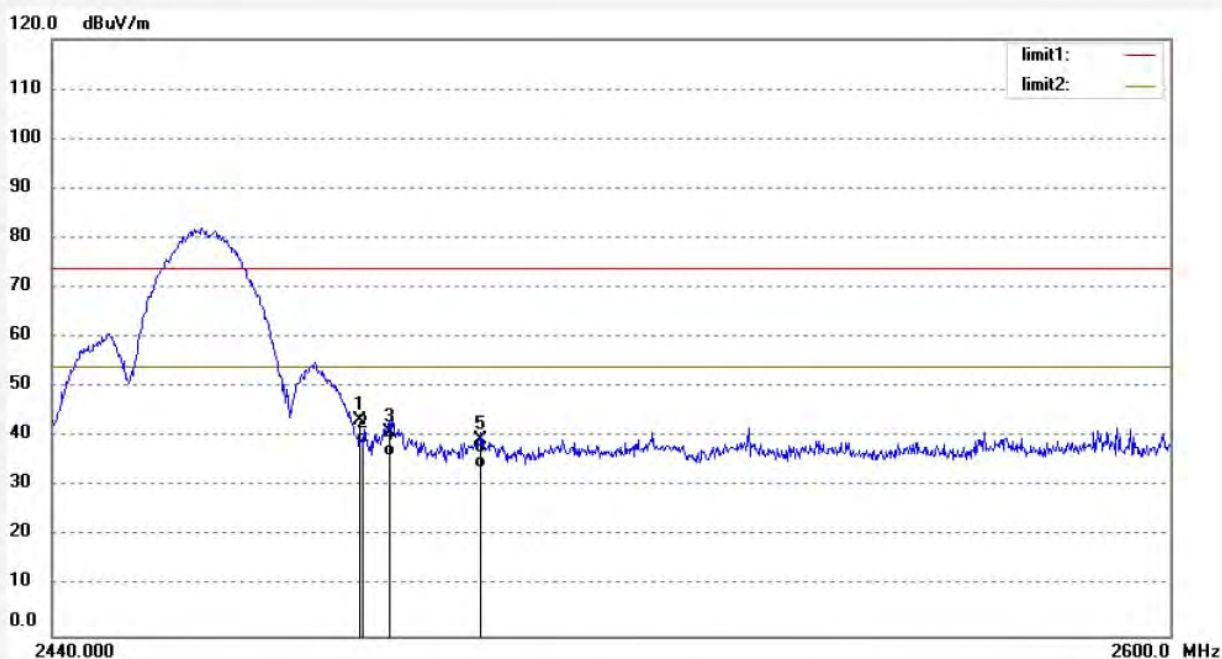

No.	Freq. (MHz)	Reading (dBuV/m)	Factor (dB)	Result (dBuV/m)	Limit (dBuV/m)	Margin (dB)	Detector	Height (cm)	Degree (deg.)	Remark
1	2483.500	50.85	-7.37	43.48	74.00	-30.52	peak			
2	2483.500	45.96	-7.37	38.59	54.00	-15.41	AVG			
3	2487.190	48.22	-7.38	40.84	74.00	-33.16	peak			
4	2487.190	43.57	-7.38	36.19	54.00	-17.81	AVG			
5	2500.000	46.76	-7.40	39.36	74.00	-34.64	peak			
6	2500.000	41.21	-7.40	33.81	54.00	-20.19	AVG			

ACCURATE TECHNOLOGY CO., LTD.

 F1,Bldg,A,Changyuan New Material Port Keyuan Rd,
 Science & Industry Park,Nanshan Shenzhen,P.R.China

Site: 966 chamber

Tel:+86-0755-26503290

Fax:+86-0755-26503396

Job No.: Bob #2558

Standard: FCC 15C PK

Test item: Radiation Test

Temp.(C)/Hum.(%) 24 C / 48 %

EUT: TV BOX

Mode: TX Channel 1(802.11g)

Model: IS-TV1200K

Manufacturer: SWAGTEK

Polarization: Horizontal

Power Source: AC 120V/60Hz

Date: 12/06/27/

Time: 1/03/19

Engineer Signature:

Distance: 3m

Note: Report NO.:ATE20121277

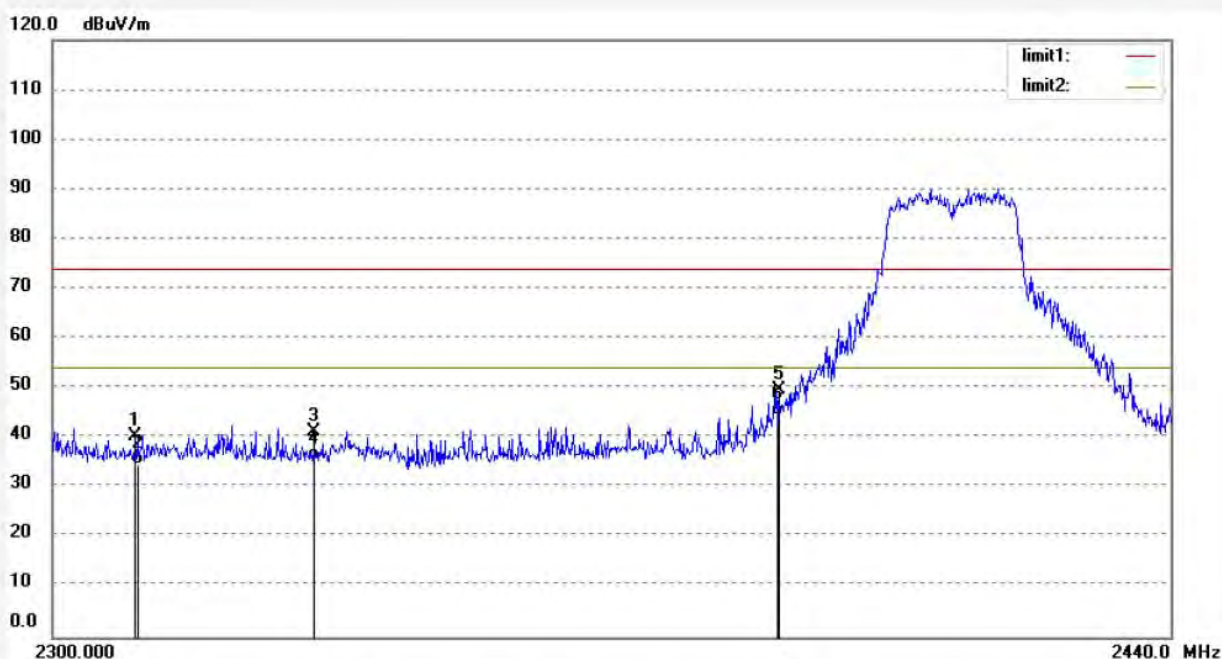

No.	Freq. (MHz)	Reading (dBuV/m)	Factor (dB)	Result (dBuV/m)	Limit (dBuV/m)	Margin (dB)	Detector	Height (cm)	Degree (deg.)	Remark
1	2310.000	48.14	-7.81	40.33	74.00	-33.67	peak			
2	2310.000	42.58	-7.81	34.77	54.00	-19.23	AVG			
3	2332.000	48.94	-7.81	41.13	74.00	-32.87	peak			
4	2332.000	43.25	-7.81	35.44	54.00	-18.56	AVG			
5	2390.000	57.28	-7.53	49.75	74.00	-24.25	peak			
6	2390.000	52.17	-7.53	44.64	54.00	-9.36	AVG			



ACCURATE TECHNOLOGY CO., LTD.

F1,Bldg,A,Changyuan New Material Port Keyuan Rd,
Science & Industry Park,Nanshan Shenzhen,P.R.China

Site: 966 chamber
Tel:+86-0755-26503290
Fax:+86-0755-26503396

Job No.: Bob #2557
Standard: FCC 15C PK
Test item: Radiation Test
Temp.(C)/Hum.(%) 24 C / 48 %
EUT: TV BOX
Mode: TX Channel 1(802.11g)
Model: IS-TV1200K
Manufacturer: SWAGTEK

Polarization: Vertical
Power Source: AC 120V/60Hz
Date: 12/06/27/
Time: 0/59/52
Engineer Signature:
Distance: 3m

Note: Report NO.:ATE20121277

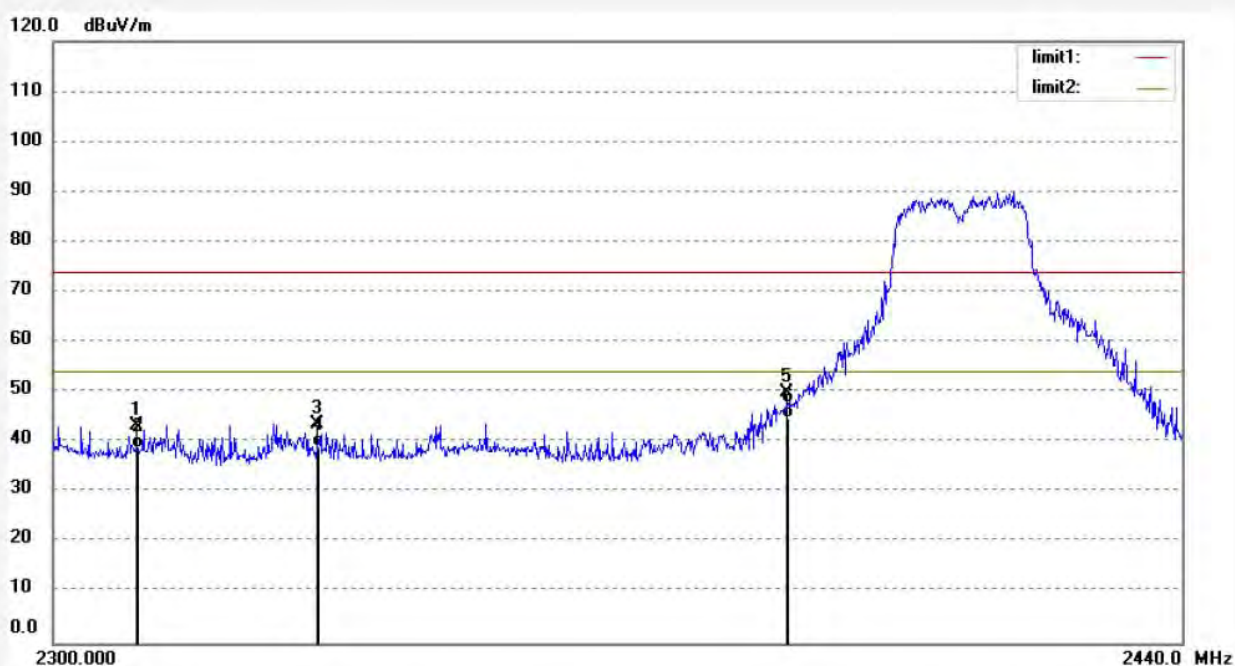

No.	Freq. (MHz)	Reading (dBuV/m)	Factor (dB)	Result (dBuV/m)	Limit (dBuV/m)	Margin (dB)	Detector	Height (cm)	Degree (deg.)	Remark
1	2310.000	51.24	-7.81	43.43	74.00	-30.57	peak			
2	2310.000	46.59	-7.81	38.78	54.00	-15.22	AVG			
3	2332.000	51.41	-7.81	43.60	74.00	-30.40	peak			
4	2332.000	46.86	-7.81	39.05	54.00	-14.95	AVG			
5	2390.000	57.48	-7.53	49.95	74.00	-24.05	peak			
6	2390.000	52.47	-7.53	44.94	54.00	-9.06	AVG			



ACCURATE TECHNOLOGY CO., LTD.

F1,Bldg,A,Changyuan New Material Port Keyuan Rd,
Science & Industry Park,Nanshan Shenzhen,P.R.China

Site: 966 chamber
Tel:+86-0755-26503290
Fax:+86-0755-26503396

Job No.: Bob #2555	Polarization: Horizontal
Standard: FCC 15C PK	Power Source: AC 120V/60Hz
Test item: Radiation Test	Date: 12/06/27/
Temp.(C)/Hum.(%) 24 C / 48 %	Time: 0/51/42
EUT: TV BOX	Engineer Signature:
Mode: TX Channel 11(802.11g)	Distance: 3m
Model: IS-TV1200K	
Manufacturer: SWAGTEK	

Note: Report NO.:ATE20121277

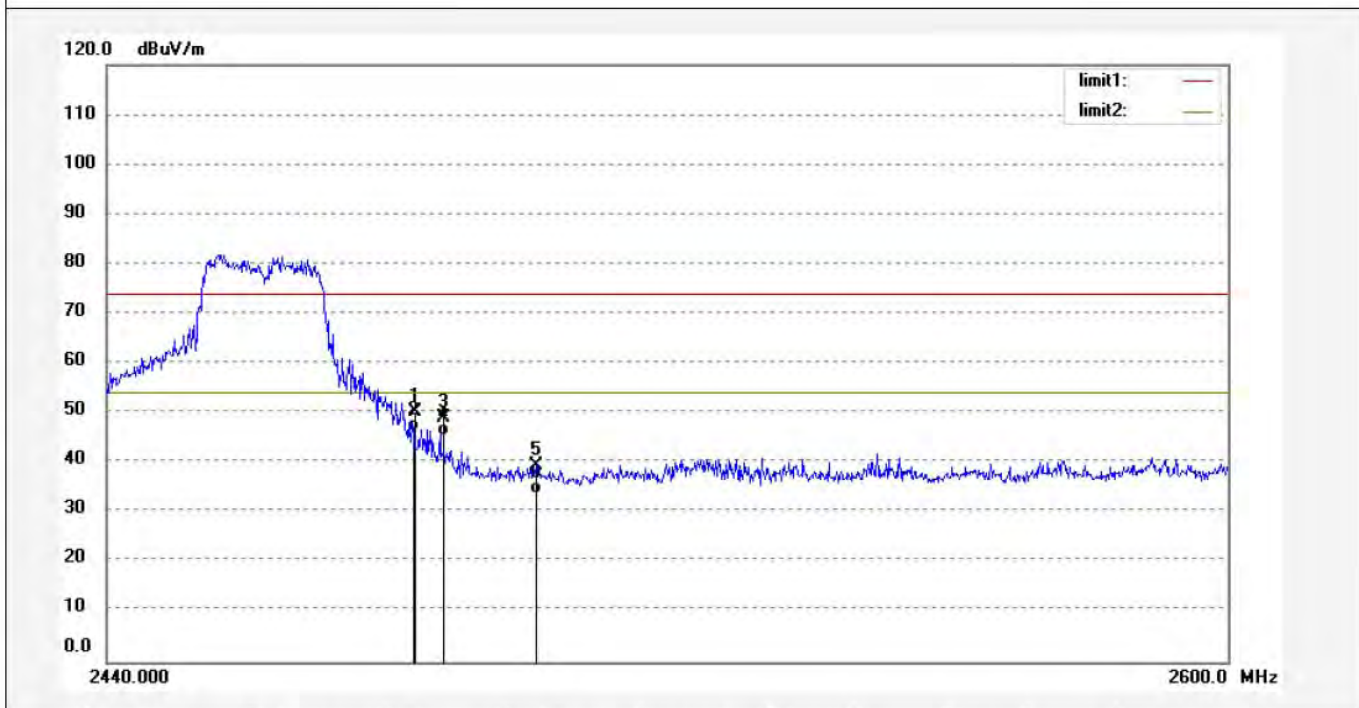

No.	Freq. (MHz)	Reading (dBuV/m)	Factor (dB)	Result (dBuV/m)	Limit (dBuV/m)	Margin (dB)	Detector	Height (cm)	Degree (deg.)	Remark
1	2483.500	57.59	-7.37	50.22	74.00	-23.78	peak			
2	2483.500	53.85	-7.37	46.48	54.00	-7.52	AVG			
3	2487.000	56.53	-7.38	49.15	74.00	-24.85	peak			
4	2487.000	52.96	-7.38	45.58	54.00	-8.42	AVG			
5	2500.045	46.95	-7.40	39.55	74.00	-34.45	peak			
6	2500.045	41.28	-7.40	33.88	54.00	-20.12	AVG			



ACCURATE TECHNOLOGY CO., LTD.

F1,Bldg,A,Changyuan New Material Port Keyuan Rd,
Science & Industry Park,Nanshan Shenzhen,P.R.China

Site: 966 chamber
Tel:+86-0755-26503290
Fax:+86-0755-26503396

Job No.: Bob #2556
Standard: FCC 15C PK
Test item: Radiation Test
Temp.(C)/Hum.(%) 24 C / 48 %
EUT: TV BOX
Mode: TX Channel 11(802.11g)
Model: IS-TV1200K
Manufacturer: SWAGTEK

Polarization: Vertical
Power Source: AC 120V/60Hz
Date: 12/06/27/
Time: 0/55/16
Engineer Signature:
Distance: 3m

Note: Report NO.:ATE20121277

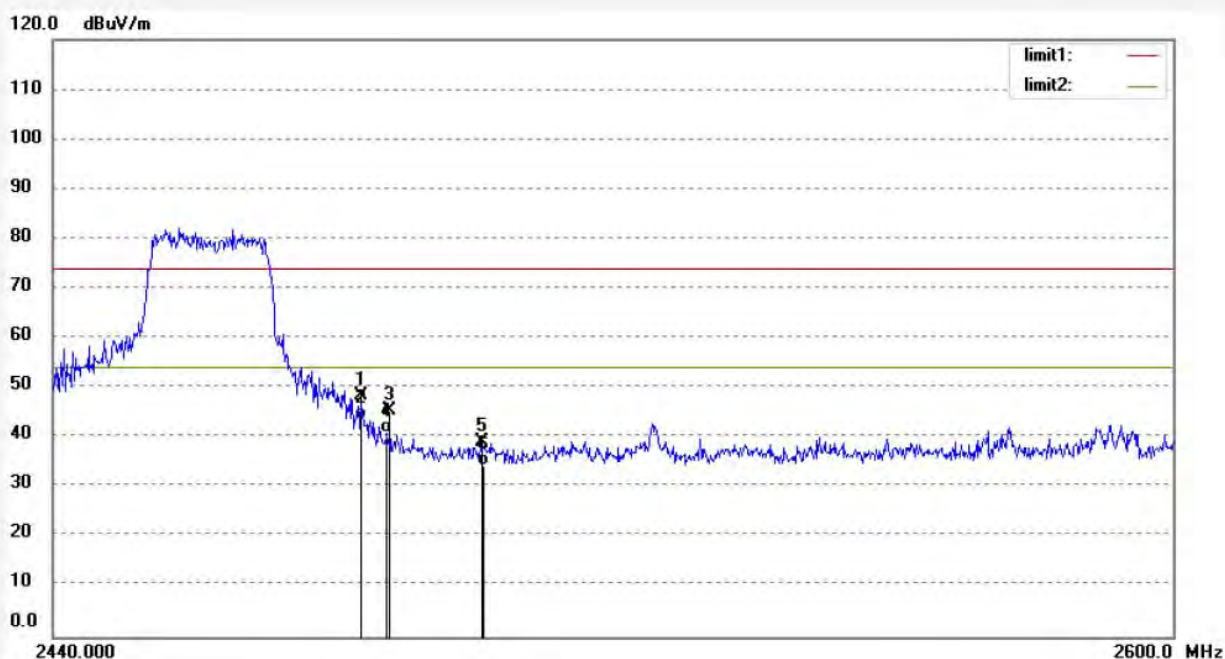

No.	Freq. (MHz)	Reading (dBuV/m)	Factor (dB)	Result (dBuV/m)	Limit (dBuV/m)	Margin (dB)	Detector	Height (cm)	Degree (deg.)	Remark
1	2483.500	55.69	-7.37	48.32	74.00	-25.68	peak			
2	2483.500	51.17	-7.37	43.80	54.00	-10.20	AVG			
3	2487.000	52.69	-7.38	45.31	74.00	-28.69	peak			
4	2487.000	48.29	-7.38	40.91	54.00	-13.09	AVG			
5	2500.000	46.63	-7.40	39.23	74.00	-34.77	peak			
6	2500.000	41.69	-7.40	34.29	54.00	-19.71	AVG			



ACCURATE TECHNOLOGY CO., LTD.

F1,Bldg,A,Changyuan New Material Port Keyuan Rd,
Science & Industry Park,Nanshan Shenzhen,P.R.China

Site: 966 chamber
Tel:+86-0755-26503290
Fax:+86-0755-26503396

Job No.: Bob #2559	Polarization: Horizontal
Standard: FCC 15C PK	Power Source: AC 120V/60Hz
Test item: Radiation Test	Date: 12/06/27/
Temp.(C)/Hum.(%) 24 C / 48 %	Time: 1/06/52
EUT: TV BOX	Engineer Signature:
Mode: TX Channel 1(802.11n)	Distance: 3m
Model: IS-TV1200K	
Manufacturer: SWAGTEK	

Note: Report NO.:ATE20121277

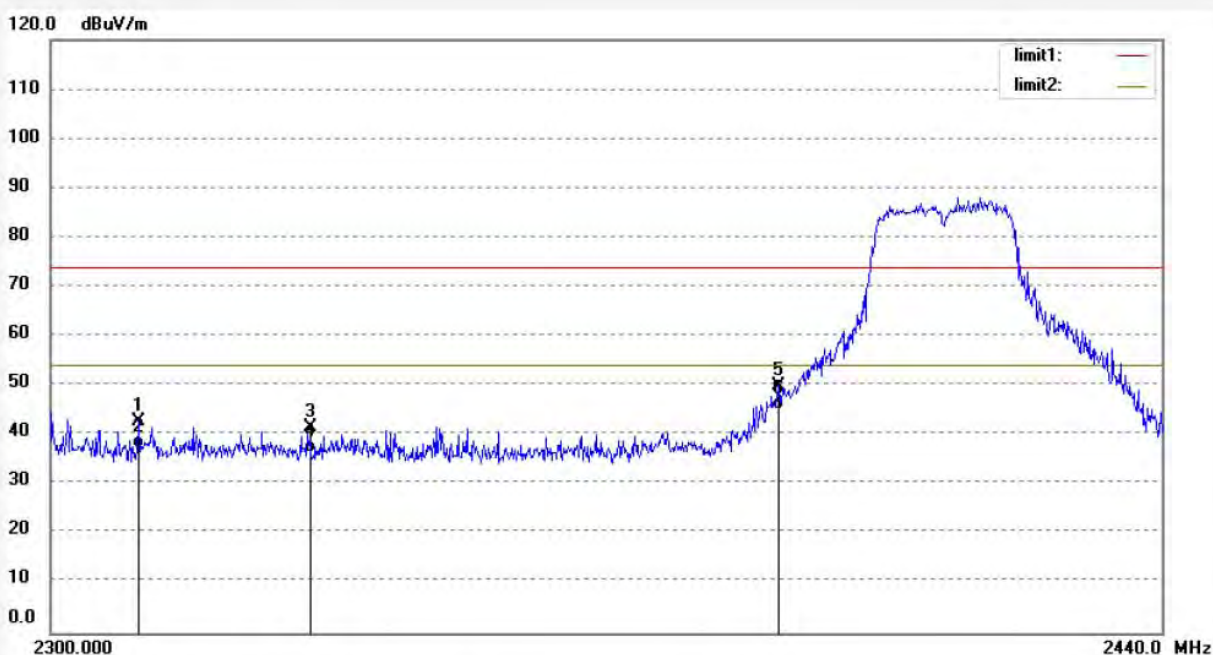

No.	Freq. (MHz)	Reading (dBuV/m)	Factor (dB)	Result (dBuV/m)	Limit (dBuV/m)	Margin (dB)	Detector	Height (cm)	Degree (deg.)	Remark
1	2310.783	50.56	-7.81	42.75	74.00	-31.25	peak			
2	2310.783	45.18	-7.81	37.37	54.00	-16.63	AVG			
3	2332.000	49.45	-7.81	41.64	74.00	-32.36	peak			
4	2332.000	44.22	-7.81	36.41	54.00	-17.59	AVG			
5	2390.806	57.38	-7.52	49.86	74.00	-24.14	peak			
6	2390.806	52.78	-7.52	45.26	54.00	-8.74	AVG			



ACCURATE TECHNOLOGY CO., LTD.

F1,Bldg,A,Changyuan New Material Port Keyuan Rd,
Science & Industry Park,Nanshan Shenzhen,P.R.China

Site: 966 chamber
Tel:+86-0755-26503290
Fax:+86-0755-26503396

Job No.: Bob #2560
Standard: FCC 15C PK
Test item: Radiation Test
Temp.(C)/Hum.(%) 24 C / 48 %
EUT: TV BOX
Mode: TX Channel 1(802.11n)
Model: IS-TV1200K
Manufacturer: SWAGTEK

Polarization: Vertical
Power Source: AC 120V/60Hz
Date: 12/06/27/
Time: 1/09/13
Engineer Signature:
Distance: 3m

Note: Report NO.:ATE20121277

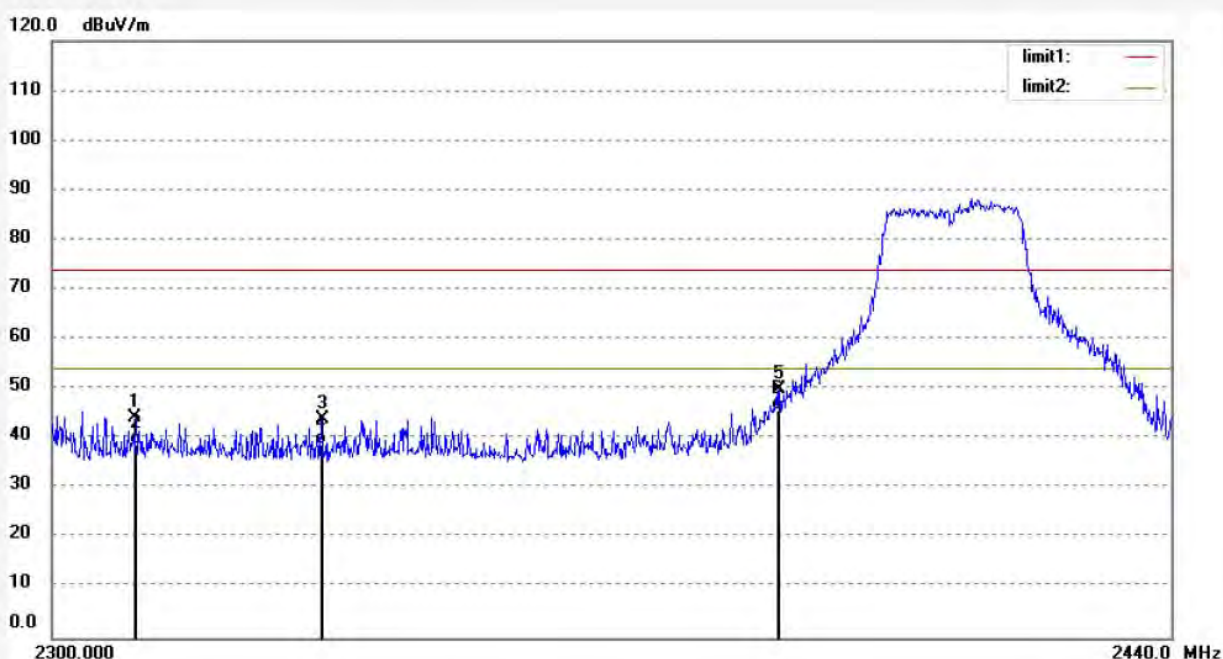

No.	Freq. (MHz)	Reading (dBuV/m)	Factor (dB)	Result (dBuV/m)	Limit (dBuV/m)	Margin (dB)	Detector	Height (cm)	Degree (deg.)	Remark
1	2310.000	51.99	-7.81	44.18	74.00	-29.82	peak			
2	2310.000	46.68	-7.81	38.87	54.00	-15.13	AVG			
3	2332.916	51.85	-7.79	44.06	74.00	-29.94	peak			
4	2332.916	46.66	-7.79	38.87	54.00	-15.13	AVG			
5	2390.000	57.59	-7.53	50.06	74.00	-23.94	peak			
6	2390.000	53.26	-7.53	45.73	54.00	-8.27	AVG			



ACCURATE TECHNOLOGY CO., LTD.

F1,Bldg.A,Changyuan New Material Port Keyuan Rd,
Science & Industry Park,Nanshan Shenzhen,P.R.China

Site: 966 chamber
Tel:+86-0755-26503290
Fax:+86-0755-26503396

Job No.: Bob #2562
Standard: FCC 15C PK
Test item: Radiation Test
Temp.(C)/Hum.(%) 24 C / 48 %
EUT: TV BOX
Mode: TX Channel 11(802.11n)
Model: IS-TV1200K
Manufacturer: SWAGTEK

Polarization: Horizontal
Power Source: AC 120V/60Hz
Date: 12/06/27/
Time: 1/18/30
Engineer Signature:
Distance: 3m

Note: Report NO.:ATE20121277

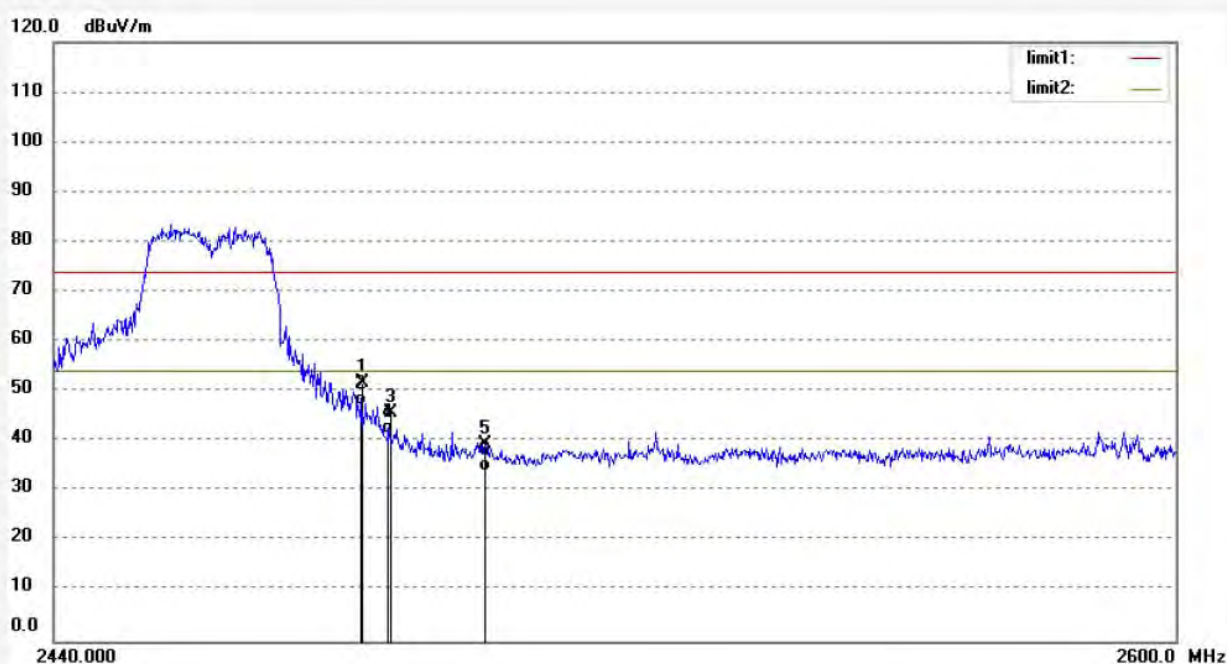

No.	Freq. (MHz)	Reading (dBuV/m)	Factor (dB)	Result (dBuV/m)	Limit (dBuV/m)	Margin (dB)	Detector	Height (cm)	Degree (deg.)	Remark
1	2483.500	59.25	-7.37	51.88	74.00	-22.12	peak			
2	2483.500	54.58	-7.37	47.21	54.00	-6.79	AVG			
3	2487.000	53.25	-7.38	45.87	74.00	-28.13	peak			
4	2487.000	48.85	-7.38	41.47	54.00	-12.53	AVG			
5	2500.363	46.95	-7.40	39.55	74.00	-34.45	peak			
6	2500.363	41.45	-7.40	34.05	54.00	-19.95	AVG			



ACCURATE TECHNOLOGY CO., LTD.

F1,Bldg,A,Changyuan New Material Port Keyuan Rd,
Science & Industry Park,Nanshan Shenzhen,P.R.China

Site: 966 chamber
Tel:+86-0755-26503290
Fax:+86-0755-26503396

Job No.: Bob #2561
Standard: FCC 15C PK
Test item: Radiation Test
Temp.(C)/Hum.(%) 24 C / 48 %
EUT: TV BOX
Mode: TX Channel 11(802.11n)
Model: IS-TV1200K
Manufacturer: SWAGTEK

Polarization: Vertical
Power Source: AC 120V/60Hz
Date: 12/06/27/
Time: 1/13/39
Engineer Signature:
Distance: 3m

Note: Report NO.:ATE20121277

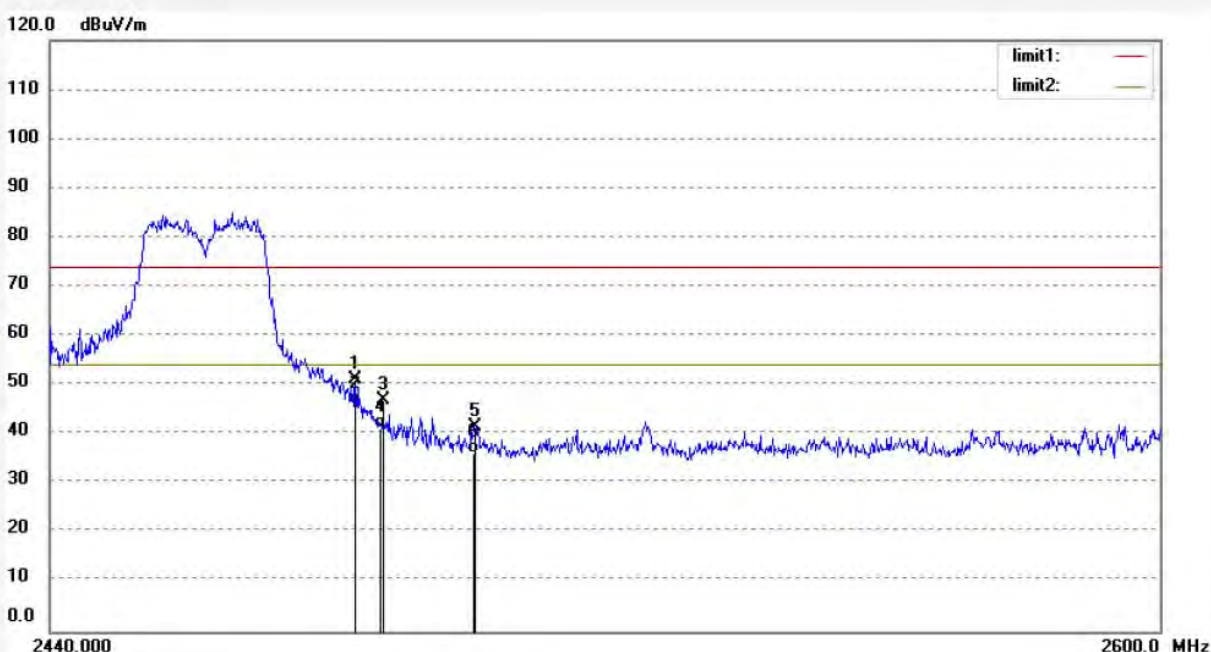

No.	Freq. (MHz)	Reading (dBuV/m)	Factor (dB)	Result (dBuV/m)	Limit (dBuV/m)	Margin (dB)	Detector	Height (cm)	Degree (deg.)	Remark
1	2483.500	58.58	-7.37	51.21	74.00	-22.79	peak			
2	2483.500	53.48	-7.37	46.11	54.00	-7.89	AVG			
3	2487.000	54.36	-7.38	46.98	74.00	-27.02	peak			
4	2487.000	48.69	-7.38	41.31	54.00	-12.69	AVG			
5	2500.000	48.91	-7.40	41.51	74.00	-32.49	peak			
6	2500.000	43.69	-7.40	36.29	54.00	-17.71	AVG			



ACCURATE TECHNOLOGY CO., LTD.

F1,Bldg,A,Changyuan New Material Port Keyuan Rd,
Science & Industry Park,Nanshan Shenzhen,P.R.China

Site: 966 chamber
Tel:+86-0755-26503290
Fax:+86-0755-26503396

Job No.: Bob #2566
Standard: FCC 15C PK
Test item: Radiation Test
Temp.(C)/Hum.(%) 24 C / 48 %
EUT: TV BOX
Mode: TX Channel 3(802.11n)
Model: IS-TV1200K
Manufacturer: SWAGTEK

Polarization: Horizontal
Power Source: AC 120V/60Hz
Date: 12/06/27/
Time: 1/36/56
Engineer Signature:
Distance: 3m

Note: Report NO.:ATE20121277

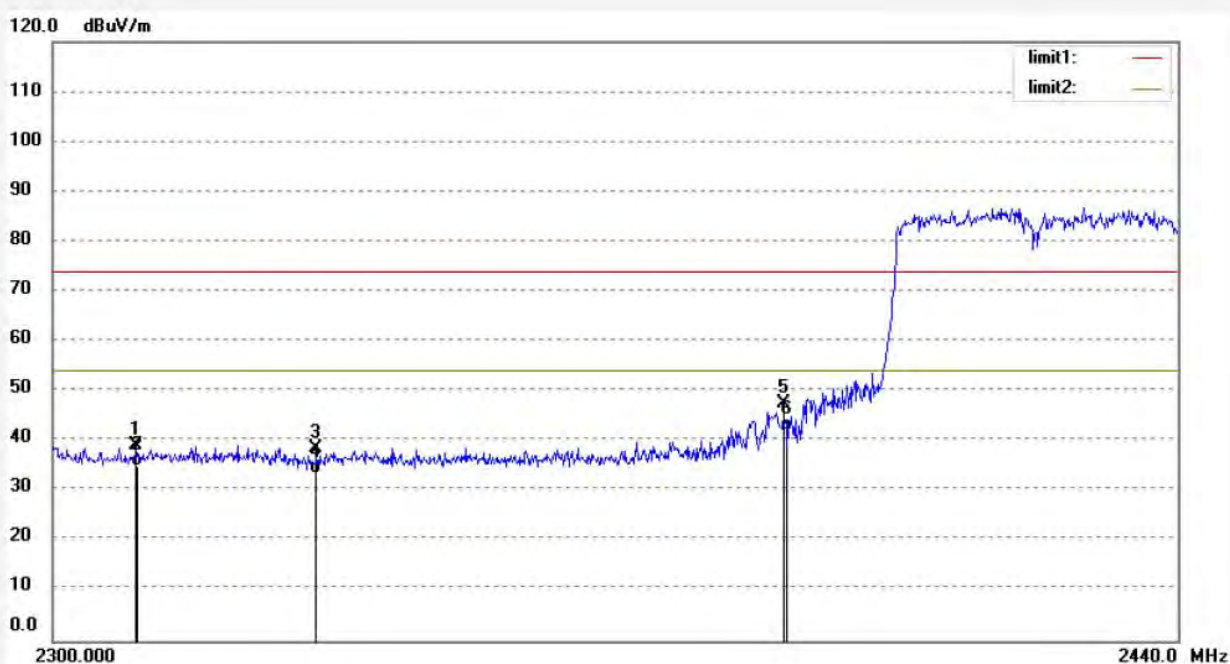

No.	Freq. (MHz)	Reading (dBuV/m)	Factor (dB)	Result (dBuV/m)	Limit (dBuV/m)	Margin (dB)	Detector	Height (cm)	Degree (deg.)	Remark
1	2310.000	47.00	-7.81	39.19	74.00	-34.81	peak			
2	2310.000	42.90	-7.81	35.09	54.00	-18.91	AVG			
3	2332.000	46.38	-7.81	38.57	74.00	-35.43	peak			
4	2332.000	41.15	-7.81	33.34	54.00	-20.66	AVG			
5	2390.000	54.96	-7.53	47.43	74.00	-26.57	peak			
6	2390.000	49.69	-7.53	42.16	54.00	-11.84	AVG			



ACCURATE TECHNOLOGY CO., LTD.

F1,Bldg,A,Changyuan New Material Port Keyuan Rd,
Science & Industry Park,Nanshan Shenzhen,P.R.China

Site: 966 chamber
Tel:+86-0755-26503290
Fax:+86-0755-26503396

Job No.: Bob #2565
Standard: FCC 15C PK
Test item: Radiation Test
Temp.(C)/Hum.(%) 24 C / 48 %
EUT: TV BOX
Mode: TX Channel 3(802.11n)
Model: IS-TV1200K
Manufacturer: SWAGTEK

Polarization: Vertical
Power Source: AC 120V/60Hz
Date: 12/06/27/
Time: 1/32/21
Engineer Signature:
Distance: 3m

Note: Report NO.:ATE20121277

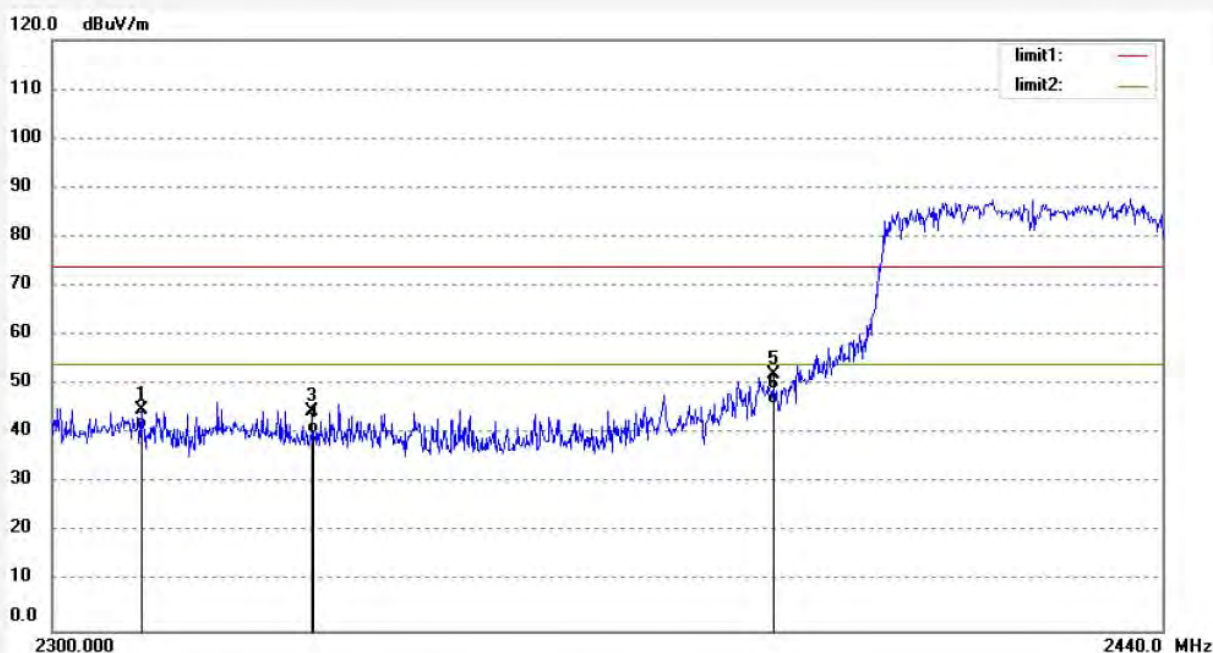

No.	Freq. (MHz)	Reading (dBuV/m)	Factor (dB)	Result (dBuV/m)	Limit (dBuV/m)	Margin (dB)	Detector	Height (cm)	Degree (deg.)	Remark
1	2310.920	52.60	-7.81	44.79	74.00	-29.21	peak			
2	2310.920	48.81	-7.81	41.00	54.00	-13.00	AVG			
3	2332.000	52.42	-7.81	44.61	74.00	-29.39	peak			
4	2332.000	47.96	-7.81	40.15	54.00	-13.85	AVG			
5	2390.000	59.69	-7.53	52.16	74.00	-21.84	peak			
6	2390.000	53.64	-7.53	46.11	54.00	-7.89	AVG			



ACCURATE TECHNOLOGY CO., LTD.

F1,Bldg,A,Changyuan New Material Port Keyuan Rd,
Science & Industry Park,Nanshan Shenzhen,P.R.China

Site: 966 chamber
Tel:+86-0755-26503290
Fax:+86-0755-26503396

Job No.: Bob #2563	Polarization: Horizontal
Standard: FCC 15C PK	Power Source: AC 120V/60Hz
Test item: Radiation Test	Date: 12/06/27/
Temp.(C)/Hum.(%) 24 C / 48 %	Time: 1/23/00
EUT: TV BOX	Engineer Signature:
Mode: TX Channel 9(802.11n)	Distance: 3m
Model: IS-TV1200K	
Manufacturer: SWAGTEK	

Note: Report NO.:ATE20121277

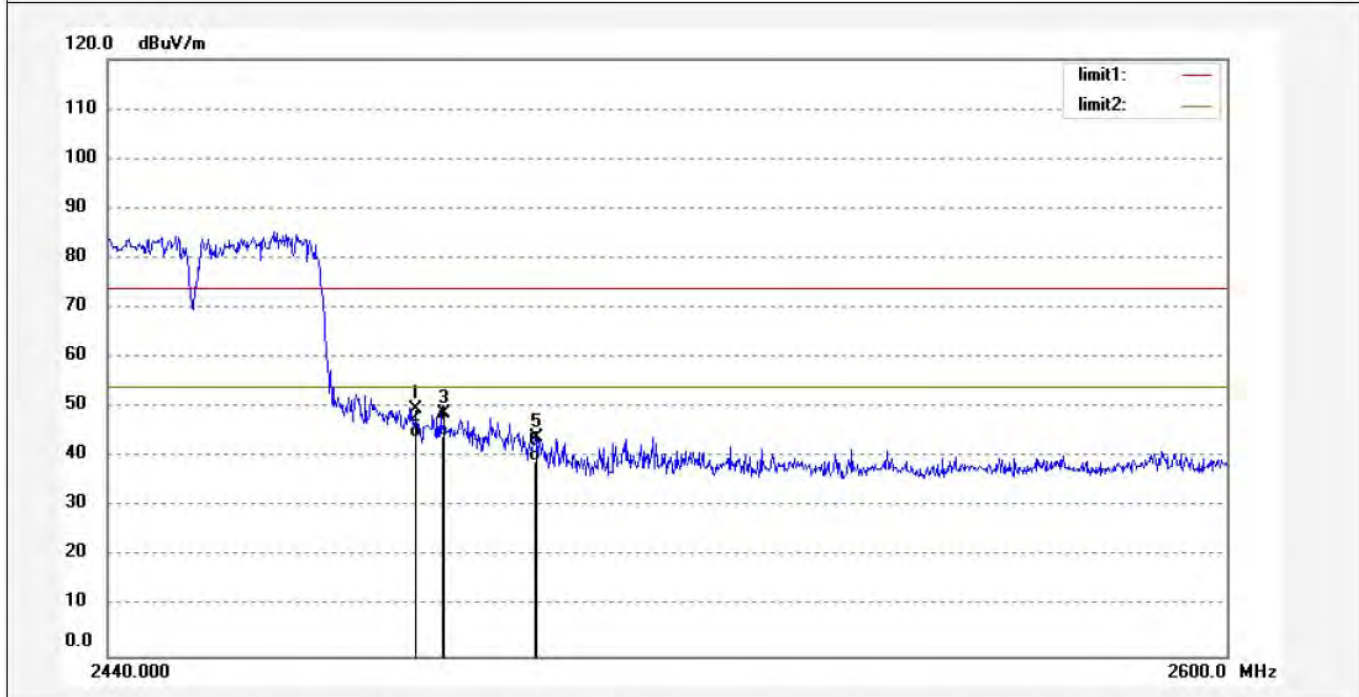

No.	Freq. (MHz)	Reading (dBuV/m)	Factor (dB)	Result (dBuV/m)	Limit (dBuV/m)	Margin (dB)	Detector	Height (cm)	Degree (deg.)	Remark
1	2483.500	56.96	-7.37	49.59	74.00	-24.41	peak			
2	2483.500	51.44	-7.37	44.07	54.00	-9.93	AVG			
3	2487.000	56.27	-7.38	48.89	74.00	-25.11	peak			
4	2487.000	51.77	-7.38	44.39	54.00	-9.61	AVG			
5	2500.000	51.33	-7.40	43.93	74.00	-30.07	peak			
6	2500.000	46.47	-7.40	39.07	54.00	-14.93	AVG			



ACCURATE TECHNOLOGY CO., LTD.

F1,Bldg,A,Changyuan New Material Port Keyuan Rd,
Science & Industry Park,Nanshan Shenzhen,P.R.China

Site: 966 chamber
Tel:+86-0755-26503290
Fax:+86-0755-26503396

Job No.: Bob #2564	Polarization: Vertical
Standard: FCC 15C PK	Power Source: AC 120V/60Hz
Test item: Radiation Test	Date: 12/06/27/
Temp.(C)/Hum.(%) 24 C / 48 %	Time: 1/28/21
EUT: TV BOX	Engineer Signature:
Mode: TX Channel 9(802.11n)	Distance: 3m
Model: IS-TV1200K	
Manufacturer: SWAGTEK	

Note: Report NO.:ATE20121277

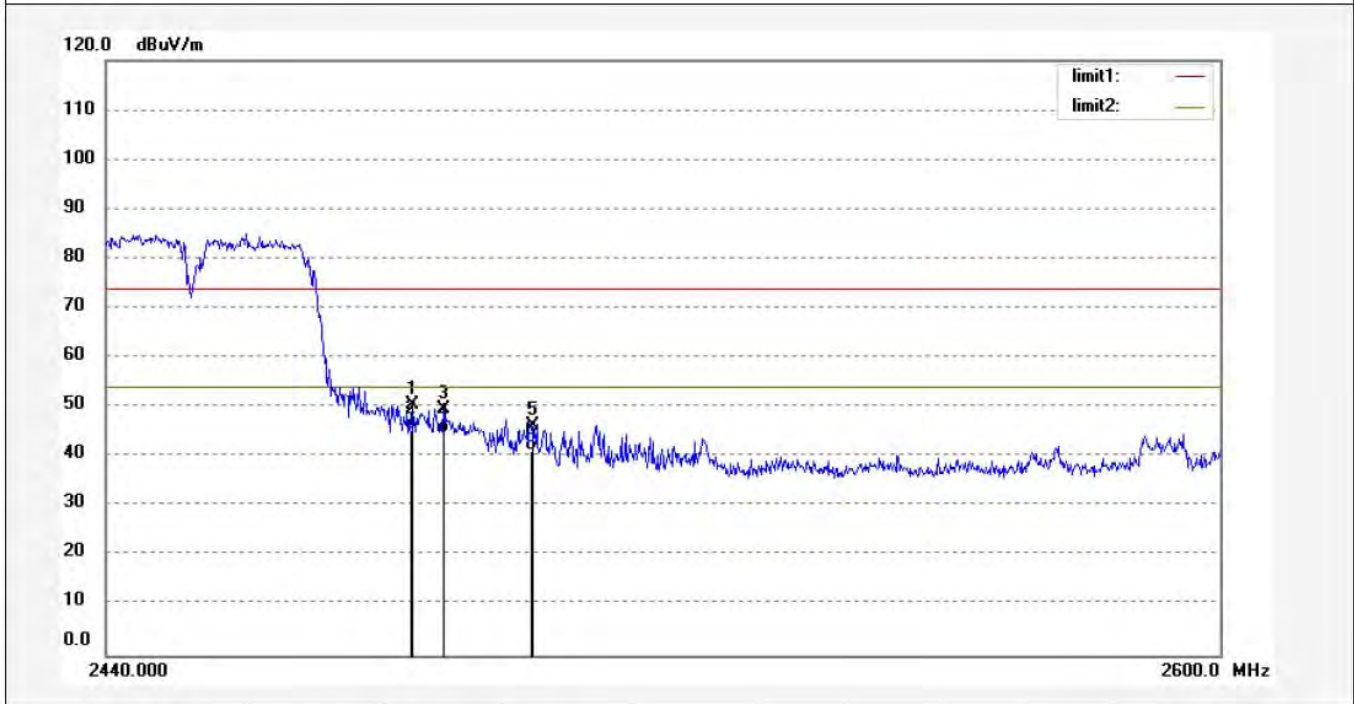

No.	Freq. (MHz)	Reading (dBuV/m)	Factor (dB)	Result (dBuV/m)	Limit (dBuV/m)	Margin (dB)	Detector	Height (cm)	Degree (deg.)	Remark
1	2483.500	57.99	-7.37	50.62	74.00	-23.38	peak			
2	2483.500	52.85	-7.37	45.48	54.00	-8.52	AVG			
3	2487.507	57.17	-7.38	49.79	74.00	-24.21	peak			
4	2487.507	52.16	-7.38	44.78	54.00	-9.22	AVG			
5	2500.000	53.64	-7.40	46.24	74.00	-27.76	peak			
6	2500.000	48.59	-7.40	41.19	54.00	-12.81	AVG			

9. RADIATED SPURIOUS EMISSION TEST

9.1. Block Diagram of Test Setup

9.1.1. Block diagram of connection between the EUT and peripherals

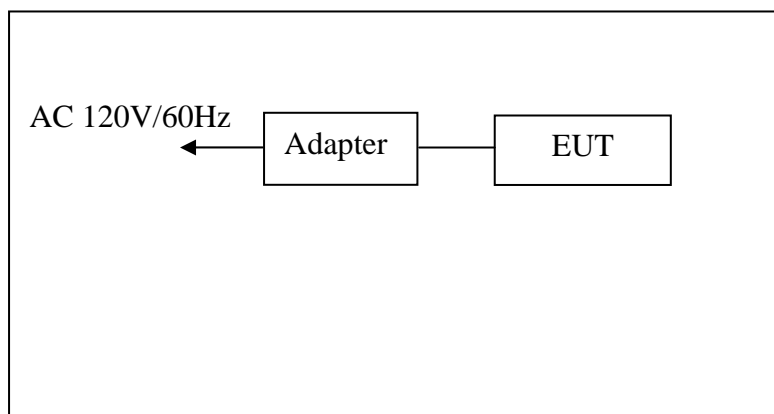

Setup: Transmitting mode

(EUT: TV BOX)

9.1.2. Semi-Anechoic Chamber Test Setup Diagram

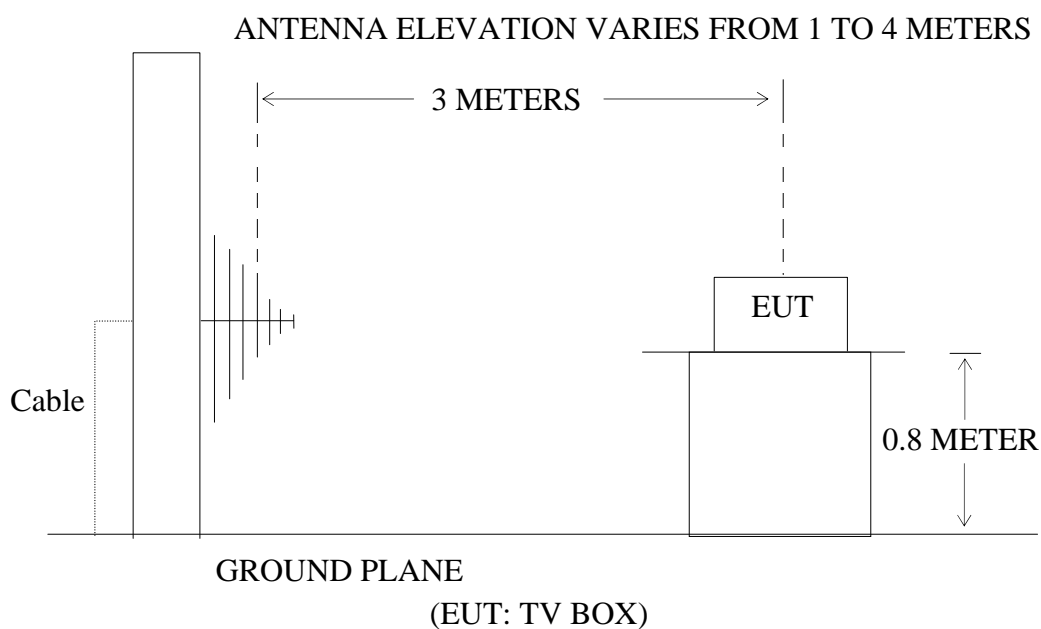

(EUT: TV BOX)

9.2.The Limit For Section 15.247(d)

Section 15.247(d): In any 100 kHz bandwidth outside the frequency band in which the spread spectrum or digitally modulated intentional radiator is operating, the radio frequency power that is produced by the intentional radiator shall be at least 20 dB below that in the 100 kHz bandwidth within the band that contains the highest level of the desired power, based on either an RF conducted or a radiated measurement, provided the transmitter demonstrates compliance with the peak conducted power limits. If the transmitter complies with the conducted power limits based on the use of RMS averaging over a time interval, as permitted under paragraph (b)(3) of this section, the attenuation required under this paragraph shall be 30 dB instead of 20 dB. Attenuation below the general limits specified in Section 15.209(a) is not required. In addition, radiated emissions which fall in the restricted bands, as defined in Section 15.205(a), must also comply with the radiated emission limits specified in Section 15.209(a).

9.3.Restricted bands of operation

9.3.1.FCC Part 15.205 Restricted bands of operation

(a) Except as shown in paragraph (d) of this section, Only spurious emissions are permitted in any of the frequency bands listed below:

MHz	MHz	MHz	GHz
0.090-0.110	16.42-16.423	399.9-410	4.5-5.15
¹ 0.495-0.505	16.69475-16.69525	608-614	5.35-5.46
2.1735-2.1905	16.80425-16.80475	960-1240	7.25-7.75
4.125-4.128	25.5-25.67	1300-1427	8.025-8.5
4.17725-4.17775	37.5-38.25	1435-1626.5	9.0-9.2
4.20725-4.20775	73-74.6	1645.5-1646.5	9.3-9.5
6.215-6.218	74.8-75.2	1660-1710	10.6-12.7
6.26775-6.26825	108-121.94	1718.8-1722.2	13.25-13.4
6.31175-6.31225	123-138	2200-2300	14.47-14.5
8.291-8.294	149.9-150.05	2310-2390	15.35-16.2
8.362-8.366	156.52475-156.52525	2483.5-2500	17.7-21.4
8.37625-8.38675	156.7-156.9	2690-2900	22.01-23.12
8.41425-8.41475	162.0125-167.17	3260-3267	23.6-24.0
12.29-12.293	167.72-173.2	3332-3339	31.2-31.8
12.51975-12.52025	240-285	3345.8-3358	36.43-36.5
12.57675-12.57725	322-335.4	3600-4400	(²)
13.36-13.41			

¹Until February 1, 1999, this restricted band shall be 0.490-0.510

²Above 38.6

(b) Except as provided in paragraphs (d) and (e), the field strength of emission appearing within these frequency bands shall not exceed the limits shown in Section 15.209. At frequencies equal to or less than 1000MHz, Compliance with the limits in Section 15.209 shall be demonstrated using measurement instrumentation employing a CISPR quasi-peak detector. Above 1000MHz, compliance with the emission limits in Section 15.209 shall be demonstrated based on the average value of the measured emissions. The provisions in Section 15.35 apply to these measurements.

9.4. Configuration of EUT on Measurement

The following equipment are installed on Radiated Emission Measurement to meet the commission requirements and operating regulations in a manner which tends to maximize its emission characteristics in normal application.

9.4.1. TV BOX (EUT)

Model Number : IS-TV1200K
 Serial Number : N/A
 Manufacturer : SWAGTEK

9.5. Operating Condition of EUT

9.5.1. Setup the EUT and simulator as shown as Section 9.1.

9.5.2. Turn on the power of all equipment.

9.5.3. Let the EUT work in TX modes measure it. The transmit frequency are 2412-2462 and 2422-2452MHz. We select 2412MHz, 2437MHz, 2462MHz and 2422MHz, 2437MHz, 2452MHz TX frequency to transmit.

9.6. Test Procedure

The EUT and its simulators are placed on a turntable, which is 0.8 meter high above ground. The turntable can rotate 360 degrees to determine the position of the maximum emission level. EUT is set 3.0 meters away from the receiving antenna, which is mounted on an antenna tower. The antenna can be moved up and down between 1.0 meter and 4 meters to find out the maximum emission level. Broadband antenna (calibrated bilog antenna) is used as receiving antenna. Both horizontal and vertical polarizations of the antenna are set on measurement. In order to find the maximum emission levels, all of the interface cables must be manipulated according to ANSI C63.4: 2003 on radiated emission measurement. The EUT was tested in 3 orthogonal planes.

The worst-case data rate for this channel to be 1Mbps for 802.11b mode and 6Mbps for 802.11g mode and 150Mbps for 802.11n mode, based on previous with 802.11 WLAN product design architectures.

The bandwidth of test receiver is set at 9kHz in below 30MHz. and set at 120kHz in 30-1000MHz, and 1MHz in above 1000MHz.

The frequency range from 9kHz to 25GHz is checked.

The final measurement in band 9-90kHz, 110-490kHz and above 1000MHz is performed with Average detector. Except those frequency bands mention above, the final measurement for frequencies below 1000MHz is performed with Quasi Peak detector.

The field strength is calculated by adding the antenna factor, and cable loss, and subtracting the amplifier gain from the measured reading. The basic equation calculation is as follows:

Result = Reading + Corrected Factor

Where Corrected Factor = Antenna Factor + Cable Loss – Amplifier Gain

9.7. The Field Strength of Radiation Emission Measurement Results

PASS.

Date of Test:	June 28, 2012	Temperature:	25°C
EUT:	TV BOX	Humidity:	50%
Model No.:	IS-TV1200K	Power Supply:	AC 120V/60HZ
Test Mode:	802.11b Channel Low 2412MHz	Test Engineer:	Pei

For Below 30MHz

Frequency (MHz)	Reading (dBμV/m)	Factor(dB) Corr.	Result (dBμV/m)	Limit (dBμV/m)	Margin (dB)	Polarization
	QP		QP	QP	QP	
-	-	-	-	-	-	X
-	-	-	-	-	-	Y
-	-	-	-	-	-	Z

For 30MHz-1000MHz

Corrected Factor = Antenna Factor + Cable Loss – Amplifier Gain

Frequency (MHz)	Reading (dBμV/m)	Factor Corr. (dB)	Result (dBμV/m)	Limit (dBμV/m)	Margin (dB)	Polarization
	QP		QP	QP	QP	
602.9287	13.44	25.59	39.03	46.00	-6.97	Vertical
862.8015	11.04	28.64	39.68	46.00	-6.32	Vertical
945.3336	11.39	29.46	40.85	46.00	-5.15	Vertical
421.3287	15.80	23.16	38.96	46.00	-7.04	Horizontal
815.6352	12.59	28.02	40.61	46.00	-5.39	Horizontal
935.4214	11.01	29.26	40.27	46.00	-5.73	Horizontal

For 1GHz-25GHz

Corrected Factor = Antenna Factor + Cable Loss – Amplifier Gain

Frequency (MHz)	Reading(dBμV/m)		Factor Corr. (dB)	Result(dBμV/m)		Limit(dBμV/m)		Margin(dBμV/m)		Polarization
	AV	PEAK		AV	PEAK	AV	PEAK	AV	PEAK	
-	-	-	-	-	-	-	-	-	-	Vertical
-	-	-	-	-	-	-	-	-	-	Horizontal

Note: 1. Emissions attenuated more than 20 dB below the permissible value are not reported.**2. *: Denotes restricted band of operation.**

Date of Test:	June 28, 2012	Temperature:	25°C
EUT:	TV BOX	Humidity:	50%
Model No.:	IS-TV1200K	Power Supply:	AC 120V/60HZ
Test Mode:	802.11b Channel Middle 2437MHz	Test Engineer:	Pei

For Below 30MHz

Frequency (MHz)	Reading (dBμV/m)		Factor(dB) Corr.	Result (dBμV/m)		Limit (dBμV/m)	Margin (dB)		Polarization
	QP			QP			QP		
-	-	-	-	-	-	-	-	-	X
-	-	-	-	-	-	-	-	-	Y
-	-	-	-	-	-	-	-	-	Z

For 30MHz-1000MHz

Corrected Factor = Antenna Factor + Cable Loss – Amplifier Gain

Frequency (MHz)	Reading (dBμV/m)		Factor Corr. (dB)	Result (dBμV/m)		Limit (dBμV/m)	Margin (dB)		Polarization
	QP			QP			QP		
605.0509	16.02		25.64	41.66		46.00	-4.34		Vertical
716.2038	13.40		27.05	40.45		46.00	-5.55		Vertical
887.3978	11.71		28.77	40.48		46.00	-5.52		Vertical
644.5531	13.43		26.08	39.51		46.00	-6.49		Horizontal
747.0467	13.62		27.57	41.19		46.00	-4.81		Horizontal
850.7603	11.67		28.36	40.03		46.00	-5.97		Horizontal

For 1GHz-25GHz

Corrected Factor = Antenna Factor + Cable Loss – Amplifier Gain

Frequency (MHz)	Reading(dBμV/m)		Factor Corr. (dB)	Result(dBμV/m)		Limit(dBμV/m)		Margin(dBμV/m)		Polarization
	AV	PEAK		AV	PEAK	AV	PEAK	AV	PEAK	
-	-	-	-	-	-	-	-	-	-	Vertical
-	-	-	-	-	-	-	-	-	-	Horizontal

Note: 1. Emissions attenuated more than 20 dB below the permissible value are not reported.**2. *: Denotes restricted band of operation.**

Date of Test:	June 28, 2012	Temperature:	25°C
EUT:	TV BOX	Humidity:	50%
Model No.:	IS-TV1200K	Power Supply:	AC 120V/60HZ
Test Mode:	802.11b Channel High 2462MHz	Test Engineer:	Pei

For Below 30MHz

Frequency (MHz)	Reading (dBμV/m)	Factor(dB) Corr.	Result (dBμV/m)	Limit (dBμV/m)	Margin (dB)	Polarization
	QP		QP	QP	QP	
-	-	-	-	-	-	X
-	-	-	-	-	-	Y
-	-	-	-	-	-	Z

For 30MHz-1000MHz

Corrected Factor = Antenna Factor + Cable Loss – Amplifier Gain

Frequency (MHz)	Reading (dBμV/m)	Factor Corr. (dB)	Result (dBμV/m)	Limit (dBμV/m)	Margin (dB)	Polarization
	QP		QP	QP	QP	
565.9776	15.02	25.27	40.29	46.00	-5.71	Vertical
644.5531	14.28	26.08	40.36	46.00	-5.64	Vertical
850.7603	12.11	28.36	40.47	46.00	-5.53	Vertical
644.5531	14.60	26.08	40.68	46.00	-5.32	Horizontal
747.0467	12.50	27.57	40.07	46.00	-5.93	Horizontal
850.7603	12.28	28.36	40.64	46.00	-5.36	Horizontal

For 1GHz-25GHz

Corrected Factor = Antenna Factor + Cable Loss – Amplifier Gain

Frequency (MHz)	Reading(dBμV/m)		Factor Corr. (dB)	Result(dBμV/m)		Limit(dBμV/m)		Margin(dBμV/m)		Polarization
	AV	PEAK		AV	PEAK	AV	PEAK	AV	PEAK	
-	-	-	-	-	-	-	-	-	-	Vertical
-	-	-	-	-	-	-	-	-	-	Horizontal

Note: 1. Emissions attenuated more than 20 dB below the permissible value are not reported.**2. *: Denotes restricted band of operation.**

Date of Test:	June 28, 2012	Temperature:	25°C
EUT:	TV BOX	Humidity:	50%
Model No.:	IS-TV1200K	Power Supply:	AC 120V/60HZ
Test Mode:	802.11g Channel Low 2412MHz	Test Engineer:	Pei

For Below 30MHz

Frequency (MHz)	Reading (dBμV/m)	Factor(dB) Corr.	Result (dBμV/m)	Limit (dBμV/m)	Margin (dB)	Polarization
	QP		QP	QP	QP	
-	-	-	-	-	-	X
-	-	-	-	-	-	Y
-	-	-	-	-	-	Z

For 30MHz-1000MHz

Corrected Factor = Antenna Factor + Cable Loss – Amplifier Gain

Frequency (MHz)	Reading (dBμV/m)	Factor Corr. (dB)	Result (dBμV/m)	Limit (dBμV/m)	Margin (dB)	Polarization
	QP		QP	QP	QP	
565.9776	14.29	25.27	39.56	46.00	-6.44	Vertical
605.0509	14.25	25.64	39.89	46.00	-6.11	Vertical
686.6342	12.79	26.37	39.16	46.00	-6.84	Vertical
421.3287	15.17	23.16	38.33	46.00	-7.67	Horizontal
815.6352	12.54	28.02	40.56	46.00	-5.44	Horizontal
887.3978	11.59	28.77	40.36	46.00	-5.64	Horizontal

For 1GHz-25GHz

Corrected Factor = Antenna Factor + Cable Loss – Amplifier Gain

Frequency (MHz)	Reading(dBμV/m)		Factor Corr. (dB)	Result(dBμV/m)		Limit(dBμV/m)		Margin(dBμV/m)		Polarization
	AV	PEAK		AV	PEAK	AV	PEAK	AV	PEAK	
-	-	-	-	-	-	-	-	-	-	Vertical
-	-	-	-	-	-	-	-	-	-	Horizontal

Note: 1. Emissions attenuated more than 20 dB below the permissible value are not reported.**2. *: Denotes restricted band of operation.**

Date of Test:	June 28, 2012	Temperature:	25°C
EUT:	TV BOX	Humidity:	50%
Model No.:	IS-TV1200K	Power Supply:	AC 120V/60HZ
Test Mode:	802.11g Channel Middle 2437MHz	Test Engineer:	Pei

For Below 30MHz

Frequency (MHz)	Reading (dBμV/m)	Factor(dB) Corr.	Result (dBμV/m)	Limit (dBμV/m)	Margin (dB)	Polarization
	QP		QP	QP	QP	
-	-	-	-	-	-	X
-	-	-	-	-	-	Y
-	-	-	-	-	-	Z

For 30MHz-1000MHz

Corrected Factor = Antenna Factor + Cable Loss – Amplifier Gain

Frequency (MHz)	Reading (dBμV/m)	Factor Corr. (dB)	Result (dBμV/m)	Limit (dBμV/m)	Margin (dB)	Polarization
	QP		QP	QP	QP	
498.7303	16.33	23.98	40.31	46.00	-5.69	Vertical
565.9776	15.86	25.27	41.13	46.00	-4.87	Vertical
644.5531	14.95	26.08	41.03	46.00	-4.97	Vertical
389.9874	16.70	21.88	38.58	46.00	-7.42	Horizontal
850.7603	11.78	28.36	40.14	46.00	-5.86	Horizontal
925.6132	11.26	29.16	40.42	46.00	-5.58	Horizontal

For 1GHz-25GHz

Corrected Factor = Antenna Factor + Cable Loss – Amplifier Gain

Frequency (MHz)	Reading(dBμV/m)		Factor Corr. (dB)	Result(dBμV/m)		Limit(dBμV/m)		Margin(dBμV/m)		Polarization
	AV	PEAK		AV	PEAK	AV	PEAK	AV	PEAK	
-	-	-	-	-	-	-	-	-	-	Vertical
-	-	-	-	-	-	-	-	-	-	Horizontal

Note: 1. Emissions attenuated more than 20 dB below the permissible value are not reported.**2. *: Denotes restricted band of operation.**

Date of Test:	June 28, 2012	Temperature:	25°C
EUT:	TV BOX	Humidity:	50%
Model No.:	IS-TV1200K	Power Supply:	AC 120V/60HZ
Test Mode:	802.11g Channel High 2462MHz	Test Engineer:	Pei

For Below 30MHz

Frequency (MHz)	Reading (dBμV/m)	Factor(dB) Corr.	Result (dBμV/m)	Limit (dBμV/m)	Margin (dB)	Polarization
	QP		QP	QP	QP	
-	-	-	-	-	-	X
-	-	-	-	-	-	Y
-	-	-	-	-	-	Z

For 30MHz-1000MHz

Corrected Factor = Antenna Factor + Cable Loss – Amplifier Gain

Frequency (MHz)	Reading (dBμV/m)	Factor Corr. (dB)	Result (dBμV/m)	Limit (dBμV/m)	Margin (dB)	Polarization
	QP		QP	QP	QP	
565.9776	15.66	25.27	40.93	46.00	-5.07	Vertical
686.6342	14.60	26.37	40.97	46.00	-5.03	Vertical
850.7603	12.50	28.36	40.86	46.00	-5.14	Vertical
747.0467	12.99	27.57	40.56	46.00	-5.44	Horizontal
779.2179	13.02	27.83	40.85	46.00	-5.15	Horizontal
850.7603	13.03	28.36	41.39	46.00	-4.61	Horizontal

For 1GHz-25GHz

Corrected Factor = Antenna Factor + Cable Loss – Amplifier Gain

Frequency (MHz)	Reading(dBμV/m)		Factor Corr. (dB)	Result(dBμV/m)		Limit(dBμV/m)		Margin(dBμV/m)		Polarization
	AV	PEAK		AV	PEAK	AV	PEAK	AV	PEAK	
-	-	-	-	-	-	-	-	-	-	Vertical
-	-	-	-	-	-	-	-	-	-	Horizontal

Note: 1. Emissions attenuated more than 20 dB below the permissible value are not reported.**2. *: Denotes restricted band of operation.**

Date of Test:	<u>June 28, 2012</u>	Temperature:	<u>25°C</u>
EUT:	<u>TV BOX</u>	Humidity:	<u>50%</u>
Model No.:	<u>IS-TV1200K</u>	Power Supply:	<u>AC 120V/60HZ</u>
	<u>802.11n Channel Low 2412MHz</u>		
Test Mode:	<u>(20MHz)</u>	Test Engineer:	<u>Pei</u>

For Below 30MHz

Frequency (MHz)	Reading (dB μ V/m)	Factor(dB) Corr.	Result (dB μ V/m)	Limit (dB μ V/m)	Margin (dB)	Polarization
	QP		QP	QP	QP	
-	-	-	-	-	-	X
-	-	-	-	-	-	Y
-	-	-	-	-	-	Z

For 30MHz-1000MHz

Corrected Factor = Antenna Factor + Cable Loss – Amplifier Gain

Frequency (MHz)	Reading (dB μ V/m)	Factor Corr. (dB)	Result (dB μ V/m)	Limit (dB μ V/m)	Margin (dB)	Polarization
	QP		QP	QP	QP	
498.7302	13.56	23.98	37.54	46.00	-8.46	Vertical
605.0507	13.75	25.64	39.39	46.00	-6.61	Vertical
815.6352	9.46	28.02	37.48	46.00	-8.52	Vertical
421.3287	14.17	23.16	37.33	46.00	-8.67	Horizontal
815.6352	12.04	28.02	40.06	46.00	-5.94	Horizontal
887.3976	12.59	28.77	41.36	46.00	-4.64	Horizontal

For 1GHz-25GHz

Corrected Factor = Antenna Factor + Cable Loss – Amplifier Gain

Frequency (MHz)	Reading(dB μ V/m)		Factor Corr. (dB)	Result(dB μ V/m)		Limit(dB μ V/m)		Margin(dB μ V/m)		Polarization
	AV	PEAK		AV	PEAK	AV	PEAK	AV	PEAK	
-	-	-	-	-	-	-	-	-	-	Vertical
-	-	-	-	-	-	-	-	-	-	Horizontal

Note: 1. Emissions attenuated more than 20 dB below the permissible value are not reported.

2. *: Denotes restricted band of operation.

Date of Test:	<u>June 28, 2012</u>	Temperature:	<u>25°C</u>
EUT:	<u>TV BOX</u>	Humidity:	<u>50%</u>
Model No.:	<u>IS-TV1200K</u>	Power Supply:	<u>AC 120V/60HZ</u>
	<u>802.11n Channel Middle 2437MHz</u>		
Test Mode:	<u>(20MHz)</u>	Test Engineer:	<u>Pei</u>

For Below 30MHz

Frequency (MHz)	Reading (dBμV/m)	Factor(dB) Corr.	Result (dBμV/m)	Limit (dBμV/m)	Margin (dB)	Polarization
	QP		QP	QP	QP	
-	-	-	-	-	-	X
-	-	-	-	-	-	Y
-	-	-	-	-	-	Z

For 30MHz-1000MHz

Corrected Factor = Antenna Factor + Cable Loss – Amplifier Gain

Frequency (MHz)	Reading (dBμV/m)	Factor Corr. (dB)	Result (dBμV/m)	Limit (dBμV/m)	Margin (dB)	Polarization
	QP		QP	QP	QP	
498.7303	14.85	23.98	38.83	46.00	-7.17	Vertical
644.5531	14.63	26.08	40.71	46.00	-5.29	Vertical
850.7603	12.92	28.36	41.28	46.00	-4.72	Vertical
421.3287	16.41	23.16	39.57	46.00	-6.43	Horizontal
468.1650	14.81	23.55	38.36	46.00	-7.64	Horizontal
815.6352	10.67	28.02	38.69	46.00	-7.31	Horizontal

For 1GHz-25GHz

Corrected Factor = Antenna Factor + Cable Loss – Amplifier Gain

Frequency (MHz)	Reading(dBμV/m)		Factor Corr. (dB)	Result(dBμV/m)		Limit(dBμV/m)		Margin(dBμV/m)		Polarization
	AV	PEAK		AV	PEAK	AV	PEAK	AV	PEAK	
-	-	-	-	-	-	-	-	-	-	Vertical
-	-	-	-	-	-	-	-	-	-	Horizontal

Note: 1. Emissions attenuated more than 20 dB below the permissible value are not reported.**2. *: Denotes restricted band of operation.**

Date of Test:	<u>June 28, 2012</u>	Temperature:	<u>25°C</u>
EUT:	<u>TV BOX</u>	Humidity:	<u>50%</u>
Model No.:	<u>IS-TV1200K</u>	Power Supply:	<u>AC 120V/60HZ</u>
	<u>802.11n Channel High 2462MHz</u>		
Test Mode:	<u>(20MHz)</u>	Test Engineer:	<u>Pei</u>

For Below 30MHz

Frequency (MHz)	Reading (dBμV/m)	Factor(dB) Corr.	Result (dBμV/m)	Limit (dBμV/m)	Margin (dB)	Polarization
	QP		QP	QP	QP	
-	-	-	-	-	-	X
-	-	-	-	-	-	Y
-	-	-	-	-	-	Z

For 30MHz-1000MHz

Corrected Factor = Antenna Factor + Cable Loss – Amplifier Gain

Frequency (MHz)	Reading (dBμV/m)	Factor Corr. (dB)	Result (dBμV/m)	Limit (dBμV/m)	Margin (dB)	Polarization
	QP		QP	QP	QP	
565.9776	14.87	25.27	40.14	46.00	-5.86	Vertical
686.6342	13.67	26.37	40.04	46.00	-5.96	Vertical
850.7603	12.19	28.36	40.55	46.00	-5.45	Vertical
644.5531	14.93	26.08	41.01	46.00	-4.99	Horizontal
686.6342	14.47	26.37	40.84	46.00	-5.16	Horizontal
850.7603	12.27	28.36	40.63	46.00	-5.37	Horizontal

For 1GHz-25GHz

Corrected Factor = Antenna Factor + Cable Loss – Amplifier Gain

Frequency (MHz)	Reading(dBμV/m)		Factor Corr. (dB)	Result(dBμV/m)		Limit(dBμV/m)		Margin(dBμV/m)		Polarization
	AV	PEAK		AV	PEAK	AV	PEAK	AV	PEAK	
-	-	-	-	-	-	-	-	-	-	Vertical
-	-	-	-	-	-	-	-	-	-	Horizontal

Note: 1. Emissions attenuated more than 20 dB below the permissible value are not reported.**2. *: Denotes restricted band of operation.**

Date of Test:	<u>June 28, 2012</u>	Temperature:	<u>25°C</u>
EUT:	<u>TV BOX</u>	Humidity:	<u>50%</u>
Model No.:	<u>IS-TV1200K</u>	Power Supply:	<u>AC 120V/60HZ</u>
	<u>802.11n Channel Low 2422MHz</u>		
Test Mode:	<u>(40MHz)</u>	Test Engineer:	<u>Pei</u>

For Below 30MHz

Frequency (MHz)	Reading (dBμV/m)	Factor(dB) Corr.	Result (dBμV/m)	Limit (dBμV/m)	Margin (dB)	Polarization
	QP		QP	QP	QP	
-	-	-	-	-	-	X
-	-	-	-	-	-	Y
-	-	-	-	-	-	Z

For 30MHz-1000MHz

Corrected Factor = Antenna Factor + Cable Loss – Amplifier Gain

Frequency (MHz)	Reading (dBμV/m)	Factor Corr. (dB)	Result (dBμV/m)	Limit (dBμV/m)	Margin (dB)	Polarization
	QP		QP	QP	QP	
644.5531	11.76	26.08	37.84	46.00	-8.16	Vertical
779.2179	11.58	27.83	39.41	46.00	-6.59	Vertical
850.7603	11.27	28.36	39.63	46.00	-6.37	Vertical
602.9287	12.42	25.59	38.01	46.00	-7.99	Horizontal
644.5531	13.94	26.08	40.02	46.00	-5.98	Horizontal
850.7603	11.81	28.36	40.17	46.00	-5.83	Horizontal

For 1GHz-25GHz

Corrected Factor = Antenna Factor + Cable Loss – Amplifier Gain

Frequency (MHz)	Reading(dBμV/m)		Factor Corr. (dB)	Result(dBμV/m)		Limit(dBμV/m)		Margin(dBμV/m)		Polarization
	AV	PEAK		AV	PEAK	AV	PEAK	AV	PEAK	
-	-	-	-	-	-	-	-	-	-	Vertical
-	-	-	-	-	-	-	-	-	-	Horizontal

Note: 1. Emissions attenuated more than 20 dB below the permissible value are not reported.

2. *: Denotes restricted band of operation.

Date of Test:	<u>June 28, 2012</u>	Temperature:	<u>25°C</u>
EUT:	<u>TV BOX</u>	Humidity:	<u>50%</u>
Model No.:	<u>IS-TV1200K</u>	Power Supply:	<u>AC 120V/60HZ</u>
	<u>802.11n Channel Middle 2437MHz</u>		
Test Mode:	<u>(40MHz)</u>	Test Engineer:	<u>Pei</u>

For Below 30MHz

Frequency (MHz)	Reading (dBμV/m)	Factor(dB) Corr.	Result (dBμV/m)	Limit (dBμV/m)	Margin (dB)	Polarization
	QP		QP	QP	QP	
-	-	-	-	-	-	X
-	-	-	-	-	-	Y
-	-	-	-	-	-	Z

For 30MHz-1000MHz

Corrected Factor = Antenna Factor + Cable Loss – Amplifier Gain

Frequency (MHz)	Reading (dBμV/m)	Factor Corr. (dB)	Result (dBμV/m)	Limit (dBμV/m)	Margin (dB)	Polarization
	QP		QP	QP	QP	
565.9776	14.43	25.27	39.70	46.00	-6.30	Vertical
747.0467	10.72	27.57	38.29	46.00	-7.71	Vertical
925.6132	9.53	29.16	38.69	46.00	-7.31	Vertical
605.0509	13.42	25.64	39.06	46.00	-6.94	Horizontal
644.5531	14.83	26.08	40.91	46.00	-5.09	Horizontal
850.7603	12.04	28.36	40.40	46.00	-5.60	Horizontal

For 1GHz-25GHz

Corrected Factor = Antenna Factor + Cable Loss – Amplifier Gain

Frequency (MHz)	Reading(dBμV/m)		Factor Corr. (dB)	Result(dBμV/m)		Limit(dBμV/m)		Margin(dBμV/m)		Polarization
	AV	PEAK		AV	PEAK	AV	PEAK	AV	PEAK	
-	-	-	-	-	-	-	-	-	-	Vertical
-	-	-	-	-	-	-	-	-	-	Horizontal

Note: 1. Emissions attenuated more than 20 dB below the permissible value are not reported.**2. *: Denotes restricted band of operation.**

Date of Test:	<u>June 28, 2012</u>	Temperature:	<u>25°C</u>
EUT:	<u>TV BOX</u>	Humidity:	<u>50%</u>
Model No.:	<u>IS-TV1200K</u>	Power Supply:	<u>AC 120V/60HZ</u>
	<u>802.11n Channel High 2452MHz</u>		
Test Mode:	<u>(40MHz)</u>	Test Engineer:	<u>Pei</u>

For Below 30MHz

Frequency (MHz)	Reading (dBμV/m)	Factor(dB) Corr.	Result (dBμV/m)	Limit (dBμV/m)	Margin (dB)	Polarization
	QP		QP	QP	QP	
-	-	-	-	-	-	X
-	-	-	-	-	-	Y
-	-	-	-	-	-	Z

For 30MHz-1000MHz

Corrected Factor = Antenna Factor + Cable Loss – Amplifier Gain

Frequency (MHz)	Reading (dBμV/m)	Factor Corr. (dB)	Result (dBμV/m)	Limit (dBμV/m)	Margin (dB)	Polarization
	QP		QP	QP	QP	
565.9776	12.78	25.27	38.05	46.00	-7.95	Vertical
605.0509	12.69	25.64	38.33	46.00	-7.67	Vertical
850.7603	12.46	28.36	40.82	46.00	-5.18	Vertical
644.5531	13.90	26.08	39.98	46.00	-6.02	Horizontal
850.7603	12.42	28.36	40.78	46.00	-5.22	Horizontal
887.3978	11.53	28.77	40.30	46.00	-5.70	Horizontal

For 1GHz-25GHz

Corrected Factor = Antenna Factor + Cable Loss – Amplifier Gain

Frequency (MHz)	Reading(dBμV/m)		Factor Corr. (dB)	Result(dBμV/m)		Limit(dBμV/m)		Margin(dBμV/m)		Polarization
	AV	PEAK		AV	PEAK	AV	PEAK	AV	PEAK	
-	-	-	-	-	-	-	-	-	-	Vertical
-	-	-	-	-	-	-	-	-	-	Horizontal

Note: 1. Emissions attenuated more than 20 dB below the permissible value are not reported.**2. *: Denotes restricted band of operation.**



ACCURATE TECHNOLOGY CO., LTD.

F1,Bldg,A,Changyuan New Material Port Keyuan Rd,
Science & Industry Park,Nanshan Shenzhen,P.R.China

Site: 966 chamber
Tel:+86-0755-26503290
Fax:+86-0755-26503396

Job No.: Bob #1925	Polarization: Horizontal
Standard: FCC Class B 3M Radiated	Power Source: AC 120V/60Hz
Test item: Radiation Test	Date: 12/06/28/
Temp.(C)/Hum.(%) 25 C / 51 %	Time: 10/26/18
EUT: TV BOX	Engineer Signature:
Mode: TX Channel 1(802.11b)	Distance: 3m
Model: IS-TV1200K	
Manufacturer: SWAGTEK	

Note: Report NO.:ATE20121277

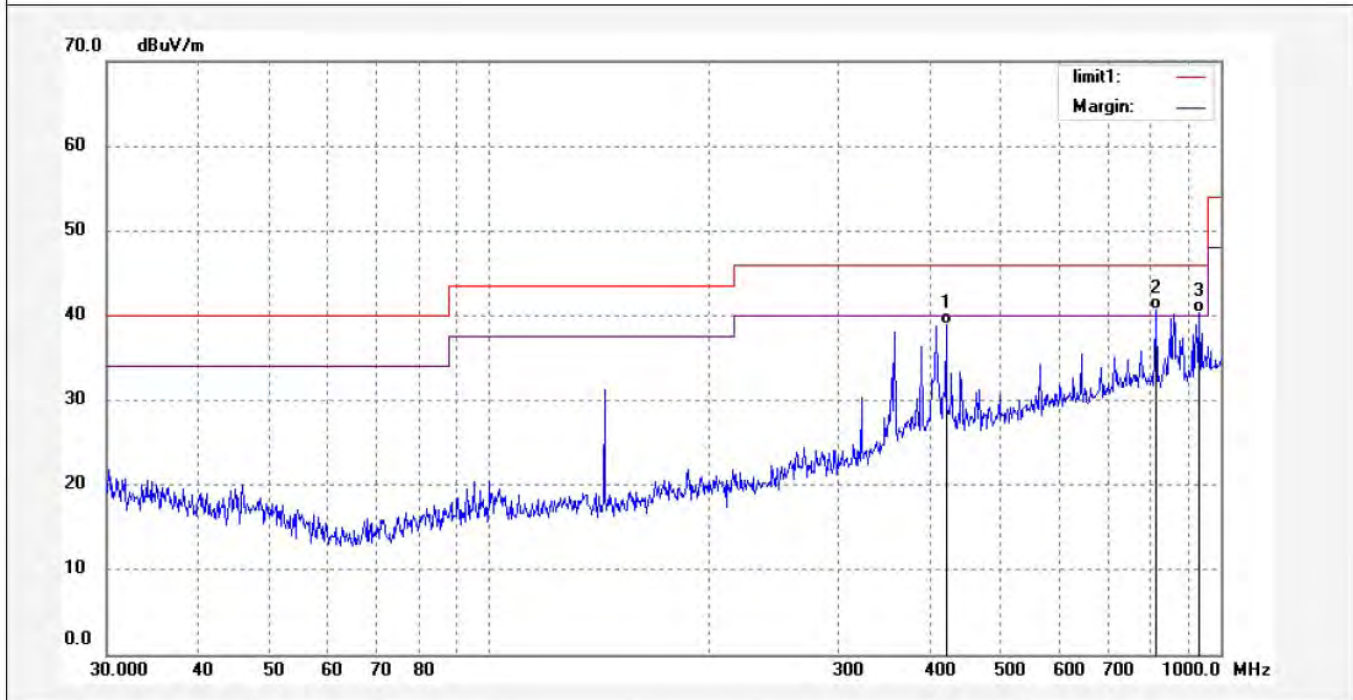

No.	Freq. (MHz)	Reading (dBuV/m)	Factor (dB)	Result (dBuV/m)	Limit (dBuV/m)	Margin (dB)	Detector	Height (cm)	Degree (deg.)	Remark
1	421.3287	15.80	23.16	38.96	46.00	-7.04	QP			
2	815.6352	12.59	28.02	40.61	46.00	-5.39	QP			
3	935.4214	11.01	29.26	40.27	46.00	-5.73	QP			



ACCURATE TECHNOLOGY CO., LTD.

F1,Bldg,A,Changyuan New Material Port Keyuan Rd,
Science & Industry Park,Nanshan Shenzhen,P.R.China

Site: 966 chamber
Tel:+86-0755-26503290
Fax:+86-0755-26503396

Job No.: Bob #1924	Polarization: Vertical
Standard: FCC Class B 3M Radiated	Power Source: AC 120V/60Hz
Test item: Radiation Test	Date: 12/06/28/
Temp.(C)/Hum.(%) 25 C / 51 %	Time: 10/23/36
EUT: TV BOX	Engineer Signature:
Mode: TX Channel 1(802.11b)	Distance: 3m
Model: IS-TV1200K	
Manufacturer: SWAGTEK	

Note: Report NO.:ATE20121277

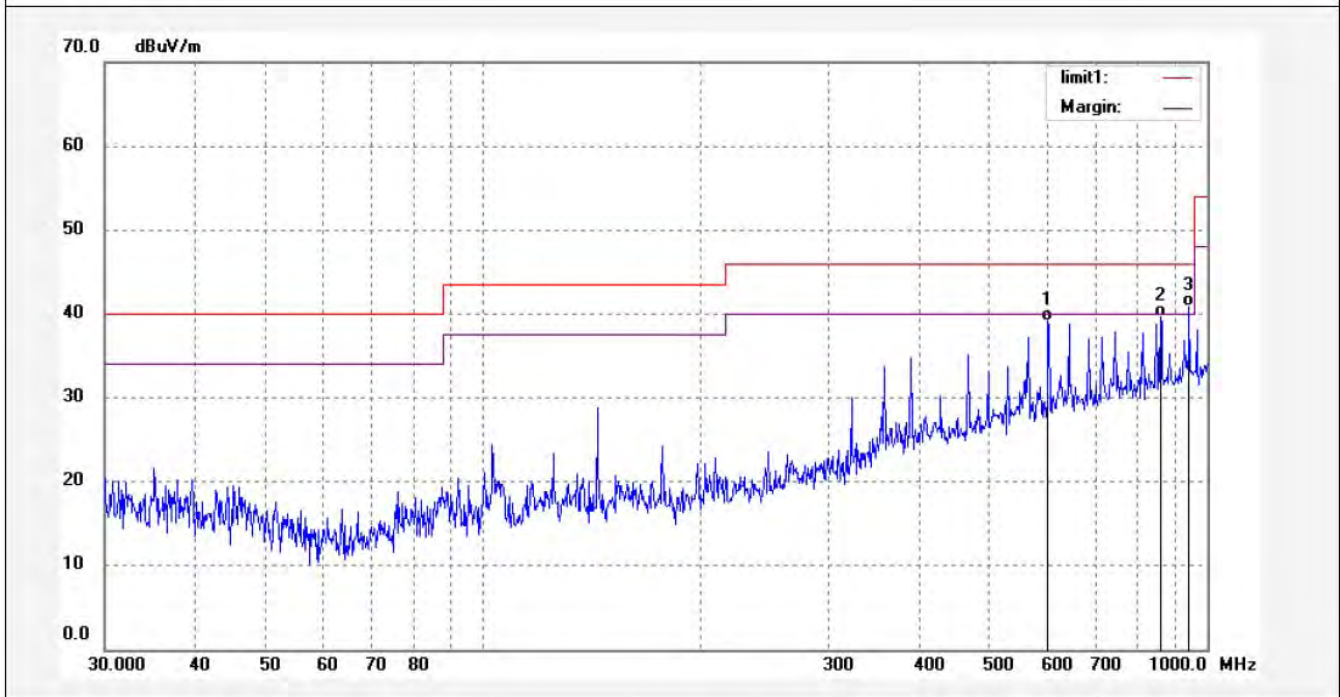

No.	Freq. (MHz)	Reading (dBuV/m)	Factor (dB)	Result (dBuV/m)	Limit (dBuV/m)	Margin (dB)	Detector	Height (cm)	Degree (deg.)	Remark
1	602.9287	13.44	25.59	39.03	46.00	-6.97	QP			
2	862.8015	11.04	28.64	39.68	46.00	-6.32	QP			
3	945.3336	11.39	29.46	40.85	46.00	-5.15	QP			



ACCURATE TECHNOLOGY CO., LTD.

F1,Bldg,A,Changyuan New Material Port Keyuan Rd,
Science & Industry Park,Nanshan Shenzhen,P.R.China

Site: 966 chamber
Tel:+86-0755-26503290
Fax:+86-0755-26503396

Job No.: Bob #2567
Standard: FCC Class B 3M Radiated
Test item: Radiation Test
Temp.(C)/Hum.(%) 24 C / 48 %
EUT: TV BOX
Mode: TX Channel 1 (802.11b)
Model: IS-TV1200K
Manufacturer: SWAGTEK

Polarization: Horizontal
Power Source: AC 120V/60Hz
Date: 12/06/29/
Time: 11:40:11
Engineer Signature: Bob
Distance: 3m

Note: Report No.:ATE20121277

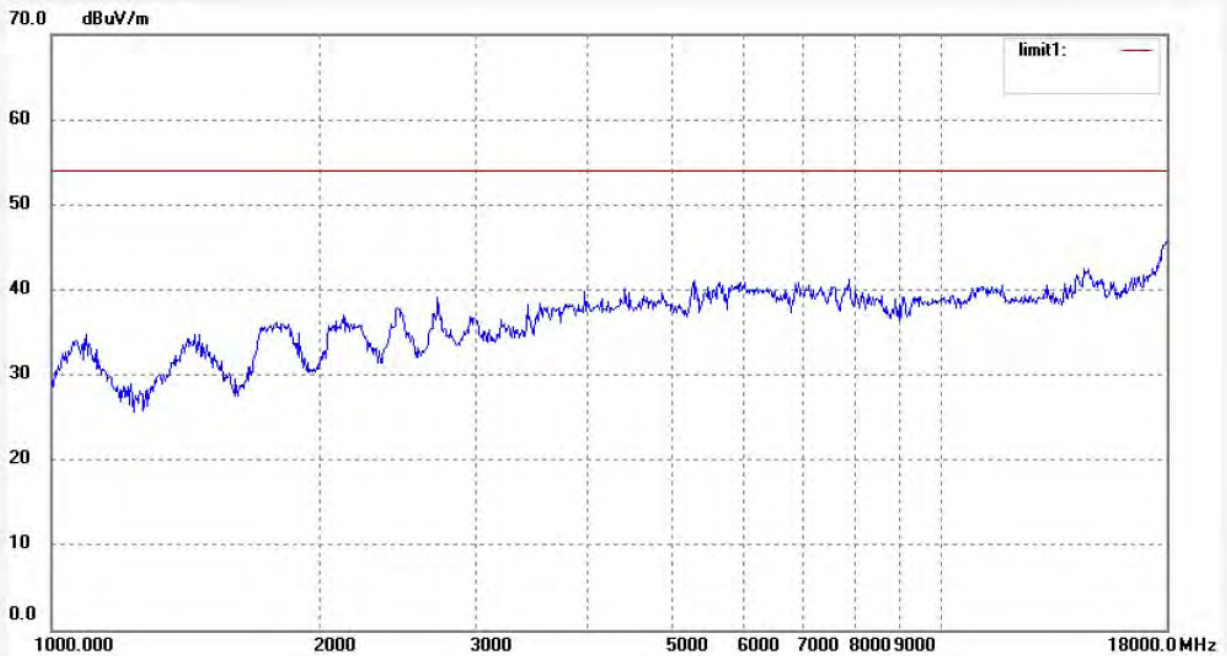

No.	Freq. (MHz)	Reading (dBuV/m)	Factor (dB)	Result (dBuV/m)	Limit (dBuV/m)	Margin (dB)	Detector	Height (cm)	Degree (deg.)	Remark
-----	-------------	------------------	-------------	-----------------	----------------	-------------	----------	-------------	---------------	--------



ACCURATE TECHNOLOGY CO., LTD.

F1,Bldg,A,Changyuan New Material Port Keyuan Rd,
Science & Industry Park,Nanshan Shenzhen,P.R.China

Site: 966 chamber
Tel:+86-0755-26503290
Fax:+86-0755-26503396

Job No.: Bob #2568	Polarization: Vertical
Standard: FCC Class B 3M Radiated	Power Source: AC 120V/60Hz
Test item: Radiation Test	Date: 12/06/29/
Temp.(C)/Hum.(%) 24 C / 48 %	Time: 11:43:23
EUT: TV BOX	Engineer Signature: Bob
Mode: TX Channel 1 (802.11b)	Distance: 3m
Model: IS-TV1200K	
Manufacturer: SWAGTEK	

Note: Report No.:ATE20121277

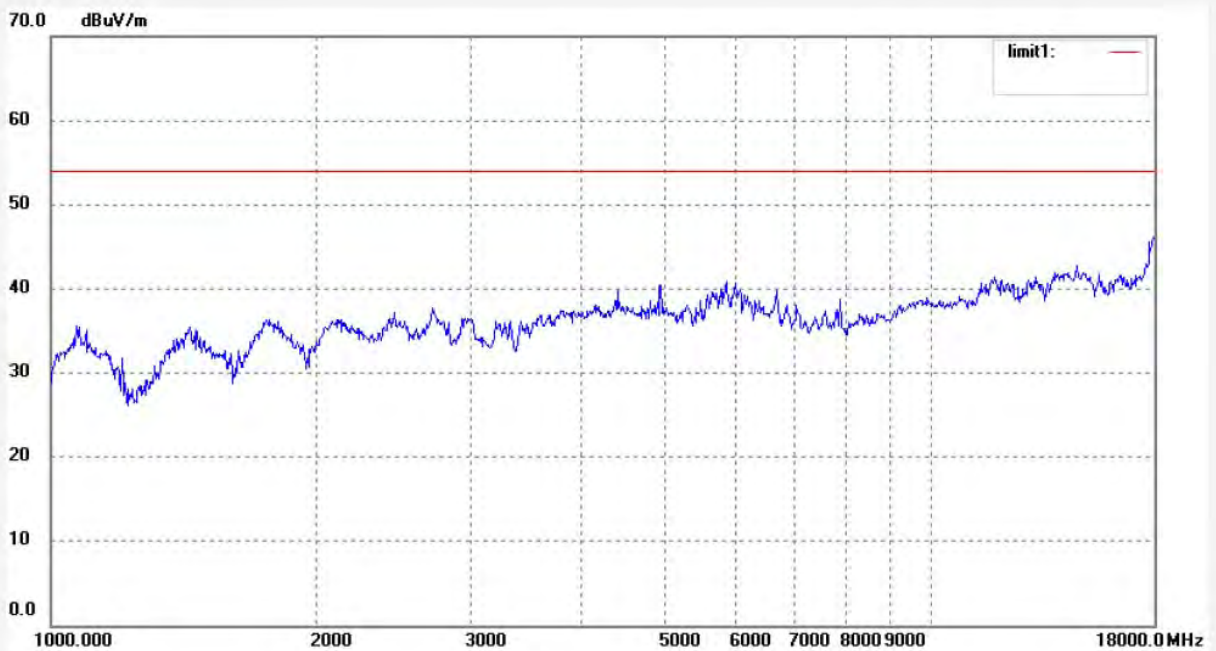

No.	Freq. (MHz)	Reading (dBuV/m)	Factor (dB)	Result (dBuV/m)	Limit (dBuV/m)	Margin (dB)	Detector	Height (cm)	Degree (deg.)	Remark
-----	-------------	------------------	-------------	-----------------	----------------	-------------	----------	-------------	---------------	--------



ACCURATE TECHNOLOGY CO., LTD.

F1,Bldg,A,Changyuan New Material Port Keyuan Rd,
Science & Industry Park,Nanshan Shenzhen,P.R.China

Site: 966 chamber
Tel:+86-0755-26503290
Fax:+86-0755-26503396

Job No.: Bob #1601
Standard: FCC Class B 3M Radiated
Test item: Radiation Test
Temp.(C)/Hum.(%) 25 C / 50 %
EUT: TV BOX
Mode: TX Channel 1 (802.11b)
Model: IS-TV1200K
Manufacturer: SWAGTEK

Polarization: Horizontal
Power Source: AC 120V/60Hz
Date: 12/06/27/
Time: 10:05:15
Engineer Signature: Bob
Distance: 3m

Note: Report No.:ATE20121277

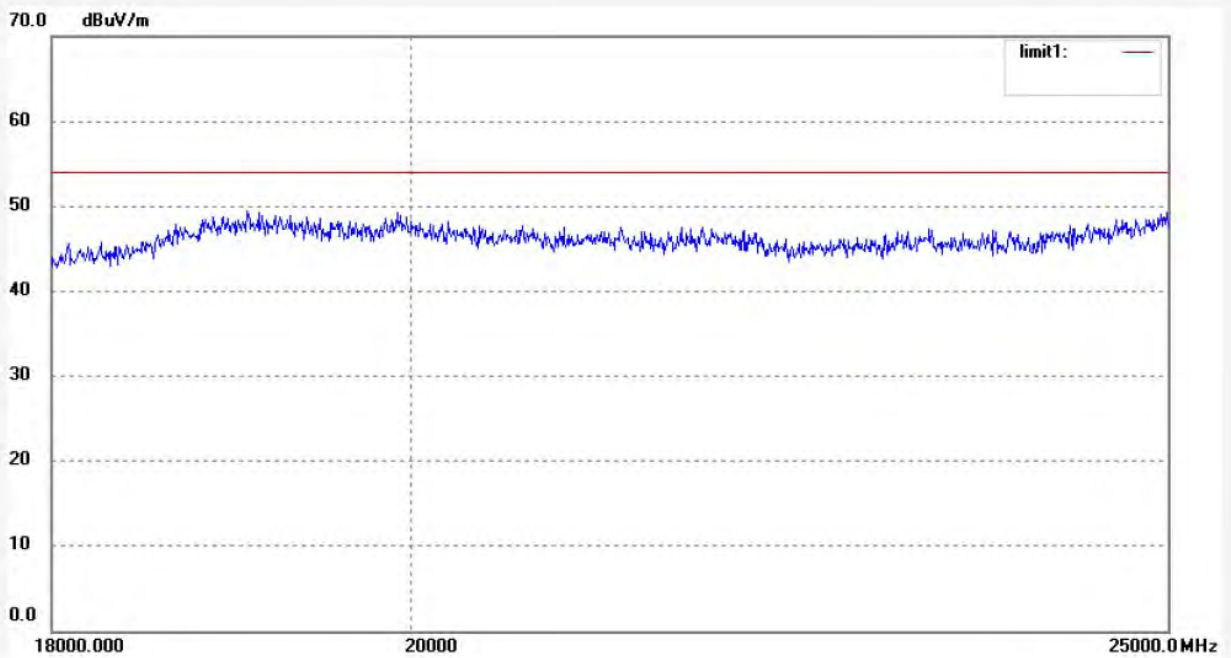

No.	Freq. (MHz)	Reading (dBuV/m)	Factor (dB)	Result (dBuV/m)	Limit (dBuV/m)	Margin (dB)	Detector	Height (cm)	Degree (deg.)	Remark
-----	-------------	------------------	-------------	-----------------	----------------	-------------	----------	-------------	---------------	--------



ACCURATE TECHNOLOGY CO., LTD.

F1,Bldg,A,Changyuan New Material Port Keyuan Rd,
Science & Industry Park,Nanshan Shenzhen,P.R.China

Site: 966 chamber
Tel:+86-0755-26503290
Fax:+86-0755-26503396

Job No.: Bob #1602	Polarization: Vertical
Standard: FCC Class B 3M Radiated	Power Source: AC 120V/60Hz
Test item: Radiation Test	Date: 12/06/27/
Temp.(C)/Hum.(%) 25 C / 50 %	Time: 10:09:22
EUT: TV BOX	Engineer Signature: Bob
Mode: TX Channel 1 (802.11b)	Distance: 3m
Model: IS-TV1200K	
Manufacturer: SWAGTEK	

Note: Report No.:ATE20121277

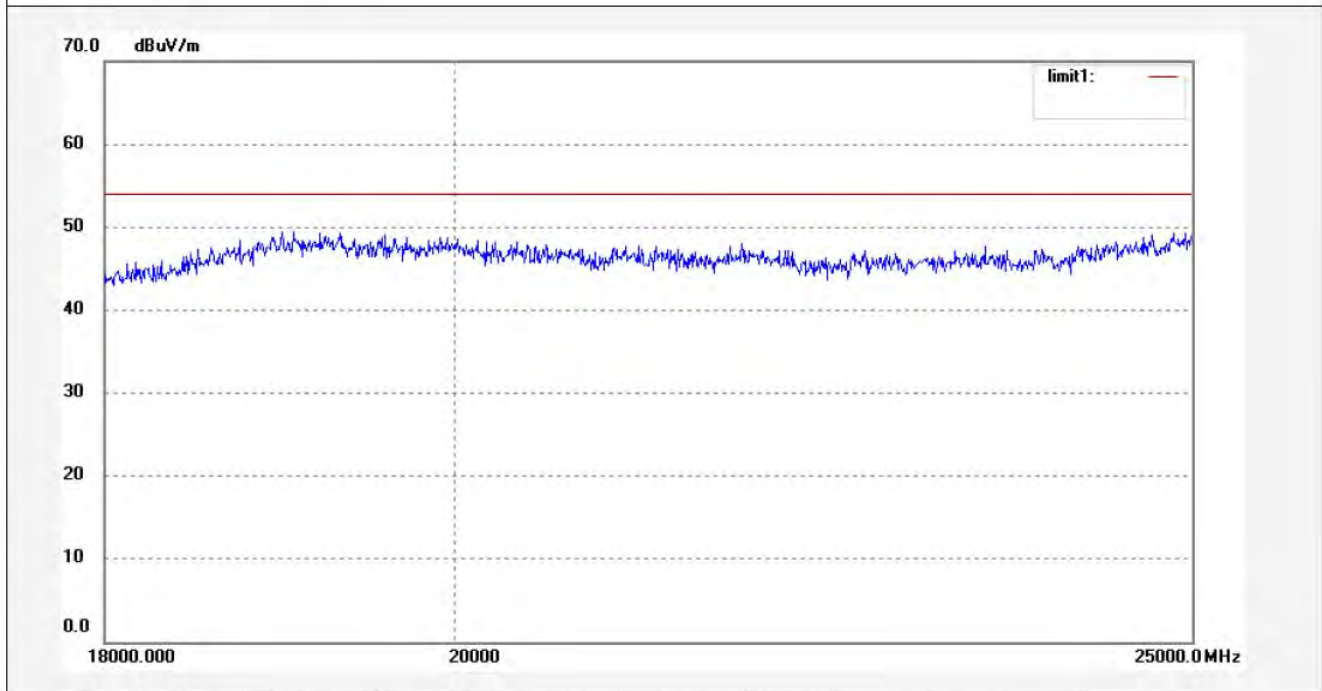

No.	Freq. (MHz)	Reading (dBuV/m)	Factor (dB)	Result (dBuV/m)	Limit (dBuV/m)	Margin (dB)	Detector	Height (cm)	Degree (deg.)	Remark
-----	-------------	------------------	-------------	-----------------	----------------	-------------	----------	-------------	---------------	--------



ACCURATE TECHNOLOGY CO., LTD.

F1,Bldg,A,Changyuan New Material Port Keyuan Rd,
Science & Industry Park,Nanshan Shenzhen,P.R.China

Site: 966 chamber
Tel:+86-0755-26503290
Fax:+86-0755-26503396

Job No.: Bob #1934
Standard: FCC Class B 3M Radiated
Test item: Radiation Test
Temp.(C)/Hum.(%) 25 C / 51 %
EUT: TV BOX
Mode: TX Channel 6(802.11b)
Model: IS-TV1200K
Manufacturer: SWAGTEK

Polarization: Horizontal
Power Source: AC 120V/60Hz
Date: 12/06/28/
Time: 10/53/45
Engineer Signature:
Distance: 3m

Note: Report NO.:ATE20121277

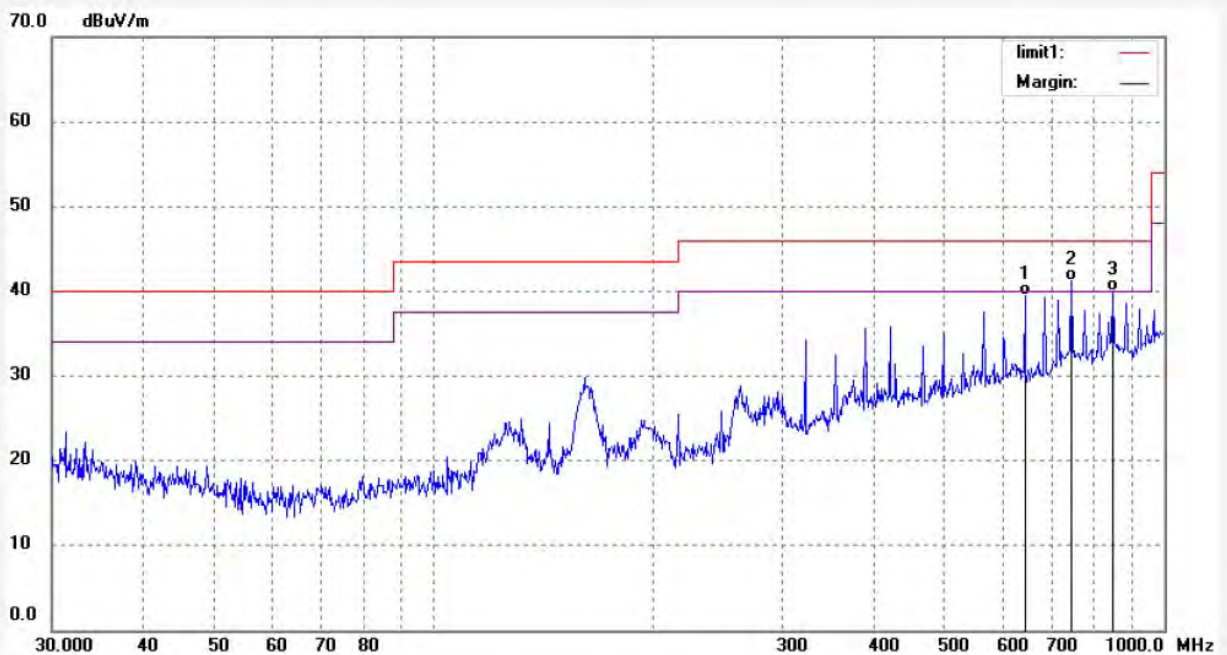

No.	Freq. (MHz)	Reading (dBuV/m)	Factor (dB)	Result (dBuV/m)	Limit (dBuV/m)	Margin (dB)	Detector	Height (cm)	Degree (deg.)	Remark
1	644.5531	13.43	26.08	39.51	46.00	-6.49	QP			
2	747.0467	13.62	27.57	41.19	46.00	-4.81	QP			
3	850.7603	11.67	28.36	40.03	46.00	-5.97	QP			



ACCURATE TECHNOLOGY CO., LTD.

F1,Bldg,A,Changyuan New Material Port Keyuan Rd,
Science & Industry Park,Nanshan Shenzhen,P.R.China

Site: 966 chamber
Tel:+86-0755-26503290
Fax:+86-0755-26503396

Job No.: Bob #1935	Polarization: Vertical
Standard: FCC Class B 3M Radiated	Power Source: AC 120V/60Hz
Test item: Radiation Test	Date: 12/06/28/
Temp.(C)/Hum.(%) 25 C / 51 %	Time: 10/55/23
EUT: TV BOX	Engineer Signature:
Mode: TX Channel 6(802.11b)	Distance: 3m
Model: IS-TV1200K	
Manufacturer: SWAGTEK	

Note: Report NO.:ATE20121277

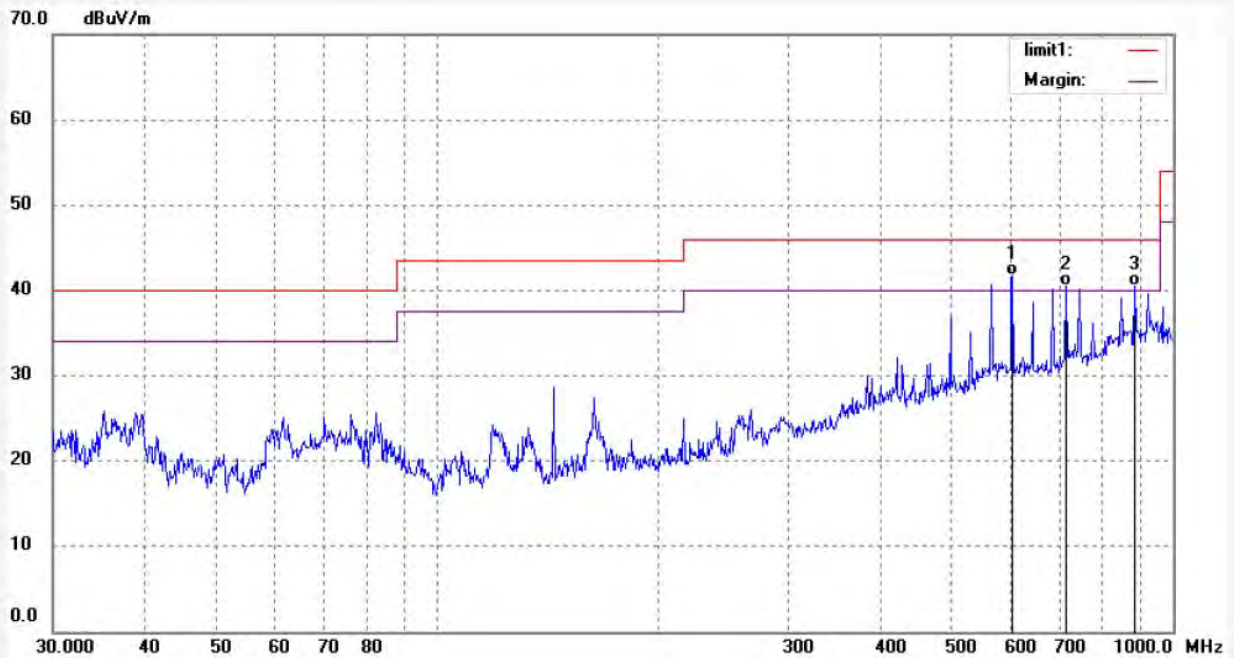

No.	Freq. (MHz)	Reading (dBuV/m)	Factor (dB)	Result (dBuV/m)	Limit (dBuV/m)	Margin (dB)	Detector	Height (cm)	Degree (deg.)	Remark
1	605.0509	16.02	25.64	41.66	46.00	-4.34	QP			
2	716.2038	13.40	27.05	40.45	46.00	-5.55	QP			
3	887.3978	11.71	28.77	40.48	46.00	-5.52	QP			



ACCURATE TECHNOLOGY CO., LTD.

F1,Bldg,A,Changyuan New Material Port Keyuan Rd,
Science & Industry Park,Nanshan Shenzhen,P.R.China

Site: 966 chamber
Tel:+86-0755-26503290
Fax:+86-0755-26503396

Job No.: Bob #2570	Polarization: Horizontal
Standard: FCC Class B 3M Radiated	Power Source: AC 120V/60Hz
Test item: Radiation Test	Date: 12/06/29/
Temp.(C)/Hum.(%) 24 C / 48 %	Time: 11:50:42
EUT: TV BOX	Engineer Signature: Bob
Mode: TX Channel 6 (802.11b)	Distance: 3m
Model: IS-TV1200K	
Manufacturer: SWAGTEK	

Note: Report No.:ATE20121277

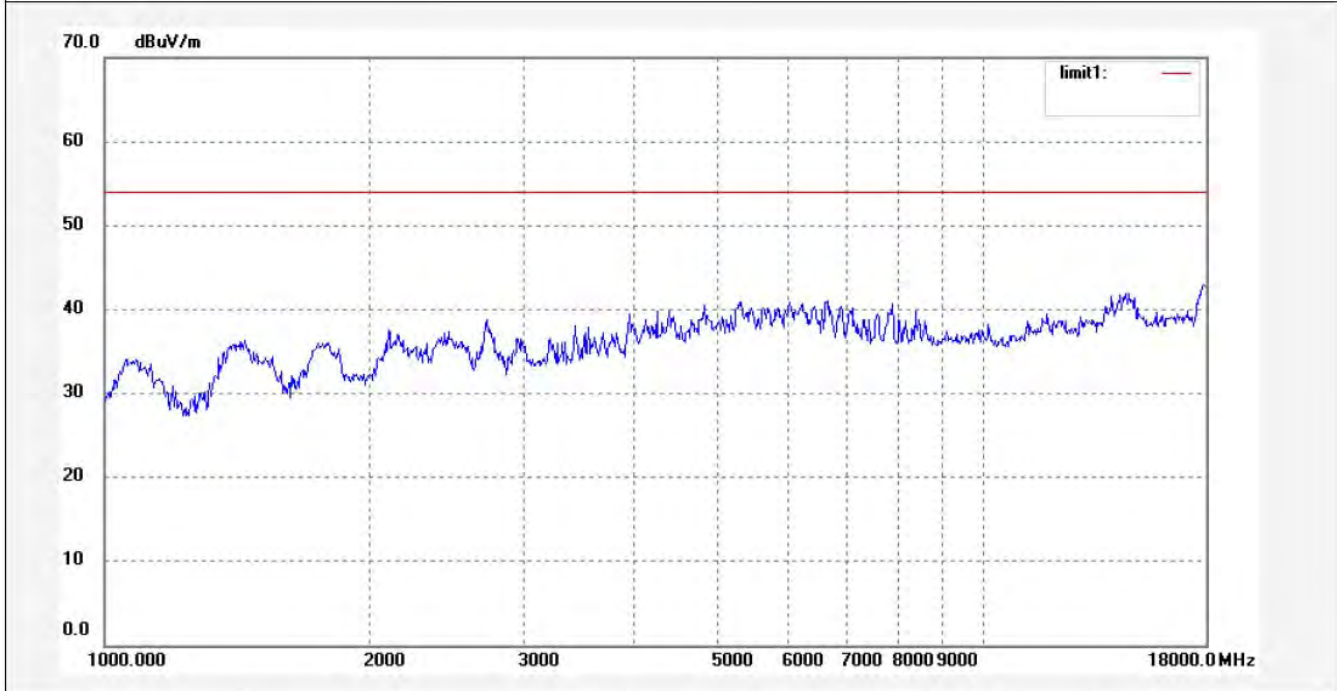

No.	Freq. (MHz)	Reading (dBuV/m)	Factor (dB)	Result (dBuV/m)	Limit (dBuV/m)	Margin (dB)	Detector	Height (cm)	Degree (deg.)	Remark
-----	-------------	------------------	-------------	-----------------	----------------	-------------	----------	-------------	---------------	--------



ACCURATE TECHNOLOGY CO., LTD.

F1,Bldg,A,Changyuan New Material Port Keyuan Rd,
Science & Industry Park,Nanshan Shenzhen,P.R.China

Site: 966 chamber
Tel:+86-0755-26503290
Fax:+86-0755-26503396

Job No.: Bob #2569	Polarization: Vertical
Standard: FCC Class B 3M Radiated	Power Source: AC 120V/60Hz
Test item: Radiation Test	Date: 12/06/29/
Temp.(C)/Hum.(%) 24 C / 48 %	Time: 11:46:45
EUT: TV BOX	Engineer Signature: Bob
Mode: TX Channel 6 (802.11b)	Distance: 3m
Model: IS-TV1200K	
Manufacturer: SWAGTEK	

Note: Report No.:ATE20121277

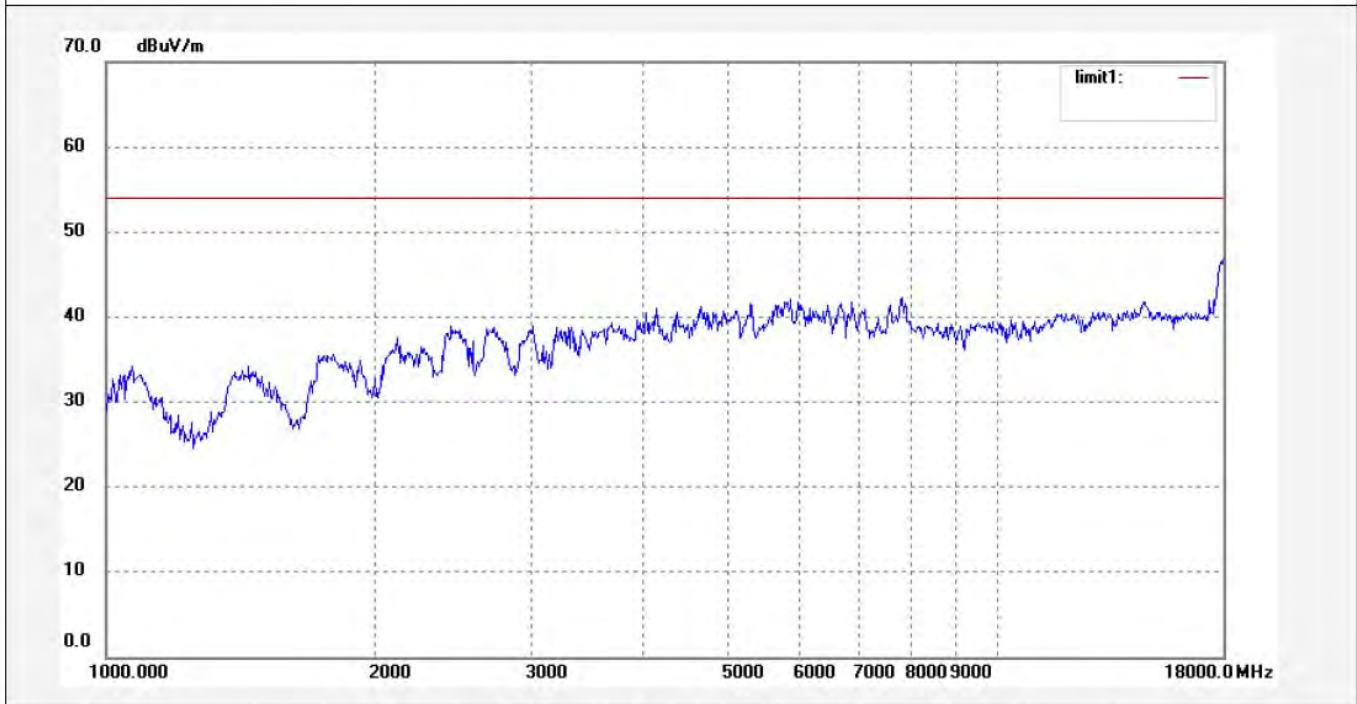

No.	Freq. (MHz)	Reading (dBuV/m)	Factor (dB)	Result (dBuV/m)	Limit (dBuV/m)	Margin (dB)	Detector	Height (cm)	Degree (deg.)	Remark
-----	-------------	------------------	-------------	-----------------	----------------	-------------	----------	-------------	---------------	--------



ACCURATE TECHNOLOGY CO., LTD.

F1,Bldg,A,Changyuan New Material Port Keyuan Rd,
Science & Industry Park,Nanshan Shenzhen,P.R.China

Site: 966 chamber
Tel:+86-0755-26503290
Fax:+86-0755-26503396

Job No.: Bob #1604	Polarization: Horizontal
Standard: FCC Class B 3M Radiated	Power Source: AC 120V/60Hz
Test item: Radiation Test	Date: 12/06/27/
Temp.(C)/Hum.(%) 25 C / 50 %	Time: 10:18:36
EUT: TV BOX	Engineer Signature: Bob
Mode: TX Channel 6 (802.11b)	Distance: 3m
Model: IS-TV1200K	
Manufacturer: SWAGTEK	

Note: Report No.:ATE20121277

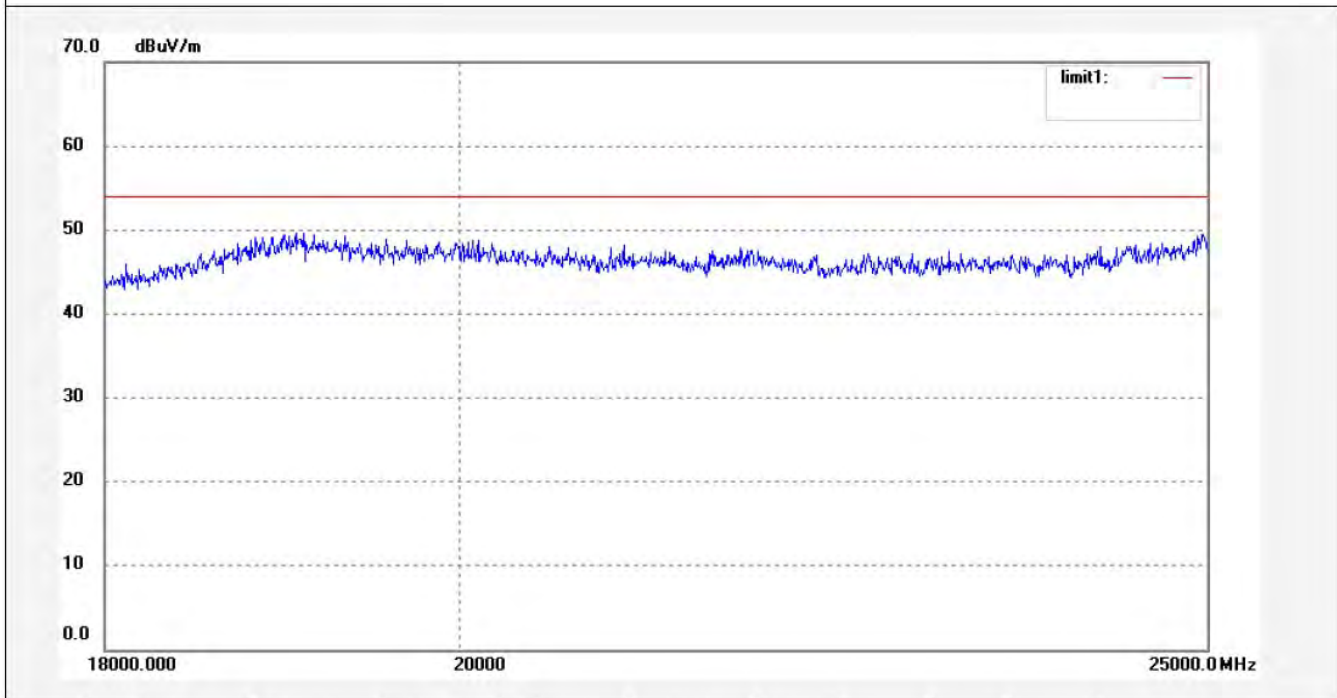

No.	Freq. (MHz)	Reading (dBuV/m)	Factor (dB)	Result (dBuV/m)	Limit (dBuV/m)	Margin (dB)	Detector	Height (cm)	Degree (deg.)	Remark
-----	-------------	------------------	-------------	-----------------	----------------	-------------	----------	-------------	---------------	--------



ACCURATE TECHNOLOGY CO., LTD.

F1,Bldg,A,Changyuan New Material Port Keyuan Rd,
Science & Industry Park,Nanshan Shenzhen,P.R.China

Site: 966 chamber
Tel:+86-0755-26503290
Fax:+86-0755-26503396

Job No.: Bob #1603	Polarization: Vertical
Standard: FCC Class B 3M Radiated	Power Source: AC 120V/60Hz
Test item: Radiation Test	Date: 12/06/27/
Temp.(C)/Hum.(%) 25 C / 50 %	Time: 10:14:45
EUT: TV BOX	Engineer Signature: Bob
Mode: TX Channel 6 (802.11b)	Distance: 3m
Model: IS-TV1200K	
Manufacturer: SWAGTEK	

Note: Report No.:ATE20121277

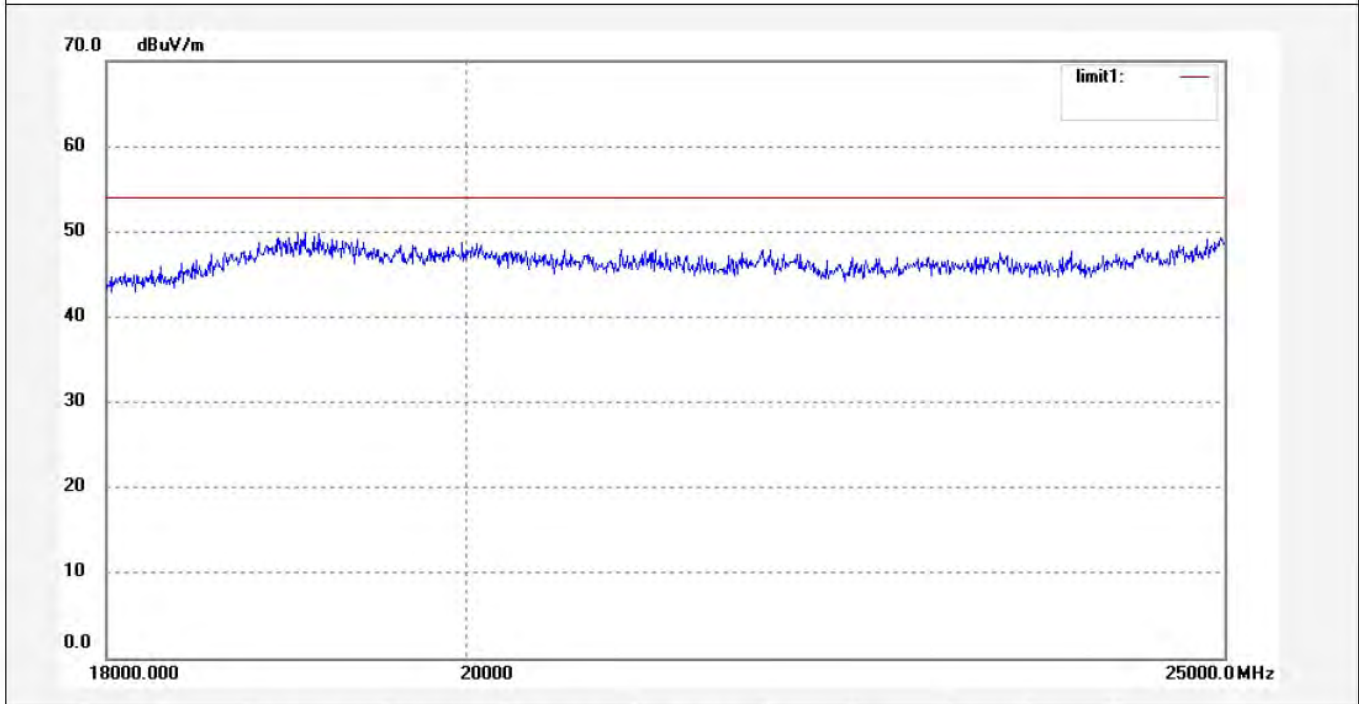

No.	Freq. (MHz)	Reading (dBuV/m)	Factor (dB)	Result (dBuV/m)	Limit (dBuV/m)	Margin (dB)	Detector	Height (cm)	Degree (deg.)	Remark
-----	-------------	------------------	-------------	-----------------	----------------	-------------	----------	-------------	---------------	--------



ACCURATE TECHNOLOGY CO., LTD.

F1,Bldg,A,Changyuan New Material Port Keyuan Rd,
Science & Industry Park,Nanshan Shenzhen,P.R.China

Site: 966 chamber
Tel:+86-0755-26503290
Fax:+86-0755-26503396

Job No.: Bob #1937
Standard: FCC Class B 3M Radiated
Test item: Radiation Test
Temp.(C)/Hum.(%) 25 C / 51 %
EUT: TV BOX
Mode: TX Channel 11(802.11b)
Model: IS-TV1200K
Manufacturer: SWAGTEK

Polarization: Horizontal
Power Source: AC 120V/60Hz
Date: 12/06/28/
Time: 11/02/39
Engineer Signature:
Distance: 3m

Note: Report NO.:ATE20121277

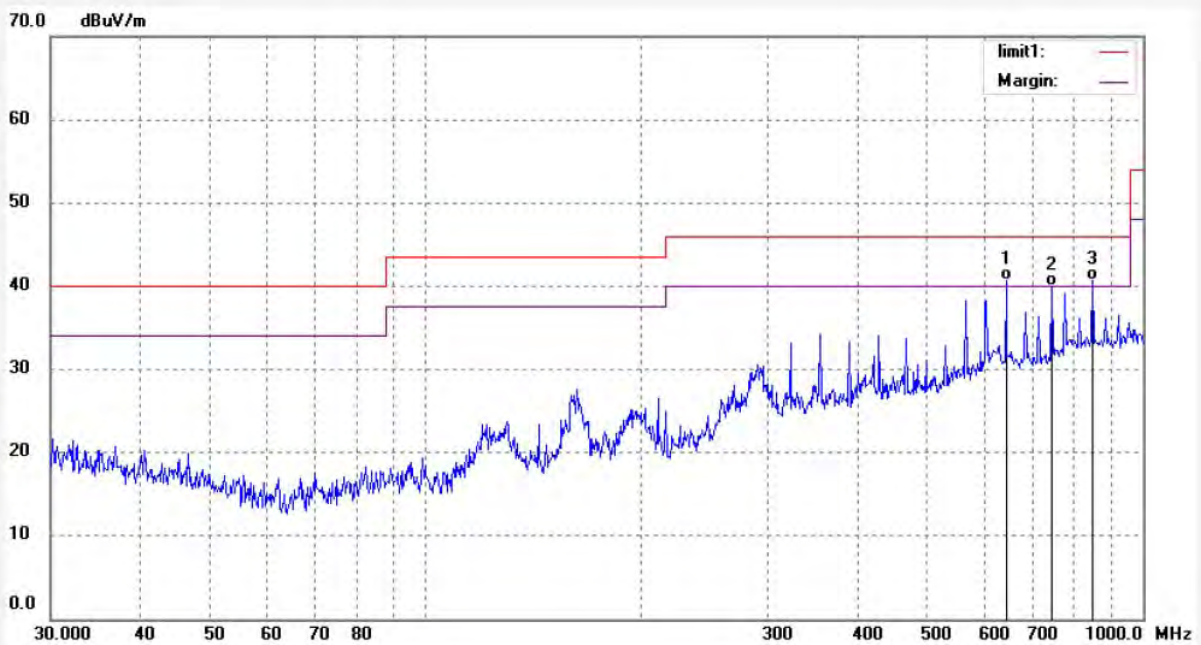

No.	Freq. (MHz)	Reading (dBuV/m)	Factor (dB)	Result (dBuV/m)	Limit (dBuV/m)	Margin (dB)	Detector	Height (cm)	Degree (deg.)	Remark
1	644.5531	14.60	26.08	40.68	46.00	-5.32	QP			
2	747.0467	12.50	27.57	40.07	46.00	-5.93	QP			
3	850.7603	12.28	28.36	40.64	46.00	-5.36	QP			



ACCURATE TECHNOLOGY CO., LTD.

F1,Bldg,A,Changyuan New Material Port Keyuan Rd,
Science & Industry Park,Nanshan Shenzhen,P.R.China

Site: 966 chamber
Tel:+86-0755-26503290
Fax:+86-0755-26503396

Job No.: Bob #1936
Standard: FCC Class B 3M Radiated
Test item: Radiation Test
Temp.(C)/Hum.(%) 25 C / 51 %
EUT: TV BOX
Mode: TX Channel 11(802.11b)
Model: IS-TV1200K
Manufacturer: SWAGTEK

Polarization: Vertical
Power Source: AC 120V/60Hz
Date: 12/06/28/
Time: 10/58/06
Engineer Signature:
Distance: 3m

Note: Report NO.:ATE20121277

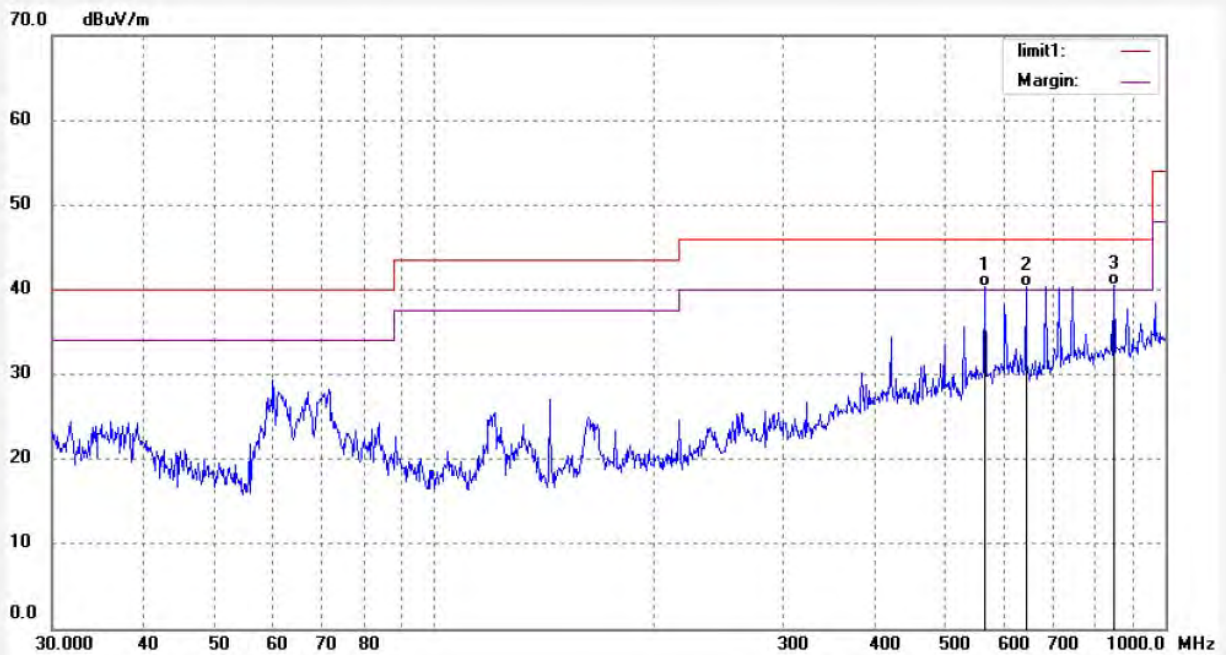

No.	Freq. (MHz)	Reading (dBuV/m)	Factor (dB)	Result (dBuV/m)	Limit (dBuV/m)	Margin (dB)	Detector	Height (cm)	Degree (deg.)	Remark
1	565.9776	15.02	25.27	40.29	46.00	-5.71	QP			
2	644.5531	14.28	26.08	40.36	46.00	-5.64	QP			
3	850.7603	12.11	28.36	40.47	46.00	-5.53	QP			



ACCURATE TECHNOLOGY CO., LTD.

F1,Bldg,A,Changyuan New Material Port Keyuan Rd,
Science & Industry Park,Nanshan Shenzhen,P.R.China

Site: 966 chamber
Tel:+86-0755-26503290
Fax:+86-0755-26503396

Job No.: Bob #2571	Polarization: Horizontal
Standard: FCC Class B 3M Radiated	Power Source: AC 120V/60Hz
Test item: Radiation Test	Date: 12/06/29/
Temp.(C)/Hum.(%) 24 C / 48 %	Time: 11:53:36
EUT: TV BOX	Engineer Signature: Bob
Mode: TX Channel 11 (802.11b)	Distance: 3m
Model: IS-TV1200K	
Manufacturer: SWAGTEK	

Note: Report No.:ATE20121277

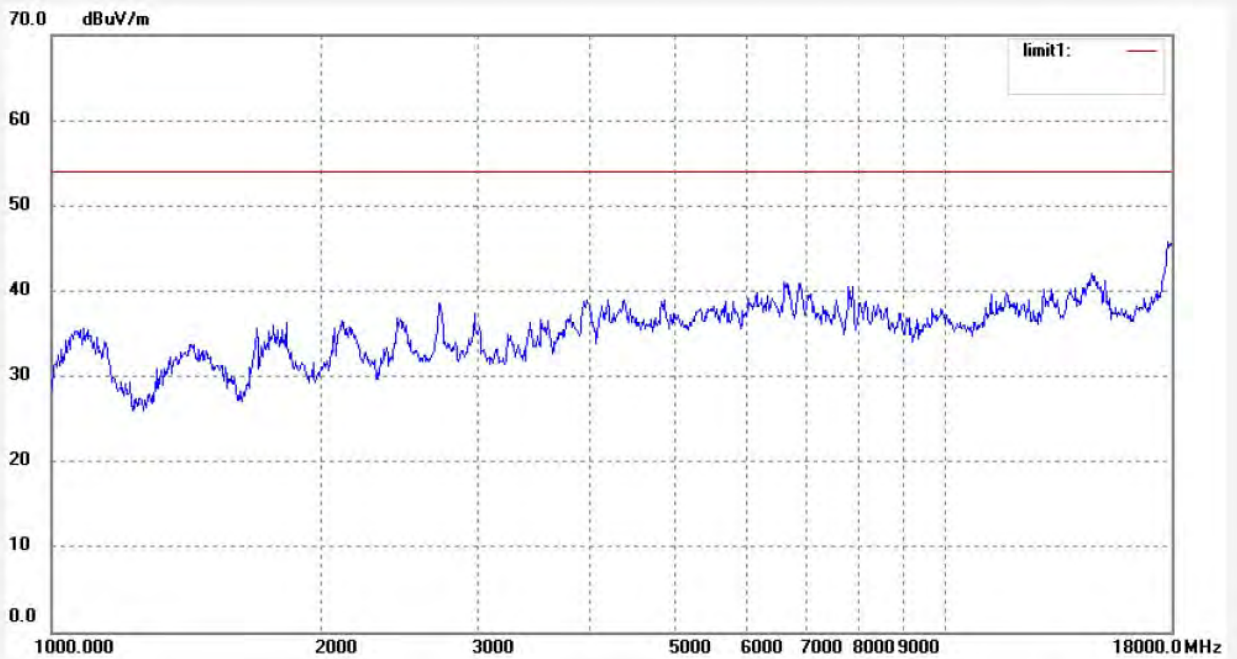

No.	Freq. (MHz)	Reading (dBuV/m)	Factor (dB)	Result (dBuV/m)	Limit (dBuV/m)	Margin (dB)	Detector	Height (cm)	Degree (deg.)	Remark
-----	-------------	------------------	-------------	-----------------	----------------	-------------	----------	-------------	---------------	--------



ACCURATE TECHNOLOGY CO., LTD.

F1,Bldg,A,Changyuan New Material Port Keyuan Rd,
Science & Industry Park,Nanshan Shenzhen,P.R.China

Site: 966 chamber
Tel:+86-0755-26503290
Fax:+86-0755-26503396

Job No.: Bob #2572
Standard: FCC Class B 3M Radiated
Test item: Radiation Test
Temp.(C)/Hum.(%) 24 C / 48 %
EUT: TV BOX
Mode: TX Channel 11 (802.11b)
Model: IS-TV1200K
Manufacturer: SWAGTEK

Polarization: Vertical
Power Source: AC 120V/60Hz
Date: 12/06/29/
Time: 11:56:56
Engineer Signature: Bob
Distance: 3m

Note: Report No.:ATE20121277

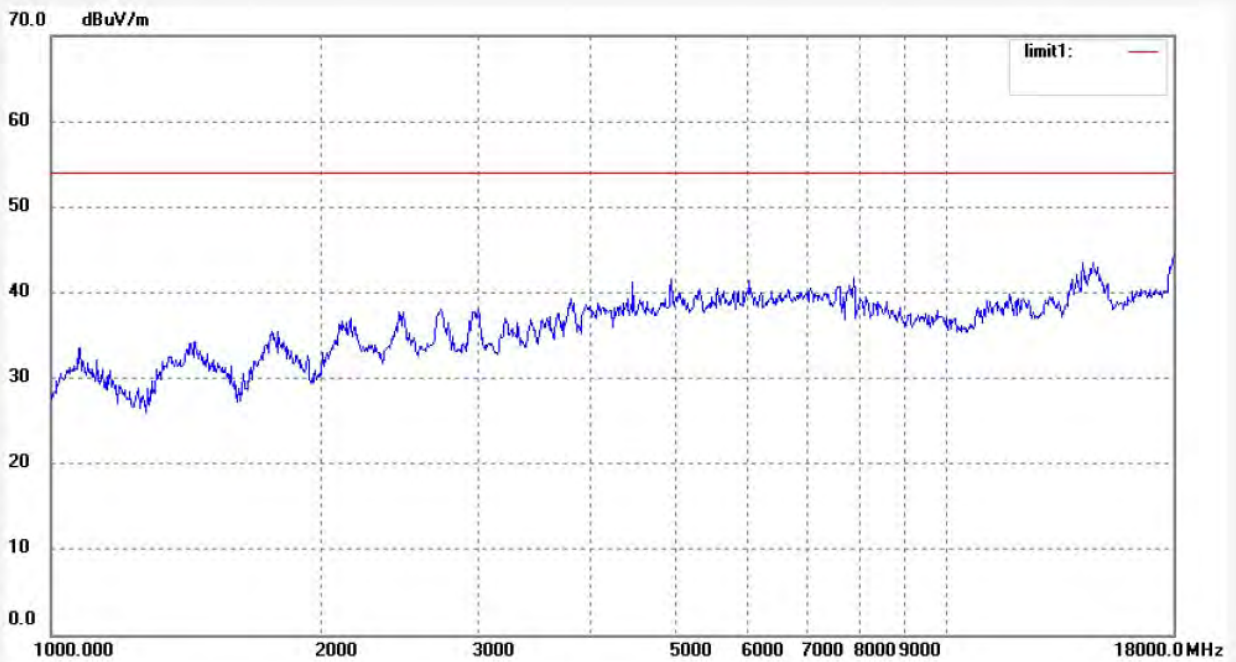

No.	Freq. (MHz)	Reading (dBuV/m)	Factor (dB)	Result (dBuV/m)	Limit (dBuV/m)	Margin (dB)	Detector	Height (cm)	Degree (deg.)	Remark
-----	-------------	------------------	-------------	-----------------	----------------	-------------	----------	-------------	---------------	--------



ACCURATE TECHNOLOGY CO., LTD.

F1,Bldg,A,Changyuan New Material Port Keyuan Rd,
Science & Industry Park,Nanshan Shenzhen,P.R.China

Site: 966 chamber
Tel:+86-0755-26503290
Fax:+86-0755-26503396

Job No.: Bob #1605	Polarization: Horizontal
Standard: FCC Class B 3M Radiated	Power Source: AC 120V/60Hz
Test item: Radiation Test	Date: 12/06/27/
Temp.(C)/Hum.(%) 25 C / 50 %	Time: 10:23:55
EUT: TV BOX	Engineer Signature: Bob
Mode: TX Channel 11 (802.11b)	Distance: 3m
Model: IS-TV1200K	
Manufacturer: SWAGTEK	

Note: Report No.:ATE20121277

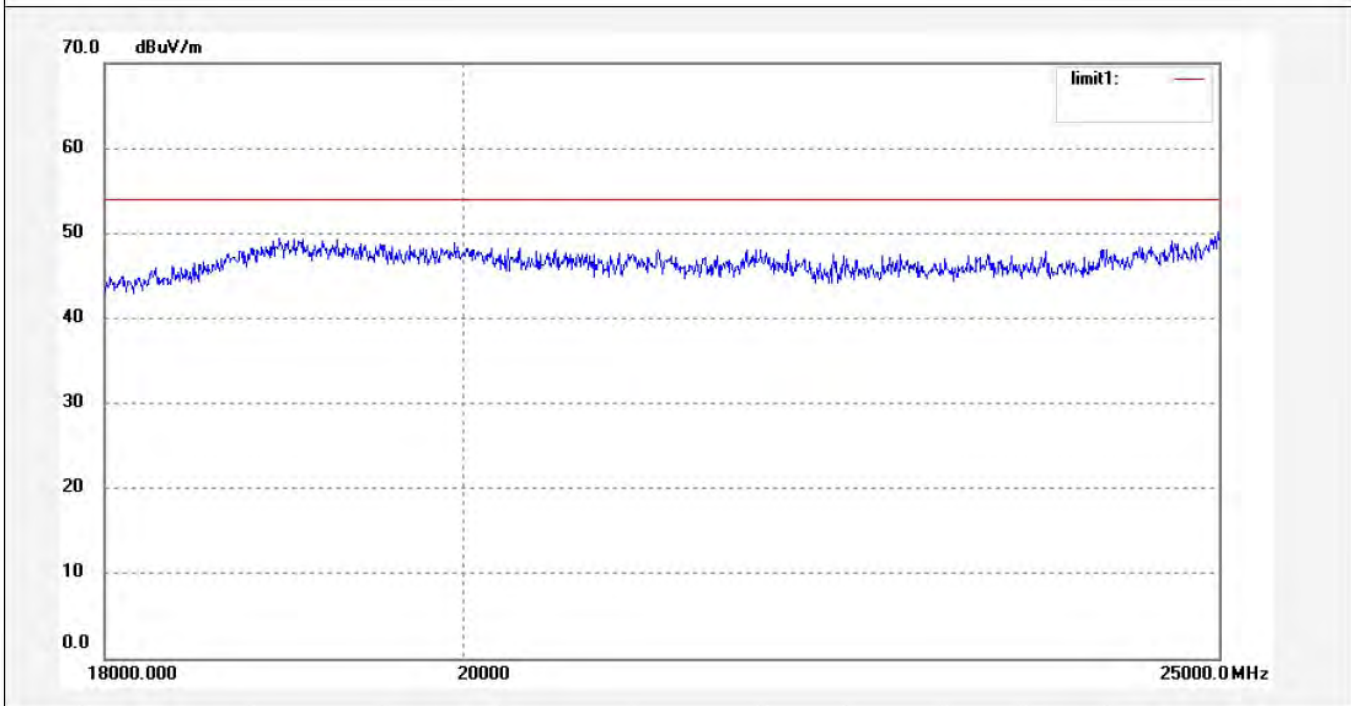

No.	Freq. (MHz)	Reading (dBuV/m)	Factor (dB)	Result (dBuV/m)	Limit (dBuV/m)	Margin (dB)	Detector	Height (cm)	Degree (deg.)	Remark
-----	-------------	------------------	-------------	-----------------	----------------	-------------	----------	-------------	---------------	--------



ACCURATE TECHNOLOGY CO., LTD.

F1,Bldg,A,Changyuan New Material Port Keyuan Rd,
Science & Industry Park,Nanshan Shenzhen,P.R.China

Site: 966 chamber
Tel:+86-0755-26503290
Fax:+86-0755-26503396

Job No.: Bob #1606	Polarization: Vertical
Standard: FCC Class B 3M Radiated	Power Source: AC 120V/60Hz
Test item: Radiation Test	Date: 12/06/27/
Temp.(C)/Hum.(%) 25 C / 50 %	Time: 10:27:11
EUT: TV BOX	Engineer Signature: Bob
Mode: TX Channel 11 (802.11b)	Distance: 3m
Model: IS-TV1200K	
Manufacturer: SWAGTEK	

Note: Report No.:ATE20121277

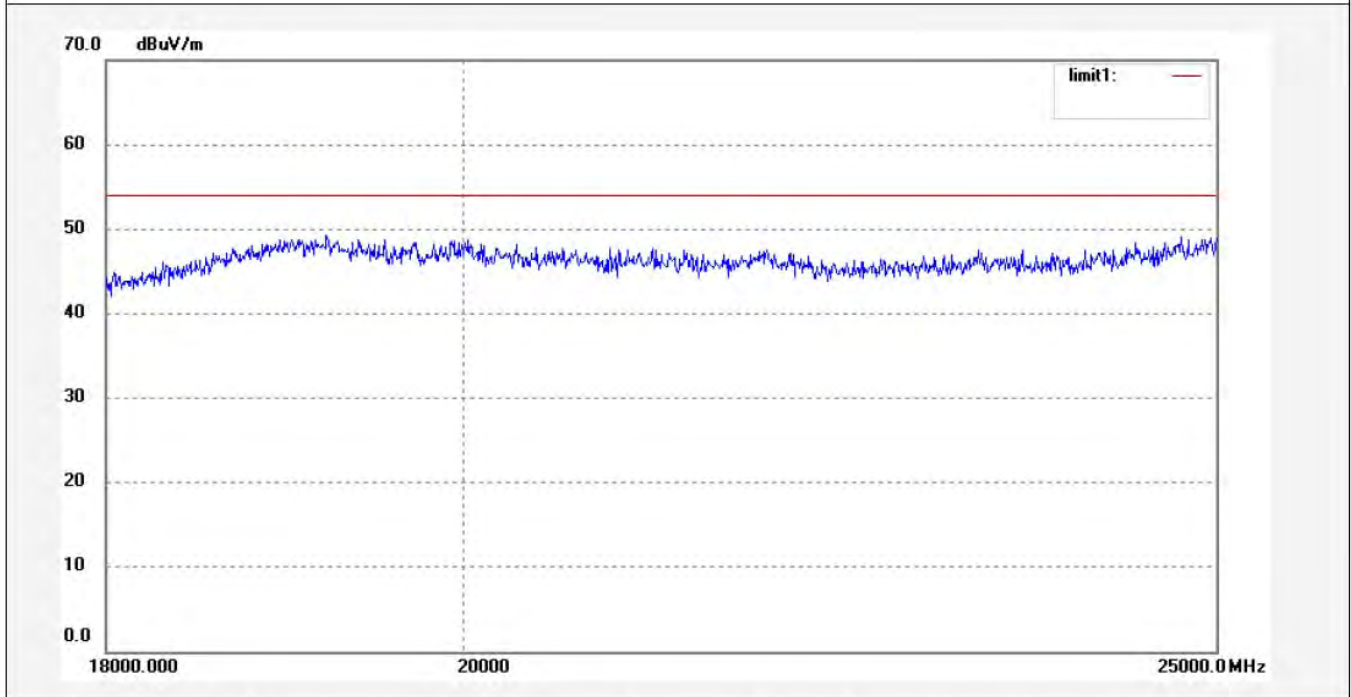

No.	Freq. (MHz)	Reading (dBuV/m)	Factor (dB)	Result (dBuV/m)	Limit (dBuV/m)	Margin (dB)	Detector	Height (cm)	Degree (deg.)	Remark
-----	-------------	------------------	-------------	-----------------	----------------	-------------	----------	-------------	---------------	--------



ACCURATE TECHNOLOGY CO., LTD.

F1,Bldg,A,Changyuan New Material Port Keyuan Rd,
Science & Industry Park,Nanshan Shenzhen,P.R.China

Site: 966 chamber
Tel:+86-0755-26503290
Fax:+86-0755-26503396

Job No.: Bob #1926
Standard: FCC Class B 3M Radiated
Test item: Radiation Test
Temp.(C)/Hum.(%) 25 C / 51 %
EUT: TV BOX
Mode: TX Channel 1(802.11g)
Model: IS-TV1200K
Manufacturer: SWAGTEK

Polarization: Horizontal
Power Source: AC 120V/60Hz
Date: 12/06/28/
Time: 10/29/35
Engineer Signature:
Distance: 3m

Note: Report NO.:ATE20121277

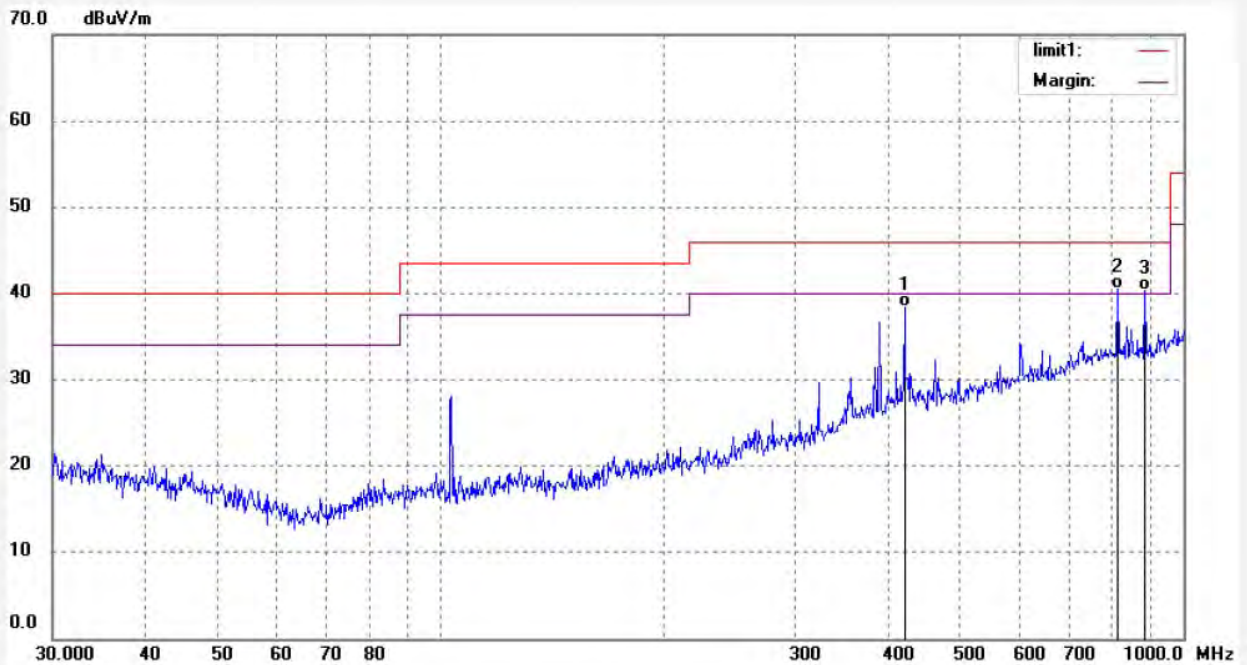

No.	Freq. (MHz)	Reading (dBuV/m)	Factor (dB)	Result (dBuV/m)	Limit (dBuV/m)	Margin (dB)	Detector	Height (cm)	Degree (deg.)	Remark
1	421.3287	15.17	23.16	38.33	46.00	-7.67	QP			
2	815.6352	12.54	28.02	40.56	46.00	-5.44	QP			
3	887.3978	11.59	28.77	40.36	46.00	-5.64	QP			



ACCURATE TECHNOLOGY CO., LTD.

F1,Bldg,A,Changyuan New Material Port Keyuan Rd,
Science & Industry Park,Nanshan Shenzhen,P.R.China

Site: 966 chamber
Tel:+86-0755-26503290
Fax:+86-0755-26503396

Job No.: Bob #1927
Standard: FCC Class B 3M Radiated
Test item: Radiation Test
Temp.(C)/Hum.(%) 25 C / 51 %
EUT: TV BOX
Mode: TX Channel 1(802.11g)
Model: IS-TV1200K
Manufacturer: SWAGTEK

Polarization: Vertical
Power Source: AC 120V/60Hz
Date: 12/06/28/
Time: 10/32/09
Engineer Signature:
Distance: 3m

Note: Report NO.:ATE20121277

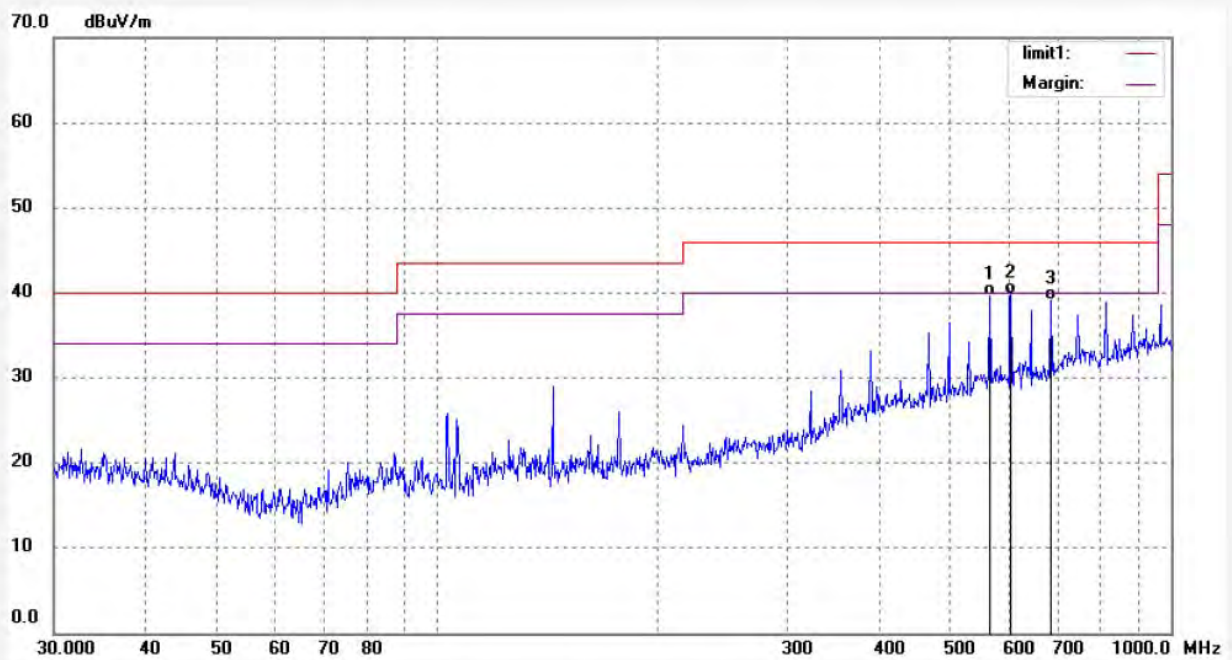

No.	Freq. (MHz)	Reading (dBuV/m)	Factor (dB)	Result (dBuV/m)	Limit (dBuV/m)	Margin (dB)	Detector	Height (cm)	Degree (deg.)	Remark
1	565.9776	14.29	25.27	39.56	46.00	-6.44	QP			
2	605.0509	14.25	25.64	39.89	46.00	-6.11	QP			
3	686.6342	12.79	26.37	39.16	46.00	-6.84	QP			



ACCURATE TECHNOLOGY CO., LTD.

F1,Bldg,A,Changyuan New Material Port Keyuan Rd,
Science & Industry Park,Nanshan Shenzhen,P.R.China

Site: 966 chamber
Tel:+86-0755-26503290
Fax:+86-0755-26503396

Job No.: Bob #2574
Standard: FCC Class B 3M Radiated
Test item: Radiation Test
Temp.(C)/Hum.(%) 24 C / 48 %
EUT: TV BOX
Mode: TX Channel 1 (802.11g)
Model: IS-TV1200K
Manufacturer: SWAGTEK

Polarization: Horizontal
Power Source: AC 120V/60Hz
Date: 12/06/29/
Time: 12:05:30
Engineer Signature: Bob
Distance: 3m

Note: Report No.:ATE20121277

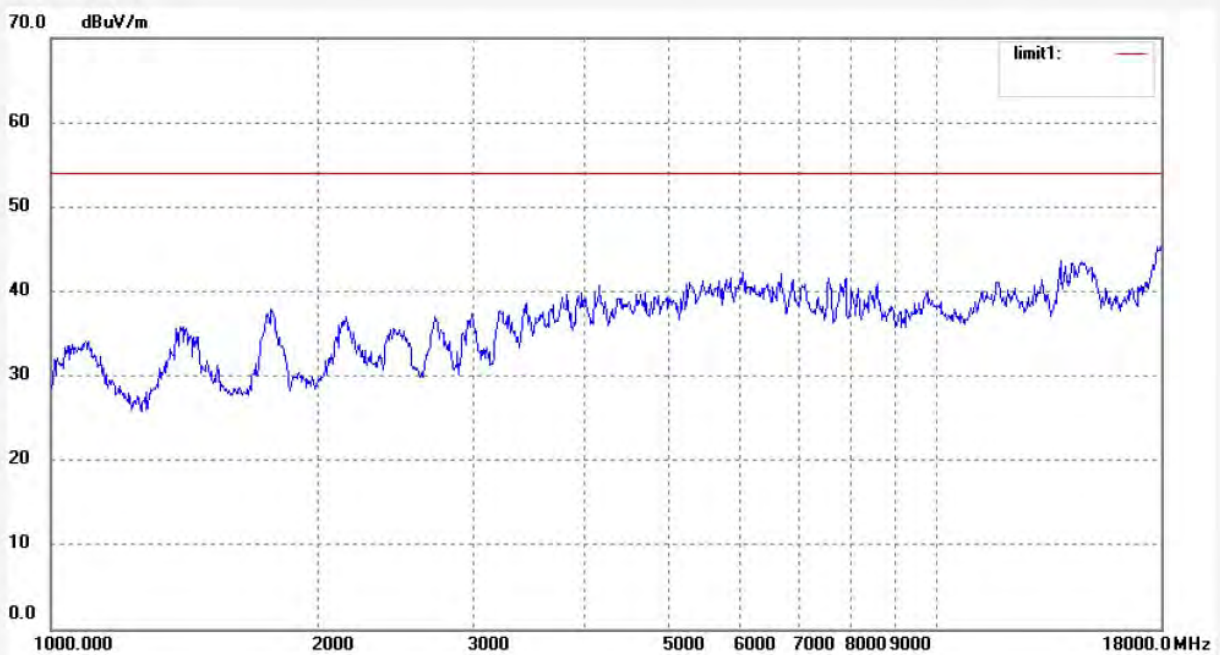

No.	Freq. (MHz)	Reading (dBuV/m)	Factor (dB)	Result (dBuV/m)	Limit (dBuV/m)	Margin (dB)	Detector	Height (cm)	Degree (deg.)	Remark
-----	-------------	------------------	-------------	-----------------	----------------	-------------	----------	-------------	---------------	--------



ACCURATE TECHNOLOGY CO., LTD.

F1,Bldg,A,Changyuan New Material Port Keyuan Rd,
Science & Industry Park,Nanshan Shenzhen,P.R.China

Site: 966 chamber
Tel:+86-0755-26503290
Fax:+86-0755-26503396

Job No.: Bob #2573	Polarization: Vertical
Standard: FCC Class B 3M Radiated	Power Source: AC 120V/60Hz
Test item: Radiation Test	Date: 12/06/29/
Temp.(C)/Hum.(%) 24 C / 48 %	Time: 12:01:35
EUT: TV BOX	Engineer Signature: Bob
Mode: TX Channel 1 (802.11g)	Distance: 3m
Model: IS-TV1200K	
Manufacturer: SWAGTEK	

Note: Report No.:ATE20121277

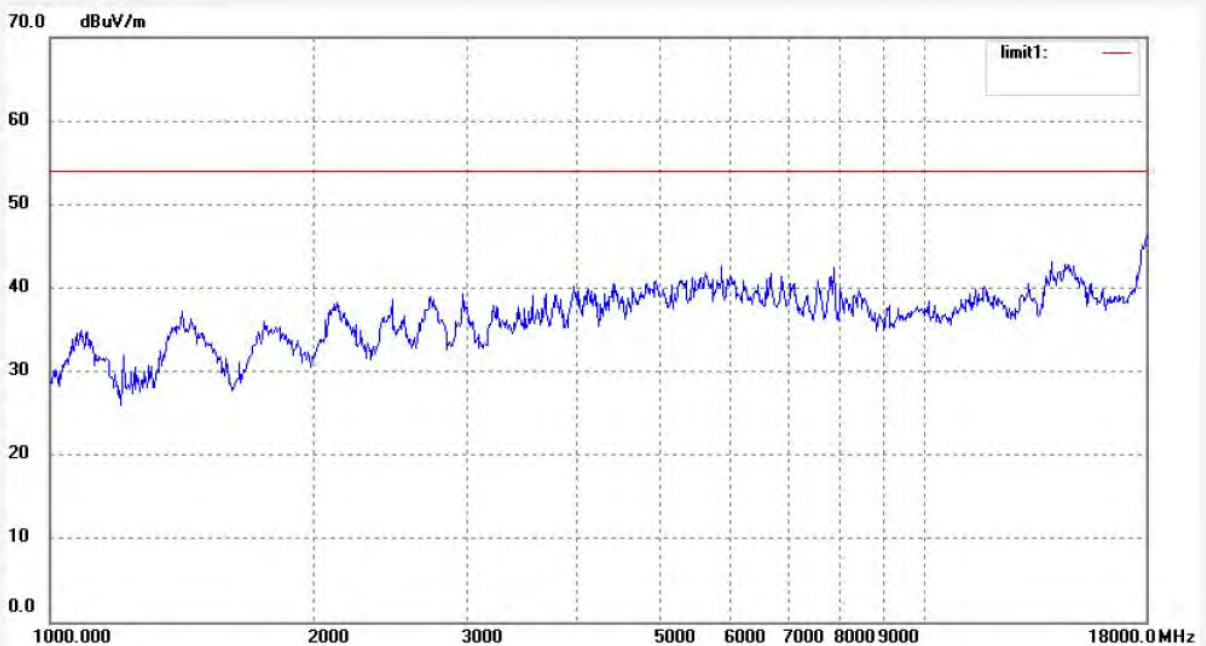

No.	Freq. (MHz)	Reading (dBuV/m)	Factor (dB)	Result (dBuV/m)	Limit (dBuV/m)	Margin (dB)	Detector	Height (cm)	Degree (deg.)	Remark
-----	-------------	------------------	-------------	-----------------	----------------	-------------	----------	-------------	---------------	--------



ACCURATE TECHNOLOGY CO., LTD.

F1,Bldg,A,Changyuan New Material Port Keyuan Rd,
Science & Industry Park,Nanshan Shenzhen,P.R.China

Site: 966 chamber
Tel:+86-0755-26503290
Fax:+86-0755-26503396

Job No.: Bob #1608	Polarization: Horizontal
Standard: FCC Class B 3M Radiated	Power Source: AC 120V/60Hz
Test item: Radiation Test	Date: 12/06/27/
Temp.(C)/Hum.(%) 25 C / 50 %	Time: 10:35:56
EUT: TV BOX	Engineer Signature: Bob
Mode: TX Channel 1 (802.11g)	Distance: 3m
Model: IS-TV1200K	
Manufacturer: SWAGTEK	

Note: Report No.:ATE20121277

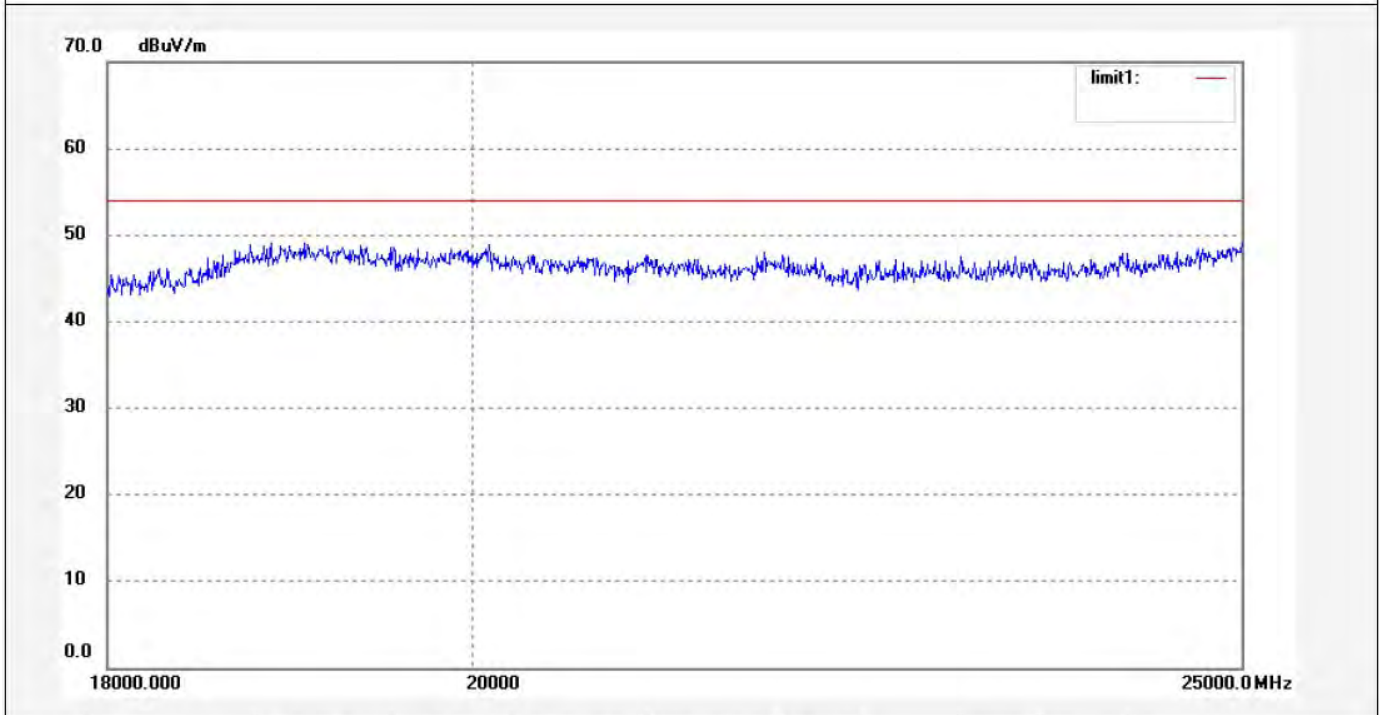

No.	Freq. (MHz)	Reading (dBuV/m)	Factor (dB)	Result (dBuV/m)	Limit (dBuV/m)	Margin (dB)	Detector	Height (cm)	Degree (deg.)	Remark
-----	-------------	------------------	-------------	-----------------	----------------	-------------	----------	-------------	---------------	--------



ACCURATE TECHNOLOGY CO., LTD.

F1,Bldg,A,Changyuan New Material Port Keyuan Rd,
Science & Industry Park,Nanshan Shenzhen,P.R.China

Site: 966 chamber
Tel:+86-0755-26503290
Fax:+86-0755-26503396

Job No.: Bob #1607	Polarization: Vertical
Standard: FCC Class B 3M Radiated	Power Source: AC 120V/60Hz
Test item: Radiation Test	Date: 12/06/27/
Temp.(C)/Hum.(%) 25 C / 50 %	Time: 10:32:05
EUT: TV BOX	Engineer Signature: Bob
Mode: TX Channel 1 (802.11g)	Distance: 3m
Model: IS-TV1200K	
Manufacturer: SWAGTEK	

Note: Report No.:ATE20121277

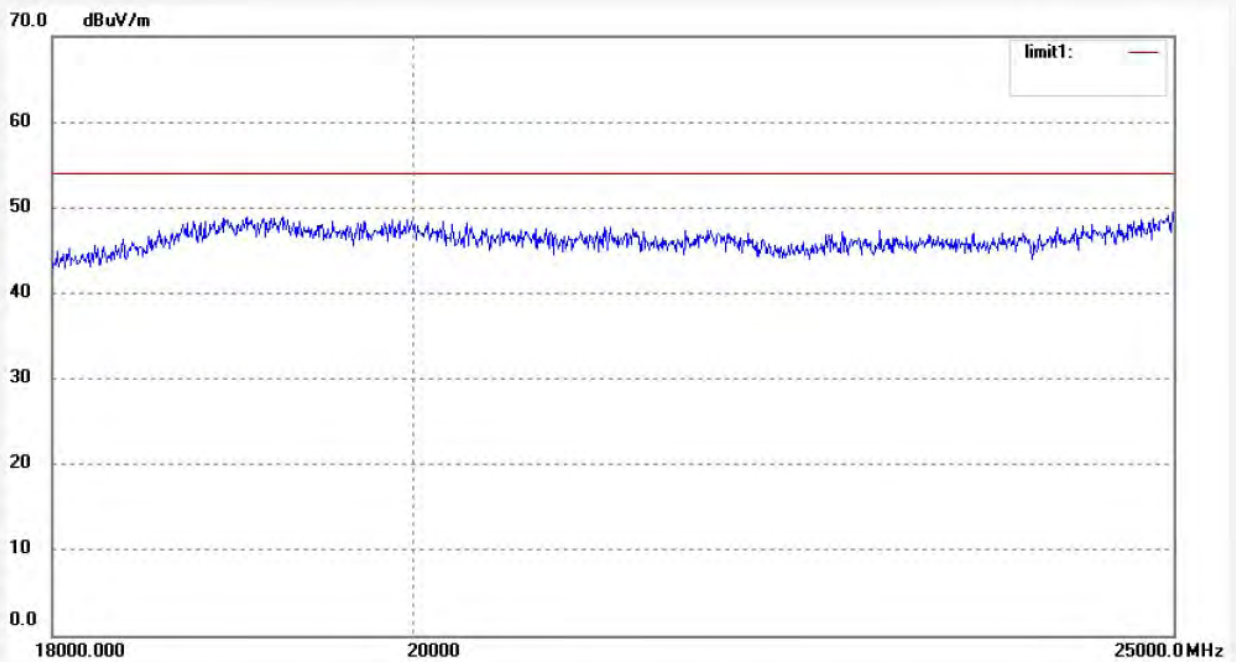

No.	Freq. (MHz)	Reading (dBuV/m)	Factor (dB)	Result (dBuV/m)	Limit (dBuV/m)	Margin (dB)	Detector	Height (cm)	Degree (deg.)	Remark
-----	-------------	------------------	-------------	-----------------	----------------	-------------	----------	-------------	---------------	--------



ACCURATE TECHNOLOGY CO., LTD.

F1,Bldg,A,Changyuan New Material Port Keyuan Rd,
Science & Industry Park,Nanshan Shenzhen,P.R.China

Site: 966 chamber
Tel:+86-0755-26503290
Fax:+86-0755-26503396

Job No.: Bob #1933
Standard: FCC Class B 3M Radiated
Test item: Radiation Test
Temp.(C)/Hum.(%) 25 C / 51 %
EUT: TV BOX
Mode: TX Channel 6(802.11g)
Model: IS-TV1200K
Manufacturer: SWAGTEK

Polarization: Horizontal
Power Source: AC 120V/60Hz
Date: 12/06/28/
Time: 10/50/02
Engineer Signature:
Distance: 3m

Note: Report NO.:ATE20121277

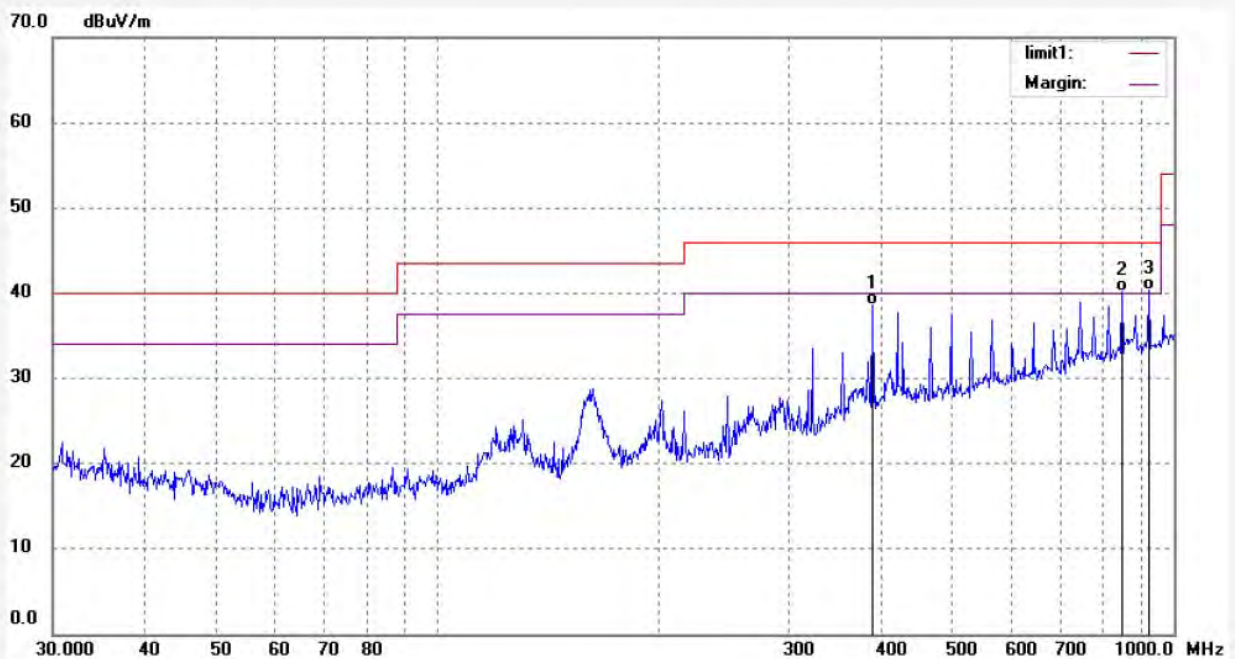

No.	Freq. (MHz)	Reading (dBuV/m)	Factor (dB)	Result (dBuV/m)	Limit (dBuV/m)	Margin (dB)	Detector	Height (cm)	Degree (deg.)	Remark
1	389.9874	16.70	21.88	38.58	46.00	-7.42	QP			
2	850.7603	11.78	28.36	40.14	46.00	-5.86	QP			
3	925.6132	11.26	29.16	40.42	46.00	-5.58	QP			



ACCURATE TECHNOLOGY CO., LTD.

F1,Bldg,A,Changyuan New Material Port Keyuan Rd,
Science & Industry Park,Nanshan Shenzhen,P.R.China

Site: 966 chamber
Tel:+86-0755-26503290
Fax:+86-0755-26503396

Job No.: Bob #1932
Standard: FCC Class B 3M Radiated
Test item: Radiation Test
Temp.(C)/Hum.(%) 25 C / 51 %
EUT: TV BOX
Mode: TX Channel 6(802.11g)
Model: IS-TV1200K
Manufacturer: SWAGTEK

Polarization: Vertical
Power Source: AC 120V/60Hz
Date: 12/06/28/
Time: 10/47/22
Engineer Signature:
Distance: 3m

Note: Report NO.:ATE20121277

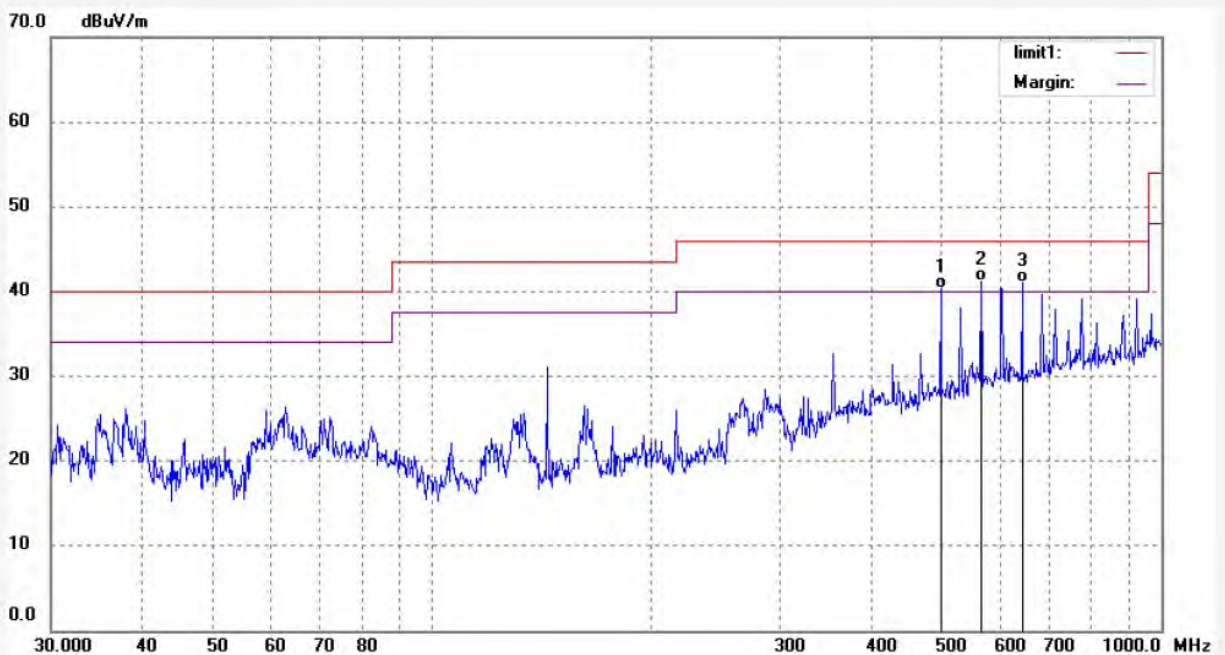

No.	Freq. (MHz)	Reading (dBuV/m)	Factor (dB)	Result (dBuV/m)	Limit (dBuV/m)	Margin (dB)	Detector	Height (cm)	Degree (deg.)	Remark
1	498.7303	16.33	23.98	40.31	46.00	-5.69	QP			
2	565.9776	15.86	25.27	41.13	46.00	-4.87	QP			
3	644.5531	14.95	26.08	41.03	46.00	-4.97	QP			



ACCURATE TECHNOLOGY CO., LTD.

F1,Bldg,A,Changyuan New Material Port Keyuan Rd,
Science & Industry Park,Nanshan Shenzhen,P.R.China

Site: 966 chamber
Tel:+86-0755-26503290
Fax:+86-0755-26503396

Job No.: Bob #2575
Standard: FCC Class B 3M Radiated
Test item: Radiation Test
Temp.(C)/Hum.(%) 24 C / 48 %
EUT: TV BOX
Mode: TX Channel 6 (802.11g)
Model: IS-TV1200K
Manufacturer: SWAGTEK

Polarization: Horizontal
Power Source: AC 120V/60Hz
Date: 12/06/29/
Time: 12:09:47
Engineer Signature: Bob
Distance: 3m

Note: Report No.:ATE20121277

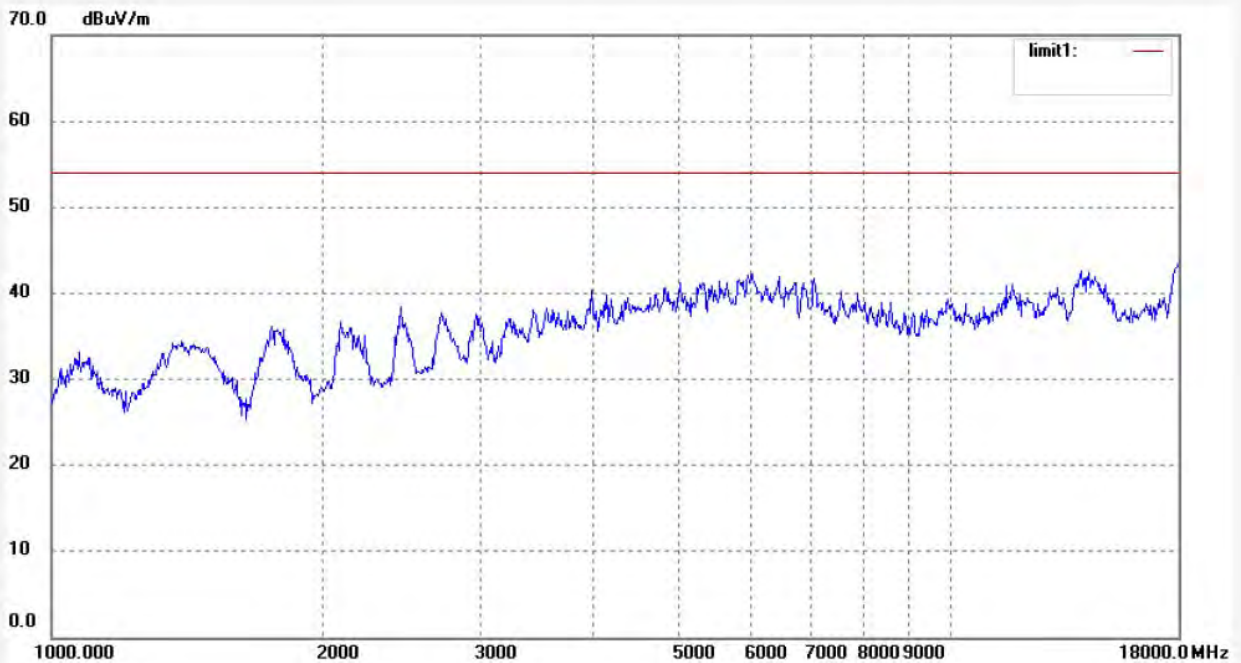

No.	Freq. (MHz)	Reading (dBuV/m)	Factor (dB)	Result (dBuV/m)	Limit (dBuV/m)	Margin (dB)	Detector	Height (cm)	Degree (deg.)	Remark
-----	-------------	------------------	-------------	-----------------	----------------	-------------	----------	-------------	---------------	--------



ACCURATE TECHNOLOGY CO., LTD.

F1,Bldg,A,Changyuan New Material Port Keyuan Rd,
Science & Industry Park,Nanshan Shenzhen,P.R.China

Site: 966 chamber
Tel:+86-0755-26503290
Fax:+86-0755-26503396

Job No.: Bob #2576	Polarization: Vertical
Standard: FCC Class B 3M Radiated	Power Source: AC 120V/60Hz
Test item: Radiation Test	Date: 12/06/29/
Temp.(C)/Hum.(%) 24 C / 48 %	Time: 12:13:30
EUT: TV BOX	Engineer Signature: Bob
Mode: TX Channel 6 (802.11g)	Distance: 3m
Model: IS-TV1200K	
Manufacturer: SWAGTEK	

Note: Report No.:ATE20121277

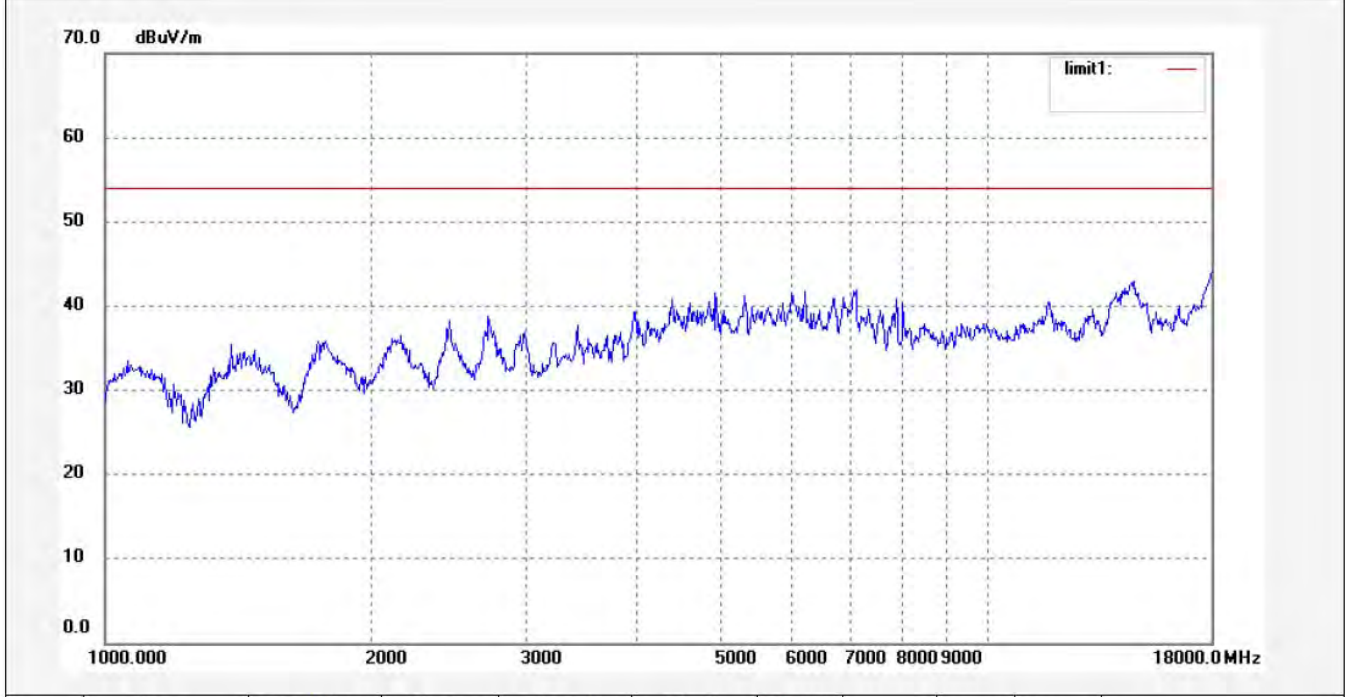

No.	Freq. (MHz)	Reading (dBuV/m)	Factor (dB)	Result (dBuV/m)	Limit (dBuV/m)	Margin (dB)	Detector	Height (cm)	Degree (deg.)	Remark
-----	-------------	------------------	-------------	-----------------	----------------	-------------	----------	-------------	---------------	--------



ACCURATE TECHNOLOGY CO., LTD.

F1,Bldg,A,Changyuan New Material Port Keyuan Rd,
Science & Industry Park,Nanshan Shenzhen,P.R.China

Site: 966 chamber
Tel:+86-0755-26503290
Fax:+86-0755-26503396

Job No.: Bob #1609	Polarization: Horizontal
Standard: FCC Class B 3M Radiated	Power Source: AC 120V/60Hz
Test item: Radiation Test	Date: 12/06/27/
Temp.(C)/Hum.(%) 25 C / 50 %	Time: 10:38:38
EUT: TV BOX	Engineer Signature: Bob
Mode: TX Channel 6 (802.11g)	Distance: 3m
Model: IS-TV1200K	
Manufacturer: SWAGTEK	

Note: Report No.:ATE20121277

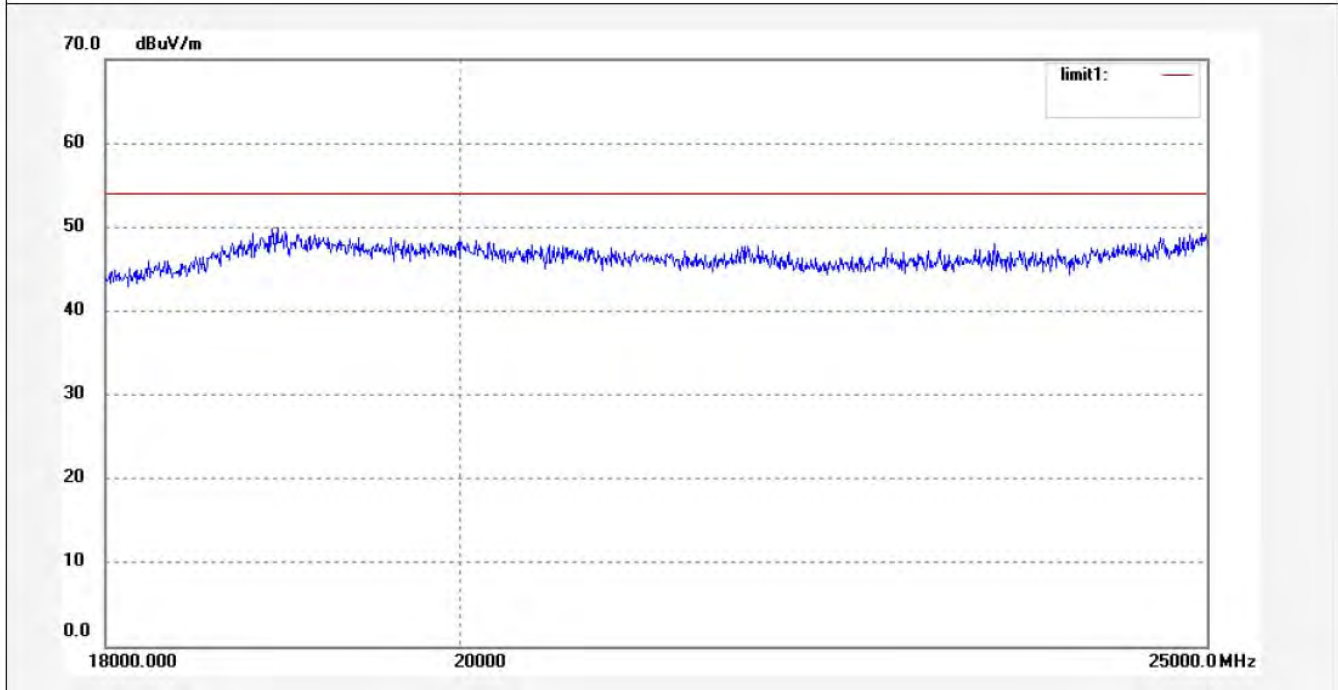

No.	Freq. (MHz)	Reading (dBuV/m)	Factor (dB)	Result (dBuV/m)	Limit (dBuV/m)	Margin (dB)	Detector	Height (cm)	Degree (deg.)	Remark
-----	-------------	------------------	-------------	-----------------	----------------	-------------	----------	-------------	---------------	--------



ACCURATE TECHNOLOGY CO., LTD.

F1,Bldg,A,Changyuan New Material Port Keyuan Rd,
Science & Industry Park,Nanshan Shenzhen,P.R.China

Site: 966 chamber
Tel:+86-0755-26503290
Fax:+86-0755-26503396

Job No.: Bob #1610	Polarization: Vertical
Standard: FCC Class B 3M Radiated	Power Source: AC 120V/60Hz
Test item: Radiation Test	Date: 12/06/27/
Temp.(C)/Hum.(%) 25 C / 50 %	Time: 10:43:17
EUT: TV BOX	Engineer Signature: Bob
Mode: TX Channel 6 (802.11g)	Distance: 3m
Model: IS-TV1200K	
Manufacturer: SWAGTEK	

Note: Report No.:ATE20121277

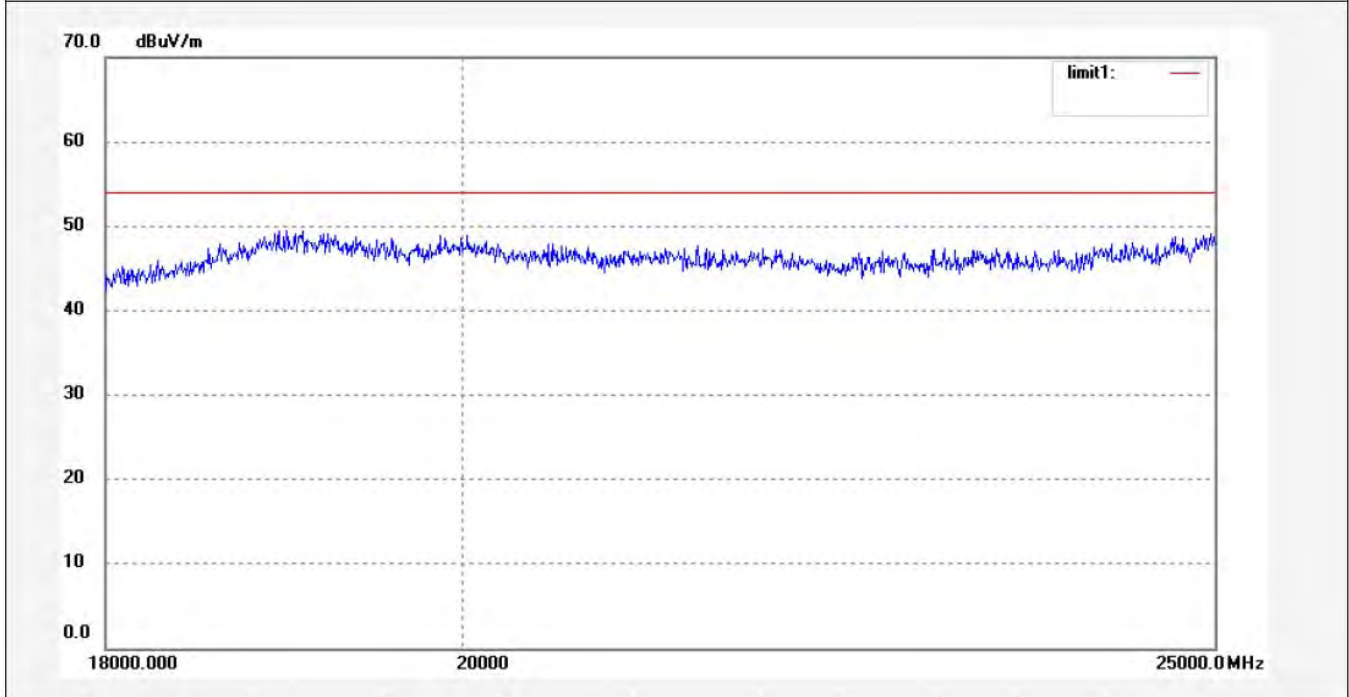

No.	Freq. (MHz)	Reading (dBuV/m)	Factor (dB)	Result (dBuV/m)	Limit (dBuV/m)	Margin (dB)	Detector	Height (cm)	Degree (deg.)	Remark
-----	-------------	------------------	-------------	-----------------	----------------	-------------	----------	-------------	---------------	--------