

## FCC TEST REPORT

For

SWAGTEK

Wi-Fi Tablet

Model No.: T7

Additional Model No.: iSWAG Allure Plus, UNONU U7007

Prepared for : SWAGTEK  
Address : 10205 NW 19th Street, STE101, Miami, FL, 33172, USA

Prepared by : Shenzhen LCS Compliance Testing Laboratory Ltd.  
Address : 1/F., Xingyuan Industrial Park, Tongda Road, Bao'an Avenue,  
Bao'an District, Shenzhen, Guangdong, China

Tel : (+86)755-82591330  
Fax : (+86)755-82591332  
Web : www.LCS-cert.com  
Mail : webmaster@LCS-cert.com

Date of receipt of test sample : October 23, 2015  
Number of tested samples : 1  
Date of Test : October 23, 2015- October 29, 2015  
Date of Report : October 29, 2015

**FCC TEST REPORT**  
**FCC CFR 47 PART 15 C(15.247): 2014**

**Report Reference No.** ..... : **LCS1510231222E**

Date of Issue..... : October 29, 2015

**Testing Laboratory Name** ..... : **Shenzhen LCS Compliance Testing Laboratory Ltd.**

Address..... : 1/F., Xingyuan Industrial Park, Tongda Road, Bao'an Avenue,  
 Bao'an District, Shenzhen, Guangdong, China

Testing Location/ Procedure ..... : Full application of Harmonised standards   
 Partial application of Harmonised standards   
 Other standard testing method

**Applicant's Name** ..... : **SWAGTEK**

Address..... : 10205 NW 19th Street, STE101, Miami, FL, 33172, USA

**Test Specification**

Standard..... : FCC CFR 47 PART 15 C(15.247): 2014

**Test Report Form No.** ..... : LCSEMC-1.0

TRF Originator..... : Shenzhen LCS Compliance Testing Laboratory Ltd.

Master TRF ..... : Dated 2011-03

**Shenzhen LCS Compliance Testing Laboratory Ltd. All rights reserved.**

This publication may be reproduced in whole or in part for non-commercial purposes as long as the Shenzhen LCS Compliance Testing Laboratory Ltd. is acknowledged as copyright owner and source of the material. Shenzhen LCS Compliance Testing Laboratory Ltd. takes no responsibility for and will not assume liability for damages resulting from the reader's interpretation of the reproduced material due to its placement and context.

**Test Item Description**..... : **Wi-Fi Tablet**

Trade Mark..... : LOGIC

Model/ Type reference ..... : T7

Ratings..... : DC 3.7V by battery (2600mAh)

Adapter:Input AC 100-240V 50/60Hz ,0.35A Output DC 5V/2A

Result ..... : **Positive**

**Compiled by:**



Dick Su / File administrators

**Supervised by:**



Glin Lu / Technique principal

**Approved by:**

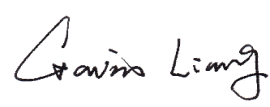

Gavin Liang/ Manager

# FCC -- TEST REPORT

<b>Test Report No. : LCS1510231222E</b>	<u>October 29, 2015</u> Date of issue
---	--

Type / Model..... : T7  EUT..... : Wi-Fi Tablet
<b>Applicant..... : SWAGTEK</b> Address..... : 10205 NW 19th Street, STE101, Miami, FL, 33172, USA Telephone..... : / Fax..... : /
<b>Manufacturer..... : SWAGTEK</b> Address..... : 10205 NW 19th Street, STE101, Miami, FL, 33172, USA Telephone..... : / Fax..... : /
<b>Factory..... : SWAGTEK</b> Address..... : 10205 NW 19th Street, STE101, Miami, FL, 33172, USA Telephone..... : / Fax..... : /

<b>Test Result</b>	<b>Positive</b>
--------------------	-----------------

The test report merely corresponds to the test sample.

It is not permitted to copy extracts of these test result without the written permission of the test laboratory.

## TABLE OF CONTENTS

<b>1. GENERAL INFORMATION .....</b>	<b>5</b>
1.1. DESCRIPTION OF DEVICE (EUT) .....	5
1.2. SUPPORT EQUIPMENT LIST .....	5
1.3. EXTERNAL I/O CABLE .....	5
1.4. DESCRIPTION OF TEST FACILITY .....	6
1.5. STATEMENT OF THE MEASUREMENT UNCERTAINTY .....	6
1.6. MEASUREMENT UNCERTAINTY .....	6
1.7. DESCRIPTION OF TEST MODES .....	7
<b>2. TEST METHODOLOGY .....</b>	<b>8</b>
2.1 EUT CONFIGURATION .....	8
2.2 EUT EXERCISE .....	8
2.3 GENERAL TEST PROCEDURES .....	8
<b>3. SYSTEM TEST CONFIGURATION .....</b>	<b>9</b>
3.1. JUSTIFICATION .....	9
3.2. EUT EXERCISE SOFTWARE .....	9
3.3. SPECIAL ACCESSORIES .....	9
3.4. BLOCK DIAGRAM/SCHEMATICS .....	9
3.5. EQUIPMENT MODIFICATIONS .....	9
3.6. TEST SETUP .....	9
<b>4. SUMMARY OF TEST RESULTS.....</b>	<b>10</b>
<b>5. SUMMARY OF TEST EQUIPMENT .....</b>	<b>11</b>
<b>6. TEST RESULT .....</b>	<b>12</b>
6.1. MAXIMUM CONDUCTED OUTPUT POWER MEASUREMENT .....	12
6.2. POWER SPECTRAL DENSITY MEASUREMENT .....	14
6.3. 6 DB SPECTRUM BANDWIDTH MEASUREMENT .....	22
6.4. RADIATED EMISSIONS MEASUREMENT .....	30
6.5. CONDUCTED SPURIOUS EMISSIONS AND BAND EDGES TEST .....	44
6.6. POWER LINE CONDUCTED EMISSIONS .....	55
<b>7. ANTENNA REQUIREMENT .....</b>	<b>58</b>
7.1 STANDARD APPLICABLE .....	58
7.2 ANTENNA CONNECTED CONSTRUCTION .....	58

## 1. GENERAL INFORMATION

### 1.1. Description of Device (EUT)

EUT	: Wi-Fi Tablet
Test Model	: T7
Power Supply	: DC 3.7V by lithium polymer battery(2600mAh) : Adapter:Input AC 100-240V 50/60Hz ,0.35A    Output DC 18V/3.6A
Hardware Version	: /
Software Version	: /
WIFI	:
Frequency Range	: 2412-2462MHz
Channel Spacing	: 5MHz
Channel Number	: 11 Channel for 20MHz bandwidth(2412~2462MHz) : 7 channels for 40MHz bandwidth(2422~2452MHz)
Modulation Type	: 802.11b: DSSS; 802.11g/n: OFDM
Antenna Description	: Integral Antenna, 1.0dBi(Max.)

### 1.2. Support equipment List

Manufacturer	Description	Model	Serial Number	Certificate
--	Adapter	--	--	--

### 1.3. External I/O Cable

I/O Port Description	Quantity	Cable
USB Port	1	N/A
TF Slot	1	N/A
Line IN	1	N/A

## 1.4. Description of Test Facility

### Site Description

#### EMC Lab.

: CNAS Registration Number. is L4595.  
 FCC Registration Number. is 899208.  
 Industry Canada Registration Number. is 9642A-1.  
 VCCI Registration Number. is C-4260 and R-3804.  
 ESMD Registration Number. is ARCB0108.  
 UL Registration Number. is 100571-492.  
 TUV SUD Registration Number. is SCN1081.  
 TUV RH Registration Number. is UA 50296516-001

Name of Firm : Shenzhen LCS Compliance Testing Laboratory Ltd.

Site Location : 1/F., Xingyuan Industrial Park, Tongda Road, Bao'an Avenue,  
 Bao'an District, Shenzhen, Guangdong, China

## 1.5. Statement of The Measurement Uncertainty

The data and results referenced in this document are true and accurate. The reader is cautioned that there may be errors within the calibration limits of the equipment and facilities. The measurement uncertainty was calculated for all measurements listed in this test report acc. To CISPR 16 – 4 “Specification for radio disturbance and immunity measuring apparatus and methods – Part 4: Uncertainty in EMC Measurements” and is documented in the LCS quality system acc. To DIN EN ISO/IEC 17025. Furthermore, component and process variability of devices similar to that tested may result in additional deviation. The manufacturer has the sole responsibility of continued compliance of the device.

## 1.6. Measurement Uncertainty

Test Item	Frequency Range	Uncertainty	Note
Radiation Uncertainty	9KHz~30MHz	3.10dB	(1)
	30MHz~200MHz	2.96dB	(1)
	200MHz~1000MHz	3.10dB	(1)
	1GHz~26.5GHz	3.80dB	(1)
	26.5GHz~40GHz	3.90dB	(1)
Conduction Uncertainty	150kHz~30MHz	1.63dB	(1)
Power disturbance	30MHz~300MHz	1.60dB	(1)

(1). This uncertainty represents an expanded uncertainty expressed at approximately the 95% confidence level using a coverage factor of  $k=2$ .

## 1.7. Description Of Test Modes

The EUT has been tested under operating condition.

This test was performed with EUT in X, Y, Z position and the worse case was found when EUT in X position.

Worst-case mode and channel used for 150kHz-30 MHz power line conducted emissions was the mode and channel with the highest output power, that was determined to be 802.11b mode(Low Channel).

Worst-case mode and channel used for 9kHz-1000 MHz radiated emissions was the mode and channel with the highest output power, that was determined to be 802.11b mode(Low Channel).

Worst-Case data rates were utilized from preliminary testing of the Chipset, worst-case data rates used during the testing are as follows:

802.11b Mode : 1 Mbps, DSSS.

802.11g Mode : 6 Mbps, OFDM.

802.11n Mode HT20:.MCS0, OFDM.

802.11n Mode HT40:.MCS0, OFDM.

### Channel List & Frequency

#### 802.11b/g/n(HT20)

Frequency Band	Channel No.	Frequency(MHz)	Channel No.	Frequency(MHz)
2412~2462MHz	1	2412	7	2442
	2	2417	8	2447
	3	2422	9	2452
	4	2427	10	2457
	5	2432	11	2462
	6	2437	--	--

#### 802.11n(HT40)

Frequency Band	Channel No.	Frequency(MHz)	Channel No.	Frequency(MHz)
2422~2452MHz	1	--	7	2442
	2	--	8	2447
	3	2422	9	2452
	4	2427	10	--
	5	2432	11	--
	6	2437	--	--

## 2. TEST METHODOLOGY

The tests documented in this report were performed in accordance with ANSI C63.10-2013, RSS-210, FCC CFR PART 15C 15.207, 15.209, 15.247 and DA 00-705.

### 2.1 EUT Configuration

The EUT configuration for testing is installed on RF field strength measurement to meet the Commissions requirement and operating in a manner that intends to maximize its emission characteristics in a continuous normal application.

### 2.2 EUT Exercise

The EUT was operated in the engineering mode to fix the TX frequency that was for the purpose of the measurements.

According to its specifications, the EUT must comply with the requirements of the Section 15.207, 15.209, 15.247 under the FCC Rules Part 15 Subpart C and RSS-210.

### 2.3 General Test Procedures

#### 2.3.1 Conducted Emissions

The EUT is placed on the turntable, which is 0.8 m above ground plane. According to the requirements in Section 6.2.1 of ANSI C63.10-2013 Conducted emissions from the EUT measured in the frequency range between 0.15 MHz and 30MHz using Quasi-peak and average detector modes.

#### 2.3.2 Radiated Emissions

The EUT is placed on a turn table, which is 0.8 m above ground plane. The turntable shall rotate 360 degrees to determine the position of maximum emission level. EUT is set 3m away from the receiving antenna, which varied from 1m to 4m to find out the highest emission. And also, each emission was to be maximized by changing the polarization of receiving antenna both horizontal and vertical. In order to find out the maximum emissions, exploratory radiated emission measurements were made according to the requirements in Section 6.3 of ANSI C63.10-2013



### 3. SYSTEM TEST CONFIGURATION

#### 3.1. Justification

Note: The EUT was programmed to be in continuously transmitting mode and the transmit duty cycle is not less than 98%.

#### 3.2. EUT Exercise Software

N/A

#### 3.3. Special Accessories

N/A

#### 3.4. Block Diagram/Schematics

Please refer to the related document

#### 3.5. Equipment Modifications

Shenzhen LCS Compliance Testing Laboratory Ltd. has not done any modification on the EUT.

#### 3.6. Test Setup

Please refer to the test setup photo.

#### 4. SUMMARY OF TEST RESULTS

<b>Applied Standard: FCC Part 15 Subpart C</b>		
<b>FCC Rules</b>	<b>Description of Test</b>	<b>Result</b>
§15.247(b)	Maximum Conducted Output Power	Compliant
§15.247(e)	Power Spectral Density	Compliant
§15.247(a)(2)	6dB Bandwidth	Compliant
§15.247(a)	Occupied Bandwidth	Compliant
§15.209, §15.247(d)	Radiated and Conducted Spurious Emissions	Compliant
§15.205	Emissions at Restricted Band	Compliant
§15.207(a)	Conducted Emissions	Compliant
§15.203	Antenna Requirements	Compliant

## 5. SUMMARY OF TEST EQUIPMENT

Item	Equipment	Manufacturer	Model No.	Serial No.	Last Cal.	Next Cal.
1	Power Sensor	R&S	NRV-Z51	100458	2015-06-18	2016-06-17
2	Power Sensor	R&S	NRV-Z32	10057	2015-06-18	2016-06-17
3	Power Meter	R&S	NRVS	100444	2015-06-18	2016-06-17
4	DC Filter	MPE	23872C	N/A	2015-06-18	2016-06-17
5	RF Cable	Harbour Industries	1452	N/A	2015-06-18	2016-06-17
6	SMA Connector	Harbour Industries	9625	N/A	2015-06-18	2016-06-17
7	Spectrum Analyzer	Agilent	N9020A	MY50510140	2015-10-27	2016-10-26
8	Signal analyzer	Agilent	E4448A(External mixers to 40GHz)	US44300469	2015-06-16	2016-06-15
9	RF Cable	Hubersuhne	Sucoflex104	FP2RX2	2015-06-18	2016-06-17
10	3m Semi Anechoic Chamber	SIDT FRANKONIA	SAC-3M	03CH03-HY	2015-06-18	2016-06-17
11	Amplifier	SCHAFFNER	COA9231A	18667	2015-06-18	2016-06-17
12	Amplifier	Agilent	8449B	3008A02120	2015-06-18	2016-06-17
13	Amplifier	MITEQ	AMF-6F-260400	9121372	2015-06-16	2016-06-15
14	Loop Antenna	R&S	HFH2-Z2	860004/001	2015-06-18	2016-06-17
15	By-log Antenna	SCHWARZBECK	VULB9163	9163-470	2015-06-10	2016-06-09
16	Horn Antenna	EMCO	3115	6741	2015-06-10	2016-06-09
17	Horn Antenna	SCHWARZBECK	BBHA9170	BBHA9170154	2015-06-10	2016-06-09
18	RF Cable-R03m	Jye Bao	RG142	CB021	2015-06-18	2016-06-17
19	RF Cable-HIGH	SUHNER	SUCOFLEX 106	03CH03-HY	2015-06-18	2016-06-17
20	EMI Test Receiver	ROHDE & SCHWARZ	ESCI	101142	2015-06-18	2016-06-17
21	EMI Test Receiver	ROHDE & SCHWARZ	ESPI	101840	2015-06-18	2016-06-17
22	Artificial Mains	ROHDE & SCHWARZ	ENV216	101288	2015-06-18	2016-06-17
23	EMI Test Software	AUDIX	E3	N/A	2015-06-18	2016-06-17

## 6. TEST RESULT

### 6.1. Maximum Conducted Output Power Measurement

#### 6.1.1. Standard Applicable

According to §15.247(b): For systems using digital modulation in the 2400-2483.5 MHz and 5725-5850 MHz band, the limit for maximum peak conducted output power is 30dBm. The limit has to be reduced by the amount in dB that the gain of the antenna exceed 6dBi. In case of point-to-point operation, the limit has to be reduced by 1dB for every 3dB that the directional gain of the antenna exceeds 6dBi.

Systems operating in the 5725-5850 MHz band that are used exclusively for fixed, point-to-point operations may employ transmitting antennas with directional gain greater than 6dBi without any corresponding reduction in transmitter peak output power.

#### 6.1.2. Measuring Instruments

Please refer to section 6 of equipments list in this report.

#### 6.1.3. Test Procedures

The transmitter output (antenna port) was connected to the power meter.

#### 6.1.4. Test Setup Layout

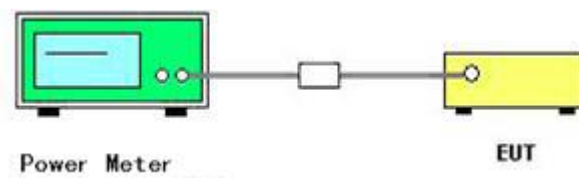

#### 6.1.5. EUT Operation during Test

The EUT was programmed to be in continuously transmitting mode.

## 6.1.6. Test Result of Maximum Conducted Output Power

Temperature	25°C	Humidity	60%
Test Engineer	Dick	Configurations	802.11b/g/n

## 802.11b

Channel	Frequency (MHz)	Conducted Peak Power (dBm)	Max. Limit (dBm)	Result
1	2412	8.37	30	Complies
6	2437	8.51	30	Complies
11	2462	8.34	30	Complies

## 802.11g

Channel	Frequency (MHz)	Conducted Peak Power (dBm)	Max. Limit (dBm)	Result
1	2412	7.61	30	Complies
6	2437	7.26	30	Complies
11	2462	7.15	30	Complies

## 802.11n HT20

Channel	Frequency (MHz)	Conducted Peak Power (dBm)	Max. Limit (dBm)	Result
1	2412	6.45	30	Complies
6	2437	6.43	30	Complies
11	2462	6.56	30	Complies

## 802.11n HT40

Channel	Frequency (MHz)	Conducted Peak Power (dBm)	Max. Limit (dBm)	Result
3	2422	6.34	30	Complies
6	2437	6.06	30	Complies
9	2452	6.47	30	Complies

Note: The relevant measured result has the offset with cable loss already.

## 6.2. Power Spectral Density Measurement

### 5.2.1. Standard Applicable

According to §15.247(e): For digitally modulated systems, the power spectral density conducted from the intentional radiator to the antenna shall not be greater than 8 dBm in any 3 kHz band during any time interval of continuous transmission.

### 5.2.2. Measuring Instruments

Please refer to section 6 of equipments list in this report.

### 5.2.3. Test Procedures

1. The transmitter was connected directly to a Spectrum Analyzer through a directional couple.
2. The power was monitored at the coupler port with a Spectrum Analyzer. The power level was set to the maximum level.
3. Set the RBW = 3 kHz.
4. Set the VBW  $\geq 3 \times$  RBW
5. Set the span to 1.5 times the DTS channel bandwidth.
6. Detector = peak.
7. Sweep time = auto couple.
8. Trace mode = max hold.
9. Allow trace to fully stabilize.
10. Use the peak marker function to determine the maximum power level in any 3 kHz band segment within the fundamental EBW.

### 5.2.4. Test Setup Layout

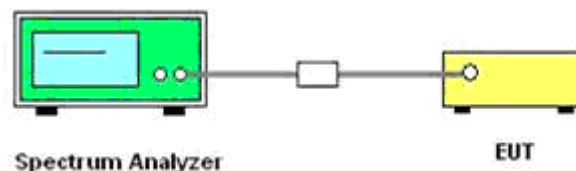

### 6.2.5. EUT Operation during Test

The EUT was programmed to be in continuously transmitting mode.

## 6.2.6. Test Result of Power Spectral Density

Temperature	25°C	Humidity	60%
Test Engineer	Dick	Configurations	802.11b/g/n

## 802.11b

Channel	Frequency (MHz)	Power Density (dBm/3KHz)	Max. Limit (dBm/3KHz)	Result
1	2412	-14.257	8	Complies
6	2437	-15.159	8	Complies
11	2462	-15.589	8	Complies

## 802.11g

Channel	Frequency (MHz)	Power Density (dBm/3KHz)	Max. Limit (dBm/3KHz)	Result
1	2412	-18.287	8	Complies
6	2437	-18.175	8	Complies
11	2462	-18.078	8	Complies

## 802.11n HT20

Channel	Frequency (MHz)	Power Density (dBm/3KHz)	Max. Limit (dBm/3KHz)	Result
1	2412	-18.062	8	Complies
6	2437	-20.628	8	Complies
11	2462	-21.894	8	Complies

## 802.11n HT40

Channel	Frequency (MHz)	Power Density (dBm/3KHz)	Max. Limit (dBm/3KHz)	Result
3	2422	-24.816	8	Complies
6	2437	-23.496	8	Complies
9	2452	-22.596	8	Complies

Note: The measured power density (dBm) has the offset with cable loss already.

### 802.11b power density

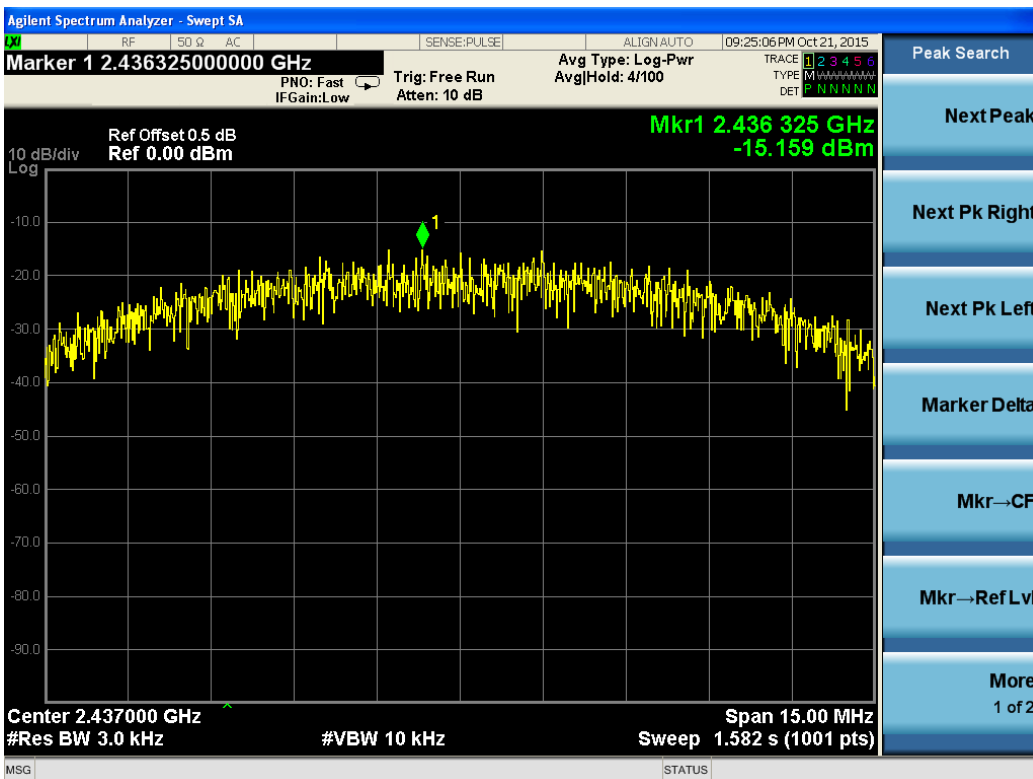
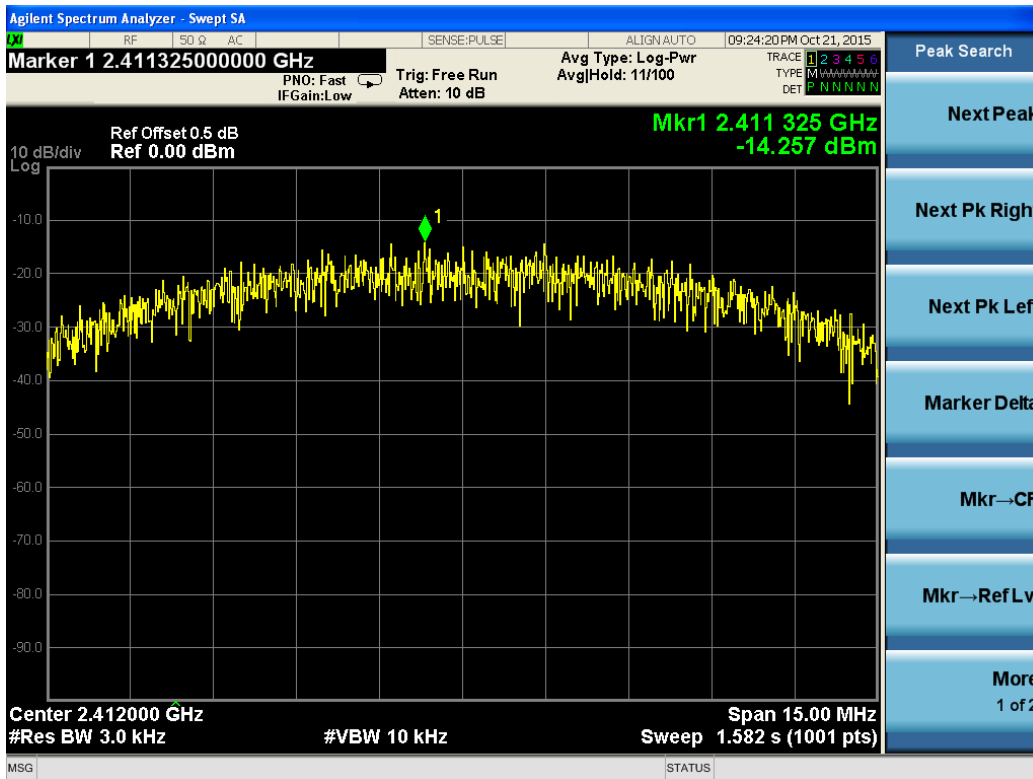



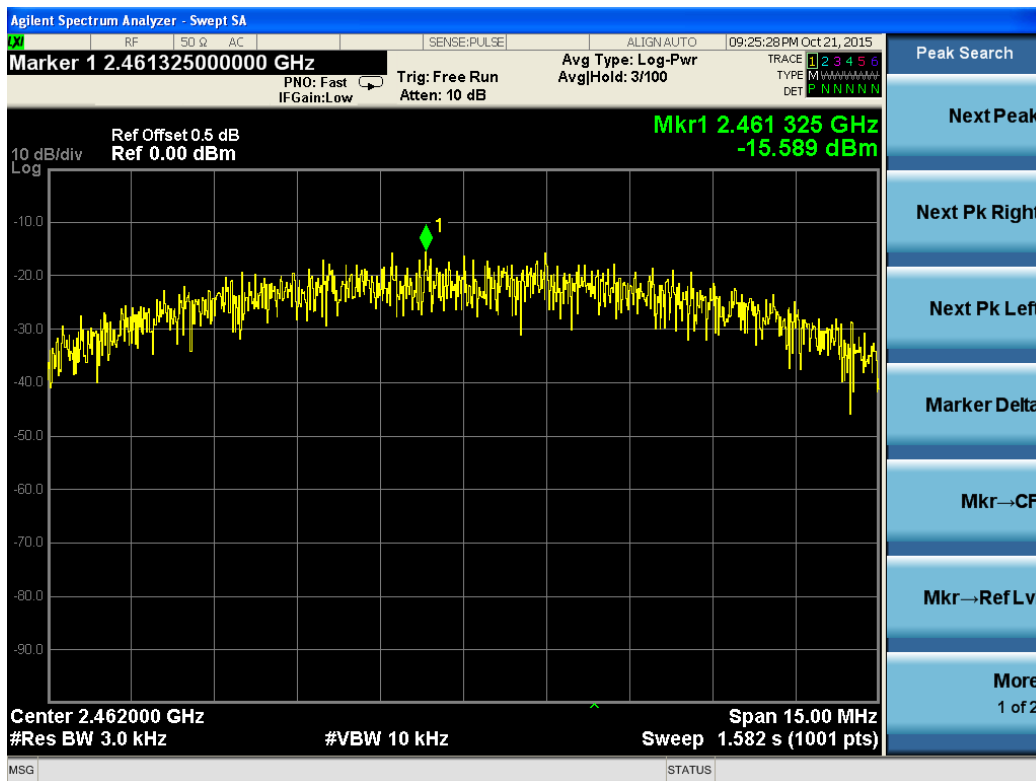

802.11g power density

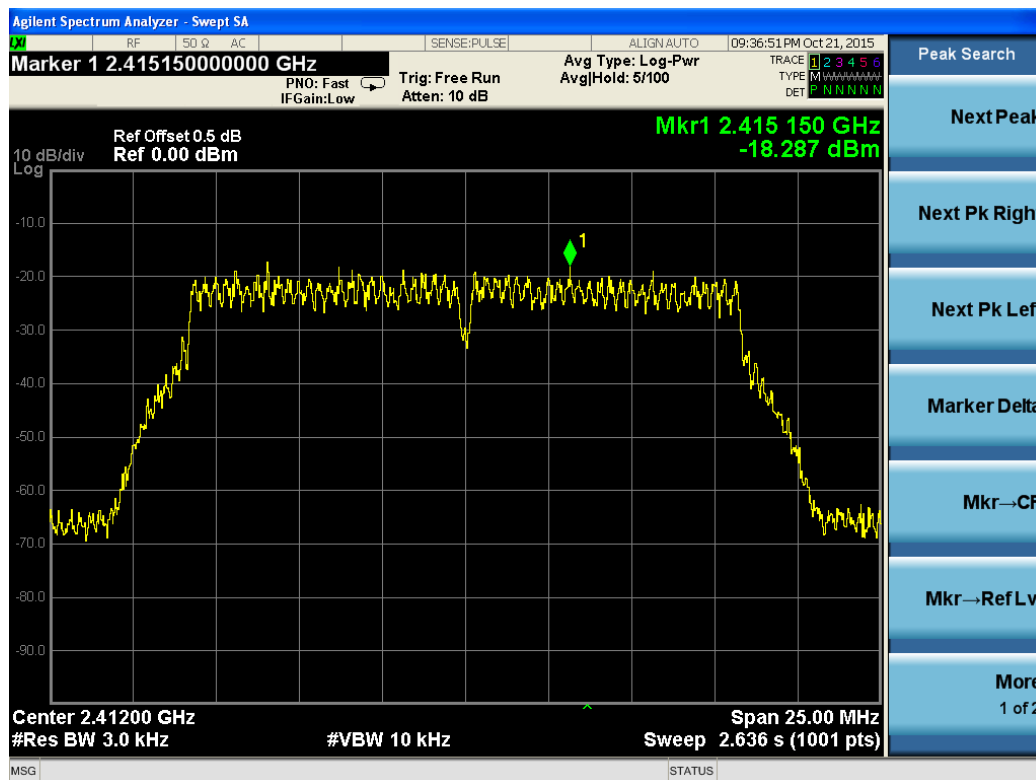

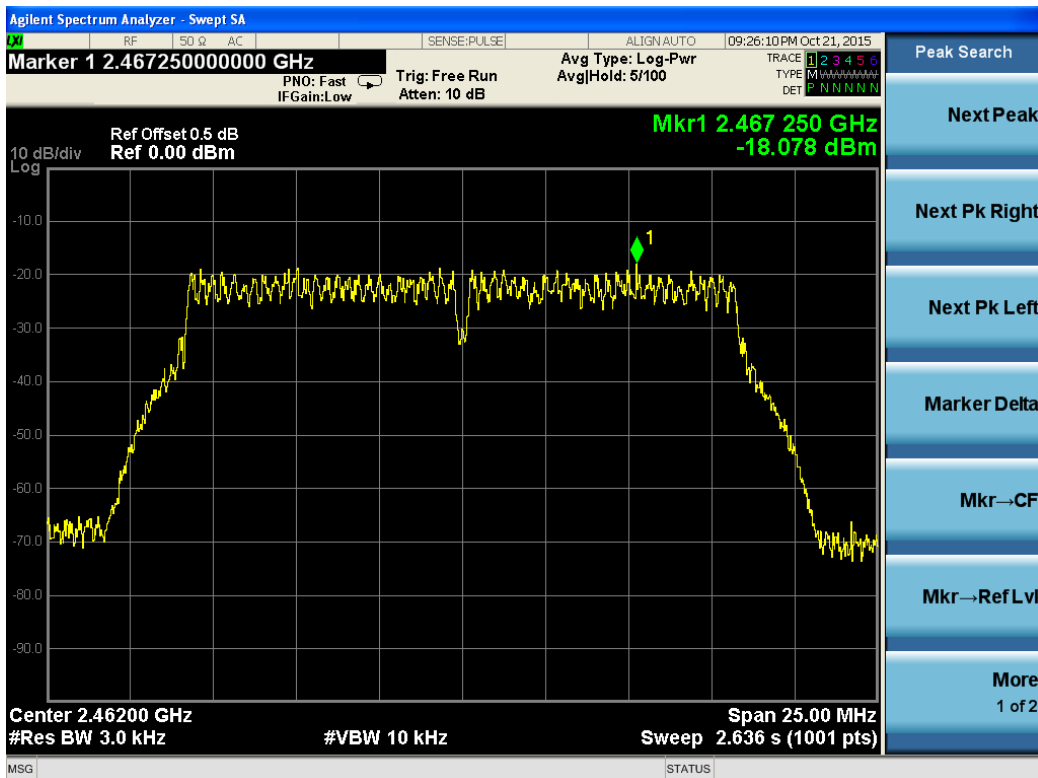
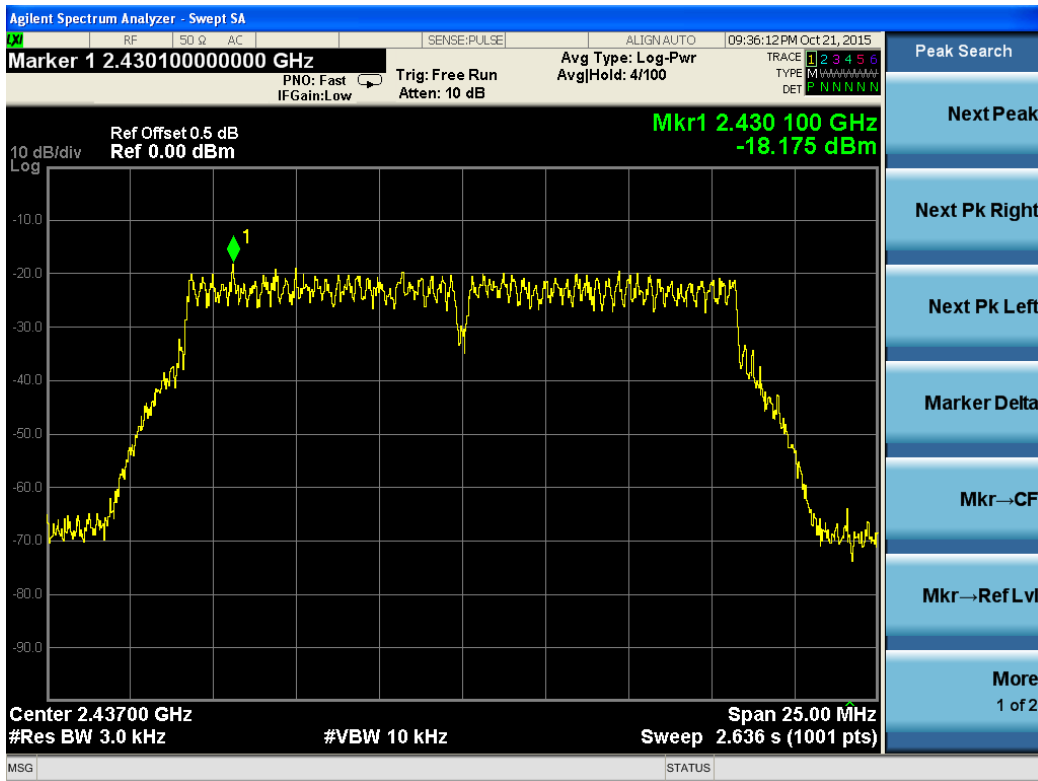

802.11n HT20 power density

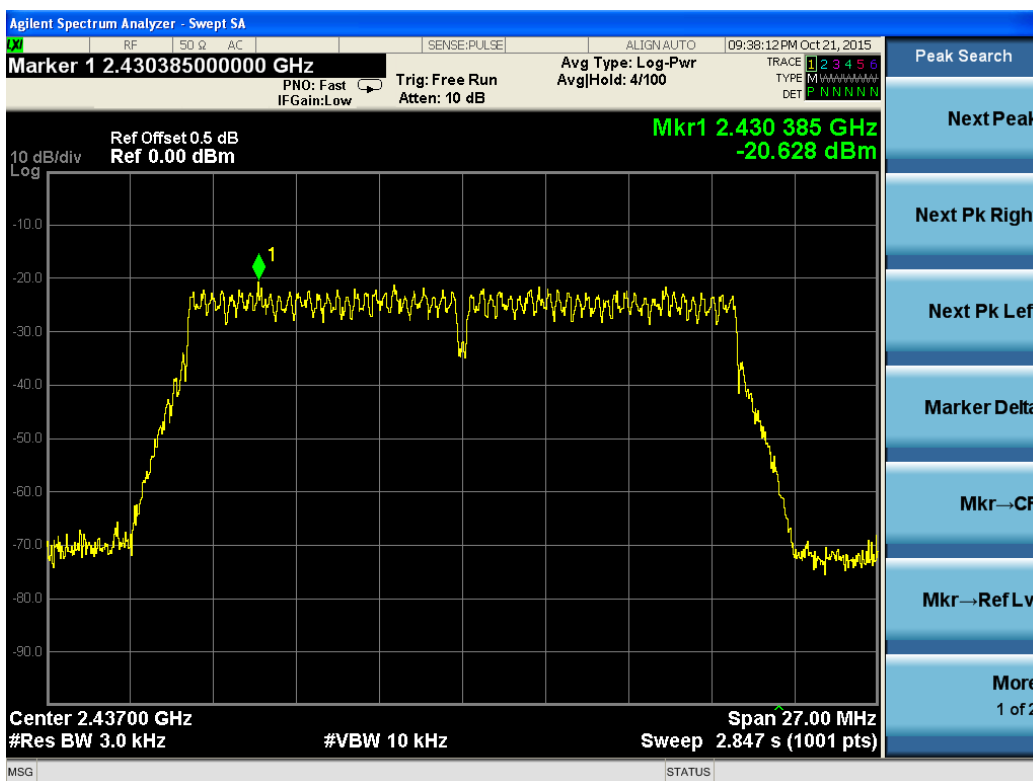
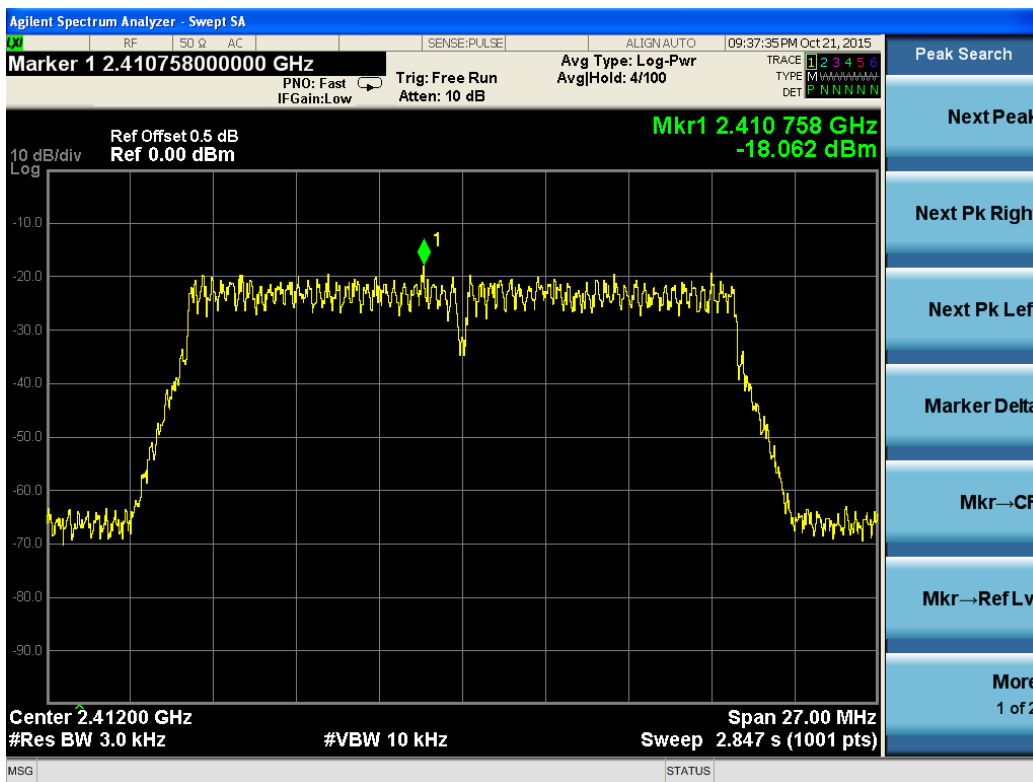

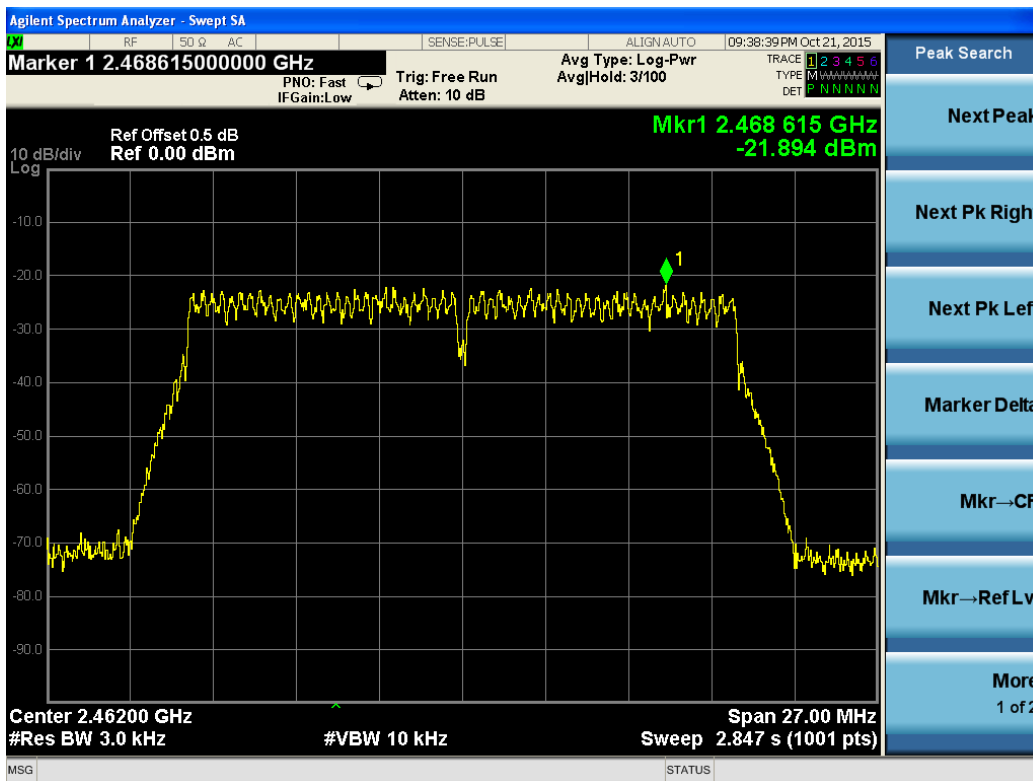

802.11n HT40 power density

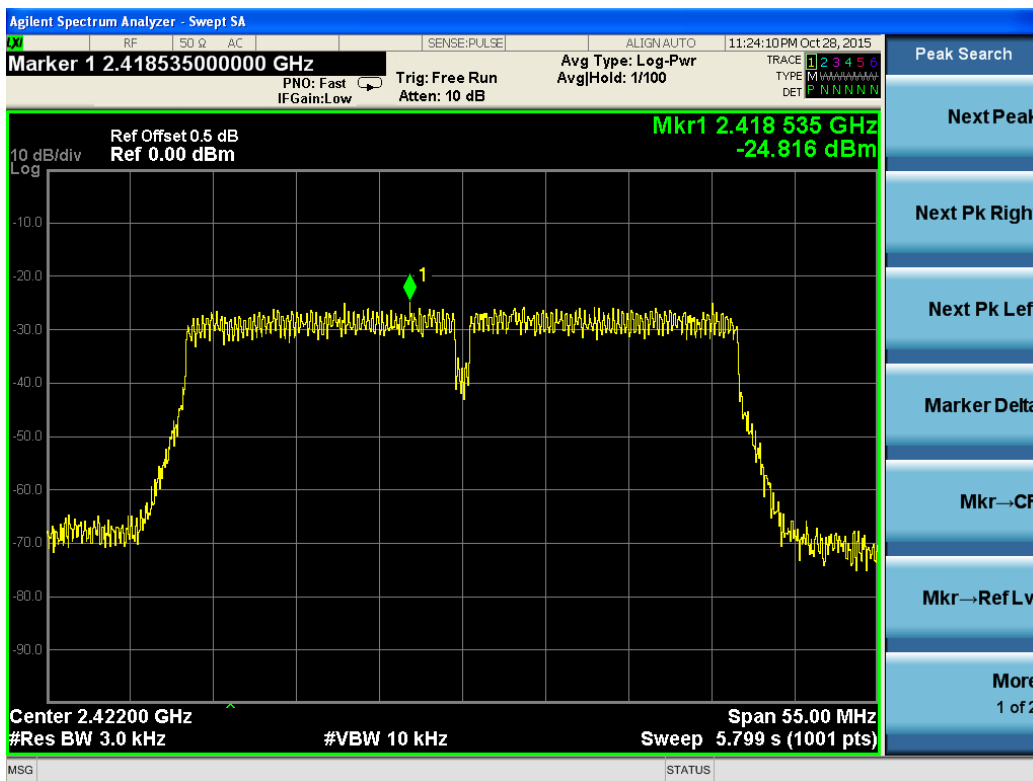

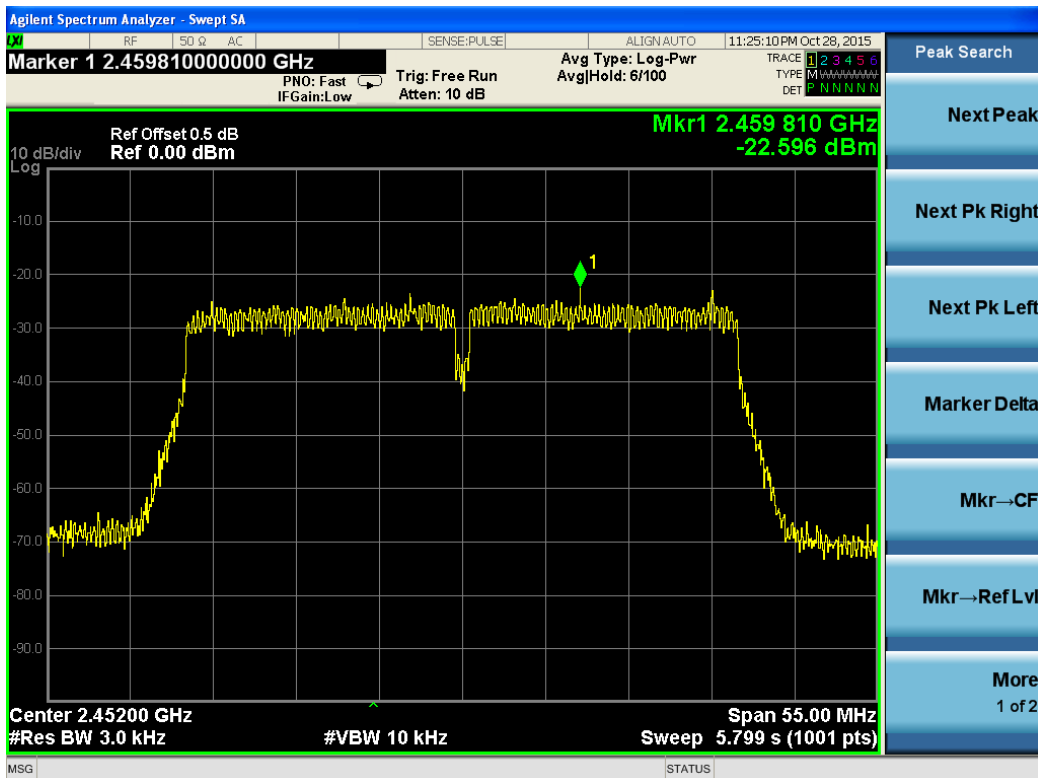
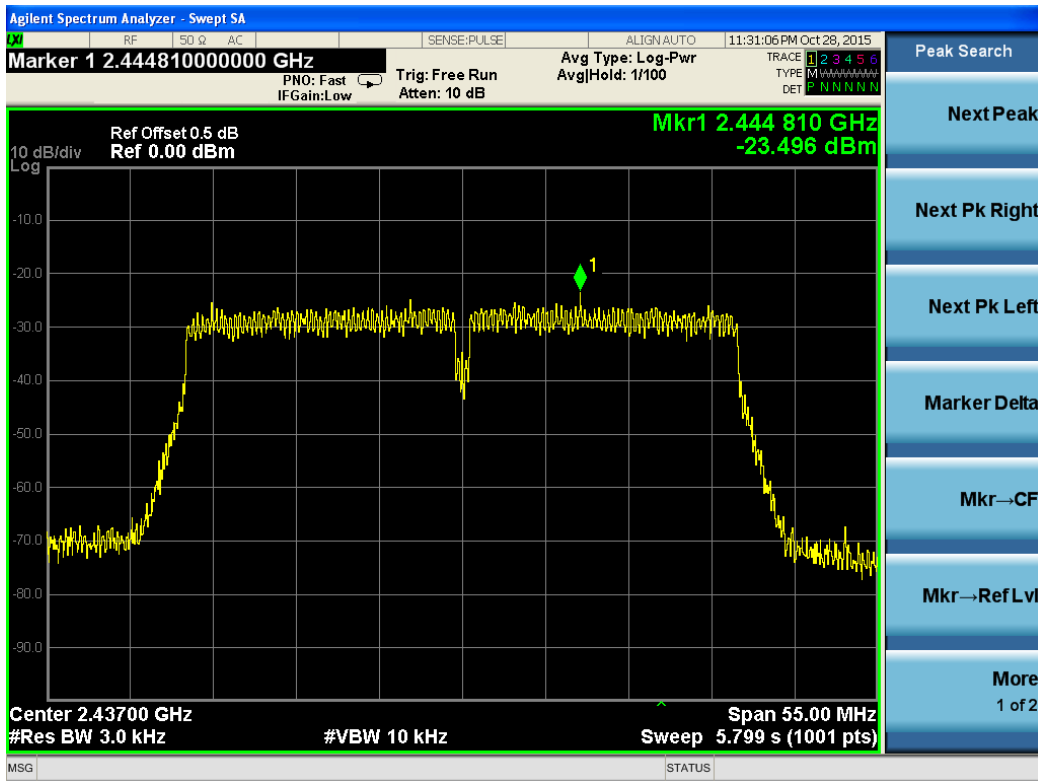

### 6.3. 6 dB Spectrum Bandwidth Measurement

#### 6.3.1. Standard Applicable

According to §15.247(a)(2): For digital modulation systems, the minimum 6 dB bandwidth shall be at least 500 kHz.

#### 6.3.2. Measuring Instruments and Setting

Please refer to section 6 of equipments list in this report. The following table is the setting of the Spectrum Analyzer.

Spectrum Parameter	Setting
Attenuation	Auto
Span Frequency	> RBW
Detector	Peak
Trace	Max Hold
Sweep Time	100ms

#### 6.3.3. Test Procedures

1. The transmitter output (antenna port) was connected to the spectrum analyser in peak hold mode.
2. The resolution bandwidth and the video bandwidth were set according to KDB558074.
3. Measured the spectrum width with power higher than 6dB below carrier.

#### 6.3.4. Test Setup Layout

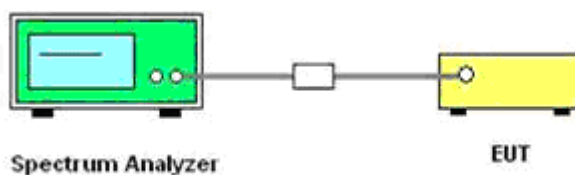

#### 6.3.5. EUT Operation during Test

The EUT was programmed to be in continuously transmitting mode.

#### 6.3.6. Test Result of 6dB Spectrum Bandwidth

Temperature	25°C	Humidity	60%
Test Engineer	Dick	Configurations	802.11b/g/n

## 802.11b

Channel	Frequency	6dB Bandwidth (MHz)	Min. Limit (kHz)	Result
1	2412	9.535	500	Complies
6	2437	9.536	500	Complies
11	2462	9.533	500	Complies

## 802.11g

Channel	Frequency	6dB Bandwidth (MHz)	Min. Limit (kHz)	Result
1	2412	16.61	500	Complies
6	2437	16.61	500	Complies
11	2462	16.62	500	Complies

## 802.11n HT20

Channel	Frequency	6dB Bandwidth (MHz)	Min. Limit (kHz)	Result
1	2412	17.81	500	Complies
6	2437	17.84	500	Complies
11	2462	17.84	500	Complies

## 802.11n HT40

Channel	Frequency	6dB Bandwidth (MHz)	Min. Limit (kHz)	Result
3	2422	36.51	500	Complies
6	2437	36.49	500	Complies
9	2452	36.51	500	Complies

802.11b channel, 6dB bandwidth

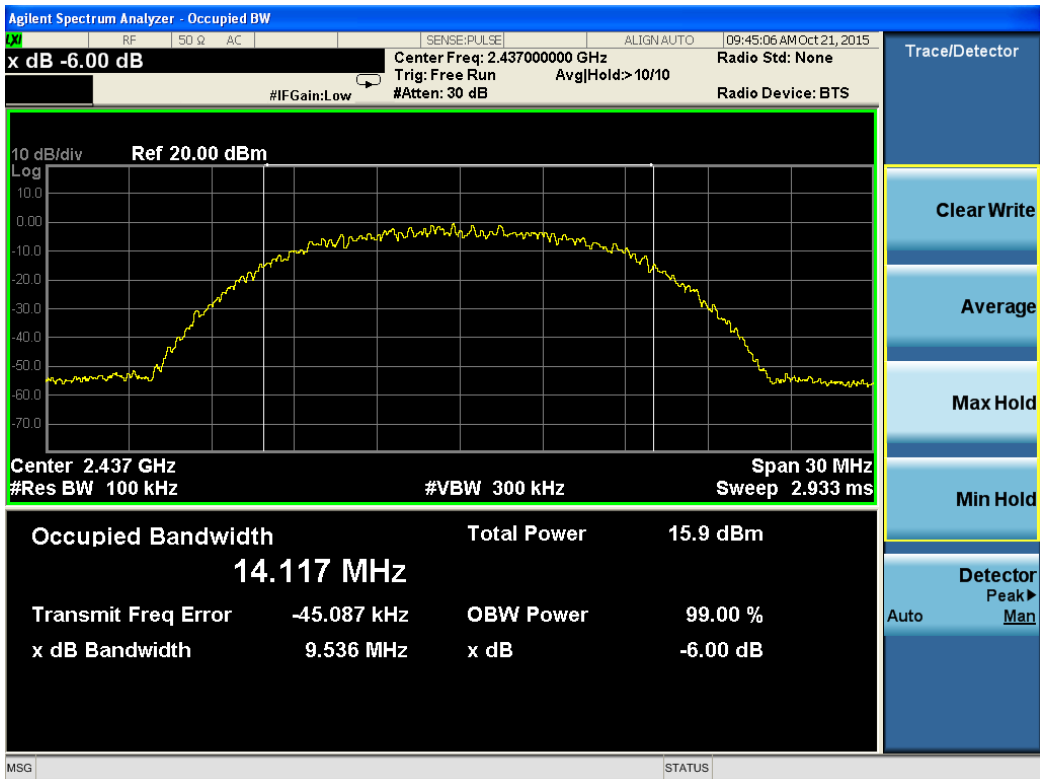
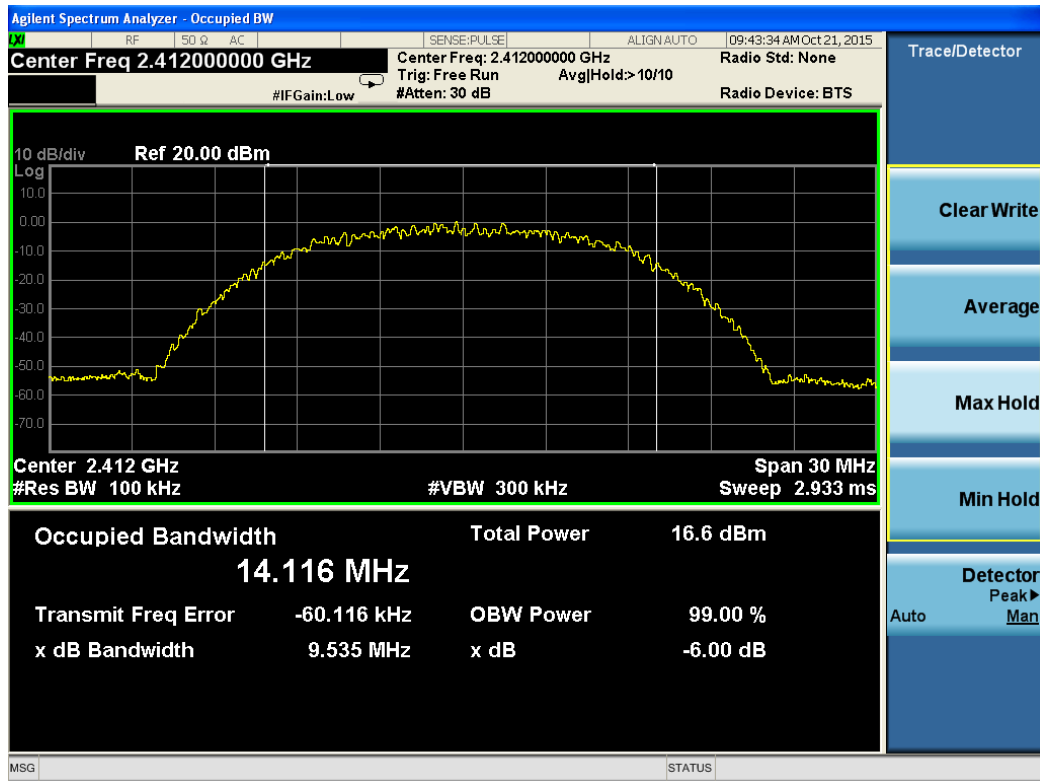



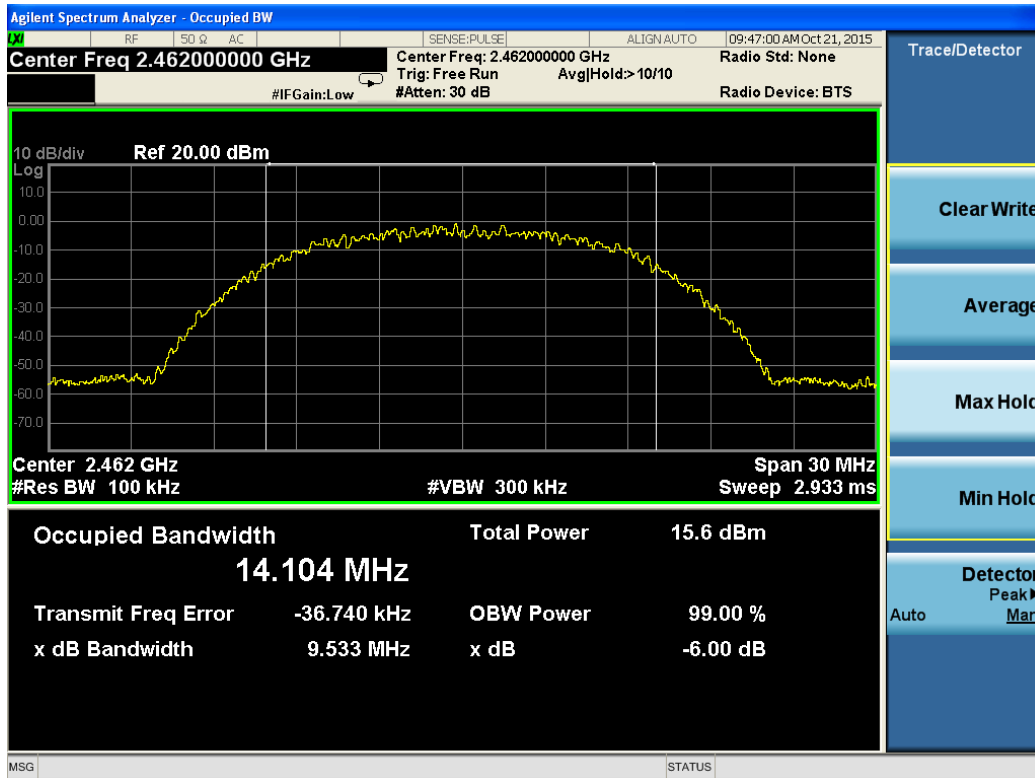

802.11g channel, 6dB bandwidth

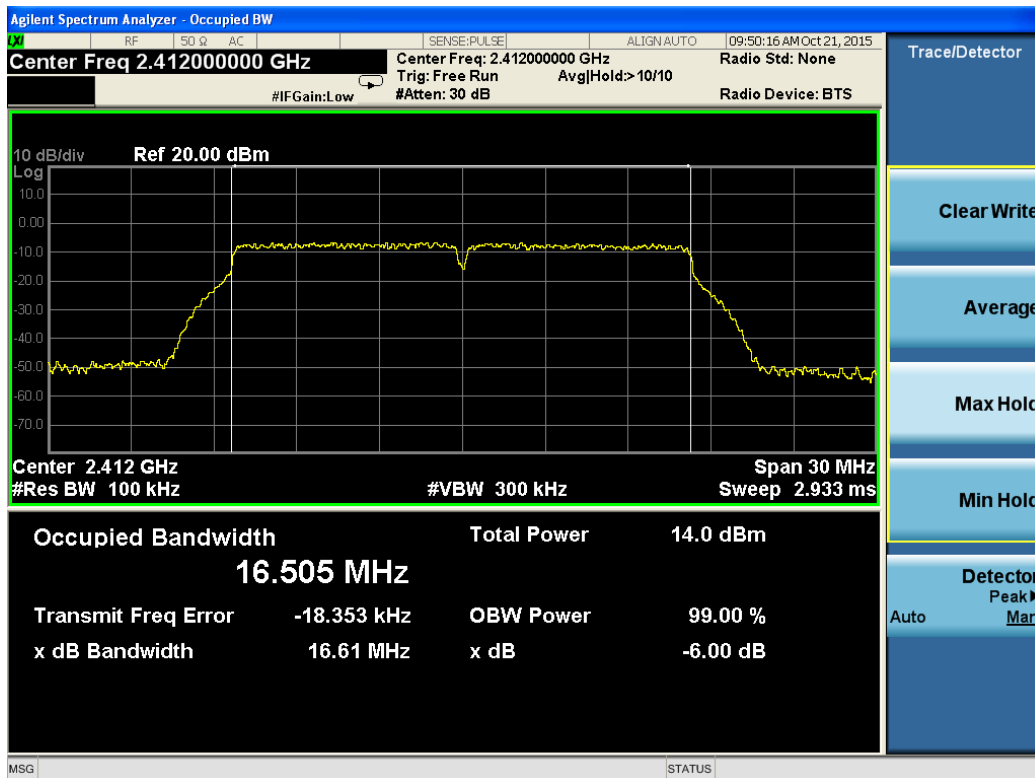

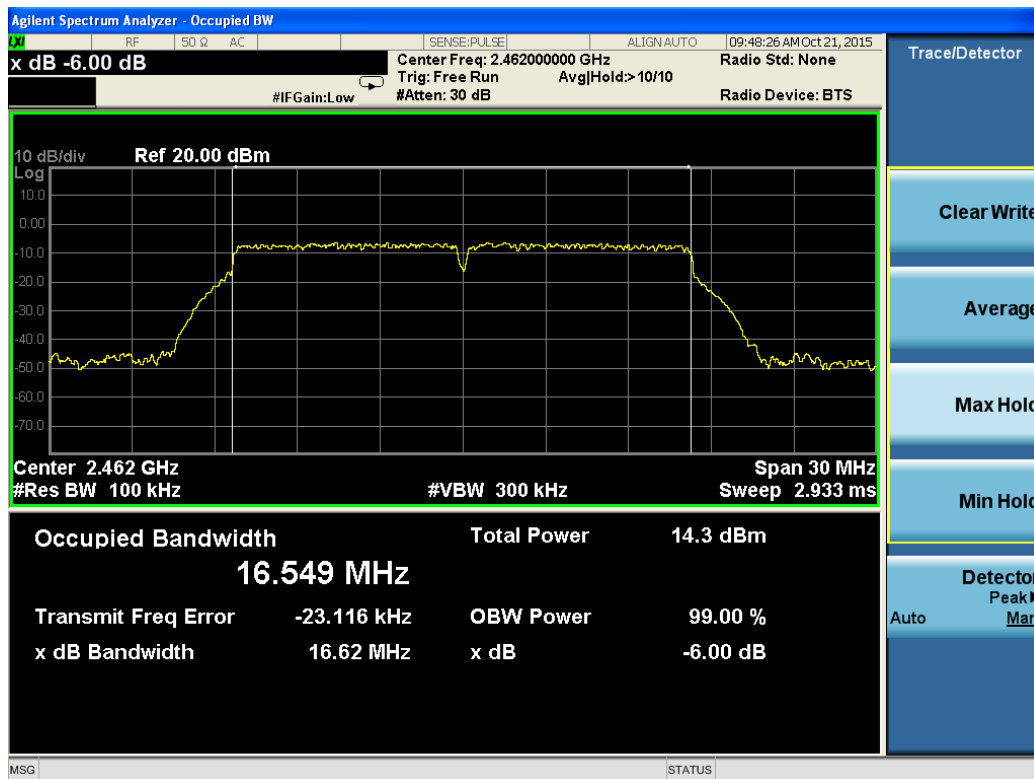
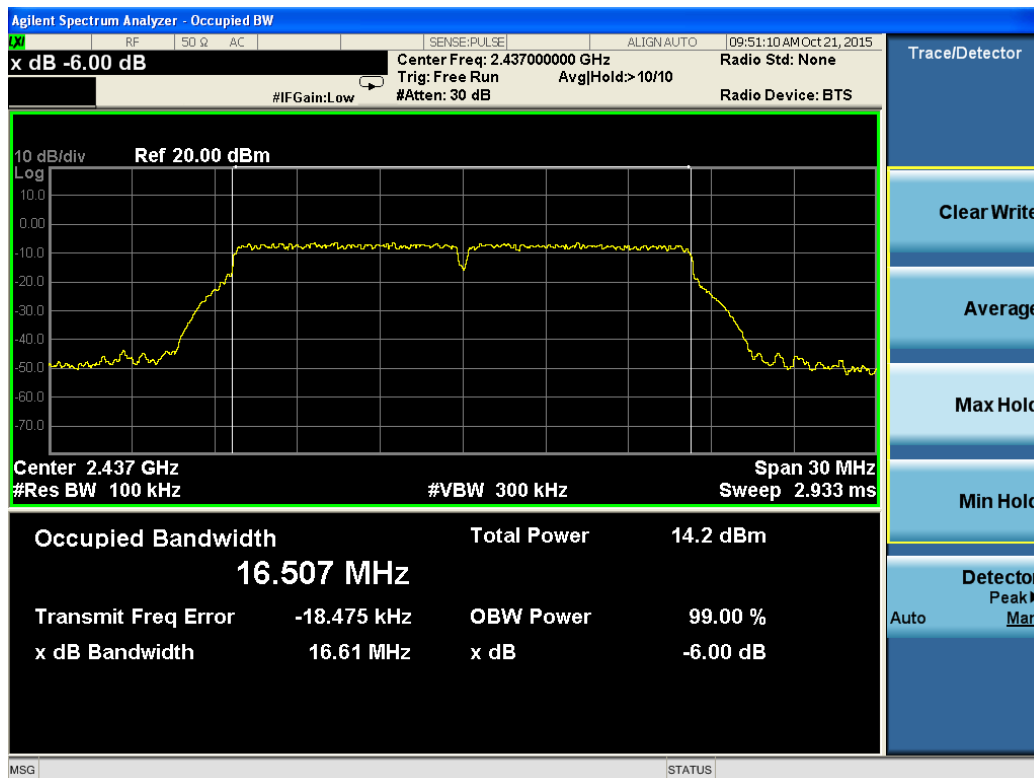

802.11n HT20 channel, 6dB bandwidth

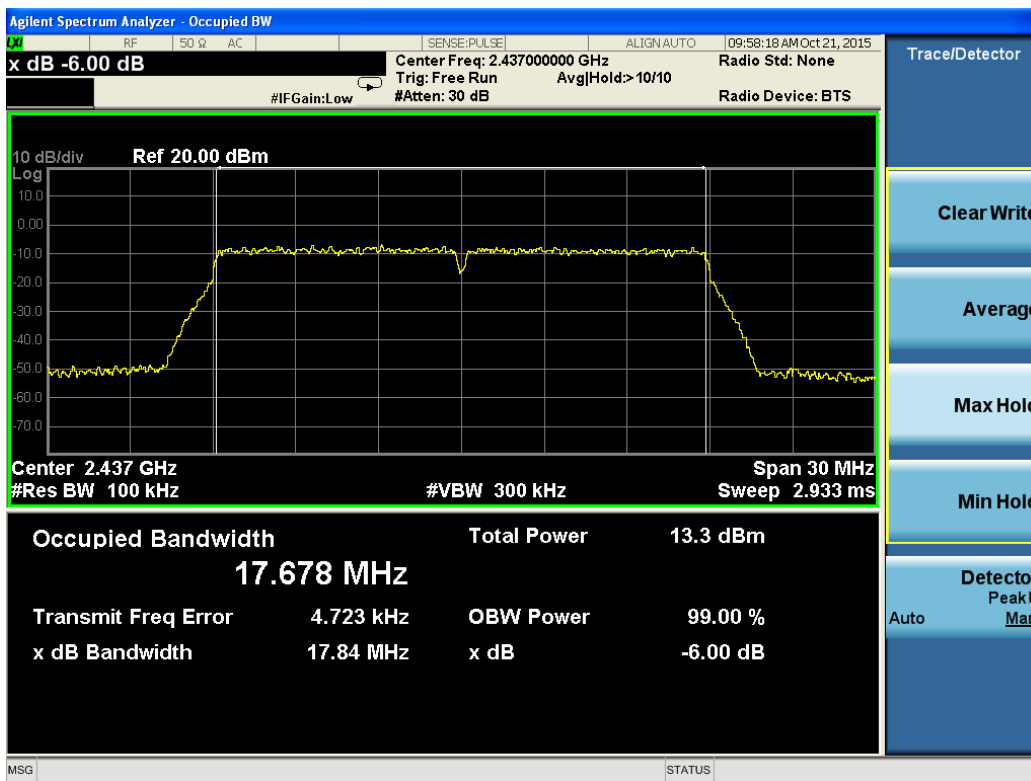
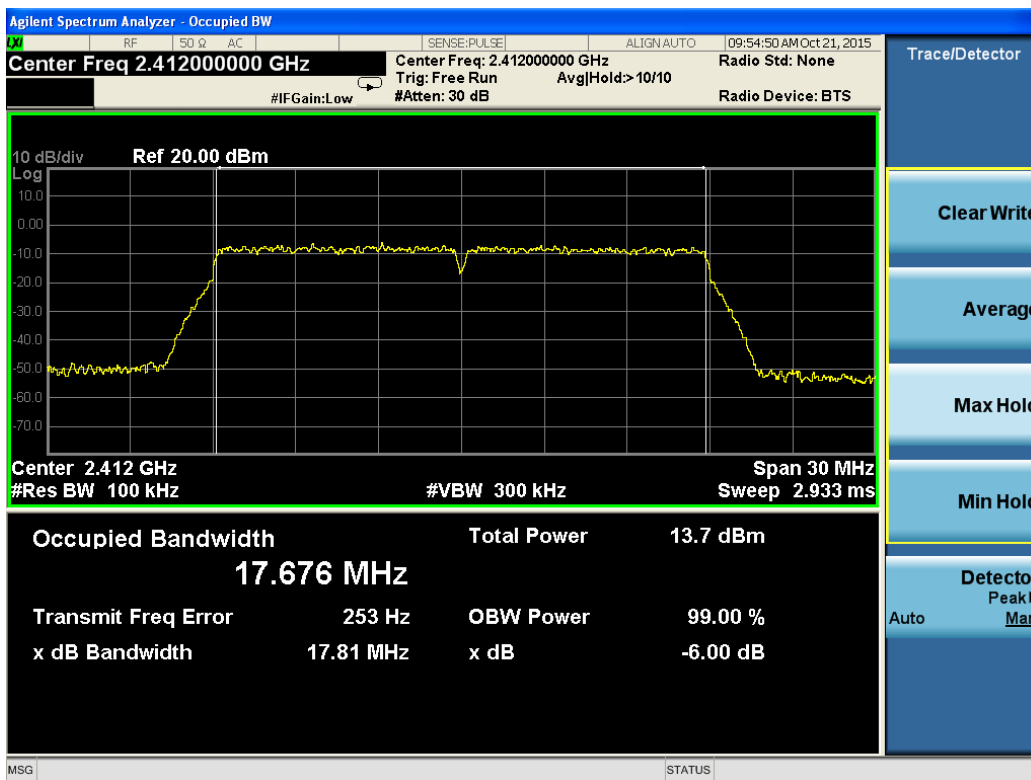

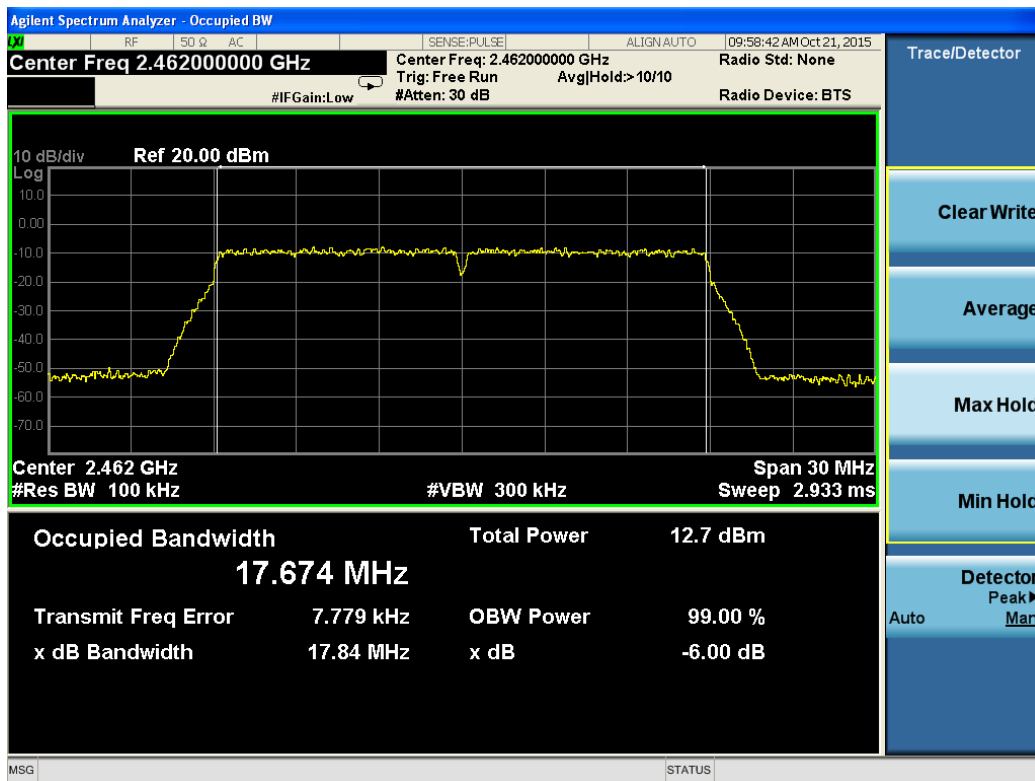

802.11n HT40 channel, 6dB bandwidth

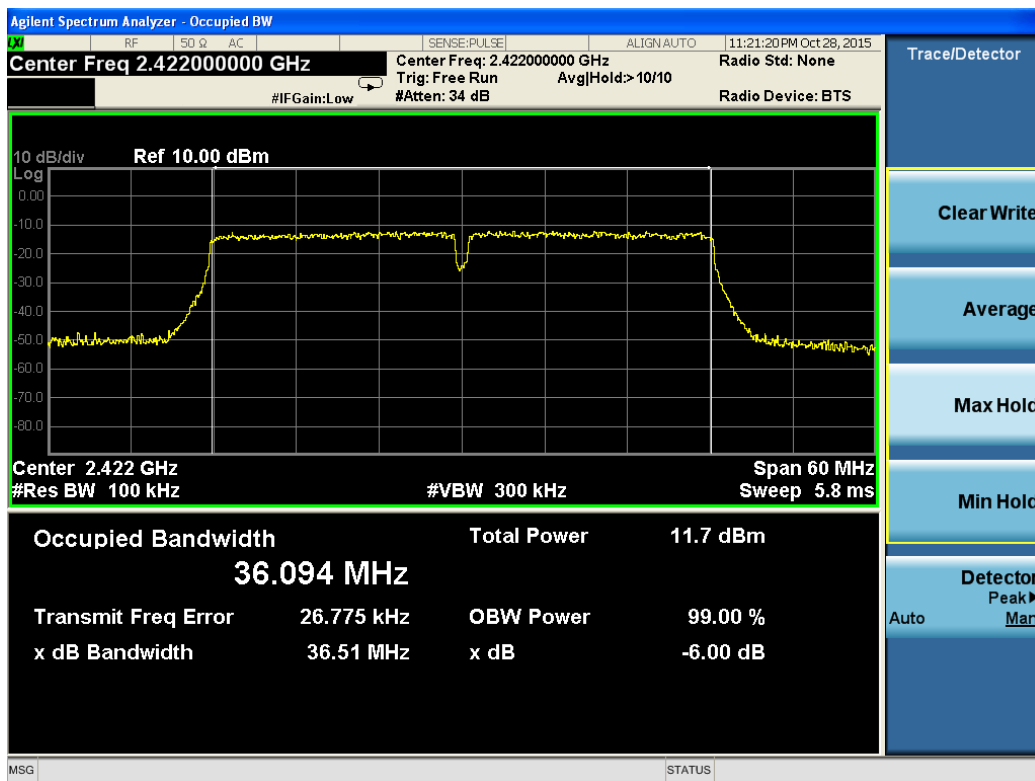

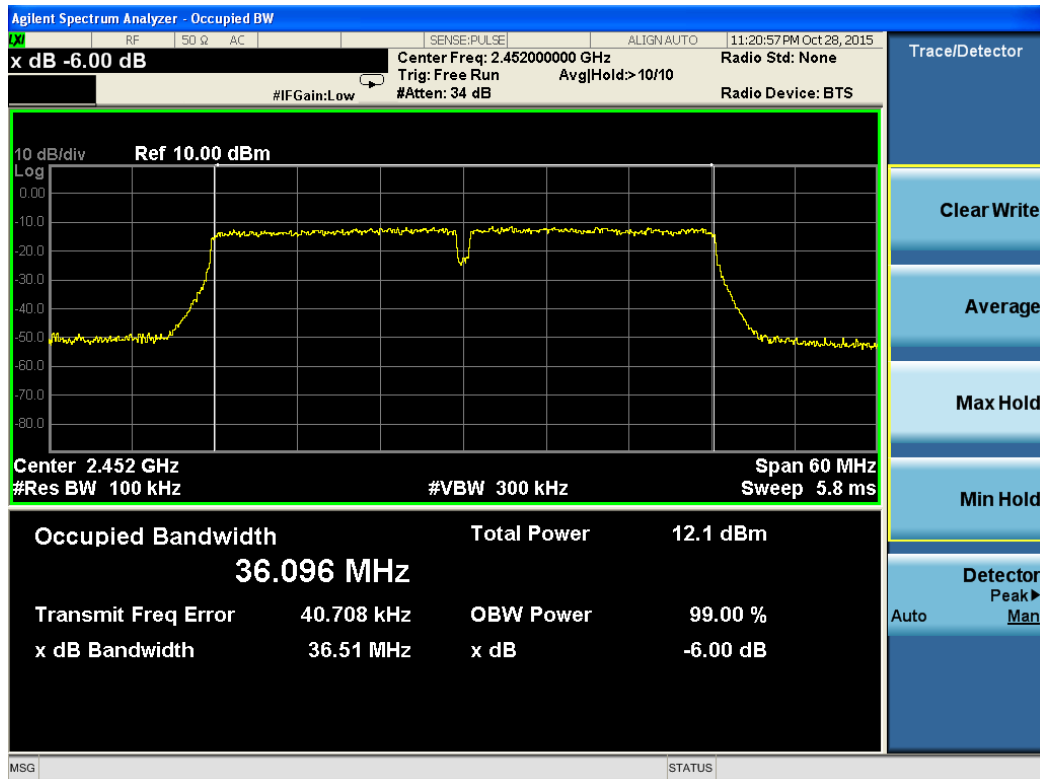
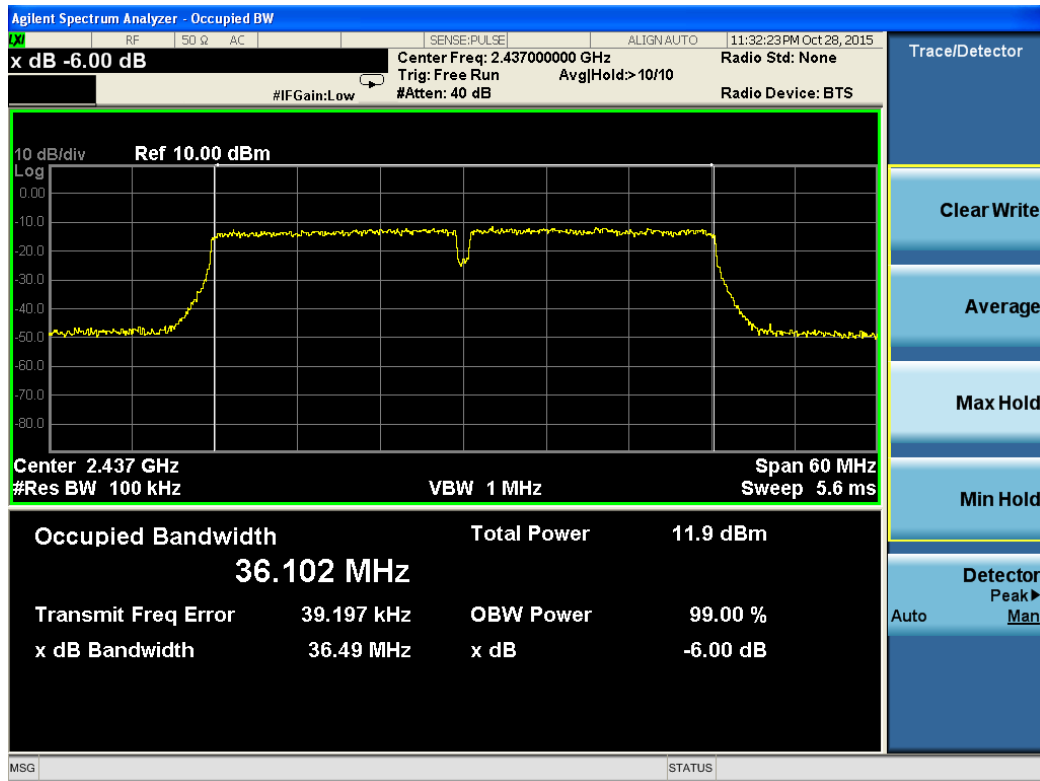

## 6.4. Radiated Emissions Measurement

### 6.4.1. Standard Applicable

According to §15.247 (d): 20dBc in any 100 kHz bandwidth outside the operating frequency band. In case the emission fall within the restricted band specified on 15.205(a), then the 15.209(a) limit in the table below has to be followed.

Frequencies(MHz)	Field Strength(microvolts/meter)	Measurement Distance(meters)
0.009~0.490	2400/F(KHz)	300
0.490~1.705	24000/F(KHz)	30
1.705~30.0	30	30
30~88	100	3
88~216	150	3
216~960	200	3
Above 960	500	3

### 6.4.2. Measuring Instruments and Setting

Please refer to section 6 of equipments list in this report. The following table is the setting of spectrum analyzer and receiver.

Spectrum Parameter	Setting
Attenuation	Auto
Start Frequency	1000 MHz
Stop Frequency	10th carrier harmonic
RB / VB (Emission in restricted band)	1MHz / 1MHz for Peak, 1 MHz / 10Hz for Average
RB / VB (Emission in non-restricted band)	1MHz / 1MHz for Peak, 1 MHz / 10Hz for Average

Receiver Parameter	Setting
Attenuation	Auto
Start ~ Stop Frequency	9kHz~150kHz / RB 200Hz for QP
Start ~ Stop Frequency	150kHz~30MHz / RB 9kHz for QP
Start ~ Stop Frequency	30MHz~1000MHz / RB 100kHz for QP

### 6.4.3. Test Procedures

1. Configure the EUT according to ANSI C63.10. The EUT was placed on the top of the turntable 0.8 meter above ground for below 1GHz, 1.5 meter above ground for above 1GHz and ground with absorber material. The phase center of the receiving antenna mounted on the top of a height-variable antenna tower was placed 3 meters far away from the turntable.
2. Power on the EUT and all the supporting units. The turntable was rotated by 360 degrees to determine the position of the highest radiation.
3. The height of the broadband receiving antenna was varied between one meter and four meters above ground to find the maximum emissions field strength of both horizontal and vertical polarization.

4. For each suspected emissions, the antenna tower was scan (from 1 m to 4 m) and then the turntable was rotated (from 0 degree to 360 degrees) to find the maximum reading
5. Set the test-receiver system to Peak or CISPR quasi-peak Detect Function with specified bandwidth under Maximum Hold Mode.
6. For emissions above 1GHz, use 1MHz VBW and RBW for peak reading. Then 1MHz RBW and 10Hz VBW for average reading in spectrum analyzer.
7. When the radiated emissions limits are expressed in terms of the average value of the emissions, and pulsed operation is employed, the measurement field strength shall be determined by averaging over one complete pulse train, including blanking intervals, as long as the pulse train does not exceed 0.1 seconds. As an alternative (provided the transmitter operates for longer than 0.1 seconds) or in cases where the pulse train exceeds 0.1 seconds, the measured field strength shall be determined from the average absolute voltage during a 0.1 second interval during which the field strength is at its maximum value.
8. If the emissions level of the EUT in peak mode was 3 dB lower than the average limit specified, then testing will be stopped and peak values of EUT will be reported, otherwise, the emissions which do not have 3 dB margin will be repeated one by one using the quasi-peak method for below 1GHz.
9. For testing above 1GHz, the emissions level of the EUT in peak mode was lower than average limit (that means the emissions level in peak mode also complies with the limit in average mode), then testing will be stopped and peak values of EUT will be reported, otherwise, the emissions will be measured in average mode again and reported.
10. In case the emission is lower than 30MHz, loop antenna has to be used for measurement and the recorded data should be QP measured by receiver. High – Low scan is not required in this case.

#### 6.4.4. Test Setup Layout

For radiated emissions below 30MHz

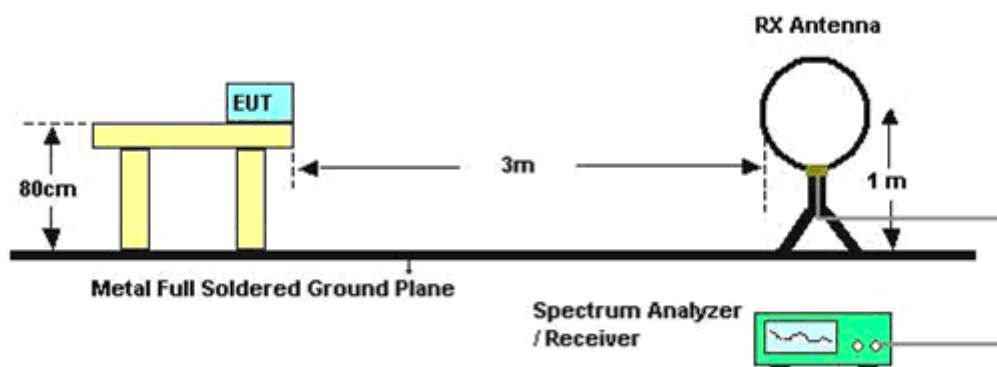

For radiated emissions above 30MHz

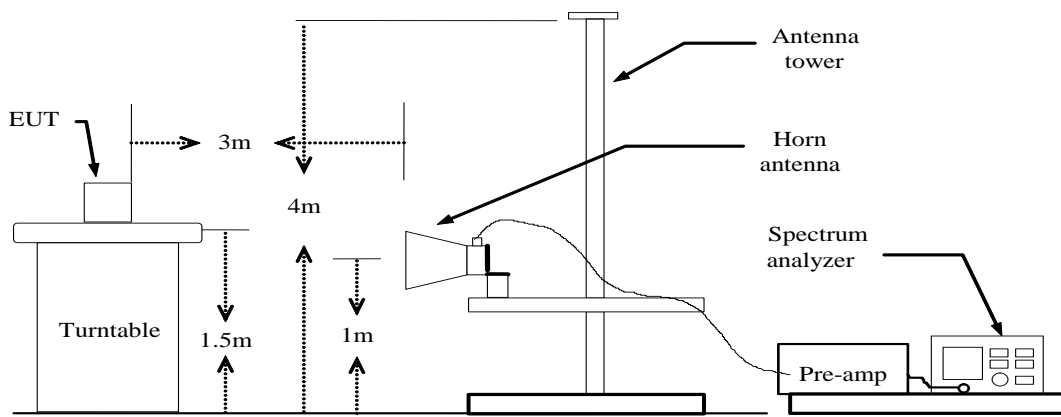
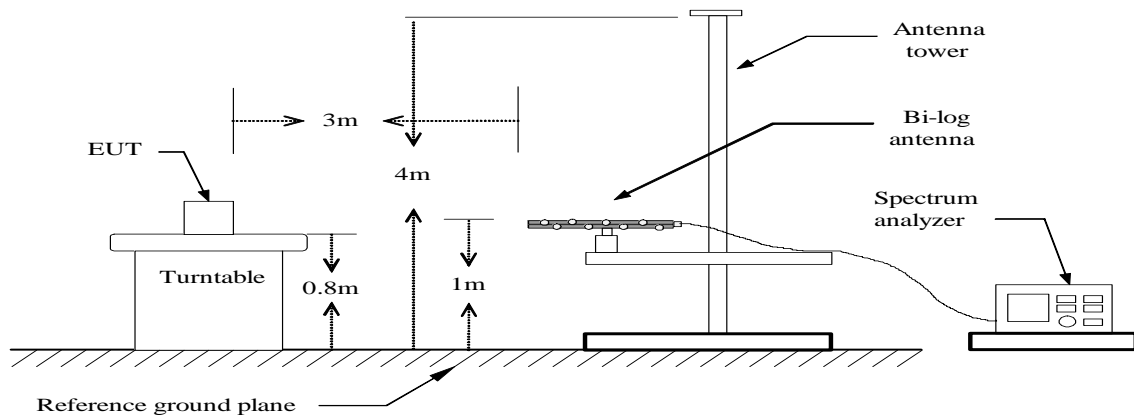

Above 10 GHz shall be extrapolated to the specified distance using an extrapolation factor of 20 dB/decade from 3m to 1.5m.

Distance extrapolation factor =  $20 \log (\text{specific distance [3m]} / \text{test distance [1.5m]})$  (dB);

Limit line = specific limits (dBuV) + distance extrapolation factor [6 dB].

#### 6.4.5. EUT Operation during Test

The EUT was programmed to be in continuously transmitting mode.



6.4.6. Results of Radiated Emissions (9kHz~30MHz)

Temperature	25°C	Humidity	60%
Test Engineer	Dick	Configurations	802.11b/g/n

Freq. (MHz)	Level (dBUV)	Over Limit (dB)	Over Limit (dBUV)	Remark
-	-	-	-	See Note

Note:

The amplitude of spurious emissions which are attenuated by more than 20 dB below the permissible value has no need to be reported.

Distance extrapolation factor = 40 log (specific distance / test distance) (dB);

Limit line = specific limits (dBUV) + distance extrapolation factor.

6.4.7. Results of Radiated Emissions (30MHz~1GHz)

Temperature	25°C	Humidity	60%
Test Engineer	Dick	Configurations	802.11b (High CH)

Test result for 802.11b (High Channel)

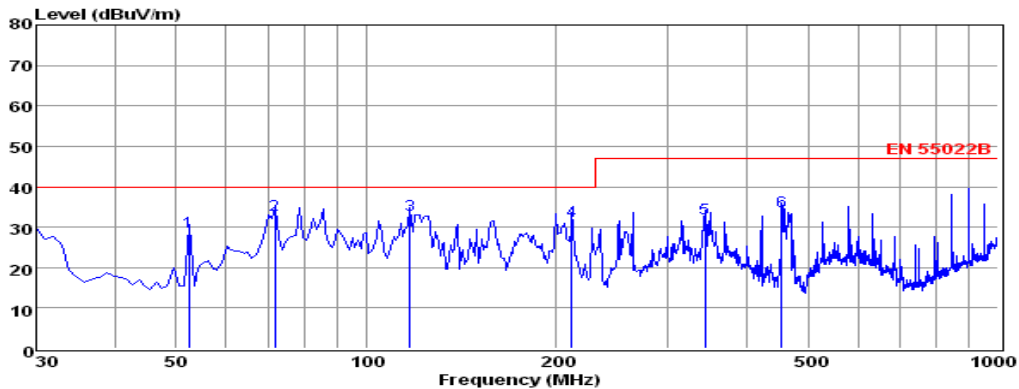

```

Env./Ins:          24°C/56%
EUT:              Wi-Fi Tablet
M/N:              T7
Power Rating:     AC 120V/60Hz
Test Mode:        TX-High Channel
Operator:         Dick
Memo:
pol:              HORIZONTAL
    
```

	Freq MHz	Reading dBUV	CabLos dB	Antfac dB/m	Measured dBUV/m	Limit dBUV/m	Over dB	Remark
1	52.31	15.17	0.46	13.14	28.77	40.00	-11.23	QP
2	71.71	23.96	0.55	8.36	32.87	40.00	-7.13	QP
3	117.30	21.29	0.68	10.96	32.93	40.00	-7.07	QP
4	211.39	19.79	0.93	10.93	31.65	40.00	-8.35	QP
5	343.31	16.96	1.12	14.17	32.25	47.00	-14.75	QP
6	454.86	17.06	1.39	15.58	34.03	47.00	-12.97	QP

Note: 1. All readings are Quasi-peak values.  
 2. Measured= Reading + Antenna Factor + Cable Loss  
 3. The emission that are 20db below the official limit are not reported

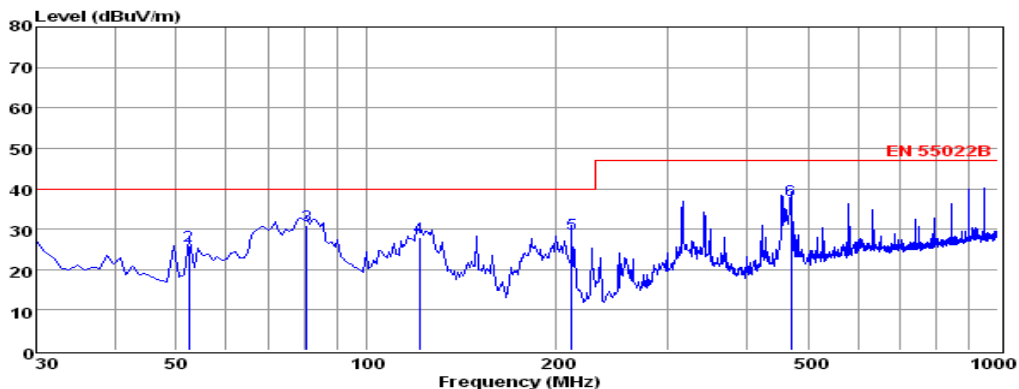

Env./Ins: 24°C/56%  
 EUT: Wi-Fi Tablet  
 M/N: T7  
 Power Rating: AC 120V/60Hz  
 Test Mode: TX-High Channel  
 Operator: Dick  
 Memo:  
 pol: VERTICAL

	Freq	Reading	CabLos	Antfac	Measured	Limit	Over	Remark
	MHz	dBuV	dB	dB/m	dBuV/m	dBuV/m	dB	
1	30.00	12.69	0.39	12.33	25.41	40.00	-14.59	QP
2	52.31	12.20	0.46	13.14	25.80	40.00	-14.20	QP
3	80.44	21.61	0.65	8.70	30.96	40.00	-9.04	QP
4	121.18	17.10	0.70	10.30	28.10	40.00	-11.90	QP
5	211.39	16.92	0.93	10.93	28.78	40.00	-11.22	QP
6	470.38	20.06	1.38	15.84	37.28	47.00	-9.72	QP

Note: 1. All readings are Quasi-peak values.  
 2. Measured= Reading + Antenna Factor + Cable Loss  
 3. The emission that ate 20db blow the official limit are not reported

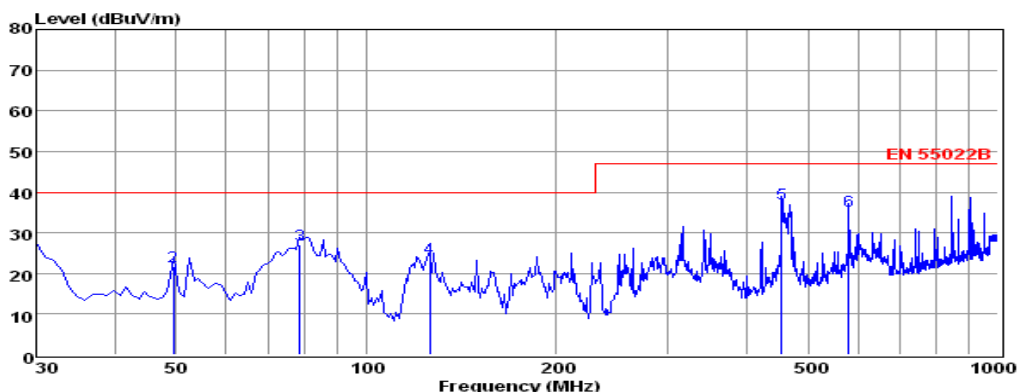

Env./Ins: 24°C/56%  
 EUT: Wi-Fi Tablet  
 M/N: T7  
 Power Rating: AC 240V/60Hz  
 Test Mode: TX-High Channel  
 Operator: Dick  
 Memo:  
 pol: HORIZONTAL

	Freq	Reading	CabLos	Antfac	Measured	Limit	Over	Remark
	MHz	dBuV	dB	dB/m	dBuV/m	dBuV/m	dB	
1	30.00	12.97	0.39	12.33	25.69	40.00	-14.31	QP
2	49.40	8.00	0.54	13.29	21.83	40.00	-18.17	QP
3	78.50	18.15	0.47	8.32	26.94	40.00	-13.06	QP
4	126.03	13.42	0.71	9.55	23.68	40.00	-16.32	QP
5	454.86	20.06	1.39	15.58	37.03	47.00	-9.97	QP
6	580.96	15.63	1.54	18.09	35.26	47.00	-11.74	QP

Note: 1. All readings are Quasi-peak values.  
 2. Measured= Reading + Antenna Factor + Cable Loss  
 3. The emission that ate 20db blow the official limit are not reported

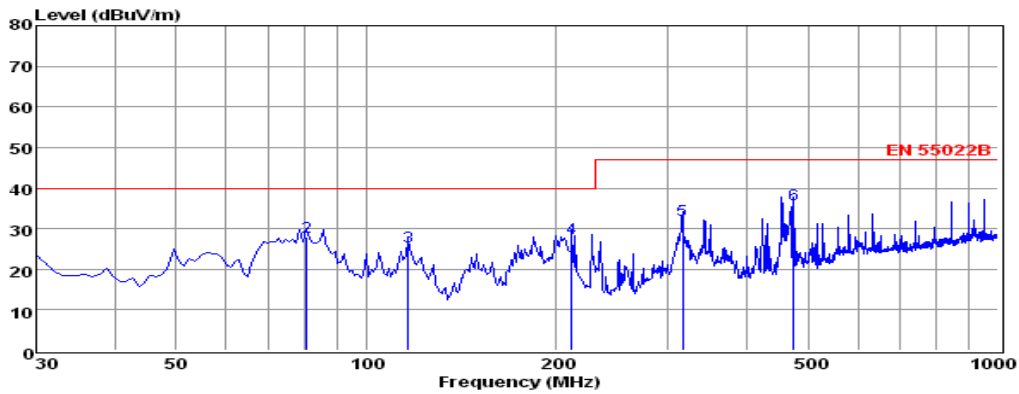

Env./Ins: 24°C/56%  
 EUT: Wi-Fi Tablet  
 M/N: T7  
 Power Rating: AC 240V/60Hz  
 Test Mode: TX-High Channel  
 Operator: Dick  
 Memo:  
 pol: VERTICAL

	Freq	Reading	CabLos	Antfac	Measured	Limit	Over	Remark
	MHz	dBuV	dB	dB/m	dBuV/m	dBuV/m	dB	
1	30.00	8.79	0.39	12.33	21.51	40.00	-18.49	QP
2	80.44	18.62	0.65	8.70	27.97	40.00	-12.03	QP
3	116.33	13.72	0.68	11.13	25.53	40.00	-14.47	QP
4	211.39	15.75	0.93	10.93	27.61	40.00	-12.39	QP
5	317.12	17.82	1.01	13.29	32.12	47.00	-14.88	QP
6	475.23	18.60	1.33	15.96	35.89	47.00	-11.11	QP

Note: 1. All readings are Quasi-peak values.  
 2. Measured= Reading + Antenna Factor + Cable Loss  
 3. The emission that are 20db below the official limit are not reported

Note:

Pre-scan all mode and recorded the worst case results in this report (802.11b (High Channel)).

Emission level (dBuV/m) = 20 log Emission level (uV/m).

Corrected Reading: Antenna Factor + Cable Loss + Read Level - Preamp Factor = Level.

## 6.4.8. Results for Radiated Emissions (Above 1GHz) 802.11b

## Channel 1

Freq. MHz	Reading dBuv	Ant. Fac. dB/m	Pre. Fac. dB	Cab. Loss dB	Measured dBuv/m	Limit dBuv/m	Margin dB	Remark	Pol.
4824.00	52.06	33.06	35.04	3.94	54.02	74	-19.98	Peak	Horizontal
4824.00	39.64	33.06	35.04	3.94	41.60	54	-12.40	Average	Horizontal
4824.00	51.31	33.06	35.04	3.94	53.27	74	-20.73	Peak	Vertical
4824.00	40.79	33.06	35.04	3.94	42.75	54	-11.25	Average	Vertical

## Channel 6

Freq. MHz	Reading dBuv	Ant. Fac. dB/m	Pre. Fac. dB	Cab. Loss dB	Measured dBuv/m	Limit dBuv/m	Margin dB	Remark	Pol.
4874.00	51.94	33.16	35.15	3.96	53.91	74	-20.09	Peak	Horizontal
4874.00	42.12	33.16	35.15	3.96	44.09	54	-9.91	Average	Horizontal
4874.00	53.54	33.16	35.15	3.96	55.51	74	-18.49	Peak	Vertical
4874.00	46.64	33.16	35.15	3.96	48.61	54	-5.39	Average	Vertical

## Channel 11

Freq. MHz	Reading dBuv	Ant. Fac. dB/m	Pre. Fac. dB	Cab. Loss dB	Measured dBuv/m	Limit dBuv/m	Margin dB	Remark	Pol.
4924.00	54.65	33.26	35.14	3.98	56.75	74	-17.25	Peak	Horizontal
4924.00	40.67	33.26	35.14	3.98	42.77	54	-11.23	Average	Horizontal
4924.00	54.19	33.26	35.14	3.98	56.29	74	-17.71	Peak	Vertical
4924.00	41.21	33.26	35.14	3.98	43.31	54	-10.69	Average	Vertical

802.11g

Channel 1

Freq. MHz	Reading dBuv	Ant. Fac. dB/m	Pre. Fac. dB	Cab. Loss dB	Measured dBuv/m	Limit dBuv/m	Margin dB	Remark	Pol.
4824.00	51.78	33.06	35.04	3.94	53.74	74	-20.26	Peak	Horizontal
4824.00	38.86	33.06	35.04	3.94	40.82	54	-13.18	Average	Horizontal
4824.00	54.56	33.06	35.04	3.94	56.52	74	-17.48	Peak	Vertical
4824.00	39.42	33.06	35.04	3.94	41.38	54	-12.62	Average	Vertical

Channel 6

Freq. MHz	Reading dBuv	Ant. Fac. dB/m	Pre. Fac. dB	Cab. Loss dB	Measured dBuv/m	Limit dBuv/m	Margin dB	Remark	Pol.
4874.00	55.17	33.16	35.15	3.96	57.14	74	-16.86	Peak	Horizontal
4874.00	40.88	33.16	35.15	3.96	42.85	54	-11.15	Average	Horizontal
4874.00	49.93	33.16	35.15	3.96	51.90	74	-22.10	Peak	Vertical
4874.00	39.44	33.16	35.15	3.96	41.41	54	-12.59	Average	Vertical

Channel 11

Freq. MHz	Reading dBuv	Ant. Fac. dB/m	Pre. Fac. dB	Cab. Loss dB	Measured dBuv/m	Limit dBuv/m	Margin dB	Remark	Pol.
4924.00	55.65	33.26	35.14	3.98	57.75	74	-16.25	Peak	Horizontal
4924.00	35.17	33.26	35.14	3.98	37.27	54	-16.73	Average	Horizontal
4924.00	51.54	33.26	35.14	3.98	53.64	74	-20.36	Peak	Vertical
4924.00	38.68	33.26	35.14	3.98	40.78	54	-13.22	Average	Vertical

## 802.11n HT20

## Channel 1

Freq. MHz	Reading dBuv	Ant. Fac. dB/m	Pre. Fac. dB	Cab. Loss dB	Measured dBuv/m	Limit dBuv/m	Margin dB	Remark	Pol.
4824.00	52.93	33.06	35.04	3.94	54.89	74	-19.11	Peak	Horizontal
4824.00	38.42	33.06	35.04	3.94	40.38	54	-13.62	Average	Horizontal
4824.00	51.26	33.06	35.04	3.94	53.22	74	-20.78	Peak	Vertical
4824.00	41.83	33.06	35.04	3.94	43.79	54	-10.21	Average	Vertical

## Channel 6

Freq. MHz	Reading dBuv	Ant. Fac. dB/m	Pre. Fac. dB	Cab. Loss dB	Measure d dBuv/m	Limit dBuv/m	Margin dB	Remark	Pol.
4874.00	53.17	33.16	35.15	3.96	55.14	74	-18.86	Peak	Horizontal
4874.00	39.34	33.16	35.15	3.96	41.31	54	-12.69	Average	Horizontal
4874.00	53.85	33.16	35.15	3.96	55.82	74	-18.18	Peak	Vertical
4874.00	37.77	33.16	35.15	3.96	39.74	54	-14.26	Average	Vertical

## Channel 11

Freq. MHz	Reading dBuv	Ant. Fac. dB/m	Pre. Fac. dB	Cab. Loss dB	Measured dBuv/m	Limit dBuv/m	Margin dB	Remark	Pol.
4924.00	51.28	33.26	35.14	3.98	53.38	74	-20.62	Peak	Horizontal
4924.00	38.31	33.26	35.14	3.98	40.41	54	-13.59	Average	Horizontal
4924.00	50.80	33.26	35.14	3.98	52.90	74	-21.10	Peak	Vertical
4924.00	37.34	33.26	35.14	3.98	39.44	54	-14.56	Average	Vertical

## 802.11n HT40

## Channel 3

Freq. MHz	Reading dBuV	Ant. Fac. dB/m	Pre. Fac. dB	Cab. Loss dB	Measured dBuV/m	Limit dBuV/m	Margin dB	Remark	Pol.
4844.00	45.39	33.06	35.04	3.94	47.35	74	-26.65	Peak	Horizontal
4844.00	36.03	33.06	35.04	3.94	37.99	54	-16.01	Average	Horizontal
4844.00	45.88	33.06	35.04	3.94	47.84	74	-26.16	Peak	Vertical
4844.00	37.84	33.06	35.04	3.94	39.80	54	-14.20	Average	Vertical

## Channel 6

Freq. MHz	Reading dBuV	Ant. Fac. dB/m	Pre. Fac. dB	Cab. Loss dB	Measured dBuV/m	Limit dBuV/m	Margin dB	Remark	Pol.
4874.00	47.32	33.16	35.15	3.96	49.29	74	-24.71	Peak	Horizontal
4874.00	38.45	33.16	35.15	3.96	40.42	54	-13.58	Average	Horizontal
4874.00	48.24	33.16	35.15	3.96	50.21	74	-23.79	Peak	Vertical
4874.00	36.62	33.16	35.15	3.96	38.59	54	-15.41	Average	Vertical

## Channel 9

Freq. MHz	Reading dBuV	Ant. Fac. dB/m	Pre. Fac. dB	Cab. Loss dB	Measured dBuV/m	Limit dBuV/m	Margin dB	Remark	Pol.
4904.00	43.41	33.26	35.14	48.20	45.51	74	-28.49	Peak	Horizontal
4904.00	38.36	33.26	35.14	40.06	40.46	54	-13.54	Average	Horizontal
4904.00	45.45	33.26	35.14	48.22	47.55	74	-26.45	Peak	Vertical
4904.00	37.19	33.26	35.14	37.33	39.29	54	-14.71	Average	Vertical

**Notes:**

1. Measuring frequencies from 9k~10th harmonic or 26.5GHz (which is less), No emission found between lowest internal used/generated frequency to 30MHz.
2. Radiated emissions measured in frequency range from 9k~10th harmonic or 40GHz (which is less) were made with an instrument using Peak detector mode.
3. Data of measurement within this frequency range shown " --- " in the table above means the reading of emissions are attenuated more than 20dB below the permissible limits or the field strength is too small to be measured.

6.4.9. Results of Band Edges Test (Radiated)

802.11b

Tx-2412

Freq. MHz	Reading Level dBuV	Ant. Fac. dB/m	Pre. Fac. dB	Cab. Loss dB	Measured dBuV/m	Limit dBuV/m	Margin dB	Remark	Pol.
2390.00	51.82	32.89	35.16	3.51	53.06	74	-20.94	Peak	Horizontal
2390.00	37.50	32.89	35.16	3.51	38.75	54	-15.25	Average	Horizontal
2400.00	55.96	32.92	35.16	3.54	57.26	74	-16.74	Peak	Horizontal
2400.00	40.51	32.92	35.16	3.54	41.81	54	-12.19	Average	Horizontal
2390.00	51.39	32.89	35.16	3.51	52.63	74	-21.37	Peak	Vertical
2390.00	39.10	32.89	35.16	3.51	40.35	54	-13.65	Average	Vertical
2400.00	56.20	32.92	35.16	3.54	57.50	74	-16.50	Peak	Vertical
2400.00	40.88	32.92	35.16	3.54	42.18	54	-11.82	Average	Vertical

Tx-2462

Freq. MHz	Reading Level dBuV	Ant. Fac. dB/m	Pre. Fac. dB	Cab. Loss dB	Measured dBuV/m	Limit dBuV/m	Margin dB	Remark	Pol.
2483.50	56.69	33.06	35.18	3.60	58.17	74	-15.83	Peak	Horizontal
2483.50	39.17	33.06	35.18	3.60	40.65	54	-13.35	Average	Horizontal
2483.50	56.44	33.06	35.18	3.60	57.92	74	-16.08	Peak	Vertical
2483.50	38.60	33.06	35.18	3.60	40.08	54	-13.92	Average	Vertical



802.11g

Tx-2412

Freq. MHz	Reading Level dBuV	Ant. Fac. dB/m	Pre. Fac. dB	Cab. Loss dB	Measured dBuV/m	Limit dBuV/m	Margin dB	Remark	Pol.
2390.00	53.48	32.89	35.16	3.51	54.72	74	-19.28	Peak	Horizontal
2390.00	35.97	32.89	35.16	3.51	37.22	54	-16.78	Average	Horizontal
2400.00	57.50	32.92	35.16	3.54	58.80	74	-15.20	Peak	Horizontal
2400.00	40.52	32.92	35.16	3.54	41.82	54	-12.18	Average	Horizontal
2390.00	51.81	32.89	35.16	3.51	53.05	74	-20.95	Peak	Vertical
2390.00	37.41	32.89	35.16	3.51	38.66	54	-15.34	Average	Vertical
2400.00	55.33	32.92	35.16	3.54	56.63	74	-17.37	Peak	Vertical
2400.00	38.05	32.92	35.16	3.54	39.35	54	-14.65	Average	Vertical

Tx-2462

Freq. MHz	Reading Level dBuV	Ant. Fac. dB/m	Pre. Fac. dB	Cab. Loss dB	Measured dBuV/m	Limit dBuV/m	Margin dB	Remark	Pol.
2483.50	56.75	33.06	35.18	3.60	58.23	74	-15.77	Peak	Horizontal
2483.50	39.40	33.06	35.18	3.60	40.88	54	-13.12	Average	Horizontal
2483.50	55.58	33.06	35.18	3.60	57.06	74	-16.94	Peak	Vertical
2483.50	38.53	33.06	35.18	3.60	40.01	54	-13.99	Average	Vertical

## 802.11n(HT20)

## Tx-2412

Freq. MHz	Reading Level dBuV	Ant. Fac. dB/m	Pre. Fac. dB	Cab. Loss dB	Measured dBuV/m	Limit dBuV/m	Margin dB	Remark	Pol.
2390.00	53.31	32.89	35.16	3.51	54.55	74	-19.45	Peak	Horizontal
2390.00	36.56	32.89	35.16	3.51	37.81	54	-16.19	Average	Horizontal
2400.00	57.19	32.92	35.16	3.54	58.49	74	-15.51	Peak	Horizontal
2400.00	39.66	32.92	35.16	3.54	40.96	54	-13.04	Average	Horizontal
2390.00	52.29	32.89	35.16	3.51	53.53	74	-20.47	Peak	Vertical
2390.00	36.10	32.89	35.16	3.51	37.35	54	-16.65	Average	Vertical
2400.00	53.90	32.92	35.16	3.54	55.20	74	-18.80	Peak	Vertical
2400.00	38.35	32.92	35.16	3.54	39.65	54	-14.35	Average	Vertical

## Tx-2462

Freq. MHz	Reading Level dBuV	Ant. Fac. dB/m	Pre. Fac. dB	Cab. Loss dB	Measured dBuV/m	Limit dBuV/m	Margin dB	Remark	Pol.
2483.50	57.34	33.06	35.18	3.60	58.82	74	-15.18	Peak	Horizontal
2483.50	39.18	33.06	35.18	3.60	40.66	54	-13.34	Average	Horizontal
2483.50	55.07	33.06	35.18	3.60	56.55	74	-17.45	Peak	Vertical
2483.50	38.30	33.06	35.18	3.60	39.78	54	-14.22	Average	Vertical

## 802.11n(HT40)

## Tx-2422

Freq. MHz	Reading Level dBuV	Ant. Fac. dB/m	Pre. Fac. dB	Cab. Loss dB	Measured dBuV/m	Limit dBuV/m	Margin dB	Remark	Pol.
2390.00	52.52	32.89	35.16	3.51	53.76	74	-20.24	Peak	Horizontal
2390.00	35.00	32.89	35.16	3.51	36.25	54	-17.75	Average	Horizontal
2400.00	57.80	32.92	35.16	3.54	59.10	74	-14.90	Peak	Horizontal
2400.00	40.53	32.92	35.16	3.54	41.83	54	-12.17	Average	Horizontal
2390.00	51.07	32.89	35.16	3.51	52.31	74	-21.69	Peak	Vertical
2390.00	36.47	32.89	35.16	3.51	37.72	54	-16.28	Average	Vertical
2400.00	56.90	32.92	35.16	3.54	58.20	74	-15.80	Peak	Vertical
2400.00	38.84	32.92	35.16	3.54	40.14	54	-13.86	Average	Vertical

## Tx-2452

Freq. MHz	Reading Level dBuV	Ant. Fac. dB/m	Pre. Fac. dB	Cab. Loss dB	Measured dBuV/m	Limit dBuV/m	Margin dB	Remark	Pol.
2483.50	56.67	33.06	35.18	3.60	58.15	74	-15.85	Peak	Horizontal
2483.50	39.78	33.06	35.18	3.60	41.26	54	-12.74	Average	Horizontal
2483.50	55.48	33.06	35.18	3.60	56.96	74	-17.04	Peak	Vertical
2483.50	37.98	33.06	35.18	3.60	39.46	54	-14.54	Average	Vertical

## 6.5. Conducted Spurious Emissions and Band Edges Test

### 6.5.1. Standard Applicable

According to §15.247 (d): In any 100 kHz bandwidth outside the frequency band in which the spread spectrum or digitally modulated intentional radiator is operating, the radio frequency power that is produced by the intentional radiator shall be at least 20 dB below that in the 100 kHz bandwidth within the band that contains the highest level of the desired power, based on either an RF conducted or a radiated measurement. Attenuation below the general limits specified in Section 15.209(a) is not required. In addition, radiated emissions which fall in the restricted bands, as defined in Section 15.205(a), must also comply with the radiated emission limits specified in Section 15.209(a) (see Section 15.205(c)).

### 6.5.2. Measuring Instruments and Setting

Please refer to section 6 of equipments list in this report. The following table is the setting of the spectrum analyzer.

Spectrum Parameter	Setting
Detector	Peak
Attenuation	Auto
RB / VB (Emission in restricted band)	100KHz/300KHz
RB / VB (Emission in non-restricted band)	100KHz/300KHz

### 6.5.3. Test Procedures

The transmitter output is connected to a spectrum analyzer. The resolution bandwidth is set to 100 kHz. The video bandwidth is set to 300 kHz

The spectrum from 9kHz to 40GHz is investigated with the transmitter set to the lowest, middle, and highest channels.

Preliminary tests on individual chains. The worst-case configuration was with a combiner, therefore final test were performed with all chains feeding a combiner.

### 6.5.4. Test Setup Layout

This test setup layout is the same as that shown in section 5.4.4.

### 6.5.5. EUT Operation during Test

The EUT was programmed to be in continuously transmitting mode.

6.5.6. Test Results of Conducted Spurious Emissions

802.11b

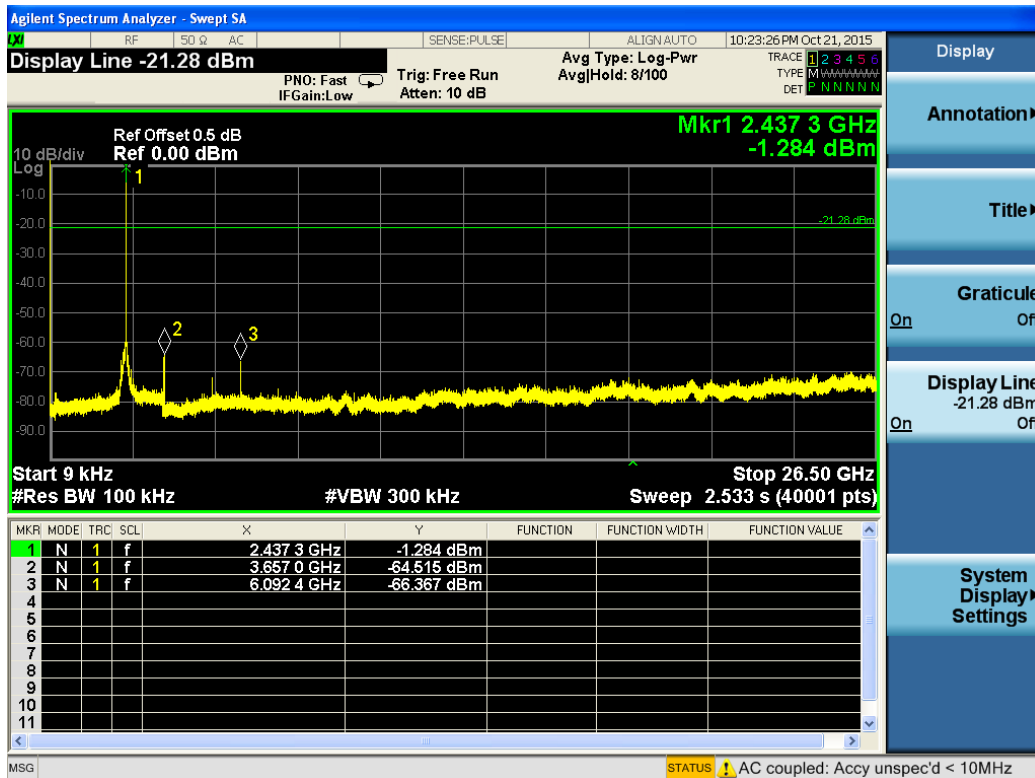
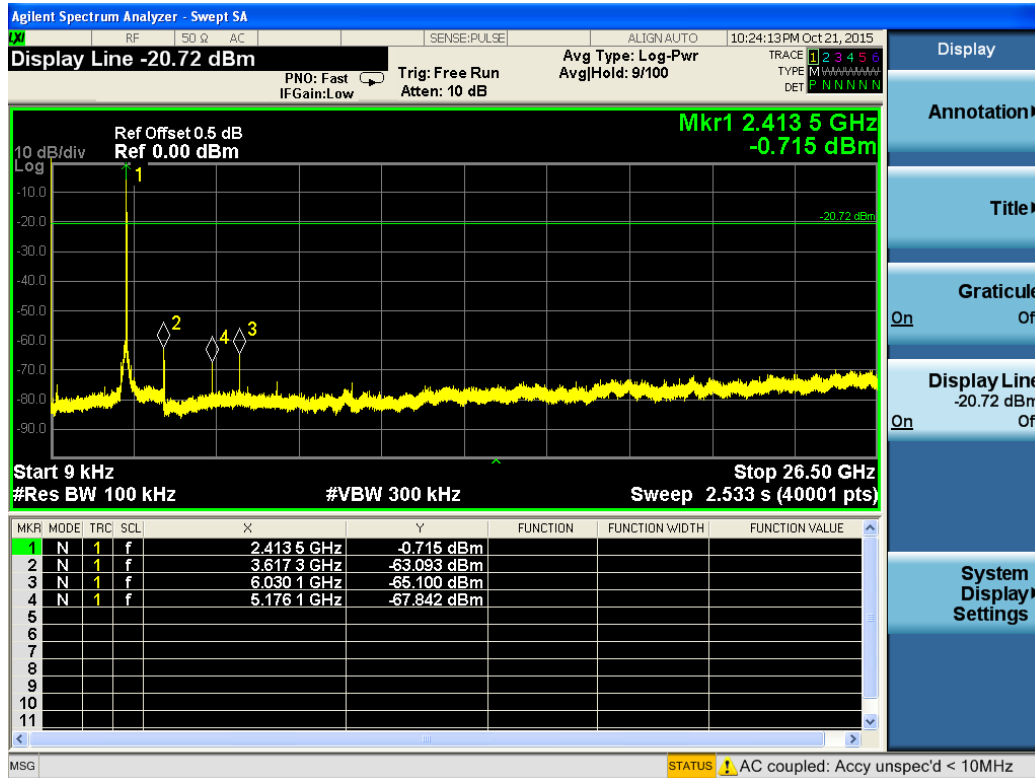

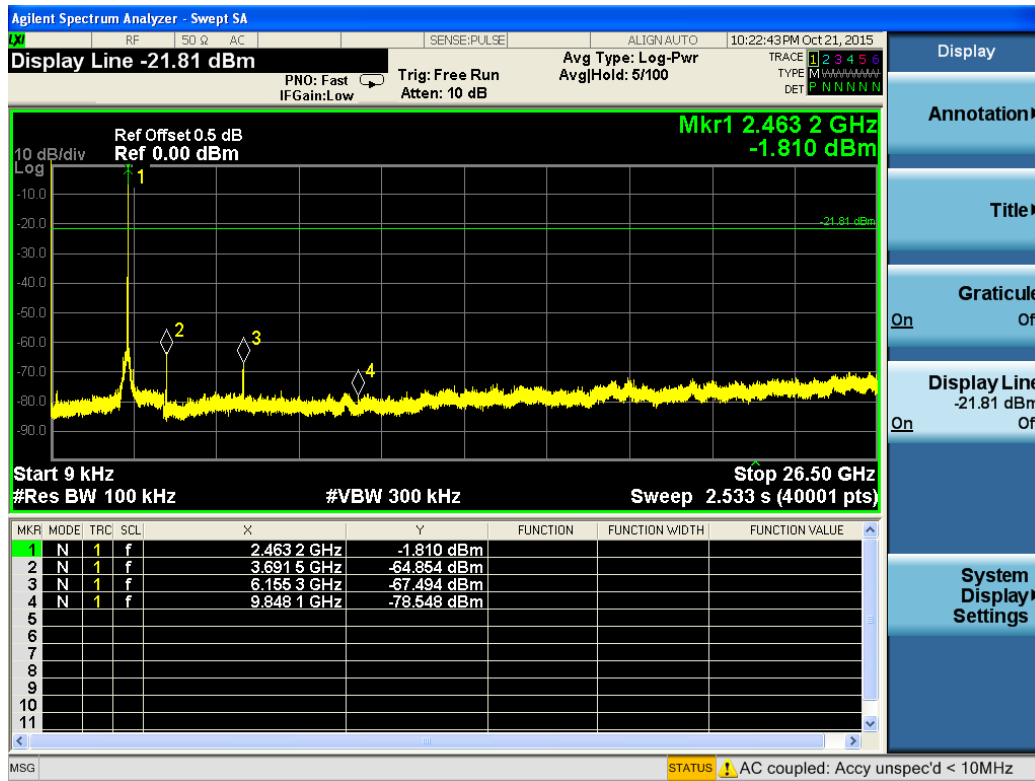

802.11g

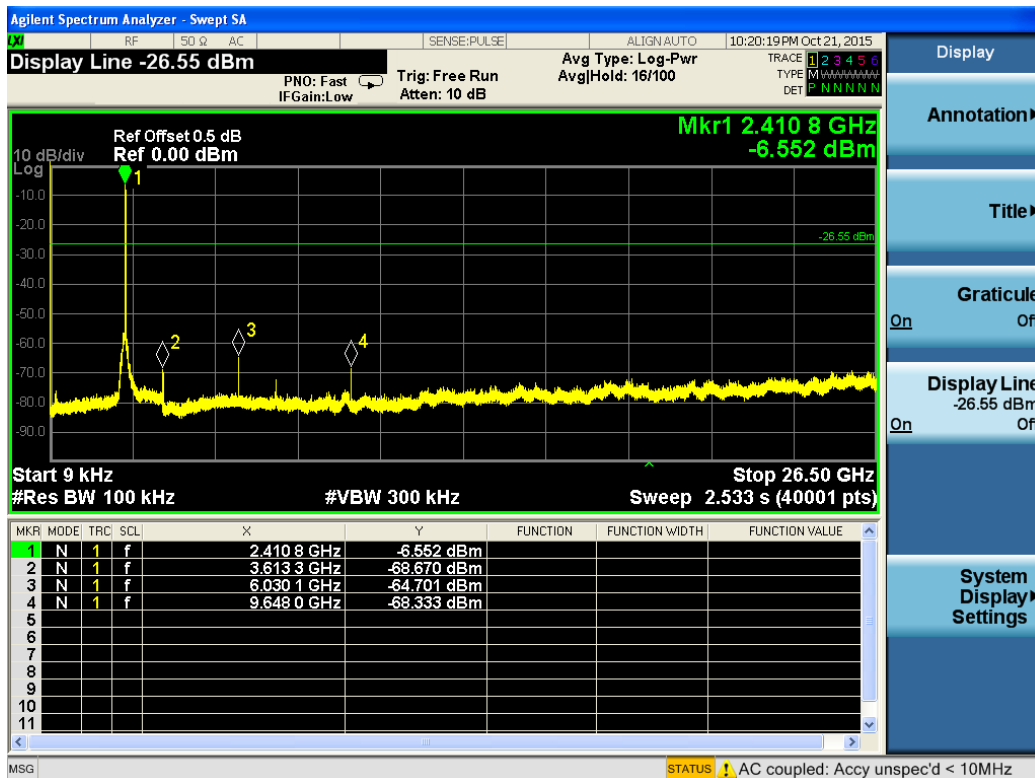

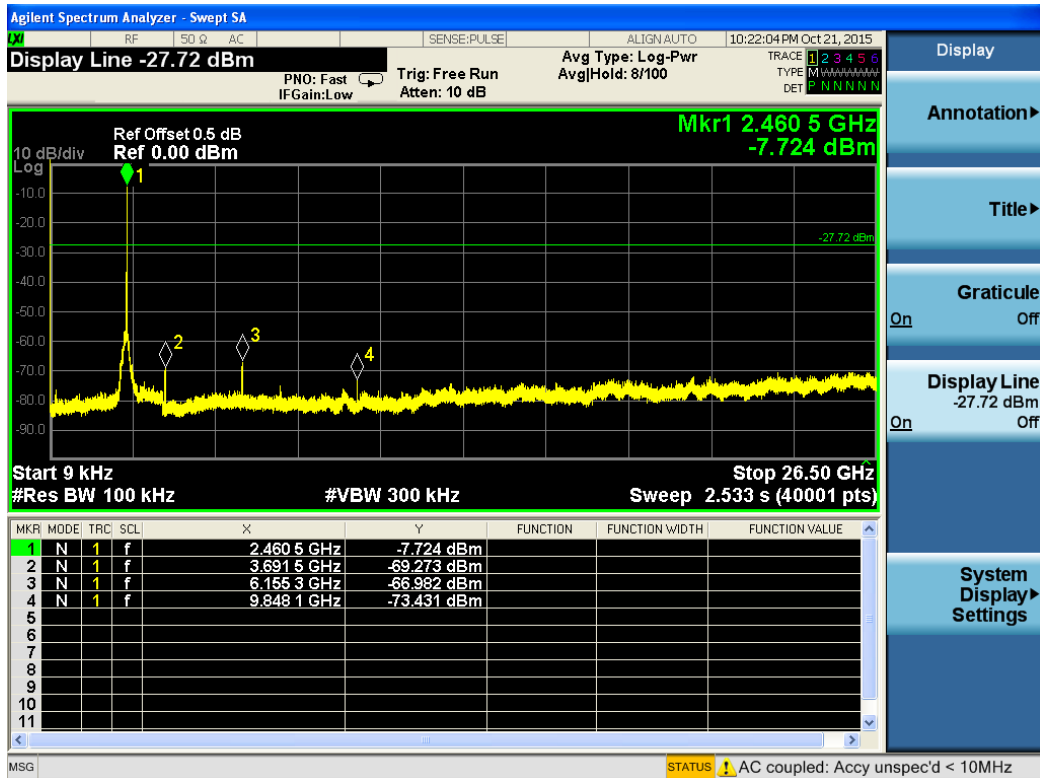
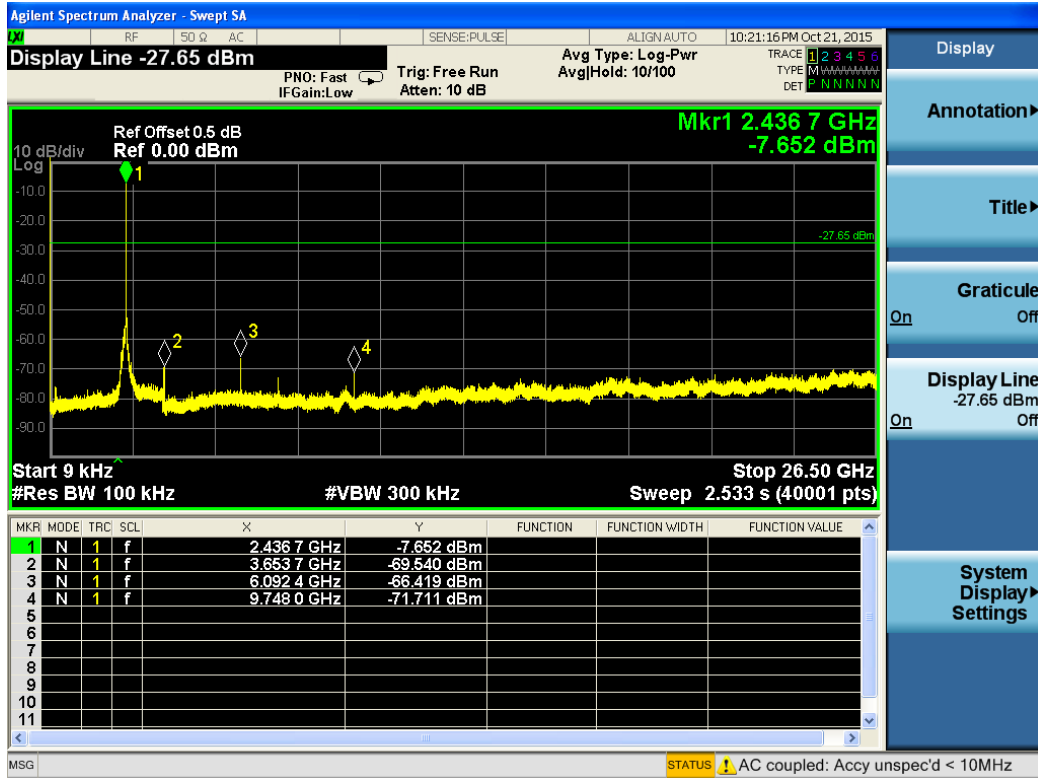

### 802.11n HT20

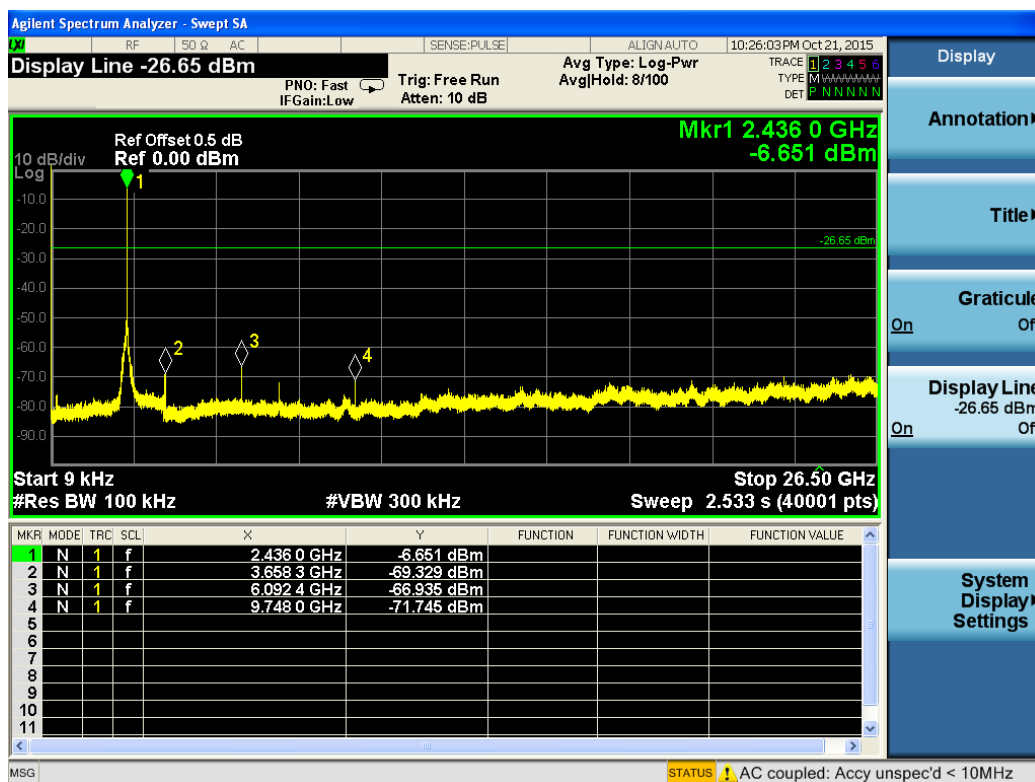
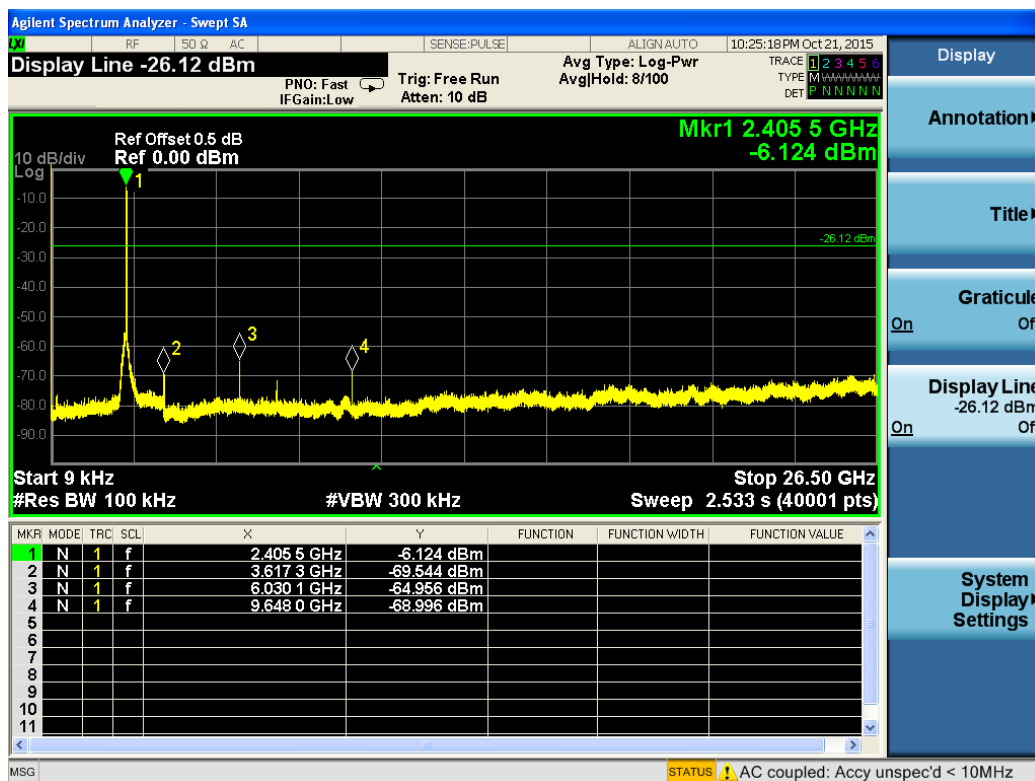



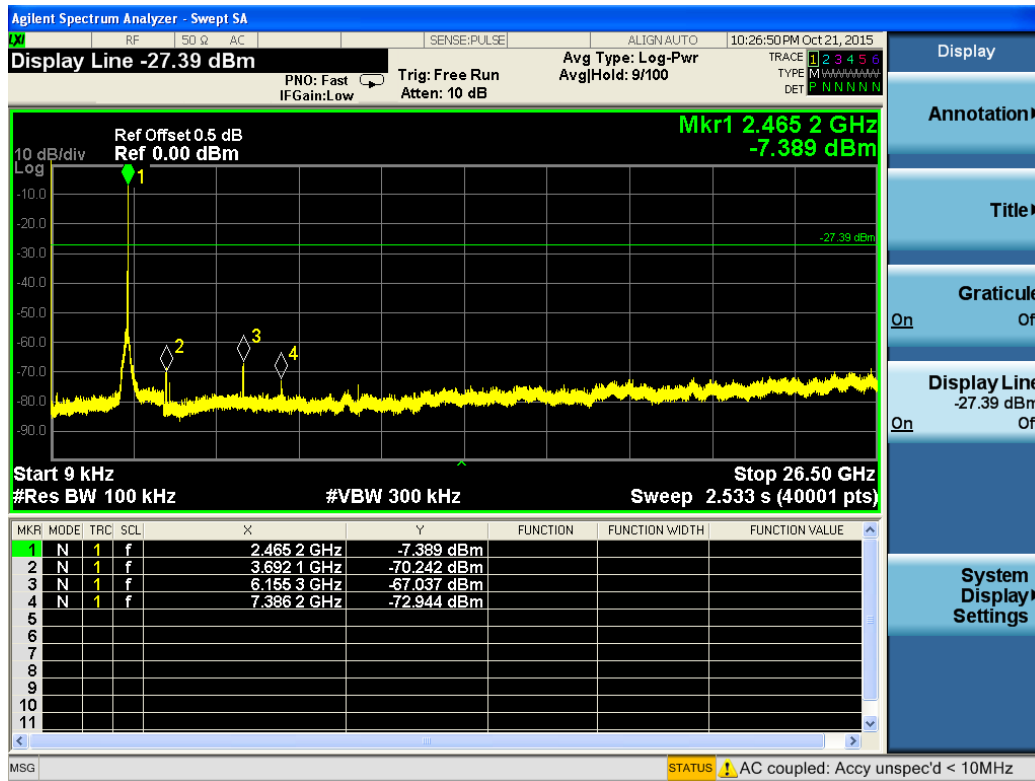

802.11n HT40

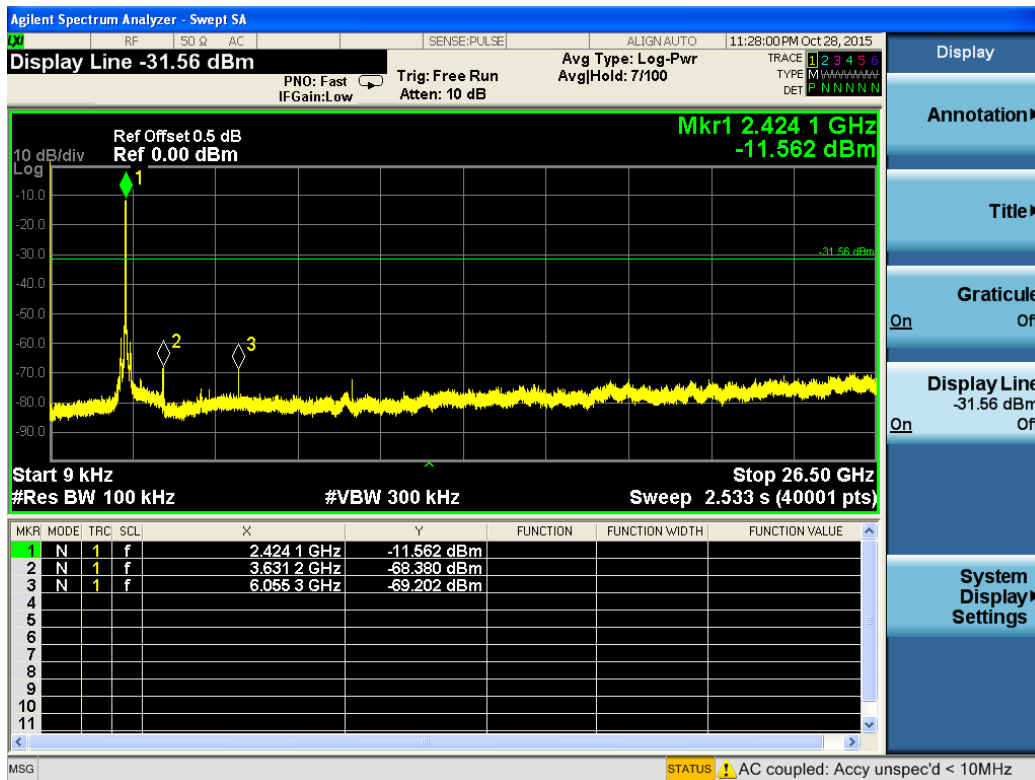

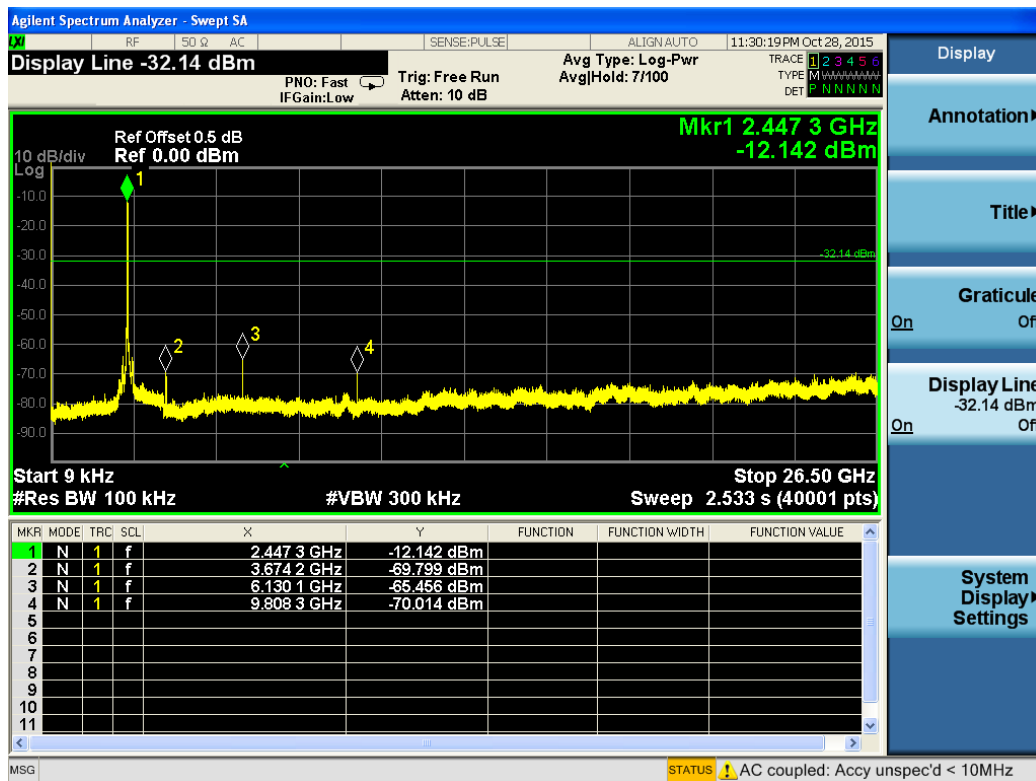
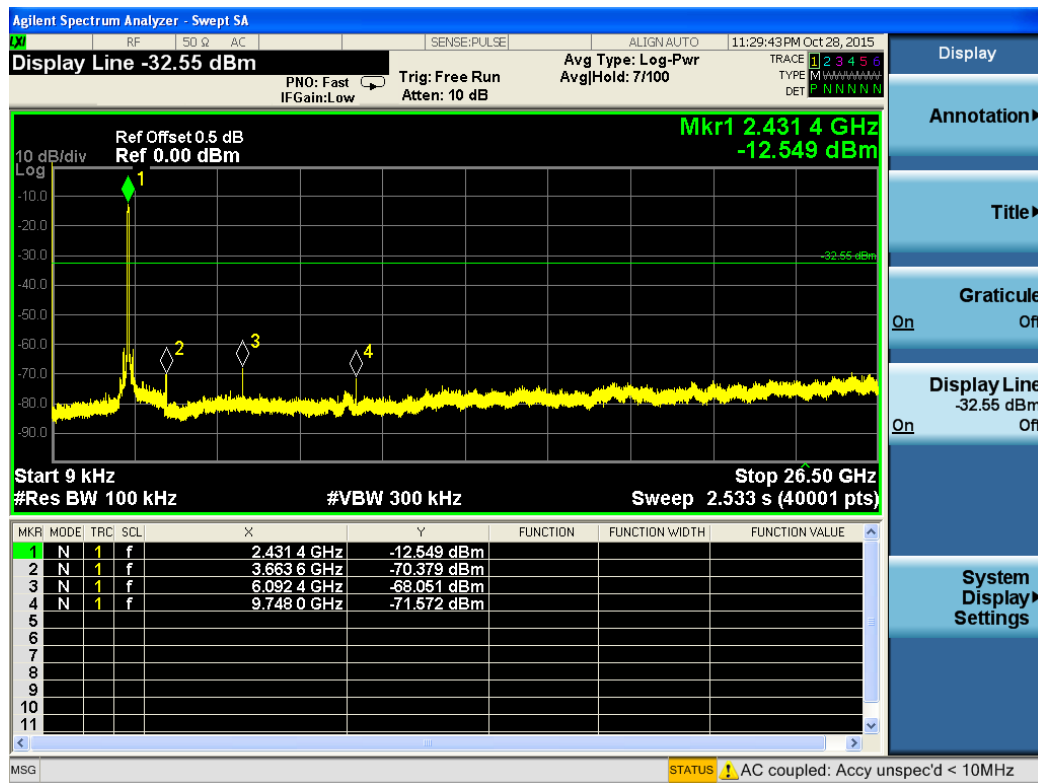

6.5.7. Test Results of Band Edges Test

802.11b

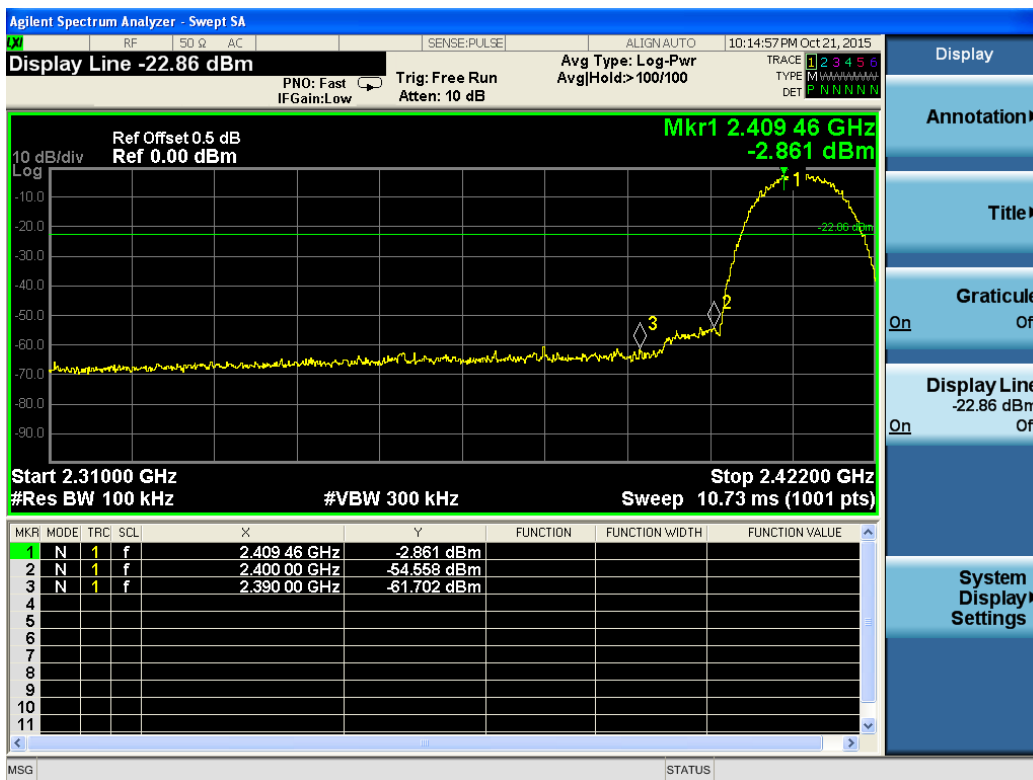

802.11g

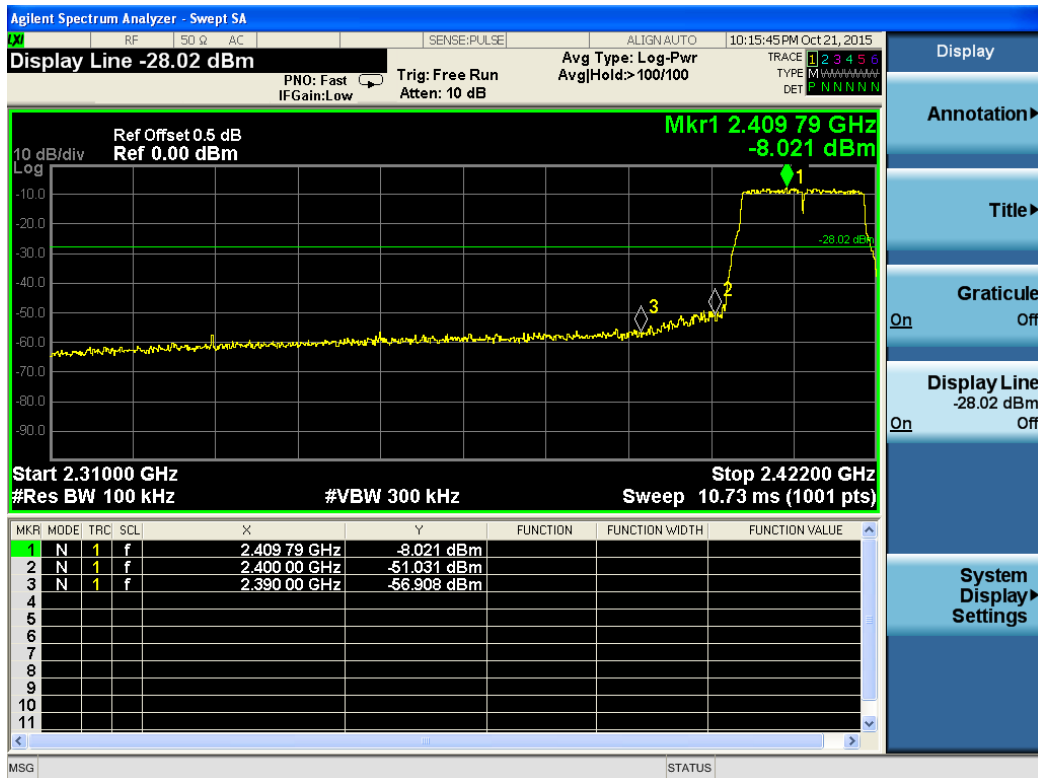

802.11n HT20



802.11n HT40

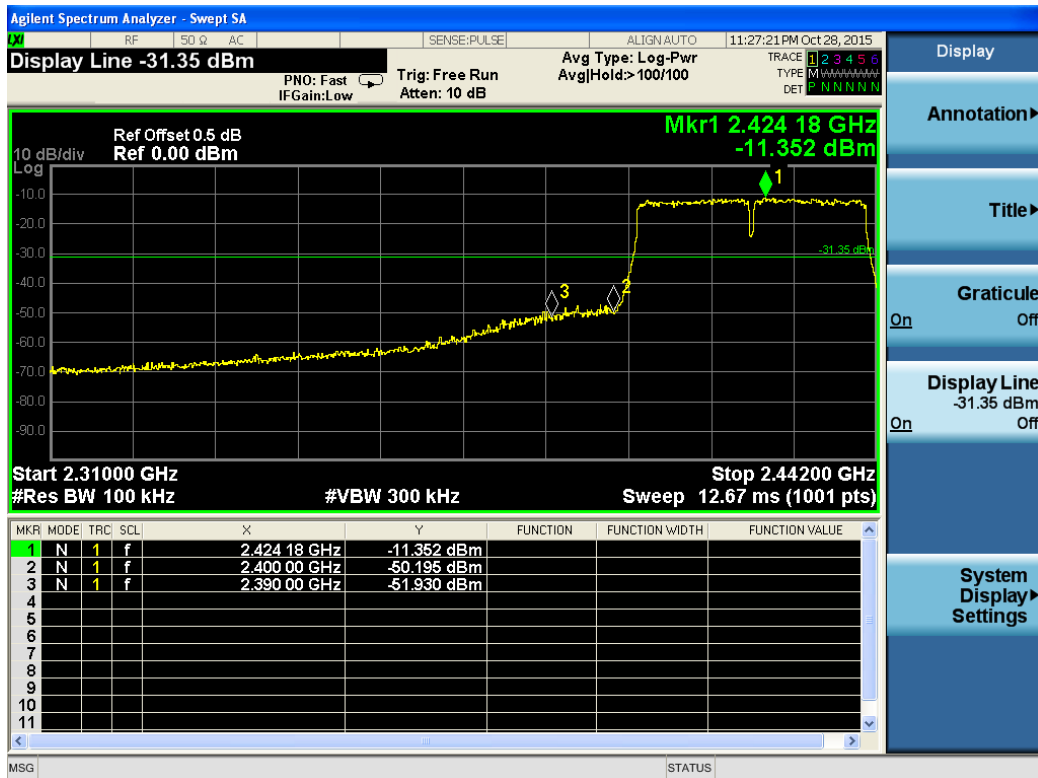

## 6.6. Power line conducted emissions

### 6.6.1 Standard Applicable

According to §15.207 (a): For an intentional radiator which is designed to be connected to the public utility (AC) power line, the radio frequency voltage that is conducted back onto the AC power line on any frequency or frequencies within the band 150 kHz to 30 MHz shall not exceed 250 microvolts (The limit decreases linearly with the logarithm of the frequency in the range 0.15 MHz to 0.50 MHz). The limits at specific frequency range is listed as follows:

Frequency Range (MHz)	Limits (dB $\mu$ V)	
	Quasi-peak	Average
0.15 to 0.50	66 to 56	56 to 46
0.50 to 5	56	46
5 to 30	60	50

### 6.6.2 Block Diagram of Test Setup

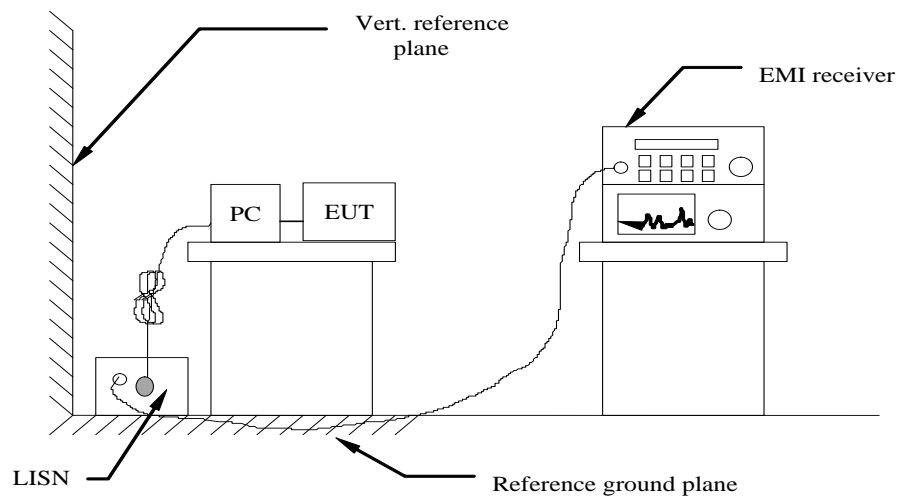

### 6.6.3 Test Results

PASS.

The test data please refer to following page.

Test result for 802.11b (High Channel)

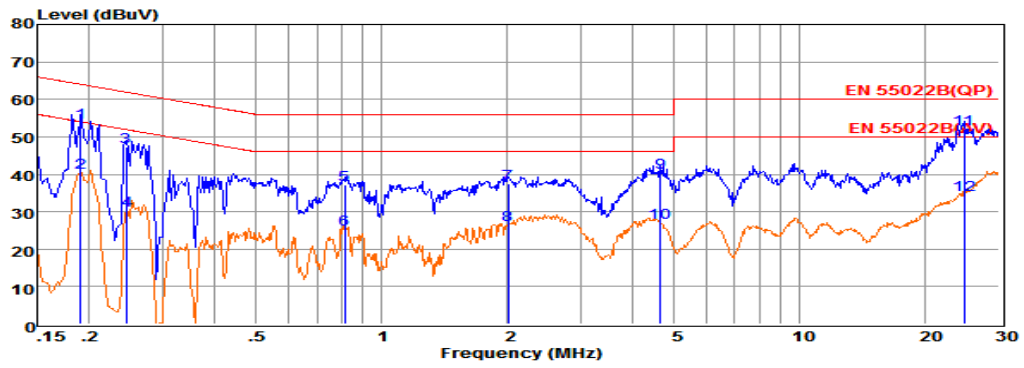

Env. Ins: 24\*/56\$  
 EUT: Wi-Fi Tablet  
 M/N: T7  
 Power Rating: AC 120V/60Hz  
 Test Mode: TX-High Channel  
 Operator: ERIC  
 Memo:  
 Pol: NEUTRAL

Freq	Reading	LisnFac	CabLos	Atten_Fac	Measured	Limit	Over	Remark
MHz	dBuV	dB	dB	dB	dBuV	dBuV	dB	
1 0.19039	34.34	9.61	0.02	10.00	53.97	64.02	-10.05	QP
2 0.19049	20.72	9.61	0.02	10.00	40.35	54.02	-13.67	Average
3 0.24552	27.51	9.60	0.03	10.00	47.14	61.91	-14.77	QP
4 0.24562	10.64	9.60	0.03	10.00	30.27	51.90	-21.63	Average
5 0.81737	17.57	9.63	0.04	10.00	37.24	56.00	-18.76	QP
6 0.81747	5.50	9.63	0.04	10.00	25.17	46.00	-20.83	Average
7 2.01185	17.66	9.63	0.05	10.00	37.34	56.00	-18.66	QP
8 2.01285	6.88	9.63	0.05	10.00	26.56	46.00	-19.44	Average
9 4.64685	20.66	9.66	0.06	10.00	40.38	56.00	-15.62	QP
10 4.64785	7.24	9.66	0.06	10.00	26.96	46.00	-19.04	Average
1124.79044	32.10	9.83	0.13	10.00	52.06	60.00	-7.94	QP
1224.79144	14.50	9.83	0.13	10.00	34.46	50.00	-15.54	Average

Remarks: 1. Measured = Reading + Lisn Factor +Cable Loss+Atten\_Fac.  
 2. The emission levels that are 20dB below the official limit are not reported.

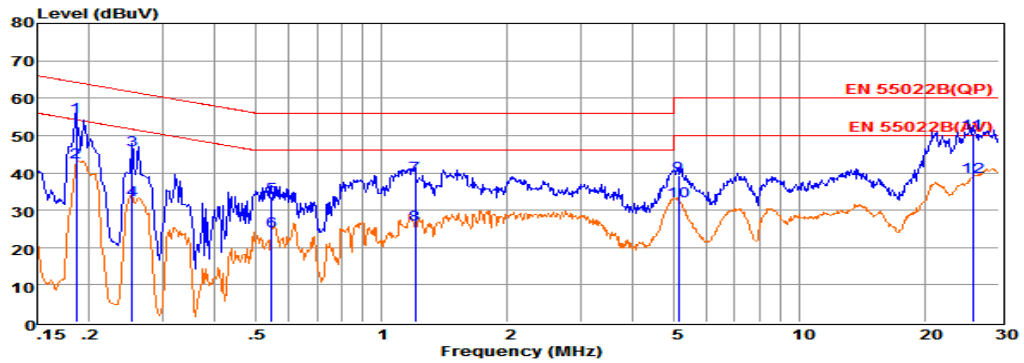

Env. Ins: 24\*/56\$  
 EUT: Wi-Fi Tablet  
 M/N: T7  
 Power Rating: AC 120V/60Hz  
 Test Mode: TX-High Channel  
 Operator: ERIC  
 Memo:  
 Pol: LINE

Freq	Reading	LisnFac	CabLos	Atten_Fac	Measured	Limit	Over	Remark
MHz	dBuV	dB	dB	dB	dBuV	dBuV	dB	
1 0.18639	35.43	9.62	0.02	10.00	55.07	64.20	-9.13	QP
2 0.18649	23.16	9.62	0.02	10.00	42.80	54.19	-11.39	Average
3 0.25345	26.36	9.63	0.03	10.00	46.02	61.64	-15.62	QP
4 0.25355	13.02	9.63	0.03	10.00	32.68	51.64	-18.96	Average
5 0.54644	13.81	9.63	0.04	10.00	33.48	56.00	-22.52	QP
6 0.54654	4.69	9.63	0.04	10.00	24.36	46.00	-21.64	Average
7 1.20336	19.58	9.63	0.05	10.00	39.26	56.00	-16.74	QP
8 1.20436	6.40	9.63	0.05	10.00	26.08	46.00	-19.92	Average
9 5.13900	19.67	9.65	0.06	10.00	39.38	60.00	-20.62	QP
10 5.14000	12.67	9.65	0.06	10.00	32.38	50.00	-17.62	Average
1126.00120	30.86	9.71	0.13	10.00	50.70	60.00	-9.30	QP
1226.00220	19.01	9.71	0.13	10.00	38.85	50.00	-11.15	Average

Remarks: 1. Measured = Reading + Lisn Factor +Cable Loss+Atten\_Fac.  
 2. The emission levels that are 20dB below the official limit are not reported.



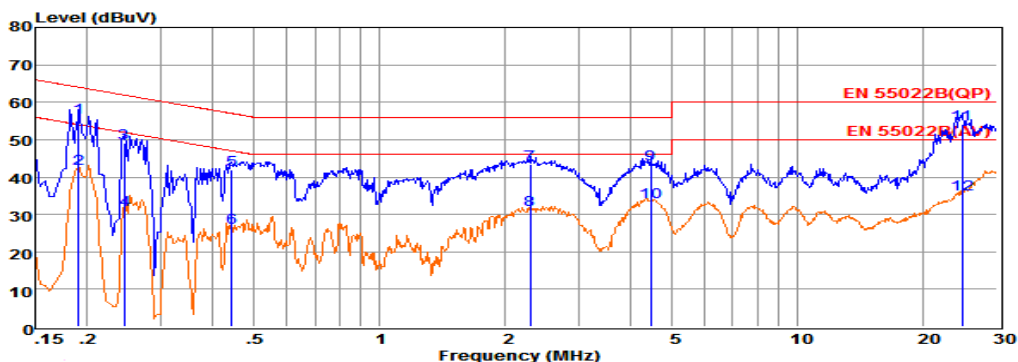

Env. Ins: 24\*/56%  
 EUT: Wi-Fi Tablet  
 M/N: T7  
 Power Rating: AC 240V/60Hz  
 Test Mode: TX-High Channel  
 Operator: ERIC  
 Memo:  
 Pol: NEUTRAL

Freq	Reading	LisnFac	CabLos	Atten_Fac	Measured	Limit	Over	Remark
MHz	dBuV	dB	dB	dB	dBuV	dBuV	dB	
1 0.19039	36.34	9.61	0.02	10.00	55.97	64.02	-8.05	QP
2 0.19049	22.72	9.61	0.02	10.00	42.35	54.02	-11.67	Average
3 0.24552	29.51	9.60	0.03	10.00	49.14	61.91	-12.77	QP
4 0.24562	11.64	9.60	0.03	10.00	31.27	51.90	-20.63	Average
5 0.44208	22.42	9.62	0.04	10.00	42.08	57.02	-14.94	QP
6 0.44218	6.69	9.62	0.04	10.00	26.35	47.02	-20.67	Average
7 2.29679	23.81	9.63	0.05	10.00	43.49	56.00	-12.51	QP
8 2.29779	11.46	9.63	0.05	10.00	31.14	46.00	-14.86	Average
9 4.45400	23.55	9.66	0.06	10.00	43.27	56.00	-12.73	QP
10 4.45500	13.66	9.66	0.06	10.00	33.38	46.00	-12.62	Average
1124.79044	34.10	9.83	0.13	10.00	54.06	60.00	-5.94	QP
1224.79144	15.50	9.83	0.13	10.00	35.46	50.00	-14.54	Average

Remarks: 1. Measured = Reading + Lisn Factor +Cable Loss+Atten Fac.  
 2. The emission levels that are 20dB below the official limit are not reported.

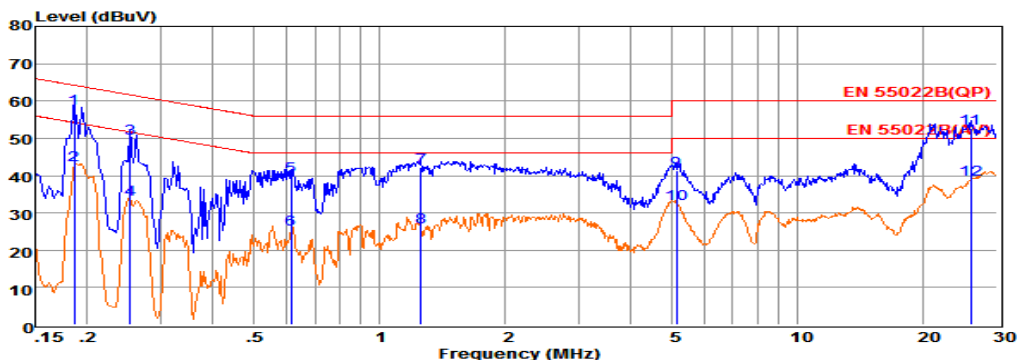

Env. Ins: 24\*/56%  
 EUT: Wi-Fi Tablet  
 M/N: T7  
 Power Rating: AC 240V/60Hz  
 Test Mode: TX-High Channel  
 Operator: ERIC  
 Memo:  
 Pol: LINE

Freq	Reading	LisnFac	CabLos	Atten_Fac	Measured	Limit	Over	Remark
MHz	dBuV	dB	dB	dB	dBuV	dBuV	dB	
1 0.18639	38.43	9.62	0.02	10.00	58.07	64.20	-6.13	QP
2 0.18649	23.16	9.62	0.02	10.00	42.80	54.19	-11.39	Average
3 0.25345	30.36	9.63	0.03	10.00	50.02	61.64	-11.62	QP
4 0.25355	14.02	9.63	0.03	10.00	33.68	51.64	-17.96	Average
5 0.61400	20.05	9.63	0.04	10.00	39.72	56.00	-16.28	QP
6 0.61410	5.98	9.63	0.04	10.00	25.65	46.00	-20.35	Average
7 1.25546	22.55	9.63	0.05	10.00	42.23	56.00	-13.77	QP
8 1.25646	6.42	9.63	0.05	10.00	26.10	46.00	-19.90	Average
9 5.13900	21.67	9.65	0.06	10.00	41.38	60.00	-18.62	QP
10 5.14000	12.67	9.65	0.06	10.00	32.38	50.00	-17.62	Average
1126.00120	32.86	9.71	0.13	10.00	52.70	60.00	-7.30	QP
1226.00320	19.01	9.71	0.13	10.00	38.85	50.00	-11.15	Average

Remarks: 1. Measured = Reading + Lisn Factor +Cable Loss+Atten Fac.  
 2. The emission levels that are 20dB below the official limit are not reported.

\*\*\*Note: Pre-scan all mode and recorded the worst case results in this report (802.11b (High Channel)).

## 7. ANTENNA REQUIREMENT

### 7.1 Standard Applicable

According to antenna requirement of §15.203.

An intentional radiator shall be designed to ensure that no antenna other than that furnished by the responsible party shall be used with the device. The use of a permanently attached antenna or of an antenna that uses a unique coupling to the intentional radiator shall be considered sufficient to comply with the provisions of this Section. The manufacturer may design the unit so that a broken antenna can be re-placed by the user, but the use of a standard antenna jack or electrical connector is prohibited. This requirement does not apply to carrier current devices or to devices operated under the provisions of Sections 15.211, 15.213, 15.217, 15.219, or 15.221. Further, this requirement does not apply to intentional radiators that must be professionally installed, such as perimeter protection systems and some field disturbance sensors, or to other intentional radiators which, in accordance with Section 15.31(d), must be measured at the installation site. However, the installer shall be responsible for ensuring that the proper antenna is employed so that the limits in this Part are not exceeded.

And according to §15.247(4)(1), system operating in the 2400-2483.5MHz bands that are used exclusively for fixed, point-to-point operations may employ transmitting antennas with directional gain greater than 6dBi provided the maximum peak output power of the intentional radiator is reduced by 1 dB for every 3 dB that the directional gain of the antenna exceeds 6dBi.

### 7.2 Antenna Connected Construction

#### 7.2.1. Standard Applicable

According to § 15.203 & RSS-Gen, an intentional radiator shall be designed to ensure that no antenna other than that furnished by the responsible party shall be used with the device.

#### 7.2.2. Antenna Connector Construction

The directional gains of antenna used for transmitting is 2.0dBi, and the antenna is connect to PCB board and no consideration of replacement. Please see EUT photo for details.

#### 7.2.3. Results: Compliance.

**Measurement parameters:**

Measurement parameter	
Detector:	Peak
Sweep time:	Auto
Resolution bandwidth:	3 MHz
Video bandwidth:	3 MHz
Trace-Mode:	Max hold

Note: The antenna gain of the complete system is calculated by the difference of radiated power in EIRP and the conducted power of the module. For normal Bluetooth devices, the DSSS mode is used.

**Limits:**

FCC	IC
Antenna Gain	
6dBi	

Tnom	Vnom	lowest channel 2412 MHz	middle channel 2437 MHz	highest channel 2462 MHz
Conducted power [dBm] Measured with DSSS		8.37	8.51	8.34
Radiated power [dBm] Measured with DSSS		9.31	9.44	9.30
Gain [dBi] Calculated		0.94	0.93	0.96
Measurement uncertainty			± 1.5 dB (cond.) / ± 3 dB (rad.)	

**Result: -/-**

-----THE END OF TEST REPORT-----