

# SAR EVALUATION REPORT

For

## SWAGTEK

10205 NW 19th Street STE101, Miami, Florida, United States

**FCC ID: O55T351F1**

<b>Report Type:</b> Revised Report	<b>Product Type:</b> 3G MOBILE PHONE
<b>Prepared By:</b> Wilson Chen	<i>Wilson Chen</i>
<b>Report Number:</b> RSZ151216004-20 Rev	
<b>Report Date:</b> 2016-10-18	
<b>Reviewed By:</b> Terry XiaHou	<i>Terry XiaHou</i>
<b>Prepared By:</b> Bay Area Compliance Laboratories Corp. (Shenzhen) 6/F, the 3rd Phase of WanLi Industrial Building, ShiHua Road, FuTian Free Trade Zone Shenzhen, Guangdong, China Tel: +86-755-33320018 Fax: +86-755-33320008 <a href="http://www.baclcorp.com.cn">www.baclcorp.com.cn</a>	

Attestation of Test Results		
<b>EUT Information</b>	<b>Company Name</b>	SWAGTEK
	<b>EUT Description</b>	3G MOBILE PHONE
	<b>FCC ID</b>	O55T351F1
	<b>Model Number</b>	Main model: Fire Multiple model: LOGIC X3.5
	<b>Test Date</b>	2016-10-04 and 2016-10-05
<b>Frequency</b>	<b>Max. SAR Level(s) Reported</b>	<b>Limit(W/Kg)</b>
<b>GSM 850</b>	0.464 W/kg 1g Head SAR 0.799 W/kg 1g Body SAR	<b>1.6</b>
<b>PCS 1900</b>	0.292 W/kg 1g Head SAR 0.837 W/kg 1g Body SAR	
<b>WCDMA850</b>	0.323 W/kg 1g Head SAR 0.348 W/kg 1g Body SAR	
<b>WCDMA1900</b>	0.418 W/kg 1g Head SAR 0.812 W/kg 1g Body SAR	
<b>Simultaneous</b>	0.855 W/kg 1g Head SAR 1.033 W/kg 1g Body SAR	
<b>Hotspot</b>	1.033 W/kg 1g Body SAR	
<b>Applicable Standards</b>	<b>ANSI / IEEE C95.1 : 2005</b> IEEE Standard for Safety Levels with Respect to Human Exposure to Radio Frequency Electromagnetic Fields,3 kHz to 300 GHz.	
	<b>ANSI / IEEE C95.3 : 2002</b> IEEE Recommended Practice for Measurements and Computations of Radio Frequency Electromagnetic Fields With Respect to Human Exposure to SuchFields,100 kHz—300 GHz.	
	<b>IEEE1528:2013</b> IEEE Recommended Practice for Determining the Peak Spatial-Average Specific Absorption Rate (SAR) in the Human Head from Wireless Communications Devices: Measurement Techniques	
	<b>KDB procedures</b> KDB 447498 D01 General RF Exposure Guidance v06. KDB 648474 D04 Handset SAR v01r03. KDB 865664 D01 SAR measurement 100 MHz to 6 GHz v01r04 KDB 865664 D02 RF Exposure Reporting v01r02 KDB 941225 D01 3G SAR Procedures v03r01 KDB 941225 D06 Hotspot Mode v02r01	
<p><b>Note:</b> This wireless device has been shown to be capable of compliance for localized specific absorption rate (SAR) for General Population/Uncontrolled Exposure limits specified in ANSI/IEEE Standards and has been tested in accordance with the measurement procedures specified in IEEE 1528-2013 and RF exposure KDB procedures.</p> <p><b>The results and statements contained in this report pertain only to the device(s) evaluated.</b></p>		

## TABLE OF CONTENTS

<b>DOCUMENT REVISION HISTORY .....</b>	<b>5</b>
<b>EUT DESCRIPTION .....</b>	<b>6</b>
TECHNICAL SPECIFICATION .....	6
<b>REFERENCE, STANDARDS, AND GUIDELINES .....</b>	<b>7</b>
SAR LIMITS .....	8
<b>FACILITIES.....</b>	<b>9</b>
<b>DESCRIPTION OF TEST SYSTEM .....</b>	<b>10</b>
<b>EQUIPMENT LIST AND CALIBRATION .....</b>	<b>17</b>
EQUIPMENTS LIST & CALIBRATION INFORMATION .....	17
<b>SAR MEASUREMENT SYSTEM VERIFICATION .....</b>	<b>18</b>
LIQUID VERIFICATION .....	18
SYSTEM ACCURACY VERIFICATION .....	20
SAR SYSTEM VALIDATION DATA .....	21
<b>EUT TEST STRATEGY AND METHODOLOGY .....</b>	<b>29</b>
TEST POSITIONS FOR DEVICE OPERATING NEXT TO A PERSON’S EAR.....	29
CHEEK/TOUCH POSITION .....	30
EAR/TILT POSITION .....	30
TEST POSITIONS FOR BODY-WORN AND OTHER CONFIGURATIONS .....	31
SAR EVALUATION PROCEDURE.....	32
TEST METHODOLOGY .....	32
<b>CONDUCTED OUTPUT POWER MEASUREMENT .....</b>	<b>33</b>
PROVISION APPLICABLE .....	33
TEST PROCEDURE .....	33
<b>SAR MEASUREMENT RESULTS .....</b>	<b>42</b>
SAR TEST DATA.....	42
<b>SAR SIMULTANEOUS TRANSMISSION DESCRIPTION .....</b>	<b>48</b>
SAR PLOTS.....	52
<b>APPENDIX A MEASUREMENT UNCERTAINTY .....</b>	<b>102</b>
<b>APPENDIX B – PROBE CALIBRATION CERTIFICATES.....</b>	<b>104</b>
<b>APPENDIX C DIPOLE CALIBRATION CERTIFICATES .....</b>	<b>113</b>
<b>APPENDIX D EUT TEST POSITION PHOTOS .....</b>	<b>131</b>
LIQUID DEPTH $\geq$ 15CM.....	131
BODY-WORN BACK SETUP PHOTO (10MM) .....	131
BODY-WORN LEFT SETUP PHOTO (10MM) .....	132
BODY-WORN RIGHT SETUP PHOTO (10MM) .....	132
BODY-WORN BOTTOM SETUP PHOTO (10MM) .....	133
LEFT HEAD TOUCH SETUP PHOTO .....	133
LEFT HEAD TILT SETUP PHOTO .....	134
RIGHT HEAD TOUCH SETUP PHOTO .....	134
RIGHT HEAD TILT SETUP PHOTO .....	135
<b>APPENDIX E EUT PHOTOS.....</b>	<b>136</b>
EUT – FRONT VIEW.....	136
EUT – BACK VIEW .....	136
EUT –LEFT SIDE VIEW .....	137
EUT – RIGHT SIDE VIEW .....	137

EUT – TOP VIEW ..... 138  
EUT – BOTTOM VIEW..... 138  
EUT – UNCOVER VIEW..... 139  
**APPENDIX F INFORMATIVE REFERENCES ..... 140**

**DOCUMENT REVISION HISTORY**

<b>Revision Number</b>	<b>Report Number</b>	<b>Description of Revision</b>	<b>Date of Revision</b>
0	RSZ151216004-20	Original Report	2016-01-05
1	RSZ151216004-20 Rev	Revised Report	2016-10-18

## EUT DESCRIPTION

This report has been prepared on behalf of SWAGTEK and their product, FCC ID: O55T351F1, Model: Fire or the EUT (Equipment under Test) as referred to in the rest of this report.

*\*Note: This series products model: LOGIC X3.5 and Fire, we select model: Fire to test, there is no electrical change has been made to the equipment, please refer to the product similarity letter.*

### Technical Specification

<b>Product Type</b>	Portable
<b>Exposure Category:</b>	Population / Uncontrolled
<b>Antenna Type(s):</b>	Internal Antenna
<b>Body-Worn Accessories:</b>	Headset
<b>Face-Head Accessories:</b>	None
<b>Multi-slot Class:</b>	Class12
<b>Operation Mode :</b>	GSM Voice, GPRS Data, WCDMA(Rel99, HSUPA, HSDPA), Wi-Fi and Bluetooth
<b>Frequency Band:</b>	GSM 850 : 824-849 MHz(TX) ; 869-894 MHz(RX) PCS 1900: 1850-1910 MHz(TX) ; 1930-1990 MHz(RX) WCDMA 850: 824-849 MHz(TX) ; 869-894 MHz(RX) WCDMA 1900: 1850-1910 MHz(TX) ; 1930-1990 MHz(RX) Wi-Fi(802.11b/g/n20): 2412 MHz-2472 MHz Bluetooth3.0 : 2402 MHz-2480 MHz
<b>Conducted RF Power:</b>	GSM 850 : 33.18 dBm PCS 1900: 29.66dBm WCDMA 850: 22.67 dBm WCDMA 1900: 21.99 dBm Wi-Fi: 9.62 dBm Bluetooth:7.88 dBm
<b>Dimensions (L*W*H):</b>	115 mm (L) × 62 mm (W) × 10 mm (H)
<b>Power Source:</b>	3.7 V <sub>DC</sub> Rechargeable Battery
<b>Normal Operation:</b>	Head and Body-worn

---

## REFERENCE, STANDARDS, AND GUIDELINES

---

### **FCC:**

The Report and Order requires routine SAR evaluation prior to equipment authorization of portable transmitter devices, including portable telephones. For consumer products, the applicable limit is 1.6 mW/g as recommended by the ANSI/IEEE standard C95.1-1992 [6] for an uncontrolled environment (Paragraph 65). According to the Supplement C of OET Bulletin 65 "Evaluating Compliance with FCC Guide-lines for Human Exposure to Radio frequency Electromagnetic Fields", released on Jun 29, 2001 by the FCC, the device should be evaluated at maximum output power (radiated from the antenna) under "worst-case" conditions for normal or intended use, incorporating normal antenna operating positions, device peak performance frequencies and positions for maximum RF energy coupling.

This report describes the methodology and results of experiments performed on wireless data terminal. The objective was to determine if there is RF radiation and if radiation is found, what is the extent of radiation with respect to safety limits. SAR (Specific Absorption Rate) is the measure of RF exposure determined by the amount of RF energy absorbed by human body (or its parts) – to determine how the RF energy couples to the body or head which is a primary health concern for body worn devices. The limit below which the exposure to RF is considered safe by regulatory bodies in North America is 1.6 mW/g average over 1 gram of tissue mass.

### **CE:**

The order requires routine SAR evaluation prior to equipment authorization of portable transmitter devices, including portable telephones. For consumer products, the applicable limit is 2 mW/g as recommended by EN62209-1 for an uncontrolled environment. According to the Standard, the device should be evaluated at maximum output power (radiated from the antenna) under "worst-case" conditions for normal or intended use, incorporating normal antenna operating positions, device peak performance frequencies and positions for maximum RF energy coupling.

This report describes the methodology and results of experiments performed on wireless data terminal. The objective was to determine if there is RF radiation and if radiation is found, what is the extent of radiation with respect to safety limits. SAR (Specific Absorption Rate) is the measure of RF exposure determined by the amount of RF energy absorbed by human body (or its parts) – to determine how the RF energy couples to the body or head which is a primary health concern for body worn devices. The limit below which the exposure to RF is considered safe by regulatory bodies in Europe is 2 mW/g average over 10 gram of tissue mass.

The test configurations were laid out on a specially designed test fixture to ensure the reproducibility of measurements. Each configuration was scanned for SAR. Analysis of each scan was carried out to characterize the above effects in the device.

**SAR Limits**

FCC Limit (1g Tissue)

EXPOSURE LIMITS	SAR (W/kg)	
	(General Population / Uncontrolled Exposure Environment)	(Occupational / Controlled Exposure Environment)
Spatial Average (averaged over the whole body)	0.08	0.4
Spatial Peak (averaged over any 1 g of tissue)	1.60	8.0
Spatial Peak (hands/wrists/feet/ankles averaged over 10 g)	4.0	20.0

CE Limit (10g Tissue)

EXPOSURE LIMITS	SAR (W/kg)	
	(General Population / Uncontrolled Exposure Environment)	(Occupational / Controlled Exposure Environment)
Spatial Average (averaged over the whole body)	0.08	0.4
Spatial Peak (averaged over any 10 g of tissue)	2.0	10
Spatial Peak (hands/wrists/feet/ankles averaged over 10 g)	4.0	20.0

Population/Uncontrolled Environments are defined as locations where there is the exposure of individual who have no knowledge or control of their exposure.

Occupational/Controlled Environments are defined as locations where there is exposure that may be incurred by people who are aware of the potential for exposure (i.e. as a result of employment or occupation).

General Population/Uncontrolled environments Spatial Peak limit 1.6W/kg (FCC) & 2 W/kg (CE) applied to the EUT.



## **FACILITIES**

---

The test site used by Bay Area Compliance Laboratories Corp. (Shenzhen) to collect data is located at 6/F, the 3rd Phase of WanLi Industrial Building, Shi Hua Road, Fu Tian Free Trade Zone, Shenzhen, Guangdong, P.R. of China

## DESCRIPTION OF TEST SYSTEM

These measurements were performed with ALSAS 10 Universal Integrated SAR Measurement system from APREL Laboratories.

### ALSAS-10U System Description

ALSAS-10-U is fully compliant with the technical and scientific requirements of IEEE 1528, IEC 62209, CENELEC, ARIB, ACA, and the Federal Communications Commission. The system comprises of a six axes articulated robot which utilizes a dedicated controller. ALSAS-10U uses the latest methodologies. And FDTD modeling to provide a platform which is repeatable with minimum uncertainty.

### Applications

Predefined measurement procedures compliant with the guidelines of CENELEC, IEEE, IEC, FCC, etc are utilized during the assessment for the device. Automatic detection for all SAR maxima are embedded within the core architecture for the system, ensuring that peak locations used for centering the zoom scan are within a 1mm resolution and a 0.05mm repeatable position. System operation range currently available up-to 6 GHz in simulated tissue.

### Area Scans

Area scans are defined prior to the measurement process being executed with a user defined variable spacing between each measurement point (integral) allowing low uncertainty measurements to be conducted. Scans defined for FCC applications utilize a 10mm<sup>2</sup> step integral, with 1mm interpolation used to locate the peak SAR area used for zoom scan assessments.

Where the system identifies multiple SAR peaks (which are within 25% of peak value) the system will provide the user with the option of assessing each peak location individually for zoom scan averaging.

### Zoom Scan (Cube Scan Averaging)

The averaging zoom scan volume utilized in the ALSAS-10U software is in the shape of a cube and the side dimension of a 1 g or 10 g mass is dependent on the density of the liquid representing the simulated tissue. A density of 1000 kg/m<sup>3</sup> is used to represent the head and body tissue density and not the phantom liquid density, in order to be consistent with the definition of the liquid dielectric properties, i.e. the side length of the 1 g cube is 10mm, with the side length of the 10 g cube 21,5mm.

When the cube intersects with the surface of the phantom, it is oriented so that 3 vertices touch the surface of the shell or the center of a face is tangent to the surface. The face of the cube closest to the surface is modified in order to conform to the tangent surface.

The zoom scan integer steps can be user defined so as to reduce uncertainty, but normal practice for typical test applications (including FCC) utilize a physical step of 5x5x8 (8mmx8mmx5mm) providing a volume of 32mm<sup>3</sup> in the X & Y axis, and 35mm in the Z axis.



### ALSAS-10U Interpolation and Extrapolation Uncertainty

The overall uncertainty for the methodology and algorithms the used during the SAR calculation was evaluated using the data from IEEE 1528 based on the example f3 algorithm:

$$f_3(x, y, z) = A \frac{a^2}{\frac{a^2}{4} + x'^2 + y'^2} \cdot \left( e^{-\frac{2z}{a}} + \frac{a^2}{2(a + 2z)^2} \right)$$

### Isotropic E-Field Probe

The isotropic E-Field probe has been fully calibrated and assessed for isotropicity, and boundary effect within a controlled environment. Depending on the frequency for which the probe is calibrated the method utilized for calibration will change.

The E-Field probe utilizes a triangular sensor arrangement as detailed in the diagram below:

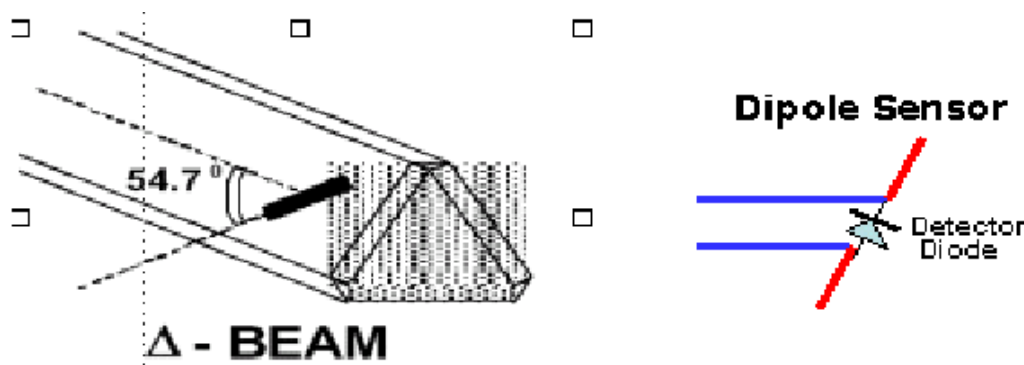

SAR is assessed with a calibrated probe which moves at a default height of 5mm from the center of the diode, which is mounted to the sensor, to the phantom surface (in the Z Axis). The 5mm offset height has been selected so as to minimize any resultant boundary effect due to the probe being in close proximity to the phantom surface.

The following algorithm is an example of the function used by the system for linearization of the output from the probe when measuring complex modulation schemes.

$$V_i = U_i + U_i^2 \cdot \frac{cf}{dcp_i}$$

### Isotropic E-Field Probe Specification

<b>Calibration Method</b>	Frequency Dependent Below 1 GHz Calibration in air performed in a TEM Cell Above 1 GHz Calibration in air performed in waveguide
<b>Sensitivity</b>	0.70 $\mu\text{V}/(\text{V}/\text{m})^2$ to 0.85 $\mu\text{V}/(\text{V}/\text{m})^2$
<b>Dynamic Range</b>	0.0005 W/kg to 100 W/kg
<b>Isotropic Response</b>	Better than 0.1 dB
<b>Diode Compression Point (DCP)</b>	Calibration for Specific Frequency
<b>Probe Tip Diameter</b>	< 2.9 mm
<b>Sensor Offset</b>	1.56 (+/- 0.02 mm)
<b>Probe Length</b>	289 mm
<b>Video Bandwidth</b>	@ 500 Hz: 1 dB @ 1.02 kHz: 3 dB
<b>Boundary Effect</b>	Less than 2.1% for distance greater than 0.58 mm
<b>Spatial Resolution</b>	The spatial resolution uncertainty is less than 1.5% for 4.9mm diameter probe. The spatial resolution uncertainty is less than 1.0% for 2.5mm diameter probe

### Boundary Detection Unit and Probe Mounting Device

ALSAS-10U incorporates a boundary detection unit with a sensitivity of 0.05mm for detecting all types of surfaces. The robust design allows for detection during probe tilt (probe normalize) exercises, and utilizes a second stage emergency stop. The signal electronics are fed directly into the robot controller for high accuracy surface detection in lateral and axial detection modes (X, Y, & Z).

The probe is mounted directly onto the Boundary Detection unit for accurate tooling and displacement calculations controlled by the robot kinematics. The probe is connect to an isolated probe interconnect where the output stage of the probe is fed directly into the amplifier stage of the Daq-Paq.

### Daq-Paq (Analog to Digital Electronics)

ALSAS-10U incorporates a fully calibrated Daq-Paq (analog to digital conversion system) which has a 4 channel input stage, sent via a 2 stage auto-set amplifier module. The input signal is amplified accordingly so as to offer a dynamic range from 5 $\mu\text{V}$  to 800mV. Integration of the fields measured is carried out at board level utilizing a Co-Processor which then sends the measured fields down into the main computational module in digitized form via an RS232 communications port. Probe linearity and duty cycle compensation is carried out within the main Daq-Paq module.

<b>ADC</b>	12 Bit
<b>Amplifier Range</b>	20 mV to 200 mV and 150 mV to 800 mV
<b>Field Integration</b>	Local Co-Processor utilizing proprietary integration algorithms
<b>Number of Input Channels</b>	4 in total 3 dedicated and 1 spare
<b>Communication</b>	Packet data via RS232

**Axis Articulated Robot**

ALSAS-10U utilizes a six axis articulated robot, which is controlled using a Pentium based real-time movement controller. The movement kinematics engine utilizes proprietary (Thermo CRS) interpolation and extrapolation algorithms, which allow full freedom of movement for each of the six joints within the working envelope. Utilization of joint 6 allows for full probe rotation with a tolerance better than 0.05mm around the central axis.



<b>Robot/Controller Manufacturer</b>	Thermo CRS
<b>Number of Axis</b>	Six independently controlled axis
<b>Positioning Repeatability</b>	0.05 mm
<b>Controller Type</b>	Single phase Pentium based C500C
<b>Robot Reach</b>	710 mm
<b>Communication</b>	RS232 and LAN compatible

**ALSAS Universal Workstation**

ALSAS Universal workstation allows for repeatability and fast adaptability. It allows users to do calibration, testing and measurements using different types of phantoms with one set up, which significantly speeds up the measurement process.

**Universal Device Positioner**

The universal device positioner allows complete freedom of movement of the EUT. Developed to hold a EUT in a free-space scenario any additional loading attributable to the material used in the construction of the positioner has been eliminated. Repeatability has been enhanced through the linear scales which form the design used to indicate positioning for any given test scenario in all major axes. A 15° tilt indicator is included for the of aid cheek to tilt movements for head SAR analysis. Overall uncertainty for measurements have been reduced due to the design of the Universal device positioner, which allows positioning of a device in as near to a free-space scenario as possible, and by providing the means for complete repeatability.



**Phantom Types**

The ALSAS-10U allows the integration of multiple phantom types. SAM Phantoms fully compliant with IEEE 1528, Universal Phantom, and Universal Flat.

**APREL SAM Phantoms**

The SAM phantoms developed using the IEEE SAM CAD file. They are fully compliant with the requirements for both IEEE 1528 and FCC Supplement C. Both the left and right SAM phantoms are interchangeable, transparent and include the IEEE 1528 grid with visible NF and MB lines.

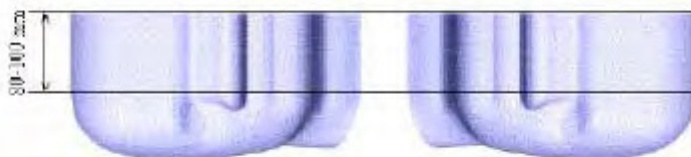

### **APREL Laboratories Universal Phantom**

The Universal Phantom is used on the ALSAS-10U as a system validation phantom. The Universal Phantom has been fully validated both experimentally from 800MHz to 6GHz and numerically using XFDTD numerical software.

The shell thickness is 2mm overall, with a 4mm spacer located at the NF/MB intersection providing an overall thickness of 6mm in line with the requirements of IEEE-1528.

The design allows for fast and accurate measurements, of handsets, by allowing the conservative SAR to be evaluated at on frequency for both left and right head experiments in one measurement.



### Tissue Dielectric Parameters for Head and Body Phantoms

The head tissue dielectric parameters recommended by the IEEE SCC-34/SC-2 in P1528 have been incorporated in the following table. These head parameters are derived from planar layer models simulating the highest expected SAR for the dielectric properties and tissue thickness variations in a human head. Other head and body tissue parameters that have not been specified in P1528 are derived from the tissue dielectric parameters computed from the 4-Cole-Cole equations described in Reference [12] and extrapolated according to the head parameters specified in P1528.

Ingredients (% by weight)	Frequency (MHz)									
	450		835		915		1900		2450	
Tissue Type	Head	Body	Head	Body	Head	Body	Head	Body	Head	Body
Water	38.56	51.16	41.45	52.4	41.05	56.0	54.9	40.4	62.7	73.2
Salt (NaCl)	3.95	1.49	1.45	1.4	1.35	0.76	0.18	0.5	0.5	0.04
Sugar	56.32	46.78	56.0	45.0	56.5	41.76	0.0	58.0	0.0	0.0
HEC	0.98	0.52	1.0	1.0	1.0	1.21	0.0	1.0	0.0	0.0
Bactericide	0.19	0.05	0.1	0.1	0.1	0.27	0.0	0.1	0.0	0.0
Triton x-100	0.0	0.0	0.0	0.0	0.0	0.0	0.0	0.0	36.8	0.0
DGBE	0.0	0.0	0.0	0.0	0.0	0.0	44.92	0.0	0.0	26.7
Dielectric Constant	43.42	58.0	42.54	56.1	42.0	56.8	39.9	54.0	39.8	52.5
Conductivity (s/m)	0.85	0.83	0.91	0.95	1.0	1.07	1.42	1.45	1.88	1.78

### Recommended Tissue Dielectric Parameters for Head and Body

Frequency (MHz)	Head Tissue		Body Tissue	
	$\epsilon_r$	$\sigma$ (S/m)	$\epsilon_r$	$\sigma$ (S/m)
150	52.3	0.76	61.9	0.80
300	45.3	0.87	58.2	0.92
450	43.5	0.87	56.7	0.94
835	41.5	0.90	55.2	0.97
900	41.5	0.97	55.0	1.05
915	41.5	0.98	55.0	1.06
1450	40.5	1.20	54.0	1.30
1610	40.3	1.29	53.8	1.40
1800-2000	40.0	1.40	53.3	1.52
2450	39.2	1.80	52.7	1.95
3000	38.5	2.40	52.0	2.73
5800	35.3	5.27	48.2	6.00



## EQUIPMENT LIST AND CALIBRATION

### Equipments List & Calibration Information

Equipment	Model	Calibration Date	Calibration Due Date	S/N
CRS F3 robot	ALS-F3	N/A	N/A	RAF0805352
CRS F3 Software	ALS-F3-SW	N/A	N/A	N/A
CRS C500C controller	ALS-C500	N/A	N/A	RCF0805379
Probe mounting device & Boundary Detection Sensor System	ALS-PMDPS-3	N/A	N/A	120-00270
Universal Work Station	ALS-UWS	N/A	N/A	100-00157
Data Acquisition Package	ALS-DAQ-PAQ-3	2015-12-14	2016-12-14	110-00212
Miniature E-Field Probe	ALS-E-020	2015-12-14	2016-12-14	500-00283
Dipole, 835MHz	ALS-D-835-S-2	2014-10-08	2017-10-08	180-00558
Dipole, 1900MHz	ALS-D-1900-S-2	2014-10-09	2017-10-09	210-00710
Device holder/Positioner	ALS-H-E-SET-2	N/A	N/A	170-00510
Left ear SAM phantom	ALS-P-SAM-L	N/A	N/A	130-00311
Right ear SAM phantom	ALS-P-SAM-R	N/A	N/A	140-00359
UniPhantom	ALS-UM-FLAT	N/A	N/A	153-00104
Simulated Tissue 835 MHz Head	ALS-TS-835-H	Each Time	/	270-01002
Simulated Tissue 835 MHz Body	ALS-TS-835-B	Each Time	/	270-02101
Simulated Tissue 1900 MHz Head	ALS-TS-1900-H	Each Time	/	295-01103
Simulated Tissue 1900 MHz Body	ALS-TS-1900-B	Each Time	/	295-02102
Directional couple	DC6180A	N/A	N/A	0325849
Power Amplifier	5S1G4	N/A	N/A	71377
Attenuator	3dB	N/A	N/A	5402
Dielectric probe kit	HP85070B	2016-06-13	2017-06-13	US33020324
Network analyzer	8752C	2016-06-03	2017-06-03	3410A02356
Synthesized Sweeper	HP 8341B	2016-06-03	2017-06-03	2624A00116
UNIVERSAL RADIO COMMUNICATION TESTER	CMU200	2015-11-23	2016-11-23	106891
EMI Test Receiver	ESCI	2016-06-13	2017-06-13	101746

# SAR MEASUREMENT SYSTEM VERIFICATION

## Liquid Verification

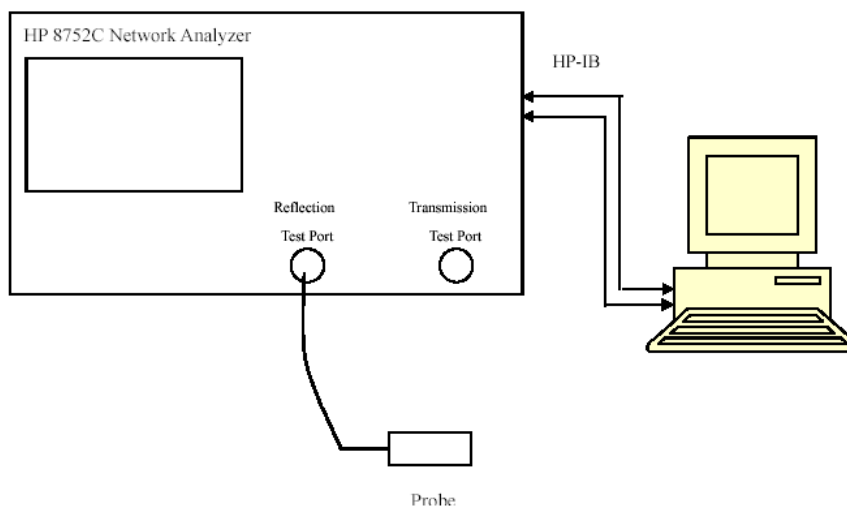

Liquid Verification Setup Block Diagram

## Liquid Verification Results

Frequency	Liquid Type	Liquid Parameter		Target Value		Delta (%)		Tolerance (%)
		$\epsilon_r$	$\sigma$ (S/m)	$\epsilon_r$	$\sigma$ (S/m)	$\Delta\epsilon_r$	$\Delta\sigma$ (S/m)	
824.2	Head	40.48	0.92	41.5	0.90	-2.458	2.222	±5
	Body	53.74	0.99	55.2	0.97	-2.645	2.062	±5
826.4	Head	40.34	0.90	41.5	0.90	-2.795	0.000	±5
	Body	54.05	0.98	55.2	0.97	-2.083	1.031	±5
836.6	Head	40.12	0.91	41.5	0.90	-3.325	1.111	±5
	Body	53.88	0.98	55.2	0.97	-2.391	1.031	±5
846.6	Head	40.45	0.91	41.5	0.90	-2.530	1.111	±5
	Body	54.12	0.97	55.2	0.97	-1.957	0.000	±5
848.8	Head	39.87	0.91	41.5	0.90	-3.928	1.111	±5
	Body	53.41	0.98	55.2	0.97	-3.243	1.031	±5

\*Liquid Verification was performed on 2016-10-04.

Frequency	Liquid Type	Liquid Parameter		Target Value		Delta (%)		Tolerance (%)
		$\epsilon_r$	$\sigma$ (S/m)	$\epsilon_r$	$\sigma$ (S/m)	$\Delta\epsilon_r$	$\Delta\sigma$ (S/m)	
1850.2	Head	38.88	1.41	40.00	1.40	-2.800	0.714	±5
	Body	52.01	1.53	53.30	1.52	-2.420	0.658	±5
1852.4	Head	38.23	1.41	40.00	1.40	-4.425	0.714	±5
	Body	51.82	1.52	53.30	1.52	-2.777	0.000	±5
1880.0	Head	38.71	1.42	40.00	1.40	-3.225	1.429	±5
	Body	51.65	1.53	53.30	1.52	-3.096	0.658	±5
1907.6	Head	38.63	1.4	40.00	1.40	-3.425	0.000	±5
	Body	52.18	1.53	53.30	1.52	-2.101	0.658	±5
1909.8	Head	38.96	1.42	40.00	1.40	-2.600	1.429	±5
	Body	51.64	1.53	53.30	1.52	-3.114	0.658	±5

\*Liquid Verification was performed on 2016-10-05.

### System Accuracy Verification

Prior to the assessment, the system validation kit was used to test whether the system was operating within its specifications of  $\pm 10\%$ . The validation results are tabulated below. And also the corresponding SAR plot is attached as well in the SAR plots files.

### System Verification Setup Block Diagram

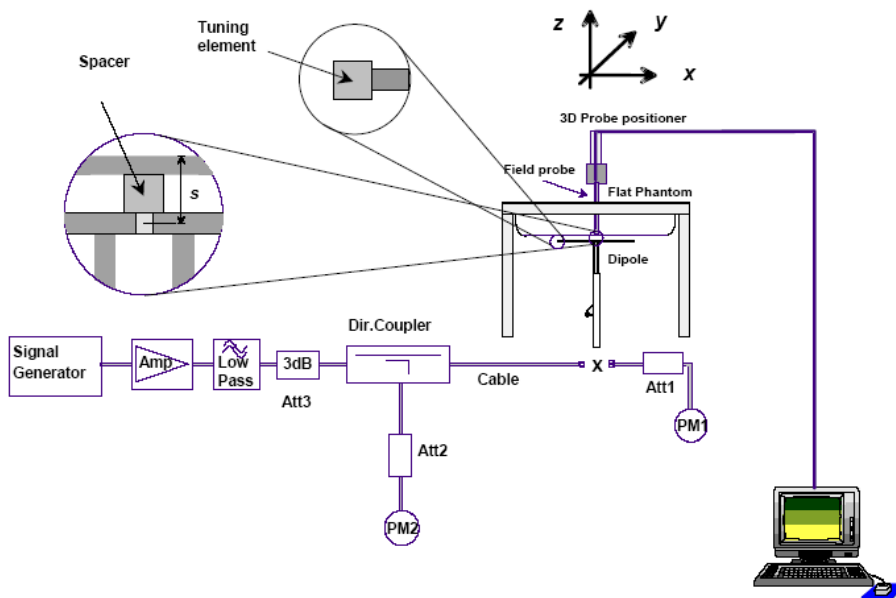

### System Accuracy Check Results

Date	Frequency Band	Liquid Type	Measured SAR (W/Kg)		Target Value (W/Kg)	Delta (%)	Tolerance (%)
2016-10-04	835	Head	1g-SAR	10.304	9.773	5.433	$\pm 10$
		Body	1g-SAR	10.348	9.736	6.286	$\pm 10$
2016-10-05	1900	Head	1g-SAR	41.140	39.481	4.202	$\pm 10$
		Body	1g-SAR	40.700	39.715	2.480	$\pm 10$

\*All SAR values are normalized to 1 Watt forward power.

**SAR SYSTEM VALIDATION DATA****Test Laboratory: Bay Area Compliance Lab Corp. (Shenzhen)****System Performance Check 835 MHz Head Liquid****Dipole 835 MHz; Type: ALS-D-835-S-2; S/N: 180-00558**

## Product Data

Device Name : Dipole 835 MHz  
Serial No. : 180-00558  
Type : Dipole  
Model : ALS-D-835-S-2  
Frequency Band : 835  
Max. Transmit Pwr : 0.25 W  
Drift Time : 3 min(s)  
Power Drift-Start : 2.114 W/kg  
Power Drift-Finish : 2.103 W/kg  
Power Drift (%) : -0.521

## Phantom Data

Name : APREL-Uni  
Type : Uni-Phantom  
Serial No. : System Default  
Location : Center  
Description : Default  
Phantom Data

## Tissue Data

Type : Head  
Serial No. : 270-01002  
Frequency : 835.0 MHz  
Last Calib. Date : 04-Oct-2016  
Temperature : 20.00 °C  
Ambient Temp. : 21.00 °C  
Humidity : 56.00 RH%  
Epsilon : 40.22 F/m  
Sigma : 0.91 S/m  
Density : 1000.00 kg/cu. m

## Probe Data

Name : E-Field  
Model : E-020  
Type : E-Field Triangle  
Serial No. : 500-00283  
Last Calib. Date : 14-Dec-2015  
Frequency Band : 835  
Duty Cycle Factor : 1  
Conversion Factor : 5.9  
Probe Sensitivity : 1.20 1.20 1.20  $\mu\text{V}/(\text{V}/\text{m})^2$   
Compression Point : 95.00 mV  
Offset : 1.56 mm

## Measurement Data

Crest Factor : 1  
Scan Type : Complete  
Tissue Temp. : 21.00 °C  
Ambient Temp. : 21.00 °C  
Area Scan : 8x13x1 : Measurement x=10mm, y=10mm, z=4mm  
Zoom Scan : 7x7x7 : Measurement x=5mm, y=5mm, z=5mm

1 gram SAR value : 2.576 W/kg  
10 gram SAR value : 1.512 W/kg  
Area Scan Peak SAR : 2.557 W/kg  
Zoom Scan Peak SAR : 3.574 W/kg

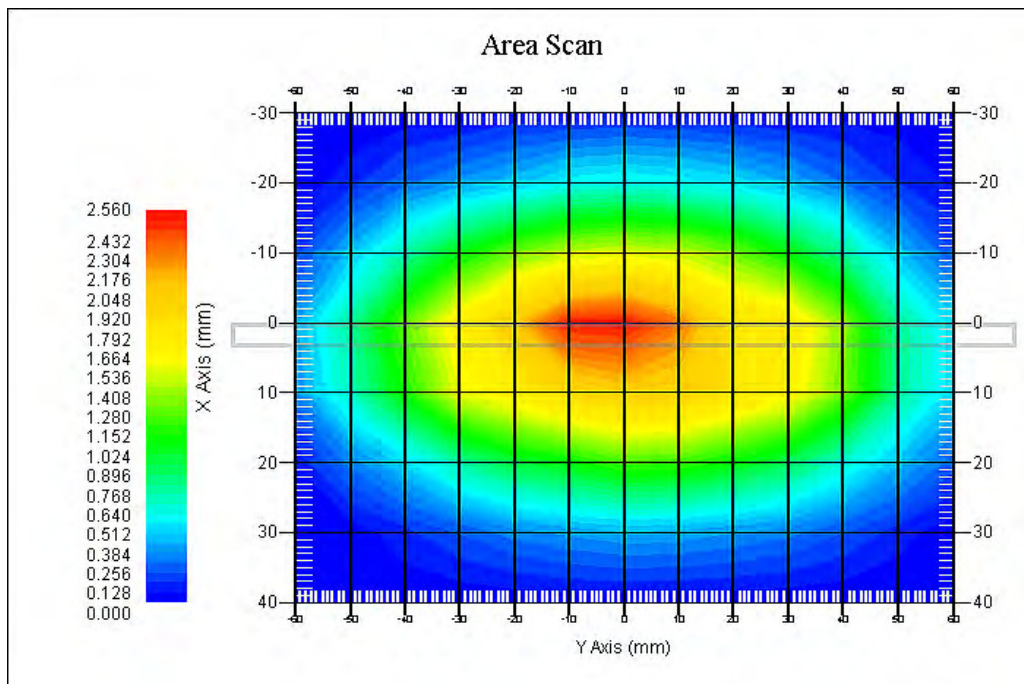

**835 MHz System Validation with Head Tissue**

**Test Laboratory: Bay Area Compliance Lab Corp. (Shenzhen)****System Performance Check 835 MHz Body Liquid****Dipole 835 MHz; Type: ALS-D-835-S-2; S/N: 180-00558**

## Product Data

Device Name : Dipole 835 MHz  
Serial No. : 180-00558  
Type : Dipole  
Model : ALS-D-835-S-2  
Frequency Band : 835  
Max. Transmit Pwr : 0.25W  
Drift Time : 3 min(s)  
Power Drift-Start : 2.204 W/kg  
Power Drift-Finish : 2.267 W/kg  
Power Drift (%) : 2.865

## Phantom Data

Name : APREL-Uni  
Type : Uni-Phantom  
Serial No. : System Default  
Location : Center  
Description : Default  
Phantom Data

## Tissue Data

Type : Body  
Serial No. : 270-02101  
Frequency : 835.0 MHz  
Last Calib. Date : 04-Oct-2016  
Temperature : 20.00 °C  
Ambient Temp. : 21.00 °C  
Humidity : 56.00 RH%  
Epsilon : 53.98 F/m  
Sigma : 0.98 S/m  
Density : 1000.00 kg/cu. m

## Probe Data

Name : E-Field  
Model : E-020  
Type : E-Field Triangle  
Serial No. : 500-00283  
Last Calib. Date : 14-Dec-2015  
Frequency Band : 835  
Duty Cycle Factor : 1  
Conversion Factor : 5.9  
Probe Sensitivity : 1.20 1.20 1.20  $\mu\text{V}/(\text{V}/\text{m})^2$   
Compression Point : 95.00 mV  
Offset : 1.56 mm

## Measurement Data

Crest Factor : 1  
Scan Type : Complete  
Tissue Temp. : 21.00 °C  
Ambient Temp. : 21.00 °C  
Area Scan : 8x13x1 : Measurement x=10mm, y=10mm, z=4mm  
Zoom Scan : 7x7x7 : Measurement x=5mm, y=5mm, z=5mm

1 gram SAR value : 2.587 W/kg  
10 gram SAR value : 1.539 W/kg  
Area Scan Peak SAR : 2.677 W/kg  
Zoom Scan Peak SAR : 3.612 W/kg

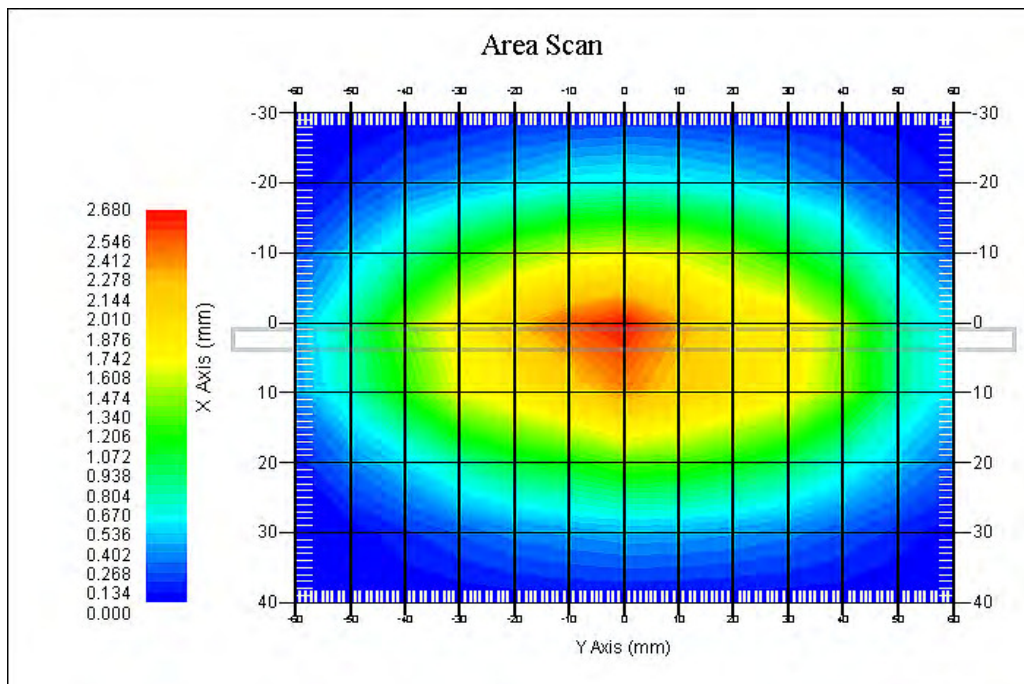

**835 MHz System Validation with Body Tissue**



**Test Laboratory: Bay Area Compliance Lab Corp. (Shenzhen)****System Performance Check 1900 MHz Head Liquid****Dipole 1900 MHz; Type: ALS-D-1900-S-2; S/N: 210-00710**

## Product Data

Device Name : Dipole 1900MHz  
Serial No. : 210-00710  
Type : Dipole  
Model : ALS-D-1900-S-2  
Frequency Band : 1900  
Max. Transmit Pwr : 0.25W  
Drift Time : 3 min(s)  
Power Drift-Start : 9.528W/kg  
Power Drift-Finish : 9.502 W/kg  
Power Drift (%) : -2.723

## Phantom Data

Name : APREL-Uni  
Type : Uni-Phantom  
Serial No. : System Default  
Location : Center  
Description : Default

## Tissue Data

Type : Head  
Serial No. : 295-01103  
Frequency : 1900.00 MHz  
Last Calib. Date : 05-Oct-2016  
Temperature : 20.00 °C  
Ambient Temp. : 21.00 °C  
Humidity : 56.00 RH%  
Epsilon : 38.68 F/m  
Sigma : 1.41 S/m  
Density : 1000.00 kg/cu. M

## Probe Data

Name : E-Field  
Model : E-020  
Type : E-Field Triangle  
Serial No. : 500-00283  
Last Calib. Date : 14-Dec-2015  
Frequency Band : 1900  
Duty Cycle Factor : 1  
Conversion Factor : 4.8  
Probe Sensitivity : 1.20 1.20 1.20  $\mu\text{V}/(\text{V}/\text{m})^2$   
Compression Point : 95.00 mV  
Offset : 1.56 mm

## Measurement Data

Crest Factor : 1  
Scan Type : Complete  
Tissue Temp. : 21.00 °C  
Ambient Temp. : 20.00 °C  
Area Scan : 8x11x1 : Measurement x=10mm, y=10mm, z=4mm  
Zoom Scan : 7x7x7 : Measurement x=5mm, y=5mm, z=5mm

1 gram SAR value : 10.285 W/kg  
10 gram SAR value : 4.997 W/kg  
Area Scan Peak SAR : 10.437 W/kg  
Zoom Scan Peak SAR : 14.598 W/kg

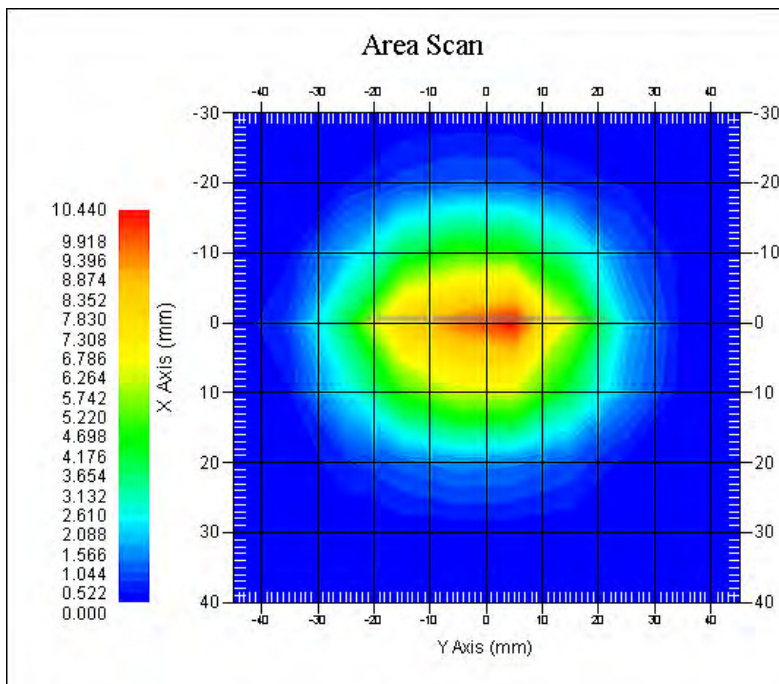

**1900 MHz System Validation with Head Tissue**

**Test Laboratory: Bay Area Compliance Lab Corp. (Shenzhen)****System Performance Check 1900 MHz Body Liquid****Dipole 1900 MHz; Type: ALS-D-1900-S-2; S/N: 210-00710**

## Product Data

Device Name : Dipole 1900MHz  
Serial No. : 210-00710  
Type : Dipole  
Model : ALS-D-1900-S-2  
Frequency Band : 1900  
Max. Transmit Pwr : 0.25W  
Drift Time : 3 min(s)  
Power Drift-Start : 8.995 W/kg  
Power Drift-Finish : 9.012 W/kg  
Power Drift (%) : 1.889

## Phantom Data

Name : APREL-Uni  
Type : Uni-Phantom  
Serial No. : System Default  
Location : Center  
Description : Default

## Tissue Data

Type : Body  
Serial No. : 295-02102  
Frequency : 1900.00 MHz  
Last Calib. Date : 05-Oct-2016  
Temperature : 20.00 °C  
Ambient Temp. : 21.00 °C  
Humidity : 56.00 RH%  
Epsilon : 51.86 F/m  
Sigma : 1.53 S/m  
Density : 1000.00 kg/cu. m

## Probe Data

Name : E-Field  
Model : E-020  
Type : E-Field Triangle  
Serial No. : 500-00283  
Last Calib. Date : 14-Dec-2015  
Frequency Band : 1900  
Duty Cycle Factor : 1  
Conversion Factor : 4.8  
Probe Sensitivity : 1.20 1.20 1.20  $\mu\text{V}/(\text{V}/\text{m})^2$   
Compression Point : 95.00 mV  
Offset : 1.56 mm

## Measurement Data

Crest Factor : 1  
Scan Type : Complete  
Tissue Temp. : 20.00 °C  
Ambient Temp. : 21.00 °C  
Area Scan : 8x11x1 : Measurement x=10mm, y=10mm, z=4mm  
Zoom Scan : 7x7x7 : Measurement x=5mm, y=5mm, z=5mm

1 gram SAR value : 10.175W/kg  
10 gram SAR value : 4.912 W/kg  
Area Scan Peak SAR : 10.239 W/kg  
Zoom Scan Peak SAR : 14.663 W/kg

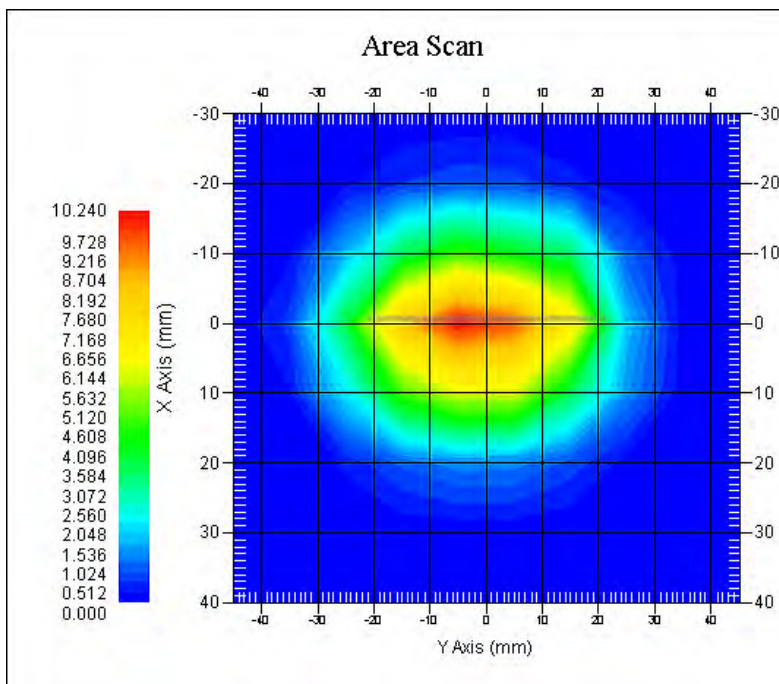

**1900 MHz System Validation with Body Tissue**

## EUT TEST STRATEGY AND METHODOLOGY

### Test Positions for Device Operating Next to a Person’s Ear

This category includes most wireless handsets with fixed, retractable or internal antennas located toward the top half of the device, with or without a foldout, sliding or similar keypad cover. The handset should have its earpiece located within the upper ¼ of the device, either along the centerline or off-centered, as perceived by its users. This type of handset should be positioned in a normal operating position with the “test device reference point” located along the “vertical centerline” on the front of the device aligned to the “ear reference point”. The “test device reference point” should be located at the same level as the center of the earpiece region. The “vertical centerline” should bisect the front surface of the handset at its top and bottom edges. A “ear reference point” is located on the outer surface of the head phantom on each ear spacer. It is located 1.5 cm above the center of the ear canal entrance in the “phantom reference plane” defined by the three lines joining the center of each “ear reference point” (left and right) and the tip of the mouth.

A handset should be initially positioned with the earpiece region pressed against the ear spacer of a head phantom. For the SCC-34/SC-2 head phantom, the device should be positioned parallel to the “N-F” line defined along the base of the ear spacer that contains the “ear reference point”. For interim head phantoms, the device should be positioned parallel to the cheek for maximum RF energy coupling. The “test device reference point” is aligned to the “ear reference point” on the head phantom and the “vertical centerline” is aligned to the “phantom reference plane”. This is called the “initial ear position”. While maintaining these three alignments, the body of the handset is gradually adjusted to each of the following positions for evaluating SAR:

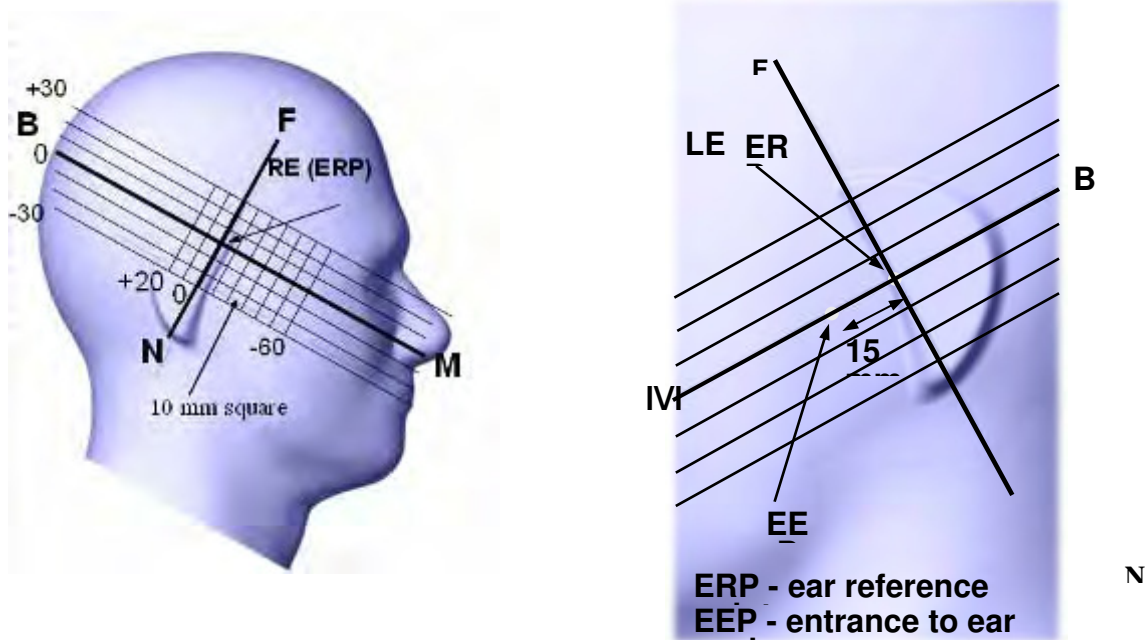

## Cheek/Touch Position

The device is brought toward the mouth of the head phantom by pivoting against the “ear reference point” or along the “N-F” line for the SCC-34/SC-2 head phantom.

This test position is established:

- When any point on the display, keypad or mouthpiece portions of the handset is in contact with the phantom.
- (or) When any portion of a foldout, sliding or similar keypad cover opened to its intended self-adjusting normal use position is in contact with the cheek or mouth of the phantom.

For existing head phantoms – when the handset loses contact with the phantom at the pivoting point, rotation should continue until the device touches the cheek of the phantom or breaks its last contact from the ear spacer.

### Cheek /Touch Position

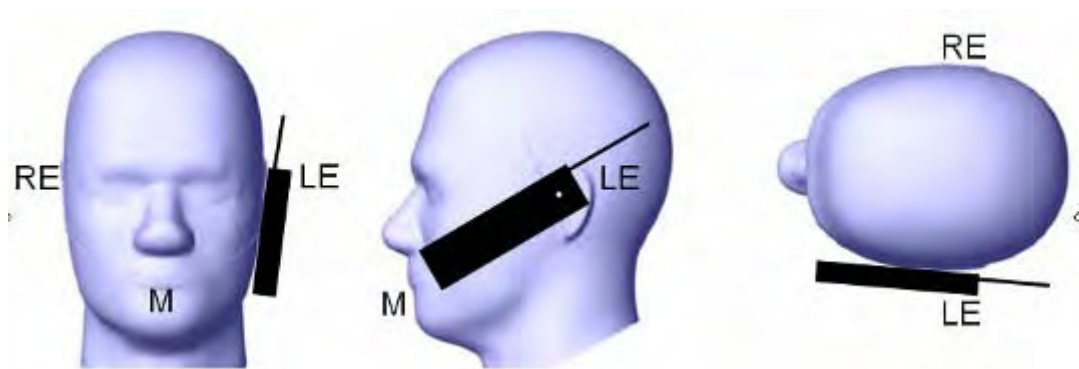

## Ear/Tilt Position

With the handset aligned in the “Cheek/Touch Position”:

1) If the earpiece of the handset is not in full contact with the phantom’s ear spacer (in the “Cheek/Touch position”) and the peak SAR location for the “Cheek/Touch” position is located at the ear spacer region or corresponds to the earpiece region of the handset, the device should be returned to the “initial ear position” by rotating it away from the mouth until the earpiece is in full contact with the ear spacer.

2) (otherwise) The handset should be moved (translated) away from the cheek perpendicular to the line passes through both “ear reference points” (note: one of these ear reference points may not physically exist on a split head model) for approximate 2-3 cm. While it is in this position, the device handset is tilted away from the mouth with respect to the “test device reference point” until the inside angle between the vertical centerline on the front surface of the phone and the horizontal line passing through the ear reference point is by 15 80°. After the tilt, it is then moved (translated) back toward the head perpendicular to the line passes through both “ear reference points” until the device touches the phantom or the ear spacer. If the antenna touches the head first, the positioning process should be repeated with a tilt angle less than 15° so that the device and its antenna would touch the phantom simultaneously. This test position may require a device holder or positioner to achieve the translation and tilting with acceptable positioning repeatability.

If a device is also designed to transmit with its keypad cover closed for operating in the head position, such positions should also be considered in the SAR evaluation. The device should be tested on the left and right side of the head phantom in the “Cheek/Touch” and “Ear/Tilt” positions. When applicable, each configuration should be tested with the antenna in its fully extended and fully retracted positions. These test configurations should be tested at the high, middle and low frequency channels of each operating mode; for example, AMPS, CDMA, and TDMA. If the SAR measured at the middle channel for each test configuration (left, right, Cheek/Touch, Tilt/Ear, extended and retracted) is at least 2.0 dB lower than the SAR limit, testing at the high and low channels is optional for such test configuration(s). If the transmission band of the test device is less than 10 MHz, testing at the high and low frequency channels is optional.

**Ear /Tilt 15° Position**

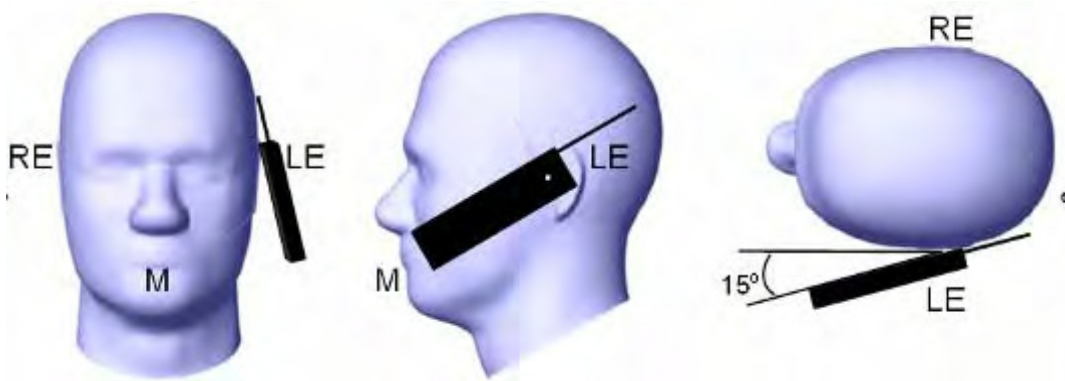

**Test positions for body-worn and other configurations**

Body-worn operating configurations should be tested with the belt-clips and holsters attached to the device and positioned against a flat phantom in normal use configurations. Devices with a headset output should be tested with a headset connected to the device. When multiple accessories that do not contain metallic components are supplied with the device, the device may be tested with only the accessory that dictates the closest spacing to the body. When multiple accessories that contain metallic components are supplied with the device, the device must be tested with each accessory that contains a unique metallic component. If multiple accessories share an identical metallic component (e.g., the same metallic belt-clip used with different holsters with no other metallic components), only the accessory that dictates the closest spacing to the body must be tested.

Body-worn accessories may not always be supplied or available as options for some devices that are intended to be authorized for body-worn use. A separation distance of 1.5 cm between the back of the device and a flat phantom is recommended for testing body-worn SAR compliance under such circumstances. Other separation distances may be used, but they should not exceed 2.5 cm. In these cases, the device may use body-worn accessories that provide a separation distance greater than that tested for the device provided however that the accessory contains no metallic components.

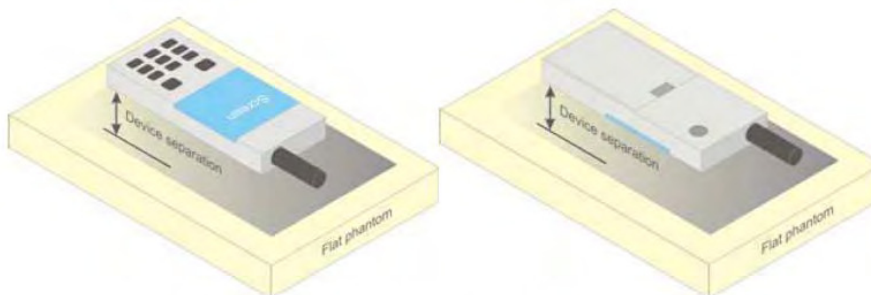

**Figure 5 – Test positions for body-worn devices**

## SAR Evaluation Procedure

The evaluation was performed with the following procedure:

Step 1: Measurement of the SAR value at a fixed location above the ear point or central position was used as a reference value for assessing the power drop. The SAR at this point is measured at the start of the test and then again at the end of the testing.

Step 2: The SAR distribution at the exposed side of the head was measured at a distance of 4 mm from the inner surface of the shell. The area covered the entire dimension of the head or EUT and the horizontal grid spacing was 10 mm x 10 mm. Based on these data, the area of the maximum absorption was determined by spline interpolation. The first Area Scan covers the entire dimension of the EUT to ensure that the hotspot was correctly identified.

Step 3: Around this point, a volume of 30 mm x 30 mm x 30 mm was assessed by measuring 7x 7 x 7 points. On the basis of this data set, the spatial peak SAR value was evaluated under the following procedure:

- 1) The data at the surface were extrapolated, since the center of the dipoles is 1.2 mm away from the tip of the probe and the distance between the surface and the lowest measuring point is 1.3 mm. The extrapolation was based on a least square algorithm. A polynomial of the fourth order was calculated through the points in z-axes. This polynomial was then used to evaluate the points between the surface and the probe tip.
- 2) The maximum interpolated value was searched with a straightforward algorithm. Around this maximum the SAR values averaged over the spatial volumes (1 g or 10 g) were computed by the 3D-Spline interpolation algorithm. The 3D-Spline is composed of three one dimensional splines with the "Not a knot"-condition (in x, y and z-directions). The volume was integrated with the trapezoidal-algorithm. One thousand points (10 x 10 x 10) were interpolated to calculate the averages.

All neighboring volumes were evaluated until no neighboring volume with a higher average value was found.

Step 4: Re-measurement of the SAR value at the same location as in Step 1. If the value changed by more than 5%, the evaluation was repeated.

## Test methodology

KDB 447498 D01.  
KDB 648474 D04  
KDB 865664 D01  
KDB 941225 D01  
KDB 941225 D06



## CONDUCTED OUTPUT POWER MEASUREMENT

### Provision Applicable

The measured peak output power should be greater and within 5% than EMI measurement.

### Test Procedure

The RF output of the transmitter was connected to the input of the EMI Test Receiver through sufficient attenuation.

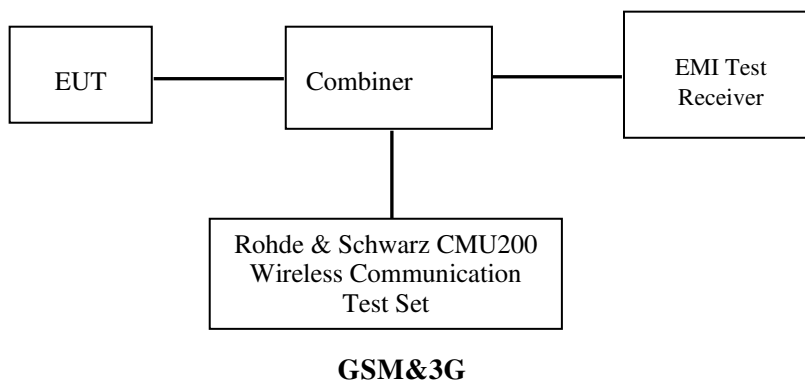

### Radio Configuration

The power measurement was configured by the Wireless Communication Test Set CMU200 & CMW500 for all Radio configurations.

#### GSM

Function: Menu select > GSM Mobile Station > GSM 850/1900

Press Connection control to choose the different menus

Press RESET > choose all the reset all settings

Connection: Press Signal Off to turn off the signal and change settings

Network Support > GSM + only

MS Signal

> 33 dBm for GSM 850

> 30 dBm for PCS 1900

BS Signal: Enter the same channel number for TCH channel (test channel) and BCCH channel

Frequency Offset > + 0 Hz

Mode > BCCH and TCH

BCCH Level > -85 dBm (May need to adjust if link is not stable)

BCCH Channel > choose desired test channel [Enter the same channel number for TCH channel (test channel) and BCCH channel]

Channel Type > Off

P0 > 4 dB

TCH > choose desired test channel

Hopping > Off

AF/RF: Enter appropriate offsets for Ext. Att. Output and Ext. Att. Input

Connection: Press Signal on to turn on the signal and change settings

**GPRS**

Function: Menu select > GSM Mobile Station > GSM 850/1900  
 Press Connection control to choose the different menus  
 Press RESET > choose all the reset all settings  
 Connection: Press Signal Off to turn off the signal and change settings  
 Network Support > GSM + GPRS or GSM + EGSM  
 Main Service > Packet Data

Service selection > Test Mode A – Auto Slot Config. off  
 MS Signal: Press Slot Config Bottom on the right twice to select and change the number of time slots and power setting  
     > Slot configuration > Uplink/Gamma  
     > 33 dBm for GPRS 850  
     > 30 dBm for GPRS 1900

BS Signal: Enter the same channel number for TCH channel (test channel) and BCCH channel  
 Frequency Offset >+ 0 Hz  
 Mode >BCCH and TCH  
 BCCH Level >-85 dBm (May need to adjust if link is not stable)  
 BCCH Channel > choose desire test channel [Enter the same channel number for TCH channel (test channel) and BCCH channel]

Channel Type > Off  
 P0 > 4 dB  
 Slot Config > Unchanged (if already set under MS signal)  
 TCH > choose desired test channel  
 Hopping >Off  
 Main Timeslot >3  
 Network: Coding Scheme >CS4 (GPRS)  
     Bit Stream >2E9-1 PSR Bit Stream  
 AF/RF: Enter appropriate offsets for Ext. Att. Output and Ext. Att. Input  
 Connection: Press Signal on to turn on the signal and change settings

**WCDMA Release 99**

The following tests were conducted according to the test requirements outlines in section 5.2 of the 3GPP TS34.121-1 specification. The EUT has a nominal maximum output power of 24dBm (+1.7/-3.7).

<b>WCDMA General Settings</b>	Loopback Mode	Test Mode 1
	Rel99 RMC	12.2kbps RMC
	Power Control Algorithm	Algorithm2
	$\beta c / \beta d$	8/15

**HSDPA**

The following tests were conducted according to the test requirements outlines in section 5.2 of the 3GPP TS34.121-1 specification.

	Mode	HSDPA	HSDPA	HSDPA	HSDPA
	Subset	1	2	3	4
WCDMA General Settings	Loopback Mode	Test Mode 1			
	Rel99 RMC	12.2kbps RMC			
	HSDPA FRC	H-Set1			
	Power Control Algorithm	Algorithm2			
	$\beta c$	2/15	12/15	15/15	15/15
	$\beta d$	15/15	15/15	8/15	4/15
	$\beta d$ (SF)	64			
	$\beta c / \beta d$	2/15	12/15	15/8	15/4
	$\beta hs$	4/15	24/15	30/15	30/15
MPR(dB)	0	0	0.5	0.5	
HSDPA Specific Settings	DACK	8			
	DNAK	8			
	DCQI	8			
	Ack-Nack repetition factor	3			
	CQI Feedback	4ms			
	CQI Repetition Factor	2			
	$Ahs = \beta hs / \beta c$	30/15			

**HSUPA**

The following tests were conducted according to the test requirements outlines in section 5.2 of the 3GPP TS34.121-1 specification.

	<b>Mode</b>	<b>HSUPA</b>	<b>HSUPA</b>	<b>HSUPA</b>	<b>HSUPA</b>	<b>HSUPA</b>
	<b>Subset</b>	<b>1</b>	<b>2</b>	<b>3</b>	<b>4</b>	<b>5</b>
<b>WCDMA A General Settings</b>	Loopback Mode	Test Mode 1				
	Rel99 RMC	12.2kbps RMC				
	HSDPA FRC	H-Set1				
	HSUPA Test	HSUPA Loopback				
	Power Control Algorithm	Algorithm2				
	$\beta c$	11/15	6/15	15/15	2/15	15/15
	$\beta d$	15/15	15/15	9/15	15/15	0
	$\beta ec$	209/225	12/15	30/15	2/15	5/15
	$\beta c/ \beta d$	11/15	6/15	15/9	2/15	-
	$\beta hs$	22/15	12/15	30/15	4/15	5/15
	CM(dB)	1.0	3.0	2.0	3.0	1.0
MPR(dB)	0	2	1	2	0	
<b>HSDPA Specific Settings</b>	DACK	8				
	DNAK	8				
	DCQI	8				
	Ack-Nack repetition factor	3				
	CQI Feedback	4ms				
	CQI Repetition Factor	2				
	$Ahs = \beta hs / \beta c$	30/15				
<b>HSUPA Specific Settings</b>	DE-DPCCH	6	8	8	5	7
	DHARQ	0	0	0	0	0
	AG Index	20	12	15	17	21
	ETFCI	75	67	92	71	81
	Associated Max UL Data Rate kbps	242.1	174.9	482.8	205.8	308.9
	Reference E_FCI	E-TFCI 11 E E-TFCI PO 4 E-TFCI 67 E-TFCI PO 18 E-TFCI 71 E-TFCI PO23 E-TFCI 75 E-TFCI PO26 E-TFCI 81 E-TFCI PO 27	E-TFCI 11 E-TFCI PO4 E-TFCI 92 E-TFCI PO 18	E-TFCI 11 E-TFCI PO4 E-TFCI 92 E-TFCI PO 18	E-TFCI 11 E E-TFCI PO 4 E-TFCI 67 E-TFCI PO 18 E-TFCI 71 E-TFCI PO23 E-TFCI 75 E-TFCI PO26 E-TFCI 81 E-TFCI PO 27	

**Wi-Fi**

For 802.11b, 802.11g and 802.11n-HT20 mode, 13 channels are provided to testing:

<b>Channel</b>	<b>Frequency (MHz)</b>	<b>Channel</b>	<b>Frequency (MHz)</b>
1	2412	8	2447
2	2417	9	2452
3	2422	10	2457
4	2427	11	2462
5	2432	12	2467
6	2437	13	2472
7	2442	/	/

For 802.11b, 802.11g, 802.11n-HT20 mode, EUT was tested with Channel 1, 7 and 13.

**Maximum Output Power among production units**

<b>Max Target Power for Production Unit (dBm)</b>			
<b>Mode/Band</b>	<b>Channel</b>		
	<b>Low</b>	<b>Middle</b>	<b>High</b>
GSM 850	33.20	33.20	33.20
GPRS 1 TX Slot	33.20	33.20	33.20
GPRS 2 TX Slot	30.80	30.80	30.80
GPRS 3 TX Slot	29.60	29.60	29.60
GPRS 4 TX Slot	27.00	27.00	27.00
PCS 1900	29.70	29.70	29.70
GPRS 1 TX Slot	29.80	29.80	29.80
GPRS 2 TX Slot	27.10	27.10	27.10
GPRS 3 TX Slot	25.60	25.60	25.60
GPRS 4 TX Slot	23.60	23.60	23.60
WCDMA 850	RMC	22.70	22.70
	HSDPA	21.50	21.50
	HSUPA	21.50	21.50
WCDMA 1900	RMC	22.00	22.00
	HSDPA	20.70	20.70
	HSUPA	20.70	20.70
Wi-Fi(b/g/n20)	9.70	9.70	9.70
Bluetooth	7.90	7.90	7.90

**Test Results:**

**GSM:**

Band	Channel No.	Frequency (MHz)	Conducted Output Power	
			Meas. Power (dBm)	Meas. Power (W)
GSM 850	128	824.2	33.12	2.051
	190	836.6	33.07	2.028
	251	848.8	<b>33.18</b>	2.080
PCS 1900	512	1850.2	<b>29.66</b>	0.925
	661	1880.0	29.63	0.918
	810	1909.8	29.58	0.908

**GPRS:**

Band	Channel No.	Frequency (MHz)	RF Output Power (dBm)			
			1 slot	2 slot	3 slots	4 slots
GSM 850	128	824.2	33.20	30.67	29.52	27.00
	190	836.6	33.18	30.80	29.47	26.98
	251	848.8	33.16	30.60	29.50	26.95
PCS 1900	512	1850.2	29.59	26.92	25.58	23.58
	661	1880.0	29.70	27.05	25.55	23.45
	810	1909.8	29.69	26.97	25.37	23.52

For SAR, the time based average power is relevant, the difference in between depends on the duty cycle of the TDMA signal.

Number of Time slot	1	2	3	4
Duty Cycle	1:8	1:4	1:2.66	1:2
Time based Ave. power compared to slotted Ave. power	-9 dB	-6 dB	-4.25 dB	-3 dB
Crest Factor	8	4	2.66	2

**The time based average power for GPRS**

Band	Channel No.	Frequency (MHz)	Time based average Power (dBm)			
			1 slot	2 slot	3 slots	4 slots
GSM 850	128	824.2	24.20	24.67	<b>25.27</b>	24.00
	190	836.6	24.18	24.80	25.22	23.98
	251	848.8	24.16	24.60	25.25	23.95
PCS 1900	512	1850.2	20.59	20.92	<b>21.33</b>	20.58
	661	1880.0	20.70	21.05	21.30	20.45
	810	1909.8	20.69	20.97	21.12	20.52

**Note:**

1. Rohde & Schwarz Radio Communication Tester (CMU200) was used for the measurement of GSM peak and average output power for active timeslots.
2. For GSM voice, 1 timeslot has been activated with power level 5 (850 MHz band) and 0 (1900 MHz band).
3. For GPRS, 1, 2, 3 and 4 timeslots has been activated separately with power level 3(850 MHz band) and 3(1900 MHz band).
4. For EGPRS, 1, 2, 3 and 4 timeslots has been activated separately with power level 6(850 MHz band) and 5(1900 MHz band).

**WCDMA 850**

Test Condition	Test Mode	3GPP Sub Test	Averaged Mean Power (dBm)		
			Low Frequency	Mid Frequency	High Frequency
Normal	RMC12.2k		22.67	22.20	21.86
	HSDPA	1	21.45	21.03	20.45
		2	21.23	20.88	20.32
		3	21.50	20.90	20.64
		4	21.20	20.87	20.11
	HSUPA	1	21.35	20.79	20.65
		2	21.17	20.89	20.23
		3	21.30	21.05	20.44
		4	21.43	21.00	20.40
		5	21.32	21.17	20.67

**WCDMA 1900**

Test Condition	Test Mode	3GPP Sub Test	Averaged Mean Power (dBm)		
			Low Frequency	Mid Frequency	High Frequency
Normal	RMC12.2k		21.99	21.83	21.90
	HSDPA	1	20.66	20.52	20.46
		2	20.70	20.51	20.20
		3	20.68	20.54	20.66
		4	20.66	20.26	20.59
	HSUPA	1	20.54	20.35	20.41
		2	20.65	20.37	20.65
		3	20.70	20.58	20.67
		4	20.70	20.46	20.70
		5	20.60	20.59	20.68

**Note:**

1. The default test configuration is to measure SAR with an established radio link between the EUT and a communication test set using a 12.2 kbps RMC (reference measurement Channel) Configured in Test Loop Model 1.
2. KDB 941225 D01-Body SAR is not required for HSDPA/HSUPA when the maximum average output of each RF channel is less than ¼ dB higher than measured 12.2kbps RMC or the maximum SAR for 12.2kbps RMC is < 75% of SAR limit.



**Bluetooth**

Mode	Frequency (MHz)	Conducted Output Power	
		(dBm)	(mw)
BDR(GFSK)	2402	6.92	4.920
	2441	6.46	4.426
	2480	7.31	5.383
EDR(4-DQPSK)	2402	6.27	4.236
	2441	7.15	5.188
	2480	7.58	5.728
EDR-8DPSK	2402	7.01	5.023
	2441	7.49	5.610
	2480	<b>7.88</b>	6.138

**Wi-Fi**

Band	Channel No.	Frequency (MHz)	Conducted Output Power	
			(dBm)	(mw)
802.11b	1	2412	9.47	8.851
	7	2442	9.36	8.630
	13	2472	<b>9.62</b>	9.162
802.11g	1	2412	8.14	6.516
	7	2442	8.12	6.486
	13	2472	8.33	6.808
802.11n HT20	1	2412	8.27	6.714
	7	2442	7.89	6.152
	13	2472	8.61	7.261

**Note:**

1. The output power was tested under data rate 1Mbps for 802.11b, 6Mbps for 802.11g, 6.5Mbps for 802.11n HT20.

## SAR MEASUREMENT RESULTS

This page summarizes the results of the performed dosimetric evaluation.

### SAR Test Data

#### Environmental Conditions

<b>Temperature:</b>	21-24 °C
<b>Relative Humidity:</b>	50-53 %
<b>ATM Pressure:</b>	1001-1002 mbar

Testing was performed by Hans Zhao and Lance Li on 2016-10-04 to 2016-10-05.

#### GSM 850:

EUT Position	Frequency (MHz)	Test Mode	Power Drift (%)	Max. Meas. Power (dBm)	Max. Rated Power (dBm)	1g SAR (W/Kg)			
						Scaled Factor	Meas. SAR	Scaled SAR	Plot
Left Head Cheek	824.2	GSM	-0.954	33.12	33.2	1.019	0.386	0.393	1#
	836.6	GSM	-1.454	33.07	33.2	1.030	0.418	0.431	2#
	848.8	GSM	-1.889	33.18	33.2	1.005	0.462	<b>0.464</b>	<b>3#</b>
Left Head Tilt	824.2	GSM	/	/	/	/	/	/	/
	836.6	GSM	0.767	33.07	33.2	1.030	0.198	0.204	4#
	848.8	GSM	/	/	/	/	/	/	/
Right Head Cheek	824.2	GSM	/	/	/	/	/	/	/
	836.6	GSM	-0.632	33.07	33.2	1.030	0.373	0.384	5#
	848.8	GSM	/	/	/	/	/	/	/
Right Head Tilt	824.2	GSM	/	/	/	/	/	/	/
	836.6	GSM	1.961	33.07	33.2	1.030	0.186	0.192	6#
	848.8	GSM	/	/	/	/	/	/	/

#### Note:

1. When the 1-g SAR is  $\leq 0.8\text{W/Kg}$ , testing for other channels are optional.
2. The EUT transmit and receive through the same GSM antenna while testing SAR.
3. When SAR or MPE is not measured at the maximum power level allowed for production units, the results must be scaled to the maximum tune-up tolerance limit according to the power applied to the individual channels tested to determine compliance.

**PCS Band:**

EUT Position	Frequency (MHz)	Test Mode	Power Drift (%)	Max. Meas. Power (dBm)	Max. Rated Power (dBm)	1g SAR (W/Kg)			
						Scaled Factor	Meas. SAR	Scaled SAR	Plot
Left Head Cheek	1850.2	GSM	/	/	/	/	/	/	/
	1880.0	GSM	-1.369	29.63	29.7	1.016	0.256	0.260	7#
	1909.8	GSM	/	/	/	/	/	/	/
Left Head Tilt	1850.2	GSM	/	/	/	/	/	/	/
	1880.0	GSM	2.858	29.63	29.7	1.016	0.166	0.169	8#
	1909.8	GSM	/	/	/	/	/	/	/
Right Head Cheek	1850.2	GSM	-2.936	29.66	29.7	1.009	0.255	0.257	9#
	1880.0	GSM	2.524	29.63	29.7	1.016	0.287	<b>0.292</b>	<b>10#</b>
	1909.8	GSM	-1.043	29.58	29.7	1.028	0.264	0.271	11#
Right Head Tilt	1850.2	GSM	/	/	/	/	/	/	/
	1880.0	GSM	-1.332	29.63	29.7	1.016	0.142	0.144	12#
	1909.8	GSM	/	/	/	/	/	/	/

**Note:**

1. When the 1-g SAR is  $\leq 0.8\text{W/Kg}$ , testing for other channels are optional.
2. The EUT transmit and receive through the same GSM antenna while testing SAR.
3. When SAR or MPE is not measured at the maximum power level allowed for production units, the results must be scaled to the maximum tune-up tolerance limit according to the power applied to the individual channels tested to determine compliance.

WCDMA 835

EUT Position	Frequency (MHz)	Test Mode	Power Drift (%)	Max. Meas. Power (dBm)	Max. Rated Power (dBm)	1g SAR (W/Kg)			
						Scaled Factor	Meas. SAR	Scaled SAR	Plot
Left Head Cheek	826.4	RMC	/	/	/	/	/	/	/
	836.6	RMC	-0.957	22.2	22.7	1.122	0.255	0.286	13#
	846.6	RMC	/	/	/	/	/	/	/
Left Head Tilt	826.4	RMC	/	/	/	/	/	/	/
	836.6	RMC	0.893	22.2	22.7	1.122	0.172	0.193	14#
	846.6	RMC	/	/	/	/	/	/	/
Right Head Cheek	826.4	RMC	-1.113	22.67	22.7	1.007	0.234	0.236	15#
	836.6	RMC	-0.776	22.2	22.7	1.122	0.288	<b>0.323</b>	16#
	846.6	RMC	-2.174	21.86	22.0	1.033	0.247	0.255	17#
Right Head Tilt	826.4	RMC	/	/	/	/	/	/	/
	836.6	RMC	-1.316	22.2	22.7	1.122	0.188	0.211	18#
	846.6	RMC	/	/	/	/	/	/	/

WCDMA1900

EUT Position	Frequency (MHz)	Test Mode	Power Drift (%)	Max. Meas. Power (dBm)	Max. Rated Power (dBm)	1g SAR (W/Kg)			
						Scaled Factor	Meas. SAR	Scaled SAR	Plot
Left Head Cheek	1852.4	RMC	/	/	/	/	/	/	/
	1880.0	RMC	-1.147	21.83	22	1.040	0.343	0.357	19#
	1907.6	RMC	/	/	/	/	/	/	/
Left Head Tilt	1852.4	RMC	/	/	/	/	/	/	/
	1880.0	RMC	-0.981	21.83	22	1.040	0.194	0.202	20#
	1907.6	RMC	/	/	/	/	/	/	/
Right Head Cheek	1852.4	RMC	-2.149	21.99	22	1.002	0.354	0.355	21#
	1880.0	RMC	-1.337	21.83	22	1.040	0.402	<b>0.418</b>	22#
	1907.6	RMC	-2.003	21.9	22	1.023	0.363	0.371	23#
Right Head Tilt	1852.4	RMC	/	/	/	/	/	/	/
	1880.0	RMC	-1.163	21.83	22	1.040	0.160	0.166	24#
	1907.6	RMC	/	/	/	/	/	/	/

Note:

1. When the 1-g SAR is  $\leq 0.8W/Kg$ , testing for other channels are optional.
2. The default test configuration is to measure SAR with an established radio link between the EUT and a communication test set using a 12.2 kbps RMC (reference measurement Channel) Configured in Test Loop Model.
3. When SAR or MPE is not measured at the maximum power level allowed for production units, the results must be scaled to the maximum tune-up tolerance limit according to the power applied to the individual channels tested to determine compliance.

**Mobile Hot-Spot Test Result**

The DUT is capable of functioning as a Wi-Fi to Cellular Mobile hotspot. Additional SAR testing was performed according to KDB 941225 D06. Testing was performed with a separation of 1cm between the DUT and the flat phantom. The DUT was positioned for SAR tests with the front and back surfaces facing the phantom, and also with the edges facing the phantom in which the transmitting antenna is <2.5 cm from the edge. Each transmit band was utilized for SAR testing. The tested mode has been selected within each band that exhibits the highest time average output power.

**Hot spot-GPRS (Frequency Band: 835)**

EUT Position	Frequency (MHz)	Test Mode	Power Drift (%)	Max. Meas. Power (dBm)	Max. Rated Power (dBm)	1g SAR (W/Kg)			
						Scaled Factor	Meas. SAR	Scaled SAR	Plot
Body-Back-Headset (10mm)	824.2	GSM	/	/	/	/	/	/	/
	836.6	GSM	2.057	33.07	33.2	1.030	0.292	0.301	25#
	848.8	GSM	/	/	/	/	/	/	/
Body-Back (10mm)	824.2	GPRS	-0.695	29.52	29.6	1.019	0.615	0.627	26#
	836.6	GPRS	-1.685	29.47	29.6	1.030	0.776	<b>0.799</b>	<b>27#</b>
	848.8	GPRS	1.576	29.5	29.6	1.023	0.755	0.772	28#
Body-Left (10mm)	824.2	GPRS	/	/	/	/	/	/	/
	836.6	GPRS	1.886	29.47	29.6	1.030	0.339	0.349	29#
	848.8	GPRS	/	/	/	/	/	/	/
Body-Right (10mm)	824.2	GPRS	/	/	/	/	/	/	/
	836.6	GPRS	2.016	29.47	29.6	1.030	0.258	0.266	30#
	848.8	GPRS	/	/	/	/	/	/	/
Body-Bottom (10mm)	824.2	GPRS	/	/	/	/	/	/	/
	836.6	GPRS	-1.840	29.47	29.6	1.030	0.336	0.346	31#
	848.8	GPRS	/	/	/	/	/	/	/

**Note:**

- 1 .When the 1-g SAR is  $\leq 0.8W/Kg$ , testing for other channels are optional.
- 2.The Multi-slot Classes of EUT is Class 12 which has maximum 4 Downlink slots and 4 Uplink slots, the maximum active slots is 5, when perform the multiple slots scan, 2DL+3UL is the worst case.
3. The EUT transmit and receive through the same GSM antenna while testing SAR.
4. When SAR or MPE is not measured at the maximum power level allowed for production units, the results must be scaled to the maximum tune-up tolerance limit according to the power applied to the individual channels tested to determine compliance.

**Hot spot-GPRS (Frequency Band: 1900)**

EUT Position	Frequency (MHz)	Test Mode	Power Drift (%)	Max. Meas. Power (dBm)	Max. Rated Power (dBm)	1g SAR (W/Kg)			
						Scaled Factor	Meas. SAR	Scaled SAR	Plot
Body-Back-Headset (10mm)	1850.2	GSM	/	/	/	/	/	/	/
	1880.0	GSM	-0.654	29.63	29.7	1.016	0.301	0.306	32#
	1909.8	GSM	/	/	/	/	/	/	/
Body-Back (10mm)	1850.2	GPRS	-0.854	25.58	25.6	1.005	0.674	0.677	33#
	1880.0	GPRS	-1.583	25.55	25.6	1.012	0.724	0.733	34#
	1909.8	GPRS	-2.089	25.37	25.6	1.054	0.794	<b>0.837</b>	<b>35#</b>
Body-Left (10mm)	1850.2	GPRS	/	/	/	/	/	/	/
	1880.0	GPRS	-0.975	25.55	25.6	1.012	0.347	0.351	36#
	1909.8	GPRS	/	/	/	/	/	/	/
Body-Right (10mm)	1850.2	GPRS	/	/	/	/	/	/	/
	1880.0	GPRS	2.013	25.55	25.6	1.012	0.401	0.406	37#
	1909.8	GPRS	/	/	/	/	/	/	/
Body-Bottom (10mm)	1850.2	GPRS	/	/	/	/	/	/	/
	1880.0	GPRS	-1.587	25.55	25.6	1.012	0.354	0.358	38#
	1909.8	GPRS	/	/	/	/	/	/	/

**Note:**

1. When the 1-g SAR is  $\leq 0.8\text{W/Kg}$ , testing for other channels are optional.
2. The Multi-slot Classes of EUT is Class 12 which has maximum 4 Downlink slots and 4 Uplink slots, the maximum active slots is 5, when perform the multiple slots scan, 2DL+3UL is the worst case.
3. The EUT transmit and receive through the same GSM antenna while testing SAR.
4. When SAR or MPE is not measured at the maximum power level allowed for production units, the results must be scaled to the maximum tune-up tolerance limit according to the power applied to the individual channels tested to determine compliance.

**Hot Spot-WCDMA835**

EUT Position	Frequency (MHz)	Test Mode	Power Drift (%)	Max. Meas. Power (dBm)	Max. Rated Power (dBm)	1g SAR (W/Kg)			
						Scaled Factor	Meas. SAR	Scaled SAR	Plot
Body-Back (10mm)	826.4	RMC	-1.702	22.67	22.7	1.007	0.248	0.250	39#
	836.6	RMC	1.544	22.20	22.7	1.122	0.310	<b>0.348</b>	<b>40#</b>
	846.6	RMC	0.512	21.86	22.0	1.033	0.291	0.301	41#
Body-Left (10mm)	826.4	RMC	/	/	/	/	/	/	/
	836.6	RMC	-1.316	22.20	22.7	1.122	0.224	0.251	42#
	846.6	RMC	/	/	/	/	/	/	/
Body-Right (10mm)	826.4	RMC	/	/	/	/	/	/	/
	836.6	RMC	2.053	22.20	22.7	1.122	0.189	0.212	43#
	846.6	RMC	/	/	/	/	/	/	/
Body-Bottom (10mm)	826.4	RMC	/	/	/	/	/	/	/
	836.6	RMC	-0.798	22.20	22.7	1.122	0.119	0.134	44#
	846.6	RMC	/	/	/	/	/	/	/

**Hot Spot-WCDMA1900**

EUT Position	Frequency (MHz)	Test Mode	Power Drift (%)	Max. Meas. Power (dBm)	Max. Rated Power (dBm)	1g SAR (W/Kg)			
						Scaled Factor	Meas. SAR	Scaled SAR	Plot
Body-Back (10mm)	1852.4	RMC	-1.611	21.99	22	1.002	0.706	0.707	45#
	1880.0	RMC	-1.876	21.83	22	1.040	0.725	0.754	46#
	1907.6	RMC	1.743	21.90	22	1.023	0.794	<b>0.812</b>	<b>47#</b>
Body-Left (10mm)	1852.4	RMC	/	/	/	/	/	/	/
	1880.0	RMC	-1.141	21.83	22	1.040	0.413	0.430	48#
	1907.6	RMC	/	/	/	/	/	/	/
Body-Right (10mm)	1852.4	RMC	/	/	/	/	/	/	/
	1880.0	RMC	0.506	21.83	22	1.040	0.287	0.298	49#
	1907.6	RMC	/	/	/	/	/	/	/
Body-Bottom (10mm)	1852.4	RMC	/	/	/	/	/	/	/
	1880.0	RMC	2.183	21.83	22	1.040	0.513	0.534	50#
	1907.6	RMC	/	/	/	/	/	/	/

**Note:**

1. When the 1-g SAR is  $\leq 0.8\text{W/Kg}$ , testing for other channels are optional.
2. The default test configuration is to measure SAR with an established radio link between the EUT and a communication test set using a 12.2 kbps RMC (reference measurement Channel) Configured in Test Loop Model.
3. When SAR or MPE is not measured at the maximum power level allowed for production units, the results must be scaled to the maximum tune-up tolerance limit according to the power applied to the individual channels tested to determine compliance.

## SAR SIMULTANEOUS TRANSMISSION DESCRIPTION

### BT& Wi-Fi and GSM&3G Antennas Location:

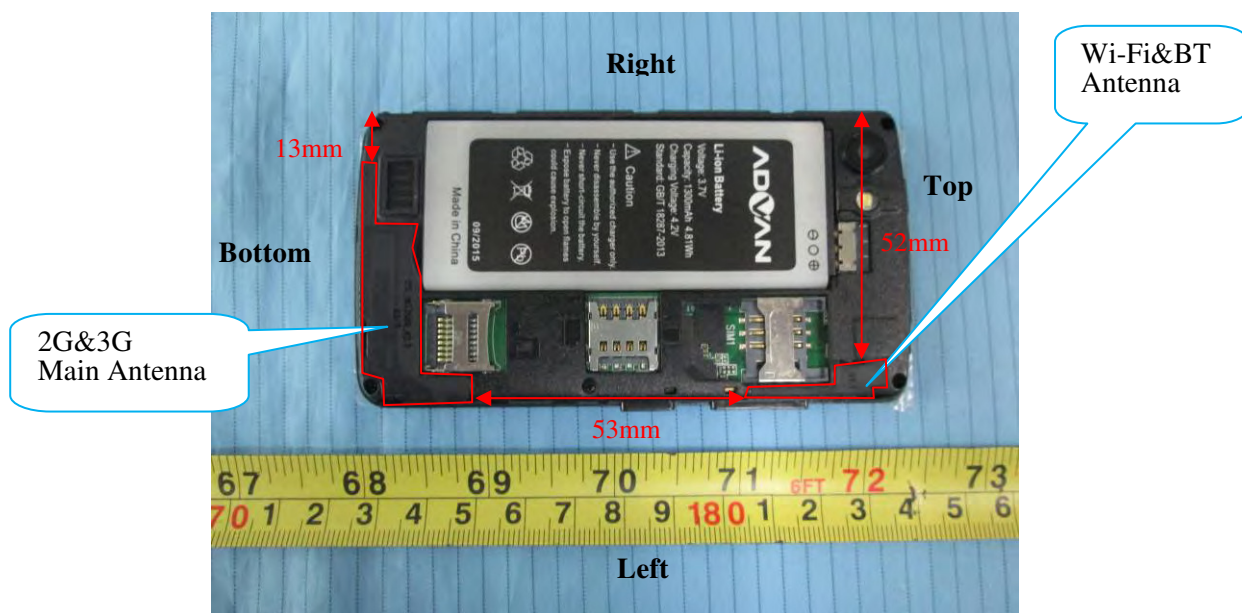

### Simultaneous Transmission:

Description of Simultaneous Transmit Capabilities			Antennas Distance (mm)
Transmitter Combination	Simultaneous?	Hotspot?	
GSM + WCDMA	×	×	0
GSM + Bluetooth	√	×	53
GSM + Wi-Fi	√	√	53
WCDMA + Bluetooth	√	×	53
WCDMA + Wi-Fi	√	√	53

### Standalone SAR test exclusion considerations

#### Head Position:

Mode	Frequency (MHz)	P <sub>avg</sub> (dBm)	P <sub>avg</sub> (mW)	Distance (mm)	Calculated value	Threshold (1-g)	SAR Test Exclusion
Wi-Fi	2472	9.70	9.333	0	2.9	3.0	Yes
Bluetooth	2480	7.90	6.166	0	1.9	3.0	Yes

#### Body Position:

Mode	Frequency (MHz)	P <sub>avg</sub> (dBm)	P <sub>avg</sub> (Mw)	Distance (mm)	Calculated value	Threshold (1-g)	SAR Test Exclusion
Wi-Fi	2472	9.70	9.333	10.00	1.5	3.0	Yes
Bluetooth	2480	7.90	6.166	10.00	1.0	3.0	Yes

The 1-g and 10-g SAR test exclusion thresholds for 100 MHz to 6 GHz at *test separation distances* ≤ 50 mm are determined by:



$[(\text{max. power of channel, including tune-up tolerance, mW})/(\text{min. test separation distance, mm})] \cdot$

$[\sqrt{f(\text{GHz})}] \leq 3.0$  for 1-g SAR and  $\leq 7.5$  for 10-g extremity SAR, where

1.  $f(\text{GHz})$  is the RF channel transmit frequency in GHz.
2. Power and distance are rounded to the nearest mW and mm before calculation.
3. The result is rounded to one decimal place for comparison.
4. When the minimum test separation distance is  $< 5$  mm, a distance of 5 mm is applied to determine SAR test Exclusion.

#### Standalone SAR estimation:

Mode	Frequency (GHz)	Distance (mm)	$P_{\text{avg}}$ (dBm)	$P_{\text{avg}}$ (mW)	Estimated 1-g (W/kg)
BT Head	2.48	0	7.90	6.166	0.259
BT Body	2.48	10	7.90	6.166	0.129
Wi-Fi Head	2.472	0	9.70	9.333	0.391
Wi-Fi Body	2.472	10	9.70	9.333	0.196

When standalone SAR test exclusion applies to an antenna that transmits simultaneously with other antennas, the standalone SAR must be estimated according to following to determine simultaneous transmission SAR test exclusion:

$[(\text{max. power of channel, including tune-up tolerance, mW})/(\text{min. test separation distance, mm})] \cdot [\sqrt{f(\text{GHz})/x}] \text{ W/kg}$  for test separation distances  $\leq 50$  mm;

where  $x = 7.5$  for 1-g SAR.

When the minimum test separation distance is  $< 5$  mm, a distance of 5 mm is applied to determine SAR test Exclusion

**Simultaneous SAR test exclusion considerations:****GSM with BT:**

Mode	Position	Reported SAR (W/kg)		ΣSAR
		GSM	BT	< 1.6W/kg
GSM850	Left Head Cheek	0.464	0.259	0.723
	Left Head Tilt	0.204	0.259	0.463
	Right Head Cheek	0.384	0.259	0.643
	Right Head Tilt	0.192	0.259	0.451
	Body-Headset-Back	0.301	0.129	0.43
PCS1900	Left Head Cheek	0.26	0.259	0.519
	Left Head Tilt	0.169	0.259	0.428
	Right Head Cheek	0.292	0.259	0.551
	Right Head Tilt	0.144	0.259	0.403
	Body-Headset-Back	0.306	0.129	0.435

**WCDMA with BT:**

Mode	Position	Reported SAR (W/kg)		ΣSAR
		WCDMA	BT	< 1.6W/kg
WCDMA 850	Left Head Cheek	0.286	0.259	0.545
	Left Head Tilt	0.193	0.259	0.452
	Right Head Cheek	0.323	0.259	0.582
	Right Head Tilt	0.211	0.259	0.47
WCDMA 1900	Left Head Cheek	0.357	0.259	0.616
	Left Head Tilt	0.202	0.259	0.461
	Right Head Cheek	0.418	0.259	0.677
	Right Head Tilt	0.166	0.259	0.425

**GSM with Wi-Fi:**

Mode	Position	Reported SAR (W/kg)		ΣSAR
		GSM	Wi-Fi	< 1.6W/kg
GSM850	Left Head Cheek	0.464	0.391	<b>0.855</b>
	Left Head Tilt	0.204	0.391	0.595
	Right Head Cheek	0.384	0.391	0.775
	Right Head Tilt	0.192	0.391	0.583
	Body-Headset-Back	0.301	0.196	0.497
PCS1900	Left Head Cheek	0.260	0.391	0.651
	Left Head Tilt	0.169	0.391	0.56
	Right Head Cheek	0.292	0.391	0.683
	Right Head Tilt	0.144	0.391	0.535
	Body-Headset-Back	0.306	0.196	0.502

**WCDMA with Wi-Fi:**

Mode	Position	Reported SAR (W/kg)		ΣSAR
		WCDMA	Wi-Fi	< 1.6W/kg
WCDMA 850	Left Head Cheek	0.286	0.391	0.677
	Left Head Tilt	0.193	0.391	0.584
	Right Head Cheek	0.323	0.391	0.714
	Right Head Tilt	0.211	0.391	0.602
WCDMA 1900	Left Head Cheek	0.357	0.391	0.748
	Left Head Tilt	0.202	0.391	0.593
	Right Head Cheek	0.418	0.391	0.809
	Right Head Tilt	0.166	0.391	0.557

Evaluations for Simultaneous SAR, BT+GSM/3G					
Test Position	Body-Back (1.0cm)	Body-Left (1.0cm)	Body-Right (1.0cm)	Body-Bottom (1.0cm)	Body-Top (1.0cm)
Mode	Stand Alone 1-g SAR (W/Kg)				
GPRS 850	0.799	0.349	0.266	0.346	/
GPRS 1900	0.837	0.351	0.406	0.358	/
WCDMA850	0.348	0.251	0.212	0.134	/
WCDMA 1900	0.812	0.43	0.298	0.534	/
BT	0.129	0.129	0.129	0.129	0.129
	Σ 1-g SAR(W/Kg)				
GPRS850 + BT	0.918	0.478	0.395	0.475	/
GPRS1900 + BT	0.966	0.48	0.535	0.487	/
WCDMA850 + BT	0.477	0.38	0.341	0.263	/
WCDMA 1900 + BT	0.941	0.559	0.427	0.663	/
Evaluations for Simultaneous SAR, Mobile Hot Spot Positions					
Test Position	Body-Back (1.0cm)	Body-Left (1.0cm)	Body-Right (1.0cm)	Body-Bottom (1.0cm)	Body-Top (1.0cm)
Mode	Stand Alone 1-g SAR (W/Kg)				
GPRS 850	0.799	0.349	0.266	0.346	/
GPRS 1900	0.837	0.351	0.406	0.358	/
WCDMA850	0.348	0.251	0.212	0.134	/
WCDMA 1900	0.812	0.43	0.298	0.534	/
Wi-Fi	0.196	0.196	0.196	0.196	0.196
	Σ 1-g SAR(W/Kg)				
GPRS850 + Wi-Fi	0.985	0.545	0.462	0.542	/
GPRS1900 + Wi-Fi	<b>1.033</b>	0.547	0.602	0.554	/
WCDMA850 + Wi-Fi	0.544	0.447	0.408	0.330	/
WCDMA 1900 + Wi-Fi	1.008	0.626	0.494	0.730	/

**Note:**

If the sum of the 1g SAR measured for the simultaneously transmitting antennas is less than the SAR limit, SAR measurement for simultaneous transmission is not require

**SAR Plots**

**Test Laboratory: Bay Area Compliance Lab Corp. (Shenzhen)**

**Left Head Cheek (824.2 MHz Low Channel)**

Measurement Data

Test mode : GSM  
 Crest Factor : 8  
 Scan Type : Complete  
 Area Scan : 11x8x1: Measurement x=10mm, y=10mm, z=4mm  
 Zoom Scan : 5x5x7: Measurement x=8mm, y=8mm, z=5mm  
 Power Drift-Start : 0.036 W/kg  
 Power Drift-Finish : 0.036 W/kg  
 Power Drift (%) : -0.954

Tissue Data

Type : Head  
 Frequency : 824.20 MHz  
 Epsilon : 40.48 F/m  
 Sigma : 0.92 S/m  
 Density : 1000.00 kg/cu. m

Probe Data

Serial No. : 500-00283  
 Frequency Band : 835  
 Duty Cycle Factor : 8  
 Conversion Factor : 5.9  
 Probe Sensitivity : 1.20 1.20 1.20  $\mu\text{V}/(\text{V}/\text{m})^2$   
 Compression Point : 95.00 mV  
 Offset : 1.56 mm

1 gram SAR value : 0.386 W/kg  
 10 gram SAR value : 0.276 W/kg  
 Area Scan Peak SAR : 0.405 W/kg  
 Zoom Scan Peak SAR : 0.629 W/kg

**Plot 1#**

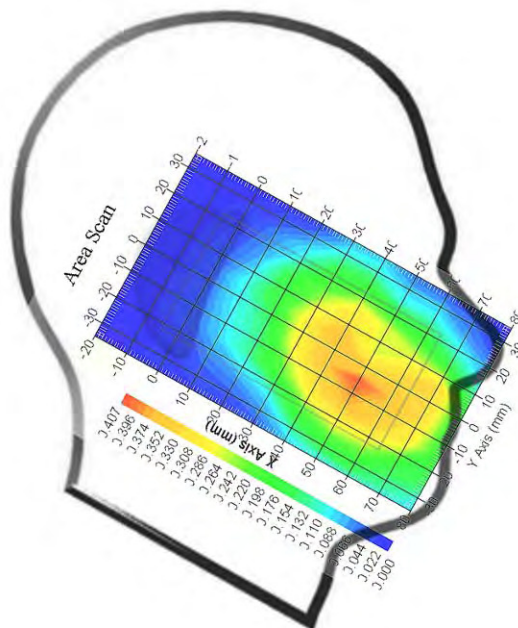

**Test Laboratory: Bay Area Compliance Lab Corp. (Shenzhen)**

**Left Head Cheek (836.6 MHz Middle Channel)**

Measurement Data

Test mode : GSM  
 Crest Factor : 8  
 Scan Type : Complete  
 Area Scan : 11x8x1: Measurement x=10mm, y=10mm, z=4mm  
 Zoom Scan : 5x5x7: Measurement x=8mm, y=8mm, z=5mm  
 Power Drift-Start : 0.027 W/kg  
 Power Drift-Finish : 0.027 W/kg  
 Power Drift (%) : -1.454

Tissue Data

Type : Head  
 Frequency : 836.6 MHz  
 Epsilon : 40.12 F/m  
 Sigma : 0.91 S/m  
 Density : 1000.00 kg/cu. m

Probe Data

Serial No. : 500-00283  
 Frequency Band : 835  
 Duty Cycle Factor : 8  
 Conversion Factor : 5.9  
 Probe Sensitivity : 1.20 1.20 1.20  $\mu\text{V}/(\text{V}/\text{m})^2$   
 Compression Point : 95.00 mV  
 Offset : 1.56 mm

1 gram SAR value : 0.418 W/kg  
 10 gram SAR value : 0.285 W/kg  
 Area Scan Peak SAR : 0.447 W/kg  
 Zoom Scan Peak SAR : 0.693 W/kg

**Plot 2#**

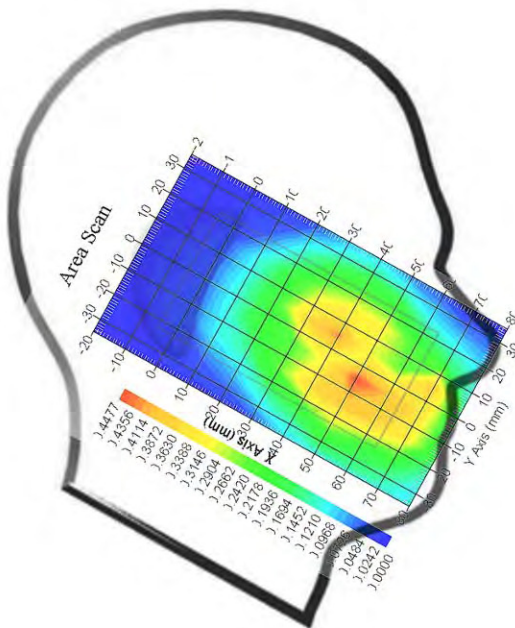

**Test Laboratory: Bay Area Compliance Lab Corp. (Shenzhen)**

**Left Head Cheek (848.8 MHz High Channel)**

Measurement Data

Test mode : GSM  
 Crest Factor : 8  
 Scan Type : Complete  
 Area Scan : 11x8x1: Measurement x=10mm, y=10mm, z=4mm  
 Zoom Scan : 5x5x7: Measurement x=8mm, y=8mm, z=5mm  
 Power Drift-Start : 0.053 W/kg  
 Power Drift-Finish : 0.052 W/kg  
 Power Drift (%) : -1.889

Tissue Data

Type : Head  
 Frequency : 848.8 MHz  
 Epsilon : 39.87 F/m  
 Sigma : 0.91 S/m  
 Density : 1000.00 kg/cu. m

Probe Data

Serial No. : 500-00283  
 Frequency Band : 835  
 Duty Cycle Factor : 8  
 Conversion Factor : 5.9  
 Probe Sensitivity : 1.20 1.20 1.20  $\mu\text{V}/(\text{V}/\text{m})^2$   
 Compression Point : 95.00 mV  
 Offset : 1.56 mm

1 gram SAR value : 0.462 W/kg  
 10 gram SAR value : 0.309 W/kg  
 Area Scan Peak SAR : 0.543 W/kg  
 Zoom Scan Peak SAR : 0.772 W/kg

**Plot 3#**

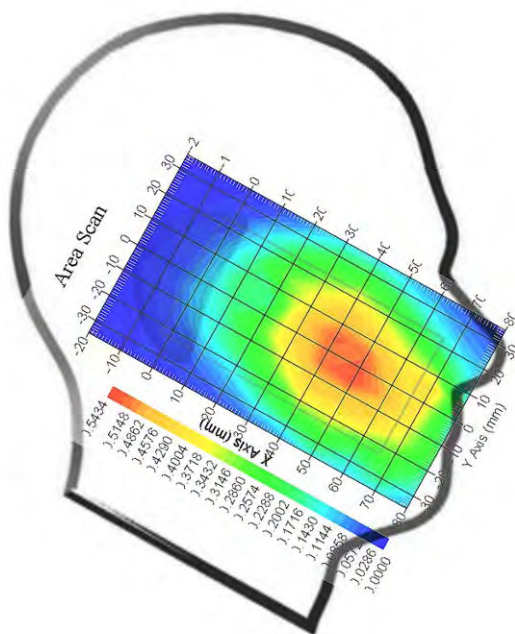

**Test Laboratory: Bay Area Compliance Lab Corp. (Shenzhen)**

**Left Head 15° Tilt (836.6 MHz Middle Channel)**

Measurement Data

Test mode : GSM  
 Crest Factor : 8  
 Scan Type : Complete  
 Area Scan : 11x8x1: Measurement x=10mm, y=10mm, z=4mm  
 Zoom Scan : 5x5x7: Measurement x=8mm, y=8mm, z=5mm  
 Power Drift-Start : 0.132 W/kg  
 Power Drift-Finish : 0.133 W/kg  
 Power Drift (%) : 0.767

Tissue Data

Type : Head  
 Frequency : 836.6 MHz  
 Epsilon : 40.12 F/m  
 Sigma : 0.91 S/m  
 Density : 1000.00 kg/cu. m

Probe Data

Serial No. : 500-00283  
 Frequency Band : 835  
 Duty Cycle Factor : 8  
 Conversion Factor : 5.9  
 Probe Sensitivity : 1.20 1.20 1.20  $\mu\text{V}/(\text{V}/\text{m})^2$   
 Compression Point : 95.00 mV  
 Offset : 1.56 mm

1 gram SAR value : 0.198 W/kg  
 10 gram SAR value : 0.143 W/kg  
 Area Scan Peak SAR : 0.224 W/kg  
 Zoom Scan Peak SAR : 0.290 W/kg

**Plot 4#**

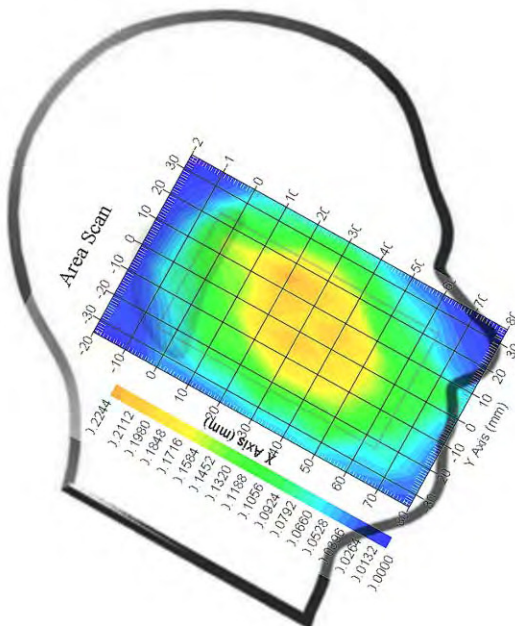

**Test Laboratory: Bay Area Compliance Lab Corp. (Shenzhen)**

**Right Head Cheek (836.6 MHz Middle Channel)**

Measurement Data

Test mode : GSM  
 Crest Factor : 8  
 Scan Type : Complete  
 Area Scan : 11x8x1: Measurement x=10mm, y=10mm, z=4mm  
 Zoom Scan : 5x5x7: Measurement x=8mm, y=8mm, z=5mm  
 Power Drift-Start : 0.054 W/kg  
 Power Drift-Finish : 0.054 W/kg  
 Power Drift (%) : -0.632

Tissue Data

Type : Head  
 Frequency : 836.6 MHz  
 Epsilon : 40.12 F/m  
 Sigma : 0.91 S/m  
 Density : 1000.00 kg/cu. m

Probe Data

Serial No. : 500-00283  
 Frequency Band : 835  
 Duty Cycle Factor : 8  
 Conversion Factor : 5.9  
 Probe Sensitivity : 1.20 1.20 1.20  $\mu\text{V}/(\text{V}/\text{m})^2$   
 Compression Point : 95.00 mV  
 Offset : 1.56 mm

1 gram SAR value : 0.373 W/kg  
 10 gram SAR value : 0.256 W/kg  
 Area Scan Peak SAR : 0.401 W/kg  
 Zoom Scan Peak SAR : 0.675 W/kg

**Plot 5#**

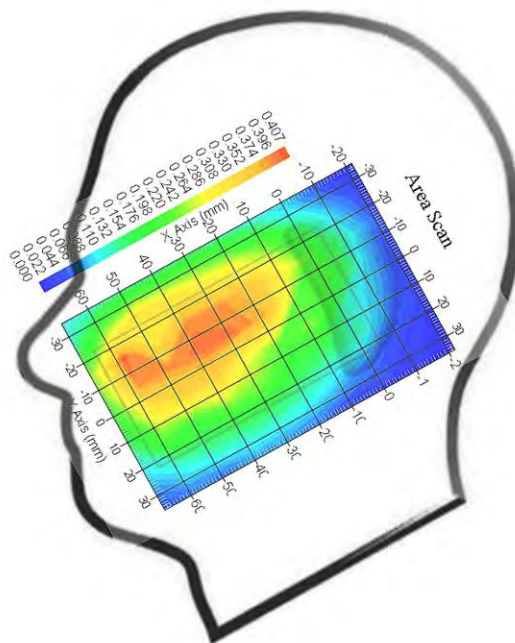



**Test Laboratory: Bay Area Compliance Lab Corp. (Shenzhen)**

**Right Head 15° Tilt (836.6 MHz Middle Channel)**

Measurement Data

Test mode : GSM  
 Crest Factor : 8  
 Scan Type : Complete  
 Area Scan : 11x8x1: Measurement x=10mm, y=10mm, z=4mm  
 Zoom Scan : 5x5x7: Measurement x=8mm, y=8mm, z=5mm  
 Power Drift-Start : 0.102 W/kg  
 Power Drift-Finish : 0.104 W/kg  
 Power Drift (%) : 1.961

Tissue Data

Type : Head  
 Frequency : 836.6 MHz  
 Epsilon : 40.12 F/m  
 Sigma : 0.91 S/m  
 Density : 1000.00 kg/cu. m

Probe Data

Serial No. : 500-00283  
 Frequency Band : 835  
 Duty Cycle Factor : 8  
 Conversion Factor : 5.9  
 Probe Sensitivity : 1.20 1.20 1.20  $\mu\text{V}/(\text{V}/\text{m})^2$   
 Compression Point : 95.00 mV  
 Offset : 1.56 mm

1 gram SAR value : 0.186 W/kg  
 10 gram SAR value : 0.129 W/kg  
 Area Scan Peak SAR : 0.203 W/kg  
 Zoom Scan Peak SAR : 0.312 W/kg

**Plot 6#**

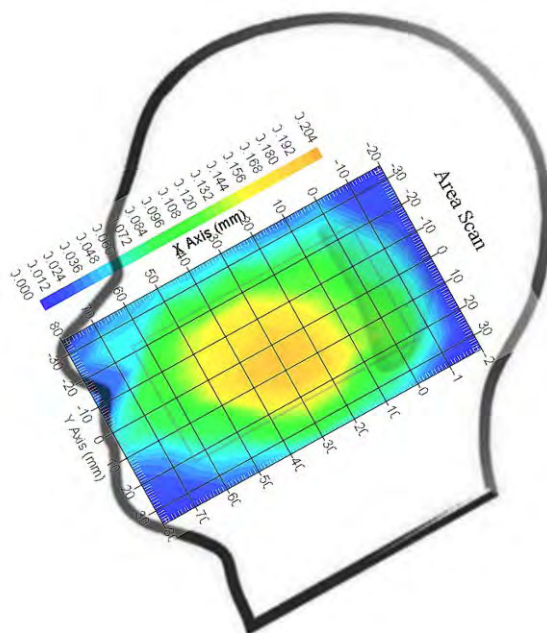

**Test Laboratory: Bay Area Compliance Lab Corp. (Shenzhen)**

**Left Head Cheek(1880.0 MHz Middle Channel)**

Measurement Data

Test mode : GSM  
 Crest Factor : 8  
 Scan Type : Complete  
 Area Scan : 11x8x1: Measurement x=10mm, y=10mm, z=4mm  
 Zoom Scan : 5x5x7: Measurement x=8mm, y=8mm, z=5mm  
 Power Drift-Start : 0.002 W/kg  
 Power Drift-Finish : 0.002 W/kg  
 Power Drift (%) : -1.369

Tissue Data

Type : Head  
 Frequency : 1880.0 MHz  
 Epsilon : 38.71 F/m  
 Sigma : 1.42 S/m  
 Density : 1000.00 kg/cu. M

Probe Data

Serial No. : 500-00283  
 Frequency Band : 1900  
 Duty Cycle Factor : 8  
 Conversion Factor : 4.8  
 Probe Sensitivity : 1.20 1.20 1.20  $\mu\text{V}/(\text{V}/\text{m})^2$   
 Compression Point : 95.00 mV  
 Offset : 1.56 mm

1 gram SAR value : 0.256 W/kg  
 10 gram SAR value : 0.142 W/kg  
 Area Scan Peak SAR : 0.349 W/kg  
 Zoom Scan Peak SAR : 0.492 W/kg

**Plot 7#**

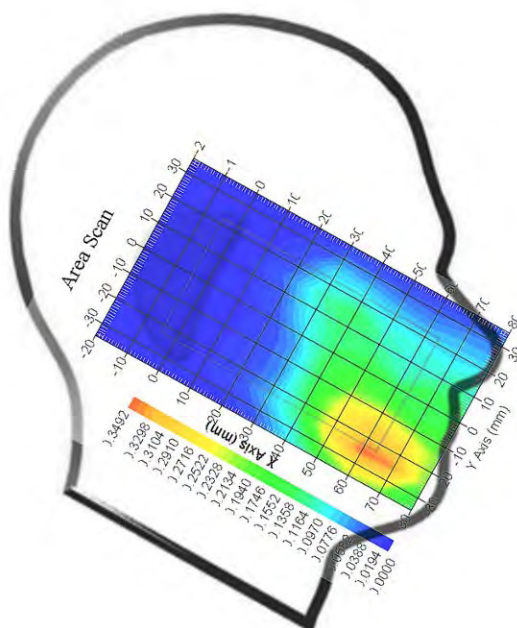

**Test Laboratory: Bay Area Compliance Lab Corp. (Shenzhen)**

**Left Head 15° Tilt (1880.0 MHz Middle Channel)**

Measurement Data

Test mode : GSM  
 Crest Factor : 8  
 Scan Type : Complete  
 Area Scan : 11x8x1: Measurement x=10mm, y=10mm, z=4mm  
 Zoom Scan : 5x5x7: Measurement x=8mm, y=8mm, z=5mm  
 Power Drift-Start : 0.035 W/kg  
 Power Drift-Finish : 0.036 W/kg  
 Power Drift (%) : 2.858

Tissue Data

Type : Head  
 Frequency : 1880.0 MHz  
 Epsilon : 38.71 F/m  
 Sigma : 1.42 S/m  
 Density : 1000.00 kg/cu. M

Probe Data

Serial No. : 500-00283  
 Frequency Band : 1900  
 Duty Cycle Factor : 8  
 Conversion Factor : 4.8  
 Probe Sensitivity : 1.20 1.20 1.20  $\mu\text{V}/(\text{V}/\text{m})^2$   
 Compression Point : 95.00 mV  
 Offset : 1.56 mm

1 gram SAR value : 0.166 W/kg  
 10 gram SAR value : 0.089 W/kg  
 Area Scan Peak SAR : 0.187 W/kg  
 Zoom Scan Peak SAR : 0.303 W/kg

**Plot 8#**

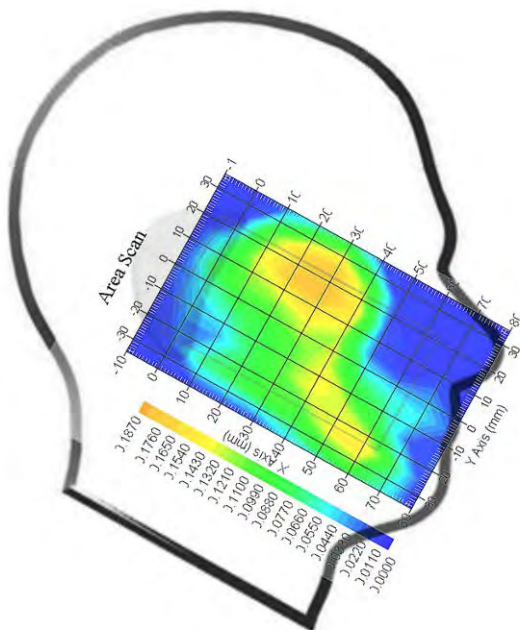

**Test Laboratory: Bay Area Compliance Lab Corp. (Shenzhen)**

**Right Head Cheek(1850.2 MHz Low Channel)**

Measurement Data

Test mode : GSM  
 Crest Factor : 8  
 Scan Type : Complete  
 Area Scan : 11x8x1: Measurement x=10mm, y=10mm, z=4mm  
 Zoom Scan : 5x5x7: Measurement x=8mm, y=8mm, z=5mm  
 Power Drift-Start : 0.002 W/kg  
 Power Drift-Finish : 0.002 W/kg  
 Power Drift (%) : -2.936

Tissue Data

Type : Head  
 Frequency : 1850.2 MHz  
 Epsilon : 38.88 F/m  
 Sigma : 1.41 S/m  
 Density : 1000.00 kg/cu. M

Probe Data

Serial No. : 500-00283  
 Frequency Band : 1900  
 Duty Cycle Factor : 8  
 Conversion Factor : 4.8  
 Probe Sensitivity : 1.20 1.20 1.20  $\mu\text{V}/(\text{V}/\text{m})^2$   
 Compression Point : 95.00 mV  
 Offset : 1.56 mm

1 gram SAR value : 0.255 W/kg  
 10 gram SAR value : 0.140 W/kg  
 Area Scan Peak SAR : 0.347 W/kg  
 Zoom Scan Peak SAR : 0.491 W/kg

**Plot 9#**

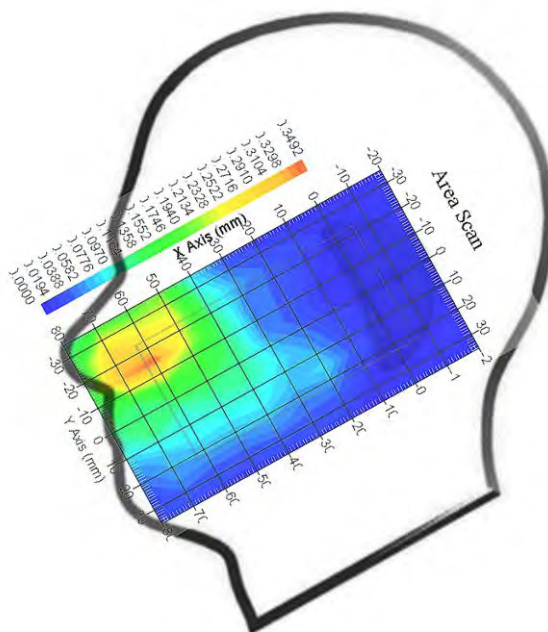

**Test Laboratory: Bay Area Compliance Lab Corp. (Shenzhen)**

**Right Head Cheek(1880.0 MHz Middle Channel)**

Measurement Data

Test mode : GSM  
 Crest Factor : 8  
 Scan Type : Complete  
 Area Scan : 11x8x1: Measurement x=10mm, y=10mm, z=4mm  
 Zoom Scan : 5x5x7: Measurement x=8mm, y=8mm, z=5mm  
 Power Drift-Start : 0.002 W/kg  
 Power Drift-Finish : 0.002 W/kg  
 Power Drift (%) : 2.524

Tissue Data

Type : Head  
 Frequency : 1880.0 MHz  
 Epsilon : 38.71 F/m  
 Sigma : 1.42 S/m  
 Density : 1000.00 kg/cu. M

Probe Data

Serial No. : 500-00283  
 Frequency Band : 1900  
 Duty Cycle Factor : 8  
 Conversion Factor : 4.8  
 Probe Sensitivity : 1.20 1.20 1.20  $\mu\text{V}/(\text{V/m})^2$   
 Compression Point : 95.00 mV  
 Offset : 1.56 mm

1 gram SAR value : 0.287 W/kg  
 10 gram SAR value : 0.155 W/kg  
 Area Scan Peak SAR : 0.367 W/kg  
 Zoom Scan Peak SAR : 0.600 W/kg

**Plot 10#**

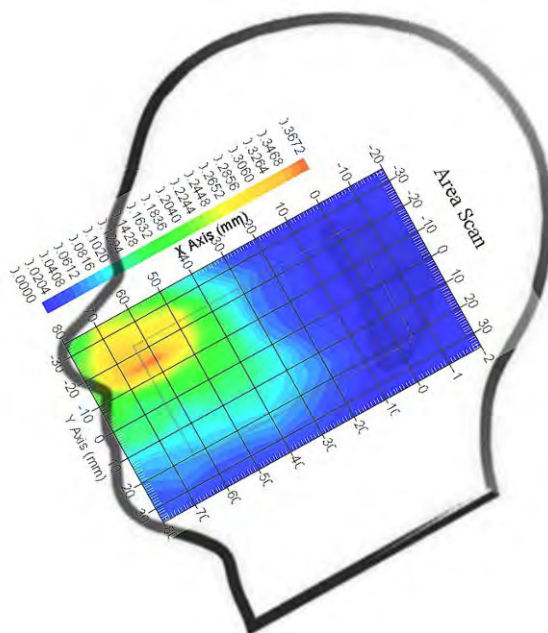

**Test Laboratory: Bay Area Compliance Lab Corp. (Shenzhen)**

**Right Head Cheek(1909.8 MHz High Channel)**

Measurement Data

Test mode : GSM  
 Crest Factor : 8  
 Scan Type : Complete  
 Area Scan : 11x8x1: Measurement x=10mm, y=10mm, z=4mm  
 Zoom Scan : 5x5x7: Measurement x=8mm, y=8mm, z=5mm  
 Power Drift-Start : 0.011 W/kg  
 Power Drift-Finish : 0.011 W/kg  
 Power Drift (%) : -1.043

Tissue Data

Type : Head  
 Frequency : 1909.8 MHz  
 Epsilon : 39.96 F/m  
 Sigma : 1.42 S/m  
 Density : 1000.00 kg/cu. M

Probe Data

Serial No. : 500-00283  
 Frequency Band : 1900  
 Duty Cycle Factor : 8  
 Conversion Factor : 4.8  
 Probe Sensitivity : 1.20 1.20 1.20  $\mu\text{V}/(\text{V}/\text{m})^2$   
 Compression Point : 95.00 mV  
 Offset : 1.56 mm

1 gram SAR value : 0.264 W/kg  
 10 gram SAR value : 0.147 W/kg  
 Area Scan Peak SAR : 0.342 W/kg  
 Zoom Scan Peak SAR : 0.518 W/kg

**Plot 11#**

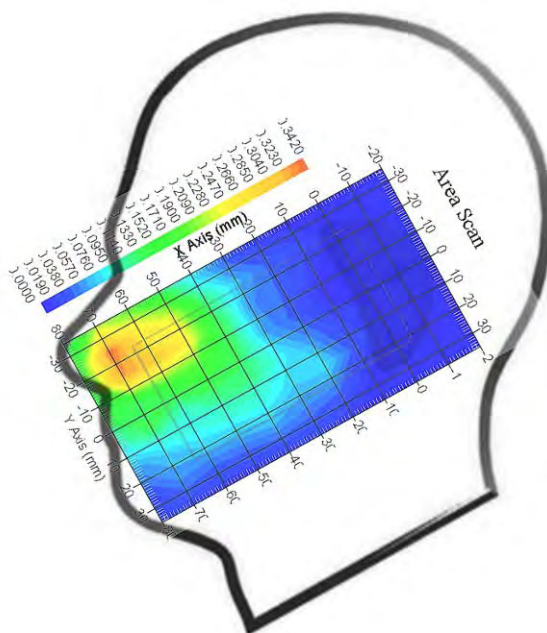

**Test Laboratory: Bay Area Compliance Lab Corp. (Shenzhen)**

**Right Head 15° Tilt (1880.0 MHz Middle Channel)**

Measurement Data

Test mode : GSM  
 Crest Factor : 8  
 Scan Type : Complete  
 Area Scan : 11x8x1: Measurement x=10mm, y=10mm, z=4mm  
 Zoom Scan : 5x5x7: Measurement x=8mm, y=8mm, z=5mm  
 Power Drift-Start : 0.037 W/kg  
 Power Drift-Finish : 0.037 W/kg  
 Power Drift (%) : -1.332

Tissue Data

Type : Head  
 Frequency : 1880.0 MHz  
 Epsilon : 38.71 F/m  
 Sigma : 1.42 S/m  
 Density : 1000.00 kg/cu. M

Probe Data

Serial No. : 500-00283  
 Frequency Band : 1900  
 Duty Cycle Factor : 8  
 Conversion Factor : 4.8  
 Probe Sensitivity : 1.20 1.20 1.20  $\mu\text{V}/(\text{V/m})^2$   
 Compression Point : 95.00 mV  
 Offset : 1.56 mm

1 gram SAR value : 0.142 W/kg  
 10 gram SAR value : 0.079 W/kg  
 Area Scan Peak SAR : 0.171 W/kg  
 Zoom Scan Peak SAR : 0.278 W/kg

**Plot 12#**

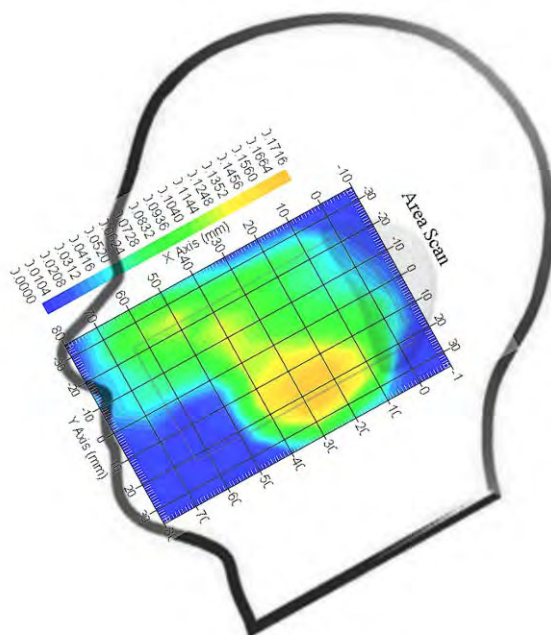

**Test Laboratory: Bay Area Compliance Lab Corp. (Shenzhen)**

**WCDMA850; Left Head Cheek (836.6 MHz Middle Channel)**

Measurement Data

Test mode : WCDMA850  
 Crest Factor : 1  
 Scan Type : Complete  
 Area Scan : 11x8x1: Measurement x=10mm, y=10mm, z=4mm  
 Zoom Scan : 5x5x7: Measurement x=8mm, y=8mm, z=5mm  
 Power Drift-Start : 0.047 W/kg  
 Power Drift-Finish : 0.047W/kg  
 Power Drift (%) : -0.957

Tissue Data

Type : Head  
 Frequency : 836.6 MHz  
 Epsilon : 40.12 F/m  
 Sigma : 0.91 S/m  
 Density : 1000.00 kg/cu. m

Probe Data

Serial No. : 500-00283  
 Frequency Band : 835  
 Duty Cycle Factor : 1  
 Conversion Factor : 5.9  
 Probe Sensitivity : 1.20 1.20 1.20  $\mu\text{V}/(\text{V}/\text{m})^2$   
 Compression Point : 95.00 mV  
 Offset : 1.56 mm

1 gram SAR value : 0.255 W/kg  
 10 gram SAR value : 0.156 W/kg  
 Area Scan Peak SAR : 0.306 W/kg  
 Zoom Scan Peak SAR : 0.463 W/kg

**Plot 13#**

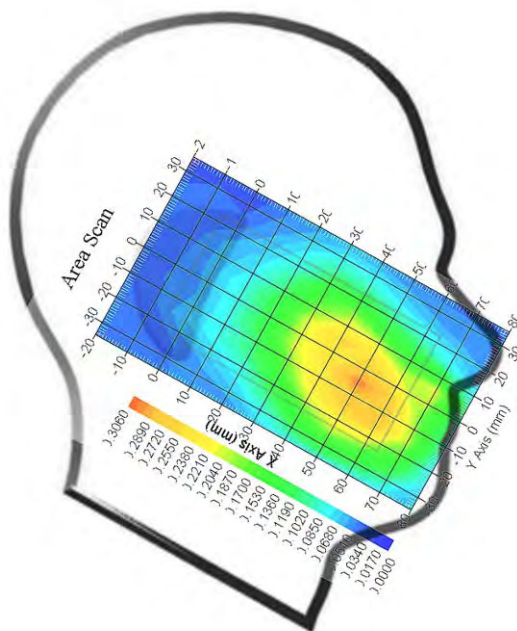



**Test Laboratory: Bay Area Compliance Lab Corp. (Shenzhen)**

**WCDMA850; Left Head 15° Tilt (836.6 MHz Middle Channel)**

Measurement Data

Test mode : WCDMA850  
 Crest Factor : 1  
 Scan Type : Complete  
 Area Scan : 11x8x1: Measurement x=10mm, y=10mm, z=4mm  
 Zoom Scan : 5x5x7: Measurement x=8mm, y=8mm, z=5mm  
 Power Drift-Start : 0.112 W/kg  
 Power Drift-Finish : 0.113 W/kg  
 Power Drift (%) : 0.893

Tissue Data

Type : Head  
 Frequency : 836.6 MHz  
 Epsilon : 40.12 F/m  
 Sigma : 0.91 S/m  
 Density : 1000.00 kg/cu. m

Probe Data

Serial No. : 500-00283  
 Frequency Band : 835  
 Duty Cycle Factor : 1  
 Conversion Factor : 5.9  
 Probe Sensitivity : 1.20 1.20 1.20  $\mu\text{V}/(\text{V}/\text{m})^2$   
 Compression Point : 95.00 mV  
 Offset : 1.56 mm

1 gram SAR value : 0.172 W/kg  
 10 gram SAR value : 0.117 W/kg  
 Area Scan Peak SAR : 0.193 W/kg  
 Zoom Scan Peak SAR : 0.285 W/kg

**Plot 14#**

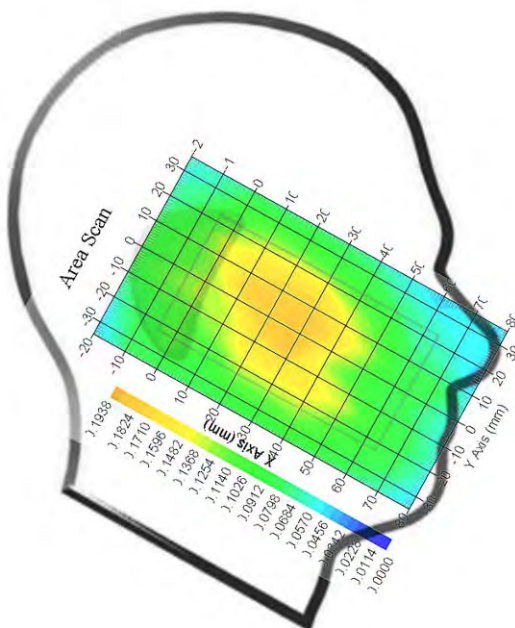

**Test Laboratory: Bay Area Compliance Lab Corp. (Shenzhen)**

**WCDMA850; Right Head Cheek (826.4 MHz Low Channel)**

Measurement Data

Test mode : WCDMA850  
 Crest Factor : 1  
 Scan Type : Complete  
 Area Scan : 11x8x1: Measurement x=10mm, y=10mm, z=4mm  
 Zoom Scan : 5x5x7: Measurement x=8mm, y=8mm, z=5mm  
 Power Drift-Start : 0.042 W/kg  
 Power Drift-Finish : 0.042 W/kg  
 Power Drift (%) : -1.113

Tissue Data

Type : Head  
 Frequency : 826.4 MHz  
 Epsilon : 40.34 F/m  
 Sigma : 0.90 S/m  
 Density : 1000.00 kg/cu. m

Probe Data

Serial No. : 500-00283  
 Frequency Band : 835  
 Duty Cycle Factor : 1  
 Conversion Factor : 5.9  
 Probe Sensitivity : 1.20 1.20 1.20  $\mu\text{V}/(\text{V}/\text{m})^2$   
 Compression Point : 95.00 mV  
 Offset : 1.56 mm

1 gram SAR value : 0.234 W/kg  
 10 gram SAR value : 0.141 W/kg  
 Area Scan Peak SAR : 0.269 W/kg  
 Zoom Scan Peak SAR : 0.406 W/kg

**Plot 15#**

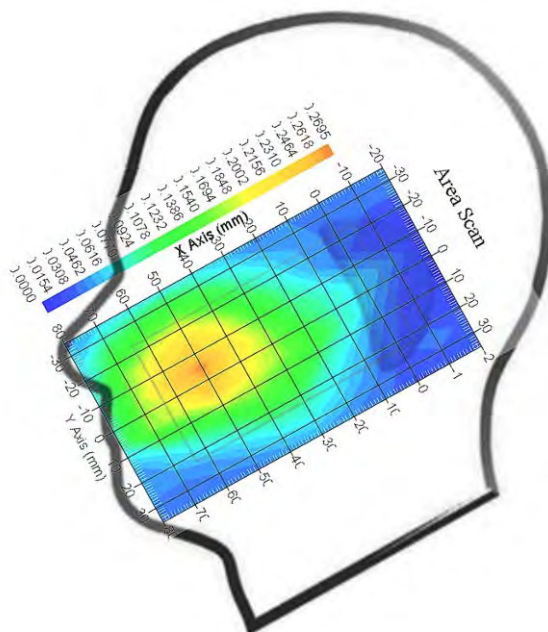

**Test Laboratory: Bay Area Compliance Lab Corp. (Shenzhen)**

**WCDMA850; Right Head Cheek (836.6 MHz Middle Channel)**

Measurement Data

Test mode : WCDMA850  
 Crest Factor : 1  
 Scan Type : Complete  
 Area Scan : 11x8x1: Measurement x=10mm, y=10mm, z=4mm  
 Zoom Scan : 5x5x7: Measurement x=8mm, y=8mm, z=5mm  
 Power Drift-Start : 0.035 W/kg  
 Power Drift-Finish : 0.035 W/kg  
 Power Drift (%) : -0.776

Tissue Data

Type : Head  
 Frequency : 836.6 MHz  
 Epsilon : 40.11 F/m  
 Sigma : 0.91 S/m  
 Density : 1000.00 kg/cu. m

Probe Data

Serial No. : 500-00283  
 Frequency Band : 835  
 Duty Cycle Factor : 1  
 Conversion Factor : 5.9  
 Probe Sensitivity : 1.20 1.20 1.20  $\mu\text{V}/(\text{V/m})^2$   
 Compression Point : 95.00 mV  
 Offset : 1.56 mm

1 gram SAR value : 0.288 W/kg  
 10 gram SAR value : 0.185 W/kg  
 Area Scan Peak SAR : 0.327 W/kg  
 Zoom Scan Peak SAR : 0.532 W/kg

**Plot 16#**

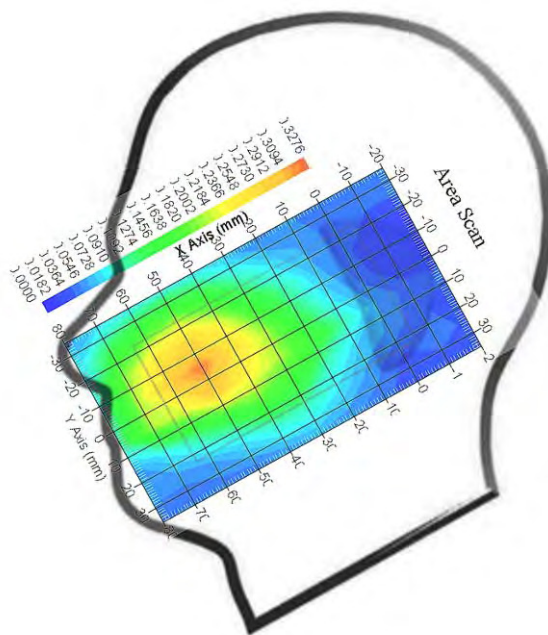

**Test Laboratory: Bay Area Compliance Lab Corp. (Shenzhen)**

**WCDMA850; Right Head Cheek (846.6 MHz High Channel)**

Measurement Data

Test mode : WCDMA850  
 Crest Factor : 1  
 Scan Type : Complete  
 Area Scan : 11x8x1: Measurement x=10mm, y=10mm, z=4mm  
 Zoom Scan : 5x5x7: Measurement x=8mm, y=8mm, z=5mm  
 Power Drift-Start : 0.092 W/kg  
 Power Drift-Finish : 0.090 W/kg  
 Power Drift (%) : -2.174

Tissue Data

Type : Head  
 Frequency : 846.6 MHz  
 Epsilon : 40.54 F/m  
 Sigma : 0.91 S/m  
 Density : 1000.00 kg/cu. m

Probe Data

Serial No. : 500-00283  
 Frequency Band : 835  
 Duty Cycle Factor : 1  
 Conversion Factor : 5.9  
 Probe Sensitivity : 1.20 1.20 1.20  $\mu\text{V}/(\text{V}/\text{m})^2$   
 Compression Point : 95.00 mV  
 Offset : 1.56 mm

1 gram SAR value : 0.247 W/kg  
 10 gram SAR value : 0.139 W/kg  
 Area Scan Peak SAR : 0.283 W/kg  
 Zoom Scan Peak SAR : 0.407 W/kg

**Plot 17#**

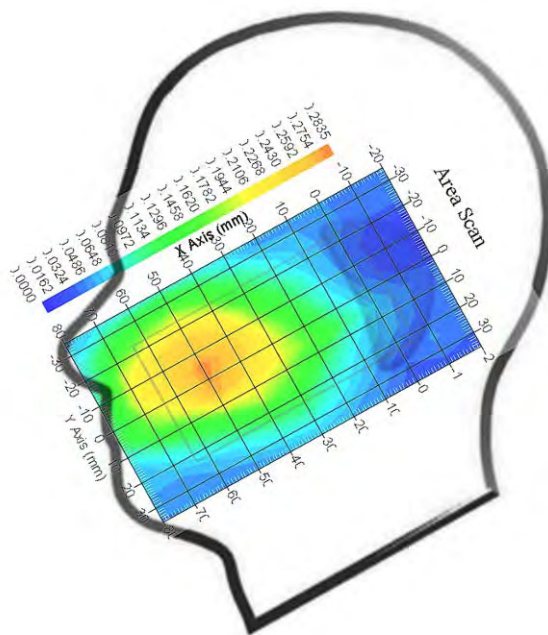

**Test Laboratory: Bay Area Compliance Lab Corp. (Shenzhen)**

**WCDMA850; Right Head 15° Tilt (836.6 MHz Middle Channel)**

Measurement Data

Test mode : WCDMA850  
 Crest Factor : 1  
 Scan Type : Complete  
 Area Scan : 11x8x1: Measurement x=10mm, y=10mm, z=4mm  
 Zoom Scan : 5x5x7: Measurement x=8mm, y=8mm, z=5mm  
 Power Drift-Start : 0.076 W/kg  
 Power Drift-Finish : 0.075 W/kg  
 Power Drift (%) : -1.316

Tissue Data

Type : Head  
 Frequency : 836.6 MHz  
 Epsilon : 40.11 F/m  
 Sigma : 0.91 S/m  
 Density : 1000.00 kg/cu. m

Probe Data

Serial No. : 500-00283  
 Frequency Band : 835  
 Duty Cycle Factor : 1  
 Conversion Factor : 5.9  
 Probe Sensitivity : 1.20 1.20 1.20  $\mu\text{V}/(\text{V}/\text{m})^2$   
 Compression Point : 95.00 mV  
 Offset : 1.56 mm

1 gram SAR value : 0.188 W/kg  
 10 gram SAR value : 0.147 W/kg  
 Area Scan Peak SAR : 0.238 W/kg  
 Zoom Scan Peak SAR : 0.375 W/kg

**Plot 18#**

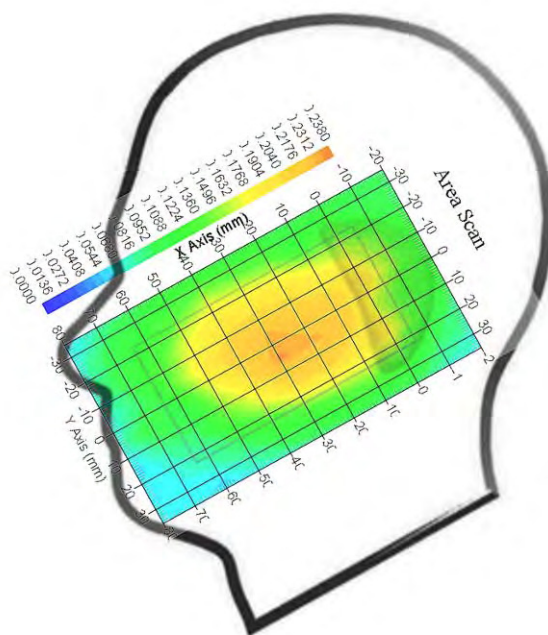

**Test Laboratory: Bay Area Compliance Lab Corp. (Shenzhen)**

**WCDMA1900; Left Head Cheek (1880 MHz Middle Channel)**

Measurement Data

Test mode : WCDMA1900  
 Crest Factor : 1  
 Scan Type : Complete  
 Area Scan : 11x8x1: Measurement x=10mm, y=10mm, z=4mm  
 Zoom Scan : 5x5x7: Measurement x=8mm, y=8mm, z=5mm  
 Power Drift-Start : 0.005 W/kg  
 Power Drift-Finish : 0.005 W/kg  
 Power Drift (%) : -1.147

Tissue Data

Type : Head  
 Frequency : 1880 MHz  
 Epsilon : 38.71 F/m  
 Sigma : 1.42 S/m  
 Density : 1000.00 kg/cu. m

Probe Data

Serial No. : 500-00283  
 Frequency Band : 1900  
 Duty Cycle Factor : 1  
 Conversion Factor : 4.8  
 Probe Sensitivity : 1.20 1.20 1.20  $\mu\text{V}/(\text{V}/\text{m})^2$   
 Compression Point : 95.00 mV  
 Offset : 1.56 mm

1 gram SAR value : 0.343 W/kg  
 10 gram SAR value : 0.186 W/kg  
 Area Scan Peak SAR : 0.436 W/kg  
 Zoom Scan Peak SAR : 0.649 W/kg

**Plot 19#**

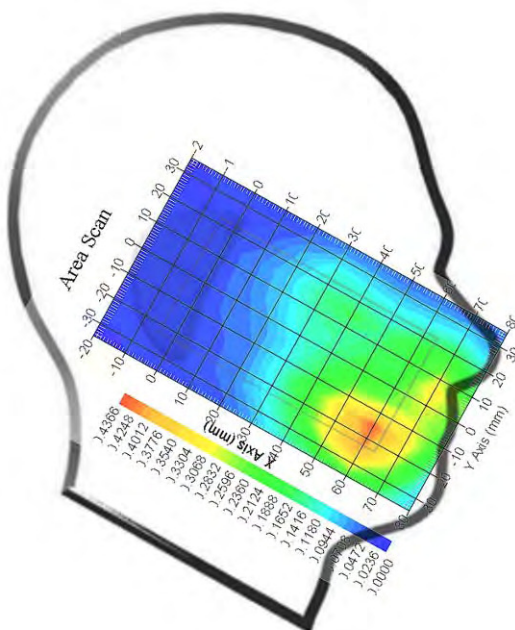

**Test Laboratory: Bay Area Compliance Lab Corp. (Shenzhen)**

**WCDMA1900; Left Head 15° Tilt (1880 MHz Middle Channel)**

Measurement Data

Test mode : WCDMA1900  
 Crest Factor : 1  
 Scan Type : Complete  
 Area Scan : 11x8x1: Measurement x=10mm, y=10mm, z=4mm  
 Zoom Scan : 5x5x7: Measurement x=8mm, y=8mm, z=5mm  
 Power Drift-Start : 0.102 W/kg  
 Power Drift-Finish : 0.101 W/kg  
 Power Drift (%) : -0.981

Tissue Data

Type : Head  
 Frequency : 1880 MHz  
 Epsilon : 38.71 F/m  
 Sigma : 1.42 S/m  
 Density : 1000.00 kg/cu. m

Probe Data

Serial No. : 500-00283  
 Frequency Band : 1900  
 Duty Cycle Factor : 1  
 Conversion Factor : 4.8  
 Probe Sensitivity : 1.20 1.20 1.20  $\mu\text{V}/(\text{V}/\text{m})^2$   
 Compression Point : 95.00 mV  
 Offset : 1.56 mm

1 gram SAR value : 0.194 W/kg  
 10 gram SAR value : 0.129 W/kg  
 Area Scan Peak SAR : 0.217 W/kg  
 Zoom Scan Peak SAR : 0.362 W/kg

**Plot 20#**

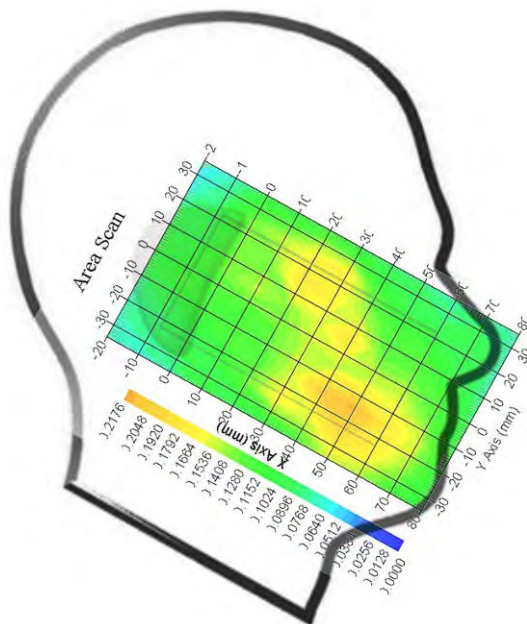

**Test Laboratory: Bay Area Compliance Lab Corp. (Shenzhen)**

**WCDMA1900; Right Head Cheek (1852.4 MHz Low Channel)**

Measurement Data

Test mode : WCDMA1900  
 Crest Factor : 1  
 Scan Type : Complete  
 Area Scan : 11x8x1: Measurement x=10mm, y=10mm, z=4mm  
 Zoom Scan : 5x5x7: Measurement x=8mm, y=8mm, z=5mm  
 Power Drift-Start : 0.017 W/kg  
 Power Drift-Finish : 0.007 W/kg  
 Power Drift (%) : -2.149

Tissue Data

Type : Head  
 Frequency : 1852.4 MHz  
 Epsilon : 38.23 F/m  
 Sigma : 1.41 S/m  
 Density : 1000.00 kg/cu. m

Probe Data

Serial No. : 500-00283  
 Frequency Band : 1900  
 Duty Cycle Factor : 1  
 Conversion Factor : 4.8  
 Probe Sensitivity : 1.20 1.20 1.20  $\mu\text{V}/(\text{V}/\text{m})^2$   
 Compression Point : 95.00 mV  
 Offset : 1.56 mm

1 gram SAR value : 0.354 W/kg  
 10 gram SAR value : 0.211 W/kg  
 Area Scan Peak SAR : 0.451 W/kg  
 Zoom Scan Peak SAR : 0.712 W/kg

**Plot 21#**

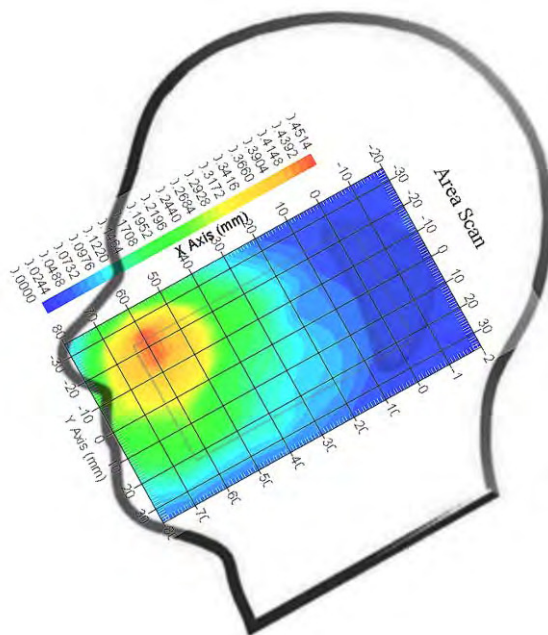



**Test Laboratory: Bay Area Compliance Lab Corp. (Shenzhen)**

**WCDMA1900; Right Head Cheek (1880 MHz Middle Channel)**

Measurement Data

Test mode : WCDMA1900  
 Crest Factor : 1  
 Scan Type : Complete  
 Area Scan : 11x8x1: Measurement x=10mm, y=10mm, z=4mm  
 Zoom Scan : 5x5x7: Measurement x=8mm, y=8mm, z=5mm  
 Power Drift-Start : 0.016 W/kg  
 Power Drift-Finish : 0.016 W/kg  
 Power Drift (%) : -1.337

Tissue Data

Type : Head  
 Frequency : 1880 MHz  
 Epsilon : 38.71 F/m  
 Sigma : 1.42 S/m  
 Density : 1000.00 kg/cu. m

Probe Data

Serial No. : 500-00283  
 Frequency Band : 1900  
 Duty Cycle Factor : 1  
 Conversion Factor : 4.8  
 Probe Sensitivity : 1.20 1.20 1.20  $\mu\text{V}/(\text{V}/\text{m})^2$   
 Compression Point : 95.00 mV  
 Offset : 1.56 mm

1 gram SAR value : 0.402 W/kg  
 10 gram SAR value : 0.216 W/kg  
 Area Scan Peak SAR : 0.488 W/kg  
 Zoom Scan Peak SAR : 0.763 W/kg

**Plot 22#**

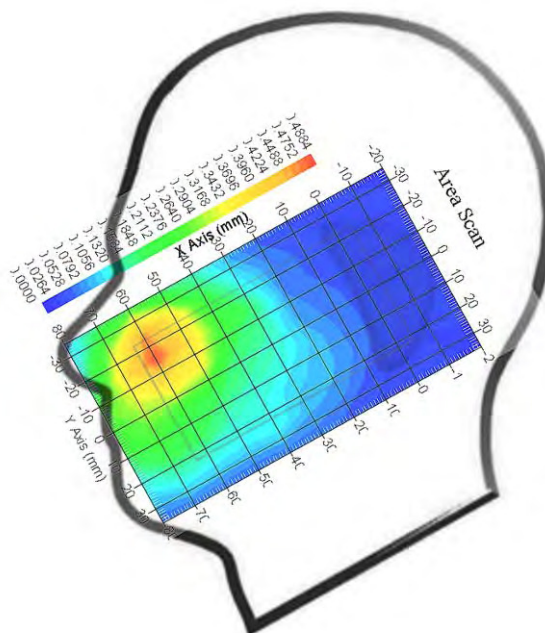

**Test Laboratory: Bay Area Compliance Lab Corp. (Shenzhen)**

**WCDMA1900; Right Head Cheek (1907.6 MHz High Channel)**

Measurement Data

Test mode : WCDMA1900  
 Crest Factor : 1  
 Scan Type : Complete  
 Area Scan : 11x8x1: Measurement x=10mm, y=10mm, z=4mm  
 Zoom Scan : 5x5x7: Measurement x=8mm, y=8mm, z=5mm  
 Power Drift-Start : 0.018 W/kg  
 Power Drift-Finish : 0.018 W/kg  
 Power Drift (%) : -2.003

Tissue Data

Type : Head  
 Frequency : 1907.6 MHz  
 Epsilon : 38.63 F/m  
 Sigma : 1.40 S/m  
 Density : 1000.00 kg/cu. m

Probe Data

Serial No. : 500-00283  
 Frequency Band : 1900  
 Duty Cycle Factor : 1  
 Conversion Factor : 4.8  
 Probe Sensitivity : 1.20 1.20 1.20  $\mu\text{V}/(\text{V}/\text{m})^2$   
 Compression Point : 95.00 mV  
 Offset : 1.56 mm

1 gram SAR value : 0.363 W/kg  
 10 gram SAR value : 0.192 W/kg  
 Area Scan Peak SAR : 0.462 W/kg  
 Zoom Scan Peak SAR : 0.686 W/kg

**Plot 23#**

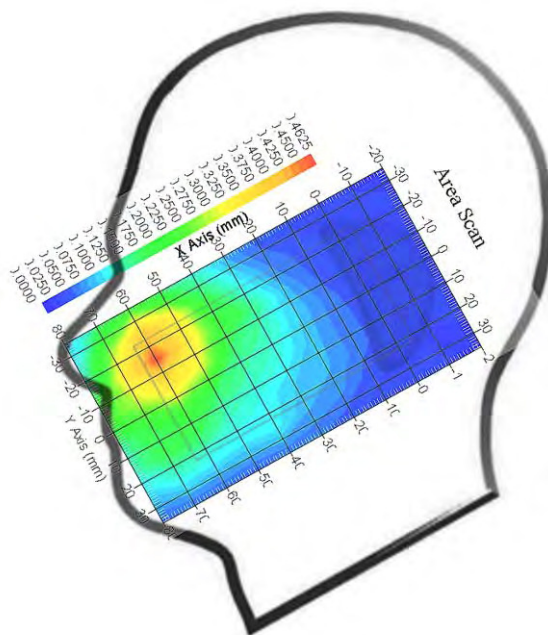

**Test Laboratory: Bay Area Compliance Lab Corp. (Shenzhen)**

**WCDMA1900; Right Head 15° Tilt (1880 MHz Middle Channel)**

Measurement Data

Test mode : WCDMA1900  
 Crest Factor : 1  
 Scan Type : Complete  
 Area Scan : 11x8x1: Measurement x=10mm, y=10mm, z=4mm  
 Zoom Scan : 5x5x7: Measurement x=8mm, y=8mm, z=5mm  
 Power Drift-Start : 0.086 W/kg  
 Power Drift-Finish : 0.085 W/kg  
 Power Drift (%) : -1.163

Tissue Data

Type : Head  
 Frequency : 1880 MHz  
 Epsilon : 38.71 F/m  
 Sigma : 1.42 S/m  
 Density : 1000.00 kg/cu. m

Probe Data

Serial No. : 500-00283  
 Frequency Band : 1900  
 Duty Cycle Factor : 1  
 Conversion Factor : 4.8  
 Probe Sensitivity : 1.20 1.20 1.20  $\mu\text{V}/(\text{V}/\text{m})^2$   
 Compression Point : 95.00 mV  
 Offset : 1.56 mm

1 gram SAR value : 0.160 W/kg  
 10 gram SAR value : 0.104 W/kg  
 Area Scan Peak SAR : 0.217 W/kg  
 Zoom Scan Peak SAR : 0.336 W/kg

**Plot 24#**

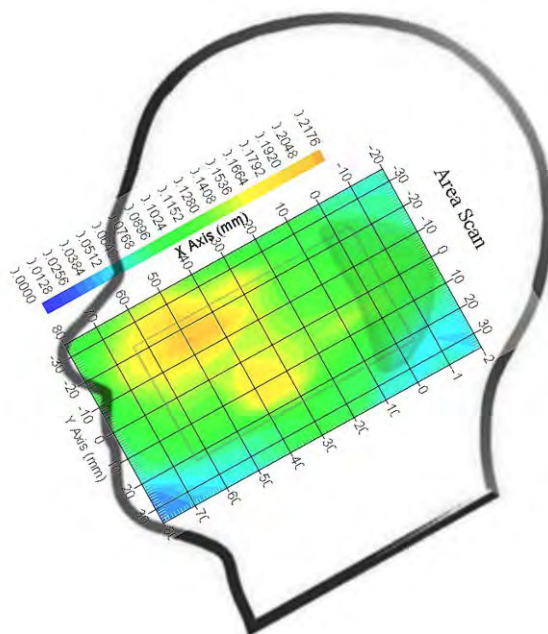

**Test Laboratory: Bay Area Compliance Lab Corp. (Shenzhen)**

**Body-Back-Headset (836.6 MHz Middle Channel)**

Measurement Data

Test mode : GSM  
 Crest Factor : 8  
 Scan Type : Complete  
 Area Scan : 9x11x1: Measurement x=10mm, y=10mm, z=4mm  
 Zoom Scan : 5x5x7: Measurement x=8mm, y=8mm, z=5mm  
 Power Drift-Start : 0.243 W/kg  
 Power Drift-Finish : 0.248 W/kg  
 Power Drift (%) : 2.057

Tissue Data

Type : Body  
 Frequency : 836.6 MHz  
 Epsilon : 53.88 F/m  
 Sigma : 0.98 S/m  
 Density : 1000.00 kg/cu. m

Probe Data

Serial No. : 500-00283  
 Frequency Band : 835  
 Duty Cycle Factor : 8  
 Conversion Factor : 5.9  
 Probe Sensitivity : 1.20 1.20 1.20  $\mu\text{V}/(\text{V}/\text{m})^2$   
 Compression Point : 95.00 mV  
 Offset : 1.56 mm

1 gram SAR value : 0.292 W/kg  
 10 gram SAR value : 0.195 W/kg  
 Area Scan Peak SAR : 0.352 W/kg  
 Zoom Scan Peak SAR : 0.510 W/kg

**Plot 25#**

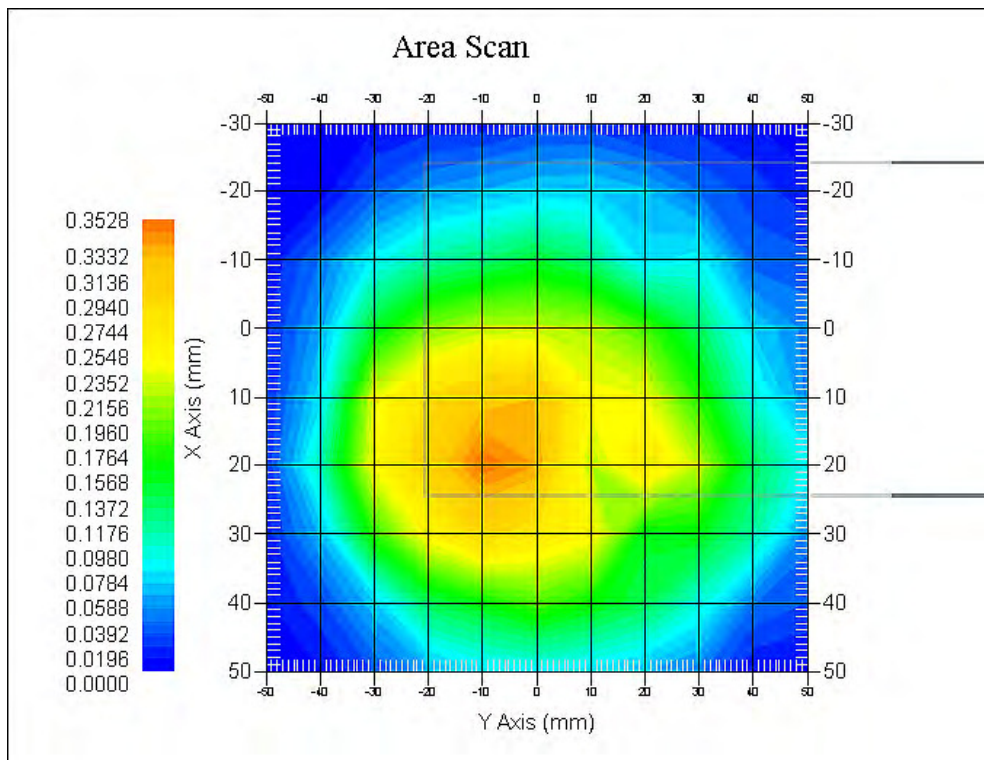

**Test Laboratory: Bay Area Compliance Lab Corp. (Shenzhen)**

**Body-worn-Back (824.2 MHz Low Channel)**

Measurement Data

Test mode : GPRS  
 Crest Factor : 2.67  
 Scan Type : Complete  
 Area Scan : 9x11x1: Measurement x=10mm, y=10mm, z=4mm  
 Zoom Scan : 5x5x7: Measurement x=8mm, y=8mm, z=5mm  
 Power Drift-Start : 0.575 W/kg  
 Power Drift-Finish : 0.571 W/kg  
 Power Drift (%) : -0.695

Tissue Data

Type : Body  
 Frequency : 824.2 MHz  
 Epsilon : 53.74 F/m  
 Sigma : 0.99 S/m  
 Density : 1000.00 kg/cu. m

Probe Data

Serial No. : 500-00283  
 Frequency Band : 835  
 Duty Cycle Factor : 2.67  
 Conversion Factor : 5.9  
 Probe Sensitivity : 1.20 1.20 1.20  $\mu\text{V}/(\text{V}/\text{m})^2$   
 Compression Point : 95.00 mV  
 Offset : 1.56 mm

1 gram SAR value : 0.615 W/kg  
 10 gram SAR value : 0.401 W/kg  
 Area Scan Peak SAR : 0.687 W/kg  
 Zoom Scan Peak SAR : 0.920 W/kg

**Plot 26#**

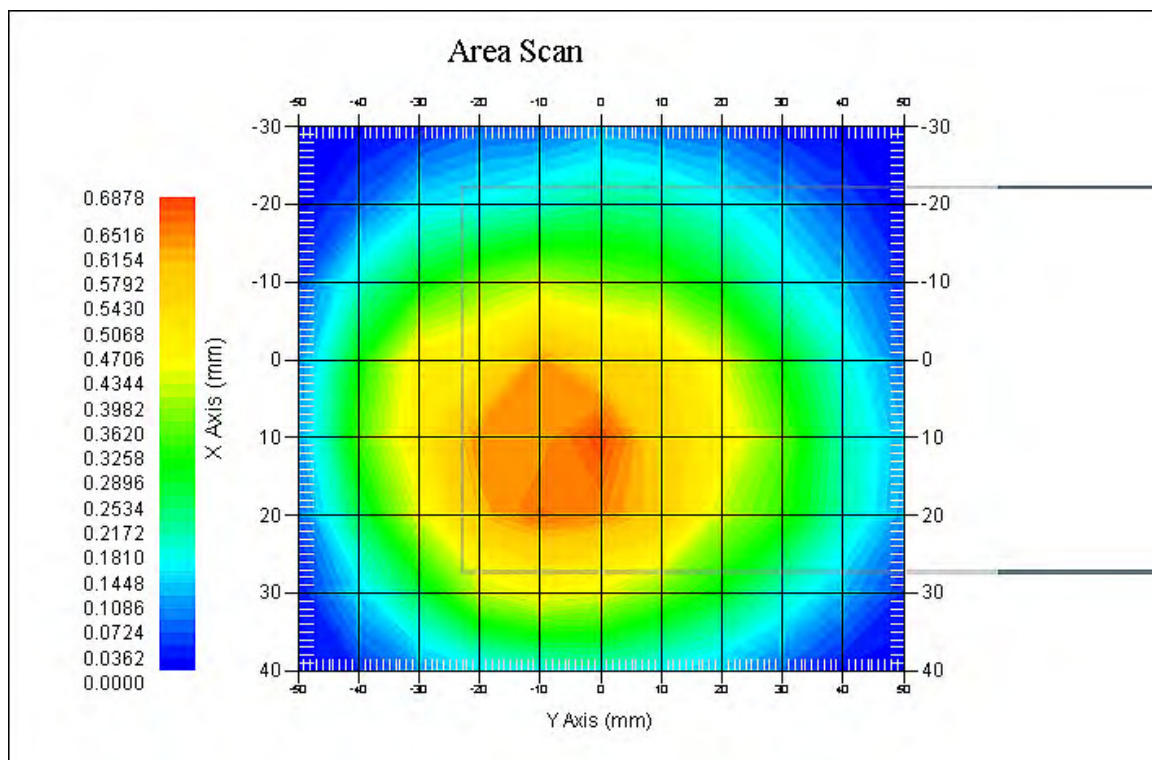

**Test Laboratory: Bay Area Compliance Lab Corp. (Shenzhen)**

**Body-worn-Back (836.6 MHz Middle Channel)**

Measurement Data

Test mode : GPRS  
 Crest Factor : 2.67  
 Scan Type : Complete  
 Area Scan : 9x11x1: Measurement x=10mm, y=10mm, z=4mm  
 Zoom Scan : 5x5x7: Measurement x=8mm, y=8mm, z=5mm  
 Power Drift-Start : 0.712 W/kg  
 Power Drift-Finish : 0.700 W/kg  
 Power Drift (%) : -1.685

Tissue Data

Type : Body  
 Frequency : 836.6 MHz  
 Epsilon : 53.88 F/m  
 Sigma : 0.98 S/m  
 Density : 1000.00 kg/cu. m

Probe Data

Serial No. : 500-00283  
 Frequency Band : 835  
 Duty Cycle Factor : 2.67  
 Conversion Factor : 5.9  
 Probe Sensitivity : 1.20 1.20 1.20  $\mu\text{V}/(\text{V}/\text{m})^2$   
 Compression Point : 95.00 mV  
 Offset : 1.56 mm

1 gram SAR value : 0.776 W/kg  
 10 gram SAR value : 0.453 W/kg  
 Area Scan Peak SAR : 0.797 W/kg  
 Zoom Scan Peak SAR : 1.265 W/kg

**Plot 27#**

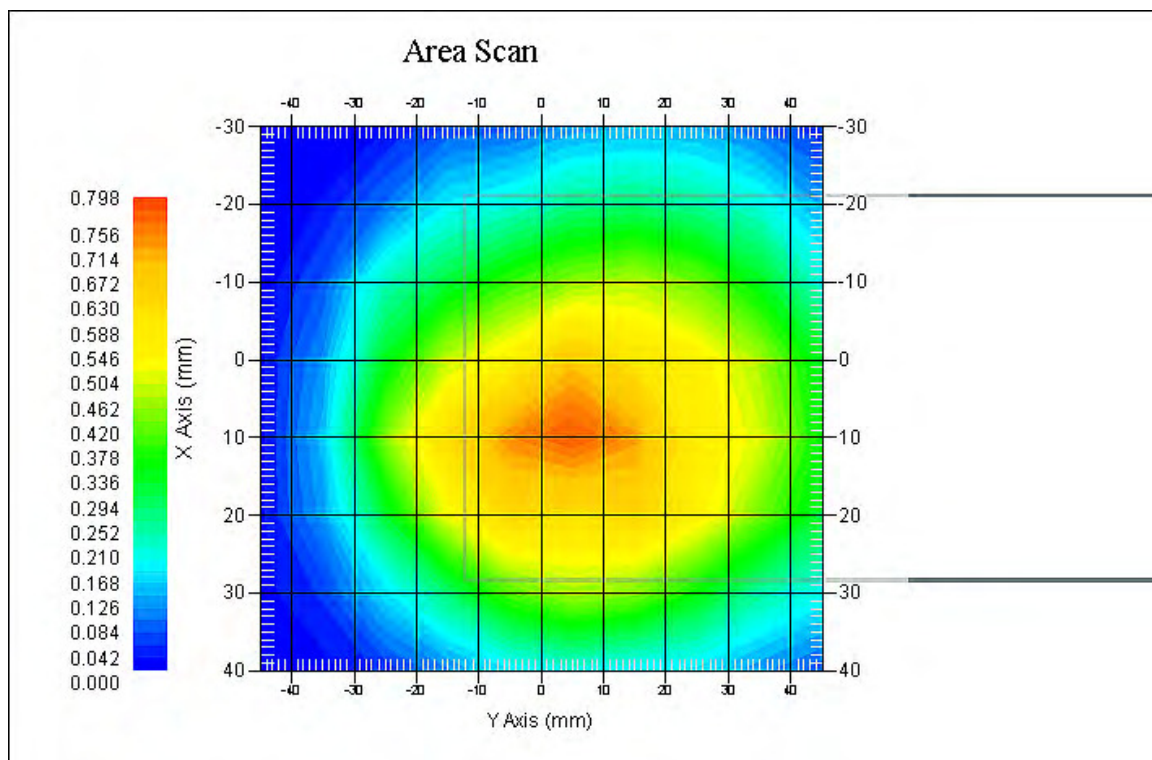

**Test Laboratory: Bay Area Compliance Lab Corp. (Shenzhen)**

**Body-worn-Back (848.8 MHz High Channel)**

Measurement Data

Test mode : GPRS  
 Crest Factor : 2.67  
 Scan Type : Complete  
 Area Scan : 9x11x1: Measurement x=10mm, y=10mm, z=4mm  
 Zoom Scan : 5x5x7: Measurement x=8mm, y=8mm, z=5mm  
 Power Drift-Start : 0.698 W/kg  
 Power Drift-Finish : 0.709 W/kg  
 Power Drift (%) : 1.576

Tissue Data

Type : Body  
 Frequency : 848.8 MHz  
 Epsilon : 53.41 F/m  
 Sigma : 0.98 S/m  
 Density : 1000.00 kg/cu. m

Probe Data

Serial No. : 500-00283  
 Frequency Band : 835  
 Duty Cycle Factor : 2.67  
 Conversion Factor : 5.9  
 Probe Sensitivity : 1.20 1.20 1.20  $\mu\text{V}/(\text{V}/\text{m})^2$   
 Compression Point : 95.00 mV  
 Offset : 1.56 mm

1 gram SAR value : 0.755 W/kg  
 10 gram SAR value : 0.469 W/kg  
 Area Scan Peak SAR : 0.779 W/kg  
 Zoom Scan Peak SAR : 1.176 W/kg

**Plot 28#**

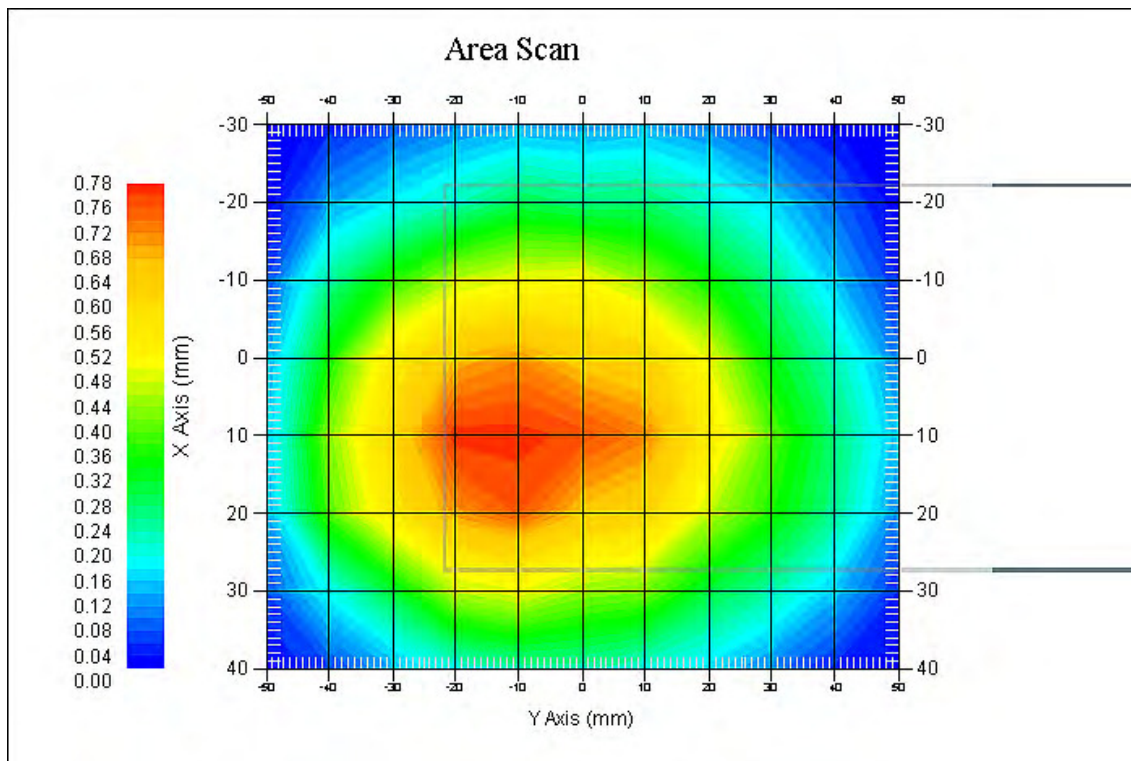

**Test Laboratory: Bay Area Compliance Lab Corp. (Shenzhen)**

**Body-worn-Left (836.6 MHz Middle Channel)**

Measurement Data

Test mode : GPRS  
 Crest Factor : 2.67  
 Scan Type : Complete  
 Area Scan : 7x10x1: Measurement x=10mm, y=10mm, z=4mm  
 Zoom Scan : 5x5x7: Measurement x=8mm, y=8mm, z=5mm  
 Power Drift-Start : 0.265 W/kg  
 Power Drift-Finish : 0.270 W/kg  
 Power Drift (%) : 1.886

Tissue Data

Type : Body  
 Frequency : 836.6 MHz  
 Epsilon : 53.88 F/m  
 Sigma : 0.98 S/m  
 Density : 1000.00 kg/cu. m

Probe Data

Serial No. : 500-00283  
 Frequency Band : 835  
 Duty Cycle Factor : 2.67  
 Conversion Factor : 5.9  
 Probe Sensitivity : 1.20 1.20 1.20  $\mu\text{V}/(\text{V}/\text{m})^2$   
 Compression Point : 95.00 mV  
 Offset : 1.56 mm

1 gram SAR value : 0.339 W/kg  
 10 gram SAR value : 0.221 W/kg  
 Area Scan Peak SAR : 0.400 W/kg  
 Zoom Scan Peak SAR : 0.612 W/kg

**Plot 29#**

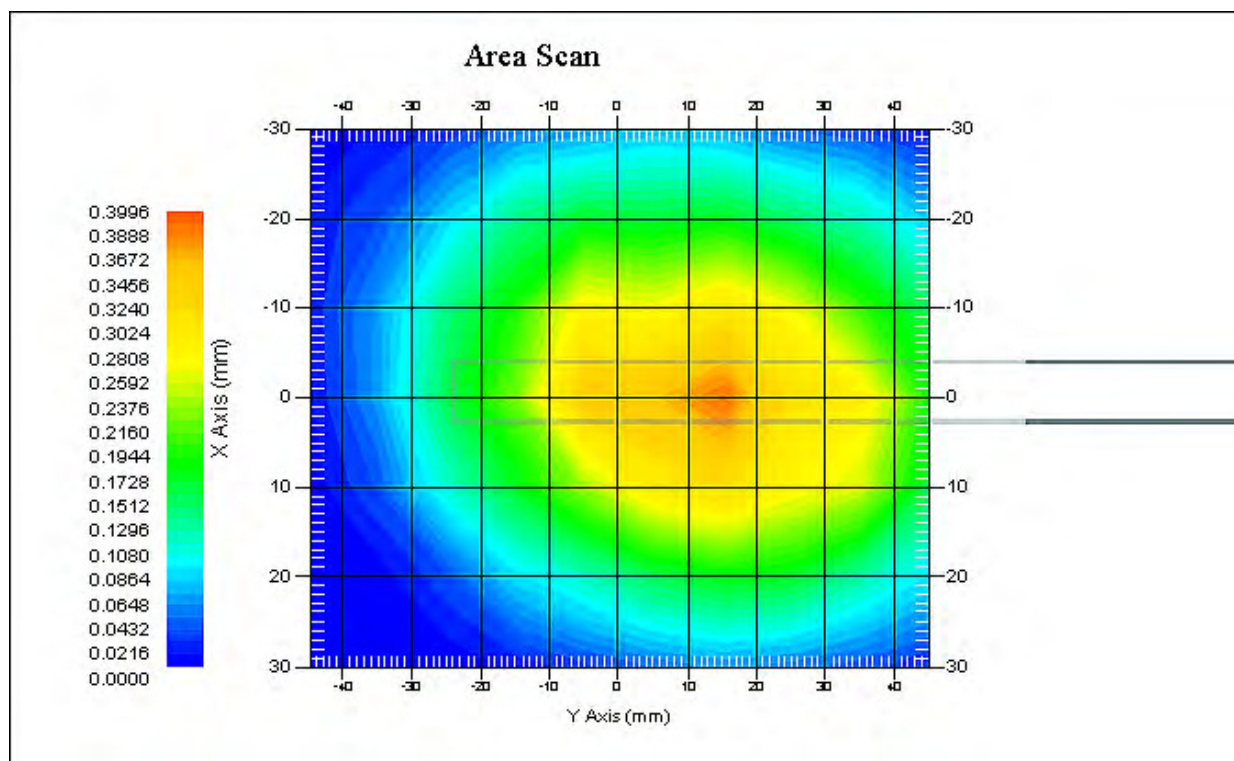



**Test Laboratory: Bay Area Compliance Lab Corp. (Shenzhen)**

**Body-worn-Right (836.6 MHz Middle Channel)**

Measurement Data

Test mode : GPRS  
 Crest Factor : 2.67  
 Scan Type : Complete  
 Area Scan : 7x9x1: Measurement x=10mm, y=10mm, z=4mm  
 Zoom Scan : 5x5x7: Measurement x=8mm, y=8mm, z=5mm  
 Power Drift-Start : 0.248 W/kg  
 Power Drift-Finish : 0.253 W/kg  
 Power Drift (%) : 2.016

Tissue Data

Type : Body  
 Frequency : 836.6 MHz  
 Epsilon : 53.88 F/m  
 Sigma : 0.98 S/m  
 Density : 1000.00 kg/cu. m

Probe Data

Serial No. : 500-00283  
 Frequency Band : 835  
 Duty Cycle Factor : 2.67  
 Conversion Factor : 5.9  
 Probe Sensitivity : 1.20 1.20 1.20  $\mu\text{V}/(\text{V}/\text{m})^2$   
 Compression Point : 95.00 mV  
 Offset : 1.56 mm

1 gram SAR value : 0.258 W/kg  
 10 gram SAR value : 0.191 W/kg  
 Area Scan Peak SAR : 0.313 W/kg  
 Zoom Scan Peak SAR : 0.476 W/kg

**Plot 30#**

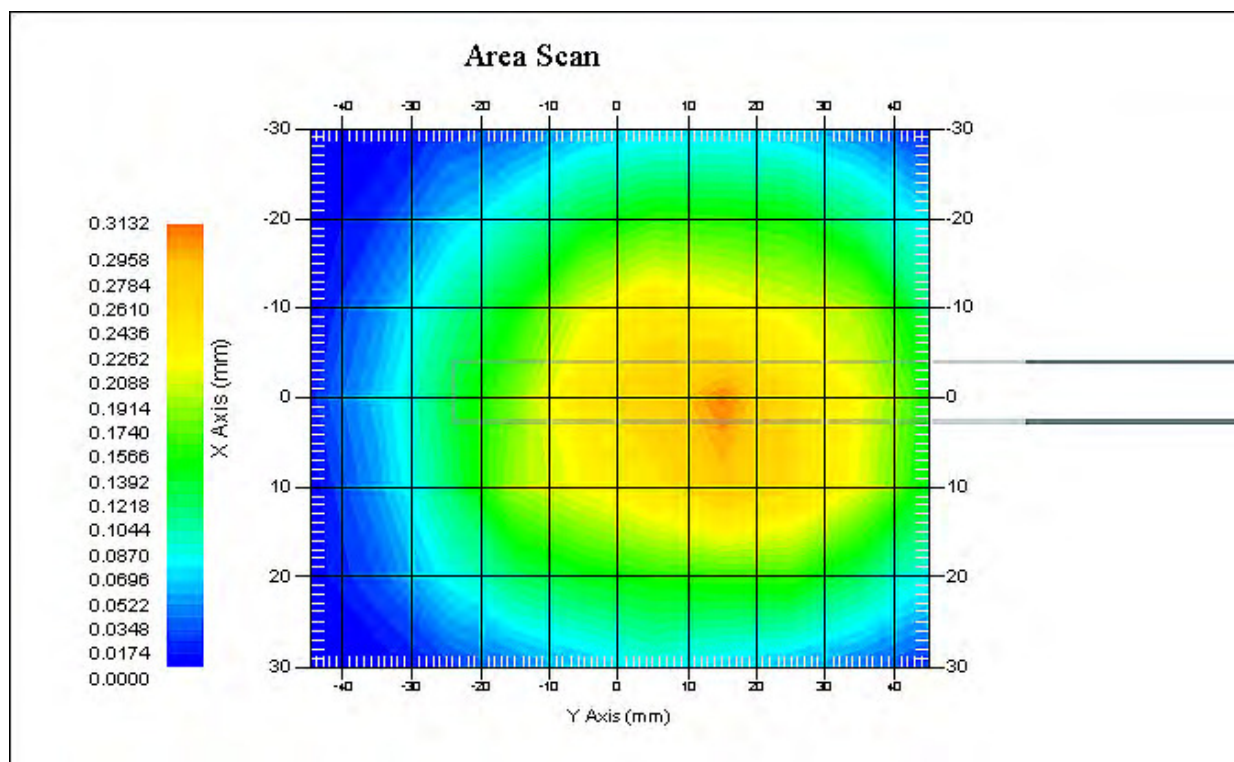

**Test Laboratory: Bay Area Compliance Lab Corp. (Shenzhen)**

**Body-worn-Bottom (836.6 MHz Middle Channel)**

Measurement Data

Test mode : GPRS  
 Crest Factor : 2.67  
 Scan Type : Complete  
 Area Scan : 7x10x1: Measurement x=10mm, y=10mm, z=4mm  
 Zoom Scan : 5x5x7: Measurement x=8mm, y=8mm, z=5mm  
 Power Drift-Start : 0.163 W/kg  
 Power Drift-Finish : 0.160 W/kg  
 Power Drift (%) : -1.840

Tissue Data

Type : Body  
 Frequency : 836.6 MHz  
 Epsilon : 53.88 F/m  
 Sigma : 0.98 S/m  
 Density : 1000.00 kg/cu. m

Probe Data

Serial No. : 500-00283  
 Frequency Band : 835  
 Duty Cycle Factor : 2.67  
 Conversion Factor : 5.9  
 Probe Sensitivity : 1.20 1.20 1.20  $\mu\text{V}/(\text{V}/\text{m})^2$   
 Compression Point : 95.00 mV  
 Offset : 1.56 mm

1 gram SAR value : 0.336 W/kg  
 10 gram SAR value : 0.132 W/kg  
 Area Scan Peak SAR : 0.370 W/kg  
 Zoom Scan Peak SAR : 0.558 W/kg

**Plot 31#**

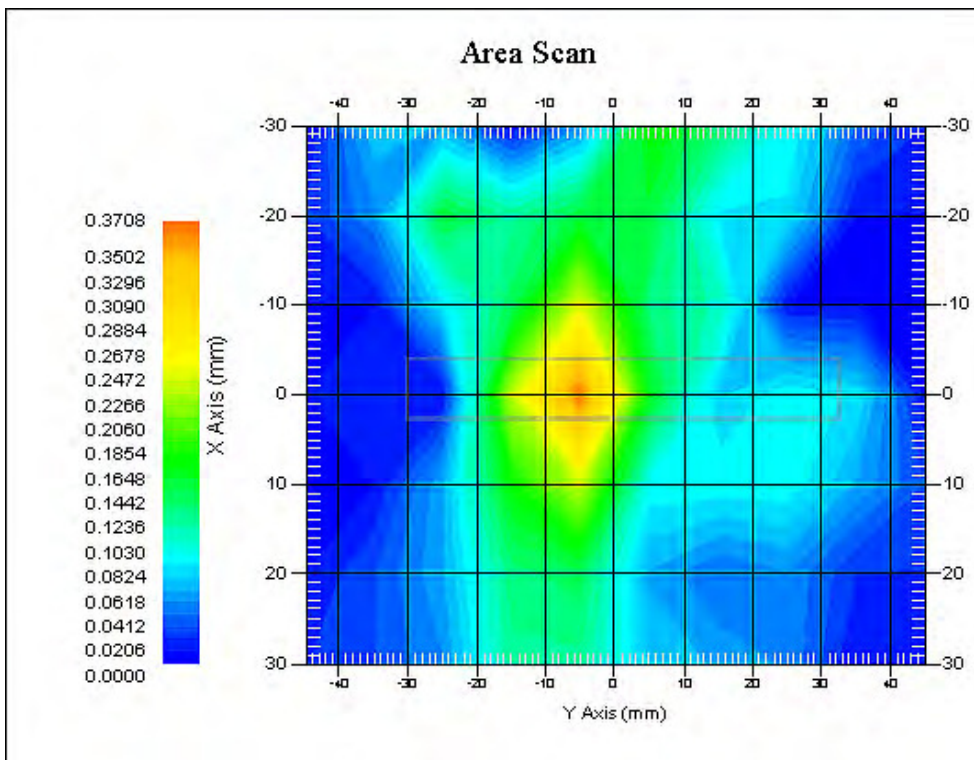

**Test Laboratory: Bay Area Compliance Lab Corp. (Shenzhen)**

**Body-Back-Headset (1880.0 MHz Middle Channel)**

Measurement Data

Test mode : GSM  
 Crest Factor : 8  
 Scan Type : Complete  
 Area Scan : 9x11x1: Measurement x=10mm, y=10mm, z=4mm  
 Zoom Scan : 5x5x7: Measurement x=8mm, y=8mm, z=5mm  
 Power Drift-Start : 0.153 W/kg  
 Power Drift-Finish : 0.152 W/kg  
 Power Drift (%) : -0.654

Tissue Data

Type : Body  
 Frequency : 1880.0 MHz  
 Epsilon : 51.65 F/m  
 Sigma : 1.53 S/m  
 Density : 1000.00 kg/cu. m

Probe Data

Serial No. : 500-00283  
 Frequency Band : 1900  
 Duty Cycle Factor : 8  
 Conversion Factor : 4.8  
 Probe Sensitivity : 1.20 1.20 1.20  $\mu\text{V}/(\text{V}/\text{m})^2$   
 Compression Point : 95.00 mV  
 Offset : 1.56 mm

1 gram SAR value : 0.301 W/kg  
 10 gram SAR value : 0.186 W/kg  
 Area Scan Peak SAR : 0.388 W/kg  
 Zoom Scan Peak SAR : 0.574 W/kg

**Plot 32#**

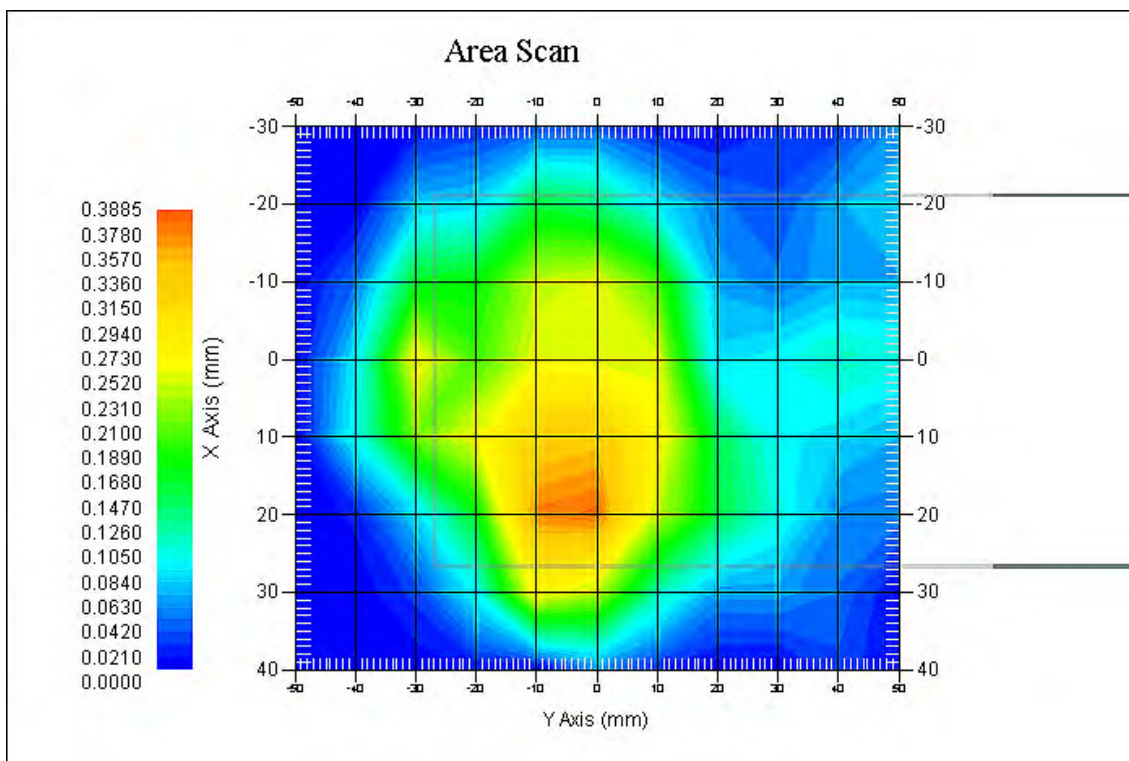

**Test Laboratory: Bay Area Compliance Lab Corp. (Shenzhen)**

**Body-worn-Back (1850.2 MHz Low Channel)**

Measurement Data

Test mode : GPRS  
 Crest Factor : 2.67  
 Scan Type : Complete  
 Area Scan : 9x12x1 : Measurement x=10mm, y=10mm, z=4mm  
 Zoom Scan : 7x7x7 : Measurement x=5mm, y=5mm, z=5mm  
 Power Drift-Start : 0.602 W/kg  
 Power Drift-Finish : 0.597 W/kg  
 Power Drift (%) : -0.854  
 Tissue Data  
 Type : Body  
 Frequency : 1850.2 MHz  
 Epsilon : 52.01 F/m  
 Sigma : 1.53 S/m  
 Density : 1000.00 kg/cu. m

Probe Data

Serial No. : 500-00283  
 Frequency Band : 1900  
 Duty Cycle Factor : 2.67  
 Conversion Factor : 4.8  
 Probe Sensitivity : 1.20 1.20 1.20  $\mu\text{V}/(\text{V}/\text{m})^2$   
 Compression Point : 95.00 mV  
 Offset : 1.56 mm

1 gram SAR value : 0.674 W/kg  
 10 gram SAR value : 0.405 W/kg  
 Area Scan Peak SAR : 0.719 W/kg  
 Zoom Scan Peak SAR : 1.302 W/kg

**Plot 33#**

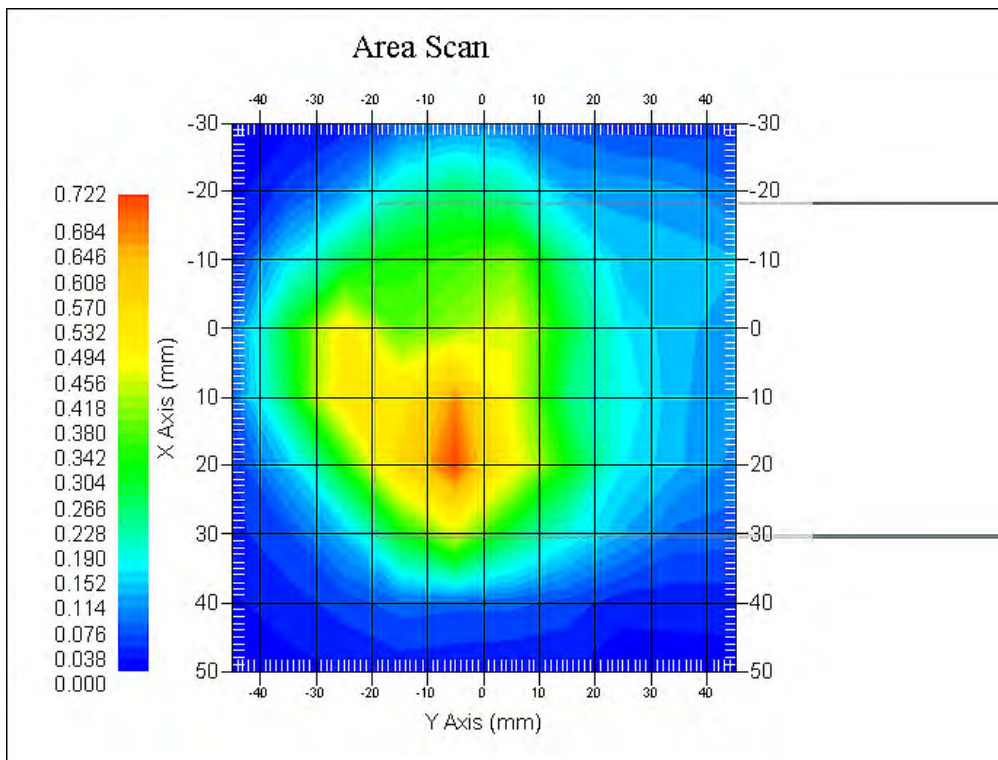

**Test Laboratory: Bay Area Compliance Lab Corp. (Shenzhen)**

**Body-worn-Back (1880.0 MHz Middle Channel)**

Measurement Data

Test mode : GPRS  
 Crest Factor : 2.67  
 Scan Type : Complete  
 Area Scan : 8x10x1 : Measurement x=10mm, y=10mm, z=4mm  
 Zoom Scan : 7x7x7 : Measurement x=5mm, y=5mm, z=5mm  
 Power Drift-Start : 0.695 W/kg  
 Power Drift-Finish : 0.684 W/kg  
 Power Drift (%) : -1.583

Tissue Data

Type : Body  
 Frequency : 1880.0 MHz  
 Epsilon : 51.65 F/m  
 Sigma : 1.52 S/m  
 Density : 1000.00 kg/cu. m

Probe Data

Serial No. : 500-00283  
 Frequency Band : 1900  
 Duty Cycle Factor : 2.67  
 Conversion Factor : 4.8  
 Probe Sensitivity : 1.20 1.20 1.20  $\mu\text{V}/(\text{V}/\text{m})^2$   
 Compression Point : 95.00 mV  
 Offset : 1.56 mm

1 gram SAR value : 0.724 W/kg  
 10 gram SAR value : 0.433 W/kg  
 Area Scan Peak SAR : 0.797 W/kg  
 Zoom Scan Peak SAR : 1.329 W/kg

**Plot 34#**

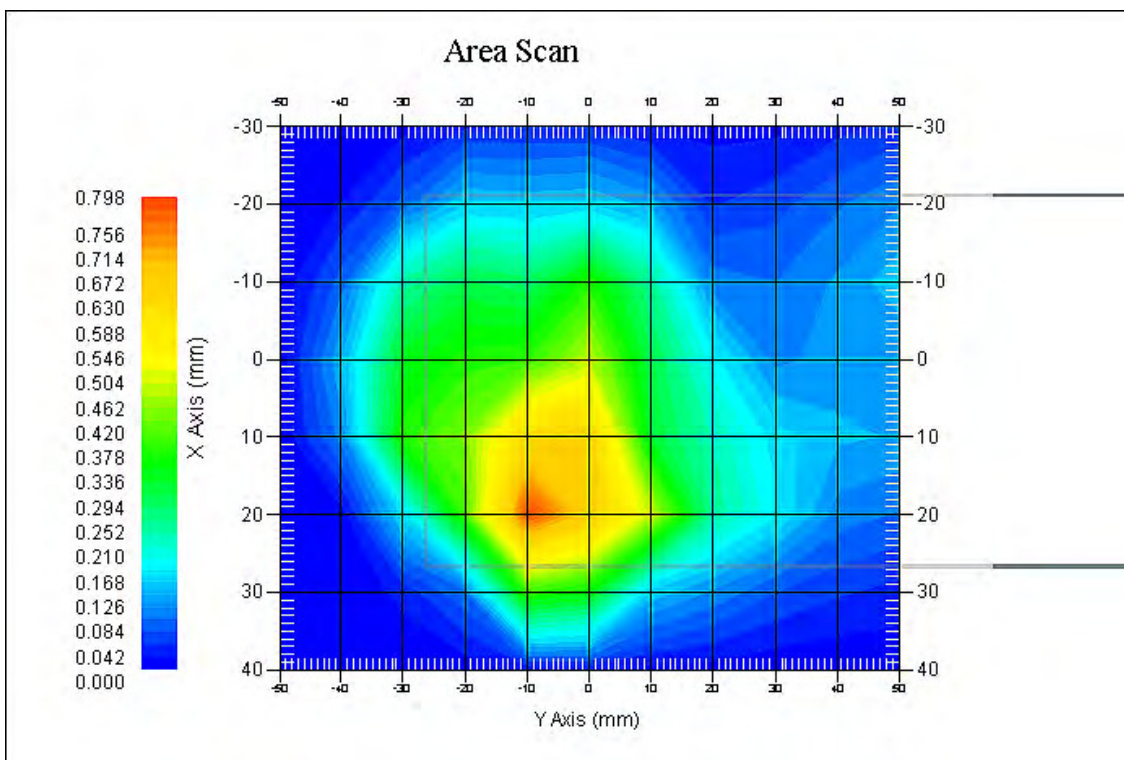

**Test Laboratory: Bay Area Compliance Lab Corp. (Shenzhen)**

**Body-worn-Back (1909.8 MHz High Channel)**

Measurement Data

Test mode : GPRS  
 Crest Factor : 2.67  
 Scan Type : Complete  
 Area Scan : 8x10x1 : Measurement x=10mm, y=10mm, z=4mm  
 Zoom Scan : 7x7x7 : Measurement x=5mm, y=5mm, z=5mm  
 Power Drift-Start : 0.718 W/kg  
 Power Drift-Finish : 0.703 W/kg  
 Power Drift (%) : -2.089

Tissue Data

Type : Body  
 Frequency : 1909.8 MHz  
 Epsilon : 51.64 F/m  
 Sigma : 1.53 S/m  
 Density : 1000.00 kg/cu. m

Probe Data

Serial No. : 500-00283  
 Frequency Band : 1900  
 Duty Cycle Factor : 2.67  
 Conversion Factor : 4.8  
 Probe Sensitivity : 1.20 1.20 1.20  $\mu\text{V}/(\text{V}/\text{m})^2$   
 Compression Point : 95.00 mV  
 Offset : 1.56 mm

1 gram SAR value : 0.794 W/kg  
 10 gram SAR value : 0.453 W/kg  
 Area Scan Peak SAR : 0.909 W/kg  
 Zoom Scan Peak SAR : 1.477 W/kg

**Plot 35#**

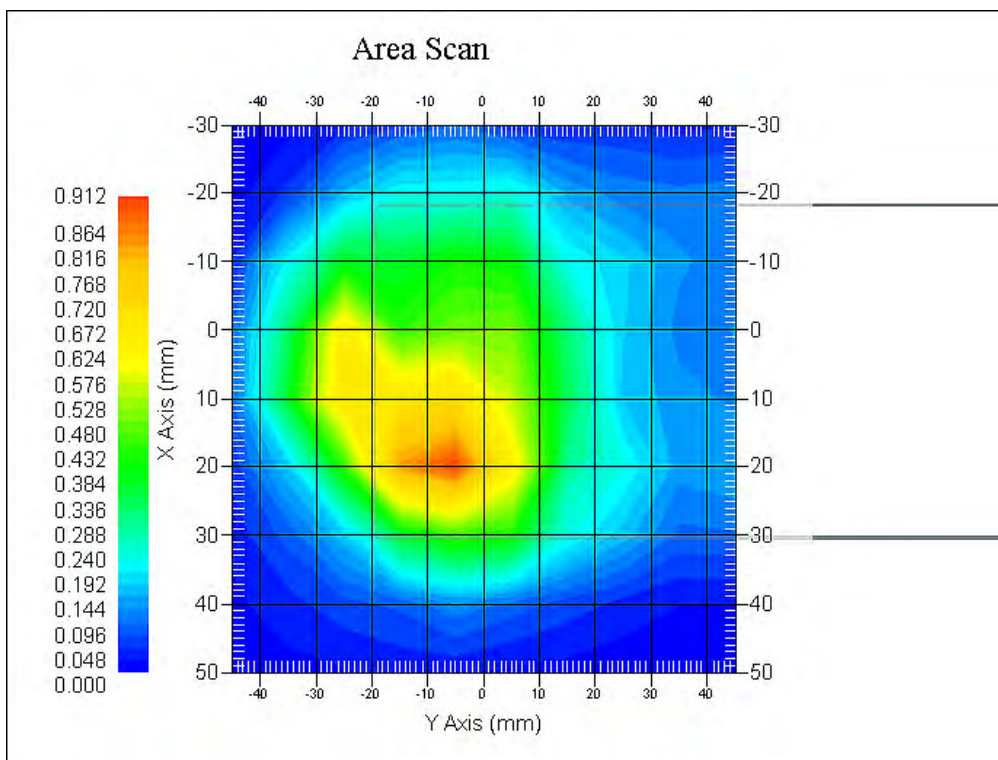

**Test Laboratory: Bay Area Compliance Lab Corp. (Shenzhen)**

**Body-worn-Left (1880 MHz Middle Channel)**

Measurement Data

Test mode : GPRS  
 Crest Factor : 2.67  
 Scan Type : Complete  
 Area Scan : 7x10x1 : Measurement x=10mm, y=10mm, z=4mm  
 Zoom Scan : 7x7x7 : Measurement x=5mm, y=5mm, z=5mm  
 Power Drift-Start : 0.205 W/kg  
 Power Drift-Finish : 0.203 W/kg  
 Power Drift (%) : -0.975

Tissue Data

Type : Body  
 Frequency : 1880 MHz  
 Epsilon : 51.65 F/m  
 Sigma : 1.53 S/m  
 Density : 1000.00 kg/cu. m

Probe Data

Serial No. : 500-00283  
 Frequency Band : 1900  
 Duty Cycle Factor : 2.67  
 Conversion Factor : 4.8  
 Probe Sensitivity : 1.20 1.20 1.20  $\mu\text{V}/(\text{V/m})^2$   
 Compression Point : 95.00 mV  
 Offset : 1.56 mm

1 gram SAR value : 0.347 W/kg  
 10 gram SAR value : 0.153 W/kg  
 Area Scan Peak SAR : 0.410 W/kg  
 Zoom Scan Peak SAR : 0.639 W/kg

**Plot 36#**

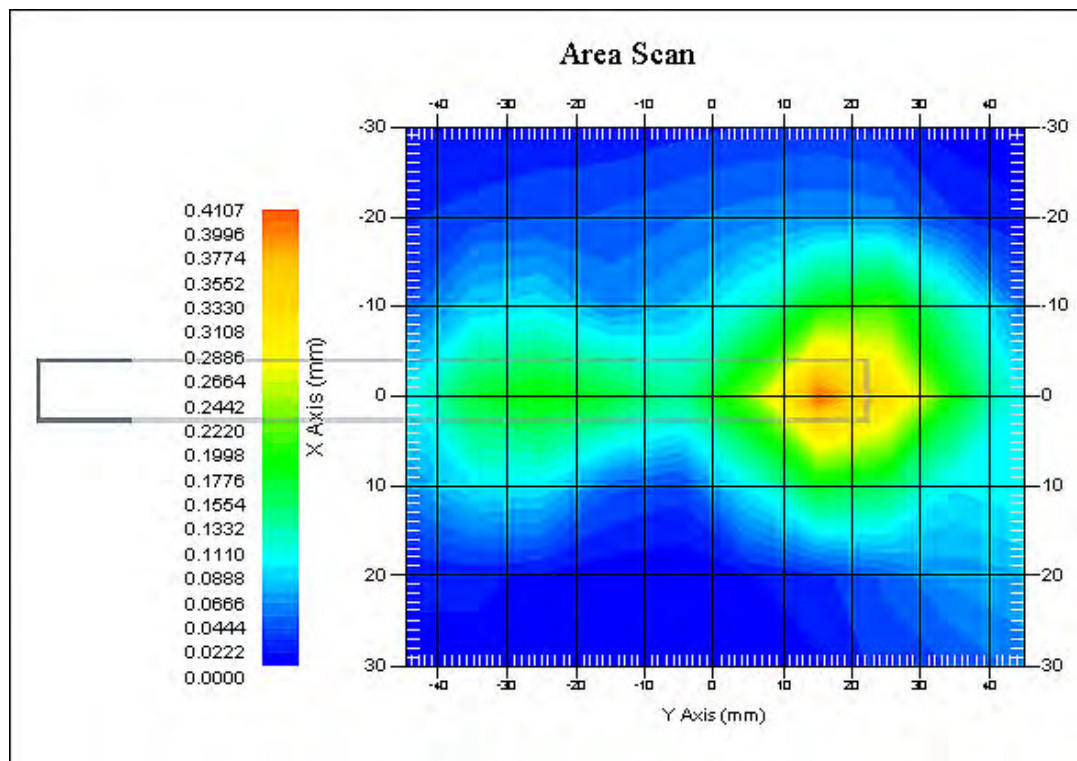

**Test Laboratory: Bay Area Compliance Lab Corp. (Shenzhen)**

**Body-worn-Right (1880 MHz Middle Channel)**

Measurement Data

Test mode : GPRS  
 Crest Factor : 2.67  
 Scan Type : Complete  
 Area Scan : 8x11x1 : Measurement x=10mm, y=10mm, z=4mm  
 Zoom Scan : 7x7x7 : Measurement x=5mm, y=5mm, z=5mm  
 Power Drift-Start : 0.298 W/kg  
 Power Drift-Finish : 0.304 W/kg  
 Power Drift (%) : 2.013

Tissue Data

Type : Body  
 Frequency : 1880 MHz  
 Epsilon : 51.65 F/m  
 Sigma : 1.53 S/m  
 Density : 1000.00 kg/cu. m

Probe Data

Serial No. : 500-00283  
 Frequency Band : 1900  
 Duty Cycle Factor : 2.67  
 Conversion Factor : 4.8  
 Probe Sensitivity : 1.20 1.20 1.20  $\mu\text{V}/(\text{V}/\text{m})^2$   
 Compression Point : 95.00 mV  
 Offset : 1.56 mm

1 gram SAR value : 0.401 W/kg  
 10 gram SAR value : 0.235 W/kg  
 Area Scan Peak SAR : 0.436 W/kg  
 Zoom Scan Peak SAR : 0.695 W/kg

**Plot 37#**

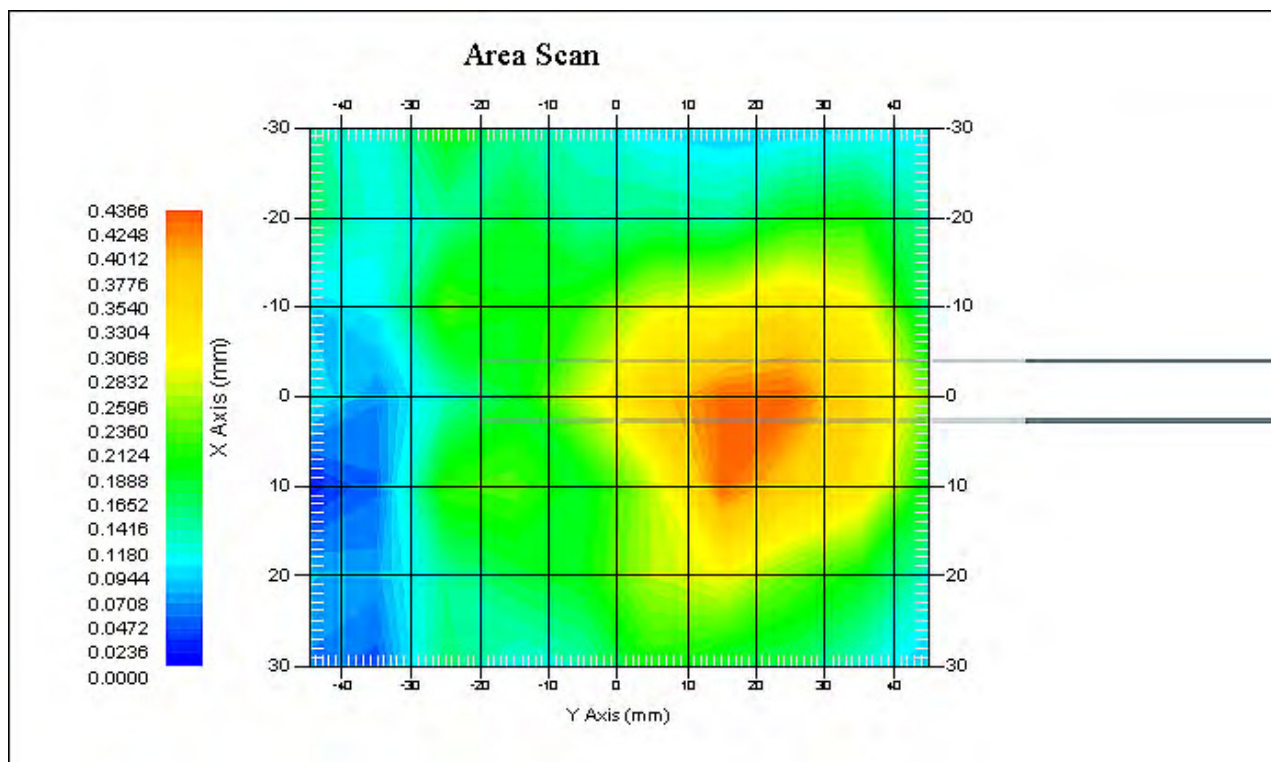



**Test Laboratory: Bay Area Compliance Lab Corp. (Shenzhen)**

**Body-worn-Bottom (1880 MHz Middle Channel)**

Measurement Data

Test mode : GPRS  
 Crest Factor : 2.67  
 Scan Type : Complete  
 Area Scan : 7x11x1 : Measurement x=10mm, y=10mm, z=4mm  
 Zoom Scan : 7x7x7 : Measurement x=5mm, y=5mm, z=5mm  
 Power Drift-Start : 0.315 W/kg  
 Power Drift-Finish : 0.310 W/kg  
 Power Drift (%) : -1.587

Tissue Data

Type : Body  
 Frequency : 1880 MHz  
 Epsilon : 51.65 F/m  
 Sigma : 1.53 S/m  
 Density : 1000.00 kg/cu. m

Probe Data

Serial No. : 500-00283  
 Frequency Band : 1900  
 Duty Cycle Factor : 2.67  
 Conversion Factor : 4.8  
 Probe Sensitivity : 1.20 1.20 1.20  $\mu\text{V}/(\text{V}/\text{m})^2$   
 Compression Point : 95.00 mV  
 Offset : 1.56 mm

1 gram SAR value : 0.354 W/kg  
 10 gram SAR value : 0.175 W/kg  
 Area Scan Peak SAR : 0.418 W/kg  
 Zoom Scan Peak SAR : 0.683 W/kg

**Plot 38#**

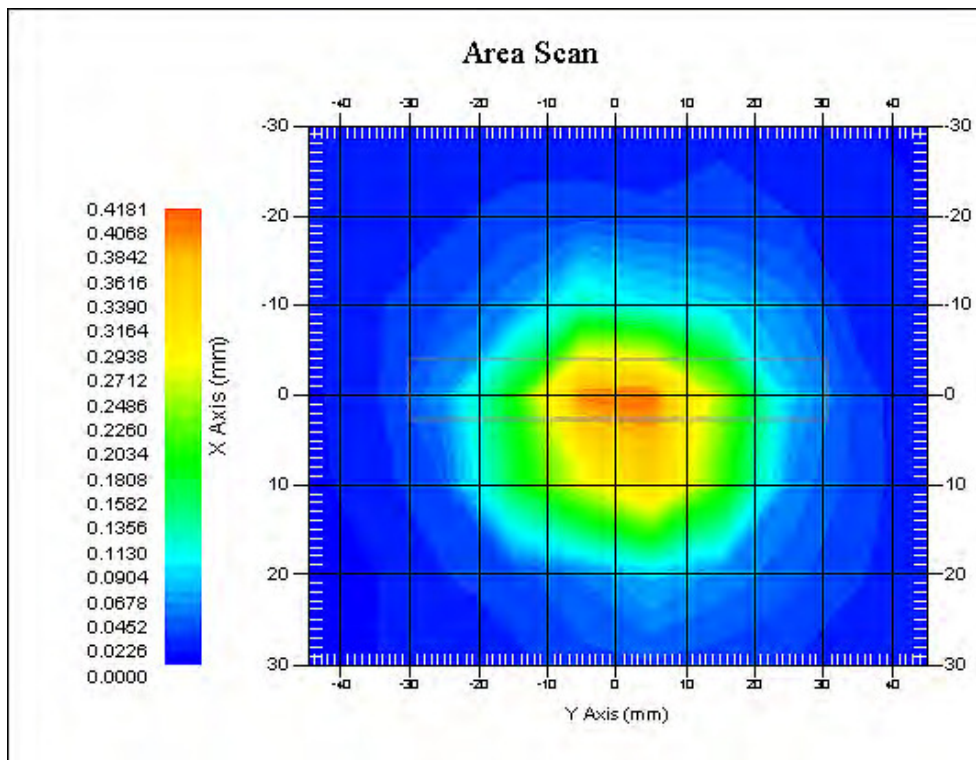

**Test Laboratory: Bay Area Compliance Lab Corp. (Shenzhen)**

**WCDMA850; Body-Worn-Back (826.4MHz Low Channel)**

Measurement Data

Test mode : WCDMA850  
 Crest Factor : 1  
 Scan Type : Complete  
 Area Scan : 8x11x1: Measurement x=10mm, y=10mm, z=4mm  
 Zoom Scan : 7x7x7: Measurement x=5mm, y=5mm, z=5mm  
 Power Drift-Start : 0.235 W/kg  
 Power Drift-Finish : 0.231 W/kg  
 Power Drift (%) : -1.702

Tissue Data

Type : Body  
 Frequency : 826.4 MHz  
 Epsilon : 54.05 F/m  
 Sigma : 0.98 S/m  
 Density : 1000.00 kg/cu. m

Probe Data

Serial No. : 500-00283  
 Frequency Band : 835  
 Duty Cycle Factor : 1  
 Conversion Factor : 5.9  
 Probe Sensitivity : 1.20 1.20 1.20  $\mu\text{V}/(\text{V}/\text{m})^2$   
 Compression Point : 95.00 mV  
 Offset : 1.56 mm

1 gram SAR value : 0.248 W/kg  
 10 gram SAR value : 0.176 W/kg  
 Area Scan Peak SAR : 0.287 W/kg  
 Zoom Scan Peak SAR : 0.478 W/kg

**Plot 39#**

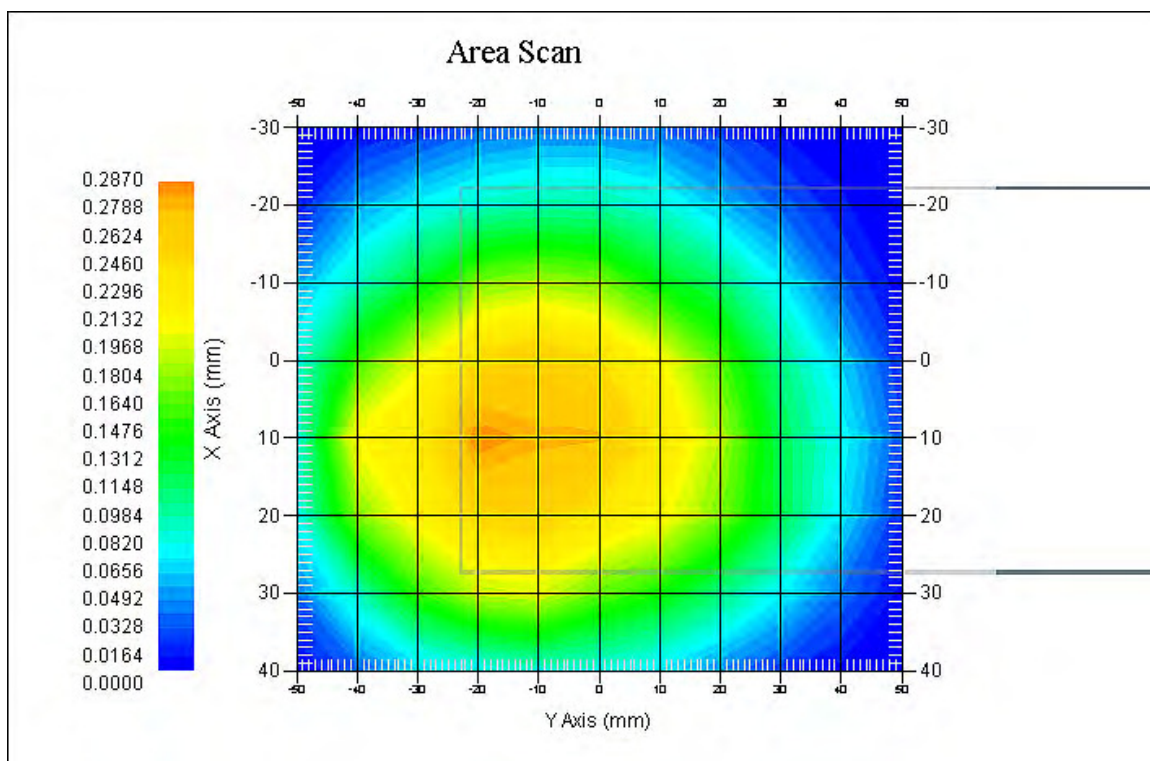

**Test Laboratory: Bay Area Compliance Lab Corp. (Shenzhen)**

**WCDMA850; Body-Worn-Back (836.6 MHz Middle Channel)**

Measurement Data

Test mode : WCDMA850  
 Crest Factor : 1  
 Scan Type : Complete  
 Area Scan : 8x11x1: Measurement x=10mm, y=10mm, z=4mm  
 Zoom Scan : 7x7x7: Measurement x=5mm, y=5mm, z=5mm  
 Power Drift-Start : 0.259 W/kg  
 Power Drift-Finish : 0.263 W/kg  
 Power Drift (%) : 1.544

Tissue Data

Type : Body  
 Frequency : 836.6 MHz  
 Epsilon : 53.88 F/m  
 Sigma : 0.98 S/m  
 Density : 1000.00 kg/cu. m

Probe Data

Serial No. : 500-00283  
 Frequency Band : 835  
 Duty Cycle Factor : 1  
 Conversion Factor : 5.9  
 Probe Sensitivity : 1.20 1.20 1.20  $\mu\text{V}/(\text{V}/\text{m})^2$   
 Compression Point : 95.00 mV  
 Offset : 1.56 mm

1 gram SAR value : 0.310 W/kg  
 10 gram SAR value : 0.198 W/kg  
 Area Scan Peak SAR : 0.342 W/kg  
 Zoom Scan Peak SAR : 0.501 W/kg

**Plot 40#**

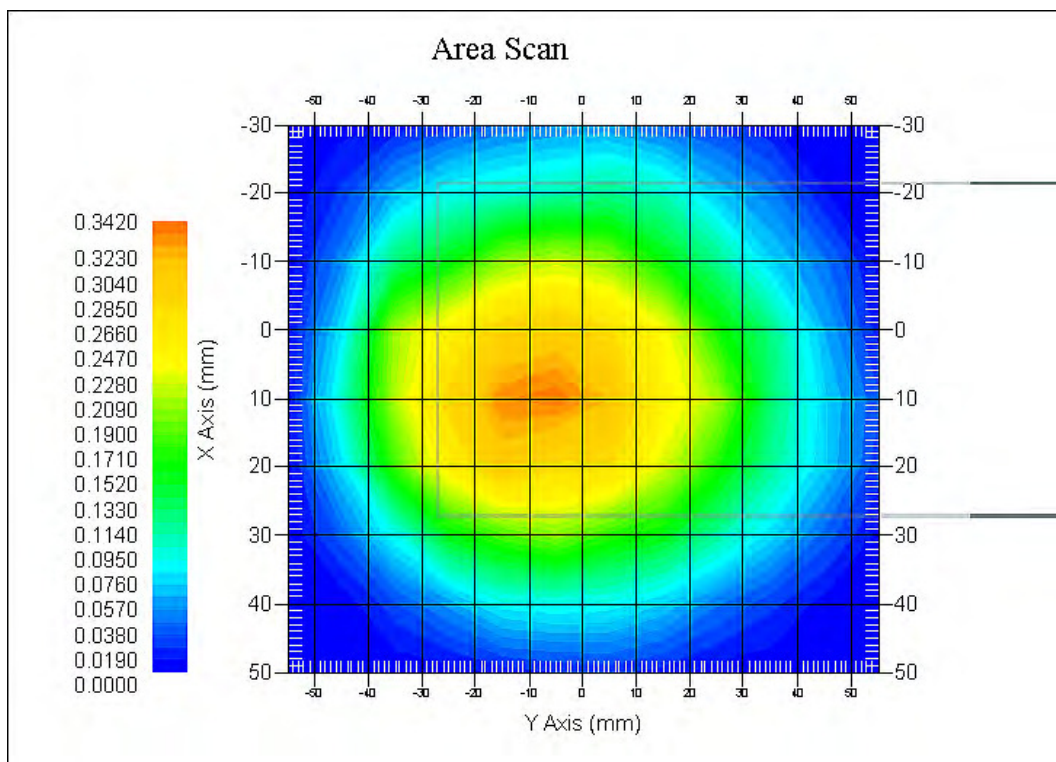

**Test Laboratory: Bay Area Compliance Lab Corp. (Shenzhen)**

**WCDMA850; Body-Worn-Back (846.6 MHz High Channel)**

Measurement Data

Test mode : WCDMA850  
 Crest Factor : 1  
 Scan Type : Complete  
 Area Scan : 8x11x1: Measurement x=10mm, y=10mm, z=4mm  
 Zoom Scan : 7x7x7: Measurement x=5mm, y=5mm, z=5mm  
 Power Drift-Start : 0.195 W/kg  
 Power Drift-Finish : 0.196 W/kg  
 Power Drift (%) : 0.512

Tissue Data

Type : Body  
 Frequency : 846.6 MHz  
 Epsilon : 54.14 F/m  
 Sigma : 0.97 S/m  
 Density : 1000.00 kg/cu. m

Probe Data

Serial No. : 500-00283  
 Frequency Band : 835  
 Duty Cycle Factor : 1  
 Conversion Factor : 5.9  
 Probe Sensitivity : 1.20 1.20 1.20  $\mu\text{V}/(\text{V}/\text{m})^2$   
 Compression Point : 95.00 mV  
 Offset : 1.56 mm

1 gram SAR value : 0.291 W/kg  
 10 gram SAR value : 0.174 W/kg  
 Area Scan Peak SAR : 0.309 W/kg  
 Zoom Scan Peak SAR : 0.458 W/kg

**Plot 41#**

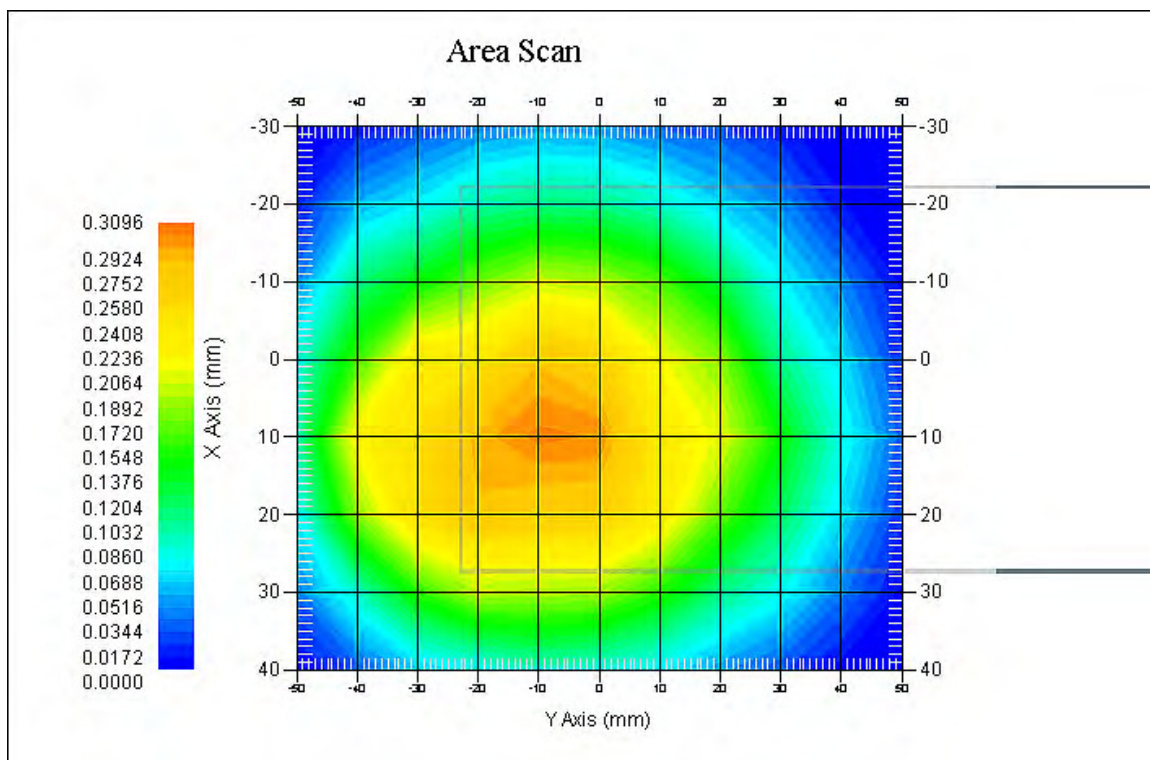

**Test Laboratory: Bay Area Compliance Lab Corp. (Shenzhen)**

**WCDMA850; Body-Worn-Left (836.6 MHz Middle Channel)**

Measurement Data

Test mode : WCDMA850  
 Crest Factor : 1  
 Scan Type : Complete  
 Area Scan : 7x12x1: Measurement x=10mm, y=10mm, z=4mm  
 Zoom Scan : 7x7x7: Measurement x=5mm, y=5mm, z=5mm  
 Power Drift-Start : 0.152 W/kg  
 Power Drift-Finish : 0.150 W/kg  
 Power Drift (%) : -1.316

Tissue Data

Type : Body  
 Frequency : 836.6 MHz  
 Epsilon : 53.88 F/m  
 Sigma : 0.98 S/m  
 Density : 1000.00 kg/cu. m

Probe Data

Serial No. : 500-00283  
 Frequency Band : 835  
 Duty Cycle Factor : 1  
 Conversion Factor : 5.9  
 Probe Sensitivity : 1.20 1.20 1.20  $\mu\text{V}/(\text{V}/\text{m})^2$   
 Compression Point : 95.00 mV  
 Offset : 1.56 mm

1 gram SAR value : 0.224 W/kg  
 10 gram SAR value : 0.159 W/kg  
 Area Scan Peak SAR : 0.255 W/kg  
 Zoom Scan Peak SAR : 0.398 W/kg

**Plot 42#**

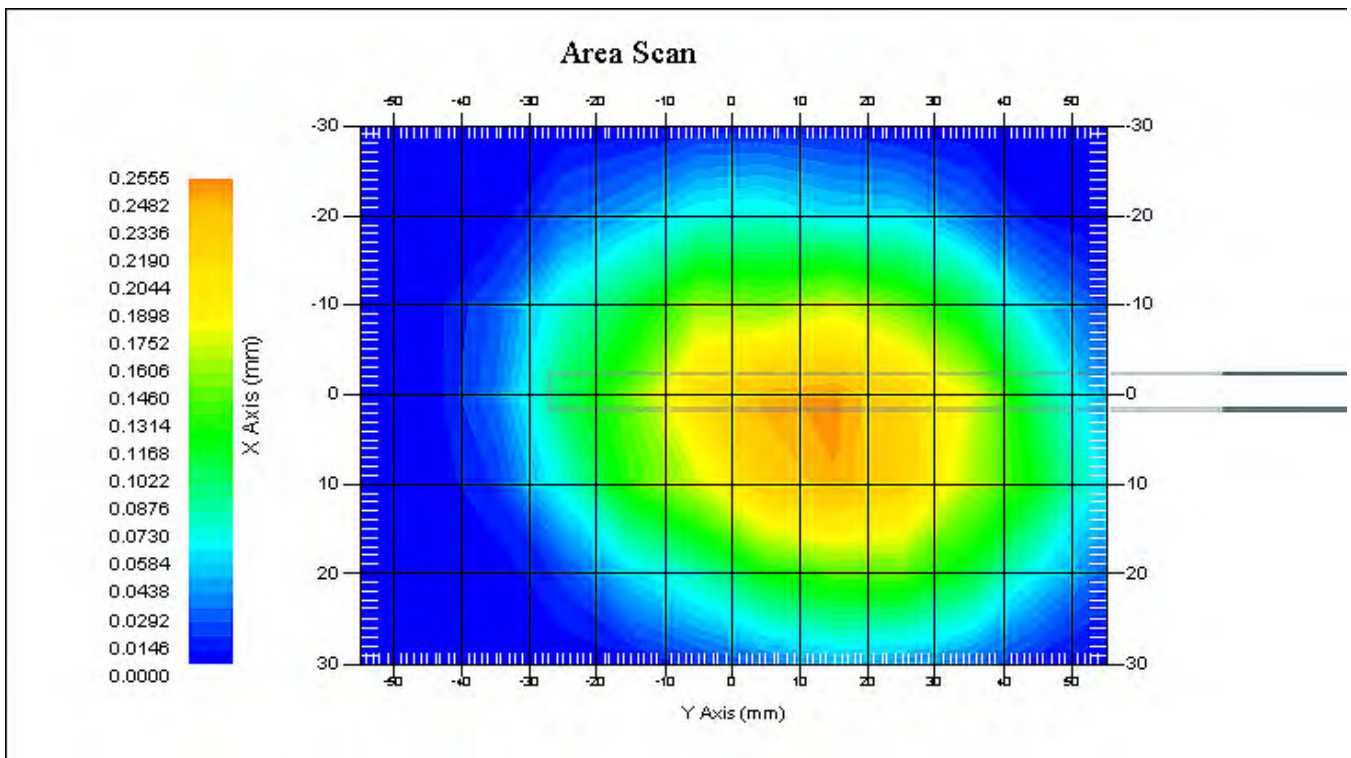

**Test Laboratory: Bay Area Compliance Lab Corp. (Shenzhen)**

**WCDMA850; Body-Worn-Right (836.6 MHz Middle Channel)**

Measurement Data

Test mode : WCDMA850  
 Crest Factor : 1  
 Scan Type : Complete  
 Area Scan : 7x11x1: Measurement x=10mm, y=10mm, z=4mm  
 Zoom Scan : 7x7x7: Measurement x=5mm, y=5mm, z=5mm  
 Power Drift-Start : 0.147 W/kg  
 Power Drift-Finish : 0.150 W/kg  
 Power Drift (%) : 2.053

Tissue Data

Type : Body  
 Frequency : 836.6 MHz  
 Epsilon : 53.88 F/m  
 Sigma : 0.98 S/m  
 Density : 1000.00 kg/cu. m

Probe Data

Serial No. : 500-00283  
 Frequency Band : 835  
 Duty Cycle Factor : 1  
 Conversion Factor : 5.9  
 Probe Sensitivity : 1.20 1.20 1.20  $\mu\text{V}/(\text{V}/\text{m})^2$   
 Compression Point : 95.00 mV  
 Offset : 1.56 mm

1 gram SAR value : 0.189 W/kg  
 10 gram SAR value : 0.114 W/kg  
 Area Scan Peak SAR : 0.210 W/kg  
 Zoom Scan Peak SAR : 0.338 W/kg

**Plot 43#**

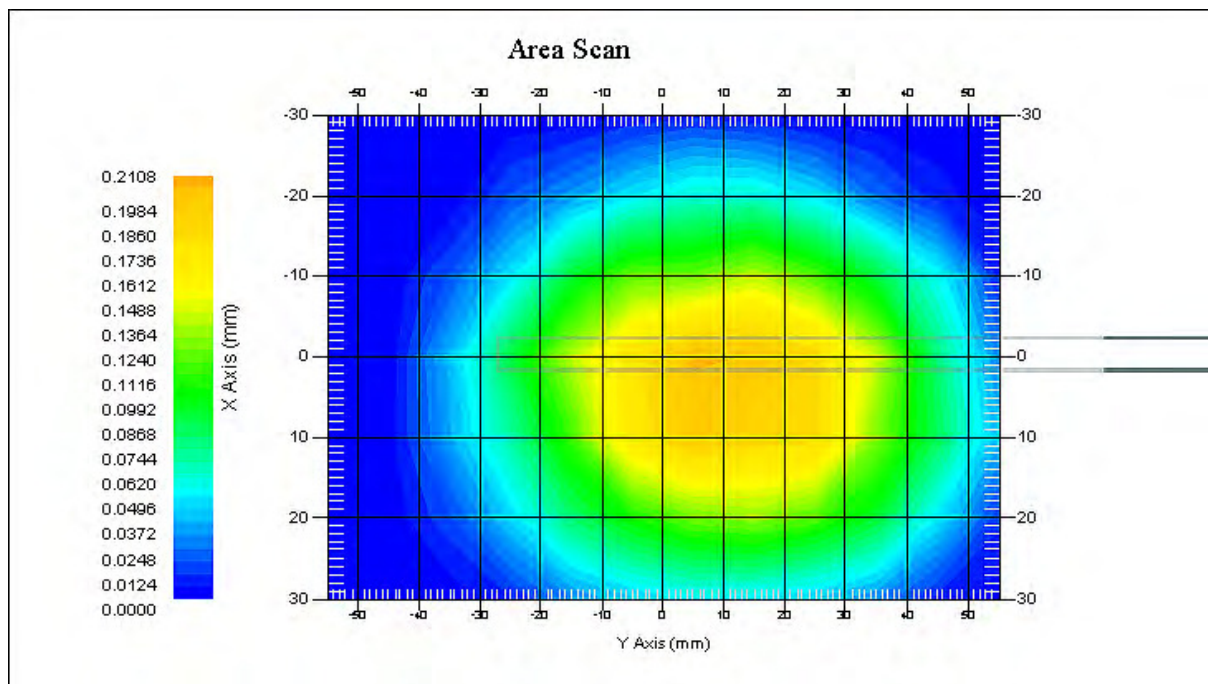

**Test Laboratory: Bay Area Compliance Lab Corp. (Shenzhen)**

**WCDMA850; Body-Worn-Bottom (836.6 MHz Middle Channel)**

Measurement Data

Test mode : WCDMA850  
 Crest Factor : 1  
 Scan Type : Complete  
 Area Scan : 7x11x1: Measurement x=10mm, y=10mm, z=4mm  
 Zoom Scan : 7x7x7: Measurement x=5mm, y=5mm, z=5mm  
 Power Drift-Start : 0.125 W/kg  
 Power Drift-Finish : 0.124 W/kg  
 Power Drift (%) : -0.798

Tissue Data

Type : Body  
 Frequency : 836.6 MHz  
 Epsilon : 53.88 F/m  
 Sigma : 0.98 S/m  
 Density : 1000.00 kg/cu. m

Probe Data

Serial No. : 500-00283  
 Frequency Band : 835  
 Duty Cycle Factor : 1  
 Conversion Factor : 5.9  
 Probe Sensitivity : 1.20 1.20 1.20  $\mu\text{V}/(\text{V/m})^2$   
 Compression Point : 95.00 mV  
 Offset : 1.56 mm

1 gram SAR value : 0.119 W/kg  
 10 gram SAR value : 0.072 W/kg  
 Area Scan Peak SAR : 0.130 W/kg  
 Zoom Scan Peak SAR : 0.203 W/kg

**Plot 44#**

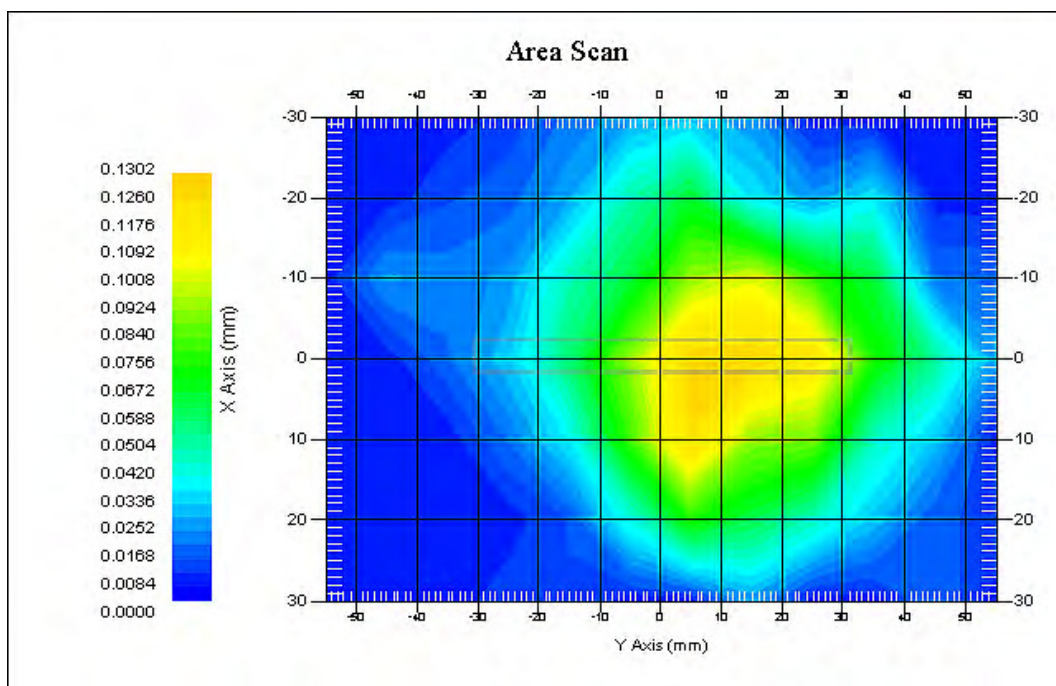

**Test Laboratory: Bay Area Compliance Lab Corp. (Shenzhen)**

**WCDMA1900; Body-Worn-Back (1852.4 MHz Low Channel)**

Measurement Data

Test mode : WCDMA1900  
 Crest Factor : 1  
 Scan Type : Complete  
 Area Scan : 9x11x1: Measurement x=10mm, y=10mm, z=4mm  
 Zoom Scan : 7x7x7: Measurement x=5mm, y=5mm, z=5mm  
 Power Drift-Start : 0.745 W/kg  
 Power Drift-Finish : 0.733 W/kg  
 Power Drift (%) : -1.611

Tissue Data

Type : Body  
 Frequency : 1852.4 MHz  
 Epsilon : 51.82 F/m  
 Sigma : 1.52 S/m  
 Density : 1000.00 kg/cu. m

Probe Data

Serial No. : 500-00283  
 Frequency Band : 1900  
 Duty Cycle Factor : 1  
 Conversion Factor : 4.8  
 Probe Sensitivity : 1.20 1.20 1.20  $\mu\text{V}/(\text{V/m})^2$   
 Compression Point : 95.00 mV  
 Offset : 1.56 mm

1 gram SAR value : 0.706 W/kg  
 10 gram SAR value : 0.341 W/kg  
 Area Scan Peak SAR : 0.829 W/kg  
 Zoom Scan Peak SAR : 1.176 W/kg

**Plot 45#**

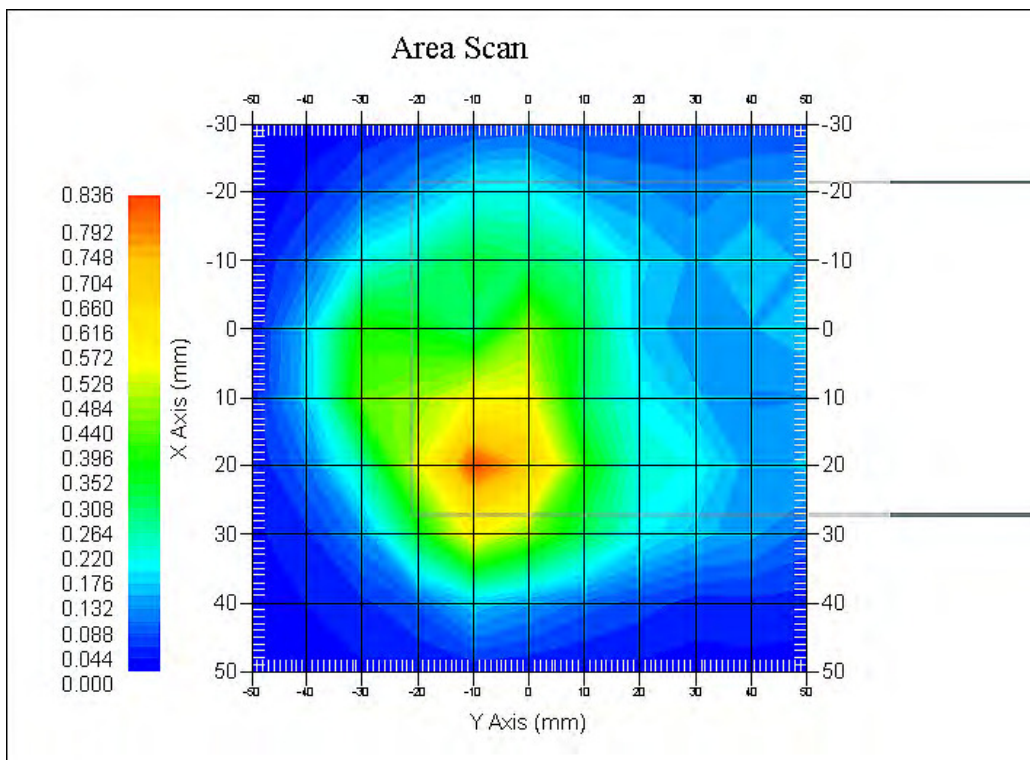



**Test Laboratory: Bay Area Compliance Lab Corp. (Shenzhen)**

**WCDMA1900; Body-Worn-Back (1880 MHz Middle Channel)**

Measurement Data

Test mode : WCDMA1900  
 Crest Factor : 1  
 Scan Type : Complete  
 Area Scan : 9x11x1: Measurement x=10mm, y=10mm, z=4mm  
 Zoom Scan : 7x7x7: Measurement x=5mm, y=5mm, z=5mm  
 Power Drift-Start : 0.693 W/kg  
 Power Drift-Finish : 0.680 W/kg  
 Power Drift (%) : -1.876

Tissue Data

Type : Body  
 Frequency : 1880 MHz  
 Epsilon : 51.65 F/m  
 Sigma : 1.53 S/m  
 Density : 1000.00 kg/cu. m

Probe Data

Serial No. : 500-00283  
 Frequency Band : 1900  
 Duty Cycle Factor : 1  
 Conversion Factor : 4.8  
 Probe Sensitivity : 1.20 1.20 1.20  $\mu\text{V}/(\text{V}/\text{m})^2$   
 Compression Point : 95.00 mV  
 Offset : 1.56 mm

1 gram SAR value : 0.725 W/kg  
 10 gram SAR value : 0.350 W/kg  
 Area Scan Peak SAR : 0.833 W/kg  
 Zoom Scan Peak SAR : 1.268 W/kg

**Plot 46#**

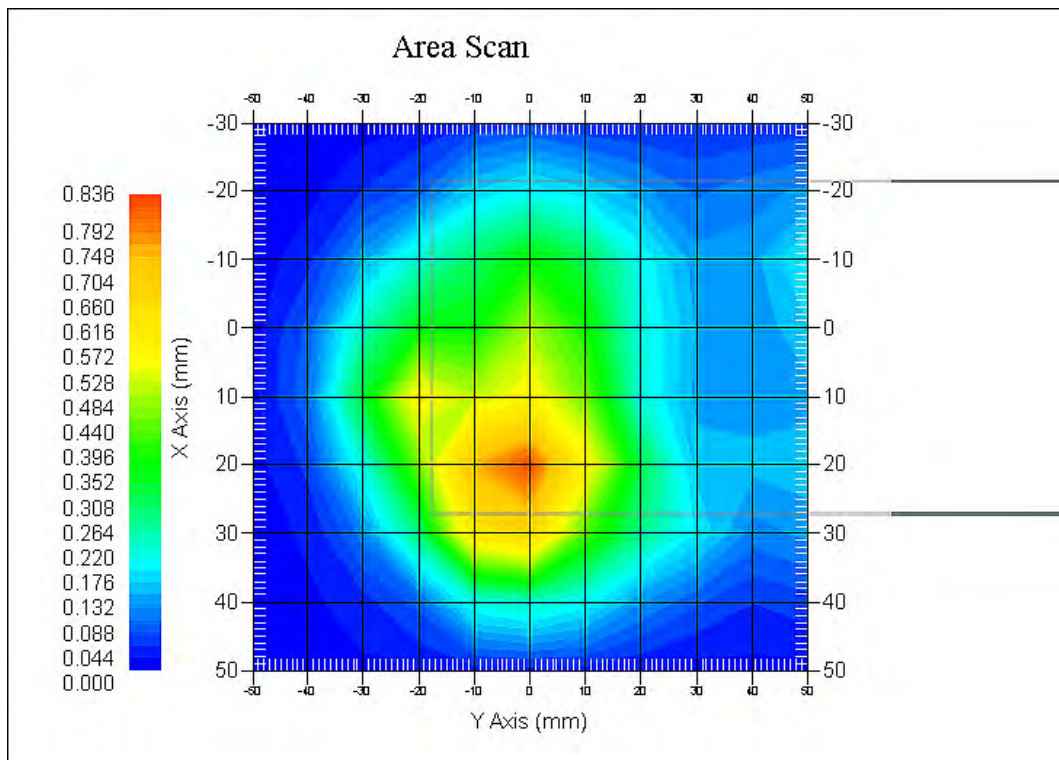

**Test Laboratory: Bay Area Compliance Lab Corp. (Shenzhen)**

**WCDMA1900; Body-Worn-Back (1907.6 MHz High Channel)**

Measurement Data

Test mode : WCDMA1900  
 Crest Factor : 1  
 Scan Type : Complete  
 Area Scan : 9x11x1: Measurement x=10mm, y=10mm, z=4mm  
 Zoom Scan : 7x7x7: Measurement x=5mm, y=5mm, z=5mm  
 Power Drift-Start : 0.803 W/kg  
 Power Drift-Finish : 0.817 W/kg  
 Power Drift (%) : 1.743

Tissue Data

Type : Body  
 Frequency : 1907.6 MHz  
 Epsilon : 52.18 F/m  
 Sigma : 1.53 S/m  
 Density : 1000.00 kg/cu. m

Probe Data

Serial No. : 500-00283  
 Frequency Band : 1900  
 Duty Cycle Factor : 1  
 Conversion Factor : 4.8  
 Probe Sensitivity : 1.20 1.20 1.20  $\mu\text{V}/(\text{V}/\text{m})^2$   
 Compression Point : 95.00 mV  
 Offset : 1.56 mm

1 gram SAR value : 0.794 W/kg  
 10 gram SAR value : 0.367 W/kg  
 Area Scan Peak SAR : 0.911 W/kg  
 Zoom Scan Peak SAR : 1.302 W/kg

**Plot 47#**

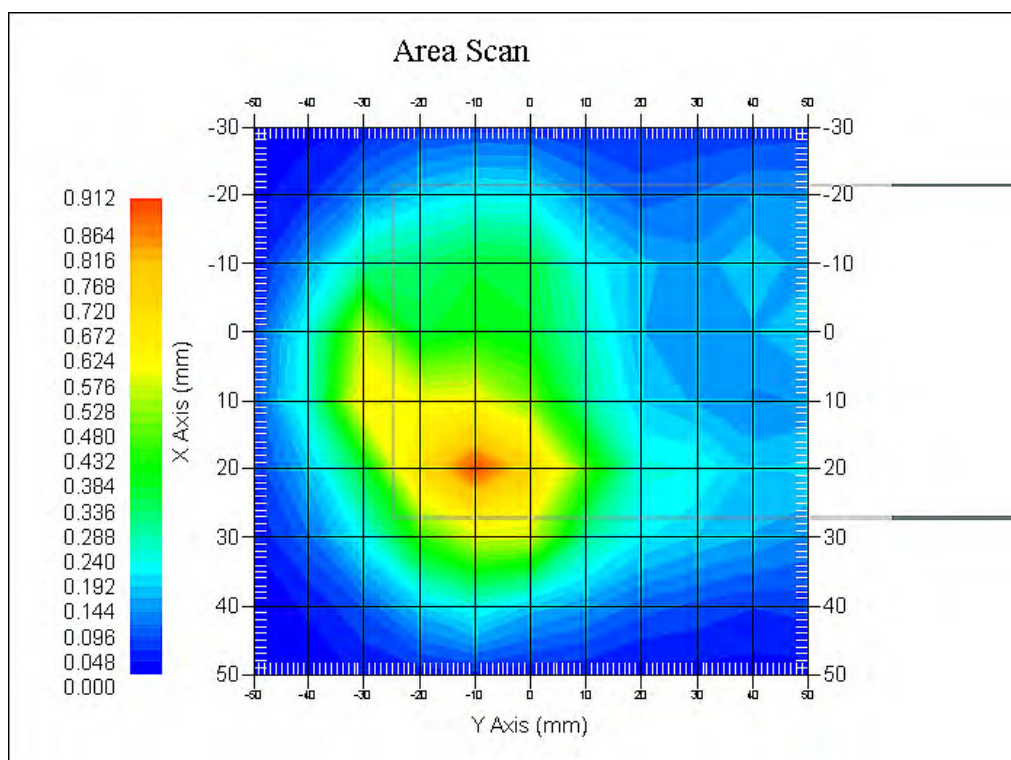

**Test Laboratory: Bay Area Compliance Lab Corp. (Shenzhen)**

**WCDMA1900; Body-Worn-Left (1880 MHz Middle Channel)**

Measurement Data

Test mode : WCDMA1900  
 Crest Factor : 1  
 Scan Type : Complete  
 Area Scan : 7x11x1: Measurement x=10mm, y=10mm, z=4mm  
 Zoom Scan : 7x7x7: Measurement x=5mm, y=5mm, z=5mm  
 Power Drift-Start : 0.263 W/kg  
 Power Drift-Finish : 0.260 W/kg  
 Power Drift (%) : -1.141

Tissue Data

Type : Body  
 Frequency : 1880 MHz  
 Epsilon : 51.65 F/m  
 Sigma : 1.53 S/m  
 Density : 1000.00 kg/cu. m

Probe Data

Serial No. : 500-00283  
 Frequency Band : 1900  
 Duty Cycle Factor : 1  
 Conversion Factor : 4.8  
 Probe Sensitivity : 1.20 1.20 1.20  $\mu\text{V}/(\text{V}/\text{m})^2$   
 Compression Point : 95.00 mV  
 Offset : 1.56 mm

1 gram SAR value : 0.413 W/kg  
 10 gram SAR value : 0.205 W/kg  
 Area Scan Peak SAR : 0.429 W/kg  
 Zoom Scan Peak SAR : 0.647 W/kg

**Plot 48#**

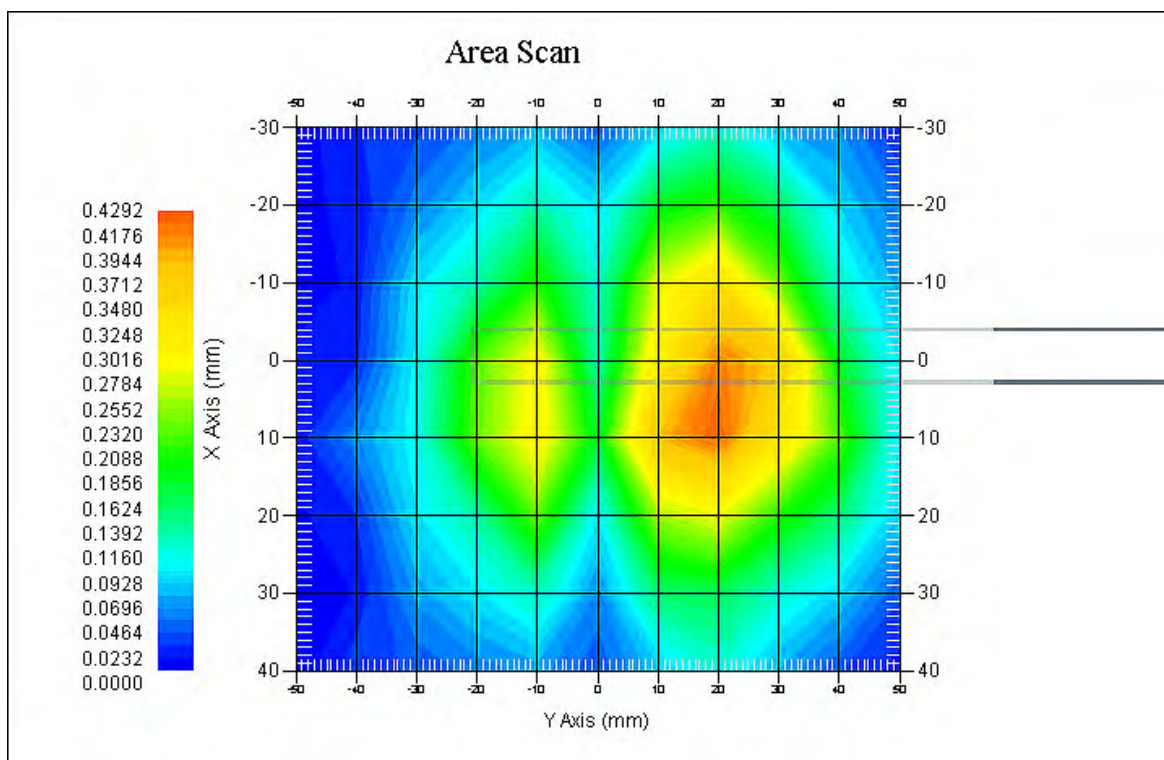

**Test Laboratory: Bay Area Compliance Lab Corp. (Shenzhen)**

**WCDMA1900; Body-Worn-Right (1852.4 MHz Low Channel)**

Measurement Data

Test mode : WCDMA1900  
 Crest Factor : 1  
 Scan Type : Complete  
 Area Scan : 7x11x1: Measurement x=10mm, y=10mm, z=4mm  
 Zoom Scan : 7x7x7: Measurement x=5mm, y=5mm, z=5mm  
 Power Drift-Start : 0.195 W/kg  
 Power Drift-Finish : 0.196 W/kg  
 Power Drift (%) : 0.506

Tissue Data

Type : Body  
 Frequency : 1880 MHz  
 Epsilon : 51.65 F/m  
 Sigma : 1.53 S/m  
 Density : 1000.00 kg/cu. m

Probe Data

Serial No. : 500-00283  
 Frequency Band : 1900  
 Duty Cycle Factor : 1  
 Conversion Factor : 4.8  
 Probe Sensitivity : 1.20 1.20 1.20  $\mu\text{V}/(\text{V}/\text{m})^2$   
 Compression Point : 95.00 mV  
 Offset : 1.56 mm

1 gram SAR value : 0.287 W/kg  
 10 gram SAR value : 0.165 W/kg  
 Area Scan Peak SAR : 0.309 W/kg  
 Zoom Scan Peak SAR : 0.466 W/kg

**Plot 49#**

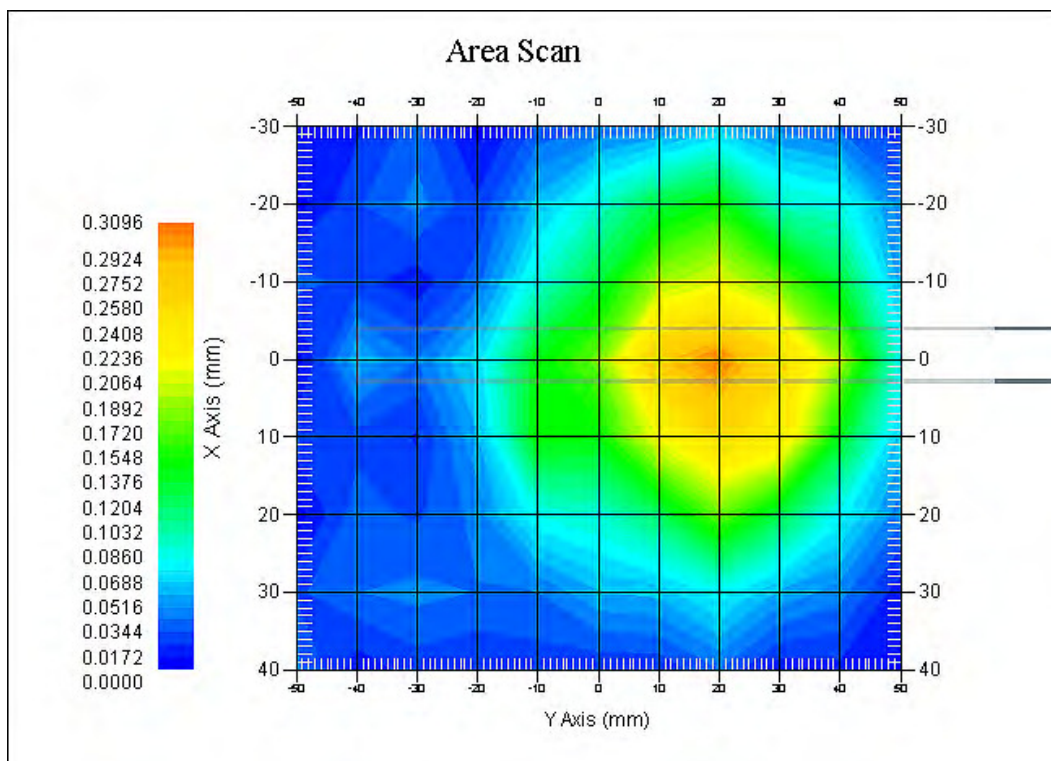

**Test Laboratory: Bay Area Compliance Lab Corp. (Shenzhen)**

**WCDMA1900; Body-Worn-Bottom (1880 MHz Middle Channel)**

Measurement Data

Test mode : WCDMA1900  
 Crest Factor : 1  
 Scan Type : Complete  
 Area Scan : 7x11x1: Measurement x=10mm, y=10mm, z=4mm  
 Zoom Scan : 7x7x7: Measurement x=5mm, y=5mm, z=5mm  
 Power Drift-Start : 0.229 W/kg  
 Power Drift-Finish : 0.234 W/kg  
 Power Drift (%) : 2.183

Tissue Data

Type : Body  
 Frequency : 1880 MHz  
 Epsilon : 51.65 F/m  
 Sigma : 1.53 S/m  
 Density : 1000.00 kg/cu. m

Probe Data

Serial No. : 500-00283  
 Frequency Band : 1900  
 Duty Cycle Factor : 1  
 Conversion Factor : 4.8  
 Probe Sensitivity : 1.20 1.20 1.20  $\mu\text{V}/(\text{V}/\text{m})^2$   
 Compression Point : 95.00 mV  
 Offset : 1.56 mm

1 gram SAR value : 0.513 W/kg  
 10 gram SAR value : 0.241 W/kg  
 Area Scan Peak SAR : 0.623 W/kg  
 Zoom Scan Peak SAR : 0.974 W/kg

**Plot 50#**

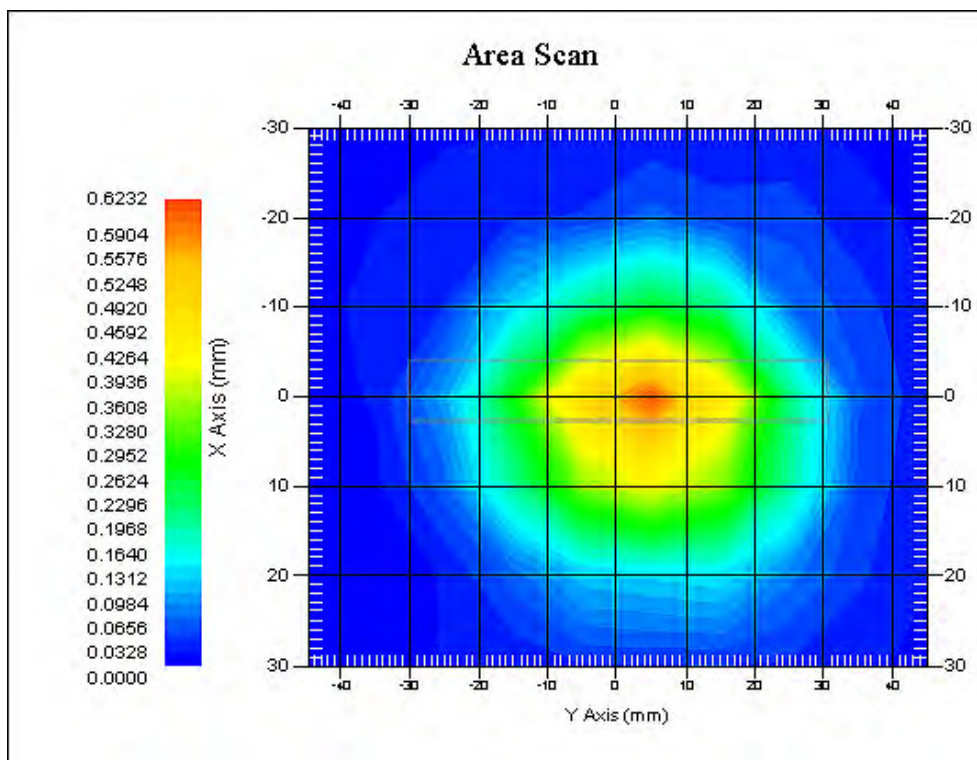

## APPENDIX A MEASUREMENT UNCERTAINTY

According to **IEEE1528:2013**, the uncertainty budget has been determined for the Head SAR measurement system and is given in the following Table.

Source of Uncertainty	Tolerance Value	Probability Distribution	Divisor	$c_i^1$ (1-g)	$c_i^1$ (10-g)	Standard Uncertainty (1-g) %	Standard Uncertainty (10-g) %
<b>Measurement System</b>							
Probe Calibration	3.5	normal	1	1	1	3.5	3.5
Axial Isotropy	3.7	rectangular	$\sqrt{3}$	$(1-cp)^{1/2}$	$(\frac{1-cp}{2})^1$	1.5	1.5
Hemispherical Isotropy	10.9	rectangular	$\sqrt{3}$	$\sqrt{cp}$	$\sqrt{cp}$	4.4	4.4
Boundary Effect	1.0	rectangular	$\sqrt{3}$	1	1	0.6	0.6
Linearity	4.7	rectangular	$\sqrt{3}$	1	1	2.7	2.7
Detection Limit	1.0	rectangular	$\sqrt{3}$	1	1	0.6	0.6
Readout Electronics	1.0	normal	1	1	1	1.0	1.0
Response Time	0.8	rectangular	$\sqrt{3}$	1	1	0.5	0.5
Integration Time	1.7	rectangular	$\sqrt{3}$	1	1	1.0	1.0
RF Ambient Condition -Noise	0.6	rectangular	$\sqrt{3}$	1	1	0.3	0.3
RF Ambient Condition - Reflections	3.0	rectangular	$\sqrt{3}$	1	1	1.7	1.7
Probe Positioner Mech. Restrictions	0.4	rectangular	$\sqrt{3}$	1	1	0.2	0.2
Probe Positioning with respect to Phantom Shell	2.9	rectangular	$\sqrt{3}$	1	1	1.7	1.7
Extrapolation and Integration	3.7	rectangular	$\sqrt{3}$	1	1	2.1	2.1
<b>Test sample related</b>							
Test sample positioning	2.0	normal	1	1	1	2.0	2.0
Device Holder Uncertainty	4.0	normal	1	1	1	6.215	6.215
Drift of Output Power	5.0	rectangular	$\sqrt{3}$	1	1	2.67	2.67
<b>Phantom and Setup</b>							
Phantom Uncertainty	3.4	rectangular	$\sqrt{3}$	1	1	2.0	2.0
SAR correction in permittivity and conductivity	1.2	normal	1	1	0.85	1.2	1.0
Liquid conductivity measurement	5.0	normal	1	0.78	0.71	3.9	3.6
Liquid permittivity measurement	5.0	normal	1	0.25	0.29	1.3	1.5
conductivity—temperature	1.1	rectangular	$\sqrt{3}$	0.78	0.71	0.5	0.5
permittivity—temperature	1.3	rectangular	$\sqrt{3}$	0.23	0.23	0.2	0.2
Combined Uncertainty		RSS				10.78	10.55
Expanded uncertainty (coverage factor=2)		Normal(k=2)				21.56	21.10

According to **IEC62209-2:2010**, the uncertainty budget has been determined for the Body SAR measurement system and is given in the following Table.

Source of Uncertainty	Tolerance Value	Probability Distribution	Divisor	$c_i^1$ (1-g)	$c_i^1$ (10-g)	Standard Uncertainty (1-g) %	Standard Uncertainty (10-g) %
<b>Measurement System</b>							
Probe Calibration	3.5	normal	1	1	1	3.5	3.5
Axial Isotropy	3.7	rectangular	$\sqrt{3}$	1	1	1.5	1.5
Boundary Effect	1.0	rectangular	$\sqrt{3}$	1	1	0.6	0.6
Linearity	4.7	rectangular	$\sqrt{3}$	1	1	2.7	2.7
Detection Limit	1.0	rectangular	$\sqrt{3}$	1	1	0.6	0.6
Readout Electronics	1.0	normal	1	1	1	1.0	1.0
Response Time	0.8	rectangular	$\sqrt{3}$	1	1	0.5	0.5
Integration Time	1.7	rectangular	$\sqrt{3}$	1	1	1.0	1.0
RF Ambient Condition -Noise	0.6	rectangular	$\sqrt{3}$	1	1	0.3	0.3
RF Ambient Condition - Reflections	3.0	rectangular	$\sqrt{3}$	1	1	1.7	1.7
Probe Positioner Mech. Restrictions	0.4	rectangular	$\sqrt{3}$	1	1	0.2	0.2
Probe Positioning with respect to Phantom Shell	2.9	rectangular	$\sqrt{3}$	1	1	1.7	1.7
Extrapolation and Integration	3.7	rectangular	$\sqrt{3}$	1	1	2.1	2.1
<b>Test sample related</b>							
Test sample positioning	2.0	normal	1	1	1	2.0	2.0
Device Holder Uncertainty	4.0	normal	1	1	1	6.215	6.215
Drift of Output Power	5.0	rectangular	$\sqrt{3}$	1	1	2.67	2.67
<b>Phantom and Setup</b>							
Phantom Uncertainty	3.4	rectangular	$\sqrt{3}$	1	1	2.0	2.0
SAR correction in permittivity and conductivity	1.2	normal	1	1	0.84	1.2	1.0
Liquid conductivity measurement	5.0	normal	1	0.78	0.71	3.9	3.6
Liquid permittivity measurement	5.0	normal	1	0.23	0.26	1.3	1.5
conductivity—temperature	1.1	rectangular	$\sqrt{3}$	0.78	0.71	0.5	0.5
permittivity—temperature	1.3	rectangular	$\sqrt{3}$	0.23	0.26	0.2	0.2
Combined Uncertainty		RSS				9.58	9.49
Expanded uncertainty (coverage factor=2)		Normal(k=2)				19.16	18.98

## APPENDIX B – PROBE CALIBRATION CERTIFICATES

### NCL CALIBRATION LABORATORIES

Calibration File No.: PC-1654

Task No: BACL-5805

## CERTIFICATE OF CALIBRATION

It is certified that the equipment identified below has been calibrated in the **NCL CALIBRATION LABORATORIES** by qualified personnel following recognized procedures and using transfer standards traceable to NRC/NIST.

Equipment: Miniature Isotropic RF Probe

Record of Calibration

Head and Body

Manufacturer: APREL Inc.

Model No.: ALS-E020

Serial No.: 500-00283

Calibration Procedure: D01-032-E020-V2, D22-012-Tissue, D28-002-Dipole  
Project No: BACL-5805

Calibrated: 12<sup>th</sup> December 2015  
Released on: 14<sup>th</sup> December 2015

This Calibration Certificate is Incomplete Unless Accompanied with the Calibration Results Summary

Released By:

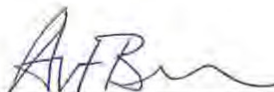

Art Brennan, Quality Manager

### **NCL** CALIBRATION LABORATORIES

Suite 102, 303 Terry Fox Dr,  
OTTAWA, ONTARIO  
CANADA K2K 3J1

Division of APREL Lab.  
TEL: (613) 435-8300  
FAX: (613) 435-8306



**NCL Calibration Laboratories**

Division of APREL, Inc.

**Introduction**

This Calibration Report reproduces the results of the calibration performed in line with the references listed below. Calibration is performed using accepted methodologies as per the references listed below. Probes are calibrated for air, and tissue and the values reported are the results from the physical quantification.

**Calibration Method**

Probes are calibrated using the following methods.

<800 MHz

TEM Cell for sensitivity in air

Standard phantom using temperature transfer method for sensitivity in tissue

>800 MHz

Waveguide\* method to determine sensitivity in air and tissue

\*Waveguide is numerically (simulation) assessed to determine the field distribution and power

The boundary effect for the probe is assessed using a standard flat phantom where the probe output is compared against a numerically simulated series of data points

**References**

- IEEE Standard 1528:2013  
IEEE Recommended Practice for Determining the Peak Spatial-Average Specific Absorption Rate (SAR) in the Human Head from Wireless Communications Devices: Measurement Techniques
- IEC 62209-1:2006  
Human Exposure to RF Fields from hand-held and body-mounted wireless communication devices - Human models, instrumentation, and procedures - Part 1: Procedure to measure the Specific Absorption Rate (SAR) for hand-held mobile wireless devices
- IEC 62209-2:2010  
Human exposure to RF fields from hand-held and body-mounted wireless devices - Human models, instrumentation, and procedures - Part 2: specific absorption rate (SAR) for wireless communication devices (30 MHz - 6 GHz)
- TP-D01-032-E020-V2 E-Field probe calibration procedure
- D22-012-Tissue dielectric tissue calibration procedure
- D28-002-Dipole procedure for validation of SAR system using a dipole
- IEEE 1309 Standard for Calibration of Electromagnetic Field Sensors and Probes, Excluding Antennas, from 9kHz to 40GHz

**NCL Calibration Laboratories**

Division of APREL Inc.

**Conditions**

Probe 500-00283 was a recalibration.

**Ambient Temperature of the Laboratory:** 20 °C +/- 1.5°C  
**Temperature of the Tissue:** 21 °C +/- 1.5°C  
**Relative Humidity:** < 60%

**Primary Measurement Standards**

Instrument	Serial Number	Cal due date
Power Meter Tektronix USB	11C940	Apr 2, 2017
Signal Generator Agilent E4438C	MY45094463	Dec 11, 2017

**Secondary Measurement Standards**

Network Analyzer Anritsu 37347C	002106	Feb. 4, 2017
---------------------------------	--------	--------------

**Attestation**

The below named signatories have conducted the calibration and review of the data which is presented in this calibration report.

**We the undersigned attest that to the best of our knowledge the calibration of this subject has been accurately conducted and that all information contained within the results pages have been reviewed for accuracy.**

  
 -----  
**Art Brennan, Quality Manager**

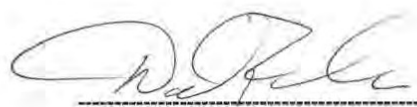
  
 -----  
**Dan Brooks, Test Engineer**

**NCL Calibration Laboratories**

Division of APREL, Inc.

**Probe Summary**

**Probe Type:** E-Field Probe E-020  
**Serial Number:** 500-00283  
**Frequency:** As presented on page 5  
**Sensor Offset:** 1.56  
**Sensor Length:** 2.5  
**Tip Enclosure:** Composite\*  
**Tip Diameter:** < 2.9 mm  
**Tip Length:** 55 mm  
**Total Length:** 289 mm  
**Diode Compression Point:** 95 mV

**Sensitivity in Air**

Frequency Range	Channel X, $\mu\text{V}/(\text{V}/\text{m})^2$	Channel Y, $\mu\text{V}/(\text{V}/\text{m})^2$	Channel Z, $\mu\text{V}/(\text{V}/\text{m})^2$	Tolerance, $\mu\text{V}/(\text{V}/\text{m})^2$
450 MHz	1.212	1.205	1.199	$\pm 0.004$
750 MHz, 835 MHz 900 MHz	1.212	1.21	1.209	$\pm 0.004$
1 GHz – 4 GHz	1.21	1.21	1.207	$\pm 0.004$
5 GHz – 6 GHz	1.2	1.192	1.19	$\pm 0.005$

\*Resistive to recommended tissue recipes per IEEE-1528

**NCL Calibration Laboratories**

Division of APREL, Inc.

Calibration for Tissue (Head H, Body B)

Frequency	Tissue Type	Measured Epsilon	Measured Sigma	Standard Uncertainty (%)	Calibration Frequency Range (MHz)	Conversion Factor
450 H	Head	43.5	0.84	3.5	±50	5.7
450 B	Body	56.77	0.93	3.5	±50	5.8
750 H	Head	42.92	0.92	3.5	±50	6.0
750 B	Body	55.57	0.93	3.5	±50	5.9
835 H	Head	43.44	0.94	3.5	±50	5.9
835 B	Body	54.91	1.00	3.5	±50	5.9
900 H	Head	41.05	1.01	3.5	±50	6.0
900 B	Body	54.86	1.04	3.5	±50	5.9
1450 H	Head	X	X	X	X	X
1450 B	Body	X	X	X	X	X
1500 H	Head	X	X	X	X	X
1500 B	Body	X	X	X	X	X
1640 H	Head	X	X	X	X	X
1640 B	Body	X	X	X	X	X
1750 H	Head	38.58	1.36	3.5	±75	5.4
1750 B	Body	51.5	1.52	3.5	±75	5.3
1800 H	Head	X	X	X	X	X
1800 B	Body	X	X	X	X	X
1900 H	Head	40.72	1.37	3.5	±75	4.8
1900 B	Body	52.29	1.58	3.5	±75	4.8
2000 H	Head	X	X	X	X	X
2000 B	Body	X	X	X	X	X
2100 H	Head	X	X	X	X	X
2100 B	Body	X	X	X	X	X
2300 H	Head	X	X	X	X	X
2300 B	Body	X	X	X	X	X
2450 H	Head	37.35	1.85	3.5	±75	4.8
2450 B	Body	53.26	1.96	3.5	±75	4.3
3000 H	Head	X	X	X	X	X
3000 B	Body	X	X	X	X	X
3600 H	Head	37.24	3.14	3.5	±100	4.4
3600 B	Body	50.23	3.81	3.5	±100	4.1
5250 H	Head	35.05	4.65	3.5	±100	3.1
5250 B	Body	46.24	5.11	3.5	±100	2.9
5600 H	Head	34.95	5.06	3.5	±100	3.0
5600 B	Body	45.95	5.73	3.5	±100	2.4
5800 H	Head	34.57	5.27	3.5	±100	3.1
5800 B	Body	46.01	6.10	3.5	±100	2.6

**NCL Calibration Laboratories**

Division of APREL, Inc.

**Boundary Effect:**

Uncertainty resulting from the boundary effect is less than 2.1% for the distance between the tip of the probe and the tissue boundary, when less than 0.58mm.

**Spatial Resolution:**

The spatial resolution uncertainty is less than 1.5% for 4.9mm diameter probe.  
 The spatial resolution uncertainty is less than 1.0% for 2.5mm diameter probe.

**DAQ-PAQ Contribution**

To minimize the uncertainty calculation all tissue sensitivity values were calculated using a load impedance of 5 MΩ.

**Probe Calibration Uncertainty**

Uncertainty component	Tolerance (± %)	Probability distribution	Divisor	Standard uncertainty (± %)
Incident or forward power	2.5	R	√3	1.44
Reflected power	2	R	√3	1.15
Liquid conductivity measurement	1	R	√3	0.58
Liquid permittivity measurement	1	R	√3	0.58
Liquid conductivity deviation	1.5	R	√3	0.87
Liquid permittivity deviation	1.5	R	√3	0.87
Frequency deviation	2.25	R	√3	1.30
Field homogeneity	2.5	R	√3	1.44
Field-probe positioning	2.5	R	√3	1.44
Field-probe linearity	1.55	R	√3	0.89
<b>Combined standard uncertainty</b>		RSS		<b>3.50</b>

**NCL Calibration Laboratories**

Division of APREL, Inc.

**Receiving Pattern Air**

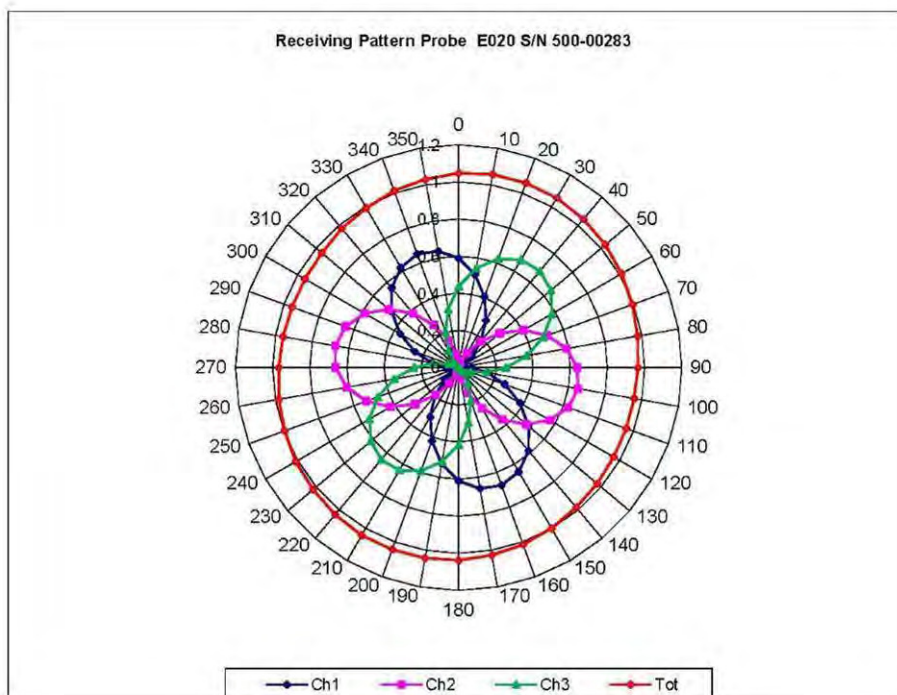

**NCL Calibration Laboratories**

Division of APREL, Inc.

**Isotropy Error Air**

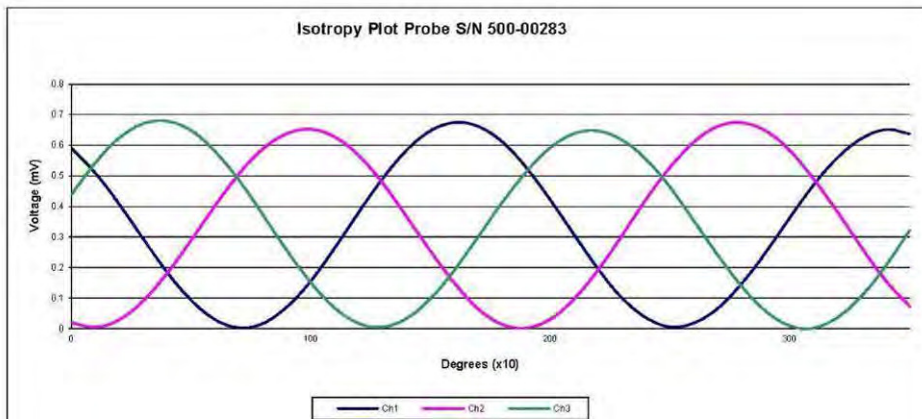
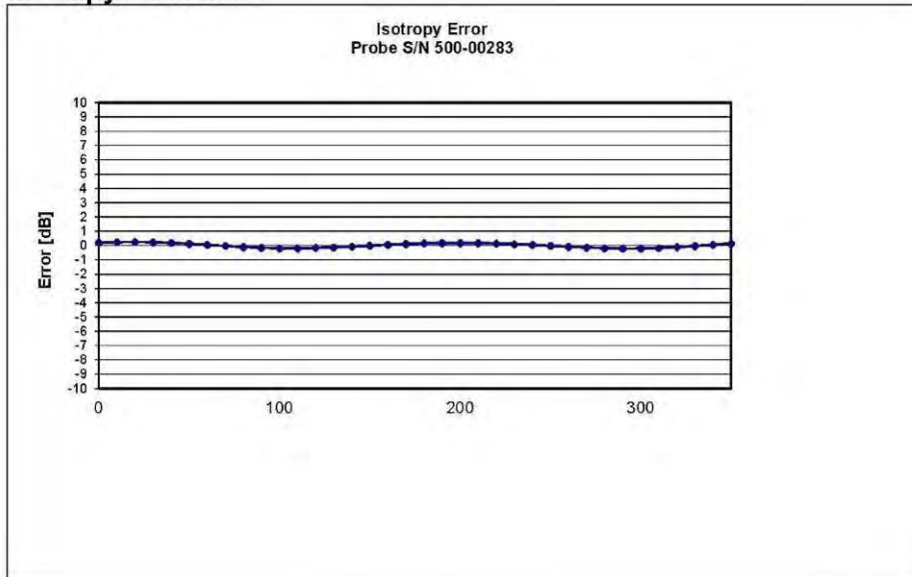

**NCL Calibration Laboratories**

Division of APREL, Inc.

**Dynamic Range**

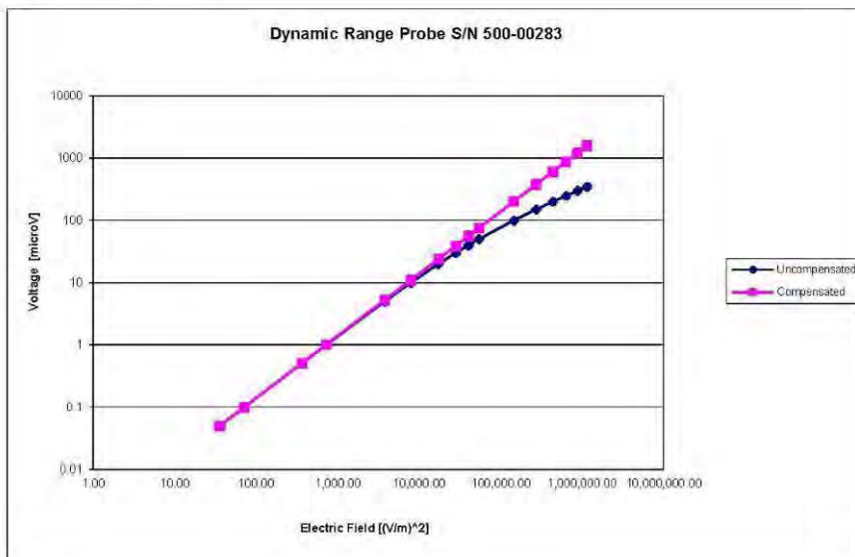

**Video Bandwidth**

**Probe Frequency Characteristics**

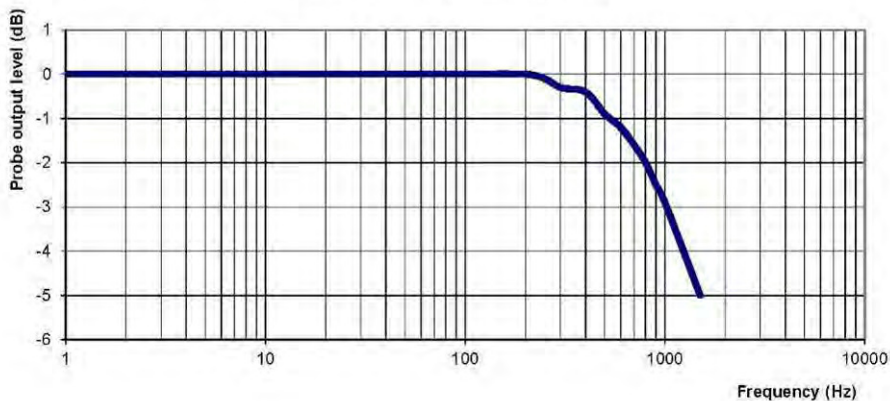

Video Bandwidth at 500 Hz                      1 dB  
 Video Bandwidth at 1.02 KHz:                3 dB

Page 9 of 10  
 This page has been reviewed for content and attested to on Page 2 of this document.

Probe S/N 500-00283



## APPENDIX C DIPOLE CALIBRATION CERTIFICATES

### NCL CALIBRATION LABORATORIES

Calibration File No: DC-1599  
Project Number: BAC-dipole-cal-5779

## CERTIFICATE OF CALIBRATION

It is certified that the equipment identified below has been calibrated in the  
**NCL CALIBRATION LABORATORIES** by qualified personnel following recognized  
procedures and using transfer standards traceable to NRC/NIST.

Validation Dipole(Head and Body)

Manufacturer: APREL Laboratories  
Part number: ALS-D-835-S-2  
Frequency: 835 MHz  
Serial No: 180-00558

Customer: Bay Area Compliance Laboratory (China)

Calibrated: 8<sup>th</sup> October 2014  
Released on: 8<sup>th</sup> October 2014

This Calibration Certificate is Incomplete Unless Accompanied with the Calibration Results Summary

Released By: \_\_\_\_\_



Art Brennan, Quality Manager

### **NCL CALIBRATION LABORATORIES**

Suite 102, 303 Terry Fox Dr.  
Kanata, ONTARIO  
CANADA K2K 3J1

Division of APREL Lab.  
TEL: (613) 435-8300  
FAX: (613)435-8306

**NCL Calibration Laboratories**

Division of APREL Laboratories.

**Conditions**

Dipole 180-00558 was received with a damaged connection for a re-calibration.

**Ambient Temperature of the Laboratory:** 22 °C +/- 0.5°C  
**Temperature of the Tissue:** 21 °C +/- 0.5°C

**Attestation**

The below named signatories have conducted the calibration and review of the data which is presented in this calibration report.

We the undersigned attest that to the best of our knowledge the calibration of this subject has been accurately conducted and that all information contained within the results pages have been reviewed for accuracy.

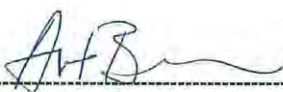
  
-----  
Art Brennan, Quality Manager

  
-----  
Maryna Nesterova Calibration Engineer

**Primary Measurement Standards**

<b>Instrument</b>	<b>Serial Number</b>	<b>Cal due date</b>
Tektronix USB Power Meter	11C940	May 14, 2015
Network Analyzer Anritsu 37347C	002106	Feb. 20, 2015

This page has been reviewed for content and attested to by signature within this document.

**NCL Calibration Laboratories**

Division of APREL Laboratories.

**Calibration Results Summary**

The following results relate the Calibrated Dipole and should be used as a quick reference for the user.

**Mechanical Dimensions**

Length: 162.2 mm  
 Height: 89.4 mm

**Electrical Specification**

Tissue	Frequency	SWR:	Return Loss	Impedance
Head	835 MHz	1.066 U	-30.344 dB	49.001 Ω
Body	835 MHz	1.089 U	-28.118 dB	53.117 Ω

**System Validation Results**

Tissue	Frequency	1 Gram	10 Gram	Peak
Head	835 MHz	9.773	6.174	14.713
Body	835 MHz	9.736	6.297	14.513

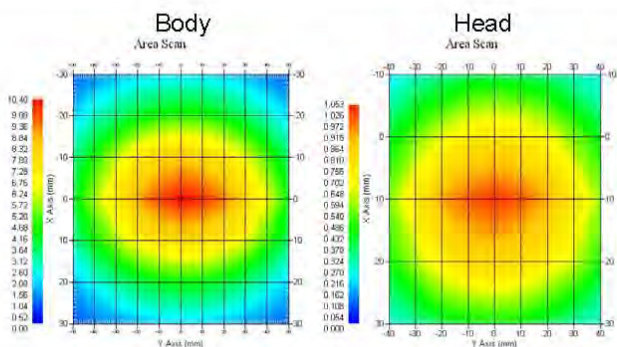

This page has been reviewed for content and attested to by signature within this document.

**NCL Calibration Laboratories**

Division of APREL Laboratories.

**Introduction**

This Calibration Report has been produced in line with the SSI Dipole Calibration Procedure SSI-TP-018-ALSAS. The results contained within this report are for Validation Dipole 180-00558. The calibration routine consisted of a three-step process. Step 1 was a mechanical verification of the dipole to ensure that it meets the mechanical specifications. Step 2 was an Electrical Calibration for the Validation Dipole, where the SWR, Impedance, and the Return loss were assessed. Step 3 involved a System Validation using the ALSAS-10U, along with APREL E-020 30 MHz to 6 GHz E-Field Probe Serial Number 225.

**References**

- SSI-TP-018-ALSAS Dipole Calibration Procedure
- SSI-TP-016 Tissue Calibration Procedure
- IEEE 1528:2013 "Recommended Practice for Determining the Peak Spatial-Average Specific Absorption Rate (SAR) in the Human Head from Wireless Communications Devices: Measurement Techniques"
- IEC-62209-1:2006 "Human exposure to radio frequency fields from hand-held and body-mounted wireless communication devices – Human models, instrumentation, and procedures" Part 1: "Procedure to determine the Specific Absorption Rate (SAR) for hand-held devices used in close proximity of the ear (frequency range of 300 MHz to 3 GHz)"
- IEC-62209-2:2010 "Human exposure to radio frequency fields from hand-held and body-mounted wireless communication devices – Human models, instrumentation, and procedures" Part 2: "Procedure to determine the Specific Absorption Rate (SAR) for hand-held devices used in close proximity of the ear (frequency range of 30 MHz to 6 GHz)"
- D28-002 Procedure for validation of SAR system using a dipole

**Conditions**

Dipole 180-00558 was repaired prior to this calibration. The repair reliability depends upon correct usage of the dipole.

**Ambient Temperature of the Laboratory:** 22 °C +/- 0.5°C  
**Temperature of the Tissue:** 20 °C +/- 0.5°C

**Dipole Calibration uncertainty**

The calibration uncertainty for the dipole is made up of various parameters presented below.

<b>Mechanical</b>	1%
<b>Positioning Error</b>	1.22%
<b>Electrical</b>	1.7%
<b>Tissue</b>	2.2%
<b>Dipole Validation</b>	2.2%
<b>TOTAL</b>	<b>8.32% (16.64% K=2)</b>

This page has been reviewed for content and attested to by signature within this document.

**NCL Calibration Laboratories**

Division of APREL Laboratories.

**Dipole Calibration Results**

**Mechanical Verification**

APREL Length	APREL Height	Measured Length	Measured Height
161.0 mm	89.8 mm	162.2 mm	89.4 mm

**Electrical Verification**

Tissue Type	Return Loss:	SWR:	Impedance:
Head	-30.344 dB	1.066 U	49.001 Ω
Body	-28.118 dB	1.089 U	53.117 Ω □

**Tissue Validation**

	Dielectric constant, $\epsilon_r$	Conductivity, $\sigma$ [S/m]
Head Tissue 835MHz	43.42	0.94
Body Tissue 835MHz	55.77	1.01

This page has been reviewed for content and attested to by signature within this document.

**NCL Calibration Laboratories**

Division of APREL Laboratories.

The Following Graphs are the results as displayed on the Vector Network Analyzer.

**S11 Parameter Return Loss**

Head Tissue: Frequency Range 0.817 to 0.848 GHz

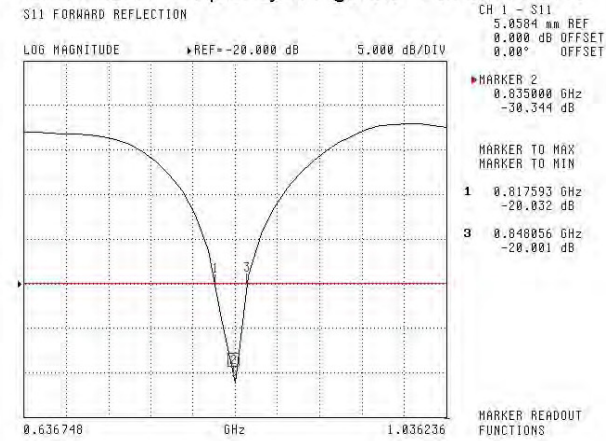

Body Tissue: Frequency Range 0.823 to 0.851 GHz

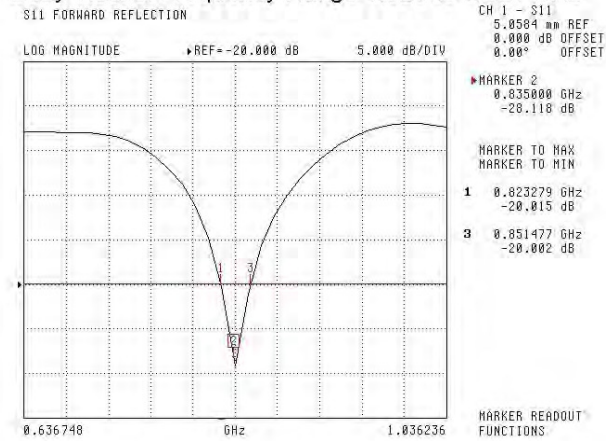

This page has been reviewed for content and attested to by signature within this document.

**NCL Calibration Laboratories**

Division of APREL Laboratories.

**SWR**  
**Head**

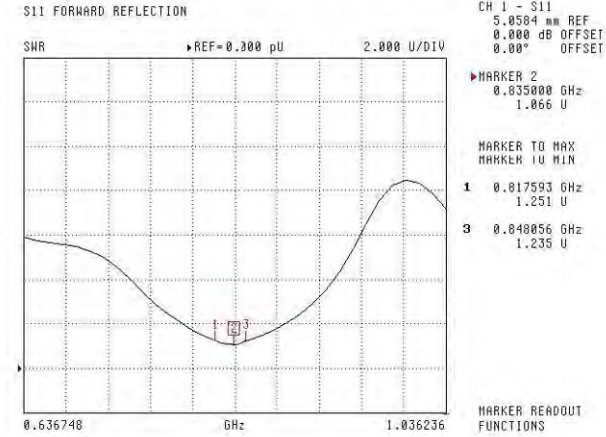

**Body**

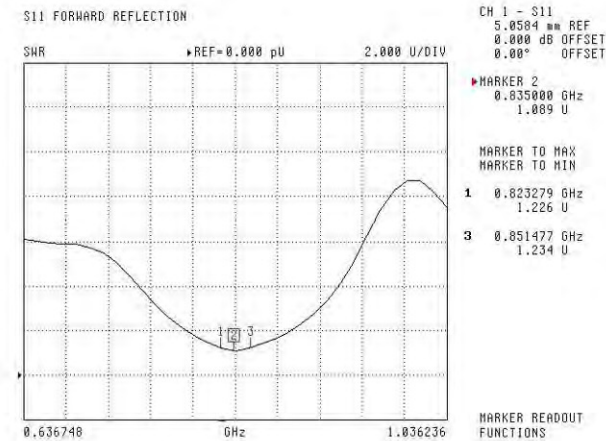

This page has been reviewed for content and attested to by signature within this document.

**NCL Calibration Laboratories**

Division of APREL Laboratories.

**Smith Chart Dipole Impedance**

**Head**

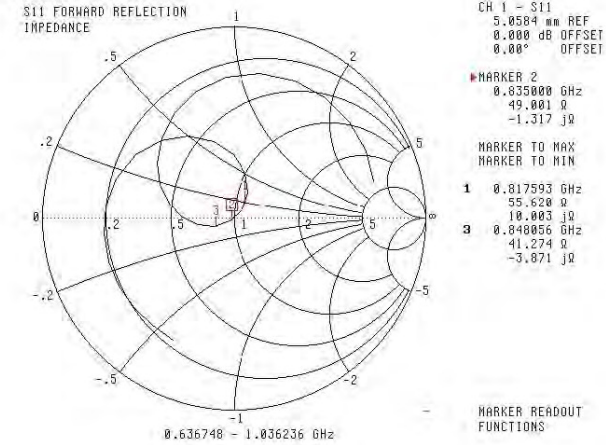

**Body**

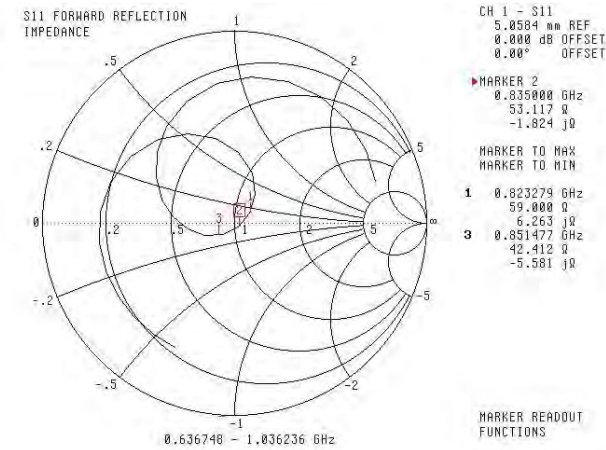

This page has been reviewed for content and attested to by signature within this document.



**NCL Calibration Laboratories**

Division of APREL Laboratories.

**Test Equipment**

The test equipment used during Probe Calibration, manufacturer, model number and, current calibration status are listed and located on the main APREL server R:\NCL\Calibration Equipment\Instrument List 2014.

This page has been reviewed for content and attested to by signature within this document.

9

**NCL CALIBRATION LABORATORIES**

Calibration File No: DC-1601  
Project Number: BAC-dipole -cal-5779

**CERTIFICATE OF CALIBRATION**

It is certified that the equipment identified below has been calibrated in the  
**NCL CALIBRATION LABORATORIES** by qualified personnel following recognized  
procedures and using transfer standards traceable to NRC/NIST.

Validation Dipole (Head & Body)

Manufacturer: APREL Laboratories  
Part number: ALS-D-1900-S-2  
Frequency: 1900 MHz  
Serial No: 210-00710

Customer: Bay Area Compliance Laboratory (China)

Calibrated: 9<sup>th</sup> October, 2014  
Released on: 9<sup>th</sup> October, 2014

This Calibration Certificate is Incomplete Unless Accompanied with the Calibration Results Summary

Released By:   
Art Brennan, Quality Manager

**NCL CALIBRATION LABORATORIES**

Suite 102, 303 Terry Fox Dr.  
Kanata, ONTARIO  
CANADA K2K 3J1

Division of APREL Lab.  
TEL: (613) 435-8300  
FAX: (613)435-8306

**NCL Calibration Laboratories**

Division of APREL Laboratories.

**Conditions**

Dipole 210-00710 was received in good condition and was a re-calibration.

**Ambient Temperature of the Laboratory:** 22 °C +/- 0.5°C  
**Temperature of the Tissue:** 21 °C +/- 0.5°C

**Attestation**

The below named signatories have conducted the calibration and review of the data which is presented in this calibration report.

We the undersigned attest that to the best of our knowledge the calibration of this subject has been accurately conducted and that all information contained within the results pages have been reviewed for accuracy.

  
 -----  
 Art Brennan, Quality Manager

  
 -----  
 Maryna Nesterova Calibration Engineer

**Primary Measurement Standards**

Instrument	Serial Number	Cal due date
Tektronix USB Power Meter	11C940	May 14, 2015
Network Analyzer Anritsu 37347C	002106	Feb. 20, 2015

This page has been reviewed for content and attested to by signature within this document.

**NCL Calibration Laboratories**

Division of APREL Laboratories.

**Calibration Results Summary**

The following results relate the Calibrated Dipole and should be used as a quick reference for the user.

**Mechanical Dimensions**

**Length:** 67.1 mm  
**Height:** 38.9 mm

**Electrical Specification**

Tissue	Frequency	SWR:	Return Loss	Impedance
Head	1900MHz	1.084 U	-27.92 dB	52.247 Ω
Body	1900MHz	1.128 U	-24.40 dB	52.618 Ω

**System Validation Results**

Tissue	Frequency	1 Gram	10 Gram	Peak
Head	1900 MHz	39.481	20.44	73.364
Body	1900 MHz	39.715	20.552	73.565

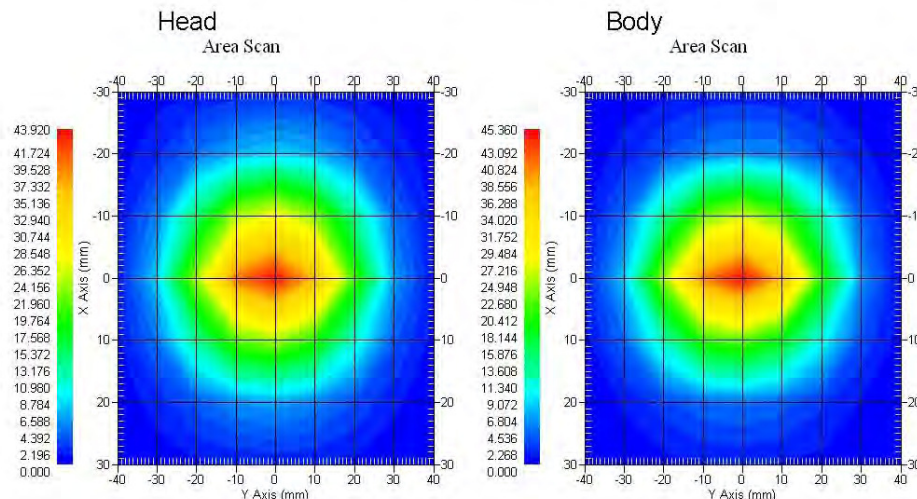

This page has been reviewed for content and attested to by signature within this document.

**NCL Calibration Laboratories**

Division of APREL Laboratories.

**Introduction**

This Calibration Report has been produced in line with the SSI Dipole Calibration Procedure SSI-TP-018-ALSAS. The results contained within this report are for Validation Dipole 210-00710. The calibration routine consisted of a three-step process. Step 1 was a mechanical verification of the dipole to ensure that it meets the mechanical specifications. Step 2 was an Electrical Calibration for the Validation Dipole, where the SWR, Impedance, and the Return loss were assessed. Step 3 involved a System Validation using the ALSAS-10U, along with APREL E-020 30 MHz to 6 GHz E-Field Probe Serial Number 225.

**References**

- SSI-TP-018-ALSAS Dipole Calibration Procedure
- SSI-TP-016 Tissue Calibration Procedure
- IEEE 1528:2013 "Recommended Practice for Determining the Peak Spatial-Average Specific Absorption Rate (SAR) in the Human Head from Wireless Communications Devices: Measurement Techniques"
- IEC-62209-1:2006 "Human exposure to radio frequency fields from hand-held and body-mounted wireless communication devices – Human models, instrumentation, and procedures"  
Part 1: "Procedure to determine the Specific Absorption Rate (SAR) for hand-held devices used in close proximity of the ear (frequency range of 300 MHz to 3 GHz)"
- IEC-62209-2:2010 "Human exposure to radio frequency fields from hand-held and body-mounted wireless communication devices – Human models, instrumentation, and procedures"  
Part 2: "Procedure to determine the Specific Absorption Rate (SAR) for hand-held devices used in close proximity of the ear (frequency range of 30 MHz to 6 GHz)"
- D28-002 Procedure for validation of SAR system using a dipole

**Conditions**

Dipole 210-00710 was a recalibration.

**Ambient Temperature of the Laboratory:** 22 °C +/- 0.5°C

**Temperature of the Tissue:** 20 °C +/- 0.5°C

**Dipole Calibration uncertainty**

The calibration uncertainty for the dipole is made up of various parameters presented below.

<b>Mechanical</b>	1%
<b>Positioning Error</b>	1.22%
<b>Electrical</b>	1.7%
<b>Tissue</b>	2.2%
<b>Dipole Validation</b>	2.2%
<b>TOTAL</b>	<b>8.32% (16.64% K=2)</b>

This page has been reviewed for content and attested to by signature within this document.

4

**NCL Calibration Laboratories**

Division of APREL Laboratories.

**Dipole Calibration Results**

**Mechanical Verification**

APREL Length	APREL Height	Measured Length	Measured Height
68.0 mm	39.5 mm	67.1mm	38.9 mm

**Electrical Validation**

Tissue	Frequency	SWR:	Return Loss	Impedance
Head	1900MHz	1.084 U	-27.92 dB	52.247 Ω
Body	1900MHz	1.128 U	-24.40 dB	52.618 Ω

**Tissue Validation**

	Dielectric constant, $\epsilon_r$	Conductivity, $\sigma$ [S/m]
Head Tissue 1900MHz	40.20	1.38
Body Tissue 1900MHz	52.63	1.46

This page has been reviewed for content and attested to by signature within this document.

**NCL Calibration Laboratories**  
 Division of APREL Laboratories.

The Following Graphs are the results as displayed on the Vector Network Analyzer.

**S11 Parameter Return Loss**

Head: Frequency Range 1.865 to 1.937 GHz

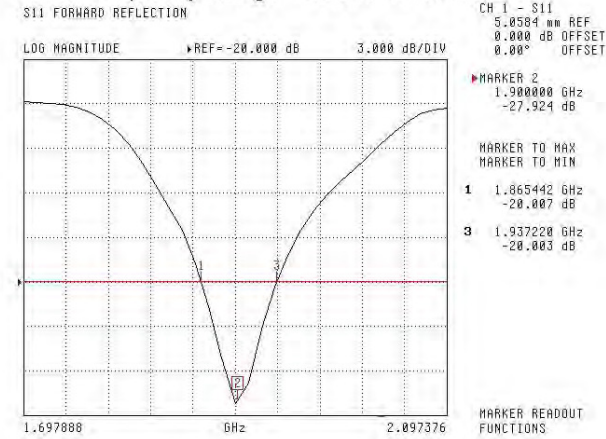

Body: Frequency Range 1.869 to 1.931 MHz

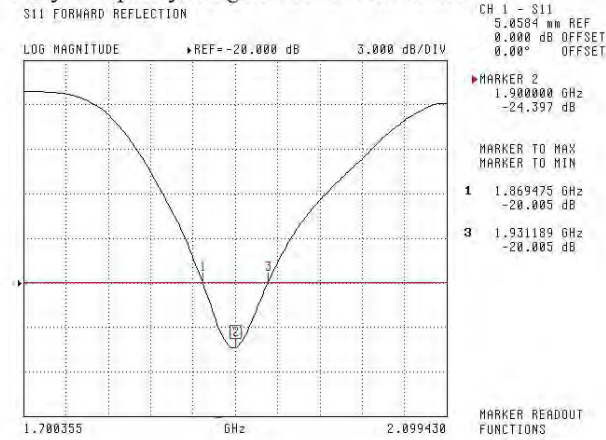

This page has been reviewed for content and attested to by signature within this document.

**NCL Calibration Laboratories**  
 Division of APREL Laboratories.

**SWR**

**Head**

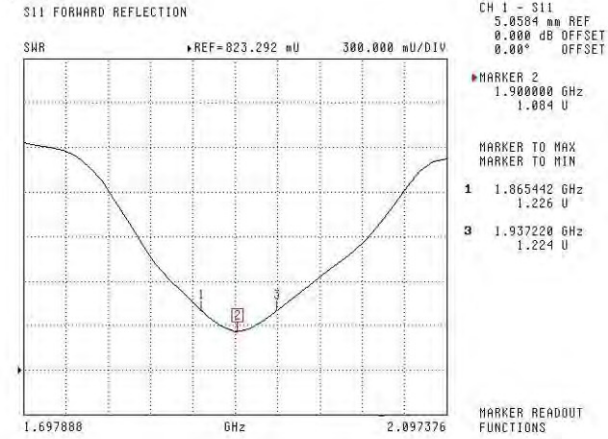

**Body**

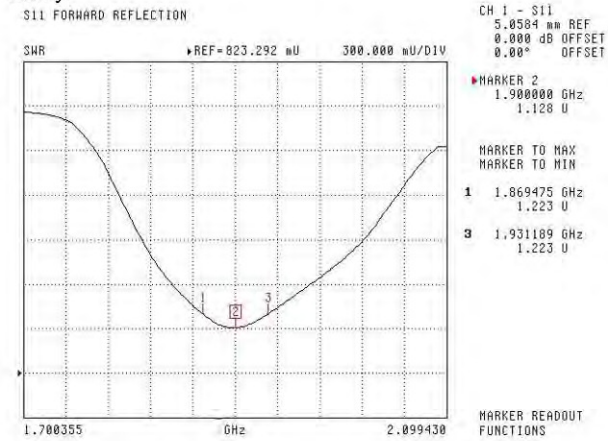

This page has been reviewed for content and attested to by signature within this document.



**NCL Calibration Laboratories**  
 Division of APREL Laboratories.

**Smith Chart Dipole Impedance**

**Head**

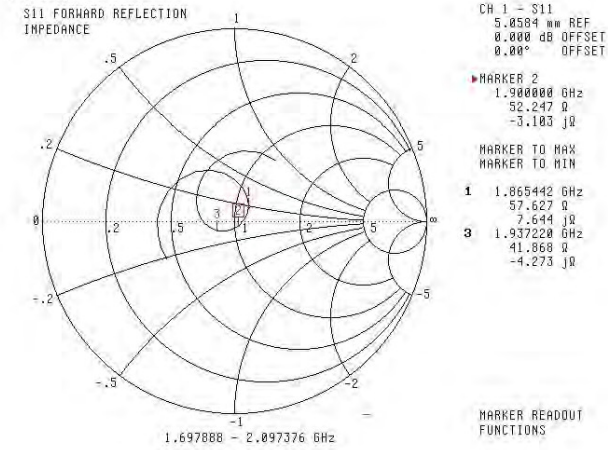

**Body**

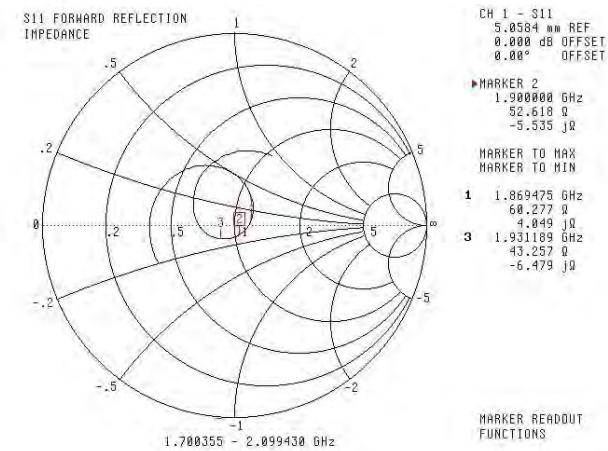

This page has been reviewed for content and attested to by signature within this document.

**NCL Calibration Laboratories**

Division of APREL Laboratories.

**Test Equipment**

The test equipment used during Probe Calibration, manufacturer, model number and, current calibration status are listed and located on the main APREL server R:\NCL\Calibration Equipment\Instrument List 2014

This page has been reviewed for content and attested to by signature within this document.

## APPENDIX D EUT TEST POSITION PHOTOS

Liquid depth  $\geq 15\text{cm}$

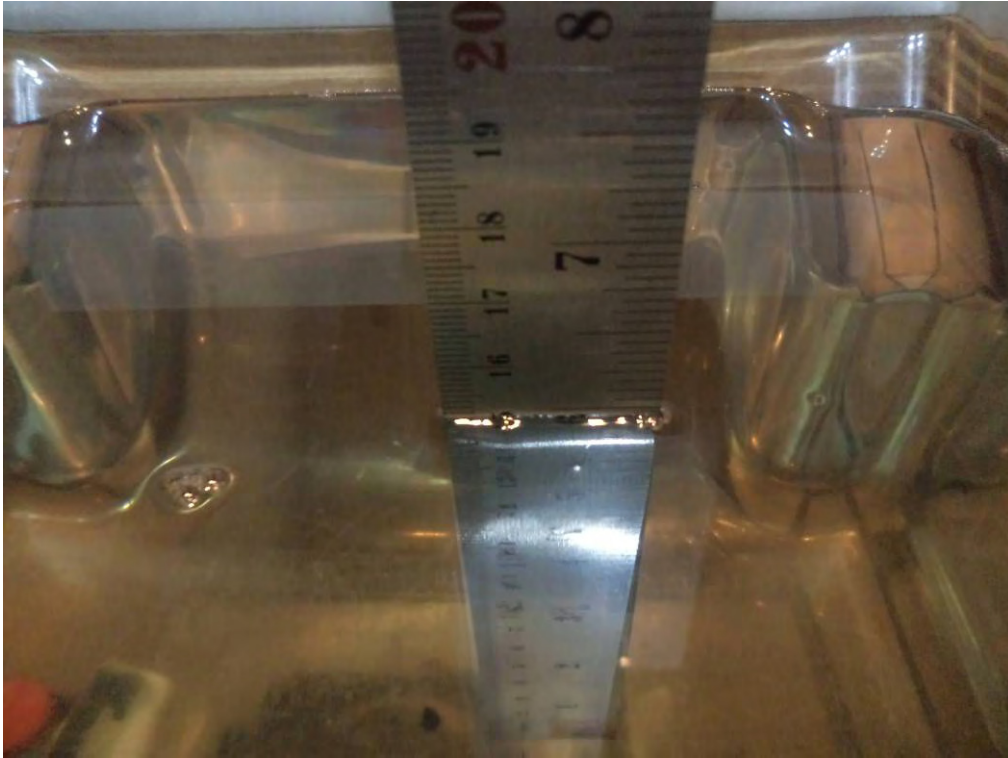

Body-worn Back Setup Photo (10mm)

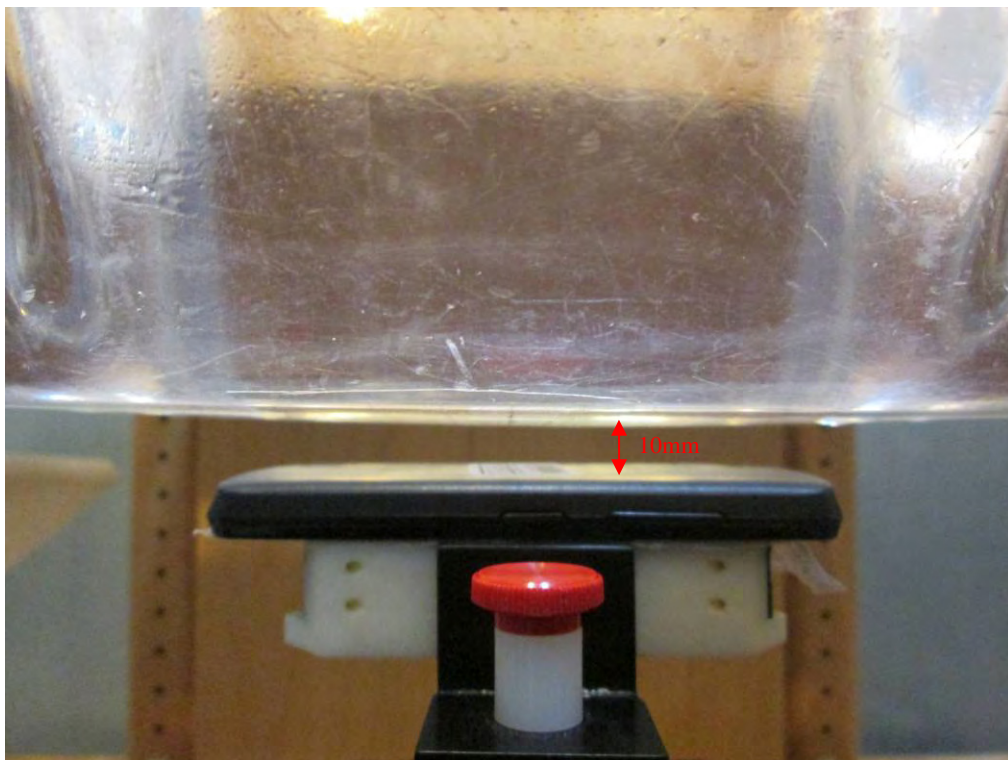

**Body-worn Left Setup Photo (10mm)**



**Body-worn Right Setup Photo (10mm)**

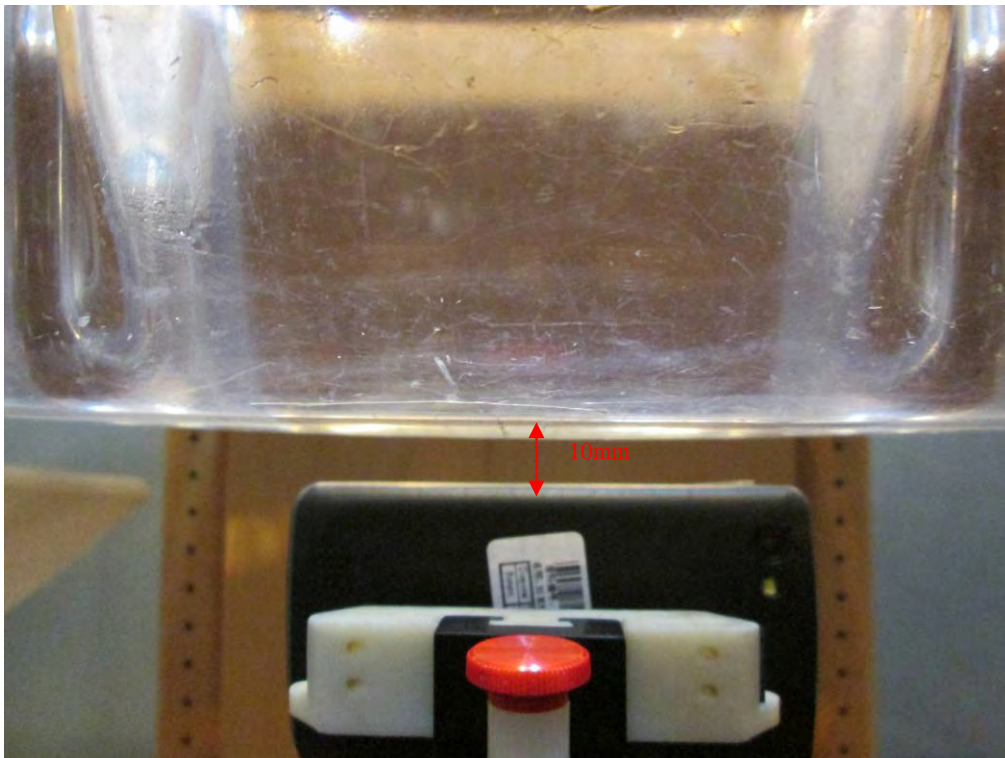

**Body-worn Bottom Setup Photo (10mm)**

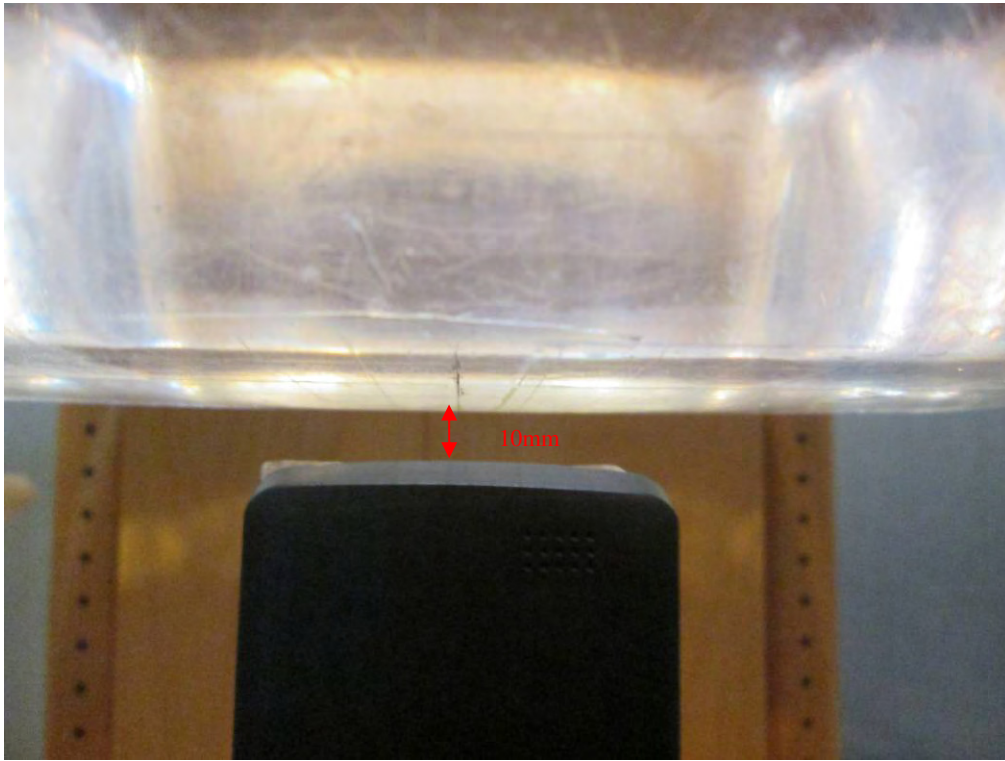

**Left Head Touch Setup Photo**

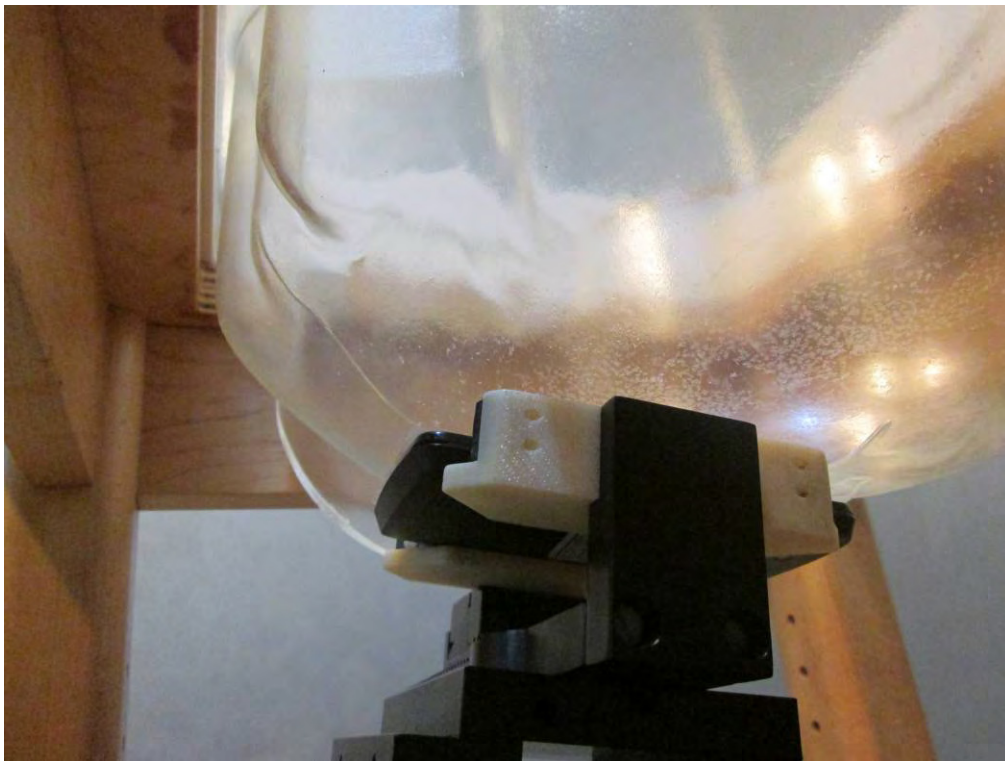

**Left Head Tilt Setup Photo**

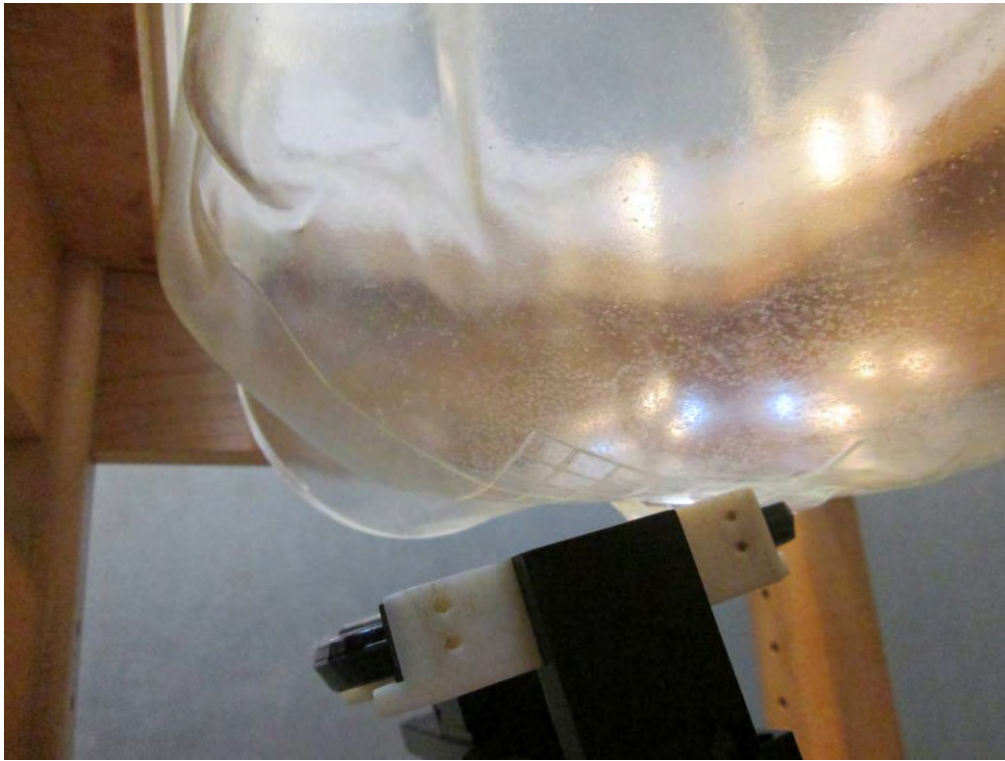

**Right Head Touch Setup Photo**

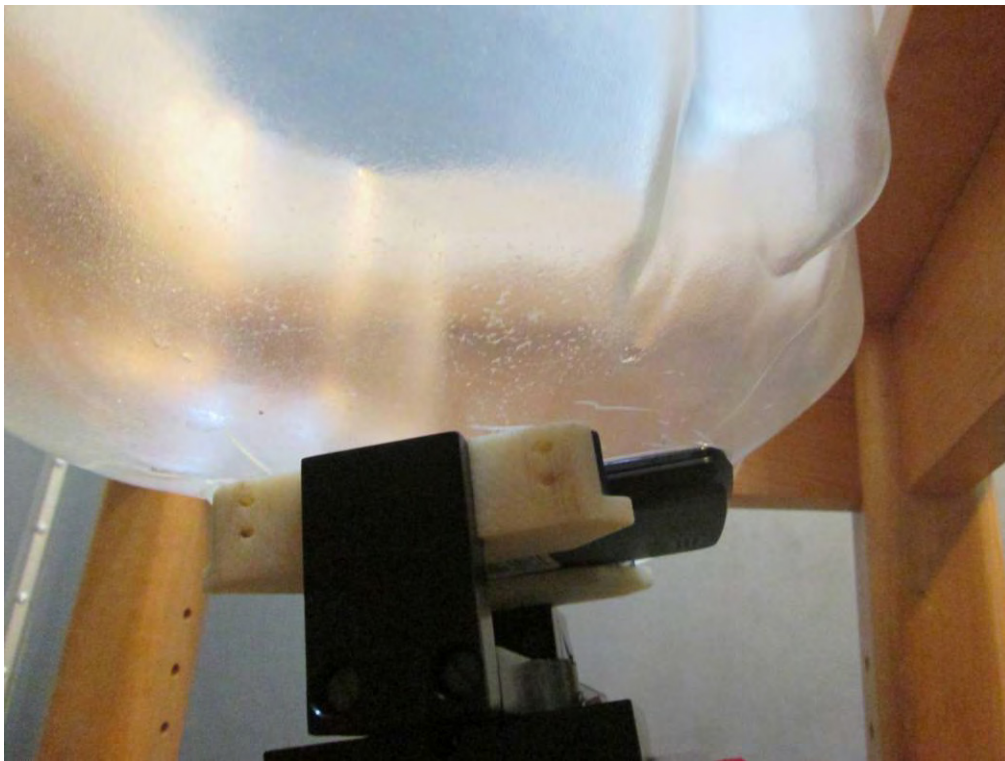

**Right Head Tilt Setup Photo**



## APPENDIX E EUT PHOTOS

**EUT – Front View**



**EUT – Back View**





**EUT –Left Side View**



**EUT – Right Side View**



**EUT – Top View**



**EUT – Bottom View**



### EUT – Uncover View



---

## APPENDIX F INFORMATIVE REFERENCES

---

- [1] Federal Communications Commission, "Report and order: Guidelines for evaluating the environmental effects of radiofrequency radiation", Tech. Rep. FCC 96-326, FCC, Washington, D.C. 20554, 1996.
- [2] David L. Means Kwok Chan, Robert F. Cleveland, "Evaluating compliance with FCC guidelines for human exposure to radiofrequency electromagnetic fields", Tech. Rep., Federal Communication Commission, Office of Engineering & Technology, Washington, DC, 1997.
- [3] Thomas Schmid, Oliver Egger, and Niels Kuster, "Automated E-field scanning system for dosimetric assessments", IEEE Transactions on Microwave Theory and Techniques, vol. 44, pp. 105-113, Jan. 1996.
- [4] Niels Kuster, Ralph Kastle, and Thomas Schmid, "Dosimetric evaluation of mobile communications equipment with known precision", IEEE Transactions on Communications, vol. E80-B, no. 5, pp. 645-652, May 1997.
- [5] CENELEC, "Considerations for evaluating of human exposure to electromagnetic fields (EMFs) from mobile telecommunication equipment (MTE) in the frequency range 30MHz - 6GHz", Tech. Rep., CENELEC, European Committee for Electrotechnical Standardization, Brussels, 1997.
- [6] ANSI, ANSI/IEEE C95.1-1992: IEEE Standard for Safety Levels with Respect to Human Exposure to Radio Frequency Electromagnetic Fields, 3 kHz to 300 GHz, The Institute of Electrical and Electronics Engineers, Inc., New York, NY 10017, 1992.
- [7] Katja Pokovic, Thomas Schmid, and Niels Kuster, "Robust setup for precise calibration of E-field probes in tissue simulating liquids at mobile communications frequencies", in ICECOM '97, Dubrovnik, October 15-17, 1997, pp. 120-24.
- [8] Katja Pokovic, Thomas Schmid, and Niels Kuster, "E-field probe with improved isotropy in brain simulating liquids", in Proceedings of the ELMAR, Zadar, Croatia, 23-25 June, 1996, pp. 172-175.
- [9] Volker Hombach, Klaus Meier, Michael Burkhardt, Eberhard Kuhn, and Niels Kuster, "The dependence of EM energy absorption upon human head modeling at 900 MHz", IEEE Transactions on Microwave Theory and Techniques, vol. 44, no. 10, pp. 1865-1873, Oct. 1996.
- [10] Klaus Meier, Ralf Kastle, Volker Hombach, Roger Tay, and Niels Kuster, "The dependence of EM energy absorption upon human head modeling at 1800 MHz", IEEE Transactions on Microwave Theory and Techniques, Oct. 1997, in press.
- [11] W. Gander, Computermathematik, Birkhaeuser, Basel, 1992.
- [12] W. H. Press, S. A. Teukolsky, W. T. Vetterling, and B. P. Flannery, Numerical Recipes in C, The Art of Scientific Computing, Second Edition, Cambridge University Press, 1992. Dosimetric Evaluation of Sample device, month 1998 9
- [13] NIS81 NAMAS, "The treatment of uncertainty in EMC measurement", Tech. Rep., NAMAS Executive, National Physical Laboratory, Teddington, Middlesex, England, 1994.
- [14] Barry N. Taylor and Christ E. Kuyatt, "Guidelines for evaluating and expressing the uncertainty of NIST measurement results", Tech. Rep., National Institute of Standards and Technology, 1994. Dosimetric Evaluation of Sample device, month 1998 10.

\*\*\*\*\* END OF REPORT \*\*\*\*\*